







Codice assieme	Descrizione assieme	Immagine assieme
ASM2825A/0.D00	Assieme generico	
ASM1312A/0.D02	Assieme generico	
ASM1333A/0.D00	Assieme generico	
ASM1311A/0.D01	Copertura esterna	

ASM2825A/0.D00 - Assieme generico

FRONTE





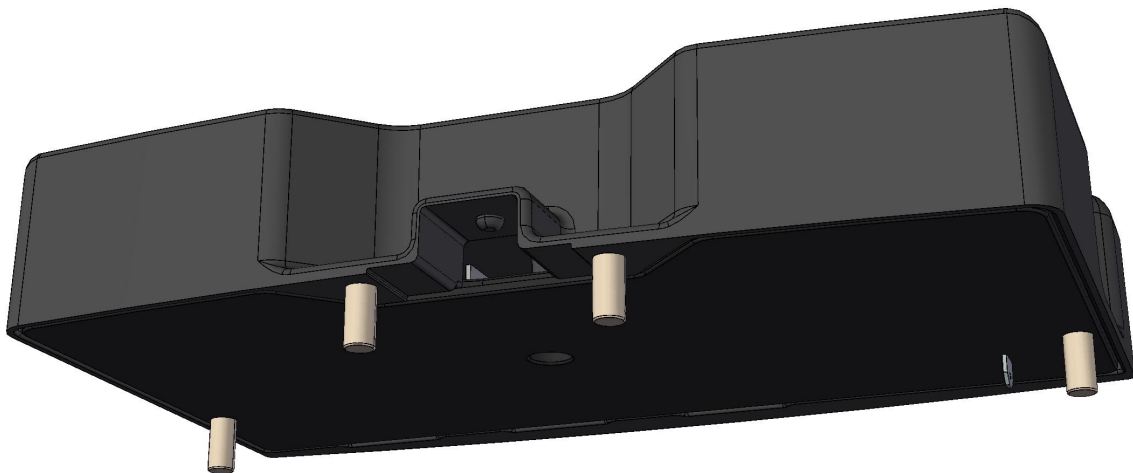

ASM2825A/0.D00 - Assieme generico

RETRO

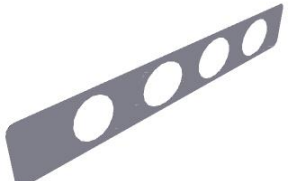
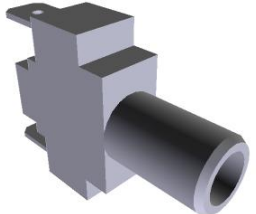

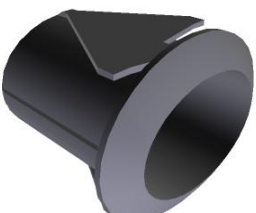

COMPONENTE			RICAMBIO																						
Codice	Descrizione	Immagine	Codice	Descrizione	Lista componenti																				
TR1141A	TERMOSTATO 2-72°		KTR1141A	KIT TERMOSTATO TR1141A	<table border="1"> <thead> <tr> <th>Codice</th> <th>Descrizione</th> <th>Qtà</th> <th>UM</th> </tr> </thead> <tbody> <tr> <td>TR1141A0</td> <td>TERMOSTATO 2-72°C</td> <td>1.500</td> <td>PZ</td> </tr> <tr> <td>VI1850A0</td> <td>VITE M4X6 TCB+ NICHELATA</td> <td>2</td> <td>PZ</td> </tr> </tbody> </table>	Codice	Descrizione	Qtà	UM	TR1141A0	TERMOSTATO 2-72°C	1.500	PZ	VI1850A0	VITE M4X6 TCB+ NICHELATA	2	PZ								
Codice	Descrizione	Qtà	UM																						
TR1141A0	TERMOSTATO 2-72°C	1.500	PZ																						
VI1850A0	VITE M4X6 TCB+ NICHELATA	2	PZ																						
VM1019B	CRUSCOTTO COMANDI LIEVITATORE MANUALE		KVM1019B	KIT CRUSCOTTO COMANDI LIEVITATORE MANUALE	<table border="1"> <thead> <tr> <th>Codice</th> <th>Descrizione</th> <th>Qtà</th> <th>UM</th> </tr> </thead> <tbody> <tr> <td>MS1018B0</td> <td>MASCHERINA SERIGRAFATA LIEV.MANUALE</td> <td>1</td> <td>PZ</td> </tr> <tr> <td>VE1585A0</td> <td>GEMMA ELLITTICA AZZURRA SINUSOIDE ORO</td> <td>1</td> <td>PZ</td> </tr> <tr> <td>VM1019B0</td> <td>CRUSCOTTO COMANDI LIEVITATORE MANUALE</td> <td>1</td> <td>PZ</td> </tr> <tr> <td>VM2009A0</td> <td>SUPPORTO ELLITTICO D16 ARGENTO</td> <td>3</td> <td>PZ</td> </tr> </tbody> </table>	Codice	Descrizione	Qtà	UM	MS1018B0	MASCHERINA SERIGRAFATA LIEV.MANUALE	1	PZ	VE1585A0	GEMMA ELLITTICA AZZURRA SINUSOIDE ORO	1	PZ	VM1019B0	CRUSCOTTO COMANDI LIEVITATORE MANUALE	1	PZ	VM2009A0	SUPPORTO ELLITTICO D16 ARGENTO	3	PZ
Codice	Descrizione	Qtà	UM																						
MS1018B0	MASCHERINA SERIGRAFATA LIEV.MANUALE	1	PZ																						
VE1585A0	GEMMA ELLITTICA AZZURRA SINUSOIDE ORO	1	PZ																						
VM1019B0	CRUSCOTTO COMANDI LIEVITATORE MANUALE	1	PZ																						
VM2009A0	SUPPORTO ELLITTICO D16 ARGENTO	3	PZ																						
VM1028A	VASSOIO CRUSCOTTO LIEVITATORE MANUAL		KVM1028A	KIT VASSOIO CRUSCOTTO LIEV MAN VM1028A0	<table border="1"> <thead> <tr> <th>Codice</th> <th>Descrizione</th> <th>Qtà</th> <th>UM</th> </tr> </thead> <tbody> <tr> <td>VM1028A0</td> <td>VASSOIO CRUSCOTTO LIEVITATORE MANUAL</td> <td>1</td> <td>PZ</td> </tr> </tbody> </table>	Codice	Descrizione	Qtà	UM	VM1028A0	VASSOIO CRUSCOTTO LIEVITATORE MANUAL	1	PZ												
Codice	Descrizione	Qtà	UM																						
VM1028A0	VASSOIO CRUSCOTTO LIEVITATORE MANUAL	1	PZ																						
MN1003A	MANOPOLA TERMOSTATO LIEVITATORE 0-70#		MN1003A0	MANOPOLA TERMOSTATO LIEVITATORE 0-70#																					

COMPONENTE			RICAMBIO																		
Codice	Descrizione	Immagine	Codice	Descrizione	Lista componenti																
MS1018B	MASCHERINA SERIGRAFATA LIEV.MANUALE																				
VE1562A	PULSANTE UNIPOLARE NA		KVE0107A	KIT GEMMA NUVOLETTA ARGENTO	<table border="1"> <thead> <tr> <th>Codice</th> <th>Descrizione</th> <th>Qtà</th> <th>UM</th> </tr> </thead> <tbody> <tr> <td>VE1562A0</td> <td>PULSANTE UNIPOLARE N</td> <td>1</td> <td>PZ</td> </tr> <tr> <td>VM1761A0</td> <td>SUPPORTO ELLITTICO NERO</td> <td>1</td> <td>PZ</td> </tr> <tr> <td>VM1775A0</td> <td>TASTO ARGENTO OPACO NUVOLETTA ORO</td> <td>1</td> <td>PZ</td> </tr> </tbody> </table>	Codice	Descrizione	Qtà	UM	VE1562A0	PULSANTE UNIPOLARE N	1	PZ	VM1761A0	SUPPORTO ELLITTICO NERO	1	PZ	VM1775A0	TASTO ARGENTO OPACO NUVOLETTA ORO	1	PZ
Codice	Descrizione	Qtà	UM																		
VE1562A0	PULSANTE UNIPOLARE N	1	PZ																		
VM1761A0	SUPPORTO ELLITTICO NERO	1	PZ																		
VM1775A0	TASTO ARGENTO OPACO NUVOLETTA ORO	1	PZ																		
			KVE0106A	KIT GEMMA FIAMMA ARG.	<table border="1"> <thead> <tr> <th>Codice</th> <th>Descrizione</th> <th>Qtà</th> <th>UM</th> </tr> </thead> <tbody> <tr> <td>VE1562A0</td> <td>PULSANTE UNIPOLARE N</td> <td>1</td> <td>PZ</td> </tr> <tr> <td>VM1761A0</td> <td>SUPPORTO ELLITTICO NERO</td> <td>1</td> <td>PZ</td> </tr> <tr> <td>VM1774A0</td> <td>TASTO ARGENTO OPACO FIAMMA ORO</td> <td>1</td> <td>PZ</td> </tr> </tbody> </table>	Codice	Descrizione	Qtà	UM	VE1562A0	PULSANTE UNIPOLARE N	1	PZ	VM1761A0	SUPPORTO ELLITTICO NERO	1	PZ	VM1774A0	TASTO ARGENTO OPACO FIAMMA ORO	1	PZ
Codice	Descrizione	Qtà	UM																		
VE1562A0	PULSANTE UNIPOLARE N	1	PZ																		
VM1761A0	SUPPORTO ELLITTICO NERO	1	PZ																		
VM1774A0	TASTO ARGENTO OPACO FIAMMA ORO	1	PZ																		
VM1775A	TASTO ARGENTO OPACO NUVOLETTA ORO		KVE0107A	KIT GEMMA NUVOLETTA ARGENTO	<table border="1"> <thead> <tr> <th>Codice</th> <th>Descrizione</th> <th>Qtà</th> <th>UM</th> </tr> </thead> <tbody> <tr> <td>VE1562A0</td> <td>PULSANTE UNIPOLARE N</td> <td>1</td> <td>PZ</td> </tr> <tr> <td>VM1761A0</td> <td>SUPPORTO ELLITTICO NERO</td> <td>1</td> <td>PZ</td> </tr> <tr> <td>VM1775A0</td> <td>TASTO ARGENTO OPACO NUVOLETTA ORO</td> <td>1</td> <td>PZ</td> </tr> </tbody> </table>	Codice	Descrizione	Qtà	UM	VE1562A0	PULSANTE UNIPOLARE N	1	PZ	VM1761A0	SUPPORTO ELLITTICO NERO	1	PZ	VM1775A0	TASTO ARGENTO OPACO NUVOLETTA ORO	1	PZ
Codice	Descrizione	Qtà	UM																		
VE1562A0	PULSANTE UNIPOLARE N	1	PZ																		
VM1761A0	SUPPORTO ELLITTICO NERO	1	PZ																		
VM1775A0	TASTO ARGENTO OPACO NUVOLETTA ORO	1	PZ																		
VM2009A	SUPPORTO ELLITTICO D16 ARGENTO		KVM2009A	KIT SUPPORTO ELLITTICO D16 ARGENTO	<table border="1"> <thead> <tr> <th>Codice</th> <th>Descrizione</th> <th>Qtà</th> <th>UM</th> </tr> </thead> <tbody> <tr> <td>VM2009A0</td> <td>SUPPORTO ELLITTICO D16 ARGENTO</td> <td>1</td> <td>PZ</td> </tr> </tbody> </table>	Codice	Descrizione	Qtà	UM	VM2009A0	SUPPORTO ELLITTICO D16 ARGENTO	1	PZ								
Codice	Descrizione	Qtà	UM																		
VM2009A0	SUPPORTO ELLITTICO D16 ARGENTO	1	PZ																		

COMPONENTE			RICAMBIO																																																																						
Codice	Descrizione	Immagine	Codice	Descrizione	Lista componenti																																																																				
VM1762A	SUPPORTO LAMPADA INTERNO		KVM1762A	KIT SUPPORTO INTERNO LAMPADA	<table border="1"> <thead> <tr> <th>Codice</th> <th>Descrizione</th> <th>Qtà</th> <th>UM</th> </tr> </thead> <tbody> <tr> <td>VM1762A0</td> <td>SUPPORTO LAMPADA INTERNO</td> <td>1</td> <td>PZ</td> </tr> </tbody> </table>	Codice	Descrizione	Qtà	UM	VM1762A0	SUPPORTO LAMPADA INTERNO	1	PZ																																																												
Codice	Descrizione	Qtà	UM																																																																						
VM1762A0	SUPPORTO LAMPADA INTERNO	1	PZ																																																																						
VE1535A	LUCE SPIA LED BIANCA 230V		KVE1535A KVE0105A KVE0104A KVE0102A	KIT 1 PZ.LUCE SPIA LED KIT RICAMBIO SPIA VERDE NUVOLETTA KIT GEMMA VERDE NEUTRA KIT GEMMA FIAMMA	<table border="1"> <thead> <tr> <th>Codice</th> <th>Descrizione</th> <th>Qtà</th> <th>UM</th> </tr> </thead> <tbody> <tr> <td>VE1535A1</td> <td>LUCE SPIA LED BIANCA 230V</td> <td>10</td> <td>PZ</td> </tr> </tbody> </table> <table border="1"> <thead> <tr> <th>Codice</th> <th>Descrizione</th> <th>Qtà</th> <th>UM</th> </tr> </thead> <tbody> <tr> <td>VE1535A1</td> <td>LUCE SPIA LED BIANCA 230V</td> <td>1</td> <td>PZ</td> </tr> <tr> <td>VM1761A0</td> <td>SUPPORTO ELLITTICO NERO</td> <td>1</td> <td>PZ</td> </tr> <tr> <td>VM1762A0</td> <td>SUPPORTO LAMPADA INTERNO</td> <td>1</td> <td>PZ</td> </tr> <tr> <td>VM1903A0</td> <td>GEMMA VERDE NUVOLETTA ORO</td> <td>1</td> <td>PZ</td> </tr> </tbody> </table> <table border="1"> <thead> <tr> <th>Codice</th> <th>Descrizione</th> <th>Qtà</th> <th>UM</th> </tr> </thead> <tbody> <tr> <td>VE1535A1</td> <td>LUCE SPIA LED BIANCA 230V</td> <td>1</td> <td>PZ</td> </tr> <tr> <td>VM1761A0</td> <td>SUPPORTO ELLITTICO NERO</td> <td>1</td> <td>PZ</td> </tr> <tr> <td>VM1762A0</td> <td>SUPPORTO LAMPADA INTERNO</td> <td>1</td> <td>PZ</td> </tr> <tr> <td>VM1902A0</td> <td>GEMMA VERDE NEUTR</td> <td>1</td> <td>PZ</td> </tr> </tbody> </table> <table border="1"> <thead> <tr> <th>Codice</th> <th>Descrizione</th> <th>Qtà</th> <th>UM</th> </tr> </thead> <tbody> <tr> <td>VE1535A1</td> <td>LUCE SPIA LED BIANCA 230V</td> <td>1</td> <td>PZ</td> </tr> <tr> <td>VM1761A0</td> <td>SUPPORTO ELLITTICO NERO</td> <td>1</td> <td>PZ</td> </tr> <tr> <td>VM1762A0</td> <td>SUPPORTO LAMPADA INTERNO</td> <td>1</td> <td>PZ</td> </tr> <tr> <td>VM1767A0</td> <td>GEMMA VERDE FIAMMA ORO</td> <td>1</td> <td>PZ</td> </tr> </tbody> </table>	Codice	Descrizione	Qtà	UM	VE1535A1	LUCE SPIA LED BIANCA 230V	10	PZ	Codice	Descrizione	Qtà	UM	VE1535A1	LUCE SPIA LED BIANCA 230V	1	PZ	VM1761A0	SUPPORTO ELLITTICO NERO	1	PZ	VM1762A0	SUPPORTO LAMPADA INTERNO	1	PZ	VM1903A0	GEMMA VERDE NUVOLETTA ORO	1	PZ	Codice	Descrizione	Qtà	UM	VE1535A1	LUCE SPIA LED BIANCA 230V	1	PZ	VM1761A0	SUPPORTO ELLITTICO NERO	1	PZ	VM1762A0	SUPPORTO LAMPADA INTERNO	1	PZ	VM1902A0	GEMMA VERDE NEUTR	1	PZ	Codice	Descrizione	Qtà	UM	VE1535A1	LUCE SPIA LED BIANCA 230V	1	PZ	VM1761A0	SUPPORTO ELLITTICO NERO	1	PZ	VM1762A0	SUPPORTO LAMPADA INTERNO	1	PZ	VM1767A0	GEMMA VERDE FIAMMA ORO	1	PZ
Codice	Descrizione	Qtà	UM																																																																						
VE1535A1	LUCE SPIA LED BIANCA 230V	10	PZ																																																																						
Codice	Descrizione	Qtà	UM																																																																						
VE1535A1	LUCE SPIA LED BIANCA 230V	1	PZ																																																																						
VM1761A0	SUPPORTO ELLITTICO NERO	1	PZ																																																																						
VM1762A0	SUPPORTO LAMPADA INTERNO	1	PZ																																																																						
VM1903A0	GEMMA VERDE NUVOLETTA ORO	1	PZ																																																																						
Codice	Descrizione	Qtà	UM																																																																						
VE1535A1	LUCE SPIA LED BIANCA 230V	1	PZ																																																																						
VM1761A0	SUPPORTO ELLITTICO NERO	1	PZ																																																																						
VM1762A0	SUPPORTO LAMPADA INTERNO	1	PZ																																																																						
VM1902A0	GEMMA VERDE NEUTR	1	PZ																																																																						
Codice	Descrizione	Qtà	UM																																																																						
VE1535A1	LUCE SPIA LED BIANCA 230V	1	PZ																																																																						
VM1761A0	SUPPORTO ELLITTICO NERO	1	PZ																																																																						
VM1762A0	SUPPORTO LAMPADA INTERNO	1	PZ																																																																						
VM1767A0	GEMMA VERDE FIAMMA ORO	1	PZ																																																																						

COMPONENTE			RICAMBIO																																			
Codice	Descrizione	Immagine	Codice	Descrizione	Lista componenti																																	
VE1535A	LUCHE SPIA LED BIANCA 230V		KVE0101A	KIT GEMMA VERDE SINUSOIDE	<table border="1"> <thead> <tr> <th>Codice</th> <th>Descrizione</th> <th>Qtà</th> <th>UM</th> </tr> </thead> <tbody> <tr> <td>VE1535A1</td> <td>LUCHE SPIA LED BIANCA 230V</td> <td>1</td> <td>PZ</td> </tr> <tr> <td>VM1761A0</td> <td>SUPPORTO ELLITTICO NERO</td> <td>1</td> <td>PZ</td> </tr> <tr> <td>VM1762A0</td> <td>SUPPORTO LAMPADA INTERNO</td> <td>1</td> <td>PZ</td> </tr> <tr> <td>VM1765A0</td> <td>GEMMA VERDE SINUSOIDE ORO</td> <td>1</td> <td>PZ</td> </tr> </tbody> </table>	Codice	Descrizione	Qtà	UM	VE1535A1	LUCHE SPIA LED BIANCA 230V	1	PZ	VM1761A0	SUPPORTO ELLITTICO NERO	1	PZ	VM1762A0	SUPPORTO LAMPADA INTERNO	1	PZ	VM1765A0	GEMMA VERDE SINUSOIDE ORO	1	PZ													
			Codice	Descrizione	Qtà	UM																																
			VE1535A1	LUCHE SPIA LED BIANCA 230V	1	PZ																																
VM1761A0	SUPPORTO ELLITTICO NERO	1	PZ																																			
VM1762A0	SUPPORTO LAMPADA INTERNO	1	PZ																																			
VM1765A0	GEMMA VERDE SINUSOIDE ORO	1	PZ																																			
KVE0100A	KIT GEMMA TERMOMETRO	<table border="1"> <thead> <tr> <th>Codice</th> <th>Descrizione</th> <th>Qtà</th> <th>UM</th> </tr> </thead> <tbody> <tr> <td>VE1530A0</td> <td>GEMMA ELLITTICA AZZURRA TERMOMETR O ORO</td> <td>1</td> <td>PZ</td> </tr> <tr> <td>VE1535A1</td> <td>LUCHE SPIA LED BIANCA 230V</td> <td>1</td> <td>PZ</td> </tr> <tr> <td>VM1761A0</td> <td>SUPPORTO ELLITTICO NERO</td> <td>1</td> <td>PZ</td> </tr> <tr> <td>VM1762A0</td> <td>SUPPORTO LAMPADA INTERNO</td> <td>1</td> <td>PZ</td> </tr> </tbody> </table>	Codice	Descrizione	Qtà	UM	VE1530A0	GEMMA ELLITTICA AZZURRA TERMOMETR O ORO	1	PZ	VE1535A1	LUCHE SPIA LED BIANCA 230V	1	PZ	VM1761A0	SUPPORTO ELLITTICO NERO	1	PZ	VM1762A0	SUPPORTO LAMPADA INTERNO	1	PZ																
Codice	Descrizione	Qtà	UM																																			
VE1530A0	GEMMA ELLITTICA AZZURRA TERMOMETR O ORO	1	PZ																																			
VE1535A1	LUCHE SPIA LED BIANCA 230V	1	PZ																																			
VM1761A0	SUPPORTO ELLITTICO NERO	1	PZ																																			
VM1762A0	SUPPORTO LAMPADA INTERNO	1	PZ																																			
KVE0011A	KIT MANOPOLE - GEMME XP	<table border="1"> <thead> <tr> <th>Codice</th> <th>Descrizione</th> <th>Qtà</th> <th>UM</th> </tr> </thead> <tbody> <tr> <td>MN1105A0</td> <td>MANOPOLA TERMOSTATO 120-400C XP</td> <td>1</td> <td>PZ</td> </tr> <tr> <td>MN1110A0</td> <td>GHIERA CON INDICE STAMPATO XP</td> <td>1</td> <td>PZ</td> </tr> <tr> <td>VE1530A0</td> <td>GEMMA ELLITTICA AZZURRA TERMOMETR O ORO</td> <td>1</td> <td>PZ</td> </tr> <tr> <td>VE1535A1</td> <td>LUCHE SPIA LED BIANCA 230V</td> <td>1</td> <td>PZ</td> </tr> <tr> <td>VE1561A0</td> <td>PULSANTE BIPOLARE NA/NA</td> <td>1</td> <td>PZ</td> </tr> <tr> <td>VM1761A0</td> <td>SUPPORTO ELLITTICO NERO</td> <td>2</td> <td>PZ</td> </tr> <tr> <td>VM1762A0</td> <td>SUPPORTO LAMPADA INTERNO</td> <td>1</td> <td>PZ</td> </tr> <tr> <td>VM1776A0</td> <td>TASTO ARGENTO OPACO "0-1" ORO</td> <td>1</td> <td>PZ</td> </tr> </tbody> </table>	Codice	Descrizione	Qtà	UM	MN1105A0	MANOPOLA TERMOSTATO 120-400C XP	1	PZ	MN1110A0	GHIERA CON INDICE STAMPATO XP	1	PZ	VE1530A0	GEMMA ELLITTICA AZZURRA TERMOMETR O ORO	1	PZ	VE1535A1	LUCHE SPIA LED BIANCA 230V	1	PZ	VE1561A0	PULSANTE BIPOLARE NA/NA	1	PZ	VM1761A0	SUPPORTO ELLITTICO NERO	2	PZ	VM1762A0	SUPPORTO LAMPADA INTERNO	1	PZ	VM1776A0	TASTO ARGENTO OPACO "0-1" ORO	1	PZ
Codice	Descrizione	Qtà	UM																																			
MN1105A0	MANOPOLA TERMOSTATO 120-400C XP	1	PZ																																			
MN1110A0	GHIERA CON INDICE STAMPATO XP	1	PZ																																			
VE1530A0	GEMMA ELLITTICA AZZURRA TERMOMETR O ORO	1	PZ																																			
VE1535A1	LUCHE SPIA LED BIANCA 230V	1	PZ																																			
VE1561A0	PULSANTE BIPOLARE NA/NA	1	PZ																																			
VM1761A0	SUPPORTO ELLITTICO NERO	2	PZ																																			
VM1762A0	SUPPORTO LAMPADA INTERNO	1	PZ																																			
VM1776A0	TASTO ARGENTO OPACO "0-1" ORO	1	PZ																																			

COMPONENTE			RICAMBIO																																						
Codice	Descrizione	Immagine	Codice	Descrizione	Lista componenti																																				
VE1535A	LUCE SPIA LED BIANCA 230V		KVE0008A	KIT GEMME AZZURRE XL	<table border="1"> <thead> <tr> <th>Codice</th> <th>Descrizione</th> <th>Qtà</th> <th>UM</th> </tr> </thead> <tbody> <tr> <td>VE1530A0</td> <td>GEMMA ELLITTICA AZZURRA TERMOMETR O ORO</td> <td>1</td> <td>PZ</td> </tr> <tr> <td>VE1535A1</td> <td>LUCE SPIA LED BIANCA 230V</td> <td>1</td> <td>PZ</td> </tr> <tr> <td>VE1561A0</td> <td>PULSANTE BIPOLARE NA/NA</td> <td>1</td> <td>PZ</td> </tr> <tr> <td>VE1562A0</td> <td>PULSANTE UNIPOLARE N</td> <td>1</td> <td>PZ</td> </tr> <tr> <td>VM1761A0</td> <td>SUPPORTO ELLITTICO NERO</td> <td>3</td> <td>PZ</td> </tr> <tr> <td>VM1762A0</td> <td>SUPPORTO LAMPADA INTERNO</td> <td>1</td> <td>PZ</td> </tr> <tr> <td>VM1775A0</td> <td>TASTO ARGENTO OPACO NUVOLETTA ORO</td> <td>1</td> <td>PZ</td> </tr> <tr> <td>VM1776A0</td> <td>TASTO ARGENTO OPACO "0-1" ORO</td> <td>1</td> <td>PZ</td> </tr> </tbody> </table>	Codice	Descrizione	Qtà	UM	VE1530A0	GEMMA ELLITTICA AZZURRA TERMOMETR O ORO	1	PZ	VE1535A1	LUCE SPIA LED BIANCA 230V	1	PZ	VE1561A0	PULSANTE BIPOLARE NA/NA	1	PZ	VE1562A0	PULSANTE UNIPOLARE N	1	PZ	VM1761A0	SUPPORTO ELLITTICO NERO	3	PZ	VM1762A0	SUPPORTO LAMPADA INTERNO	1	PZ	VM1775A0	TASTO ARGENTO OPACO NUVOLETTA ORO	1	PZ	VM1776A0	TASTO ARGENTO OPACO "0-1" ORO	1	PZ
			Codice	Descrizione	Qtà	UM																																			
VE1530A0	GEMMA ELLITTICA AZZURRA TERMOMETR O ORO	1	PZ																																						
VE1535A1	LUCE SPIA LED BIANCA 230V	1	PZ																																						
VE1561A0	PULSANTE BIPOLARE NA/NA	1	PZ																																						
VE1562A0	PULSANTE UNIPOLARE N	1	PZ																																						
VM1761A0	SUPPORTO ELLITTICO NERO	3	PZ																																						
VM1762A0	SUPPORTO LAMPADA INTERNO	1	PZ																																						
VM1775A0	TASTO ARGENTO OPACO NUVOLETTA ORO	1	PZ																																						
VM1776A0	TASTO ARGENTO OPACO "0-1" ORO	1	PZ																																						
KVE0007A	KIT GEMME XF-XG	<table border="1"> <thead> <tr> <th>Codice</th> <th>Descrizione</th> <th>Qtà</th> <th>UM</th> </tr> </thead> <tbody> <tr> <td>VE1530A0</td> <td>GEMMA ELLITTICA AZZURRA TERMOMETR O ORO</td> <td>1</td> <td>PZ</td> </tr> <tr> <td>VE1535A1</td> <td>LUCE SPIA LED BIANCA 230V</td> <td>1</td> <td>PZ</td> </tr> <tr> <td>VE1562A0</td> <td>PULSANTE UNIPOLARE N</td> <td>1</td> <td>PZ</td> </tr> <tr> <td>VE1585A0</td> <td>GEMMA ELLITTICA AZZURRA SINUSOIDE ORO</td> <td>1</td> <td>PZ</td> </tr> <tr> <td>VM1761A0</td> <td>SUPPORTO ELLITTICO NERO</td> <td>5</td> <td>PZ</td> </tr> <tr> <td>VM1762A0</td> <td>SUPPORTO LAMPADA INTERNO</td> <td>4</td> <td>PZ</td> </tr> <tr> <td>VM1767A0</td> <td>GEMMA VERDE FIAMMA ORO</td> <td>1</td> <td>PZ</td> </tr> </tbody> </table>	Codice	Descrizione	Qtà	UM	VE1530A0	GEMMA ELLITTICA AZZURRA TERMOMETR O ORO	1	PZ	VE1535A1	LUCE SPIA LED BIANCA 230V	1	PZ	VE1562A0	PULSANTE UNIPOLARE N	1	PZ	VE1585A0	GEMMA ELLITTICA AZZURRA SINUSOIDE ORO	1	PZ	VM1761A0	SUPPORTO ELLITTICO NERO	5	PZ	VM1762A0	SUPPORTO LAMPADA INTERNO	4	PZ	VM1767A0	GEMMA VERDE FIAMMA ORO	1	PZ							
Codice	Descrizione	Qtà	UM																																						
VE1530A0	GEMMA ELLITTICA AZZURRA TERMOMETR O ORO	1	PZ																																						
VE1535A1	LUCE SPIA LED BIANCA 230V	1	PZ																																						
VE1562A0	PULSANTE UNIPOLARE N	1	PZ																																						
VE1585A0	GEMMA ELLITTICA AZZURRA SINUSOIDE ORO	1	PZ																																						
VM1761A0	SUPPORTO ELLITTICO NERO	5	PZ																																						
VM1762A0	SUPPORTO LAMPADA INTERNO	4	PZ																																						
VM1767A0	GEMMA VERDE FIAMMA ORO	1	PZ																																						

COMPONENTE			RICAMBIO																							
Codice	Descrizione	Immagine	Codice	Descrizione	Lista componenti																					
VE1535A	LUCE SPIA LED BIANCA 230V		KVE0007A	KIT GEMME XF-XG	<table border="1"> <thead> <tr> <th>Codice</th> <th>Descrizione</th> <th>Qtà</th> <th>UM</th> </tr> </thead> <tbody> <tr> <td>VM1774A0</td> <td>TASTO ARGENTO OPACO FIAMMA ORO</td> <td>1</td> <td>PZ</td> </tr> <tr> <td>VM1775A0</td> <td>TASTO ARGENTO OPACO NUVOLETTA ORO</td> <td>1</td> <td>PZ</td> </tr> <tr> <td>VM1902A0</td> <td>GEMMA VERDE NEUTR</td> <td>1</td> <td>PZ</td> </tr> <tr> <td>VM1903A0</td> <td>GEMMA VERDE NUVOLETTA ORO</td> <td>1</td> <td>PZ</td> </tr> </tbody> </table>	Codice	Descrizione	Qtà	UM	VM1774A0	TASTO ARGENTO OPACO FIAMMA ORO	1	PZ	VM1775A0	TASTO ARGENTO OPACO NUVOLETTA ORO	1	PZ	VM1902A0	GEMMA VERDE NEUTR	1	PZ	VM1903A0	GEMMA VERDE NUVOLETTA ORO	1	PZ	
			Codice	Descrizione	Qtà	UM																				
			VM1774A0	TASTO ARGENTO OPACO FIAMMA ORO	1	PZ																				
VM1775A0	TASTO ARGENTO OPACO NUVOLETTA ORO	1	PZ																							
VM1902A0	GEMMA VERDE NEUTR	1	PZ																							
VM1903A0	GEMMA VERDE NUVOLETTA ORO	1	PZ																							
KLP1014A	KIT RICAMBIO SPIA AZZURRA SINUSOID	<table border="1"> <thead> <tr> <th>Codice</th> <th>Descrizione</th> <th>Qtà</th> <th>UM</th> </tr> </thead> <tbody> <tr> <td>VE1170A0</td> <td>SUPPORTO D16 ELLITTICO NICHEL OPAC</td> <td>2</td> <td>PZ</td> </tr> <tr> <td>VE1535A1</td> <td>LUCE SPIA LED BIANCA 230V</td> <td>2</td> <td>PZ</td> </tr> <tr> <td>VE1585A0</td> <td>GEMMA ELLITTICA AZZURRA SINUSOIDE ORO</td> <td>2</td> <td>PZ</td> </tr> <tr> <td>VM1762A0</td> <td>SUPPORTO LAMPADA INTERNO</td> <td>2</td> <td>PZ</td> </tr> <tr> <td>VM2009A0</td> <td>SUPPORTO ELLITTICO D16 ARGENTO</td> <td>1</td> <td>PZ</td> </tr> </tbody> </table>	Codice	Descrizione	Qtà	UM	VE1170A0	SUPPORTO D16 ELLITTICO NICHEL OPAC	2	PZ	VE1535A1	LUCE SPIA LED BIANCA 230V	2	PZ	VE1585A0	GEMMA ELLITTICA AZZURRA SINUSOIDE ORO	2	PZ	VM1762A0	SUPPORTO LAMPADA INTERNO	2	PZ	VM2009A0	SUPPORTO ELLITTICO D16 ARGENTO	1	PZ
Codice	Descrizione	Qtà	UM																							
VE1170A0	SUPPORTO D16 ELLITTICO NICHEL OPAC	2	PZ																							
VE1535A1	LUCE SPIA LED BIANCA 230V	2	PZ																							
VE1585A0	GEMMA ELLITTICA AZZURRA SINUSOIDE ORO	2	PZ																							
VM1762A0	SUPPORTO LAMPADA INTERNO	2	PZ																							
VM2009A0	SUPPORTO ELLITTICO D16 ARGENTO	1	PZ																							
KLP1012A	KIT RICAMBIO SPIA AZZURRA TERMOSTATO	<table border="1"> <thead> <tr> <th>Codice</th> <th>Descrizione</th> <th>Qtà</th> <th>UM</th> </tr> </thead> <tbody> <tr> <td>VE1170A0</td> <td>SUPPORTO D16 ELLITTICO NICHEL OPAC</td> <td>2</td> <td>PZ</td> </tr> <tr> <td>VE1530A0</td> <td>GEMMA ELLITTICA AZZURRA TERMOMETR O ORO</td> <td>2</td> <td>PZ</td> </tr> <tr> <td>VE1535A1</td> <td>LUCE SPIA LED BIANCA 230V</td> <td>2</td> <td>PZ</td> </tr> <tr> <td>VM1762A0</td> <td>SUPPORTO LAMPADA INTERNO</td> <td>2</td> <td>PZ</td> </tr> </tbody> </table>	Codice	Descrizione	Qtà	UM	VE1170A0	SUPPORTO D16 ELLITTICO NICHEL OPAC	2	PZ	VE1530A0	GEMMA ELLITTICA AZZURRA TERMOMETR O ORO	2	PZ	VE1535A1	LUCE SPIA LED BIANCA 230V	2	PZ	VM1762A0	SUPPORTO LAMPADA INTERNO	2	PZ				
Codice	Descrizione	Qtà	UM																							
VE1170A0	SUPPORTO D16 ELLITTICO NICHEL OPAC	2	PZ																							
VE1530A0	GEMMA ELLITTICA AZZURRA TERMOMETR O ORO	2	PZ																							
VE1535A1	LUCE SPIA LED BIANCA 230V	2	PZ																							
VM1762A0	SUPPORTO LAMPADA INTERNO	2	PZ																							

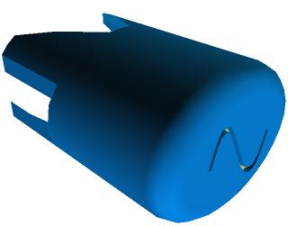
COMPONENTE			RICAMBIO																										
Codice	Descrizione	Immagine	Codice	Descrizione	Lista componenti																								
VE1535A	LUCE SPIA LED BIANCA 230V		KLP1011A	KIT SPIA TERMOSTATO SUPP.NICHELATO 110V	<table border="1"> <thead> <tr> <th>Codice</th> <th>Descrizione</th> <th>Qtà</th> <th>UM</th> </tr> </thead> <tbody> <tr> <td>VE1170A0</td> <td>SUPPORTO D16 ELLITTICO NICHEL OPAC</td> <td>1</td> <td>PZ</td> </tr> <tr> <td>VE1530A0</td> <td>GEMMA ELLITTICA AZZURRA TERMOMETR O ORO</td> <td>1</td> <td>PZ</td> </tr> <tr> <td>VE1535A1</td> <td>LUCE SPIA LED BIANCA 230V</td> <td>1</td> <td>PZ</td> </tr> <tr> <td>VM1762A0</td> <td>SUPPORTO LAMPADA INTERNO</td> <td>1</td> <td>PZ</td> </tr> </tbody> </table>	Codice	Descrizione	Qtà	UM	VE1170A0	SUPPORTO D16 ELLITTICO NICHEL OPAC	1	PZ	VE1530A0	GEMMA ELLITTICA AZZURRA TERMOMETR O ORO	1	PZ	VE1535A1	LUCE SPIA LED BIANCA 230V	1	PZ	VM1762A0	SUPPORTO LAMPADA INTERNO	1	PZ				
			Codice	Descrizione	Qtà	UM																							
			VE1170A0	SUPPORTO D16 ELLITTICO NICHEL OPAC	1	PZ																							
VE1530A0	GEMMA ELLITTICA AZZURRA TERMOMETR O ORO	1	PZ																										
VE1535A1	LUCE SPIA LED BIANCA 230V	1	PZ																										
VM1762A0	SUPPORTO LAMPADA INTERNO	1	PZ																										
KLP1010A	KIT RICAMBIO SPIA VERDE TERMOSTAT	<table border="1"> <thead> <tr> <th>Codice</th> <th>Descrizione</th> <th>Qtà</th> <th>UM</th> </tr> </thead> <tbody> <tr> <td>VE1170A0</td> <td>SUPPORTO D16 ELLITTICO NICHEL OPAC</td> <td>1</td> <td>PZ</td> </tr> <tr> <td>VE1535A1</td> <td>LUCE SPIA LED BIANCA 230V</td> <td>1</td> <td>PZ</td> </tr> <tr> <td>VM1762A0</td> <td>SUPPORTO LAMPADA INTERNO</td> <td>1</td> <td>PZ</td> </tr> <tr> <td>VM1764A0</td> <td>GEMMA VERDE TERMOMETR O ORO</td> <td>1</td> <td>PZ</td> </tr> </tbody> </table>	Codice	Descrizione	Qtà	UM	VE1170A0	SUPPORTO D16 ELLITTICO NICHEL OPAC	1	PZ	VE1535A1	LUCE SPIA LED BIANCA 230V	1	PZ	VM1762A0	SUPPORTO LAMPADA INTERNO	1	PZ	VM1764A0	GEMMA VERDE TERMOMETR O ORO	1	PZ							
Codice	Descrizione	Qtà	UM																										
VE1170A0	SUPPORTO D16 ELLITTICO NICHEL OPAC	1	PZ																										
VE1535A1	LUCE SPIA LED BIANCA 230V	1	PZ																										
VM1762A0	SUPPORTO LAMPADA INTERNO	1	PZ																										
VM1764A0	GEMMA VERDE TERMOMETR O ORO	1	PZ																										
KLP1005A	KIT 10 PZ. RICAMBIO LUCE SPI	<table border="1"> <thead> <tr> <th>Codice</th> <th>Descrizione</th> <th>Qtà</th> <th>UM</th> </tr> </thead> <tbody> <tr> <td>VE1535A1</td> <td>LUCE SPIA LED BIANCA 230V</td> <td>10</td> <td>PZ</td> </tr> </tbody> </table>	Codice	Descrizione	Qtà	UM	VE1535A1	LUCE SPIA LED BIANCA 230V	10	PZ																			
Codice	Descrizione	Qtà	UM																										
VE1535A1	LUCE SPIA LED BIANCA 230V	10	PZ																										
VE1585A	GEMMA ELLITTICA AZZURRA SINUSOIDE ORO		KLP1014A	KIT RICAMBIO SPIA AZZURRA SINUSOID	<table border="1"> <thead> <tr> <th>Codice</th> <th>Descrizione</th> <th>Qtà</th> <th>UM</th> </tr> </thead> <tbody> <tr> <td>VE1170A0</td> <td>SUPPORTO D16 ELLITTICO NICHEL OPAC</td> <td>2</td> <td>PZ</td> </tr> <tr> <td>VE1535A1</td> <td>LUCE SPIA LED BIANCA 230V</td> <td>2</td> <td>PZ</td> </tr> <tr> <td>VE1585A0</td> <td>GEMMA ELLITTICA AZZURRA SINUSOIDE ORO</td> <td>2</td> <td>PZ</td> </tr> <tr> <td>VM1762A0</td> <td>SUPPORTO LAMPADA INTERNO</td> <td>2</td> <td>PZ</td> </tr> <tr> <td>VM2009A0</td> <td>SUPPORTO ELLITTICO D16 ARGENTO</td> <td>1</td> <td>PZ</td> </tr> </tbody> </table>	Codice	Descrizione	Qtà	UM	VE1170A0	SUPPORTO D16 ELLITTICO NICHEL OPAC	2	PZ	VE1535A1	LUCE SPIA LED BIANCA 230V	2	PZ	VE1585A0	GEMMA ELLITTICA AZZURRA SINUSOIDE ORO	2	PZ	VM1762A0	SUPPORTO LAMPADA INTERNO	2	PZ	VM2009A0	SUPPORTO ELLITTICO D16 ARGENTO	1	PZ
			Codice	Descrizione	Qtà	UM																							
			VE1170A0	SUPPORTO D16 ELLITTICO NICHEL OPAC	2	PZ																							
			VE1535A1	LUCE SPIA LED BIANCA 230V	2	PZ																							
			VE1585A0	GEMMA ELLITTICA AZZURRA SINUSOIDE ORO	2	PZ																							
VM1762A0	SUPPORTO LAMPADA INTERNO	2	PZ																										
VM2009A0	SUPPORTO ELLITTICO D16 ARGENTO	1	PZ																										

COMPONENTE			RICAMBIO																						
Codice	Descrizione	Immagine	Codice	Descrizione	Lista componenti																				
VM2009A	SUPPORTO ELLITTICO D16 ARGENTO		KVM2009A	KIT SUPPORTO ELLITTICO D16 ARGENTO	<table border="1"> <thead> <tr> <th>Codice</th> <th>Descrizione</th> <th>Qtà</th> <th>UM</th> </tr> </thead> <tbody> <tr> <td>VM2009A0</td> <td>SUPPORTO ELLITTICO D16 ARGENTO</td> <td>1</td> <td>PZ</td> </tr> </tbody> </table>	Codice	Descrizione	Qtà	UM	VM2009A0	SUPPORTO ELLITTICO D16 ARGENTO	1	PZ												
Codice	Descrizione	Qtà	UM																						
VM2009A0	SUPPORTO ELLITTICO D16 ARGENTO	1	PZ																						
VM2009A	SUPPORTO ELLITTICO D16 ARGENTO		KVM2009A	KIT SUPPORTO ELLITTICO D16 ARGENTO	<table border="1"> <thead> <tr> <th>Codice</th> <th>Descrizione</th> <th>Qtà</th> <th>UM</th> </tr> </thead> <tbody> <tr> <td>VM2009A0</td> <td>SUPPORTO ELLITTICO D16 ARGENTO</td> <td>1</td> <td>PZ</td> </tr> </tbody> </table>	Codice	Descrizione	Qtà	UM	VM2009A0	SUPPORTO ELLITTICO D16 ARGENTO	1	PZ												
Codice	Descrizione	Qtà	UM																						
VM2009A0	SUPPORTO ELLITTICO D16 ARGENTO	1	PZ																						
VM1776A	TASTO ARGENTO OPACO "0-1" ORO		KVE0108A	KIT TASTO ARGENTO OPACO	<table border="1"> <thead> <tr> <th>Codice</th> <th>Descrizione</th> <th>Qtà</th> <th>UM</th> </tr> </thead> <tbody> <tr> <td>VE1170A0</td> <td>SUPPORTO D16 ELLITTICO NICHEL OPAC</td> <td>1</td> <td>PZ</td> </tr> <tr> <td>VE1561A0</td> <td>PULSANTE BIPOLARE NA/NA</td> <td>1</td> <td>PZ</td> </tr> <tr> <td>VM1761A0</td> <td>SUPPORTO ELLITTICO NERO</td> <td>1</td> <td>PZ</td> </tr> <tr> <td>VM1776A0</td> <td>TASTO ARGENTO OPACO "0-1" ORO</td> <td>1</td> <td>PZ</td> </tr> </tbody> </table>	Codice	Descrizione	Qtà	UM	VE1170A0	SUPPORTO D16 ELLITTICO NICHEL OPAC	1	PZ	VE1561A0	PULSANTE BIPOLARE NA/NA	1	PZ	VM1761A0	SUPPORTO ELLITTICO NERO	1	PZ	VM1776A0	TASTO ARGENTO OPACO "0-1" ORO	1	PZ
Codice	Descrizione	Qtà	UM																						
VE1170A0	SUPPORTO D16 ELLITTICO NICHEL OPAC	1	PZ																						
VE1561A0	PULSANTE BIPOLARE NA/NA	1	PZ																						
VM1761A0	SUPPORTO ELLITTICO NERO	1	PZ																						
VM1776A0	TASTO ARGENTO OPACO "0-1" ORO	1	PZ																						
VE1561A	PULSANTE BIPOLARE NA/NA		KVE0108A	KIT TASTO ARGENTO OPACO	<table border="1"> <thead> <tr> <th>Codice</th> <th>Descrizione</th> <th>Qtà</th> <th>UM</th> </tr> </thead> <tbody> <tr> <td>VE1170A0</td> <td>SUPPORTO D16 ELLITTICO NICHEL OPAC</td> <td>1</td> <td>PZ</td> </tr> <tr> <td>VE1561A0</td> <td>PULSANTE BIPOLARE NA/NA</td> <td>1</td> <td>PZ</td> </tr> <tr> <td>VM1761A0</td> <td>SUPPORTO ELLITTICO NERO</td> <td>1</td> <td>PZ</td> </tr> <tr> <td>VM1776A0</td> <td>TASTO ARGENTO OPACO "0-1" ORO</td> <td>1</td> <td>PZ</td> </tr> </tbody> </table>	Codice	Descrizione	Qtà	UM	VE1170A0	SUPPORTO D16 ELLITTICO NICHEL OPAC	1	PZ	VE1561A0	PULSANTE BIPOLARE NA/NA	1	PZ	VM1761A0	SUPPORTO ELLITTICO NERO	1	PZ	VM1776A0	TASTO ARGENTO OPACO "0-1" ORO	1	PZ
Codice	Descrizione	Qtà	UM																						
VE1170A0	SUPPORTO D16 ELLITTICO NICHEL OPAC	1	PZ																						
VE1561A0	PULSANTE BIPOLARE NA/NA	1	PZ																						
VM1761A0	SUPPORTO ELLITTICO NERO	1	PZ																						
VM1776A0	TASTO ARGENTO OPACO "0-1" ORO	1	PZ																						

ASM1312A/0.D02 - Assieme generico



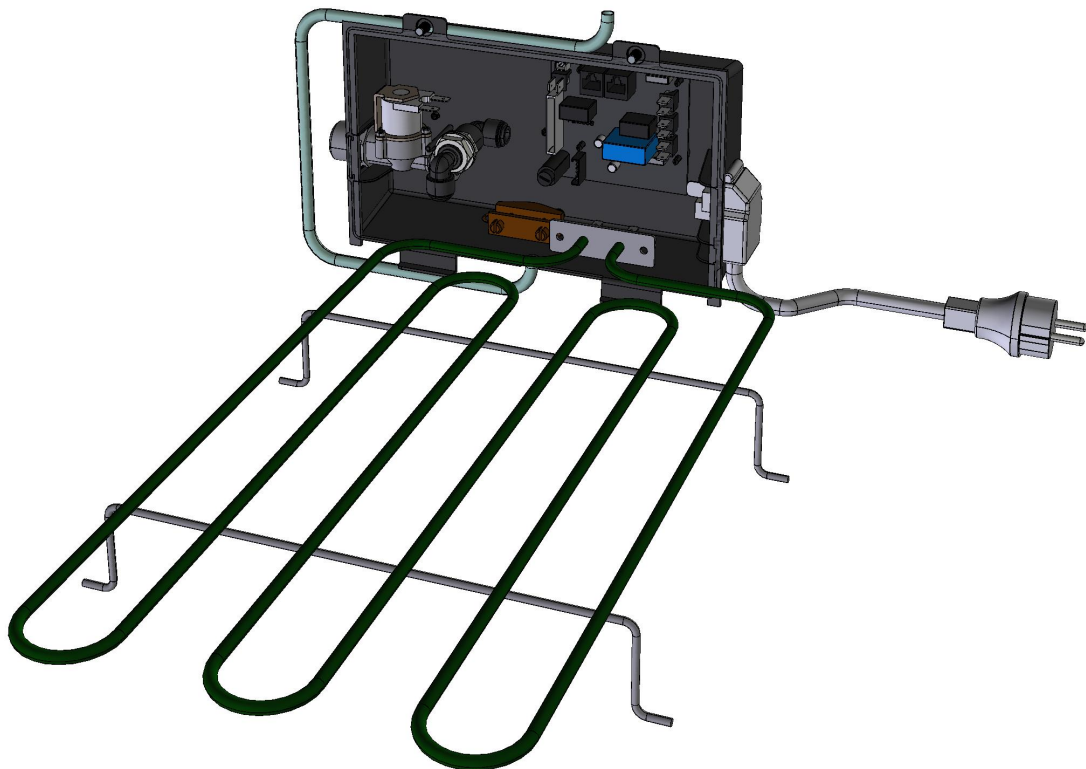

FRONTE

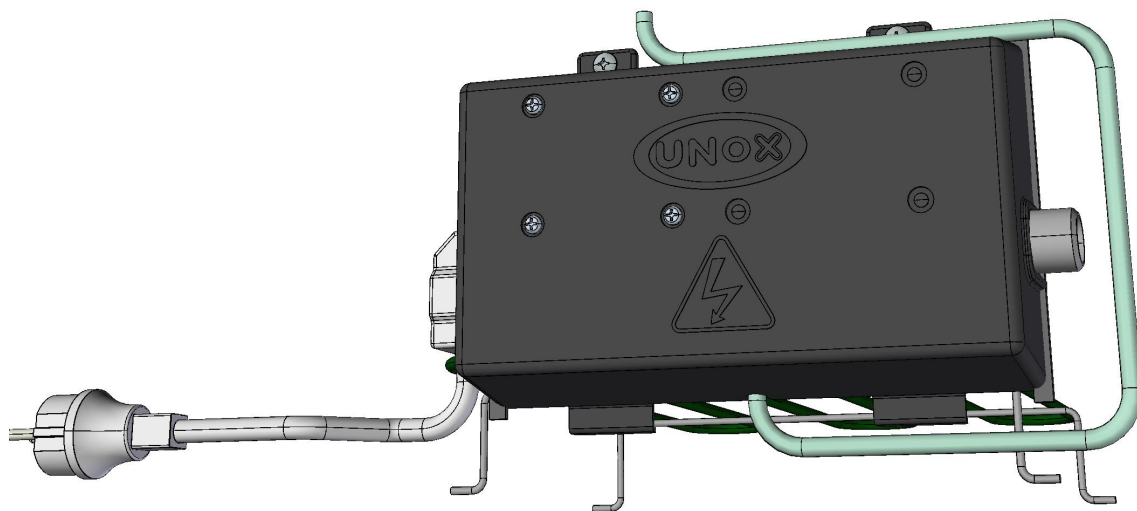

ASM1312A/0.D02 - Assieme generico

RETRO

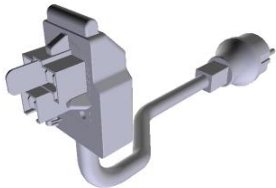
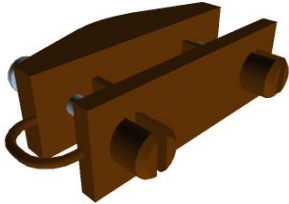
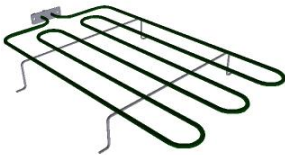

COMPONENTE			RICAMBIO																														
Codice	Descrizione	Immagine	Codice	Descrizione	Lista componenti																												
MR1000A	CAVO 3X1,5 H07RN-F MT1,5+K2/3+SCHUK		KMR1000A	KIT CAVO 3X1,5 H07RN-F MT1,5+K2/3+SCHUK	<table border="1"> <thead> <tr> <th>Codice</th> <th>Descrizione</th> <th>Qtà</th> <th>UM</th> </tr> </thead> <tbody> <tr> <td>MR1000A0</td> <td>CAVO 3X1,5 H07RN-F MT1,5+K2/3+S CHUKO</td> <td>1</td> <td>PZ</td> </tr> </tbody> </table>	Codice	Descrizione	Qtà	UM	MR1000A0	CAVO 3X1,5 H07RN-F MT1,5+K2/3+S CHUKO	1	PZ																				
Codice	Descrizione	Qtà	UM																														
MR1000A0	CAVO 3X1,5 H07RN-F MT1,5+K2/3+S CHUKO	1	PZ																														
VE1075A	PRESSACAPO FV 268 RO+VITI FISSAGGIO		VE1075A0	PRESSACAPO FV 268 RO+VITI FISSAGGIO																													
RS1095A	RESISTENZA PIANA 1200W 230V		KRS1095A	KIT RESISTENZA 1.2KW	<table border="1"> <thead> <tr> <th>Codice</th> <th>Descrizione</th> <th>Qtà</th> <th>UM</th> </tr> </thead> <tbody> <tr> <td>GN1326A1</td> <td>GUARNIZIONE RESISTENZA 71X19 G6,25</td> <td>1</td> <td>PZ</td> </tr> <tr> <td>IP1385A0</td> <td>IMBALLO POLISTIROLO ANGOLARE 110X80X2000</td> <td>1.200</td> <td>PZ</td> </tr> <tr> <td>RS1095A1</td> <td>RESISTENZA PIANA 1200W 230V</td> <td>1</td> <td>PZ</td> </tr> <tr> <td>SL1045A0</td> <td>SILICONE ANTRACITE S53 80 ML</td> <td>1</td> <td>PZ</td> </tr> <tr> <td>VI1220A1</td> <td>VITE AUTOFILETTA NTE 4.2X11 TCS+ MARUTE</td> <td>2</td> <td>PZ</td> </tr> <tr> <td>VM1059A1</td> <td>FILM TERMORETRA IBILE H800</td> <td>1.200</td> <td>M</td> </tr> </tbody> </table>	Codice	Descrizione	Qtà	UM	GN1326A1	GUARNIZIONE RESISTENZA 71X19 G6,25	1	PZ	IP1385A0	IMBALLO POLISTIROLO ANGOLARE 110X80X2000	1.200	PZ	RS1095A1	RESISTENZA PIANA 1200W 230V	1	PZ	SL1045A0	SILICONE ANTRACITE S53 80 ML	1	PZ	VI1220A1	VITE AUTOFILETTA NTE 4.2X11 TCS+ MARUTE	2	PZ	VM1059A1	FILM TERMORETRA IBILE H800	1.200	M
Codice	Descrizione	Qtà	UM																														
GN1326A1	GUARNIZIONE RESISTENZA 71X19 G6,25	1	PZ																														
IP1385A0	IMBALLO POLISTIROLO ANGOLARE 110X80X2000	1.200	PZ																														
RS1095A1	RESISTENZA PIANA 1200W 230V	1	PZ																														
SL1045A0	SILICONE ANTRACITE S53 80 ML	1	PZ																														
VI1220A1	VITE AUTOFILETTA NTE 4.2X11 TCS+ MARUTE	2	PZ																														
VM1059A1	FILM TERMORETRA IBILE H800	1.200	M																														
EL1140A	ELETTROVALVOLA SINGOLA ATT. J.GUEST		KEL1140A	KIT ELETTROVALVOLA 1 VIA	<table border="1"> <thead> <tr> <th>Codice</th> <th>Descrizione</th> <th>Qtà</th> <th>UM</th> </tr> </thead> <tbody> <tr> <td>EL1140A0</td> <td>ELETTROVALV OLA SINGOLA ATT. J.GUEST</td> <td>1</td> <td>PZ</td> </tr> </tbody> </table>	Codice	Descrizione	Qtà	UM	EL1140A0	ELETTROVALV OLA SINGOLA ATT. J.GUEST	1	PZ																				
Codice	Descrizione	Qtà	UM																														
EL1140A0	ELETTROVALV OLA SINGOLA ATT. J.GUEST	1	PZ																														

COMPONENTE			RICAMBIO														
Codice	Descrizione	Immagine	Codice	Descrizione	Lista componenti												
EL1195B	RACCORDO GOMITO Ø8F-Ø8M		KEL1195B	KIT 10 PZ.RACCORDO GOMITO ̄8F-̄8M	<table border="1"> <thead> <tr> <th>Codice</th> <th>Descrizione</th> <th>Qtà</th> <th>UM</th> </tr> </thead> <tbody> <tr> <td>EL1195A0</td> <td>RACCORDO A GOMITO CON J.GUEST</td> <td>10</td> <td>PZ</td> </tr> <tr> <td>EL1195B0</td> <td>RACCORDO GOMITO Ø8F-Ø8M</td> <td>10</td> <td>PZ</td> </tr> </tbody> </table>	Codice	Descrizione	Qtà	UM	EL1195A0	RACCORDO A GOMITO CON J.GUEST	10	PZ	EL1195B0	RACCORDO GOMITO Ø8F-Ø8M	10	PZ
			Codice	Descrizione	Qtà	UM											
EL1195A0	RACCORDO A GOMITO CON J.GUEST	10	PZ														
EL1195B0	RACCORDO GOMITO Ø8F-Ø8M	10	PZ														
KEL1195A	KIT 10 PZ.RACCORDO GOMITO ̄8F-̄8M	<table border="1"> <thead> <tr> <th>Codice</th> <th>Descrizione</th> <th>Qtà</th> <th>UM</th> </tr> </thead> <tbody> <tr> <td>EL1195A0</td> <td>RACCORDO A GOMITO CON J.GUEST</td> <td>10</td> <td>PZ</td> </tr> </tbody> </table>	Codice	Descrizione	Qtà	UM	EL1195A0	RACCORDO A GOMITO CON J.GUEST	10	PZ							
Codice	Descrizione	Qtà	UM														
EL1195A0	RACCORDO A GOMITO CON J.GUEST	10	PZ														
EL1125A	PASSAPARETE ̄8		EL1125A0	PASSAPARETE ̄8													
0H4820A	STAFFA SOSTEGNO BULBO		0H4820A1	STAFFA SOSTEGNO BULBO													
CE1024A	CAVO UL LIEVITATORI MANUALI, THERMOSTATO																
GN1523A	GUARNIZIONE SCATOLA COMPONENTI XLT		KGN1328A	KIT PROFILO GOMMA NERO ADESIVO	<table border="1"> <thead> <tr> <th>Codice</th> <th>Descrizione</th> <th>Qtà</th> <th>UM</th> </tr> </thead> <tbody> <tr> <td>GN1328A1</td> <td>PROFILO GOMMA NERO ADESIVO 8X3</td> <td>4.500</td> <td>M</td> </tr> </tbody> </table>	Codice	Descrizione	Qtà	UM	GN1328A1	PROFILO GOMMA NERO ADESIVO 8X3	4.500	M				
Codice	Descrizione	Qtà	UM														
GN1328A1	PROFILO GOMMA NERO ADESIVO 8X3	4.500	M														

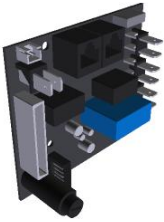
COMPONENTE			RICAMBIO																		
Codice	Descrizione	Immagine	Codice	Descrizione	Lista componenti																
PE1065B	SCHEDA POTENZA LIEVITATORE LM		KPE1065B	KIT SCHEDA POTENZA LIEVITATORE LM	<table border="1"> <thead> <tr> <th>Codice</th> <th>Descrizione</th> <th>Qtà</th> <th>UM</th> </tr> </thead> <tbody> <tr> <td>PE1065B0</td> <td>SCHEDA POTENZA LIEVITATORE LM</td> <td>1</td> <td>PZ</td> </tr> <tr> <td>VI1850A0</td> <td>VITE M4X6 TCB+ NICHELATA</td> <td>4</td> <td>PZ</td> </tr> <tr> <td>VM1745A0</td> <td>SUPPORTO PER SCHEDA</td> <td>4</td> <td>PZ</td> </tr> </tbody> </table>	Codice	Descrizione	Qtà	UM	PE1065B0	SCHEDA POTENZA LIEVITATORE LM	1	PZ	VI1850A0	VITE M4X6 TCB+ NICHELATA	4	PZ	VM1745A0	SUPPORTO PER SCHEDA	4	PZ
Codice	Descrizione	Qtà	UM																		
PE1065B0	SCHEDA POTENZA LIEVITATORE LM	1	PZ																		
VI1850A0	VITE M4X6 TCB+ NICHELATA	4	PZ																		
VM1745A0	SUPPORTO PER SCHEDA	4	PZ																		

ASM1333A/0.D00 - Assieme generico

FRONTE

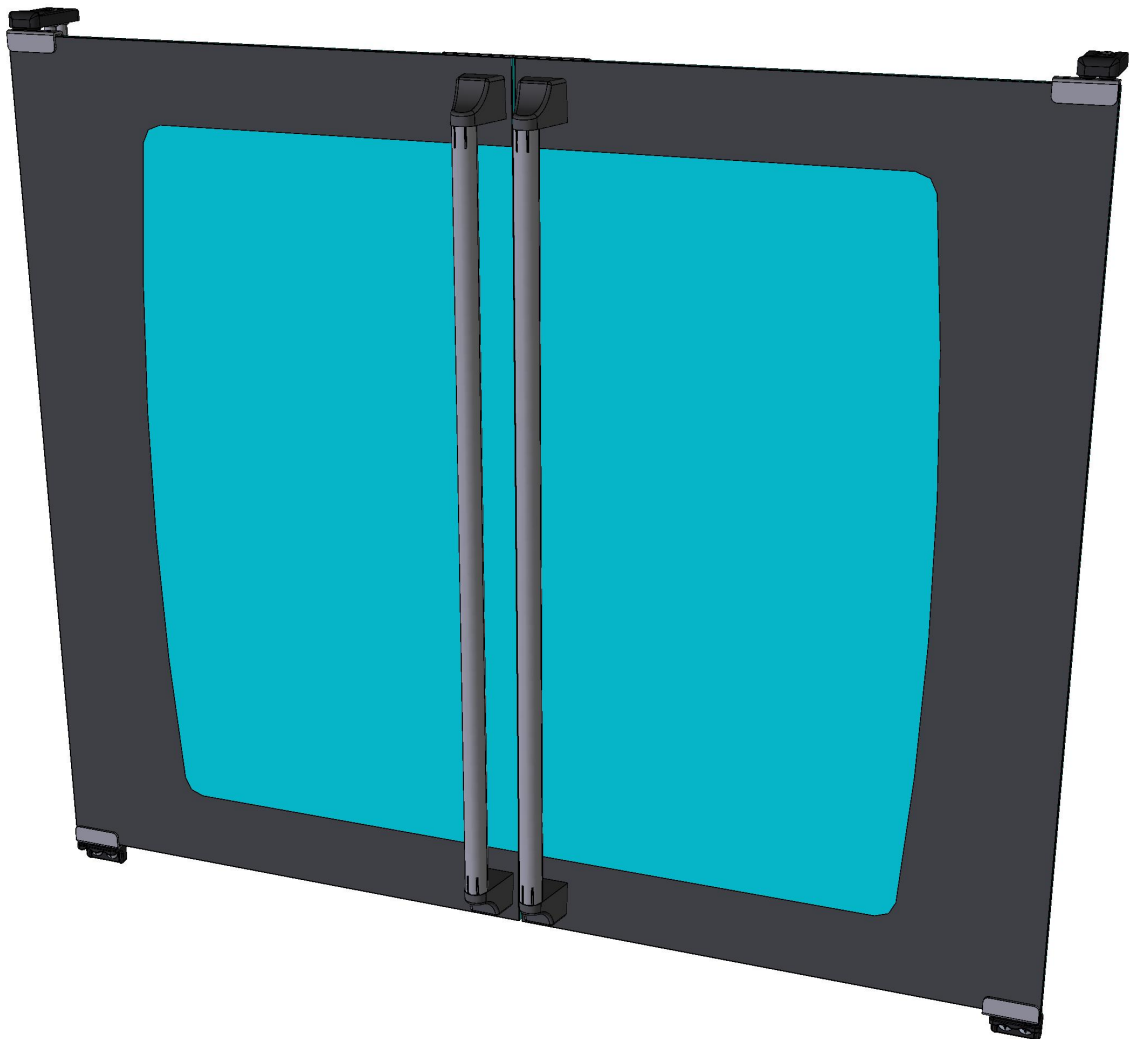

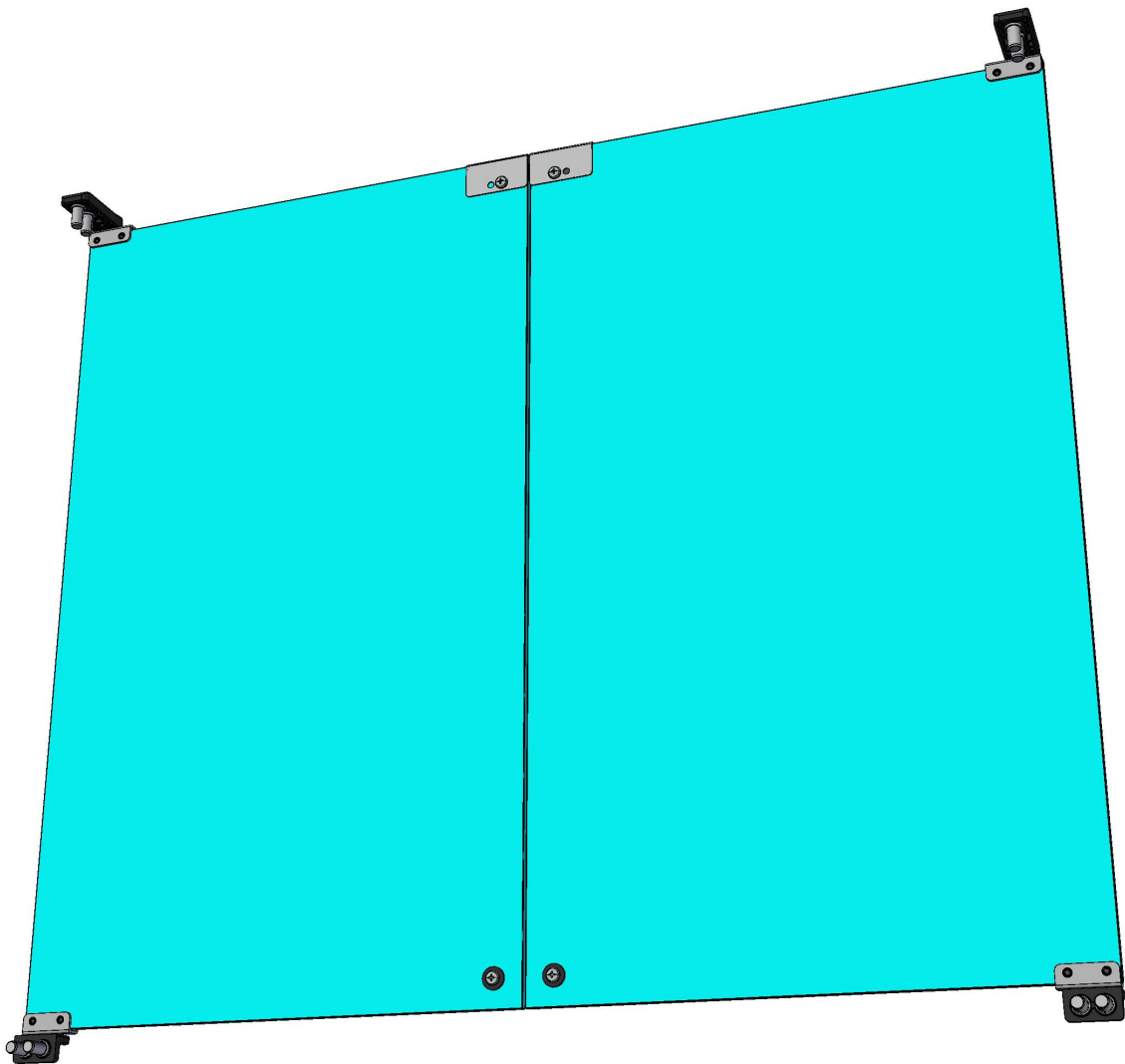

ASM1333A/0.D00 - Assieme generico

RETRO





COMPONENTE			RICAMBIO										
Codice	Descrizione	Immagine	Codice	Descrizione	Lista componenti								
VM1022B	STAFFA SUPERIORE PORTA LIEVITATOR		KVM1022B	KIT STAFFA SUP. PORTA LIEVITATORE VM102	<table border="1"> <thead> <tr> <th>Codice</th> <th>Descrizione</th> <th>Qtà</th> <th>UM</th> </tr> </thead> <tbody> <tr> <td>VM1022B0</td> <td>STAFFA SUPERIORE PORTA LIEVITATORE</td> <td>1</td> <td>PZ</td> </tr> </tbody> </table>	Codice	Descrizione	Qtà	UM	VM1022B0	STAFFA SUPERIORE PORTA LIEVITATORE	1	PZ
			Codice	Descrizione	Qtà	UM							
VM1022B0	STAFFA SUPERIORE PORTA LIEVITATORE	1	PZ										
KVM1022A	KIT STAFFA SUP.PORTA LIEVITATORE VM102	<table border="1"> <thead> <tr> <th>Codice</th> <th>Descrizione</th> <th>Qtà</th> <th>UM</th> </tr> </thead> <tbody> <tr> <td>VM1022A0</td> <td>STAFFA SUPERIORE PORTA LIEVITATORE</td> <td>1</td> <td>PZ</td> </tr> </tbody> </table>	Codice	Descrizione	Qtà	UM	VM1022A0	STAFFA SUPERIORE PORTA LIEVITATORE	1	PZ			
Codice	Descrizione	Qtà	UM										
VM1022A0	STAFFA SUPERIORE PORTA LIEVITATORE	1	PZ										
VM1024B	STAFFA INFERIORE SX PORTA LIEVITATORE		KVM1024B	KIT STAFFE INFERIORI PORTA LIEVITATORE	<table border="1"> <thead> <tr> <th>Codice</th> <th>Descrizione</th> <th>Qtà</th> <th>UM</th> </tr> </thead> <tbody> <tr> <td>VM1023B0</td> <td>STAFFA INFERIORE DX PORTA LIEVITATORE</td> <td>1</td> <td>PZ</td> </tr> </tbody> </table>	Codice	Descrizione	Qtà	UM	VM1023B0	STAFFA INFERIORE DX PORTA LIEVITATORE	1	PZ
					Codice	Descrizione	Qtà	UM					
VM1023B0	STAFFA INFERIORE DX PORTA LIEVITATORE	1	PZ										
<table border="1"> <thead> <tr> <th>Codice</th> <th>Descrizione</th> <th>Qtà</th> <th>UM</th> </tr> </thead> <tbody> <tr> <td>VM1024B0</td> <td>STAFFA INFERIORE SX PORTA LIEVITATORE</td> <td>1</td> <td>PZ</td> </tr> </tbody> </table>	Codice	Descrizione	Qtà	UM	VM1024B0	STAFFA INFERIORE SX PORTA LIEVITATORE	1	PZ					
Codice	Descrizione	Qtà	UM										
VM1024B0	STAFFA INFERIORE SX PORTA LIEVITATORE	1	PZ										
CR1081A	CERNIERA SX INOX XV-XL-XB		KCR1080A	KIT CERNIERA DX/S	<table border="1"> <thead> <tr> <th>Codice</th> <th>Descrizione</th> <th>Qtà</th> <th>UM</th> </tr> </thead> <tbody> <tr> <td>CR1080A0</td> <td>CERNIERA DX INOX XV-XL-X</td> <td>1</td> <td>PZ</td> </tr> </tbody> </table>	Codice	Descrizione	Qtà	UM	CR1080A0	CERNIERA DX INOX XV-XL-X	1	PZ
					Codice	Descrizione	Qtà	UM					
					CR1080A0	CERNIERA DX INOX XV-XL-X	1	PZ					
					<table border="1"> <thead> <tr> <th>Codice</th> <th>Descrizione</th> <th>Qtà</th> <th>UM</th> </tr> </thead> <tbody> <tr> <td>CR1081A0</td> <td>CERNIERA SX INOX XV-XL-X</td> <td>1</td> <td>PZ</td> </tr> </tbody> </table>	Codice	Descrizione	Qtà	UM	CR1081A0	CERNIERA SX INOX XV-XL-X	1	PZ
					Codice	Descrizione	Qtà	UM					
					CR1081A0	CERNIERA SX INOX XV-XL-X	1	PZ					
<table border="1"> <thead> <tr> <th>Codice</th> <th>Descrizione</th> <th>Qtà</th> <th>UM</th> </tr> </thead> <tbody> <tr> <td>GN1320A0</td> <td>GUARNIZIONE CERNIERA VETRO PORTA</td> <td>2</td> <td>PZ</td> </tr> </tbody> </table>	Codice	Descrizione	Qtà	UM	GN1320A0	GUARNIZIONE CERNIERA VETRO PORTA	2	PZ					
Codice	Descrizione	Qtà	UM										
GN1320A0	GUARNIZIONE CERNIERA VETRO PORTA	2	PZ										
<table border="1"> <thead> <tr> <th>Codice</th> <th>Descrizione</th> <th>Qtà</th> <th>UM</th> </tr> </thead> <tbody> <tr> <td>VI1685A0</td> <td>VITE NO TESTA EI M6X6 TESTA CONICA INOX</td> <td>4</td> <td>PZ</td> </tr> </tbody> </table>	Codice	Descrizione	Qtà	UM	VI1685A0	VITE NO TESTA EI M6X6 TESTA CONICA INOX	4	PZ					
Codice	Descrizione	Qtà	UM										
VI1685A0	VITE NO TESTA EI M6X6 TESTA CONICA INOX	4	PZ										
<table border="1"> <thead> <tr> <th>Codice</th> <th>Descrizione</th> <th>Qtà</th> <th>UM</th> </tr> </thead> <tbody> <tr> <td>VM1790A0</td> <td>BOCCOLA CERNIERA 12X6.5 DI5.3</td> <td>2</td> <td>PZ</td> </tr> </tbody> </table>	Codice	Descrizione	Qtà	UM	VM1790A0	BOCCOLA CERNIERA 12X6.5 DI5.3	2	PZ					
Codice	Descrizione	Qtà	UM										
VM1790A0	BOCCOLA CERNIERA 12X6.5 DI5.3	2	PZ										
<table border="1"> <thead> <tr> <th>Codice</th> <th>Descrizione</th> <th>Qtà</th> <th>UM</th> </tr> </thead> <tbody> <tr> <td>VM1790A0</td> <td>BOCCOLA CERNIERA 12X6.5 DI5.3</td> <td>2</td> <td>PZ</td> </tr> </tbody> </table>	Codice	Descrizione	Qtà	UM	VM1790A0	BOCCOLA CERNIERA 12X6.5 DI5.3	2	PZ					
Codice	Descrizione	Qtà	UM										
VM1790A0	BOCCOLA CERNIERA 12X6.5 DI5.3	2	PZ										
GN1320A	GUARNIZIONE CERNIERA VETRO PORTA		KGN1320A	KIT 4 GUARNIZIONI CERNIERE VETRO PORTA	<table border="1"> <thead> <tr> <th>Codice</th> <th>Descrizione</th> <th>Qtà</th> <th>UM</th> </tr> </thead> <tbody> <tr> <td>GN1320A0</td> <td>GUARNIZIONE CERNIERA VETRO PORTA</td> <td>4</td> <td>PZ</td> </tr> </tbody> </table>	Codice	Descrizione	Qtà	UM	GN1320A0	GUARNIZIONE CERNIERA VETRO PORTA	4	PZ
					Codice	Descrizione	Qtà	UM					
			GN1320A0	GUARNIZIONE CERNIERA VETRO PORTA	4	PZ							
			<table border="1"> <thead> <tr> <th>Codice</th> <th>Descrizione</th> <th>Qtà</th> <th>UM</th> </tr> </thead> <tbody> <tr> <td>CR1081A0</td> <td>CERNIERA SX INOX XV-XL-X</td> <td>1</td> <td>PZ</td> </tr> </tbody> </table>	Codice	Descrizione	Qtà	UM	CR1081A0	CERNIERA SX INOX XV-XL-X	1	PZ		
			Codice	Descrizione	Qtà	UM							
			CR1081A0	CERNIERA SX INOX XV-XL-X	1	PZ							
KCR1081A	KIT CERNIERA SX/INF CR1081A	<table border="1"> <thead> <tr> <th>Codice</th> <th>Descrizione</th> <th>Qtà</th> <th>UM</th> </tr> </thead> <tbody> <tr> <td>GN1320A0</td> <td>GUARNIZIONE CERNIERA VETRO PORTA</td> <td>1</td> <td>PZ</td> </tr> </tbody> </table>	Codice	Descrizione	Qtà	UM	GN1320A0	GUARNIZIONE CERNIERA VETRO PORTA	1	PZ			
		Codice	Descrizione	Qtà	UM								
GN1320A0	GUARNIZIONE CERNIERA VETRO PORTA	1	PZ										
<table border="1"> <thead> <tr> <th>Codice</th> <th>Descrizione</th> <th>Qtà</th> <th>UM</th> </tr> </thead> <tbody> <tr> <td>VI1083A0</td> <td>VITE M6X6 TC1/2T INOX</td> <td>2</td> <td>PZ</td> </tr> </tbody> </table>	Codice	Descrizione	Qtà	UM	VI1083A0	VITE M6X6 TC1/2T INOX	2	PZ					
Codice	Descrizione	Qtà	UM										
VI1083A0	VITE M6X6 TC1/2T INOX	2	PZ										
<table border="1"> <thead> <tr> <th>Codice</th> <th>Descrizione</th> <th>Qtà</th> <th>UM</th> </tr> </thead> <tbody> <tr> <td>VM1790A0</td> <td>BOCCOLA CERNIERA 12X6.5 DI5.3</td> <td>1</td> <td>PZ</td> </tr> </tbody> </table>	Codice	Descrizione	Qtà	UM	VM1790A0	BOCCOLA CERNIERA 12X6.5 DI5.3	1	PZ					
Codice	Descrizione	Qtà	UM										
VM1790A0	BOCCOLA CERNIERA 12X6.5 DI5.3	1	PZ										
<table border="1"> <thead> <tr> <th>Codice</th> <th>Descrizione</th> <th>Qtà</th> <th>UM</th> </tr> </thead> <tbody> <tr> <td>VM1790A0</td> <td>BOCCOLA CERNIERA 12X6.5 DI5.3</td> <td>1</td> <td>PZ</td> </tr> </tbody> </table>	Codice	Descrizione	Qtà	UM	VM1790A0	BOCCOLA CERNIERA 12X6.5 DI5.3	1	PZ					
Codice	Descrizione	Qtà	UM										
VM1790A0	BOCCOLA CERNIERA 12X6.5 DI5.3	1	PZ										

COMPONENTE			RICAMBIO																										
Codice	Descrizione	Immagine	Codice	Descrizione	Lista componenti																								
GN1320A	GUARNIZIONE CERNIERA VETRO PORTA		KCR1080A	KIT CERNIERA DX/S	<table border="1"> <thead> <tr> <th>Codice</th> <th>Descrizione</th> <th>Qtà</th> <th>UM</th> </tr> </thead> <tbody> <tr> <td>CR1080A0</td> <td>CERNIERA DX INOX XV-XL-X</td> <td>1</td> <td>PZ</td> </tr> <tr> <td>CR1081A0</td> <td>CERNIERA SX INOX XV-XL-X</td> <td>1</td> <td>PZ</td> </tr> <tr> <td>GN1320A0</td> <td>GUARNIZIONE CERNIERA VETRO PORTA</td> <td>2</td> <td>PZ</td> </tr> <tr> <td>VI1685A0</td> <td>VITE NO TESTA EI M6X6 TESTA CONICA INOX</td> <td>4</td> <td>PZ</td> </tr> <tr> <td>VM1790A0</td> <td>BOCCOLA CERNIERA 12X6.5 DI5.3</td> <td>2</td> <td>PZ</td> </tr> </tbody> </table>	Codice	Descrizione	Qtà	UM	CR1080A0	CERNIERA DX INOX XV-XL-X	1	PZ	CR1081A0	CERNIERA SX INOX XV-XL-X	1	PZ	GN1320A0	GUARNIZIONE CERNIERA VETRO PORTA	2	PZ	VI1685A0	VITE NO TESTA EI M6X6 TESTA CONICA INOX	4	PZ	VM1790A0	BOCCOLA CERNIERA 12X6.5 DI5.3	2	PZ
					Codice	Descrizione	Qtà	UM																					
CR1080A0	CERNIERA DX INOX XV-XL-X	1	PZ																										
CR1081A0	CERNIERA SX INOX XV-XL-X	1	PZ																										
GN1320A0	GUARNIZIONE CERNIERA VETRO PORTA	2	PZ																										
VI1685A0	VITE NO TESTA EI M6X6 TESTA CONICA INOX	4	PZ																										
VM1790A0	BOCCOLA CERNIERA 12X6.5 DI5.3	2	PZ																										
<table border="1"> <thead> <tr> <th>Codice</th> <th>Descrizione</th> <th>Qtà</th> <th>UM</th> </tr> </thead> <tbody> <tr> <td>CR1080A0</td> <td>CERNIERA DX INOX XV-XL-X</td> <td>1</td> <td>PZ</td> </tr> <tr> <td>CR1081A0</td> <td>CERNIERA SX INOX XV-XL-X</td> <td>1</td> <td>PZ</td> </tr> <tr> <td>GN1320A0</td> <td>GUARNIZIONE CERNIERA VETRO PORTA</td> <td>2</td> <td>PZ</td> </tr> <tr> <td>VI1685A0</td> <td>VITE NO TESTA EI M6X6 TESTA CONICA INOX</td> <td>4</td> <td>PZ</td> </tr> <tr> <td>VM1790A0</td> <td>BOCCOLA CERNIERA 12X6.5 DI5.3</td> <td>2</td> <td>PZ</td> </tr> </tbody> </table>	Codice	Descrizione	Qtà	UM	CR1080A0	CERNIERA DX INOX XV-XL-X	1	PZ	CR1081A0	CERNIERA SX INOX XV-XL-X	1	PZ	GN1320A0	GUARNIZIONE CERNIERA VETRO PORTA	2	PZ	VI1685A0	VITE NO TESTA EI M6X6 TESTA CONICA INOX	4	PZ	VM1790A0	BOCCOLA CERNIERA 12X6.5 DI5.3	2	PZ					
Codice	Descrizione	Qtà	UM																										
CR1080A0	CERNIERA DX INOX XV-XL-X	1	PZ																										
CR1081A0	CERNIERA SX INOX XV-XL-X	1	PZ																										
GN1320A0	GUARNIZIONE CERNIERA VETRO PORTA	2	PZ																										
VI1685A0	VITE NO TESTA EI M6X6 TESTA CONICA INOX	4	PZ																										
VM1790A0	BOCCOLA CERNIERA 12X6.5 DI5.3	2	PZ																										
CR1080A	CERNIERA DX INOX XV-XL-XB		KCR1080A	KIT CERNIERA DX/S	<table border="1"> <thead> <tr> <th>Codice</th> <th>Descrizione</th> <th>Qtà</th> <th>UM</th> </tr> </thead> <tbody> <tr> <td>CR1080A0</td> <td>CERNIERA DX INOX XV-XL-X</td> <td>1</td> <td>PZ</td> </tr> <tr> <td>CR1081A0</td> <td>CERNIERA SX INOX XV-XL-X</td> <td>1</td> <td>PZ</td> </tr> <tr> <td>GN1320A0</td> <td>GUARNIZIONE CERNIERA VETRO PORTA</td> <td>2</td> <td>PZ</td> </tr> <tr> <td>VI1685A0</td> <td>VITE NO TESTA EI M6X6 TESTA CONICA INOX</td> <td>4</td> <td>PZ</td> </tr> <tr> <td>VM1790A0</td> <td>BOCCOLA CERNIERA 12X6.5 DI5.3</td> <td>2</td> <td>PZ</td> </tr> </tbody> </table>	Codice	Descrizione	Qtà	UM	CR1080A0	CERNIERA DX INOX XV-XL-X	1	PZ	CR1081A0	CERNIERA SX INOX XV-XL-X	1	PZ	GN1320A0	GUARNIZIONE CERNIERA VETRO PORTA	2	PZ	VI1685A0	VITE NO TESTA EI M6X6 TESTA CONICA INOX	4	PZ	VM1790A0	BOCCOLA CERNIERA 12X6.5 DI5.3	2	PZ
Codice	Descrizione	Qtà	UM																										
CR1080A0	CERNIERA DX INOX XV-XL-X	1	PZ																										
CR1081A0	CERNIERA SX INOX XV-XL-X	1	PZ																										
GN1320A0	GUARNIZIONE CERNIERA VETRO PORTA	2	PZ																										
VI1685A0	VITE NO TESTA EI M6X6 TESTA CONICA INOX	4	PZ																										
VM1790A0	BOCCOLA CERNIERA 12X6.5 DI5.3	2	PZ																										
GN1320A	GUARNIZIONE CERNIERA VETRO PORTA		KGN1320A	KIT 4 GUARNIZIONI CERNIERE VETRO PORTA	<table border="1"> <thead> <tr> <th>Codice</th> <th>Descrizione</th> <th>Qtà</th> <th>UM</th> </tr> </thead> <tbody> <tr> <td>GN1320A0</td> <td>GUARNIZIONE CERNIERA VETRO PORTA</td> <td>4</td> <td>PZ</td> </tr> </tbody> </table>	Codice	Descrizione	Qtà	UM	GN1320A0	GUARNIZIONE CERNIERA VETRO PORTA	4	PZ																
			Codice	Descrizione	Qtà	UM																							
			GN1320A0	GUARNIZIONE CERNIERA VETRO PORTA	4	PZ																							
			KCR1081A	KIT CERNIERA SX/INF CR1081A	<table border="1"> <thead> <tr> <th>Codice</th> <th>Descrizione</th> <th>Qtà</th> <th>UM</th> </tr> </thead> <tbody> <tr> <td>CR1081A0</td> <td>CERNIERA SX INOX XV-XL-X</td> <td>1</td> <td>PZ</td> </tr> <tr> <td>GN1320A0</td> <td>GUARNIZIONE CERNIERA VETRO PORTA</td> <td>1</td> <td>PZ</td> </tr> <tr> <td>VI1083A0</td> <td>VITE M6X6 TC1/2T INOX</td> <td>2</td> <td>PZ</td> </tr> <tr> <td>VM1790A0</td> <td>BOCCOLA CERNIERA 12X6.5 DI5.3</td> <td>1</td> <td>PZ</td> </tr> </tbody> </table>	Codice	Descrizione	Qtà	UM	CR1081A0	CERNIERA SX INOX XV-XL-X	1	PZ	GN1320A0	GUARNIZIONE CERNIERA VETRO PORTA	1	PZ	VI1083A0	VITE M6X6 TC1/2T INOX	2	PZ	VM1790A0	BOCCOLA CERNIERA 12X6.5 DI5.3	1	PZ				
Codice	Descrizione	Qtà	UM																										
CR1081A0	CERNIERA SX INOX XV-XL-X	1	PZ																										
GN1320A0	GUARNIZIONE CERNIERA VETRO PORTA	1	PZ																										
VI1083A0	VITE M6X6 TC1/2T INOX	2	PZ																										
VM1790A0	BOCCOLA CERNIERA 12X6.5 DI5.3	1	PZ																										
KCR1080A	KIT CERNIERA DX/S	<table border="1"> <thead> <tr> <th>Codice</th> <th>Descrizione</th> <th>Qtà</th> <th>UM</th> </tr> </thead> <tbody> <tr> <td>CR1080A0</td> <td>CERNIERA DX INOX XV-XL-X</td> <td>1</td> <td>PZ</td> </tr> <tr> <td>CR1081A0</td> <td>CERNIERA SX INOX XV-XL-X</td> <td>1</td> <td>PZ</td> </tr> </tbody> </table>	Codice	Descrizione	Qtà	UM	CR1080A0	CERNIERA DX INOX XV-XL-X	1	PZ	CR1081A0	CERNIERA SX INOX XV-XL-X	1	PZ															
Codice	Descrizione	Qtà	UM																										
CR1080A0	CERNIERA DX INOX XV-XL-X	1	PZ																										
CR1081A0	CERNIERA SX INOX XV-XL-X	1	PZ																										
					<table border="1"> <thead> <tr> <th>Codice</th> <th>Descrizione</th> <th>Qtà</th> <th>UM</th> </tr> </thead> <tbody> <tr> <td>CR1080A0</td> <td>CERNIERA DX INOX XV-XL-X</td> <td>1</td> <td>PZ</td> </tr> <tr> <td>CR1081A0</td> <td>CERNIERA SX INOX XV-XL-X</td> <td>1</td> <td>PZ</td> </tr> </tbody> </table>	Codice	Descrizione	Qtà	UM	CR1080A0	CERNIERA DX INOX XV-XL-X	1	PZ	CR1081A0	CERNIERA SX INOX XV-XL-X	1	PZ												
Codice	Descrizione	Qtà	UM																										
CR1080A0	CERNIERA DX INOX XV-XL-X	1	PZ																										
CR1081A0	CERNIERA SX INOX XV-XL-X	1	PZ																										

COMPONENTE			RICAMBIO																						
Codice	Descrizione	Immagine	Codice	Descrizione	Lista componenti																				
GN1320A	GUARNIZIONE CERNIERA VETRO PORTA		KCR1080A	KIT CERNIERA DX/S	<table border="1"> <thead> <tr> <th>Codice</th> <th>Descrizione</th> <th>Qtà</th> <th>UM</th> </tr> </thead> <tbody> <tr> <td>GN1320A0</td> <td>GUARNIZIONE CERNIERA VETRO PORTA</td> <td>2</td> <td>PZ</td> </tr> <tr> <td>VI1685A0</td> <td>VITE NO TESTA EI M6X6 TESTA CONICA INOX</td> <td>4</td> <td>PZ</td> </tr> <tr> <td>VM1790A0</td> <td>BOCCOLA CERNIERA 12X6.5 DI5.3</td> <td>2</td> <td>PZ</td> </tr> </tbody> </table>	Codice	Descrizione	Qtà	UM	GN1320A0	GUARNIZIONE CERNIERA VETRO PORTA	2	PZ	VI1685A0	VITE NO TESTA EI M6X6 TESTA CONICA INOX	4	PZ	VM1790A0	BOCCOLA CERNIERA 12X6.5 DI5.3	2	PZ				
Codice	Descrizione	Qtà	UM																						
GN1320A0	GUARNIZIONE CERNIERA VETRO PORTA	2	PZ																						
VI1685A0	VITE NO TESTA EI M6X6 TESTA CONICA INOX	4	PZ																						
VM1790A0	BOCCOLA CERNIERA 12X6.5 DI5.3	2	PZ																						
MG1015B	TERMINALE MANIGLIA L.MISS/L.MICRO/CH EFTO		KMG1015B	KIT 2 PZ.TERMINALE MANIGLIA	<table border="1"> <thead> <tr> <th>Codice</th> <th>Descrizione</th> <th>Qtà</th> <th>UM</th> </tr> </thead> <tbody> <tr> <td>MG1015B0</td> <td>TERMINALE MANIGLIA L.MISS/L.MICR O/CHEFTO</td> <td>2</td> <td>PZ</td> </tr> <tr> <td>VI1855A0</td> <td>VITE AUTOFIL. 5X25 TCB+</td> <td>2</td> <td>PZ</td> </tr> <tr> <td>VI1870A0</td> <td>VITE AUTOFIL. X PLASTICA 5X50 TCB+</td> <td>2</td> <td>PZ</td> </tr> <tr> <td>VM1025A0</td> <td>TAPPO NYLON PA66 V2 GRIGIO Ø16</td> <td>2</td> <td>PZ</td> </tr> </tbody> </table>	Codice	Descrizione	Qtà	UM	MG1015B0	TERMINALE MANIGLIA L.MISS/L.MICR O/CHEFTO	2	PZ	VI1855A0	VITE AUTOFIL. 5X25 TCB+	2	PZ	VI1870A0	VITE AUTOFIL. X PLASTICA 5X50 TCB+	2	PZ	VM1025A0	TAPPO NYLON PA66 V2 GRIGIO Ø16	2	PZ
Codice	Descrizione	Qtà	UM																						
MG1015B0	TERMINALE MANIGLIA L.MISS/L.MICR O/CHEFTO	2	PZ																						
VI1855A0	VITE AUTOFIL. 5X25 TCB+	2	PZ																						
VI1870A0	VITE AUTOFIL. X PLASTICA 5X50 TCB+	2	PZ																						
VM1025A0	TAPPO NYLON PA66 V2 GRIGIO Ø16	2	PZ																						
VM1720A	RONDELLA PORTA XL405		VM1720A0	RONDELLA PORTA XL405																					
TB1077A	TUBO MANIGLIA XLT135/XLT195 118X		KTB1077A	KIT TUBO MANIGLIA XLT135/XLT195	<table border="1"> <thead> <tr> <th>Codice</th> <th>Descrizione</th> <th>Qtà</th> <th>UM</th> </tr> </thead> <tbody> <tr> <td>TB1077A0</td> <td>TUBO MANIGLIA XLT135/XLT195 5 118X1</td> <td>1</td> <td>PZ</td> </tr> <tr> <td>VI1220A1</td> <td>VITE AUTOFILETTA NTE 4.2X11 TCS+ MARUTE</td> <td>4</td> <td>PZ</td> </tr> <tr> <td>VM1794A0</td> <td>FASCETTA 250X4.8 PA66 NERA</td> <td>2</td> <td>PZ</td> </tr> <tr> <td>VM2103A0</td> <td>PIASTRINA FERMAFASCE TTA</td> <td>2</td> <td>PZ</td> </tr> </tbody> </table>	Codice	Descrizione	Qtà	UM	TB1077A0	TUBO MANIGLIA XLT135/XLT195 5 118X1	1	PZ	VI1220A1	VITE AUTOFILETTA NTE 4.2X11 TCS+ MARUTE	4	PZ	VM1794A0	FASCETTA 250X4.8 PA66 NERA	2	PZ	VM2103A0	PIASTRINA FERMAFASCE TTA	2	PZ
Codice	Descrizione	Qtà	UM																						
TB1077A0	TUBO MANIGLIA XLT135/XLT195 5 118X1	1	PZ																						
VI1220A1	VITE AUTOFILETTA NTE 4.2X11 TCS+ MARUTE	4	PZ																						
VM1794A0	FASCETTA 250X4.8 PA66 NERA	2	PZ																						
VM2103A0	PIASTRINA FERMAFASCE TTA	2	PZ																						

COMPONENTE			RICAMBIO																																																		
Codice	Descrizione	Immagine	Codice	Descrizione	Lista componenti																																																
0H4540A	LAMIERA PER CALAMITA PORTA XL 405		0H4540A0	LAMIERA PER CALAMITA PORTA XL 405																																																	
GN1330A	GUARNIZIONE LAMIERINO FERRITICO XL405		KVT1086BR	XLT195/XLT193 PORTA COMPLETA DX VETRO	<table border="1"> <thead> <tr> <th>Codice</th> <th>Descrizione</th> <th>Qtà</th> <th>UM</th> </tr> </thead> <tbody> <tr> <td>0H4540A0</td> <td>LAMIERA PER CALAMITA PORTA XL 405</td> <td>1</td> <td>PZ</td> </tr> <tr> <td>CR1080A0</td> <td>CERNIERA DX INOX XV-XL-X</td> <td>1</td> <td>PZ</td> </tr> <tr> <td>CR1081A0</td> <td>CERNIERA SX INOX XV-XL-X</td> <td>1</td> <td>PZ</td> </tr> <tr> <td>GN1320A0</td> <td>GUARNIZIONE CERNIERA VETRO PORTA</td> <td>2</td> <td>PZ</td> </tr> <tr> <td>GN1330A0</td> <td>GUARNIZIONE LAMIERINO FERRITICO XL405</td> <td>1</td> <td>PZ</td> </tr> <tr> <td>MG1015B0</td> <td>TERMINALE MANIGLIA L.MISS/L.MICR O/CHEFTO</td> <td>2</td> <td>PZ</td> </tr> <tr> <td>TB1077A0</td> <td>TUBO MANIGLIA XLT135/XLT19 5118X1</td> <td>1</td> <td>PZ</td> </tr> <tr> <td>V11685A0</td> <td>VITE NO TESTA EI M6X6 TESTA CONICA INOX</td> <td>4</td> <td>PZ</td> </tr> <tr> <td>VI1930A0</td> <td>VITE 5X25 TRUCIOLARE INOX</td> <td>2</td> <td>PZ</td> </tr> <tr> <td>VM1720A0</td> <td>RONDELLA PORTA XL405</td> <td>1</td> <td>PZ</td> </tr> <tr> <td>VT1086B0</td> <td>VETRO PORTA 399X661 NERO XLT195/XLT19</td> <td>1</td> <td>PZ</td> </tr> </tbody> </table>	Codice	Descrizione	Qtà	UM	0H4540A0	LAMIERA PER CALAMITA PORTA XL 405	1	PZ	CR1080A0	CERNIERA DX INOX XV-XL-X	1	PZ	CR1081A0	CERNIERA SX INOX XV-XL-X	1	PZ	GN1320A0	GUARNIZIONE CERNIERA VETRO PORTA	2	PZ	GN1330A0	GUARNIZIONE LAMIERINO FERRITICO XL405	1	PZ	MG1015B0	TERMINALE MANIGLIA L.MISS/L.MICR O/CHEFTO	2	PZ	TB1077A0	TUBO MANIGLIA XLT135/XLT19 5118X1	1	PZ	V11685A0	VITE NO TESTA EI M6X6 TESTA CONICA INOX	4	PZ	VI1930A0	VITE 5X25 TRUCIOLARE INOX	2	PZ	VM1720A0	RONDELLA PORTA XL405	1	PZ	VT1086B0	VETRO PORTA 399X661 NERO XLT195/XLT19	1	PZ
Codice	Descrizione	Qtà	UM																																																		
0H4540A0	LAMIERA PER CALAMITA PORTA XL 405	1	PZ																																																		
CR1080A0	CERNIERA DX INOX XV-XL-X	1	PZ																																																		
CR1081A0	CERNIERA SX INOX XV-XL-X	1	PZ																																																		
GN1320A0	GUARNIZIONE CERNIERA VETRO PORTA	2	PZ																																																		
GN1330A0	GUARNIZIONE LAMIERINO FERRITICO XL405	1	PZ																																																		
MG1015B0	TERMINALE MANIGLIA L.MISS/L.MICR O/CHEFTO	2	PZ																																																		
TB1077A0	TUBO MANIGLIA XLT135/XLT19 5118X1	1	PZ																																																		
V11685A0	VITE NO TESTA EI M6X6 TESTA CONICA INOX	4	PZ																																																		
VI1930A0	VITE 5X25 TRUCIOLARE INOX	2	PZ																																																		
VM1720A0	RONDELLA PORTA XL405	1	PZ																																																		
VT1086B0	VETRO PORTA 399X661 NERO XLT195/XLT19	1	PZ																																																		
			KVT1086BL	XLT195/XLT193 PORTA COMPLETA SX VETRO	<table border="1"> <thead> <tr> <th>Codice</th> <th>Descrizione</th> <th>Qtà</th> <th>UM</th> </tr> </thead> <tbody> <tr> <td>0H4540A0</td> <td>LAMIERA PER CALAMITA PORTA XL 405</td> <td>1</td> <td>PZ</td> </tr> <tr> <td>CR1080A0</td> <td>CERNIERA DX INOX XV-XL-X</td> <td>1</td> <td>PZ</td> </tr> <tr> <td>CR1081A0</td> <td>CERNIERA SX INOX XV-XL-X</td> <td>1</td> <td>PZ</td> </tr> </tbody> </table>	Codice	Descrizione	Qtà	UM	0H4540A0	LAMIERA PER CALAMITA PORTA XL 405	1	PZ	CR1080A0	CERNIERA DX INOX XV-XL-X	1	PZ	CR1081A0	CERNIERA SX INOX XV-XL-X	1	PZ																																
Codice	Descrizione	Qtà	UM																																																		
0H4540A0	LAMIERA PER CALAMITA PORTA XL 405	1	PZ																																																		
CR1080A0	CERNIERA DX INOX XV-XL-X	1	PZ																																																		
CR1081A0	CERNIERA SX INOX XV-XL-X	1	PZ																																																		

COMPONENTE			RICAMBIO																																						
Codice	Descrizione	Immagine	Codice	Descrizione	Lista componenti																																				
GN1330A	GUARNIZIONE LAMIERINO FERRITICO XL405		KVT1086BL	XLT195/XLT193 PORTA COMPLETA SX VETRO	<table border="1"> <thead> <tr> <th>Codice</th> <th>Descrizione</th> <th>Qtà</th> <th>UM</th> </tr> </thead> <tbody> <tr> <td>GN1320A0</td> <td>GUARNIZIONE CERNIERA VETRO PORTA</td> <td>2</td> <td>PZ</td> </tr> <tr> <td>GN1330A0</td> <td>GUARNIZIONE LAMIERINO FERRITICO XL405</td> <td>1</td> <td>PZ</td> </tr> <tr> <td>MG1015B0</td> <td>TERMINALE MANIGLIA L.MISS/L.MICR O/CHEFTO</td> <td>2</td> <td>PZ</td> </tr> <tr> <td>TB1077A0</td> <td>TUBO MANIGLIA XLT135/XLT19 5 Ì18X1</td> <td>1</td> <td>PZ</td> </tr> <tr> <td>VI1685A0</td> <td>VITE NO TESTA EI M6X6 TESTA CONICA INOX</td> <td>4</td> <td>PZ</td> </tr> <tr> <td>VI1930A0</td> <td>VITE 5X25 TRUCIOLARE INOX</td> <td>2</td> <td>PZ</td> </tr> <tr> <td>VM1720A0</td> <td>RONDELLA PORTA.XL405</td> <td>1</td> <td>PZ</td> </tr> <tr> <td>VT1086B0</td> <td>VETRO PORTA 399X661 NERO XLT195/XLT19</td> <td>1</td> <td>PZ</td> </tr> </tbody> </table>	Codice	Descrizione	Qtà	UM	GN1320A0	GUARNIZIONE CERNIERA VETRO PORTA	2	PZ	GN1330A0	GUARNIZIONE LAMIERINO FERRITICO XL405	1	PZ	MG1015B0	TERMINALE MANIGLIA L.MISS/L.MICR O/CHEFTO	2	PZ	TB1077A0	TUBO MANIGLIA XLT135/XLT19 5 Ì18X1	1	PZ	VI1685A0	VITE NO TESTA EI M6X6 TESTA CONICA INOX	4	PZ	VI1930A0	VITE 5X25 TRUCIOLARE INOX	2	PZ	VM1720A0	RONDELLA PORTA.XL405	1	PZ	VT1086B0	VETRO PORTA 399X661 NERO XLT195/XLT19	1	PZ
			Codice	Descrizione	Qtà	UM																																			
GN1320A0	GUARNIZIONE CERNIERA VETRO PORTA	2	PZ																																						
GN1330A0	GUARNIZIONE LAMIERINO FERRITICO XL405	1	PZ																																						
MG1015B0	TERMINALE MANIGLIA L.MISS/L.MICR O/CHEFTO	2	PZ																																						
TB1077A0	TUBO MANIGLIA XLT135/XLT19 5 Ì18X1	1	PZ																																						
VI1685A0	VITE NO TESTA EI M6X6 TESTA CONICA INOX	4	PZ																																						
VI1930A0	VITE 5X25 TRUCIOLARE INOX	2	PZ																																						
VM1720A0	RONDELLA PORTA.XL405	1	PZ																																						
VT1086B0	VETRO PORTA 399X661 NERO XLT195/XLT19	1	PZ																																						
KVT1076BR	XLT135/XLT133 PORTA COMPLETA DX VETRO	<table border="1"> <thead> <tr> <th>Codice</th> <th>Descrizione</th> <th>Qtà</th> <th>UM</th> </tr> </thead> <tbody> <tr> <td>0H4540A0</td> <td>LAMIERA PER CALAMITA PORTA XL 405</td> <td>1</td> <td>PZ</td> </tr> <tr> <td>CR1080A0</td> <td>CERNIERA DX INOX XV-XL-X</td> <td>1</td> <td>PZ</td> </tr> <tr> <td>CR1081A0</td> <td>CERNIERA SX INOX XV-XL-X</td> <td>1</td> <td>PZ</td> </tr> <tr> <td>GN1320A0</td> <td>GUARNIZIONE CERNIERA VETRO PORTA</td> <td>2</td> <td>PZ</td> </tr> <tr> <td>GN1330A0</td> <td>GUARNIZIONE LAMIERINO FERRITICO XL405</td> <td>1</td> <td>PZ</td> </tr> <tr> <td>IP1385A1</td> <td>IMB POL ANGOLARE 110X80X2000 D30</td> <td>1.400</td> <td>M</td> </tr> <tr> <td>IP1508A0</td> <td>POLISTIROLO PROFILO AD U 2000X60X60</td> <td>0.300</td> <td>PZ</td> </tr> <tr> <td>IP1508A1</td> <td>POLISTIROLO PROFILO AD U 2000X60X60</td> <td>2</td> <td>M</td> </tr> </tbody> </table>	Codice	Descrizione	Qtà	UM	0H4540A0	LAMIERA PER CALAMITA PORTA XL 405	1	PZ	CR1080A0	CERNIERA DX INOX XV-XL-X	1	PZ	CR1081A0	CERNIERA SX INOX XV-XL-X	1	PZ	GN1320A0	GUARNIZIONE CERNIERA VETRO PORTA	2	PZ	GN1330A0	GUARNIZIONE LAMIERINO FERRITICO XL405	1	PZ	IP1385A1	IMB POL ANGOLARE 110X80X2000 D30	1.400	M	IP1508A0	POLISTIROLO PROFILO AD U 2000X60X60	0.300	PZ	IP1508A1	POLISTIROLO PROFILO AD U 2000X60X60	2	M			
Codice	Descrizione	Qtà	UM																																						
0H4540A0	LAMIERA PER CALAMITA PORTA XL 405	1	PZ																																						
CR1080A0	CERNIERA DX INOX XV-XL-X	1	PZ																																						
CR1081A0	CERNIERA SX INOX XV-XL-X	1	PZ																																						
GN1320A0	GUARNIZIONE CERNIERA VETRO PORTA	2	PZ																																						
GN1330A0	GUARNIZIONE LAMIERINO FERRITICO XL405	1	PZ																																						
IP1385A1	IMB POL ANGOLARE 110X80X2000 D30	1.400	M																																						
IP1508A0	POLISTIROLO PROFILO AD U 2000X60X60	0.300	PZ																																						
IP1508A1	POLISTIROLO PROFILO AD U 2000X60X60	2	M																																						

COMPONENTE			RICAMBIO																																															
Codice	Descrizione	Immagine	Codice	Descrizione	Lista componenti																																													
GN1330A	GUARNIZIONE LAMIERINO FERRITICO XL405		KVT1076BR	XLT135/XLT133 PORTA COMPLETA DX VETRO	<table border="1"> <thead> <tr> <th>Codice</th> <th>Descrizione</th> <th>Qtà</th> <th>UM</th> </tr> </thead> <tbody> <tr> <td>MG1015B0</td> <td>TERMINALE MANIGLIA L.MISS/L.MICR O/CHEFTO</td> <td>2</td> <td>PZ</td> </tr> <tr> <td>TB1077A0</td> <td>TUBO MANIGLIA XLT135/XLT19 5 Ì18X1</td> <td>1</td> <td>PZ</td> </tr> <tr> <td>VI1685A0</td> <td>VITE NO TESTA EI M6X6 TESTA CONICA INOX</td> <td>4</td> <td>PZ</td> </tr> <tr> <td>VI1930A0</td> <td>VITE 5X25 TRUCIOLARE INOX</td> <td>2</td> <td>PZ</td> </tr> <tr> <td>VM1059A1</td> <td>FILM TERMORETRA IBILE H800</td> <td>1.500</td> <td>M</td> </tr> <tr> <td>VM1720A0</td> <td>RONDELLA PORTA XL405</td> <td>1</td> <td>PZ</td> </tr> <tr> <td>VT1076B0</td> <td>VETRO PORTA 299X661 NERO XLT135/XLT13</td> <td>1</td> <td>PZ</td> </tr> </tbody> </table>	Codice	Descrizione	Qtà	UM	MG1015B0	TERMINALE MANIGLIA L.MISS/L.MICR O/CHEFTO	2	PZ	TB1077A0	TUBO MANIGLIA XLT135/XLT19 5 Ì18X1	1	PZ	VI1685A0	VITE NO TESTA EI M6X6 TESTA CONICA INOX	4	PZ	VI1930A0	VITE 5X25 TRUCIOLARE INOX	2	PZ	VM1059A1	FILM TERMORETRA IBILE H800	1.500	M	VM1720A0	RONDELLA PORTA XL405	1	PZ	VT1076B0	VETRO PORTA 299X661 NERO XLT135/XLT13	1	PZ													
			Codice	Descrizione	Qtà	UM																																												
MG1015B0	TERMINALE MANIGLIA L.MISS/L.MICR O/CHEFTO	2	PZ																																															
TB1077A0	TUBO MANIGLIA XLT135/XLT19 5 Ì18X1	1	PZ																																															
VI1685A0	VITE NO TESTA EI M6X6 TESTA CONICA INOX	4	PZ																																															
VI1930A0	VITE 5X25 TRUCIOLARE INOX	2	PZ																																															
VM1059A1	FILM TERMORETRA IBILE H800	1.500	M																																															
VM1720A0	RONDELLA PORTA XL405	1	PZ																																															
VT1076B0	VETRO PORTA 299X661 NERO XLT135/XLT13	1	PZ																																															
KVT1076BL	XLT135/XLT133 PORTA COMPLETA SX VETRO	<table border="1"> <thead> <tr> <th>Codice</th> <th>Descrizione</th> <th>Qtà</th> <th>UM</th> </tr> </thead> <tbody> <tr> <td>OH4540A0</td> <td>LAMIERA PER CALAMITA PORTA XL 405</td> <td>1</td> <td>PZ</td> </tr> <tr> <td>CR1080A0</td> <td>CERNIERA DX INOX XV-XL-X</td> <td>1</td> <td>PZ</td> </tr> <tr> <td>CR1081A0</td> <td>CERNIERA SX INOX XV-XL-X</td> <td>1</td> <td>PZ</td> </tr> <tr> <td>GN1320A0</td> <td>GUARNIZIONE CERNIERA VETRO PORTA</td> <td>2</td> <td>PZ</td> </tr> <tr> <td>GN1330A0</td> <td>GUARNIZIONE LAMIERINO FERRITICO XL405</td> <td>1</td> <td>PZ</td> </tr> <tr> <td>MG1015B0</td> <td>TERMINALE MANIGLIA L.MISS/L.MICR O/CHEFTO</td> <td>2</td> <td>PZ</td> </tr> <tr> <td>TB1077A0</td> <td>TUBO MANIGLIA XLT135/XLT19 5 Ì18X1</td> <td>1</td> <td>PZ</td> </tr> <tr> <td>VI1685A0</td> <td>VITE NO TESTA EI M6X6 TESTA CONICA INOX</td> <td>4</td> <td>PZ</td> </tr> <tr> <td>VI1930A0</td> <td>VITE 5X25 TRUCIOLARE INOX</td> <td>2</td> <td>PZ</td> </tr> <tr> <td>VM1720A0</td> <td>RONDELLA PORTA XL405</td> <td>1</td> <td>PZ</td> </tr> <tr> <td>VT1076B0</td> <td>VETRO PORTA 299X661 NERO XLT135/XLT13</td> <td>1</td> <td>PZ</td> </tr> </tbody> </table>	Codice	Descrizione	Qtà	UM	OH4540A0	LAMIERA PER CALAMITA PORTA XL 405	1	PZ	CR1080A0	CERNIERA DX INOX XV-XL-X	1	PZ	CR1081A0	CERNIERA SX INOX XV-XL-X	1	PZ	GN1320A0	GUARNIZIONE CERNIERA VETRO PORTA	2	PZ	GN1330A0	GUARNIZIONE LAMIERINO FERRITICO XL405	1	PZ	MG1015B0	TERMINALE MANIGLIA L.MISS/L.MICR O/CHEFTO	2	PZ	TB1077A0	TUBO MANIGLIA XLT135/XLT19 5 Ì18X1	1	PZ	VI1685A0	VITE NO TESTA EI M6X6 TESTA CONICA INOX	4	PZ	VI1930A0	VITE 5X25 TRUCIOLARE INOX	2	PZ	VM1720A0	RONDELLA PORTA XL405	1	PZ	VT1076B0	VETRO PORTA 299X661 NERO XLT135/XLT13	1	PZ
Codice	Descrizione	Qtà	UM																																															
OH4540A0	LAMIERA PER CALAMITA PORTA XL 405	1	PZ																																															
CR1080A0	CERNIERA DX INOX XV-XL-X	1	PZ																																															
CR1081A0	CERNIERA SX INOX XV-XL-X	1	PZ																																															
GN1320A0	GUARNIZIONE CERNIERA VETRO PORTA	2	PZ																																															
GN1330A0	GUARNIZIONE LAMIERINO FERRITICO XL405	1	PZ																																															
MG1015B0	TERMINALE MANIGLIA L.MISS/L.MICR O/CHEFTO	2	PZ																																															
TB1077A0	TUBO MANIGLIA XLT135/XLT19 5 Ì18X1	1	PZ																																															
VI1685A0	VITE NO TESTA EI M6X6 TESTA CONICA INOX	4	PZ																																															
VI1930A0	VITE 5X25 TRUCIOLARE INOX	2	PZ																																															
VM1720A0	RONDELLA PORTA XL405	1	PZ																																															
VT1076B0	VETRO PORTA 299X661 NERO XLT135/XLT13	1	PZ																																															

COMPONENTE			RICAMBIO																																																																										
Codice	Descrizione	Immagine	Codice	Descrizione	Lista componenti																																																																								
GN1330A	GUARNIZIONE LAMIERINO FERRITICO XL405		KDR1210AR	PORTA COMPLETA XL405 RIGHT	<table border="1"> <thead> <tr> <th>Codice</th> <th>Descrizione</th> <th>Qtà</th> <th>UM</th> </tr> </thead> <tbody> <tr> <td>0H4530C0</td> <td>SGOCCIOLAT OIO PORTA DX XL415</td> <td>1</td> <td>PZ</td> </tr> <tr> <td>0H4540A0</td> <td>LAMIERA PER CALAMITA PORTA XL 405</td> <td>1</td> <td>PZ</td> </tr> <tr> <td>CR1080A0</td> <td>CERNIERA DX INOX XV-XL-X</td> <td>1</td> <td>PZ</td> </tr> <tr> <td>CR1081A0</td> <td>CERNIERA SX INOX XV-XL-X</td> <td>1</td> <td>PZ</td> </tr> <tr> <td>GN1320A0</td> <td>GUARNIZIONE CERNIERA VETRO PORTA</td> <td>2</td> <td>PZ</td> </tr> <tr> <td>GN1330A0</td> <td>GUARNIZIONE LAMIERINO FERRITICO XL405</td> <td>1</td> <td>PZ</td> </tr> <tr> <td>IP1385A1</td> <td>IMB POL ANGOLARE 110X80X2000 D30</td> <td>1.300</td> <td>M</td> </tr> <tr> <td>IP1508A0</td> <td>POLISTIROLO PROFILO AD U 2000X60X60</td> <td>0.570</td> <td>PZ</td> </tr> <tr> <td>IP1508A1</td> <td>POLISTIROLO PROFILO AD U 2000X60X60</td> <td>2</td> <td>M</td> </tr> <tr> <td>MG1015B0</td> <td>TERMINALE MANIGLIA L.MISS/L.MICR O/CHEFTO</td> <td>2</td> <td>PZ</td> </tr> <tr> <td>TB1730A0</td> <td>TUBO MANIGLIA XL405 Ø18X1</td> <td>1</td> <td>PZ</td> </tr> <tr> <td>VI1685A0</td> <td>VITE NO TESTA EI M6X6 TESTA CONICA INOX</td> <td>4</td> <td>PZ</td> </tr> <tr> <td>VI1930A0</td> <td>VITE 5X25 TRUCIOLARE INOX</td> <td>2</td> <td>PZ</td> </tr> <tr> <td>VM1059A1</td> <td>FILM TERMORETRA IBILE H800</td> <td>1.300</td> <td>M</td> </tr> <tr> <td>VM1720A0</td> <td>RONDELLA PORTA XL405</td> <td>1</td> <td>PZ</td> </tr> <tr> <td>VM1790A0</td> <td>BOCCOLA CERNIERA 12X6.5 DI5.3</td> <td>2</td> <td>PZ</td> </tr> <tr> <td>VT1210A0</td> <td>VETRO PORTA XL405</td> <td>1</td> <td>PZ</td> </tr> </tbody> </table>	Codice	Descrizione	Qtà	UM	0H4530C0	SGOCCIOLAT OIO PORTA DX XL415	1	PZ	0H4540A0	LAMIERA PER CALAMITA PORTA XL 405	1	PZ	CR1080A0	CERNIERA DX INOX XV-XL-X	1	PZ	CR1081A0	CERNIERA SX INOX XV-XL-X	1	PZ	GN1320A0	GUARNIZIONE CERNIERA VETRO PORTA	2	PZ	GN1330A0	GUARNIZIONE LAMIERINO FERRITICO XL405	1	PZ	IP1385A1	IMB POL ANGOLARE 110X80X2000 D30	1.300	M	IP1508A0	POLISTIROLO PROFILO AD U 2000X60X60	0.570	PZ	IP1508A1	POLISTIROLO PROFILO AD U 2000X60X60	2	M	MG1015B0	TERMINALE MANIGLIA L.MISS/L.MICR O/CHEFTO	2	PZ	TB1730A0	TUBO MANIGLIA XL405 Ø18X1	1	PZ	VI1685A0	VITE NO TESTA EI M6X6 TESTA CONICA INOX	4	PZ	VI1930A0	VITE 5X25 TRUCIOLARE INOX	2	PZ	VM1059A1	FILM TERMORETRA IBILE H800	1.300	M	VM1720A0	RONDELLA PORTA XL405	1	PZ	VM1790A0	BOCCOLA CERNIERA 12X6.5 DI5.3	2	PZ	VT1210A0	VETRO PORTA XL405	1	PZ
Codice	Descrizione	Qtà	UM																																																																										
0H4530C0	SGOCCIOLAT OIO PORTA DX XL415	1	PZ																																																																										
0H4540A0	LAMIERA PER CALAMITA PORTA XL 405	1	PZ																																																																										
CR1080A0	CERNIERA DX INOX XV-XL-X	1	PZ																																																																										
CR1081A0	CERNIERA SX INOX XV-XL-X	1	PZ																																																																										
GN1320A0	GUARNIZIONE CERNIERA VETRO PORTA	2	PZ																																																																										
GN1330A0	GUARNIZIONE LAMIERINO FERRITICO XL405	1	PZ																																																																										
IP1385A1	IMB POL ANGOLARE 110X80X2000 D30	1.300	M																																																																										
IP1508A0	POLISTIROLO PROFILO AD U 2000X60X60	0.570	PZ																																																																										
IP1508A1	POLISTIROLO PROFILO AD U 2000X60X60	2	M																																																																										
MG1015B0	TERMINALE MANIGLIA L.MISS/L.MICR O/CHEFTO	2	PZ																																																																										
TB1730A0	TUBO MANIGLIA XL405 Ø18X1	1	PZ																																																																										
VI1685A0	VITE NO TESTA EI M6X6 TESTA CONICA INOX	4	PZ																																																																										
VI1930A0	VITE 5X25 TRUCIOLARE INOX	2	PZ																																																																										
VM1059A1	FILM TERMORETRA IBILE H800	1.300	M																																																																										
VM1720A0	RONDELLA PORTA XL405	1	PZ																																																																										
VM1790A0	BOCCOLA CERNIERA 12X6.5 DI5.3	2	PZ																																																																										
VT1210A0	VETRO PORTA XL405	1	PZ																																																																										





COMPONENTE			RICAMBIO																																																																										
Codice	Descrizione	Immagine	Codice	Descrizione	Lista componenti																																																																								
GN1330A	GUARNIZIONE LAMIERINO FERRITICO XL405		KDR1210AL	PORTA COMPLETA XL405 LEFT	<table border="1"> <thead> <tr> <th>Codice</th> <th>Descrizione</th> <th>Qtà</th> <th>UM</th> </tr> </thead> <tbody> <tr> <td>0H4535C0</td> <td>SGOCCIOLAT OIO PORTA SX XL415</td> <td>1</td> <td>PZ</td> </tr> <tr> <td>0H4540A0</td> <td>LAMIERA PER CALAMITA PORTA XL 405</td> <td>1</td> <td>PZ</td> </tr> <tr> <td>CR1080A0</td> <td>CERNIERA DX INOX XV-XL-X</td> <td>1</td> <td>PZ</td> </tr> <tr> <td>CR1081A0</td> <td>CERNIERA SX INOX XV-XL-X</td> <td>1</td> <td>PZ</td> </tr> <tr> <td>GN1320A0</td> <td>GUARNIZIONE CERNIERA VETRO PORTA</td> <td>2</td> <td>PZ</td> </tr> <tr> <td>GN1330A0</td> <td>GUARNIZIONE LAMIERINO FERRITICO XL405</td> <td>1</td> <td>PZ</td> </tr> <tr> <td>IP1385A1</td> <td>IMB POL ANGOLARE 110X80X2000 D30</td> <td>1.300</td> <td>M</td> </tr> <tr> <td>IP1508A0</td> <td>POLISTIROLO PROFILO AD U 2000X60X60</td> <td>0.570</td> <td>PZ</td> </tr> <tr> <td>IP1508A1</td> <td>POLISTIROLO PROFILO AD U 2000X60X60</td> <td>2</td> <td>M</td> </tr> <tr> <td>MG1015B0</td> <td>TERMINALE MANIGLIA L.MISS/L.MICR O/CHEFTO</td> <td>2</td> <td>PZ</td> </tr> <tr> <td>TB1730A0</td> <td>TUBO MANIGLIA XL405 Ø18X1</td> <td>1</td> <td>PZ</td> </tr> <tr> <td>VI1685A0</td> <td>VITE NO TESTA EI M6X6 TESTA CONICA INOX</td> <td>4</td> <td>PZ</td> </tr> <tr> <td>VI1930A0</td> <td>VITE 5X25 TRUCIOLARE INOX</td> <td>2</td> <td>PZ</td> </tr> <tr> <td>VM1059A1</td> <td>FILM TERMORETRA IBILE H800</td> <td>1.300</td> <td>M</td> </tr> <tr> <td>VM1720A0</td> <td>RONDELLA PORTA XL405</td> <td>1</td> <td>PZ</td> </tr> <tr> <td>VM1790A0</td> <td>BOCCOLA CERNIERA 12X6.5 DI5.3</td> <td>2</td> <td>PZ</td> </tr> <tr> <td>VT1210A0</td> <td>VETRO PORTA XL405</td> <td>1</td> <td>PZ</td> </tr> </tbody> </table>	Codice	Descrizione	Qtà	UM	0H4535C0	SGOCCIOLAT OIO PORTA SX XL415	1	PZ	0H4540A0	LAMIERA PER CALAMITA PORTA XL 405	1	PZ	CR1080A0	CERNIERA DX INOX XV-XL-X	1	PZ	CR1081A0	CERNIERA SX INOX XV-XL-X	1	PZ	GN1320A0	GUARNIZIONE CERNIERA VETRO PORTA	2	PZ	GN1330A0	GUARNIZIONE LAMIERINO FERRITICO XL405	1	PZ	IP1385A1	IMB POL ANGOLARE 110X80X2000 D30	1.300	M	IP1508A0	POLISTIROLO PROFILO AD U 2000X60X60	0.570	PZ	IP1508A1	POLISTIROLO PROFILO AD U 2000X60X60	2	M	MG1015B0	TERMINALE MANIGLIA L.MISS/L.MICR O/CHEFTO	2	PZ	TB1730A0	TUBO MANIGLIA XL405 Ø18X1	1	PZ	VI1685A0	VITE NO TESTA EI M6X6 TESTA CONICA INOX	4	PZ	VI1930A0	VITE 5X25 TRUCIOLARE INOX	2	PZ	VM1059A1	FILM TERMORETRA IBILE H800	1.300	M	VM1720A0	RONDELLA PORTA XL405	1	PZ	VM1790A0	BOCCOLA CERNIERA 12X6.5 DI5.3	2	PZ	VT1210A0	VETRO PORTA XL405	1	PZ
Codice	Descrizione	Qtà	UM																																																																										
0H4535C0	SGOCCIOLAT OIO PORTA SX XL415	1	PZ																																																																										
0H4540A0	LAMIERA PER CALAMITA PORTA XL 405	1	PZ																																																																										
CR1080A0	CERNIERA DX INOX XV-XL-X	1	PZ																																																																										
CR1081A0	CERNIERA SX INOX XV-XL-X	1	PZ																																																																										
GN1320A0	GUARNIZIONE CERNIERA VETRO PORTA	2	PZ																																																																										
GN1330A0	GUARNIZIONE LAMIERINO FERRITICO XL405	1	PZ																																																																										
IP1385A1	IMB POL ANGOLARE 110X80X2000 D30	1.300	M																																																																										
IP1508A0	POLISTIROLO PROFILO AD U 2000X60X60	0.570	PZ																																																																										
IP1508A1	POLISTIROLO PROFILO AD U 2000X60X60	2	M																																																																										
MG1015B0	TERMINALE MANIGLIA L.MISS/L.MICR O/CHEFTO	2	PZ																																																																										
TB1730A0	TUBO MANIGLIA XL405 Ø18X1	1	PZ																																																																										
VI1685A0	VITE NO TESTA EI M6X6 TESTA CONICA INOX	4	PZ																																																																										
VI1930A0	VITE 5X25 TRUCIOLARE INOX	2	PZ																																																																										
VM1059A1	FILM TERMORETRA IBILE H800	1.300	M																																																																										
VM1720A0	RONDELLA PORTA XL405	1	PZ																																																																										
VM1790A0	BOCCOLA CERNIERA 12X6.5 DI5.3	2	PZ																																																																										
VT1210A0	VETRO PORTA XL405	1	PZ																																																																										

COMPONENTE			RICAMBIO																																																		
Codice	Descrizione	Immagine	Codice	Descrizione	Lista componenti																																																
VT1086B	VETRO PORTA 399X661 NERO XLT195/XLT193		KVT1086BR	XLT195/XLT193 PORTA COMPLETA DX VETRO	<table border="1"> <thead> <tr> <th>Codice</th> <th>Descrizione</th> <th>Qtà</th> <th>UM</th> </tr> </thead> <tbody> <tr> <td>0H4540A0</td> <td>LAMIERA PER CALAMITA PORTA XL 405</td> <td>1</td> <td>PZ</td> </tr> <tr> <td>CR1080A0</td> <td>CERNIERA DX INOX XV-XL-X</td> <td>1</td> <td>PZ</td> </tr> <tr> <td>CR1081A0</td> <td>CERNIERA SX INOX XV-XL-X</td> <td>1</td> <td>PZ</td> </tr> <tr> <td>GN1320A0</td> <td>GUARNIZIONE CERNIERA VETRO PORTA</td> <td>2</td> <td>PZ</td> </tr> <tr> <td>GN1330A0</td> <td>GUARNIZIONE LAMIERINO FERRITICO XL405</td> <td>1</td> <td>PZ</td> </tr> <tr> <td>MG1015B0</td> <td>TERMINALE MANIGLIA L.MISS/L.MICR O/CHEFTO</td> <td>2</td> <td>PZ</td> </tr> <tr> <td>TB1077A0</td> <td>TUBO MANIGLIA XLT135/XLT19 5 118X1</td> <td>1</td> <td>PZ</td> </tr> <tr> <td>VI1685A0</td> <td>VITE NO TESTA EI M6X6 TESTA CONICA INOX</td> <td>4</td> <td>PZ</td> </tr> <tr> <td>VI1930A0</td> <td>VITE 5X25 TRUCIOLARE INOX</td> <td>2</td> <td>PZ</td> </tr> <tr> <td>VM1720A0</td> <td>RONDELLA PORTA XL405</td> <td>1</td> <td>PZ</td> </tr> <tr> <td>VT1086B0</td> <td>VETRO PORTA 399X661 NERO XLT195/XLT193</td> <td>1</td> <td>PZ</td> </tr> </tbody> </table>	Codice	Descrizione	Qtà	UM	0H4540A0	LAMIERA PER CALAMITA PORTA XL 405	1	PZ	CR1080A0	CERNIERA DX INOX XV-XL-X	1	PZ	CR1081A0	CERNIERA SX INOX XV-XL-X	1	PZ	GN1320A0	GUARNIZIONE CERNIERA VETRO PORTA	2	PZ	GN1330A0	GUARNIZIONE LAMIERINO FERRITICO XL405	1	PZ	MG1015B0	TERMINALE MANIGLIA L.MISS/L.MICR O/CHEFTO	2	PZ	TB1077A0	TUBO MANIGLIA XLT135/XLT19 5 118X1	1	PZ	VI1685A0	VITE NO TESTA EI M6X6 TESTA CONICA INOX	4	PZ	VI1930A0	VITE 5X25 TRUCIOLARE INOX	2	PZ	VM1720A0	RONDELLA PORTA XL405	1	PZ	VT1086B0	VETRO PORTA 399X661 NERO XLT195/XLT193	1	PZ
			Codice	Descrizione	Qtà	UM																																															
0H4540A0	LAMIERA PER CALAMITA PORTA XL 405	1	PZ																																																		
CR1080A0	CERNIERA DX INOX XV-XL-X	1	PZ																																																		
CR1081A0	CERNIERA SX INOX XV-XL-X	1	PZ																																																		
GN1320A0	GUARNIZIONE CERNIERA VETRO PORTA	2	PZ																																																		
GN1330A0	GUARNIZIONE LAMIERINO FERRITICO XL405	1	PZ																																																		
MG1015B0	TERMINALE MANIGLIA L.MISS/L.MICR O/CHEFTO	2	PZ																																																		
TB1077A0	TUBO MANIGLIA XLT135/XLT19 5 118X1	1	PZ																																																		
VI1685A0	VITE NO TESTA EI M6X6 TESTA CONICA INOX	4	PZ																																																		
VI1930A0	VITE 5X25 TRUCIOLARE INOX	2	PZ																																																		
VM1720A0	RONDELLA PORTA XL405	1	PZ																																																		
VT1086B0	VETRO PORTA 399X661 NERO XLT195/XLT193	1	PZ																																																		
KVT1086BL	XLT195/XLT193 PORTA COMPLETA SX VETRO	<table border="1"> <thead> <tr> <th>Codice</th> <th>Descrizione</th> <th>Qtà</th> <th>UM</th> </tr> </thead> <tbody> <tr> <td>0H4540A0</td> <td>LAMIERA PER CALAMITA PORTA XL 405</td> <td>1</td> <td>PZ</td> </tr> <tr> <td>CR1080A0</td> <td>CERNIERA DX INOX XV-XL-X</td> <td>1</td> <td>PZ</td> </tr> <tr> <td>CR1081A0</td> <td>CERNIERA SX INOX XV-XL-X</td> <td>1</td> <td>PZ</td> </tr> <tr> <td>GN1320A0</td> <td>GUARNIZIONE CERNIERA VETRO PORTA</td> <td>2</td> <td>PZ</td> </tr> <tr> <td>GN1330A0</td> <td>GUARNIZIONE LAMIERINO FERRITICO XL405</td> <td>1</td> <td>PZ</td> </tr> <tr> <td>MG1015B0</td> <td>TERMINALE MANIGLIA L.MISS/L.MICR O/CHEFTO</td> <td>2</td> <td>PZ</td> </tr> </tbody> </table>	Codice	Descrizione	Qtà	UM	0H4540A0	LAMIERA PER CALAMITA PORTA XL 405	1	PZ	CR1080A0	CERNIERA DX INOX XV-XL-X	1	PZ	CR1081A0	CERNIERA SX INOX XV-XL-X	1	PZ	GN1320A0	GUARNIZIONE CERNIERA VETRO PORTA	2	PZ	GN1330A0	GUARNIZIONE LAMIERINO FERRITICO XL405	1	PZ	MG1015B0	TERMINALE MANIGLIA L.MISS/L.MICR O/CHEFTO	2	PZ																							
Codice	Descrizione	Qtà	UM																																																		
0H4540A0	LAMIERA PER CALAMITA PORTA XL 405	1	PZ																																																		
CR1080A0	CERNIERA DX INOX XV-XL-X	1	PZ																																																		
CR1081A0	CERNIERA SX INOX XV-XL-X	1	PZ																																																		
GN1320A0	GUARNIZIONE CERNIERA VETRO PORTA	2	PZ																																																		
GN1330A0	GUARNIZIONE LAMIERINO FERRITICO XL405	1	PZ																																																		
MG1015B0	TERMINALE MANIGLIA L.MISS/L.MICR O/CHEFTO	2	PZ																																																		

COMPONENTE			RICAMBIO																										
Codice	Descrizione	Immagine	Codice	Descrizione	Lista componenti																								
VT1086B	VETRO PORTA 399X661 NERO XLT195/XLT193		KVT1086BL	XLT195/XLT193 PORTA COMPLETA SX VETRO	<table border="1"> <thead> <tr> <th>Codice</th> <th>Descrizione</th> <th>Qtà</th> <th>UM</th> </tr> </thead> <tbody> <tr> <td>TB1077A0</td> <td>TUBO MANIGLIA XLT135/XLT19 5 1/8X1</td> <td>1</td> <td>PZ</td> </tr> <tr> <td>VI1685A0</td> <td>VITE NO TESTA EI M6X6 TESTA CONICA INOX</td> <td>4</td> <td>PZ</td> </tr> <tr> <td>VI1930A0</td> <td>VITE 5X25 TRUCIOLARE INOX</td> <td>2</td> <td>PZ</td> </tr> <tr> <td>VM1720A0</td> <td>RONDELLA PORTA XL405</td> <td>1</td> <td>PZ</td> </tr> <tr> <td>VT1086B0</td> <td>VETRO PORTA 399X661 NERO XLT195/XLT19</td> <td>1</td> <td>PZ</td> </tr> </tbody> </table>	Codice	Descrizione	Qtà	UM	TB1077A0	TUBO MANIGLIA XLT135/XLT19 5 1/8X1	1	PZ	VI1685A0	VITE NO TESTA EI M6X6 TESTA CONICA INOX	4	PZ	VI1930A0	VITE 5X25 TRUCIOLARE INOX	2	PZ	VM1720A0	RONDELLA PORTA XL405	1	PZ	VT1086B0	VETRO PORTA 399X661 NERO XLT195/XLT19	1	PZ
Codice	Descrizione	Qtà	UM																										
TB1077A0	TUBO MANIGLIA XLT135/XLT19 5 1/8X1	1	PZ																										
VI1685A0	VITE NO TESTA EI M6X6 TESTA CONICA INOX	4	PZ																										
VI1930A0	VITE 5X25 TRUCIOLARE INOX	2	PZ																										
VM1720A0	RONDELLA PORTA XL405	1	PZ																										
VT1086B0	VETRO PORTA 399X661 NERO XLT195/XLT19	1	PZ																										
VM1022B	STAFFA SUPERIORE PORTA LIEVITATOR		KVM1022B KVM1022A	KIT STAFFA SUP. PORTA LIEVITATORE VM102 KIT STAFFA SUP.PORTA LIEVITATORE VM102	<table border="1"> <thead> <tr> <th>Codice</th> <th>Descrizione</th> <th>Qtà</th> <th>UM</th> </tr> </thead> <tbody> <tr> <td>VM1022B0</td> <td>STAFFA SUPERIORE PORTA LIEVITATORE</td> <td>1</td> <td>PZ</td> </tr> <tr> <td>VM1022A0</td> <td>STAFFA SUPERIORE PORTA LIEVITATORE</td> <td>1</td> <td>PZ</td> </tr> </tbody> </table>	Codice	Descrizione	Qtà	UM	VM1022B0	STAFFA SUPERIORE PORTA LIEVITATORE	1	PZ	VM1022A0	STAFFA SUPERIORE PORTA LIEVITATORE	1	PZ												
Codice	Descrizione	Qtà	UM																										
VM1022B0	STAFFA SUPERIORE PORTA LIEVITATORE	1	PZ																										
VM1022A0	STAFFA SUPERIORE PORTA LIEVITATORE	1	PZ																										
VM1023B	STAFFA INFERIORE DX PORTA LIEVITATORE		KVM1024A	KIT STAFFE INFERIORI PORTA LIEVITATORE	<table border="1"> <thead> <tr> <th>Codice</th> <th>Descrizione</th> <th>Qtà</th> <th>UM</th> </tr> </thead> <tbody> <tr> <td>VM1023A0</td> <td>STAFFA INFERIORE DX PORTA LIEVITATORE</td> <td>1</td> <td>PZ</td> </tr> <tr> <td>VM1024A0</td> <td>STAFFA INFERIORE SX PORTA LIEVITATORE</td> <td>1</td> <td>PZ</td> </tr> </tbody> </table>	Codice	Descrizione	Qtà	UM	VM1023A0	STAFFA INFERIORE DX PORTA LIEVITATORE	1	PZ	VM1024A0	STAFFA INFERIORE SX PORTA LIEVITATORE	1	PZ												
Codice	Descrizione	Qtà	UM																										
VM1023A0	STAFFA INFERIORE DX PORTA LIEVITATORE	1	PZ																										
VM1024A0	STAFFA INFERIORE SX PORTA LIEVITATORE	1	PZ																										
CR1081A	CERNIERA SX INOX XV-XL-XB		KCR1080A	KIT CERNIERA DX/S	<table border="1"> <thead> <tr> <th>Codice</th> <th>Descrizione</th> <th>Qtà</th> <th>UM</th> </tr> </thead> <tbody> <tr> <td>CR1080A0</td> <td>CERNIERA DX INOX XV-XL-X</td> <td>1</td> <td>PZ</td> </tr> <tr> <td>CR1081A0</td> <td>CERNIERA SX INOX XV-XL-X</td> <td>1</td> <td>PZ</td> </tr> <tr> <td>GN1320A0</td> <td>GUARNIZIONE CERNIERA VETRO PORTA</td> <td>2</td> <td>PZ</td> </tr> <tr> <td>VI1685A0</td> <td>VITE NO TESTA EI M6X6 TESTA CONICA INOX</td> <td>4</td> <td>PZ</td> </tr> <tr> <td>VM1790A0</td> <td>BOCCOLA CERNIERA 12X6.5 DI5.3</td> <td>2</td> <td>PZ</td> </tr> </tbody> </table>	Codice	Descrizione	Qtà	UM	CR1080A0	CERNIERA DX INOX XV-XL-X	1	PZ	CR1081A0	CERNIERA SX INOX XV-XL-X	1	PZ	GN1320A0	GUARNIZIONE CERNIERA VETRO PORTA	2	PZ	VI1685A0	VITE NO TESTA EI M6X6 TESTA CONICA INOX	4	PZ	VM1790A0	BOCCOLA CERNIERA 12X6.5 DI5.3	2	PZ
Codice	Descrizione	Qtà	UM																										
CR1080A0	CERNIERA DX INOX XV-XL-X	1	PZ																										
CR1081A0	CERNIERA SX INOX XV-XL-X	1	PZ																										
GN1320A0	GUARNIZIONE CERNIERA VETRO PORTA	2	PZ																										
VI1685A0	VITE NO TESTA EI M6X6 TESTA CONICA INOX	4	PZ																										
VM1790A0	BOCCOLA CERNIERA 12X6.5 DI5.3	2	PZ																										

COMPONENTE			RICAMBIO																										
Codice	Descrizione	Immagine	Codice	Descrizione	Lista componenti																								
GN1320A	GUARNIZIONE CERNIERA VETRO PORTA		KGN1320A	KIT 4 GUARNIZIONI CERNIERE VETRO PORTA	<table border="1"> <thead> <tr> <th>Codice</th> <th>Descrizione</th> <th>Qtà</th> <th>UM</th> </tr> </thead> <tbody> <tr> <td>GN1320A0</td> <td>GUARNIZIONE CERNIERA VETRO PORTA</td> <td>4</td> <td>PZ</td> </tr> </tbody> </table>	Codice	Descrizione	Qtà	UM	GN1320A0	GUARNIZIONE CERNIERA VETRO PORTA	4	PZ																
			Codice	Descrizione	Qtà	UM																							
GN1320A0	GUARNIZIONE CERNIERA VETRO PORTA	4	PZ																										
KCR1081A	KIT CERNIERA SX/INF CR1081A	<table border="1"> <thead> <tr> <th>Codice</th> <th>Descrizione</th> <th>Qtà</th> <th>UM</th> </tr> </thead> <tbody> <tr> <td>CR1081A0</td> <td>CERNIERA SX INOX XV-XL-X</td> <td>1</td> <td>PZ</td> </tr> <tr> <td>GN1320A0</td> <td>GUARNIZIONE CERNIERA VETRO PORTA</td> <td>1</td> <td>PZ</td> </tr> <tr> <td>VI1083A0</td> <td>VITE M6X6 TC1/2T INOX</td> <td>2</td> <td>PZ</td> </tr> <tr> <td>VM1790A0</td> <td>BOCCOLA CERNIERA 12X6.5 DI5.3</td> <td>1</td> <td>PZ</td> </tr> </tbody> </table>	Codice	Descrizione	Qtà	UM	CR1081A0	CERNIERA SX INOX XV-XL-X	1	PZ	GN1320A0	GUARNIZIONE CERNIERA VETRO PORTA	1	PZ	VI1083A0	VITE M6X6 TC1/2T INOX	2	PZ	VM1790A0	BOCCOLA CERNIERA 12X6.5 DI5.3	1	PZ							
Codice	Descrizione	Qtà	UM																										
CR1081A0	CERNIERA SX INOX XV-XL-X	1	PZ																										
GN1320A0	GUARNIZIONE CERNIERA VETRO PORTA	1	PZ																										
VI1083A0	VITE M6X6 TC1/2T INOX	2	PZ																										
VM1790A0	BOCCOLA CERNIERA 12X6.5 DI5.3	1	PZ																										
			KCR1080A	KIT CERNIERA DX/S	<table border="1"> <thead> <tr> <th>Codice</th> <th>Descrizione</th> <th>Qtà</th> <th>UM</th> </tr> </thead> <tbody> <tr> <td>CR1080A0</td> <td>CERNIERA DX INOX XV-XL-X</td> <td>1</td> <td>PZ</td> </tr> <tr> <td>CR1081A0</td> <td>CERNIERA SX INOX XV-XL-X</td> <td>1</td> <td>PZ</td> </tr> <tr> <td>GN1320A0</td> <td>GUARNIZIONE CERNIERA VETRO PORTA</td> <td>2</td> <td>PZ</td> </tr> <tr> <td>VI1685A0</td> <td>VITE NO TESTA EI M6X6 TESTA CONICA INOX</td> <td>4</td> <td>PZ</td> </tr> <tr> <td>VM1790A0</td> <td>BOCCOLA CERNIERA 12X6.5 DI5.3</td> <td>2</td> <td>PZ</td> </tr> </tbody> </table>	Codice	Descrizione	Qtà	UM	CR1080A0	CERNIERA DX INOX XV-XL-X	1	PZ	CR1081A0	CERNIERA SX INOX XV-XL-X	1	PZ	GN1320A0	GUARNIZIONE CERNIERA VETRO PORTA	2	PZ	VI1685A0	VITE NO TESTA EI M6X6 TESTA CONICA INOX	4	PZ	VM1790A0	BOCCOLA CERNIERA 12X6.5 DI5.3	2	PZ
Codice	Descrizione	Qtà	UM																										
CR1080A0	CERNIERA DX INOX XV-XL-X	1	PZ																										
CR1081A0	CERNIERA SX INOX XV-XL-X	1	PZ																										
GN1320A0	GUARNIZIONE CERNIERA VETRO PORTA	2	PZ																										
VI1685A0	VITE NO TESTA EI M6X6 TESTA CONICA INOX	4	PZ																										
VM1790A0	BOCCOLA CERNIERA 12X6.5 DI5.3	2	PZ																										
CR1080A	CERNIERA DX INOX XV-XL-XB		KCR1080A	KIT CERNIERA DX/S	<table border="1"> <thead> <tr> <th>Codice</th> <th>Descrizione</th> <th>Qtà</th> <th>UM</th> </tr> </thead> <tbody> <tr> <td>CR1080A0</td> <td>CERNIERA DX INOX XV-XL-X</td> <td>1</td> <td>PZ</td> </tr> <tr> <td>CR1081A0</td> <td>CERNIERA SX INOX XV-XL-X</td> <td>1</td> <td>PZ</td> </tr> <tr> <td>GN1320A0</td> <td>GUARNIZIONE CERNIERA VETRO PORTA</td> <td>2</td> <td>PZ</td> </tr> <tr> <td>VI1685A0</td> <td>VITE NO TESTA EI M6X6 TESTA CONICA INOX</td> <td>4</td> <td>PZ</td> </tr> <tr> <td>VM1790A0</td> <td>BOCCOLA CERNIERA 12X6.5 DI5.3</td> <td>2</td> <td>PZ</td> </tr> </tbody> </table>	Codice	Descrizione	Qtà	UM	CR1080A0	CERNIERA DX INOX XV-XL-X	1	PZ	CR1081A0	CERNIERA SX INOX XV-XL-X	1	PZ	GN1320A0	GUARNIZIONE CERNIERA VETRO PORTA	2	PZ	VI1685A0	VITE NO TESTA EI M6X6 TESTA CONICA INOX	4	PZ	VM1790A0	BOCCOLA CERNIERA 12X6.5 DI5.3	2	PZ
Codice	Descrizione	Qtà	UM																										
CR1080A0	CERNIERA DX INOX XV-XL-X	1	PZ																										
CR1081A0	CERNIERA SX INOX XV-XL-X	1	PZ																										
GN1320A0	GUARNIZIONE CERNIERA VETRO PORTA	2	PZ																										
VI1685A0	VITE NO TESTA EI M6X6 TESTA CONICA INOX	4	PZ																										
VM1790A0	BOCCOLA CERNIERA 12X6.5 DI5.3	2	PZ																										

COMPONENTE			RICAMBIO																										
Codice	Descrizione	Immagine	Codice	Descrizione	Lista componenti																								
GN1320A	GUARNIZIONE CERNIERA VETRO PORTA		KGN1320A	KIT 4 GUARNIZIONI CERNIERE VETRO PORTA	<table border="1"> <thead> <tr> <th>Codice</th> <th>Descrizione</th> <th>Qtà</th> <th>UM</th> </tr> </thead> <tbody> <tr> <td>GN1320A0</td> <td>GUARNIZIONE CERNIERA VETRO PORTA</td> <td>4</td> <td>PZ</td> </tr> </tbody> </table>	Codice	Descrizione	Qtà	UM	GN1320A0	GUARNIZIONE CERNIERA VETRO PORTA	4	PZ																
			Codice	Descrizione	Qtà	UM																							
GN1320A0	GUARNIZIONE CERNIERA VETRO PORTA	4	PZ																										
KCR1081A	KIT CERNIERA SX/INF CR1081A	<table border="1"> <thead> <tr> <th>Codice</th> <th>Descrizione</th> <th>Qtà</th> <th>UM</th> </tr> </thead> <tbody> <tr> <td>CR1081A0</td> <td>CERNIERA SX INOX XV-XL-X</td> <td>1</td> <td>PZ</td> </tr> <tr> <td>GN1320A0</td> <td>GUARNIZIONE CERNIERA VETRO PORTA</td> <td>1</td> <td>PZ</td> </tr> <tr> <td>VI1083A0</td> <td>VITE M6X6 TC1/2T INOX</td> <td>2</td> <td>PZ</td> </tr> <tr> <td>VM1790A0</td> <td>BOCCOLA CERNIERA 12X6.5 DI5.3</td> <td>1</td> <td>PZ</td> </tr> </tbody> </table>	Codice	Descrizione	Qtà	UM	CR1081A0	CERNIERA SX INOX XV-XL-X	1	PZ	GN1320A0	GUARNIZIONE CERNIERA VETRO PORTA	1	PZ	VI1083A0	VITE M6X6 TC1/2T INOX	2	PZ	VM1790A0	BOCCOLA CERNIERA 12X6.5 DI5.3	1	PZ							
Codice	Descrizione	Qtà	UM																										
CR1081A0	CERNIERA SX INOX XV-XL-X	1	PZ																										
GN1320A0	GUARNIZIONE CERNIERA VETRO PORTA	1	PZ																										
VI1083A0	VITE M6X6 TC1/2T INOX	2	PZ																										
VM1790A0	BOCCOLA CERNIERA 12X6.5 DI5.3	1	PZ																										
			KCR1080A	KIT CERNIERA DX/S	<table border="1"> <thead> <tr> <th>Codice</th> <th>Descrizione</th> <th>Qtà</th> <th>UM</th> </tr> </thead> <tbody> <tr> <td>CR1080A0</td> <td>CERNIERA DX INOX XV-XL-X</td> <td>1</td> <td>PZ</td> </tr> <tr> <td>CR1081A0</td> <td>CERNIERA SX INOX XV-XL-X</td> <td>1</td> <td>PZ</td> </tr> <tr> <td>GN1320A0</td> <td>GUARNIZIONE CERNIERA VETRO PORTA</td> <td>2</td> <td>PZ</td> </tr> <tr> <td>VI1685A0</td> <td>VITE NO TESTA EI M6X6 TESTA CONICA INOX</td> <td>4</td> <td>PZ</td> </tr> <tr> <td>VM1790A0</td> <td>BOCCOLA CERNIERA 12X6.5 DI5.3</td> <td>2</td> <td>PZ</td> </tr> </tbody> </table>	Codice	Descrizione	Qtà	UM	CR1080A0	CERNIERA DX INOX XV-XL-X	1	PZ	CR1081A0	CERNIERA SX INOX XV-XL-X	1	PZ	GN1320A0	GUARNIZIONE CERNIERA VETRO PORTA	2	PZ	VI1685A0	VITE NO TESTA EI M6X6 TESTA CONICA INOX	4	PZ	VM1790A0	BOCCOLA CERNIERA 12X6.5 DI5.3	2	PZ
Codice	Descrizione	Qtà	UM																										
CR1080A0	CERNIERA DX INOX XV-XL-X	1	PZ																										
CR1081A0	CERNIERA SX INOX XV-XL-X	1	PZ																										
GN1320A0	GUARNIZIONE CERNIERA VETRO PORTA	2	PZ																										
VI1685A0	VITE NO TESTA EI M6X6 TESTA CONICA INOX	4	PZ																										
VM1790A0	BOCCOLA CERNIERA 12X6.5 DI5.3	2	PZ																										
MG1015B	TERMINALE MANIGLIA L.MISS/L.MICRO/CH EFTO		KMG1015B	KIT 2 PZ.TERMINALE MANIGLIA	<table border="1"> <thead> <tr> <th>Codice</th> <th>Descrizione</th> <th>Qtà</th> <th>UM</th> </tr> </thead> <tbody> <tr> <td>MG1015B0</td> <td>TERMINALE MANIGLIA L.MISS/L.MICR O/CHEFTO</td> <td>2</td> <td>PZ</td> </tr> <tr> <td>VI1855A0</td> <td>VITE AUTOFIL. 5X25 TCB+</td> <td>2</td> <td>PZ</td> </tr> <tr> <td>VI1870A0</td> <td>VITE AUTOFIL. X PLASTICA 5X50 TCB+</td> <td>2</td> <td>PZ</td> </tr> <tr> <td>VM1025A0</td> <td>TAPPO NYLON PA66 V2 GRIGIO Ø16</td> <td>2</td> <td>PZ</td> </tr> </tbody> </table>	Codice	Descrizione	Qtà	UM	MG1015B0	TERMINALE MANIGLIA L.MISS/L.MICR O/CHEFTO	2	PZ	VI1855A0	VITE AUTOFIL. 5X25 TCB+	2	PZ	VI1870A0	VITE AUTOFIL. X PLASTICA 5X50 TCB+	2	PZ	VM1025A0	TAPPO NYLON PA66 V2 GRIGIO Ø16	2	PZ				
			Codice	Descrizione	Qtà	UM																							
			MG1015B0	TERMINALE MANIGLIA L.MISS/L.MICR O/CHEFTO	2	PZ																							
			VI1855A0	VITE AUTOFIL. 5X25 TCB+	2	PZ																							
VI1870A0	VITE AUTOFIL. X PLASTICA 5X50 TCB+	2	PZ																										
VM1025A0	TAPPO NYLON PA66 V2 GRIGIO Ø16	2	PZ																										

COMPONENTE			RICAMBIO																														
Codice	Descrizione	Immagine	Codice	Descrizione	Lista componenti																												
VM1720A	RONDELLA PORTA XL405		VM1720A0	RONDELLA PORTA XL405																													
TB1077A	TUBO MANIGLIA XLT135/XLT195 ̄18X		KTB1077A	KIT TUBO MANIGLIA XLT135/XLT195	<table border="1"> <thead> <tr> <th>Codice</th> <th>Descrizione</th> <th>Qtà</th> <th>UM</th> </tr> </thead> <tbody> <tr> <td>TB1077A0</td> <td>TUBO MANIGLIA XLT135/XLT195 ̄18X1</td> <td>1</td> <td>PZ</td> </tr> <tr> <td>VI1220A1</td> <td>VITE AUTOFILETTA NTE 4.2X11 TCS+ MARUTE</td> <td>4</td> <td>PZ</td> </tr> <tr> <td>VM1794A0</td> <td>FASCETTA 250X4.8 PA66 NERA</td> <td>2</td> <td>PZ</td> </tr> <tr> <td>VM2103A0</td> <td>PIASTRINA FERMAFASCE TTA</td> <td>2</td> <td>PZ</td> </tr> </tbody> </table>	Codice	Descrizione	Qtà	UM	TB1077A0	TUBO MANIGLIA XLT135/XLT195 ̄18X1	1	PZ	VI1220A1	VITE AUTOFILETTA NTE 4.2X11 TCS+ MARUTE	4	PZ	VM1794A0	FASCETTA 250X4.8 PA66 NERA	2	PZ	VM2103A0	PIASTRINA FERMAFASCE TTA	2	PZ								
Codice	Descrizione	Qtà	UM																														
TB1077A0	TUBO MANIGLIA XLT135/XLT195 ̄18X1	1	PZ																														
VI1220A1	VITE AUTOFILETTA NTE 4.2X11 TCS+ MARUTE	4	PZ																														
VM1794A0	FASCETTA 250X4.8 PA66 NERA	2	PZ																														
VM2103A0	PIASTRINA FERMAFASCE TTA	2	PZ																														
0H4540A	LAMIERA PER CALAMITA PORTA XL 405		0H4540A0	LAMIERA PER CALAMITA PORTA XL 405																													
GN1330A	GUARNIZIONE LAMIERINO FERRITICO XL405		KVT1086BR	XLT195/XLT193 PORTA COMPLETA DX VETRO	<table border="1"> <thead> <tr> <th>Codice</th> <th>Descrizione</th> <th>Qtà</th> <th>UM</th> </tr> </thead> <tbody> <tr> <td>0H4540A0</td> <td>LAMIERA PER CALAMITA PORTA XL 405</td> <td>1</td> <td>PZ</td> </tr> <tr> <td>CR1080A0</td> <td>CERNIERA DX INOX XV-XL-X</td> <td>1</td> <td>PZ</td> </tr> <tr> <td>CR1081A0</td> <td>CERNIERA SX INOX XV-XL-X</td> <td>1</td> <td>PZ</td> </tr> <tr> <td>GN1320A0</td> <td>GUARNIZIONE CERNIERA VETRO PORTA</td> <td>2</td> <td>PZ</td> </tr> <tr> <td>GN1330A0</td> <td>GUARNIZIONE LAMIERINO FERRITICO XL405</td> <td>1</td> <td>PZ</td> </tr> <tr> <td>MG1015B0</td> <td>TERMINALE MANIGLIA L.MISS/L.MICR O/CHEFTO</td> <td>2</td> <td>PZ</td> </tr> </tbody> </table>	Codice	Descrizione	Qtà	UM	0H4540A0	LAMIERA PER CALAMITA PORTA XL 405	1	PZ	CR1080A0	CERNIERA DX INOX XV-XL-X	1	PZ	CR1081A0	CERNIERA SX INOX XV-XL-X	1	PZ	GN1320A0	GUARNIZIONE CERNIERA VETRO PORTA	2	PZ	GN1330A0	GUARNIZIONE LAMIERINO FERRITICO XL405	1	PZ	MG1015B0	TERMINALE MANIGLIA L.MISS/L.MICR O/CHEFTO	2	PZ
Codice	Descrizione	Qtà	UM																														
0H4540A0	LAMIERA PER CALAMITA PORTA XL 405	1	PZ																														
CR1080A0	CERNIERA DX INOX XV-XL-X	1	PZ																														
CR1081A0	CERNIERA SX INOX XV-XL-X	1	PZ																														
GN1320A0	GUARNIZIONE CERNIERA VETRO PORTA	2	PZ																														
GN1330A0	GUARNIZIONE LAMIERINO FERRITICO XL405	1	PZ																														
MG1015B0	TERMINALE MANIGLIA L.MISS/L.MICR O/CHEFTO	2	PZ																														

COMPONENTE			RICAMBIO																																															
Codice	Descrizione	Immagine	Codice	Descrizione	Lista componenti																																													
GN1330A	GUARNIZIONE LAMIERINO FERRITICO XL405		KVT1086BR	XLT195/XLT193 PORTA COMPLETA DX VETRO	<table border="1"> <thead> <tr> <th>Codice</th> <th>Descrizione</th> <th>Qtà</th> <th>UM</th> </tr> </thead> <tbody> <tr> <td>TB1077A0</td> <td>TUBO MANIGLIA XLT135/XLT19 5 1/8X1</td> <td>1</td> <td>PZ</td> </tr> <tr> <td>VI1685A0</td> <td>VITE NO TESTA EI M6X6 TESTA CONICA INOX</td> <td>4</td> <td>PZ</td> </tr> <tr> <td>VI1930A0</td> <td>VITE 5X25 TRUCIOLARE INOX</td> <td>2</td> <td>PZ</td> </tr> <tr> <td>VM1720A0</td> <td>RONDELLA PORTA XL405</td> <td>1</td> <td>PZ</td> </tr> <tr> <td>VT1086B0</td> <td>VETRO PORTA 399X661 NERO XLT195/XLT19</td> <td>1</td> <td>PZ</td> </tr> </tbody> </table>	Codice	Descrizione	Qtà	UM	TB1077A0	TUBO MANIGLIA XLT135/XLT19 5 1/8X1	1	PZ	VI1685A0	VITE NO TESTA EI M6X6 TESTA CONICA INOX	4	PZ	VI1930A0	VITE 5X25 TRUCIOLARE INOX	2	PZ	VM1720A0	RONDELLA PORTA XL405	1	PZ	VT1086B0	VETRO PORTA 399X661 NERO XLT195/XLT19	1	PZ																					
			Codice	Descrizione	Qtà	UM																																												
TB1077A0	TUBO MANIGLIA XLT135/XLT19 5 1/8X1	1	PZ																																															
VI1685A0	VITE NO TESTA EI M6X6 TESTA CONICA INOX	4	PZ																																															
VI1930A0	VITE 5X25 TRUCIOLARE INOX	2	PZ																																															
VM1720A0	RONDELLA PORTA XL405	1	PZ																																															
VT1086B0	VETRO PORTA 399X661 NERO XLT195/XLT19	1	PZ																																															
KVT1086BL	XLT195/XLT193 PORTA COMPLETA SX VETRO	<table border="1"> <thead> <tr> <th>Codice</th> <th>Descrizione</th> <th>Qtà</th> <th>UM</th> </tr> </thead> <tbody> <tr> <td>0H4540A0</td> <td>LAMIERA PER CALAMITA PORTA XL 405</td> <td>1</td> <td>PZ</td> </tr> <tr> <td>CR1080A0</td> <td>CERNIERA DX INOX XV-XL-X</td> <td>1</td> <td>PZ</td> </tr> <tr> <td>CR1081A0</td> <td>CERNIERA SX INOX XV-XL-X</td> <td>1</td> <td>PZ</td> </tr> <tr> <td>GN1320A0</td> <td>GUARNIZIONE CERNIERA VETRO PORTA</td> <td>2</td> <td>PZ</td> </tr> <tr> <td>GN1330A0</td> <td>GUARNIZIONE LAMIERINO FERRITICO XL405</td> <td>1</td> <td>PZ</td> </tr> <tr> <td>MG1015B0</td> <td>TERMINALE MANIGLIA L.MISS/L.MICR O/CHEFTO</td> <td>2</td> <td>PZ</td> </tr> <tr> <td>TB1077A0</td> <td>TUBO MANIGLIA XLT135/XLT19 5 1/8X1</td> <td>1</td> <td>PZ</td> </tr> <tr> <td>VI1685A0</td> <td>VITE NO TESTA EI M6X6 TESTA CONICA INOX</td> <td>4</td> <td>PZ</td> </tr> <tr> <td>VI1930A0</td> <td>VITE 5X25 TRUCIOLARE INOX</td> <td>2</td> <td>PZ</td> </tr> <tr> <td>VM1720A0</td> <td>RONDELLA PORTA XL405</td> <td>1</td> <td>PZ</td> </tr> <tr> <td>VT1086B0</td> <td>VETRO PORTA 399X661 NERO XLT195/XLT19</td> <td>1</td> <td>PZ</td> </tr> </tbody> </table>	Codice	Descrizione	Qtà	UM	0H4540A0	LAMIERA PER CALAMITA PORTA XL 405	1	PZ	CR1080A0	CERNIERA DX INOX XV-XL-X	1	PZ	CR1081A0	CERNIERA SX INOX XV-XL-X	1	PZ	GN1320A0	GUARNIZIONE CERNIERA VETRO PORTA	2	PZ	GN1330A0	GUARNIZIONE LAMIERINO FERRITICO XL405	1	PZ	MG1015B0	TERMINALE MANIGLIA L.MISS/L.MICR O/CHEFTO	2	PZ	TB1077A0	TUBO MANIGLIA XLT135/XLT19 5 1/8X1	1	PZ	VI1685A0	VITE NO TESTA EI M6X6 TESTA CONICA INOX	4	PZ	VI1930A0	VITE 5X25 TRUCIOLARE INOX	2	PZ	VM1720A0	RONDELLA PORTA XL405	1	PZ	VT1086B0	VETRO PORTA 399X661 NERO XLT195/XLT19	1	PZ
Codice	Descrizione	Qtà	UM																																															
0H4540A0	LAMIERA PER CALAMITA PORTA XL 405	1	PZ																																															
CR1080A0	CERNIERA DX INOX XV-XL-X	1	PZ																																															
CR1081A0	CERNIERA SX INOX XV-XL-X	1	PZ																																															
GN1320A0	GUARNIZIONE CERNIERA VETRO PORTA	2	PZ																																															
GN1330A0	GUARNIZIONE LAMIERINO FERRITICO XL405	1	PZ																																															
MG1015B0	TERMINALE MANIGLIA L.MISS/L.MICR O/CHEFTO	2	PZ																																															
TB1077A0	TUBO MANIGLIA XLT135/XLT19 5 1/8X1	1	PZ																																															
VI1685A0	VITE NO TESTA EI M6X6 TESTA CONICA INOX	4	PZ																																															
VI1930A0	VITE 5X25 TRUCIOLARE INOX	2	PZ																																															
VM1720A0	RONDELLA PORTA XL405	1	PZ																																															
VT1086B0	VETRO PORTA 399X661 NERO XLT195/XLT19	1	PZ																																															

COMPONENTE			RICAMBIO																																																																																	
Codice	Descrizione	Immagine	Codice	Descrizione	Lista componenti																																																																															
GN1330A	GUARNIZIONE LAMIERINO FERRITICO XL405		KVT1076BR	XLT135/XLT133 PORTA COMPLETA DX VETRO	<table border="1"> <thead> <tr> <th>Codice</th> <th>Descrizione</th> <th>Qtà</th> <th>UM</th> </tr> </thead> <tbody> <tr> <td>0H4540A0</td> <td>LAMIERA PER CALAMITA PORTA XL 405</td> <td>1</td> <td>PZ</td> </tr> <tr> <td>CR1080A0</td> <td>CERNIERA DX INOX XV-XL-X</td> <td>1</td> <td>PZ</td> </tr> <tr> <td>CR1081A0</td> <td>CERNIERA SX INOX XV-XL-X</td> <td>1</td> <td>PZ</td> </tr> <tr> <td>GN1320A0</td> <td>GUARNIZIONE CERNIERA VETRO PORTA</td> <td>2</td> <td>PZ</td> </tr> <tr> <td>GN1330A0</td> <td>GUARNIZIONE LAMIERINO FERRITICO XL405</td> <td>1</td> <td>PZ</td> </tr> <tr> <td>IP1385A1</td> <td>IMB POL ANGOLARE 110X80X2000 D30</td> <td>1.400</td> <td>M</td> </tr> <tr> <td>IP1508A0</td> <td>POLISTIROLO PROFILO AD U 2000X60X60</td> <td>0.300</td> <td>PZ</td> </tr> <tr> <td>IP1508A1</td> <td>POLISTIROLO PROFILO AD U 2000X60X60</td> <td>2</td> <td>M</td> </tr> <tr> <td>MG1015B0</td> <td>TERMINALE MANIGLIA L.MISS/L.MICR O/CHEFTO</td> <td>2</td> <td>PZ</td> </tr> <tr> <td>TB1077A0</td> <td>TUBO MANIGLIA XLT135/XLT19 5 Ì18X1</td> <td>1</td> <td>PZ</td> </tr> <tr> <td>VI1685A0</td> <td>VITE NO TESTA EI M6X6 TESTA CONICA INOX</td> <td>4</td> <td>PZ</td> </tr> <tr> <td>VI1930A0</td> <td>VITE 5X25 TRUCIOLARE INOX</td> <td>2</td> <td>PZ</td> </tr> <tr> <td>VM1059A1</td> <td>FILM TERMORETRA IBILE H800</td> <td>1.500</td> <td>M</td> </tr> <tr> <td>VM1720A0</td> <td>RONDELLA PORTA XL405</td> <td>1</td> <td>PZ</td> </tr> <tr> <td>VT1076B0</td> <td>VETRO PORTA 299X661 NERO XLT135/XLT13</td> <td>1</td> <td>PZ</td> </tr> </tbody> </table>	Codice	Descrizione	Qtà	UM	0H4540A0	LAMIERA PER CALAMITA PORTA XL 405	1	PZ	CR1080A0	CERNIERA DX INOX XV-XL-X	1	PZ	CR1081A0	CERNIERA SX INOX XV-XL-X	1	PZ	GN1320A0	GUARNIZIONE CERNIERA VETRO PORTA	2	PZ	GN1330A0	GUARNIZIONE LAMIERINO FERRITICO XL405	1	PZ	IP1385A1	IMB POL ANGOLARE 110X80X2000 D30	1.400	M	IP1508A0	POLISTIROLO PROFILO AD U 2000X60X60	0.300	PZ	IP1508A1	POLISTIROLO PROFILO AD U 2000X60X60	2	M	MG1015B0	TERMINALE MANIGLIA L.MISS/L.MICR O/CHEFTO	2	PZ	TB1077A0	TUBO MANIGLIA XLT135/XLT19 5 Ì18X1	1	PZ	VI1685A0	VITE NO TESTA EI M6X6 TESTA CONICA INOX	4	PZ	VI1930A0	VITE 5X25 TRUCIOLARE INOX	2	PZ	VM1059A1	FILM TERMORETRA IBILE H800	1.500	M	VM1720A0	RONDELLA PORTA XL405	1	PZ	VT1076B0	VETRO PORTA 299X661 NERO XLT135/XLT13	1	PZ	KVT1076BL	XLT135/XLT133 PORTA COMPLETA SX VETRO	<table border="1"> <thead> <tr> <th>Codice</th> <th>Descrizione</th> <th>Qtà</th> <th>UM</th> </tr> </thead> <tbody> <tr> <td>0H4540A0</td> <td>LAMIERA PER CALAMITA PORTA XL 405</td> <td>1</td> <td>PZ</td> </tr> <tr> <td>CR1080A0</td> <td>CERNIERA DX INOX XV-XL-X</td> <td>1</td> <td>PZ</td> </tr> </tbody> </table>	Codice	Descrizione	Qtà	UM	0H4540A0	LAMIERA PER CALAMITA PORTA XL 405	1	PZ	CR1080A0	CERNIERA DX INOX XV-XL-X	1	PZ
			Codice	Descrizione	Qtà	UM																																																																														
0H4540A0	LAMIERA PER CALAMITA PORTA XL 405	1	PZ																																																																																	
CR1080A0	CERNIERA DX INOX XV-XL-X	1	PZ																																																																																	
CR1081A0	CERNIERA SX INOX XV-XL-X	1	PZ																																																																																	
GN1320A0	GUARNIZIONE CERNIERA VETRO PORTA	2	PZ																																																																																	
GN1330A0	GUARNIZIONE LAMIERINO FERRITICO XL405	1	PZ																																																																																	
IP1385A1	IMB POL ANGOLARE 110X80X2000 D30	1.400	M																																																																																	
IP1508A0	POLISTIROLO PROFILO AD U 2000X60X60	0.300	PZ																																																																																	
IP1508A1	POLISTIROLO PROFILO AD U 2000X60X60	2	M																																																																																	
MG1015B0	TERMINALE MANIGLIA L.MISS/L.MICR O/CHEFTO	2	PZ																																																																																	
TB1077A0	TUBO MANIGLIA XLT135/XLT19 5 Ì18X1	1	PZ																																																																																	
VI1685A0	VITE NO TESTA EI M6X6 TESTA CONICA INOX	4	PZ																																																																																	
VI1930A0	VITE 5X25 TRUCIOLARE INOX	2	PZ																																																																																	
VM1059A1	FILM TERMORETRA IBILE H800	1.500	M																																																																																	
VM1720A0	RONDELLA PORTA XL405	1	PZ																																																																																	
VT1076B0	VETRO PORTA 299X661 NERO XLT135/XLT13	1	PZ																																																																																	
Codice	Descrizione	Qtà	UM																																																																																	
0H4540A0	LAMIERA PER CALAMITA PORTA XL 405	1	PZ																																																																																	
CR1080A0	CERNIERA DX INOX XV-XL-X	1	PZ																																																																																	

COMPONENTE			RICAMBIO																																										
Codice	Descrizione	Immagine	Codice	Descrizione	Lista componenti																																								
GN1330A	GUARNIZIONE LAMIERINO FERRITICO XL405		KVT1076BL	XLT135/XLT133 PORTA COMPLETA SX VETRO	<table border="1"> <thead> <tr> <th>Codice</th> <th>Descrizione</th> <th>Qtà</th> <th>UM</th> </tr> </thead> <tbody> <tr> <td>CR1081A0</td> <td>CERNIERA SX INOX XV-XL-X</td> <td>1</td> <td>PZ</td> </tr> <tr> <td>GN1320A0</td> <td>GUARNIZIONE CERNIERA VETRO PORTA</td> <td>2</td> <td>PZ</td> </tr> <tr> <td>GN1330A0</td> <td>GUARNIZIONE LAMIERINO FERRITICO XL405</td> <td>1</td> <td>PZ</td> </tr> <tr> <td>MG1015B0</td> <td>TERMINALE MANIGLIA L.MISS/L.MICR O/CHEFTO</td> <td>2</td> <td>PZ</td> </tr> <tr> <td>TB1077A0</td> <td>TUBO MANIGLIA XLT135/XLT19 5 118X1</td> <td>1</td> <td>PZ</td> </tr> <tr> <td>VI1685A0</td> <td>VITE NO TESTA EI M6X6 TESTA CONICA INOX</td> <td>4</td> <td>PZ</td> </tr> <tr> <td>VI1930A0</td> <td>VITE 5X25 TRUCIOLARE INOX</td> <td>2</td> <td>PZ</td> </tr> <tr> <td>VM1720A0</td> <td>RONDELLA PORTA XL405</td> <td>1</td> <td>PZ</td> </tr> <tr> <td>VT1076B0</td> <td>VETRO PORTA 299X661 NERO XLT135/XLT13</td> <td>1</td> <td>PZ</td> </tr> </tbody> </table>	Codice	Descrizione	Qtà	UM	CR1081A0	CERNIERA SX INOX XV-XL-X	1	PZ	GN1320A0	GUARNIZIONE CERNIERA VETRO PORTA	2	PZ	GN1330A0	GUARNIZIONE LAMIERINO FERRITICO XL405	1	PZ	MG1015B0	TERMINALE MANIGLIA L.MISS/L.MICR O/CHEFTO	2	PZ	TB1077A0	TUBO MANIGLIA XLT135/XLT19 5 118X1	1	PZ	VI1685A0	VITE NO TESTA EI M6X6 TESTA CONICA INOX	4	PZ	VI1930A0	VITE 5X25 TRUCIOLARE INOX	2	PZ	VM1720A0	RONDELLA PORTA XL405	1	PZ	VT1076B0	VETRO PORTA 299X661 NERO XLT135/XLT13	1	PZ
			Codice	Descrizione	Qtà	UM																																							
CR1081A0	CERNIERA SX INOX XV-XL-X	1	PZ																																										
GN1320A0	GUARNIZIONE CERNIERA VETRO PORTA	2	PZ																																										
GN1330A0	GUARNIZIONE LAMIERINO FERRITICO XL405	1	PZ																																										
MG1015B0	TERMINALE MANIGLIA L.MISS/L.MICR O/CHEFTO	2	PZ																																										
TB1077A0	TUBO MANIGLIA XLT135/XLT19 5 118X1	1	PZ																																										
VI1685A0	VITE NO TESTA EI M6X6 TESTA CONICA INOX	4	PZ																																										
VI1930A0	VITE 5X25 TRUCIOLARE INOX	2	PZ																																										
VM1720A0	RONDELLA PORTA XL405	1	PZ																																										
VT1076B0	VETRO PORTA 299X661 NERO XLT135/XLT13	1	PZ																																										
KDR1210AR	PORTA COMPLETA XL405 RIGHT	<table border="1"> <thead> <tr> <th>Codice</th> <th>Descrizione</th> <th>Qtà</th> <th>UM</th> </tr> </thead> <tbody> <tr> <td>0H4530C0</td> <td>SGOCCIOLAT OIO PORTA DX XL415</td> <td>1</td> <td>PZ</td> </tr> <tr> <td>0H4540A0</td> <td>LAMIERA PER CALAMITA PORTA XL 405</td> <td>1</td> <td>PZ</td> </tr> <tr> <td>CR1080A0</td> <td>CERNIERA DX INOX XV-XL-X</td> <td>1</td> <td>PZ</td> </tr> <tr> <td>CR1081A0</td> <td>CERNIERA SX INOX XV-XL-X</td> <td>1</td> <td>PZ</td> </tr> <tr> <td>GN1320A0</td> <td>GUARNIZIONE CERNIERA VETRO PORTA</td> <td>2</td> <td>PZ</td> </tr> <tr> <td>GN1330A0</td> <td>GUARNIZIONE LAMIERINO FERRITICO XL405</td> <td>1</td> <td>PZ</td> </tr> <tr> <td>IP1385A1</td> <td>IMB POL ANGOLARE 110X80X2000 D30</td> <td>1.300</td> <td>M</td> </tr> <tr> <td>IP1508A0</td> <td>POLISTIROLO PROFILO AD U 2000X60X60</td> <td>0.570</td> <td>PZ</td> </tr> </tbody> </table>	Codice	Descrizione	Qtà	UM	0H4530C0	SGOCCIOLAT OIO PORTA DX XL415	1	PZ	0H4540A0	LAMIERA PER CALAMITA PORTA XL 405	1	PZ	CR1080A0	CERNIERA DX INOX XV-XL-X	1	PZ	CR1081A0	CERNIERA SX INOX XV-XL-X	1	PZ	GN1320A0	GUARNIZIONE CERNIERA VETRO PORTA	2	PZ	GN1330A0	GUARNIZIONE LAMIERINO FERRITICO XL405	1	PZ	IP1385A1	IMB POL ANGOLARE 110X80X2000 D30	1.300	M	IP1508A0	POLISTIROLO PROFILO AD U 2000X60X60	0.570	PZ							
Codice	Descrizione	Qtà	UM																																										
0H4530C0	SGOCCIOLAT OIO PORTA DX XL415	1	PZ																																										
0H4540A0	LAMIERA PER CALAMITA PORTA XL 405	1	PZ																																										
CR1080A0	CERNIERA DX INOX XV-XL-X	1	PZ																																										
CR1081A0	CERNIERA SX INOX XV-XL-X	1	PZ																																										
GN1320A0	GUARNIZIONE CERNIERA VETRO PORTA	2	PZ																																										
GN1330A0	GUARNIZIONE LAMIERINO FERRITICO XL405	1	PZ																																										
IP1385A1	IMB POL ANGOLARE 110X80X2000 D30	1.300	M																																										
IP1508A0	POLISTIROLO PROFILO AD U 2000X60X60	0.570	PZ																																										

COMPONENTE			RICAMBIO																																										
Codice	Descrizione	Immagine	Codice	Descrizione	Lista componenti																																								
GN1330A	GUARNIZIONE LAMIERINO FERRITICO XL405		KDR1210AR	PORTA COMPLETA XL405 RIGHT	<table border="1"> <thead> <tr> <th>Codice</th> <th>Descrizione</th> <th>Qtà</th> <th>UM</th> </tr> </thead> <tbody> <tr> <td>IP1508A1</td> <td>POLISTIROLO PROFILO AD U 2000X60X60</td> <td>2</td> <td>M</td> </tr> <tr> <td>MG1015B0</td> <td>TERMINALE MANIGLIA L.MISS/L.MICR O/CHEFTO</td> <td>2</td> <td>PZ</td> </tr> <tr> <td>TB1730A0</td> <td>TUBO MANIGLIA XL405 Ø18X1</td> <td>1</td> <td>PZ</td> </tr> <tr> <td>VI1685A0</td> <td>VITE NO TESTA EI M6X6 TESTA CONICA INOX</td> <td>4</td> <td>PZ</td> </tr> <tr> <td>VI1930A0</td> <td>VITE 5X25 TRUCIOLARE INOX</td> <td>2</td> <td>PZ</td> </tr> <tr> <td>VM1059A1</td> <td>FILM TERMORETRA IBILE H800</td> <td>1.300</td> <td>M</td> </tr> <tr> <td>VM1720A0</td> <td>RONDELLA PORTA XL405</td> <td>1</td> <td>PZ</td> </tr> <tr> <td>VM1790A0</td> <td>BOCCOLA CERNIERA 12X6.5 DI5.3</td> <td>2</td> <td>PZ</td> </tr> <tr> <td>VT1210A0</td> <td>VETRO PORTA XL405</td> <td>1</td> <td>PZ</td> </tr> </tbody> </table>	Codice	Descrizione	Qtà	UM	IP1508A1	POLISTIROLO PROFILO AD U 2000X60X60	2	M	MG1015B0	TERMINALE MANIGLIA L.MISS/L.MICR O/CHEFTO	2	PZ	TB1730A0	TUBO MANIGLIA XL405 Ø18X1	1	PZ	VI1685A0	VITE NO TESTA EI M6X6 TESTA CONICA INOX	4	PZ	VI1930A0	VITE 5X25 TRUCIOLARE INOX	2	PZ	VM1059A1	FILM TERMORETRA IBILE H800	1.300	M	VM1720A0	RONDELLA PORTA XL405	1	PZ	VM1790A0	BOCCOLA CERNIERA 12X6.5 DI5.3	2	PZ	VT1210A0	VETRO PORTA XL405	1	PZ
			Codice	Descrizione	Qtà	UM																																							
IP1508A1	POLISTIROLO PROFILO AD U 2000X60X60	2	M																																										
MG1015B0	TERMINALE MANIGLIA L.MISS/L.MICR O/CHEFTO	2	PZ																																										
TB1730A0	TUBO MANIGLIA XL405 Ø18X1	1	PZ																																										
VI1685A0	VITE NO TESTA EI M6X6 TESTA CONICA INOX	4	PZ																																										
VI1930A0	VITE 5X25 TRUCIOLARE INOX	2	PZ																																										
VM1059A1	FILM TERMORETRA IBILE H800	1.300	M																																										
VM1720A0	RONDELLA PORTA XL405	1	PZ																																										
VM1790A0	BOCCOLA CERNIERA 12X6.5 DI5.3	2	PZ																																										
VT1210A0	VETRO PORTA XL405	1	PZ																																										
KDR1210AL	PORTA COMPLETA XL405 LEFT	<table border="1"> <thead> <tr> <th>Codice</th> <th>Descrizione</th> <th>Qtà</th> <th>UM</th> </tr> </thead> <tbody> <tr> <td>0H4535C0</td> <td>SGOCCIOLAT OIO PORTA SX XL415</td> <td>1</td> <td>PZ</td> </tr> <tr> <td>0H4540A0</td> <td>LAMIERA PER CALAMITA PORTA XL 405</td> <td>1</td> <td>PZ</td> </tr> <tr> <td>CR1080A0</td> <td>CERNIERA DX INOX XV-XL-X</td> <td>1</td> <td>PZ</td> </tr> <tr> <td>CR1081A0</td> <td>CERNIERA SX INOX XV-XL-X</td> <td>1</td> <td>PZ</td> </tr> <tr> <td>GN1320A0</td> <td>GUARNIZIONE CERNIERA VETRO PORTA</td> <td>2</td> <td>PZ</td> </tr> <tr> <td>GN1330A0</td> <td>GUARNIZIONE LAMIERINO FERRITICO XL405</td> <td>1</td> <td>PZ</td> </tr> <tr> <td>IP1385A1</td> <td>IMB POL ANGOLARE 110X80X2000 D30</td> <td>1.300</td> <td>M</td> </tr> <tr> <td>IP1508A0</td> <td>POLISTIROLO PROFILO AD U 2000X60X60</td> <td>0.570</td> <td>PZ</td> </tr> </tbody> </table>	Codice	Descrizione	Qtà	UM	0H4535C0	SGOCCIOLAT OIO PORTA SX XL415	1	PZ	0H4540A0	LAMIERA PER CALAMITA PORTA XL 405	1	PZ	CR1080A0	CERNIERA DX INOX XV-XL-X	1	PZ	CR1081A0	CERNIERA SX INOX XV-XL-X	1	PZ	GN1320A0	GUARNIZIONE CERNIERA VETRO PORTA	2	PZ	GN1330A0	GUARNIZIONE LAMIERINO FERRITICO XL405	1	PZ	IP1385A1	IMB POL ANGOLARE 110X80X2000 D30	1.300	M	IP1508A0	POLISTIROLO PROFILO AD U 2000X60X60	0.570	PZ							
Codice	Descrizione	Qtà	UM																																										
0H4535C0	SGOCCIOLAT OIO PORTA SX XL415	1	PZ																																										
0H4540A0	LAMIERA PER CALAMITA PORTA XL 405	1	PZ																																										
CR1080A0	CERNIERA DX INOX XV-XL-X	1	PZ																																										
CR1081A0	CERNIERA SX INOX XV-XL-X	1	PZ																																										
GN1320A0	GUARNIZIONE CERNIERA VETRO PORTA	2	PZ																																										
GN1330A0	GUARNIZIONE LAMIERINO FERRITICO XL405	1	PZ																																										
IP1385A1	IMB POL ANGOLARE 110X80X2000 D30	1.300	M																																										
IP1508A0	POLISTIROLO PROFILO AD U 2000X60X60	0.570	PZ																																										

COMPONENTE			RICAMBIO																																										
Codice	Descrizione	Immagine	Codice	Descrizione	Lista componenti																																								
GN1330A	GUARNIZIONE LAMIERINO FERRITICO XL405		KDR1210AL	PORTA COMPLETA XL405 LEFT	<table border="1"> <thead> <tr> <th>Codice</th> <th>Descrizione</th> <th>Qtà</th> <th>UM</th> </tr> </thead> <tbody> <tr> <td>IP1508A1</td> <td>POLISTIROLO PROFILO AD U 2000X60X60</td> <td>2</td> <td>M</td> </tr> <tr> <td>MG1015B0</td> <td>TERMINALE MANIGLIA L.MISS/L.MICR O/CHEFTO</td> <td>2</td> <td>PZ</td> </tr> <tr> <td>TB1730A0</td> <td>TUBO MANIGLIA XL405 Ø18X1</td> <td>1</td> <td>PZ</td> </tr> <tr> <td>VI1685A0</td> <td>VITE NO TESTA EI M6X6 TESTA CONICA INOX</td> <td>4</td> <td>PZ</td> </tr> <tr> <td>VI1930A0</td> <td>VITE 5X25 TRUCIOLARE INOX</td> <td>2</td> <td>PZ</td> </tr> <tr> <td>VM1059A1</td> <td>FILM TERMORETRA IBILE H800</td> <td>1.300</td> <td>M</td> </tr> <tr> <td>VM1720A0</td> <td>RONDELLA PORTA XL405</td> <td>1</td> <td>PZ</td> </tr> <tr> <td>VM1790A0</td> <td>BOCCOLA CERNIERA 12X6.5 DI5.3</td> <td>2</td> <td>PZ</td> </tr> <tr> <td>VT1210A0</td> <td>VETRO PORTA XL405</td> <td>1</td> <td>PZ</td> </tr> </tbody> </table>	Codice	Descrizione	Qtà	UM	IP1508A1	POLISTIROLO PROFILO AD U 2000X60X60	2	M	MG1015B0	TERMINALE MANIGLIA L.MISS/L.MICR O/CHEFTO	2	PZ	TB1730A0	TUBO MANIGLIA XL405 Ø18X1	1	PZ	VI1685A0	VITE NO TESTA EI M6X6 TESTA CONICA INOX	4	PZ	VI1930A0	VITE 5X25 TRUCIOLARE INOX	2	PZ	VM1059A1	FILM TERMORETRA IBILE H800	1.300	M	VM1720A0	RONDELLA PORTA XL405	1	PZ	VM1790A0	BOCCOLA CERNIERA 12X6.5 DI5.3	2	PZ	VT1210A0	VETRO PORTA XL405	1	PZ
Codice	Descrizione	Qtà	UM																																										
IP1508A1	POLISTIROLO PROFILO AD U 2000X60X60	2	M																																										
MG1015B0	TERMINALE MANIGLIA L.MISS/L.MICR O/CHEFTO	2	PZ																																										
TB1730A0	TUBO MANIGLIA XL405 Ø18X1	1	PZ																																										
VI1685A0	VITE NO TESTA EI M6X6 TESTA CONICA INOX	4	PZ																																										
VI1930A0	VITE 5X25 TRUCIOLARE INOX	2	PZ																																										
VM1059A1	FILM TERMORETRA IBILE H800	1.300	M																																										
VM1720A0	RONDELLA PORTA XL405	1	PZ																																										
VM1790A0	BOCCOLA CERNIERA 12X6.5 DI5.3	2	PZ																																										
VT1210A0	VETRO PORTA XL405	1	PZ																																										
VT1086B	VETRO PORTA 399X661 NERO XLT195/XLT193		KVT1086BR	XLT195/XLT193 PORTA COMPLETA DX VETRO	<table border="1"> <thead> <tr> <th>Codice</th> <th>Descrizione</th> <th>Qtà</th> <th>UM</th> </tr> </thead> <tbody> <tr> <td>0H4540A0</td> <td>LAMIERA PER CALAMITA PORTA XL 405</td> <td>1</td> <td>PZ</td> </tr> <tr> <td>CR1080A0</td> <td>CERNIERA DX INOX XV-XL-X</td> <td>1</td> <td>PZ</td> </tr> <tr> <td>CR1081A0</td> <td>CERNIERA SX INOX XV-XL-X</td> <td>1</td> <td>PZ</td> </tr> <tr> <td>GN1320A0</td> <td>GUARNIZIONE CERNIERA VETRO PORTA</td> <td>2</td> <td>PZ</td> </tr> <tr> <td>GN1330A0</td> <td>GUARNIZIONE LAMIERINO FERRITICO XL405</td> <td>1</td> <td>PZ</td> </tr> <tr> <td>MG1015B0</td> <td>TERMINALE MANIGLIA L.MISS/L.MICR O/CHEFTO</td> <td>2</td> <td>PZ</td> </tr> <tr> <td>TB1077A0</td> <td>TUBO MANIGLIA XLT135/XLT19 5 118X1</td> <td>1</td> <td>PZ</td> </tr> <tr> <td>VI1685A0</td> <td>VITE NO TESTA EI M6X6 TESTA CONICA INOX</td> <td>4</td> <td>PZ</td> </tr> </tbody> </table>	Codice	Descrizione	Qtà	UM	0H4540A0	LAMIERA PER CALAMITA PORTA XL 405	1	PZ	CR1080A0	CERNIERA DX INOX XV-XL-X	1	PZ	CR1081A0	CERNIERA SX INOX XV-XL-X	1	PZ	GN1320A0	GUARNIZIONE CERNIERA VETRO PORTA	2	PZ	GN1330A0	GUARNIZIONE LAMIERINO FERRITICO XL405	1	PZ	MG1015B0	TERMINALE MANIGLIA L.MISS/L.MICR O/CHEFTO	2	PZ	TB1077A0	TUBO MANIGLIA XLT135/XLT19 5 118X1	1	PZ	VI1685A0	VITE NO TESTA EI M6X6 TESTA CONICA INOX	4	PZ				
Codice	Descrizione	Qtà	UM																																										
0H4540A0	LAMIERA PER CALAMITA PORTA XL 405	1	PZ																																										
CR1080A0	CERNIERA DX INOX XV-XL-X	1	PZ																																										
CR1081A0	CERNIERA SX INOX XV-XL-X	1	PZ																																										
GN1320A0	GUARNIZIONE CERNIERA VETRO PORTA	2	PZ																																										
GN1330A0	GUARNIZIONE LAMIERINO FERRITICO XL405	1	PZ																																										
MG1015B0	TERMINALE MANIGLIA L.MISS/L.MICR O/CHEFTO	2	PZ																																										
TB1077A0	TUBO MANIGLIA XLT135/XLT19 5 118X1	1	PZ																																										
VI1685A0	VITE NO TESTA EI M6X6 TESTA CONICA INOX	4	PZ																																										

COMPONENTE			RICAMBIO																																															
Codice	Descrizione	Immagine	Codice	Descrizione	Lista componenti																																													
VT1086B	VETRO PORTA 399X661 NERO XLT195/XLT193		KVT1086BR	XLT195/XLT193 PORTA COMPLETA DX VETRO	<table border="1"> <thead> <tr> <th>Codice</th> <th>Descrizione</th> <th>Qtà</th> <th>UM</th> </tr> </thead> <tbody> <tr> <td>VI1930A0</td> <td>VITE 5X25 TRUCIOLARE INOX</td> <td>2</td> <td>PZ</td> </tr> <tr> <td>VM1720A0</td> <td>RONDELLA PORTA XL405</td> <td>1</td> <td>PZ</td> </tr> <tr> <td>VT1086B0</td> <td>VETRO PORTA 399X661 NERO XLT195/XLT193</td> <td>1</td> <td>PZ</td> </tr> </tbody> </table>	Codice	Descrizione	Qtà	UM	VI1930A0	VITE 5X25 TRUCIOLARE INOX	2	PZ	VM1720A0	RONDELLA PORTA XL405	1	PZ	VT1086B0	VETRO PORTA 399X661 NERO XLT195/XLT193	1	PZ																													
			Codice	Descrizione	Qtà	UM																																												
VI1930A0	VITE 5X25 TRUCIOLARE INOX	2	PZ																																															
VM1720A0	RONDELLA PORTA XL405	1	PZ																																															
VT1086B0	VETRO PORTA 399X661 NERO XLT195/XLT193	1	PZ																																															
KVT1086BL	XLT195/XLT193 PORTA COMPLETA SX VETRO	<table border="1"> <thead> <tr> <th>Codice</th> <th>Descrizione</th> <th>Qtà</th> <th>UM</th> </tr> </thead> <tbody> <tr> <td>OH4540A0</td> <td>LAMIERA PER CALAMITA PORTA XL 405</td> <td>1</td> <td>PZ</td> </tr> <tr> <td>CR1080A0</td> <td>CERNIERA DX INOX XV-XL-X</td> <td>1</td> <td>PZ</td> </tr> <tr> <td>CR1081A0</td> <td>CERNIERA SX INOX XV-XL-X</td> <td>1</td> <td>PZ</td> </tr> <tr> <td>GN1320A0</td> <td>GUARNIZIONE CERNIERA VETRO PORTA</td> <td>2</td> <td>PZ</td> </tr> <tr> <td>GN1330A0</td> <td>GUARNIZIONE LAMIERINO FERRITICO XL405</td> <td>1</td> <td>PZ</td> </tr> <tr> <td>MG1015B0</td> <td>TERMINALE MANIGLIA L.MISS/L.MICR O/CHEFTO</td> <td>2</td> <td>PZ</td> </tr> <tr> <td>TB1077A0</td> <td>TUBO MANIGLIA XLT135/XLT19 5 Ì18X1</td> <td>1</td> <td>PZ</td> </tr> <tr> <td>VI1685A0</td> <td>VITE NO TESTA EI M6X6 TESTA CONICA INOX</td> <td>4</td> <td>PZ</td> </tr> <tr> <td>VI1930A0</td> <td>VITE 5X25 TRUCIOLARE INOX</td> <td>2</td> <td>PZ</td> </tr> <tr> <td>VM1720A0</td> <td>RONDELLA PORTA XL405</td> <td>1</td> <td>PZ</td> </tr> <tr> <td>VT1086B0</td> <td>VETRO PORTA 399X661 NERO XLT195/XLT193</td> <td>1</td> <td>PZ</td> </tr> </tbody> </table>	Codice	Descrizione	Qtà	UM	OH4540A0	LAMIERA PER CALAMITA PORTA XL 405	1	PZ	CR1080A0	CERNIERA DX INOX XV-XL-X	1	PZ	CR1081A0	CERNIERA SX INOX XV-XL-X	1	PZ	GN1320A0	GUARNIZIONE CERNIERA VETRO PORTA	2	PZ	GN1330A0	GUARNIZIONE LAMIERINO FERRITICO XL405	1	PZ	MG1015B0	TERMINALE MANIGLIA L.MISS/L.MICR O/CHEFTO	2	PZ	TB1077A0	TUBO MANIGLIA XLT135/XLT19 5 Ì18X1	1	PZ	VI1685A0	VITE NO TESTA EI M6X6 TESTA CONICA INOX	4	PZ	VI1930A0	VITE 5X25 TRUCIOLARE INOX	2	PZ	VM1720A0	RONDELLA PORTA XL405	1	PZ	VT1086B0	VETRO PORTA 399X661 NERO XLT195/XLT193	1	PZ
Codice	Descrizione	Qtà	UM																																															
OH4540A0	LAMIERA PER CALAMITA PORTA XL 405	1	PZ																																															
CR1080A0	CERNIERA DX INOX XV-XL-X	1	PZ																																															
CR1081A0	CERNIERA SX INOX XV-XL-X	1	PZ																																															
GN1320A0	GUARNIZIONE CERNIERA VETRO PORTA	2	PZ																																															
GN1330A0	GUARNIZIONE LAMIERINO FERRITICO XL405	1	PZ																																															
MG1015B0	TERMINALE MANIGLIA L.MISS/L.MICR O/CHEFTO	2	PZ																																															
TB1077A0	TUBO MANIGLIA XLT135/XLT19 5 Ì18X1	1	PZ																																															
VI1685A0	VITE NO TESTA EI M6X6 TESTA CONICA INOX	4	PZ																																															
VI1930A0	VITE 5X25 TRUCIOLARE INOX	2	PZ																																															
VM1720A0	RONDELLA PORTA XL405	1	PZ																																															
VT1086B0	VETRO PORTA 399X661 NERO XLT195/XLT193	1	PZ																																															

ASM1311A/0.D01 - Copertura esterna

FRONTE

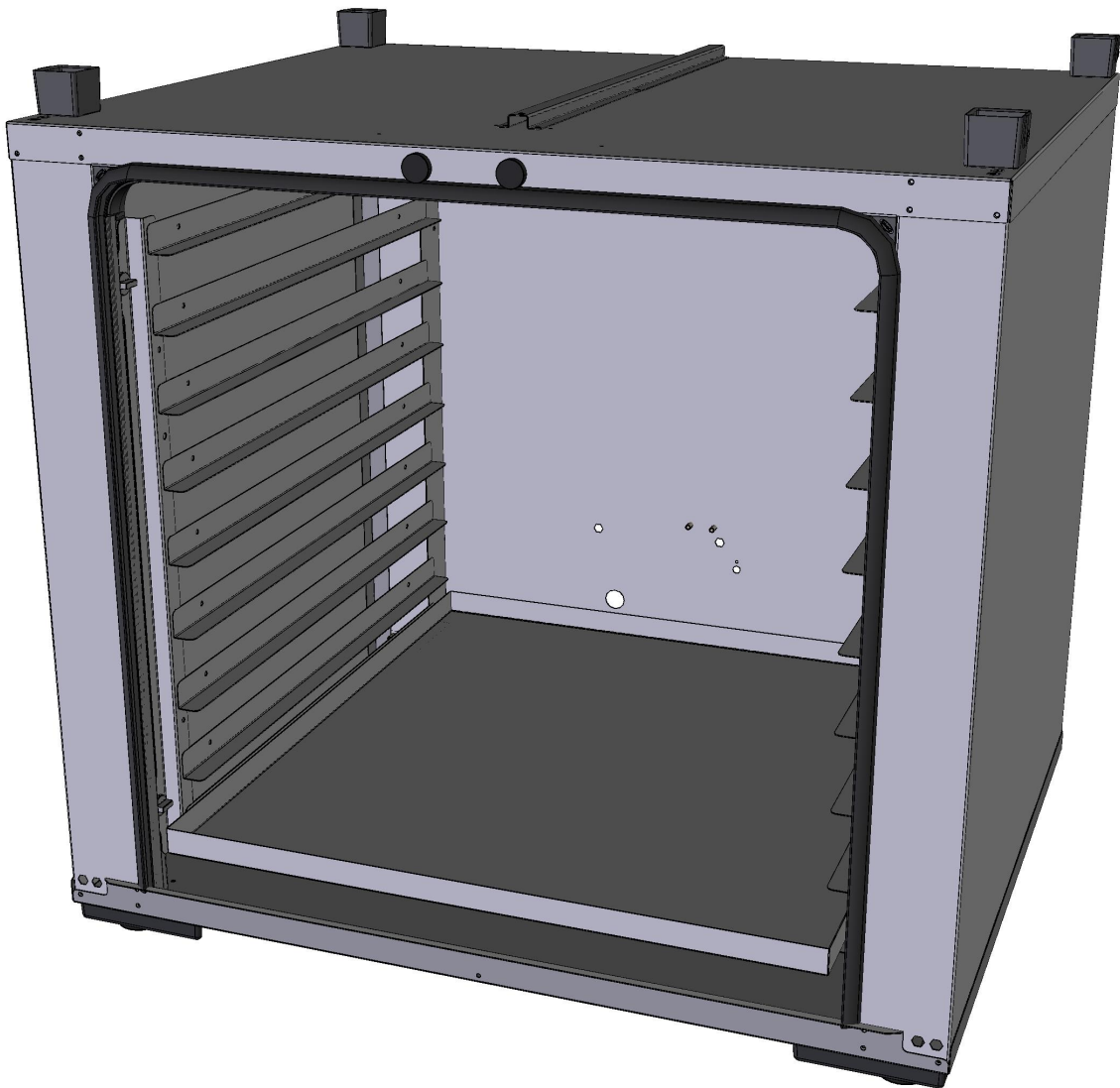





ASM1311A/0.D01 - Copertura esterna

RETRO



COMPONENTE			RICAMBIO														
Codice	Descrizione	Immagine	Codice	Descrizione	Lista componenti												
VM1750A	MORSETTO A PETTINE		KVM1750A	KIT MORSETTIERA A PETTINE	<table border="1"> <thead> <tr> <th>Codice</th> <th>Descrizione</th> <th>Qtà</th> <th>UM</th> </tr> </thead> <tbody> <tr> <td>VM1750A0</td> <td>MORSETTO A PETTINE</td> <td>1</td> <td>PZ</td> </tr> </tbody> </table>	Codice	Descrizione	Qtà	UM	VM1750A0	MORSETTO A PETTINE	1	PZ				
Codice	Descrizione	Qtà	UM														
VM1750A0	MORSETTO A PETTINE	1	PZ														
VM1820A	NOTTOLINO M6 CROMATO FISS. SUPPORTI		KVM1820A	KIT 10 NOTTOLINI S.	<table border="1"> <thead> <tr> <th>Codice</th> <th>Descrizione</th> <th>Qtà</th> <th>UM</th> </tr> </thead> <tbody> <tr> <td>VM1820A0</td> <td>NOTTOLINO M6 CROMATO FISS. SUPPORTI</td> <td>10</td> <td>PZ</td> </tr> </tbody> </table>	Codice	Descrizione	Qtà	UM	VM1820A0	NOTTOLINO M6 CROMATO FISS. SUPPORTI	10	PZ				
Codice	Descrizione	Qtà	UM														
VM1820A0	NOTTOLINO M6 CROMATO FISS. SUPPORTI	10	PZ														
VM1281A	STAFFA TRIANGOLARE PIEDINO-RUOTA																
VM1645A	ANGOLO GUARNIZIONE LIEVITATORE XL405																
VE1607A	VENTOSA MAGNETICA GOMMATA D22 H6 M6X14.5		KVE1607A	KIT VENTOSA MAGNETICA	<table border="1"> <thead> <tr> <th>Codice</th> <th>Descrizione</th> <th>Qtà</th> <th>UM</th> </tr> </thead> <tbody> <tr> <td>VE1607A1</td> <td>VENTOSA MAGNETICA GOMMATA D22 H6 M6X14.</td> <td>4</td> <td>PZ</td> </tr> <tr> <td>VI1700A0</td> <td>RONDELLA PIANA 18X6.4X1.5 INOX</td> <td>4</td> <td>PZ</td> </tr> </tbody> </table>	Codice	Descrizione	Qtà	UM	VE1607A1	VENTOSA MAGNETICA GOMMATA D22 H6 M6X14.	4	PZ	VI1700A0	RONDELLA PIANA 18X6.4X1.5 INOX	4	PZ
Codice	Descrizione	Qtà	UM														
VE1607A1	VENTOSA MAGNETICA GOMMATA D22 H6 M6X14.	4	PZ														
VI1700A0	RONDELLA PIANA 18X6.4X1.5 INOX	4	PZ														

COMPONENTE			RICAMBIO										
Codice	Descrizione	Immagine	Codice	Descrizione	Lista componenti								
PD1065A	PIEDINO D45 H20 M10X40		KPD1065A	KIT 4 PZ.PIEDINI D45 H20 M10X37	<table border="1"> <thead> <tr> <th>Codice</th> <th>Descrizione</th> <th>Qtà</th> <th>UM</th> </tr> </thead> <tbody> <tr> <td>PD1065A0</td> <td>PIEDINO D45 H20 M10X40</td> <td>4</td> <td>PZ</td> </tr> </tbody> </table>	Codice	Descrizione	Qtà	UM	PD1065A0	PIEDINO D45 H20 M10X40	4	PZ
Codice	Descrizione	Qtà	UM										
PD1065A0	PIEDINO D45 H20 M10X40	4	PZ										
0H1187A	COVER CABLAGGIO XLT193		0H1187A1	COVER CABLAGGIO XLT193									
0H1189A	PROFILO COPRI MICRO GIUNZIONI XLT195		0H1189A0	PROFILO COPRI MICRO GIUNZIONI XLT195									
0H1181A	PROFILO LAT.GUARNIZIONE XLT135/XLT133		0H1181A2	PROFILO LAT.GUARNIZIONE XLT135/XLT133									
GRL1324A	SUPPORTO LATERALE SX LIEVITATORE LM 80		GRL1324A0	SUPPORTO LATERALE SX LIEVITATORE LM 80									

COMPONENTE			RICAMBIO		
<i>Codice</i>	<i>Descrizione</i>	<i>Immagine</i>	<i>Codice</i>	<i>Descrizione</i>	<i>Lista componenti</i>
GRL1325A	SUPPORTO LATERALE DX LIEVITATORE LM 80		GRL1325A0	SUPPORTO LATERALE DX LIEVITATORE LM 80	
0E1004B	FONDO ESTERNO XLT195/XLT193		0E1004B0	FONDO ESTERNO XLT195/XLT193	
0D1034B	MANTELLO XLT195/XLT193		0D1034B0	MANTELLO XLT195/XLT193	
VM1029A	RIALZO PIEDINO SOVRAPPOSIZIONE LM		VM1029A0	RIALZO PIEDINO SOVRAPPOSIZIONE LM	
0H1188A	PROFILO SUP.GUARNIZIONE XLT195/XLT193		0H1188A2	PROFILO SUP.GUARNIZIONE XLT195/XLT193	

COMPONENTE			RICAMBIO										
Codice	Descrizione	Immagine	Codice	Descrizione	Lista componenti								
GN1521A	GUARNIZIONE PORTA XLT195/XLT193		KGN1521A	KIT GUARNIZIONE PORTA XLT193-XLT195	<table border="1"> <thead> <tr> <th>Codice</th> <th>Descrizione</th> <th>Qtà</th> <th>UM</th> </tr> </thead> <tbody> <tr> <td>GN1110A2</td> <td>GUARNIZIONE PORTA PROFILO 248</td> <td>1.830</td> <td>M</td> </tr> </tbody> </table>	Codice	Descrizione	Qtà	UM	GN1110A2	GUARNIZIONE PORTA PROFILO 248	1.830	M
			Codice	Descrizione	Qtà	UM							
GN1110A2	GUARNIZIONE PORTA PROFILO 248	1.830	M										
KGN0010A	KIT 2,5MT GUARNIZIONE PORTA GN1110A	<table border="1"> <thead> <tr> <th>Codice</th> <th>Descrizione</th> <th>Qtà</th> <th>UM</th> </tr> </thead> <tbody> <tr> <td>GN1110A2</td> <td>GUARNIZIONE PORTA PROFILO 248</td> <td>2.500</td> <td>M</td> </tr> </tbody> </table>	Codice	Descrizione	Qtà	UM	GN1110A2	GUARNIZIONE PORTA PROFILO 248	2.500	M			
Codice	Descrizione	Qtà	UM										
GN1110A2	GUARNIZIONE PORTA PROFILO 248	2.500	M										
0H1192A	VASCA UMIDITA' XLT195		0H1192A0	VASCA UMIDITA' XLT195									
0D1038A	COPERCHIO XLT193												