





Assembly code	Assembly description	Assembly image
ASM3401A/0.D04	Cooking chamber	
ASM3407A/0.D03	External cover	
ASM3419B/0.D01	Door	
ASM8225A/0.D00	Electrical system	



ASM3401A/0.D04 - Cooking chamber - FRONT

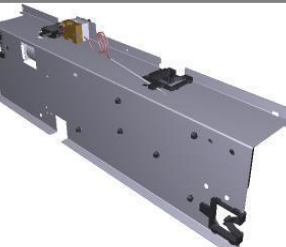
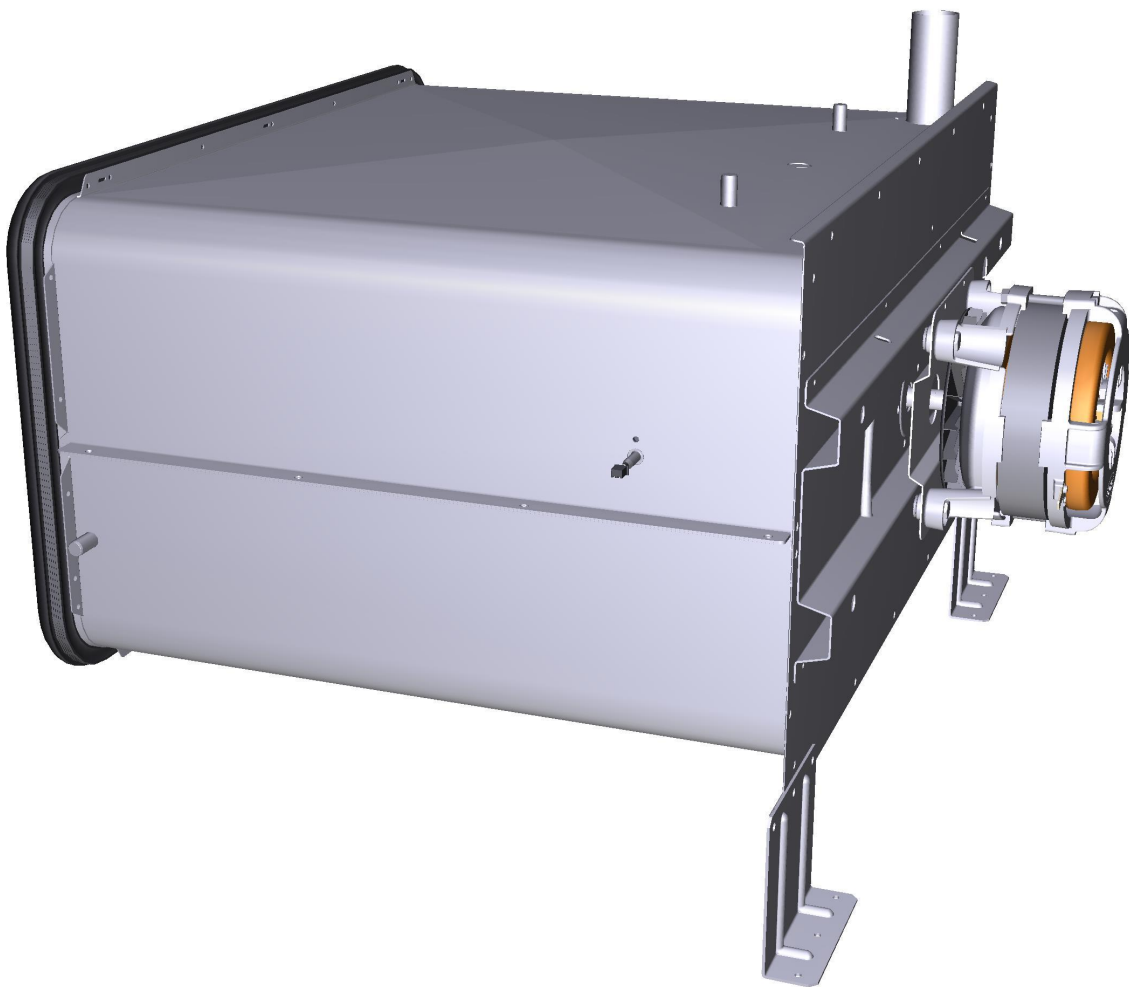





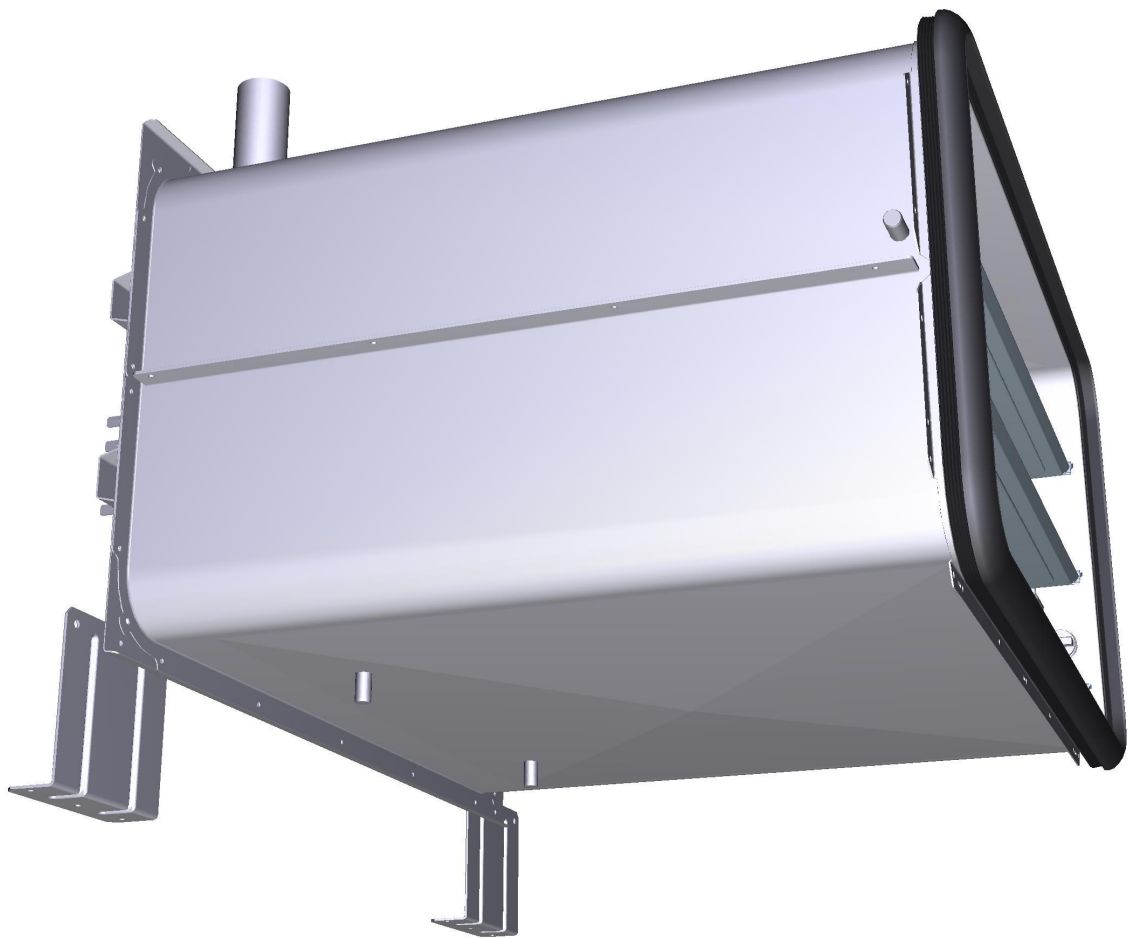





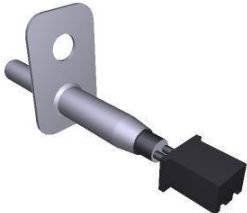

ASM3401A/0.D04 - Cooking chamber - REAR





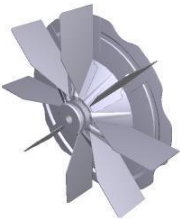

COMPONENT			SPARE PART																																										
Code	Description	Image	Code	Description	Kit components																																								
0G1671A	STEFANIA SHOP PRO GO FAN GUAR		0G1671A0	STEFANIA SHOP PRO GO FAN GUAR																																									
0H7875A	SHOP.PRO MUFFLE SUPPORT BRACKET		0H7875A1	SHOP.PRO MUFFLE SUPPORT BRACKET																																									
TR1105A	SONDA TEMPERATURA PT100 L1000		KTR1105A	PT100 L1000 TEMPERATURE PROBE KIT	<table border="1"> <thead> <tr> <th>Code</th> <th>Description</th> <th>Qty</th> <th>UOM</th> </tr> </thead> <tbody> <tr> <td>0H4302A0</td> <td>PIASTRINA SILICONE SONDE</td> <td>1.000</td> <td>PZ</td> </tr> <tr> <td>GN1120A1</td> <td>GUARNIZIONE SONDA TEMPERATUR A NTC LM</td> <td>1.000</td> <td>PZ</td> </tr> <tr> <td>GN1285A0</td> <td>GUARNIZIONE SONDA DI TEMPERATUR A NTC</td> <td>1.000</td> <td>PZ</td> </tr> <tr> <td>SL1045A0</td> <td>SILICONE ANTRACITE S57 80 ml</td> <td>1.000</td> <td>PZ</td> </tr> <tr> <td>TR1105A4</td> <td>SONDA TEMPERATUR A PT100 L1000</td> <td>1.000</td> <td>PZ</td> </tr> <tr> <td>VI1220A1</td> <td>VITE AUTOFIL. 4.2X11 TCS+ MARUTEX</td> <td>2.000</td> <td>PZ</td> </tr> <tr> <td>VM1464A1</td> <td>COPERCHIO SONDA TEMPERATUR A CT BT CON PA</td> <td>1.000</td> <td>PZ</td> </tr> <tr> <td>VM1465A1</td> <td>COPERCHIO SONDA TEMPERATUR A CT BT</td> <td>1.000</td> <td>PZ</td> </tr> <tr> <td>VM2052A0</td> <td>COPERCHIO SONDA TEMPERATUR A LM</td> <td>1.000</td> <td>PZ</td> </tr> </tbody> </table>	Code	Description	Qty	UOM	0H4302A0	PIASTRINA SILICONE SONDE	1.000	PZ	GN1120A1	GUARNIZIONE SONDA TEMPERATUR A NTC LM	1.000	PZ	GN1285A0	GUARNIZIONE SONDA DI TEMPERATUR A NTC	1.000	PZ	SL1045A0	SILICONE ANTRACITE S57 80 ml	1.000	PZ	TR1105A4	SONDA TEMPERATUR A PT100 L1000	1.000	PZ	VI1220A1	VITE AUTOFIL. 4.2X11 TCS+ MARUTEX	2.000	PZ	VM1464A1	COPERCHIO SONDA TEMPERATUR A CT BT CON PA	1.000	PZ	VM1465A1	COPERCHIO SONDA TEMPERATUR A CT BT	1.000	PZ	VM2052A0	COPERCHIO SONDA TEMPERATUR A LM	1.000	PZ
Code	Description	Qty	UOM																																										
0H4302A0	PIASTRINA SILICONE SONDE	1.000	PZ																																										
GN1120A1	GUARNIZIONE SONDA TEMPERATUR A NTC LM	1.000	PZ																																										
GN1285A0	GUARNIZIONE SONDA DI TEMPERATUR A NTC	1.000	PZ																																										
SL1045A0	SILICONE ANTRACITE S57 80 ml	1.000	PZ																																										
TR1105A4	SONDA TEMPERATUR A PT100 L1000	1.000	PZ																																										
VI1220A1	VITE AUTOFIL. 4.2X11 TCS+ MARUTEX	2.000	PZ																																										
VM1464A1	COPERCHIO SONDA TEMPERATUR A CT BT CON PA	1.000	PZ																																										
VM1465A1	COPERCHIO SONDA TEMPERATUR A CT BT	1.000	PZ																																										
VM2052A0	COPERCHIO SONDA TEMPERATUR A LM	1.000	PZ																																										

COMPONENT			SPARE PART																														
Code	Description	Image	Code	Description	Kit components																												
0H3020A	DISCO TENUTA ALBERO MOTORE		K0H3020A	CRANKSHAFT SEAL DISC	<table border="1"> <thead> <tr> <th>Code</th> <th>Description</th> <th>Qty</th> <th>UOM</th> </tr> </thead> <tbody> <tr> <td>0H3020A1</td> <td>DISCO TENUTA ALBERO MOTORE</td> <td>1.000</td> <td>PZ</td> </tr> <tr> <td>GN1546A0</td> <td>GUARNIZIONE ALBERO MOTORE D8</td> <td>1.000</td> <td>PZ</td> </tr> </tbody> </table>	Code	Description	Qty	UOM	0H3020A1	DISCO TENUTA ALBERO MOTORE	1.000	PZ	GN1546A0	GUARNIZIONE ALBERO MOTORE D8	1.000	PZ																
					Code	Description	Qty	UOM																									
0H3020A1	DISCO TENUTA ALBERO MOTORE	1.000	PZ																														
GN1546A0	GUARNIZIONE ALBERO MOTORE D8	1.000	PZ																														
0H7170A	MM MOTOR GLASS WOOL PLATE		0H7170A0	MM MOTOR GLASS WOOL PLATE																													
GN1547A	GUARNIZIONE ALBERO MOTORE D11.8		KGN1547A	D11.6 MOTOR SHAFT GASKET 3PCS KIT	<table border="1"> <thead> <tr> <th>Code</th> <th>Description</th> <th>Qty</th> <th>UOM</th> </tr> </thead> <tbody> <tr> <td>GN1547A1</td> <td>GUARNIZIONE ALBERO MOTORE D11.</td> <td>3.000</td> <td>PZ</td> </tr> </tbody> </table>	Code	Description	Qty	UOM	GN1547A1	GUARNIZIONE ALBERO MOTORE D11.	3.000	PZ																				
					Code	Description	Qty	UOM																									
GN1547A1	GUARNIZIONE ALBERO MOTORE D11.	3.000	PZ																														
MT1012A	MOTORE SIMMETRICO 330W 230V ALBERO D12		KVN1130A	LUX ≤08.2017/L.MISS/S.5/ 5E MOTOR KIT	<table border="1"> <thead> <tr> <th>Code</th> <th>Description</th> <th>Qty</th> <th>UOM</th> </tr> </thead> <tbody> <tr> <td>0H8118A0</td> <td>DISCO TENUTA ALBERO MOTORE XEVL</td> <td>1.000</td> <td>PZ</td> </tr> <tr> <td>GN1140A3</td> <td>GUARNIZIONE PORTAMOTO RE STAMPAT</td> <td>1.000</td> <td>PZ</td> </tr> <tr> <td>V11034A0</td> <td>RONDELLA PIANA 8.4x16x1 INOX</td> <td>1.000</td> <td>PZ</td> </tr> <tr> <td>V11256A0</td> <td>DADO M8 DIN 980M AUTOBLOCCA NTE INOX</td> <td>1.000</td> <td>PZ</td> </tr> <tr> <td>VM2196A0</td> <td>BOCCOLA FISSAGGIO DADO MOTOR</td> <td>1.000</td> <td>PZ</td> </tr> <tr> <td>VN1130A1</td> <td>MOTORE FORNO 330W 230V 50/60Hz ALBERO M8</td> <td>1.000</td> <td>PZ</td> </tr> </tbody> </table>	Code	Description	Qty	UOM	0H8118A0	DISCO TENUTA ALBERO MOTORE XEVL	1.000	PZ	GN1140A3	GUARNIZIONE PORTAMOTO RE STAMPAT	1.000	PZ	V11034A0	RONDELLA PIANA 8.4x16x1 INOX	1.000	PZ	V11256A0	DADO M8 DIN 980M AUTOBLOCCA NTE INOX	1.000	PZ	VM2196A0	BOCCOLA FISSAGGIO DADO MOTOR	1.000	PZ	VN1130A1	MOTORE FORNO 330W 230V 50/60Hz ALBERO M8	1.000	PZ
Code	Description	Qty	UOM																														
0H8118A0	DISCO TENUTA ALBERO MOTORE XEVL	1.000	PZ																														
GN1140A3	GUARNIZIONE PORTAMOTO RE STAMPAT	1.000	PZ																														
V11034A0	RONDELLA PIANA 8.4x16x1 INOX	1.000	PZ																														
V11256A0	DADO M8 DIN 980M AUTOBLOCCA NTE INOX	1.000	PZ																														
VM2196A0	BOCCOLA FISSAGGIO DADO MOTOR	1.000	PZ																														
VN1130A1	MOTORE FORNO 330W 230V 50/60Hz ALBERO M8	1.000	PZ																														

COMPONENT			SPARE PART																																						
Code	Description	Image	Code	Description	Kit components																																				
MT1012A	MOTORE SIMMETRICO 330W 230V ALBERO D12		KMT1012A	LUX >08.2017 / MIND.MAPS 330W MOTOR KIT	<table border="1"> <thead> <tr> <th>Code</th> <th>Description</th> <th>Qty</th> <th>UOM</th> </tr> </thead> <tbody> <tr> <td>0H2842A0</td> <td>MASCHERA CENTRAGGIO MT1012</td> <td>1.000</td> <td>PZ</td> </tr> <tr> <td>0H8118A0</td> <td>DISCO TENUTA ALBERO MOTORE XEVL</td> <td>1.000</td> <td>PZ</td> </tr> <tr> <td>GN1140A3</td> <td>GUARNIZIONE PORTAMOTO RE STAMPAT</td> <td>1.000</td> <td>PZ</td> </tr> <tr> <td>MT1012A0</td> <td>MOTORE SIMMETRICO 330W 230V ALBERO D12</td> <td>1.000</td> <td>PZ</td> </tr> <tr> <td>VI1077A1</td> <td>VITE M6x12 TE INOX</td> <td>1.000</td> <td>PZ</td> </tr> <tr> <td>VI1521A0</td> <td>RONDELLA PIANA 6x12x1 INOX</td> <td>1.000</td> <td>PZ</td> </tr> <tr> <td>VI1966A1</td> <td>VITE M4X14 TSP+ ZN</td> <td>1.000</td> <td>PZ</td> </tr> <tr> <td>VM2880A0</td> <td>ASM MGT MISURA NUMERO GIRI</td> <td>1.000</td> <td>PZ</td> </tr> </tbody> </table>	Code	Description	Qty	UOM	0H2842A0	MASCHERA CENTRAGGIO MT1012	1.000	PZ	0H8118A0	DISCO TENUTA ALBERO MOTORE XEVL	1.000	PZ	GN1140A3	GUARNIZIONE PORTAMOTO RE STAMPAT	1.000	PZ	MT1012A0	MOTORE SIMMETRICO 330W 230V ALBERO D12	1.000	PZ	VI1077A1	VITE M6x12 TE INOX	1.000	PZ	VI1521A0	RONDELLA PIANA 6x12x1 INOX	1.000	PZ	VI1966A1	VITE M4X14 TSP+ ZN	1.000	PZ	VM2880A0	ASM MGT MISURA NUMERO GIRI	1.000	PZ
					Code	Description	Qty	UOM																																	
					0H2842A0	MASCHERA CENTRAGGIO MT1012	1.000	PZ																																	
					0H8118A0	DISCO TENUTA ALBERO MOTORE XEVL	1.000	PZ																																	
					GN1140A3	GUARNIZIONE PORTAMOTO RE STAMPAT	1.000	PZ																																	
					MT1012A0	MOTORE SIMMETRICO 330W 230V ALBERO D12	1.000	PZ																																	
					VI1077A1	VITE M6x12 TE INOX	1.000	PZ																																	
					VI1521A0	RONDELLA PIANA 6x12x1 INOX	1.000	PZ																																	
					VI1966A1	VITE M4X14 TSP+ ZN	1.000	PZ																																	
					VM2880A0	ASM MGT MISURA NUMERO GIRI	1.000	PZ																																	
VN1172A	VENTOLA D195 H40 8 PALE DADO M8		KVN1172A	D195 H40 M8 NUT 8 BLADES FAN KIT	<table border="1"> <thead> <tr> <th>Code</th> <th>Description</th> <th>Qty</th> <th>UOM</th> </tr> </thead> <tbody> <tr> <td>VI1077A1</td> <td>VITE M6x12 TE INOX</td> <td>1.000</td> <td>PZ</td> </tr> <tr> <td>VI1521A0</td> <td>RONDELLA PIANA 6x12x1 INOX</td> <td>1.000</td> <td>PZ</td> </tr> <tr> <td>VN1172A0</td> <td>VENTOLA D195 H40 8 PALE DADO M</td> <td>1.000</td> <td>PZ</td> </tr> </tbody> </table>	Code	Description	Qty	UOM	VI1077A1	VITE M6x12 TE INOX	1.000	PZ	VI1521A0	RONDELLA PIANA 6x12x1 INOX	1.000	PZ	VN1172A0	VENTOLA D195 H40 8 PALE DADO M	1.000	PZ																				
					Code	Description	Qty	UOM																																	
					VI1077A1	VITE M6x12 TE INOX	1.000	PZ																																	
					VI1521A0	RONDELLA PIANA 6x12x1 INOX	1.000	PZ																																	
VN1172A0	VENTOLA D195 H40 8 PALE DADO M	1.000	PZ																																						
RS1282B	RES CIRC 2700W 230V+260W 135V 4SP H60		KRS1282B	4TURN HEAT ELEM 2700W 230V+260W 135V KIT	<table border="1"> <thead> <tr> <th>Code</th> <th>Description</th> <th>Qty</th> <th>UOM</th> </tr> </thead> <tbody> <tr> <td>GN1327A0</td> <td>GUARNIZIONE RESISTENZA 100x22</td> <td>1.000</td> <td>PZ</td> </tr> <tr> <td>RS1282B0</td> <td>RES CIRC 2700W 230V+260W 135V 4SP H60</td> <td>1.000</td> <td>PZ</td> </tr> <tr> <td>SL1045A0</td> <td>SILICONE ANTRACITE S57 80 ml</td> <td>1.000</td> <td>PZ</td> </tr> <tr> <td>VI1220A1</td> <td>VITE AUTOFIL. 4.2X11 TCS+ MARUTEX</td> <td>2.000</td> <td>PZ</td> </tr> </tbody> </table>	Code	Description	Qty	UOM	GN1327A0	GUARNIZIONE RESISTENZA 100x22	1.000	PZ	RS1282B0	RES CIRC 2700W 230V+260W 135V 4SP H60	1.000	PZ	SL1045A0	SILICONE ANTRACITE S57 80 ml	1.000	PZ	VI1220A1	VITE AUTOFIL. 4.2X11 TCS+ MARUTEX	2.000	PZ																
					Code	Description	Qty	UOM																																	
					GN1327A0	GUARNIZIONE RESISTENZA 100x22	1.000	PZ																																	
					RS1282B0	RES CIRC 2700W 230V+260W 135V 4SP H60	1.000	PZ																																	
SL1045A0	SILICONE ANTRACITE S57 80 ml	1.000	PZ																																						
VI1220A1	VITE AUTOFIL. 4.2X11 TCS+ MARUTEX	2.000	PZ																																						

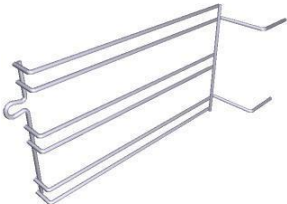
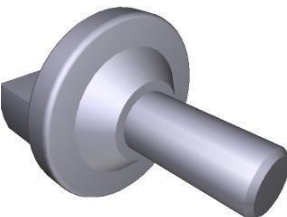

COMPONENT			SPARE PART														
Code	Description	Image	Code	Description	Kit components												
GRL1005A	GRIGLIA LATERALE DX/SX CROMATA		KGRL1005A	R/L CHROM. PLATED LATERAL SUPP KIT	<table border="1"> <thead> <tr> <th>Code</th> <th>Description</th> <th>Qty</th> <th>UOM</th> </tr> </thead> <tbody> <tr> <td>GRL1005A2</td> <td>GRIGLIA LATERALE DX/SX CROMATA</td> <td>2.000</td> <td>PZ</td> </tr> </tbody> </table>	Code	Description	Qty	UOM	GRL1005A2	GRIGLIA LATERALE DX/SX CROMATA	2.000	PZ				
Code	Description	Qty	UOM														
GRL1005A2	GRIGLIA LATERALE DX/SX CROMATA	2.000	PZ														
VM1815A	NOTTOLINO M6 CROMATO FISS. GRIGLIE		KVM1815A	MISS/MICRO/S4/S3 THUMB SCREW 10 PCS KIT	<table border="1"> <thead> <tr> <th>Code</th> <th>Description</th> <th>Qty</th> <th>UOM</th> </tr> </thead> <tbody> <tr> <td>VM1815A0</td> <td>NOTTOLINO M6 CROMATO FISS. GRIGLIE</td> <td>10.000</td> <td>PZ</td> </tr> </tbody> </table>	Code	Description	Qty	UOM	VM1815A0	NOTTOLINO M6 CROMATO FISS. GRIGLIE	10.000	PZ				
Code	Description	Qty	UOM														
VM1815A0	NOTTOLINO M6 CROMATO FISS. GRIGLIE	10.000	PZ														
GN1596A	GN1110A-GUARNIZI ONE STEFANIA SP 1500MM		KG1596A	BL SHOP.PRO STEFANIA DOOR GASKET KIT	<table border="1"> <thead> <tr> <th>Code</th> <th>Description</th> <th>Qty</th> <th>UOM</th> </tr> </thead> <tbody> <tr> <td>GN1596A1</td> <td>GN1110A-GUA RNIZIONE STEFANIA SP 1500MM</td> <td>1.000</td> <td>PZ</td> </tr> <tr> <td>VM2277A0</td> <td>SPINA KIT GUARNIZIONE PORTA</td> <td>1.000</td> <td>PZ</td> </tr> </tbody> </table>	Code	Description	Qty	UOM	GN1596A1	GN1110A-GUA RNIZIONE STEFANIA SP 1500MM	1.000	PZ	VM2277A0	SPINA KIT GUARNIZIONE PORTA	1.000	PZ
Code	Description	Qty	UOM														
GN1596A1	GN1110A-GUA RNIZIONE STEFANIA SP 1500MM	1.000	PZ														
VM2277A0	SPINA KIT GUARNIZIONE PORTA	1.000	PZ														
TB1574A	FUME CHIMNEY D30 SHOP PRO		TB1574A0	FUME CHIMNEY D30 SHOP PRO													



ASM3407A/0.D03 - External cover - FRONT













ASM3407A/0.D03 - External cover - REAR



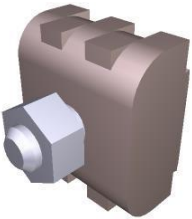

COMPONENT			SPARE PART														
Code	Description	Image	Code	Description	Kit components												
0D2401B	SP DROP-DOWN STEFANIA EXTERNAL CASING		0D2401B2	SP DROP-DOWN STEFANIA EXTERNAL CASING													
0D2409A	SP600 INF FRONT PROFILE DROP DOWN DOOR		0D2409A1	SP600 INF FRONT PROFILE DROP DOWN DOOR													
0E1381A	SP600 EXTERNAL BOTTOM PANEL		0E1381A1	SP600 EXTERNAL BOTTOM PANEL													
0F1541B	SHOP.Pro STEFANIA BACK PANEL		0F1541B0	SHOP.Pro STEFANIA BACK PANEL													
CR1000A	ATTACCO CERNIERA PORTA FORNO RIBALTA		KCR1000A	LM HINGES LATCH KIT	<table border="1"> <thead> <tr> <th>Code</th> <th>Description</th> <th>Qty</th> <th>UOM</th> </tr> </thead> <tbody> <tr> <td>CR1000A0</td> <td>ATTACCO CERNIERA PORTA FORNO RIBALTA</td> <td>1.000</td> <td>PZ</td> </tr> <tr> <td>VI1280A3</td> <td>VITE M5X10 TC1/2T COMBI ZN-NI</td> <td>2.000</td> <td>PZ</td> </tr> </tbody> </table>	Code	Description	Qty	UOM	CR1000A0	ATTACCO CERNIERA PORTA FORNO RIBALTA	1.000	PZ	VI1280A3	VITE M5X10 TC1/2T COMBI ZN-NI	2.000	PZ
Code	Description	Qty	UOM														
CR1000A0	ATTACCO CERNIERA PORTA FORNO RIBALTA	1.000	PZ														
VI1280A3	VITE M5X10 TC1/2T COMBI ZN-NI	2.000	PZ														





COMPONENT			SPARE PART														
Code	Description	Image	Code	Description	Kit components												
VM1750A	MORSETTO A PETTINE		KVM1750A	COMB TERMINAL BLOCK KIT	<table border="1"> <thead> <tr> <th>Code</th> <th>Description</th> <th>Qty</th> <th>UOM</th> </tr> </thead> <tbody> <tr> <td>V11040A0</td> <td>ROSETTA DENTELLATA INTERNA ø6 Z</td> <td>2.000</td> <td>PZ</td> </tr> <tr> <td>VM1750A0</td> <td>MORSETTO A PETTINE</td> <td>1.000</td> <td>PZ</td> </tr> </tbody> </table>	Code	Description	Qty	UOM	V11040A0	ROSETTA DENTELLATA INTERNA ø6 Z	2.000	PZ	VM1750A0	MORSETTO A PETTINE	1.000	PZ
Code	Description	Qty	UOM														
V11040A0	ROSETTA DENTELLATA INTERNA ø6 Z	2.000	PZ														
VM1750A0	MORSETTO A PETTINE	1.000	PZ														
VM2502A	ANELLO CAMINO SP		KVM2502A	BAKERLUX SHOP.PRO CHIMNEY RING KIT	<table border="1"> <thead> <tr> <th>Code</th> <th>Description</th> <th>Qty</th> <th>UOM</th> </tr> </thead> <tbody> <tr> <td>VM2502A0</td> <td>ANELLO CAMINO SP</td> <td>1.000</td> <td>PZ</td> </tr> </tbody> </table>	Code	Description	Qty	UOM	VM2502A0	ANELLO CAMINO SP	1.000	PZ				
Code	Description	Qty	UOM														
VM2502A0	ANELLO CAMINO SP	1.000	PZ														
VM2495A	SUPPORTO VENTOLA RAFFREDDAMENTO SP		KVM2495A	COOLING FAN SUPPORT KIT	<table border="1"> <thead> <tr> <th>Code</th> <th>Description</th> <th>Qty</th> <th>UOM</th> </tr> </thead> <tbody> <tr> <td>V11220A1</td> <td>VITE AUTOFIL. 4.2X11 TCS+ MARUTEX</td> <td>2.000</td> <td>PZ</td> </tr> <tr> <td>VM2495A0</td> <td>SUPPORTO VENTOLA RAFFREDDAM ENTO SP</td> <td>1.000</td> <td>PZ</td> </tr> </tbody> </table>	Code	Description	Qty	UOM	V11220A1	VITE AUTOFIL. 4.2X11 TCS+ MARUTEX	2.000	PZ	VM2495A0	SUPPORTO VENTOLA RAFFREDDAM ENTO SP	1.000	PZ
Code	Description	Qty	UOM														
V11220A1	VITE AUTOFIL. 4.2X11 TCS+ MARUTEX	2.000	PZ														
VM2495A0	SUPPORTO VENTOLA RAFFREDDAM ENTO SP	1.000	PZ														
VN1175A	VENTOLA RAFFR. 120x120 230V 50/60Hz 80°C		KVN1175A	120x120 230V 50/60Hz COOLING FAN KIT	<table border="1"> <thead> <tr> <th>Code</th> <th>Description</th> <th>Qty</th> <th>UOM</th> </tr> </thead> <tbody> <tr> <td>VN1175A0</td> <td>VENTOLA RAFFR. 120x120 230V 50/60Hz 80°C</td> <td>1.000</td> <td>PZ</td> </tr> </tbody> </table>	Code	Description	Qty	UOM	VN1175A0	VENTOLA RAFFR. 120x120 230V 50/60Hz 80°C	1.000	PZ				
Code	Description	Qty	UOM														
VN1175A0	VENTOLA RAFFR. 120x120 230V 50/60Hz 80°C	1.000	PZ														
VE1295A	MICROINTERRUTTO RE PORTA MK 16A 230V UL		KVE1295A	16A 230V DOOR MICROSWITCH KIT	<table border="1"> <thead> <tr> <th>Code</th> <th>Description</th> <th>Qty</th> <th>UOM</th> </tr> </thead> <tbody> <tr> <td>VE1295A0</td> <td>MICROINTERR UTTORE PORTA MK 16A 230V UL</td> <td>1.000</td> <td>PZ</td> </tr> </tbody> </table>	Code	Description	Qty	UOM	VE1295A0	MICROINTERR UTTORE PORTA MK 16A 230V UL	1.000	PZ				
Code	Description	Qty	UOM														
VE1295A0	MICROINTERR UTTORE PORTA MK 16A 230V UL	1.000	PZ														



COMPONENT			SPARE PART										
Code	Description	Image	Code	Description	Kit components								
VM2508A	COVER MICRO PORTA BAKERLUX SHOP.PRO		KVM2508A	BAKERLUX SHOP.PRO MICROSWITCH COVER KIT	<table border="1"> <thead> <tr> <th>Code</th> <th>Description</th> <th>Qty</th> <th>UOM</th> </tr> </thead> <tbody> <tr> <td>VM2508A0</td> <td>COVER MICRO PORTA BAKERLUX SHOP.PRO</td> <td>1.000</td> <td>PZ</td> </tr> </tbody> </table>	Code	Description	Qty	UOM	VM2508A0	COVER MICRO PORTA BAKERLUX SHOP.PRO	1.000	PZ
Code	Description	Qty	UOM										
VM2508A0	COVER MICRO PORTA BAKERLUX SHOP.PRO	1.000	PZ										
VM2481A	TAPPO FACCIATA COPERTURA ESTERNA SX SP		KVM2481A	BL SP LEFT EXT COVER FRONT PANEL CAP KIT	<table border="1"> <thead> <tr> <th>Code</th> <th>Description</th> <th>Qty</th> <th>UOM</th> </tr> </thead> <tbody> <tr> <td>VM2481A0</td> <td>TAPPO FACCIATA COPERTURA ESTERNA SX SP</td> <td>1.000</td> <td>PZ</td> </tr> </tbody> </table>	Code	Description	Qty	UOM	VM2481A0	TAPPO FACCIATA COPERTURA ESTERNA SX SP	1.000	PZ
Code	Description	Qty	UOM										
VM2481A0	TAPPO FACCIATA COPERTURA ESTERNA SX SP	1.000	PZ										
VM2480A	TAPPO FACCIATA COPERTURA ESTERNA DX SP		KVM2480A	BL SP RIGHT EXT COVER FRONT PANEL CAP	<table border="1"> <thead> <tr> <th>Code</th> <th>Description</th> <th>Qty</th> <th>UOM</th> </tr> </thead> <tbody> <tr> <td>VM2480A0</td> <td>TAPPO FACCIATA COPERTURA ESTERNA DX SP</td> <td>1.000</td> <td>PZ</td> </tr> </tbody> </table>	Code	Description	Qty	UOM	VM2480A0	TAPPO FACCIATA COPERTURA ESTERNA DX SP	1.000	PZ
Code	Description	Qty	UOM										
VM2480A0	TAPPO FACCIATA COPERTURA ESTERNA DX SP	1.000	PZ										
VM1631A	TAPPO PREMI VETRO INTERNO PLUS		KVM1631A	CAP FOR INTERNAL GLASS 10 PCS KIT	<table border="1"> <thead> <tr> <th>Code</th> <th>Description</th> <th>Qty</th> <th>UOM</th> </tr> </thead> <tbody> <tr> <td>VM1631A0</td> <td>TAPPO PREMI VETRO INTERNO PLU</td> <td>10.000</td> <td>PZ</td> </tr> </tbody> </table>	Code	Description	Qty	UOM	VM1631A0	TAPPO PREMI VETRO INTERNO PLU	10.000	PZ
Code	Description	Qty	UOM										
VM1631A0	TAPPO PREMI VETRO INTERNO PLU	10.000	PZ										
VM2490A	GUARNIZIONE FONDO EST. FRONTALE L600 SP		KVM2490A	SP 460X330 EXT BOTTOM PANEL GASKET KIT	<table border="1"> <thead> <tr> <th>Code</th> <th>Description</th> <th>Qty</th> <th>UOM</th> </tr> </thead> <tbody> <tr> <td>VM2490A0</td> <td>GUARNIZIONE FONDO EST. FRONTALE L600 SP</td> <td>2.000</td> <td>PZ</td> </tr> </tbody> </table>	Code	Description	Qty	UOM	VM2490A0	GUARNIZIONE FONDO EST. FRONTALE L600 SP	2.000	PZ
Code	Description	Qty	UOM										
VM2490A0	GUARNIZIONE FONDO EST. FRONTALE L600 SP	2.000	PZ										

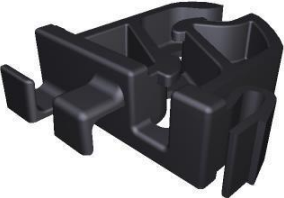

COMPONENT			SPARE PART														
Code	Description	Image	Code	Description	Kit components												
VM2491A	GUARNIZIONE FONDO EST LAT 460x330 BL SP		KVM2491A	SP 460X330 LAT BOTT PANEL GASKET 2PC KIT	<table border="1"> <thead> <tr> <th>Code</th> <th>Description</th> <th>Qty</th> <th>UOM</th> </tr> </thead> <tbody> <tr> <td>VM1631A0</td> <td>TAPPO PREMI VETRO INTERNO PLU</td> <td>4.000</td> <td>PZ</td> </tr> <tr> <td>VM2491A1</td> <td>GUARNIZIONE FONDO EST LAT 460x330 BL SP</td> <td>2.000</td> <td>PZ</td> </tr> </tbody> </table>	Code	Description	Qty	UOM	VM1631A0	TAPPO PREMI VETRO INTERNO PLU	4.000	PZ	VM2491A1	GUARNIZIONE FONDO EST LAT 460x330 BL SP	2.000	PZ
Code	Description	Qty	UOM														
VM1631A0	TAPPO PREMI VETRO INTERNO PLU	4.000	PZ														
VM2491A1	GUARNIZIONE FONDO EST LAT 460x330 BL SP	2.000	PZ														
VM1222A	CABLE LOCKS SP ACCESSORIES EL CONNECTION		VM1222A0	CABLE LOCKS SP ACCESSORIES EL CONNECTION													
VM2249A	ANGOLO FACCIATA MUFFOLA PPS		KVM2249A	CHAMBER FRONT PROFILE CORNER KIT	<table border="1"> <thead> <tr> <th>Code</th> <th>Description</th> <th>Qty</th> <th>UOM</th> </tr> </thead> <tbody> <tr> <td>VM2249A0</td> <td>ANGOLO FACCIATA MUFFOLA PPS</td> <td>1.000</td> <td>PZ</td> </tr> </tbody> </table>	Code	Description	Qty	UOM	VM2249A0	ANGOLO FACCIATA MUFFOLA PPS	1.000	PZ				
Code	Description	Qty	UOM														
VM2249A0	ANGOLO FACCIATA MUFFOLA PPS	1.000	PZ														
VM2455A	CLIP PASSAGGIO CAVO CONTROLLO COMANDI SP		KVM2455A	BL SP CONTR BOARD CABLE PASS-THROUGH KIT	<table border="1"> <thead> <tr> <th>Code</th> <th>Description</th> <th>Qty</th> <th>UOM</th> </tr> </thead> <tbody> <tr> <td>VM2455A1</td> <td>CLIP PASSAGGIO CAVO CONTROLLO COMANDI SP</td> <td>1.000</td> <td>PZ</td> </tr> </tbody> </table>	Code	Description	Qty	UOM	VM2455A1	CLIP PASSAGGIO CAVO CONTROLLO COMANDI SP	1.000	PZ				
Code	Description	Qty	UOM														
VM2455A1	CLIP PASSAGGIO CAVO CONTROLLO COMANDI SP	1.000	PZ														

ASM3419B/0.D01 - Door - FRONT

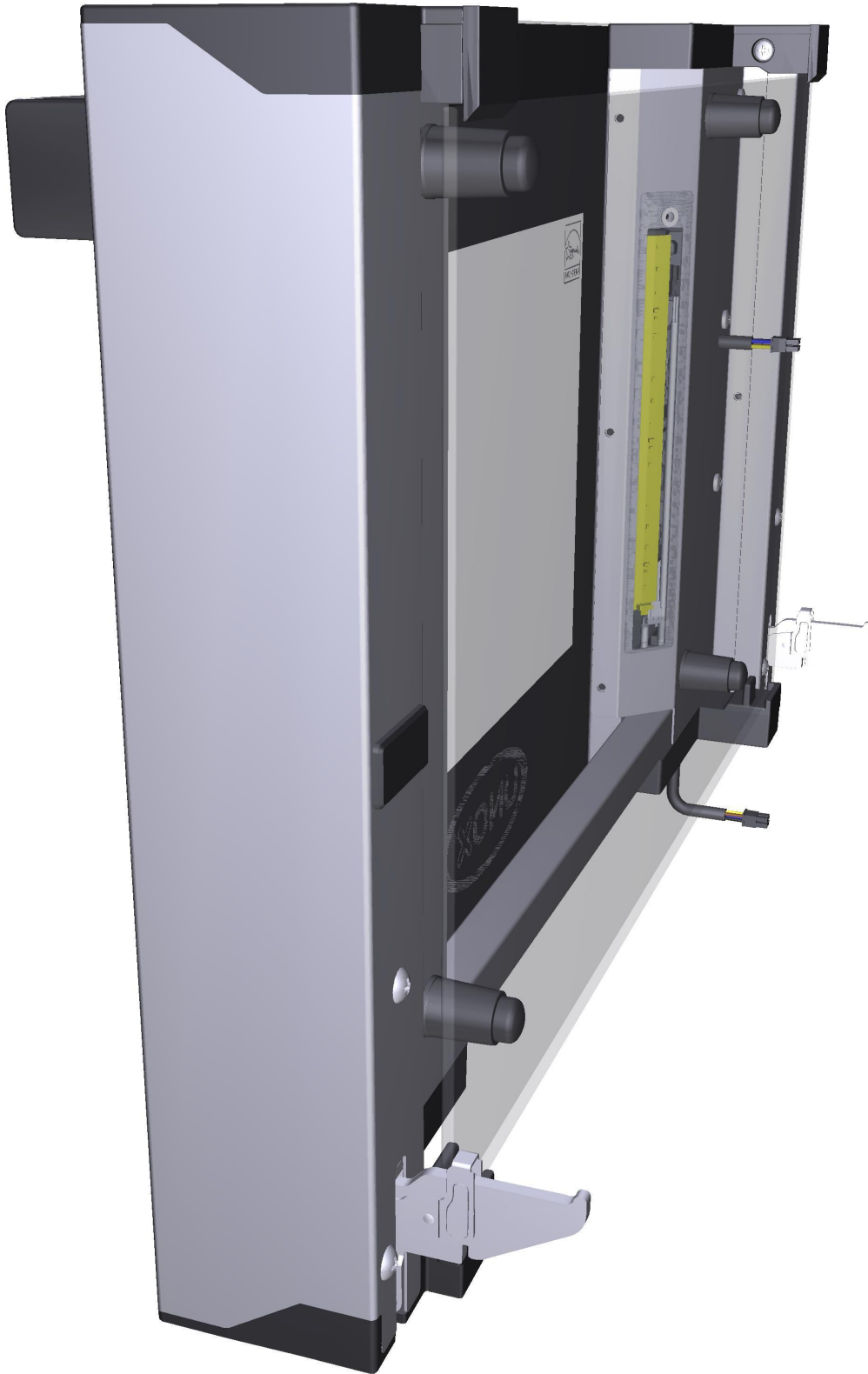

ASM3419B/0.D01 - Door - REAR







COMPONENT			SPARE PART																						
Code	Description	Image	Code	Description	Kit components																				
OB1286A	OB1286A0		OB1286A0	OB1286A0																					
OB1288A	OB1288A0		OB1288A0	OB1288A0																					
LP1050A	BARRA ILLUMINAZIONE LED L180 SP COMPLETA		KLP1050A	L180 COMPLETE LED LIGHT BAR KIT	<table border="1"> <thead> <tr> <th>Code</th> <th>Description</th> <th>Qty</th> <th>UOM</th> </tr> </thead> <tbody> <tr> <td>LP1050A0</td> <td>BARRA ILLUMINAZIONE LED L180 SP COMPLETA</td> <td>1.000</td> <td>PZ</td> </tr> <tr> <td>VI1014A0</td> <td>RONDELLA PIANA 4.5X9X0.8 INO</td> <td>1.000</td> <td>PZ</td> </tr> <tr> <td>VI1220A1</td> <td>VITE AUTOFIL. 4.2X11 TCS+ MARUTEX</td> <td>1.000</td> <td>PZ</td> </tr> <tr> <td>VM1447A0</td> <td>BUSTA AIRBALL ESD ROSA 230X450 MM</td> <td>0.500</td> <td>PZ</td> </tr> </tbody> </table>	Code	Description	Qty	UOM	LP1050A0	BARRA ILLUMINAZIONE LED L180 SP COMPLETA	1.000	PZ	VI1014A0	RONDELLA PIANA 4.5X9X0.8 INO	1.000	PZ	VI1220A1	VITE AUTOFIL. 4.2X11 TCS+ MARUTEX	1.000	PZ	VM1447A0	BUSTA AIRBALL ESD ROSA 230X450 MM	0.500	PZ
Code	Description	Qty	UOM																						
LP1050A0	BARRA ILLUMINAZIONE LED L180 SP COMPLETA	1.000	PZ																						
VI1014A0	RONDELLA PIANA 4.5X9X0.8 INO	1.000	PZ																						
VI1220A1	VITE AUTOFIL. 4.2X11 TCS+ MARUTEX	1.000	PZ																						
VM1447A0	BUSTA AIRBALL ESD ROSA 230X450 MM	0.500	PZ																						
TB3301A	TUBO MANIGLIA RIBALTA SP600		KTB3301A	BL SP 460X330 DROPDOWN HANDLE TUBE KIT	<table border="1"> <thead> <tr> <th>Code</th> <th>Description</th> <th>Qty</th> <th>UOM</th> </tr> </thead> <tbody> <tr> <td>TB3301A0</td> <td>TUBO MANIGLIA RIBALTA SP60</td> <td>1.000</td> <td>PZ</td> </tr> <tr> <td>VI1147A0</td> <td>VITE 5X25 TRUCIOLARE INOX</td> <td>4.000</td> <td>PZ</td> </tr> <tr> <td>VM2456A0</td> <td>TERMINALE MANIGLIA BL SP</td> <td>2.000</td> <td>PZ</td> </tr> </tbody> </table>	Code	Description	Qty	UOM	TB3301A0	TUBO MANIGLIA RIBALTA SP60	1.000	PZ	VI1147A0	VITE 5X25 TRUCIOLARE INOX	4.000	PZ	VM2456A0	TERMINALE MANIGLIA BL SP	2.000	PZ				
Code	Description	Qty	UOM																						
TB3301A0	TUBO MANIGLIA RIBALTA SP60	1.000	PZ																						
VI1147A0	VITE 5X25 TRUCIOLARE INOX	4.000	PZ																						
VM2456A0	TERMINALE MANIGLIA BL SP	2.000	PZ																						

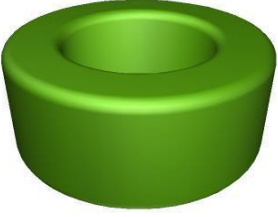

COMPONENT			SPARE PART																		
Code	Description	Image	Code	Description	Kit components																
VM2456A	TERMINALE MANIGLIA BL SP		KVM2456A	2 PCS BAKERLUX SHOP.PRO HANDLE END KIT	<table border="1"> <thead> <tr> <th>Code</th> <th>Description</th> <th>Qty</th> <th>UOM</th> </tr> </thead> <tbody> <tr> <td>VI1147A0</td> <td>VITE 5X25 TRUCIOLARE INOX</td> <td>4.000</td> <td>PZ</td> </tr> <tr> <td>VM2456A0</td> <td>TERMINALE MANIGLIA BL SP</td> <td>2.000</td> <td>PZ</td> </tr> </tbody> </table>	Code	Description	Qty	UOM	VI1147A0	VITE 5X25 TRUCIOLARE INOX	4.000	PZ	VM2456A0	TERMINALE MANIGLIA BL SP	2.000	PZ				
Code	Description	Qty	UOM																		
VI1147A0	VITE 5X25 TRUCIOLARE INOX	4.000	PZ																		
VM2456A0	TERMINALE MANIGLIA BL SP	2.000	PZ																		
VM2471A	SEDE INF CORSOIO BLOCCA VETRO INTERNO SP		KVM2471A	BL SP INTERNAL GLASS LOCK HOLDER KIT	<table border="1"> <thead> <tr> <th>Code</th> <th>Description</th> <th>Qty</th> <th>UOM</th> </tr> </thead> <tbody> <tr> <td>VI1998A0</td> <td>VITE TRUCIOLARE 5X30 TCB ZINCATA</td> <td>2.000</td> <td>PZ</td> </tr> <tr> <td>VM2471A0</td> <td>SEDE INF CORSOIO BLOCCA VETRO INTERNO SP</td> <td>1.000</td> <td>PZ</td> </tr> <tr> <td>VM2472A0</td> <td>SEDE SUP CORSOIO BLOCCA VETRO INTERNO SP</td> <td>1.000</td> <td>PZ</td> </tr> </tbody> </table>	Code	Description	Qty	UOM	VI1998A0	VITE TRUCIOLARE 5X30 TCB ZINCATA	2.000	PZ	VM2471A0	SEDE INF CORSOIO BLOCCA VETRO INTERNO SP	1.000	PZ	VM2472A0	SEDE SUP CORSOIO BLOCCA VETRO INTERNO SP	1.000	PZ
Code	Description	Qty	UOM																		
VI1998A0	VITE TRUCIOLARE 5X30 TCB ZINCATA	2.000	PZ																		
VM2471A0	SEDE INF CORSOIO BLOCCA VETRO INTERNO SP	1.000	PZ																		
VM2472A0	SEDE SUP CORSOIO BLOCCA VETRO INTERNO SP	1.000	PZ																		
VM2503A	CORSOIO BLOCCA VETRO INTERNO FISSO SP		KVM2503A	BL SP INT FIXED GLASS LOCK 2 PCS KIT	<table border="1"> <thead> <tr> <th>Code</th> <th>Description</th> <th>Qty</th> <th>UOM</th> </tr> </thead> <tbody> <tr> <td>VM2503A0</td> <td>CORSOIO BLOCCA VETRO INTERNO FISSO SP</td> <td>2.000</td> <td>PZ</td> </tr> </tbody> </table>	Code	Description	Qty	UOM	VM2503A0	CORSOIO BLOCCA VETRO INTERNO FISSO SP	2.000	PZ								
Code	Description	Qty	UOM																		
VM2503A0	CORSOIO BLOCCA VETRO INTERNO FISSO SP	2.000	PZ																		
VM2464A	TAPPO SUPERIORE SX PORTA RIBALTA SP		KVM2464A	BL SP LEFT UPPER DROPDOWN DOOR CAP KIT	<table border="1"> <thead> <tr> <th>Code</th> <th>Description</th> <th>Qty</th> <th>UOM</th> </tr> </thead> <tbody> <tr> <td>VM2464A0</td> <td>TAPPO SUPERIORE SX PORTA RIBALTA SP</td> <td>1.000</td> <td>PZ</td> </tr> </tbody> </table>	Code	Description	Qty	UOM	VM2464A0	TAPPO SUPERIORE SX PORTA RIBALTA SP	1.000	PZ								
Code	Description	Qty	UOM																		
VM2464A0	TAPPO SUPERIORE SX PORTA RIBALTA SP	1.000	PZ																		

COMPONENT			SPARE PART																		
Code	Description	Image	Code	Description	Kit components																
VM2472A	SEDE SUP CORSOIO BLOCCA VETRO INTERNO SP		KVM2471A	BL SP INTERNAL GLASS LOCK HOLDER KIT	<table border="1"> <thead> <tr> <th>Code</th> <th>Description</th> <th>Qty</th> <th>UOM</th> </tr> </thead> <tbody> <tr> <td>VI1998A0</td> <td>VITE TRUCIOLARE 5X30 TCB ZINCATA</td> <td>2.000</td> <td>PZ</td> </tr> <tr> <td>VM2471A0</td> <td>SEDE INF CORSOIO BLOCCA VETRO INTERNO SP</td> <td>1.000</td> <td>PZ</td> </tr> <tr> <td>VM2472A0</td> <td>SEDE SUP CORSOIO BLOCCA VETRO INTERNO SP</td> <td>1.000</td> <td>PZ</td> </tr> </tbody> </table>	Code	Description	Qty	UOM	VI1998A0	VITE TRUCIOLARE 5X30 TCB ZINCATA	2.000	PZ	VM2471A0	SEDE INF CORSOIO BLOCCA VETRO INTERNO SP	1.000	PZ	VM2472A0	SEDE SUP CORSOIO BLOCCA VETRO INTERNO SP	1.000	PZ
Code	Description	Qty	UOM																		
VI1998A0	VITE TRUCIOLARE 5X30 TCB ZINCATA	2.000	PZ																		
VM2471A0	SEDE INF CORSOIO BLOCCA VETRO INTERNO SP	1.000	PZ																		
VM2472A0	SEDE SUP CORSOIO BLOCCA VETRO INTERNO SP	1.000	PZ																		
VM2503A	CORSOIO BLOCCA VETRO INTERNO FISSO SP		KVM2503A	BL SP INT FIXED GLASS LOCK 2 PCS KIT	<table border="1"> <thead> <tr> <th>Code</th> <th>Description</th> <th>Qty</th> <th>UOM</th> </tr> </thead> <tbody> <tr> <td>VM2503A0</td> <td>CORSOIO BLOCCA VETRO INTERNO FISSO SP</td> <td>2.000</td> <td>PZ</td> </tr> </tbody> </table>	Code	Description	Qty	UOM	VM2503A0	CORSOIO BLOCCA VETRO INTERNO FISSO SP	2.000	PZ								
Code	Description	Qty	UOM																		
VM2503A0	CORSOIO BLOCCA VETRO INTERNO FISSO SP	2.000	PZ																		
VM2463A	TAPPO SUPERIORE DX PORTA RIBALTA SP		KVM2463A	BL SP RIGHT UPPER DROPDOWN DOOR CAP KIT	<table border="1"> <thead> <tr> <th>Code</th> <th>Description</th> <th>Qty</th> <th>UOM</th> </tr> </thead> <tbody> <tr> <td>VM2463A0</td> <td>TAPPO SUPERIORE DX PORTA RIBALTA SP</td> <td>1.000</td> <td>PZ</td> </tr> </tbody> </table>	Code	Description	Qty	UOM	VM2463A0	TAPPO SUPERIORE DX PORTA RIBALTA SP	1.000	PZ								
Code	Description	Qty	UOM																		
VM2463A0	TAPPO SUPERIORE DX PORTA RIBALTA SP	1.000	PZ																		
TB1562A	DOOR LATERAL BEAM SP600		TB1562A0	DOOR LATERAL BEAM SP600																	

COMPONENT			SPARE PART														
Code	Description	Image	Code	Description	Kit components												
VI1174A	VI1174A0		VI1174A0	VI1174A0													
VM2461A	TAPPO INFERIORE DX PORTA RIBALTA SP		KVM2461A	BL SP RIGHT LOWER DROPDOWN DOOR CAP KIT	<table border="1"> <thead> <tr> <th>Code</th> <th>Description</th> <th>Qty</th> <th>UOM</th> </tr> </thead> <tbody> <tr> <td>VM2461A0</td> <td>TAPPO INFERIORE DX PORTA RIBALTA SP</td> <td>1.000</td> <td>PZ</td> </tr> </tbody> </table>	Code	Description	Qty	UOM	VM2461A0	TAPPO INFERIORE DX PORTA RIBALTA SP	1.000	PZ				
Code	Description	Qty	UOM														
VM2461A0	TAPPO INFERIORE DX PORTA RIBALTA SP	1.000	PZ														
VM2462A	TAPPO INFERIORE SX PORTA RIBALTA SP		KVM2462A	BL SP LEFT LOWER DROPDOWN DOOR CAP KIT	<table border="1"> <thead> <tr> <th>Code</th> <th>Description</th> <th>Qty</th> <th>UOM</th> </tr> </thead> <tbody> <tr> <td>VM2462A0</td> <td>TAPPO INFERIORE SX PORTA RIBALTA SP</td> <td>1.000</td> <td>PZ</td> </tr> </tbody> </table>	Code	Description	Qty	UOM	VM2462A0	TAPPO INFERIORE SX PORTA RIBALTA SP	1.000	PZ				
Code	Description	Qty	UOM														
VM2462A0	TAPPO INFERIORE SX PORTA RIBALTA SP	1.000	PZ														
VM1630A	TAPPO PREMI VETRO INTERNO		KVM1630A	CAP FOR INTERNAL GLASS 10 PCS KIT	<table border="1"> <thead> <tr> <th>Code</th> <th>Description</th> <th>Qty</th> <th>UOM</th> </tr> </thead> <tbody> <tr> <td>VM1630A1</td> <td>TAPPO PREMI VETRO INTERNO</td> <td>10.000</td> <td>PZ</td> </tr> </tbody> </table>	Code	Description	Qty	UOM	VM1630A1	TAPPO PREMI VETRO INTERNO	10.000	PZ				
Code	Description	Qty	UOM														
VM1630A1	TAPPO PREMI VETRO INTERNO	10.000	PZ														
VM2478A	SPINGIVETRO VETRO H4 BL SP		KVM2478A	BL SHOP.PRO H4 GLASS SUPPORT 4 PCS KIT	<table border="1"> <thead> <tr> <th>Code</th> <th>Description</th> <th>Qty</th> <th>UOM</th> </tr> </thead> <tbody> <tr> <td>VM1630A1</td> <td>TAPPO PREMI VETRO INTERNO</td> <td>4.000</td> <td>PZ</td> </tr> <tr> <td>VM2478A0</td> <td>SPINGIVETRO VETRO H4 BL SP</td> <td>4.000</td> <td>PZ</td> </tr> </tbody> </table>	Code	Description	Qty	UOM	VM1630A1	TAPPO PREMI VETRO INTERNO	4.000	PZ	VM2478A0	SPINGIVETRO VETRO H4 BL SP	4.000	PZ
Code	Description	Qty	UOM														
VM1630A1	TAPPO PREMI VETRO INTERNO	4.000	PZ														
VM2478A0	SPINGIVETRO VETRO H4 BL SP	4.000	PZ														

COMPONENT			SPARE PART																		
Code	Description	Image	Code	Description	Kit components																
CE1095A	CAVO BUS MICROFIT 4POLI 2M		KCE1095A	4POLES 2M BUS CABLE KIT POWER-CONTROL	<table border="1"> <thead> <tr> <th>Code</th> <th>Description</th> <th>Qty</th> <th>UOM</th> </tr> </thead> <tbody> <tr> <td>CE1095A0</td> <td>CAVO BUS MICROFIT 4POLI 2M</td> <td>1.000</td> <td>PZ</td> </tr> </tbody> </table>	Code	Description	Qty	UOM	CE1095A0	CAVO BUS MICROFIT 4POLI 2M	1.000	PZ								
Code	Description	Qty	UOM																		
CE1095A0	CAVO BUS MICROFIT 4POLI 2M	1.000	PZ																		
CE1285A	FERRITE EMI ROUND MOD. 2643801502		KCE1285A	ROUND FERRITE ELECTROMAGN PROT. 2PCS KIT	<table border="1"> <thead> <tr> <th>Code</th> <th>Description</th> <th>Qty</th> <th>UOM</th> </tr> </thead> <tbody> <tr> <td>CE1285A0</td> <td>FERRITE EMI ROUND MOD. 2643801502</td> <td>2.000</td> <td>PZ</td> </tr> </tbody> </table>	Code	Description	Qty	UOM	CE1285A0	FERRITE EMI ROUND MOD. 2643801502	2.000	PZ								
Code	Description	Qty	UOM																		
CE1285A0	FERRITE EMI ROUND MOD. 2643801502	2.000	PZ																		
CR1111A	CERNIERA PORTA RIBALTA SP STEFANIA		KCR1111A	BAKERLUX SHOP.PRO STEFANIA HINGE KI	<table border="1"> <thead> <tr> <th>Code</th> <th>Description</th> <th>Qty</th> <th>UOM</th> </tr> </thead> <tbody> <tr> <td>CR1111A0</td> <td>CERNIERA PORTA RIBALTA SP STEFANIA</td> <td>1.000</td> <td>PZ</td> </tr> <tr> <td>VI1280A3</td> <td>VITE M5X10 TC1/2T COMBI ZN-NI</td> <td>3.000</td> <td>PZ</td> </tr> </tbody> </table>	Code	Description	Qty	UOM	CR1111A0	CERNIERA PORTA RIBALTA SP STEFANIA	1.000	PZ	VI1280A3	VITE M5X10 TC1/2T COMBI ZN-NI	3.000	PZ				
Code	Description	Qty	UOM																		
CR1111A0	CERNIERA PORTA RIBALTA SP STEFANIA	1.000	PZ																		
VI1280A3	VITE M5X10 TC1/2T COMBI ZN-NI	3.000	PZ																		
PE2105A	CONTROLLO COMPLETO SP Go		KPE2105A	BAKERLUX SP GO CONTROL BOARD KIT	<table border="1"> <thead> <tr> <th>Code</th> <th>Description</th> <th>Qty</th> <th>UOM</th> </tr> </thead> <tbody> <tr> <td>PE2105A2</td> <td>CONTROLLO COMPLETO SP Go</td> <td>1.000</td> <td>PZ</td> </tr> <tr> <td>VI1147A0</td> <td>VITE 5X25 TRUCIOLARE INOX</td> <td>2.000</td> <td>PZ</td> </tr> <tr> <td>VM1447A0</td> <td>BUSTA AIRBALL ESD ROSA 230X450 MM</td> <td>1.000</td> <td>PZ</td> </tr> </tbody> </table>	Code	Description	Qty	UOM	PE2105A2	CONTROLLO COMPLETO SP Go	1.000	PZ	VI1147A0	VITE 5X25 TRUCIOLARE INOX	2.000	PZ	VM1447A0	BUSTA AIRBALL ESD ROSA 230X450 MM	1.000	PZ
Code	Description	Qty	UOM																		
PE2105A2	CONTROLLO COMPLETO SP Go	1.000	PZ																		
VI1147A0	VITE 5X25 TRUCIOLARE INOX	2.000	PZ																		
VM1447A0	BUSTA AIRBALL ESD ROSA 230X450 MM	1.000	PZ																		
VI1174A	VI1174A0		VI1174A0	VI1174A0																	



COMPONENT			SPARE PART																						
Code	Description	Image	Code	Description	Kit components																				
VM2512A	BATTUTA SOFT MICRO PORTA BAKERLUX SP		KVM2512A	BL SP DOOR-MICROSWITC H SOFT CLOSING KI	<table border="1"> <thead> <tr> <th>Code</th> <th>Description</th> <th>Qty</th> <th>UOM</th> </tr> </thead> <tbody> <tr> <td>VM2512A0</td> <td>BATTUTA SOFT MICRO PORTA BAKERLUX SP</td> <td>1.000</td> <td>PZ</td> </tr> </tbody> </table>	Code	Description	Qty	UOM	VM2512A0	BATTUTA SOFT MICRO PORTA BAKERLUX SP	1.000	PZ												
Code	Description	Qty	UOM																						
VM2512A0	BATTUTA SOFT MICRO PORTA BAKERLUX SP	1.000	PZ																						
VT1217A	VETRO EST NERO SER STEFANIA SP 357x364x4		KVT1217A	SP STEFANIA BLACK EXT GLASS KIT	<table border="1"> <thead> <tr> <th>Code</th> <th>Description</th> <th>Qty</th> <th>UOM</th> </tr> </thead> <tbody> <tr> <td>0B0386A0</td> <td>PROFILO SUPPORTO VETRO EST STE-ELE SP</td> <td>2.000</td> <td>PZ</td> </tr> <tr> <td>SL1185A1</td> <td>SILICONE VETRO EXT STE-ELE SP</td> <td>2.000</td> <td>PZ</td> </tr> <tr> <td>VI1220A1</td> <td>VITE AUTOFIL. 4.2X11 TCS+ MARUTEX</td> <td>6.000</td> <td>PZ</td> </tr> <tr> <td>VT1217A0</td> <td>VETRO EST NERO SER STEFANIA SP 357x364x4</td> <td>1.000</td> <td>PZ</td> </tr> </tbody> </table>	Code	Description	Qty	UOM	0B0386A0	PROFILO SUPPORTO VETRO EST STE-ELE SP	2.000	PZ	SL1185A1	SILICONE VETRO EXT STE-ELE SP	2.000	PZ	VI1220A1	VITE AUTOFIL. 4.2X11 TCS+ MARUTEX	6.000	PZ	VT1217A0	VETRO EST NERO SER STEFANIA SP 357x364x4	1.000	PZ
Code	Description	Qty	UOM																						
0B0386A0	PROFILO SUPPORTO VETRO EST STE-ELE SP	2.000	PZ																						
SL1185A1	SILICONE VETRO EXT STE-ELE SP	2.000	PZ																						
VI1220A1	VITE AUTOFIL. 4.2X11 TCS+ MARUTEX	6.000	PZ																						
VT1217A0	VETRO EST NERO SER STEFANIA SP 357x364x4	1.000	PZ																						
VT1329A	VETRO INT STEFANIA SP 515x318.5x4		KVT1329A	BL SP STEFANIA INTERNAL DOOR GLASS KIT	<table border="1"> <thead> <tr> <th>Code</th> <th>Description</th> <th>Qty</th> <th>UOM</th> </tr> </thead> <tbody> <tr> <td>VT1329A0</td> <td>VETRO INT STEFANIA SP 515x318.5x4</td> <td>1.000</td> <td>PZ</td> </tr> </tbody> </table>	Code	Description	Qty	UOM	VT1329A0	VETRO INT STEFANIA SP 515x318.5x4	1.000	PZ												
Code	Description	Qty	UOM																						
VT1329A0	VETRO INT STEFANIA SP 515x318.5x4	1.000	PZ																						



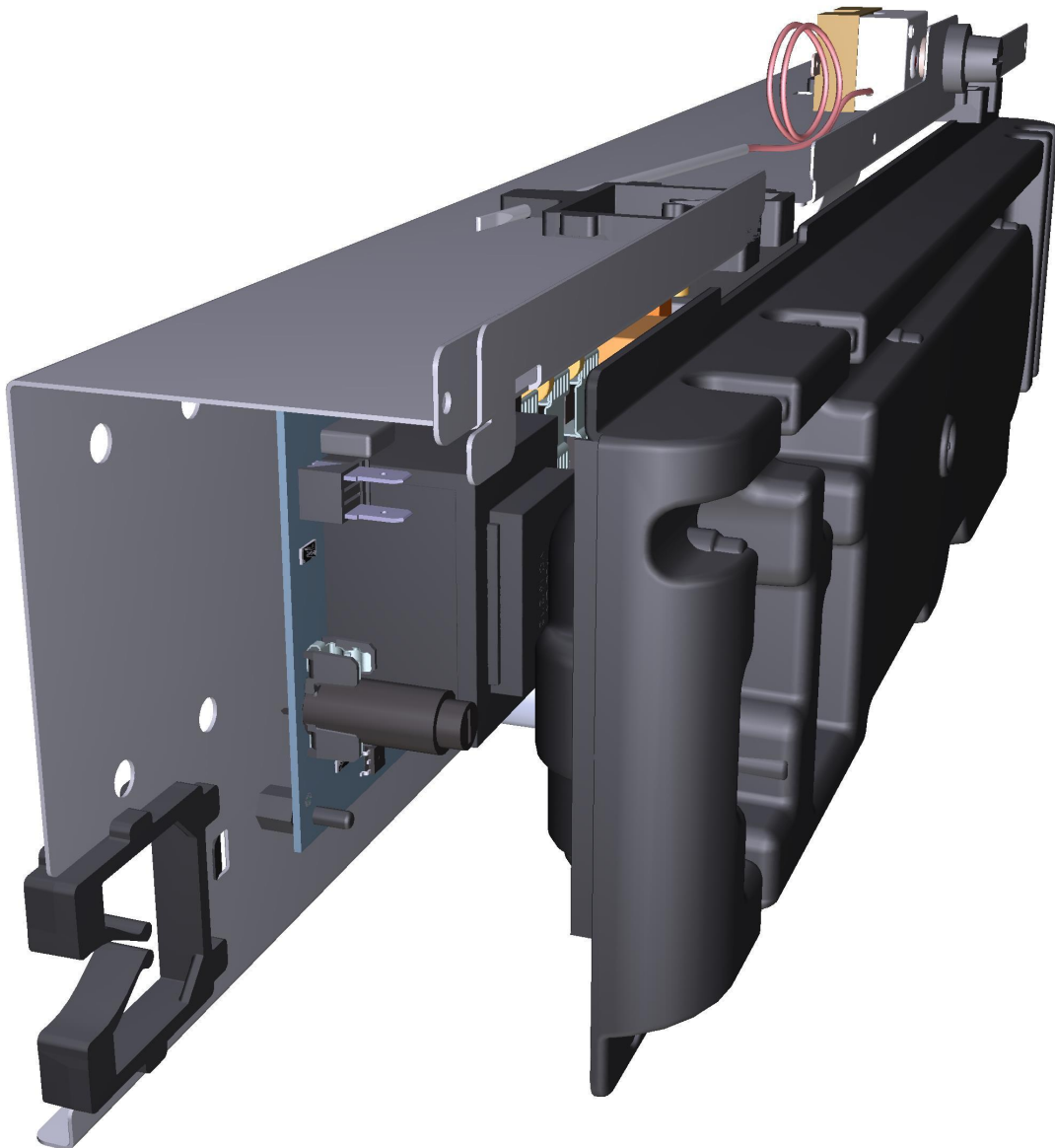

ASM8225A/0.D00 - Electrical system - FRONT

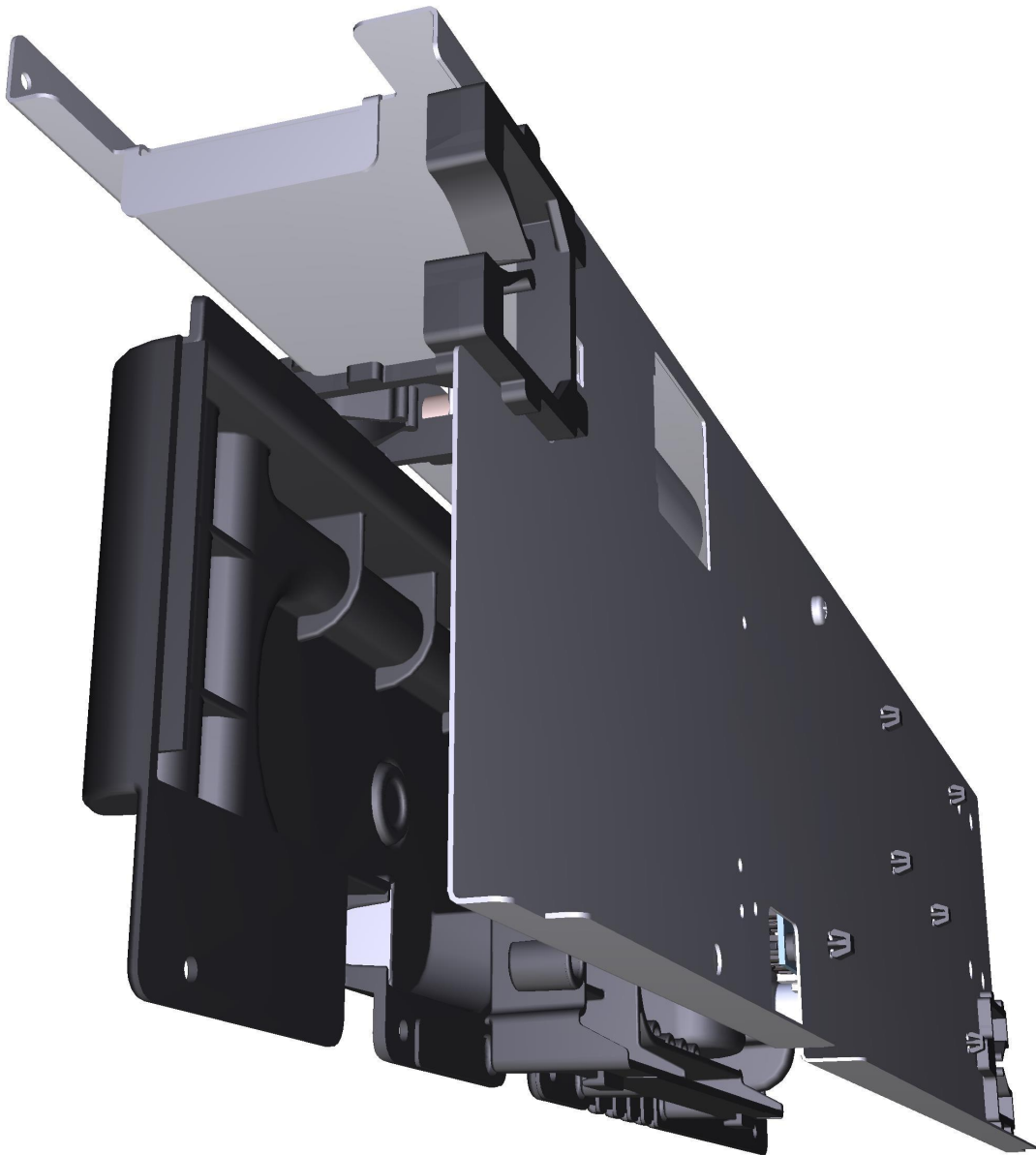



ASM8225A/0.D00 - Electrical system - REAR



COMPONENT			SPARE PART																										
Code	Description	Image	Code	Description	Kit components																								
OP1052A	SP600 SINGLE MOTOR BOARD WIRING HOLDER		OP1052A0	SP600 SINGLE MOTOR BOARD WIRING HOLDER																									
PE1463A	SCHEDA POTENZA SP600 03HS-04HS 230V		KPE1463A	SHOP.Pro 230V 03HS-04HS POWER CARD KIT	<table border="1"> <thead> <tr> <th>Code</th> <th>Description</th> <th>Qty</th> <th>UOM</th> </tr> </thead> <tbody> <tr> <td>PE1463A0</td> <td>SCHEDA POTENZA SP600 03HS-04HS 230V</td> <td>1.000</td> <td>PZ</td> </tr> <tr> <td>VI1988A0</td> <td>VITE AUTOFIL. 4.2X19 TCB+ INOX</td> <td>3.000</td> <td>PZ</td> </tr> <tr> <td>VM1187A0</td> <td>TELAIO SCHEDA POTENZA SHOP.PRO</td> <td>1.000</td> <td>PZ</td> </tr> <tr> <td>VM1447A0</td> <td>BUSTA AIRBALL ESD ROSA 230X450 MM</td> <td>1.000</td> <td>PZ</td> </tr> <tr> <td>VM1748A0</td> <td>CLIP FISSAGGIO SCHEDA H10 INCASTRO-IN CAS</td> <td>6.000</td> <td>PZ</td> </tr> </tbody> </table>	Code	Description	Qty	UOM	PE1463A0	SCHEDA POTENZA SP600 03HS-04HS 230V	1.000	PZ	VI1988A0	VITE AUTOFIL. 4.2X19 TCB+ INOX	3.000	PZ	VM1187A0	TELAIO SCHEDA POTENZA SHOP.PRO	1.000	PZ	VM1447A0	BUSTA AIRBALL ESD ROSA 230X450 MM	1.000	PZ	VM1748A0	CLIP FISSAGGIO SCHEDA H10 INCASTRO-IN CAS	6.000	PZ
Code	Description	Qty	UOM																										
PE1463A0	SCHEDA POTENZA SP600 03HS-04HS 230V	1.000	PZ																										
VI1988A0	VITE AUTOFIL. 4.2X19 TCB+ INOX	3.000	PZ																										
VM1187A0	TELAIO SCHEDA POTENZA SHOP.PRO	1.000	PZ																										
VM1447A0	BUSTA AIRBALL ESD ROSA 230X450 MM	1.000	PZ																										
VM1748A0	CLIP FISSAGGIO SCHEDA H10 INCASTRO-IN CAS	6.000	PZ																										
VM1748A	CLIP FISSAGGIO SCHEDA H10 INCASTRO-INCAS		VM1748A0	CLIP FISSAGGIO SCHEDA H10 INCASTRO-INCAS																									
CN1003A	CONDENSATORE CORAZZATO 6,3 uF		KCN1003A	6,3 uF MOTOR CAPACITOR KIT	<table border="1"> <thead> <tr> <th>Code</th> <th>Description</th> <th>Qty</th> <th>UOM</th> </tr> </thead> <tbody> <tr> <td>CN1003A0</td> <td>CONDENSATO RE CORAZZATO 6,3 uF</td> <td>1.000</td> <td>PZ</td> </tr> <tr> <td>VI1931A0</td> <td>DADO CONDENSATO RE M8x1.65 H4 CH13 ZINC</td> <td>1.000</td> <td>PZ</td> </tr> <tr> <td>VI1932A0</td> <td>RONDELLA DENTELLATA CONDENSATO RE D8 ZINC</td> <td>1.000</td> <td>PZ</td> </tr> </tbody> </table>	Code	Description	Qty	UOM	CN1003A0	CONDENSATO RE CORAZZATO 6,3 uF	1.000	PZ	VI1931A0	DADO CONDENSATO RE M8x1.65 H4 CH13 ZINC	1.000	PZ	VI1932A0	RONDELLA DENTELLATA CONDENSATO RE D8 ZINC	1.000	PZ								
Code	Description	Qty	UOM																										
CN1003A0	CONDENSATO RE CORAZZATO 6,3 uF	1.000	PZ																										
VI1931A0	DADO CONDENSATO RE M8x1.65 H4 CH13 ZINC	1.000	PZ																										
VI1932A0	RONDELLA DENTELLATA CONDENSATO RE D8 ZINC	1.000	PZ																										

COMPONENT			SPARE PART																										
Code	Description	Image	Code	Description	Kit components																								
TR1136A	TERMOSTATO SIC. UNIP. 318°C -0/+24		KTR1136A	318°C -0/+24 SAFETY THERMOSTAT KIT	<table border="1"> <thead> <tr> <th>Code</th> <th>Description</th> <th>Qty</th> <th>UOM</th> </tr> </thead> <tbody> <tr> <td>0H8120A0</td> <td>COPERCHIO INGRESSO BULBO XEVL</td> <td>1.000</td> <td>PZ</td> </tr> <tr> <td>GN1531A0</td> <td>GUARNIZIONE TENUTA INGRESSO BULBO</td> <td>1.000</td> <td>PZ</td> </tr> <tr> <td>SL1045A0</td> <td>SILICONE ANTRACITE S57 80 ml</td> <td>1.000</td> <td>PZ</td> </tr> <tr> <td>TR1136A0</td> <td>TERMOSTATO SIC. UNIP. 318°C -0/+24</td> <td>1.000</td> <td>PZ</td> </tr> <tr> <td>VI1220A1</td> <td>VITE AUTOFIL. 4.2X11 TCS+ MARUTEX</td> <td>3.000</td> <td>PZ</td> </tr> </tbody> </table>	Code	Description	Qty	UOM	0H8120A0	COPERCHIO INGRESSO BULBO XEVL	1.000	PZ	GN1531A0	GUARNIZIONE TENUTA INGRESSO BULBO	1.000	PZ	SL1045A0	SILICONE ANTRACITE S57 80 ml	1.000	PZ	TR1136A0	TERMOSTATO SIC. UNIP. 318°C -0/+24	1.000	PZ	VI1220A1	VITE AUTOFIL. 4.2X11 TCS+ MARUTEX	3.000	PZ
Code	Description	Qty	UOM																										
0H8120A0	COPERCHIO INGRESSO BULBO XEVL	1.000	PZ																										
GN1531A0	GUARNIZIONE TENUTA INGRESSO BULBO	1.000	PZ																										
SL1045A0	SILICONE ANTRACITE S57 80 ml	1.000	PZ																										
TR1136A0	TERMOSTATO SIC. UNIP. 318°C -0/+24	1.000	PZ																										
VI1220A1	VITE AUTOFIL. 4.2X11 TCS+ MARUTEX	3.000	PZ																										
VI1328A	VI1328A0		VI1328A0	VI1328A0																									
VM1188A	PASSACAVI SCHEMA POTENZA		KVM1188A	POWER BOARD WIRES PASS-THROUGH 10PCS KIT	<table border="1"> <thead> <tr> <th>Code</th> <th>Description</th> <th>Qty</th> <th>UOM</th> </tr> </thead> <tbody> <tr> <td>VM1188A0</td> <td>PASSACAVI SCHEMA POTENZA</td> <td>10.000</td> <td>PZ</td> </tr> </tbody> </table>	Code	Description	Qty	UOM	VM1188A0	PASSACAVI SCHEMA POTENZA	10.000	PZ																
Code	Description	Qty	UOM																										
VM1188A0	PASSACAVI SCHEMA POTENZA	10.000	PZ																										
VM2482A	TELAIO PORTA COMPONENTI ELETTRICI SP		KVM2482A	BAKERLUX SP ELECTR COMPONENTS HOLDER KIT	<table border="1"> <thead> <tr> <th>Code</th> <th>Description</th> <th>Qty</th> <th>UOM</th> </tr> </thead> <tbody> <tr> <td>VM2482A0</td> <td>TELAIO PORTA COMPONENTI ELETTRICI SP</td> <td>1.000</td> <td>PZ</td> </tr> <tr> <td>VM2484A0</td> <td>FERMACAVO ALLACCIAMEN TO ELETTRIC</td> <td>1.000</td> <td>PZ</td> </tr> </tbody> </table>	Code	Description	Qty	UOM	VM2482A0	TELAIO PORTA COMPONENTI ELETTRICI SP	1.000	PZ	VM2484A0	FERMACAVO ALLACCIAMEN TO ELETTRIC	1.000	PZ												
Code	Description	Qty	UOM																										
VM2482A0	TELAIO PORTA COMPONENTI ELETTRICI SP	1.000	PZ																										
VM2484A0	FERMACAVO ALLACCIAMEN TO ELETTRIC	1.000	PZ																										

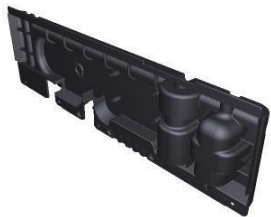

COMPONENT			SPARE PART														
Code	Description	Image	Code	Description	Kit components												
VM2483A	COPERCHIO PORTA COMPONENTI SP		KVM2483A	BL SHOP.PRO COMPONENTS HOLDER COVER KIT	<table border="1"> <thead> <tr> <th>Code</th> <th>Description</th> <th>Qty</th> <th>UOM</th> </tr> </thead> <tbody> <tr> <td>VM2483A1</td> <td>COPERCHIO PORTA COMPONENTI SP</td> <td>1.000</td> <td>PZ</td> </tr> </tbody> </table>	Code	Description	Qty	UOM	VM2483A1	COPERCHIO PORTA COMPONENTI SP	1.000	PZ				
Code	Description	Qty	UOM														
VM2483A1	COPERCHIO PORTA COMPONENTI SP	1.000	PZ														
VM2484A	FERMACAVO ALLACCIAMENTO ELETTRICO		KVM2484A	CABLE LOCKS ELECTRICAL CONNECTION KIT	<table border="1"> <thead> <tr> <th>Code</th> <th>Description</th> <th>Qty</th> <th>UOM</th> </tr> </thead> <tbody> <tr> <td>VM2484A0</td> <td>FERMACAVO ALLACCIAMEN TO ELETTRIC</td> <td>1.000</td> <td>PZ</td> </tr> </tbody> </table>	Code	Description	Qty	UOM	VM2484A0	FERMACAVO ALLACCIAMEN TO ELETTRIC	1.000	PZ				
Code	Description	Qty	UOM														
VM2484A0	FERMACAVO ALLACCIAMEN TO ELETTRIC	1.000	PZ														
			KVM2482A	BAKERLUX SP ELECTR COMPONENTS HOLDER KIT	<table border="1"> <thead> <tr> <th>Code</th> <th>Description</th> <th>Qty</th> <th>UOM</th> </tr> </thead> <tbody> <tr> <td>VM2482A0</td> <td>TELAIO PORTA COMPONENTI ELETTRICI SP</td> <td>1.000</td> <td>PZ</td> </tr> <tr> <td>VM2484A0</td> <td>FERMACAVO ALLACCIAMEN TO ELETTRIC</td> <td>1.000</td> <td>PZ</td> </tr> </tbody> </table>	Code	Description	Qty	UOM	VM2482A0	TELAIO PORTA COMPONENTI ELETTRICI SP	1.000	PZ	VM2484A0	FERMACAVO ALLACCIAMEN TO ELETTRIC	1.000	PZ
Code	Description	Qty	UOM														
VM2482A0	TELAIO PORTA COMPONENTI ELETTRICI SP	1.000	PZ														
VM2484A0	FERMACAVO ALLACCIAMEN TO ELETTRIC	1.000	PZ														