

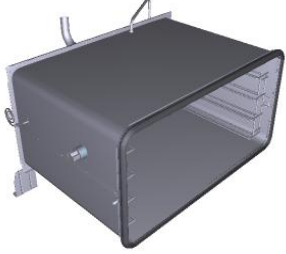



Assembly code	Assembly revision	Assembly image
ASM2012C/0.D00	Cooking chamber	
ASM2013D/0.D00	External cover	
ASM0027B/0.D00	Door	
ASM2014E/0.D01	Electrical system	

**ASM2012C/0.D00 - Cooking chamber**

**FRONT**

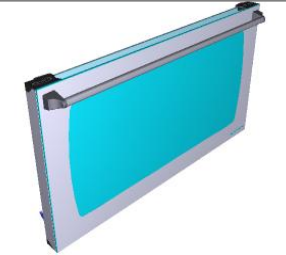
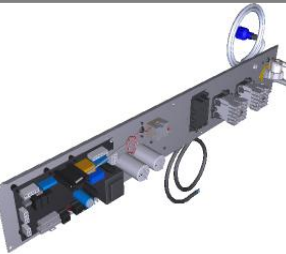
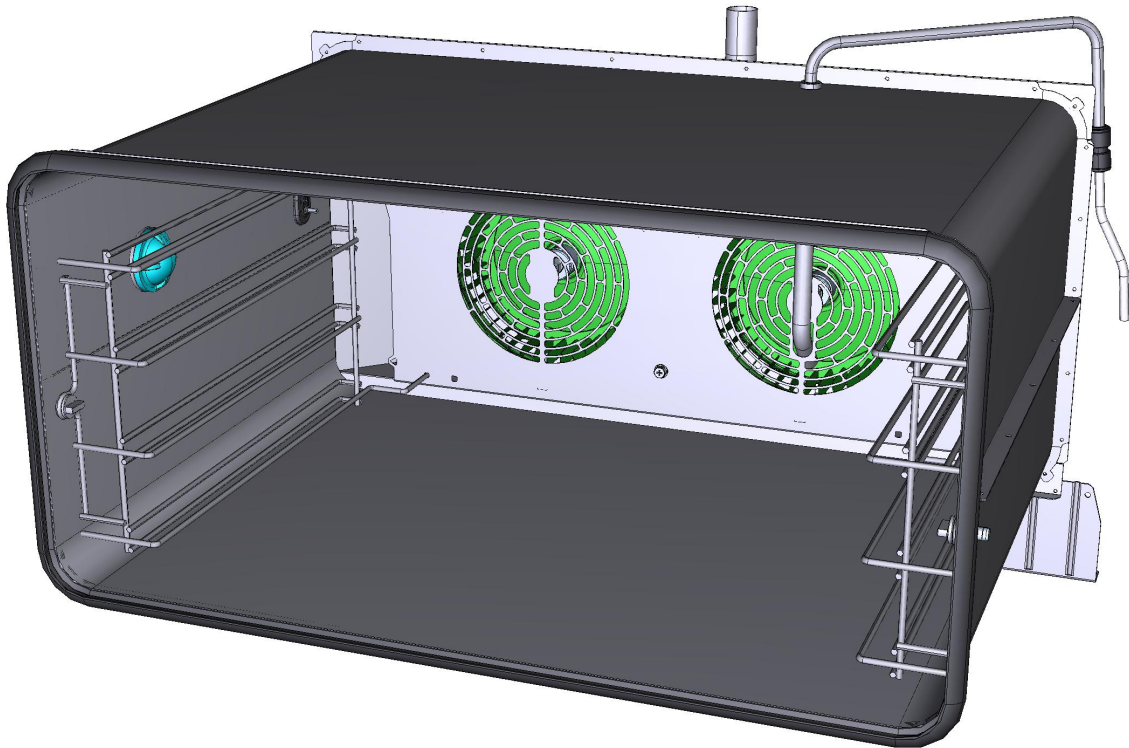







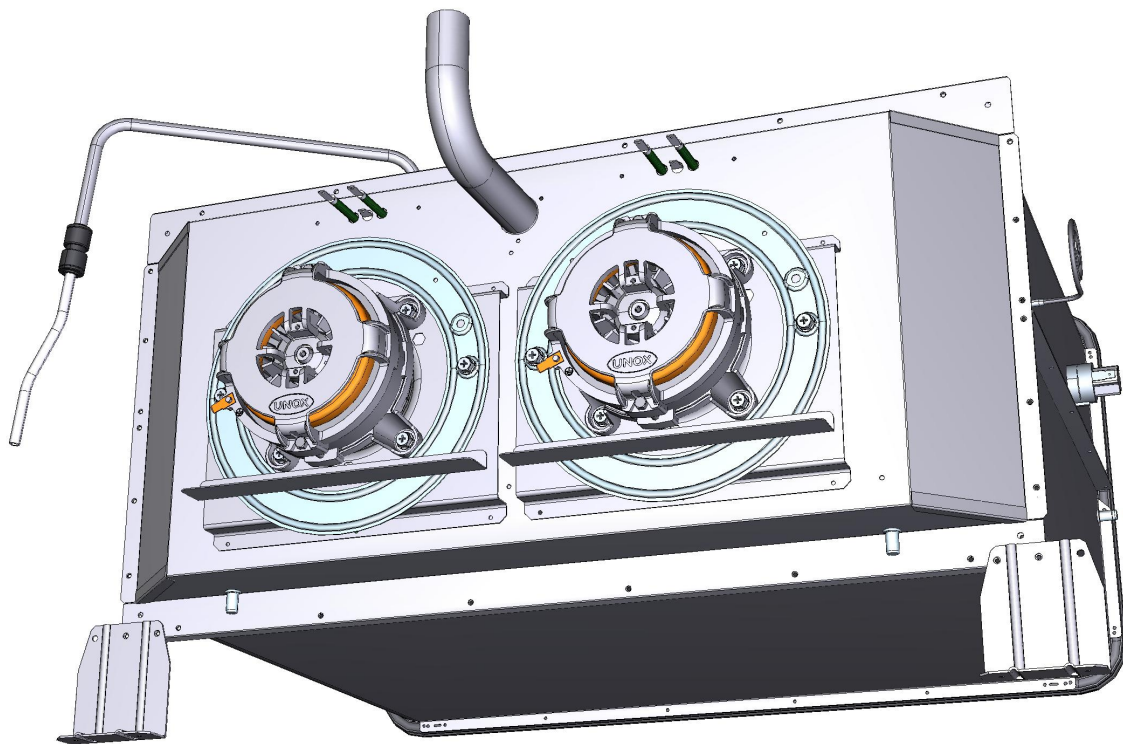

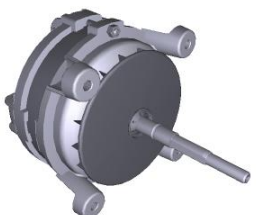

**ASM2012C/0.D00 - Cooking chamber**

**REAR**











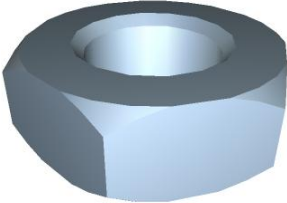

COMPONENT			SPARE PART																														
Code	Description	Image	Code	Description	Components list																												
0G1524B	XFT200 FAN GUARD SPACER		0G1524B0	XFT200 FAN GUARD SPACER																													
0G1537A	ROSSELLA STAINLESS STEEL FAN GUARD		0G1537A1	ROSSELLA STAINLESS STEEL FAN GUARD																													
0H3586A	ZINCATE MOTOR GUARD PLATE XBC-XVC		0H3586A0	ZINCATE MOTOR GUARD PLATE XBC-XVC																													
VN1130A	330W 230V 50/60HZ MOTOR		KVN1130A	5/5E SERIES XBC-XVC MOTOR KI	<table border="1"> <thead> <tr> <th>Code</th> <th>Description</th> <th>Qty</th> <th>UOM</th> </tr> </thead> <tbody> <tr> <td>GN1140A2</td> <td>MOTOR HOLDER GASKET</td> <td>1</td> <td>PZ</td> </tr> <tr> <td>VI1045A0</td> <td>16X8,4 TH=1,6 ST.STEEL WASHER</td> <td>1</td> <td>PZ</td> </tr> <tr> <td>VI1255A0</td> <td>M8 H=8 BRASS-CHRO MED NUT</td> <td>2</td> <td>PZ</td> </tr> <tr> <td>VM1794A0</td> <td>250X4.8 PA66 BLACK CLAMP</td> <td>4</td> <td>PZ</td> </tr> <tr> <td>VM2103A0</td> <td>CLAMP LOCK</td> <td>4</td> <td>PZ</td> </tr> <tr> <td>VN1130A0</td> <td>330W 230V 50/60HZ MOTO</td> <td>1</td> <td>PZ</td> </tr> </tbody> </table>	Code	Description	Qty	UOM	GN1140A2	MOTOR HOLDER GASKET	1	PZ	VI1045A0	16X8,4 TH=1,6 ST.STEEL WASHER	1	PZ	VI1255A0	M8 H=8 BRASS-CHRO MED NUT	2	PZ	VM1794A0	250X4.8 PA66 BLACK CLAMP	4	PZ	VM2103A0	CLAMP LOCK	4	PZ	VN1130A0	330W 230V 50/60HZ MOTO	1	PZ
Code	Description	Qty	UOM																														
GN1140A2	MOTOR HOLDER GASKET	1	PZ																														
VI1045A0	16X8,4 TH=1,6 ST.STEEL WASHER	1	PZ																														
VI1255A0	M8 H=8 BRASS-CHRO MED NUT	2	PZ																														
VM1794A0	250X4.8 PA66 BLACK CLAMP	4	PZ																														
VM2103A0	CLAMP LOCK	4	PZ																														
VN1130A0	330W 230V 50/60HZ MOTO	1	PZ																														

COMPONENT			SPARE PART																						
Code	Description	Image	Code	Description	Components list																				
VN1025A	D=196 H=61 38 BLADES ST. STEEL FAN		KVN1025A	D196 H61 FAN KIT	<table border="1"> <thead> <tr> <th>Code</th> <th>Description</th> <th>Qty</th> <th>UOM</th> </tr> </thead> <tbody> <tr> <td>VI1045A0</td> <td>16X8,4 TH=1,6 ST.STEEL WASHER</td> <td>1</td> <td>PZ</td> </tr> <tr> <td>VI1255A0</td> <td>M8 H=8 BRASS-CHRO MED NUT</td> <td>2</td> <td>PZ</td> </tr> <tr> <td>VN1025A2</td> <td>D=196 H=61 38 BLADES ST. STEEL FAN</td> <td>1</td> <td>PZ</td> </tr> </tbody> </table>	Code	Description	Qty	UOM	VI1045A0	16X8,4 TH=1,6 ST.STEEL WASHER	1	PZ	VI1255A0	M8 H=8 BRASS-CHRO MED NUT	2	PZ	VN1025A2	D=196 H=61 38 BLADES ST. STEEL FAN	1	PZ				
Code	Description	Qty	UOM																						
VI1045A0	16X8,4 TH=1,6 ST.STEEL WASHER	1	PZ																						
VI1255A0	M8 H=8 BRASS-CHRO MED NUT	2	PZ																						
VN1025A2	D=196 H=61 38 BLADES ST. STEEL FAN	1	PZ																						
GN1140A	MOTOR SUPPORT GASKET		KGN1140A	5 PCS. MOTOR SUPP, GASKET KIT (GN1140A1)	<table border="1"> <thead> <tr> <th>Code</th> <th>Description</th> <th>Qty</th> <th>UOM</th> </tr> </thead> <tbody> <tr> <td>GN1140A2</td> <td>MOTOR HOLDER GASKET</td> <td>5</td> <td>PZ</td> </tr> </tbody> </table>	Code	Description	Qty	UOM	GN1140A2	MOTOR HOLDER GASKET	5	PZ												
Code	Description	Qty	UOM																						
GN1140A2	MOTOR HOLDER GASKET	5	PZ																						
0H3020A	MOTOR SHAFT SEALING DISC		0H3020A1	MOTOR SHAFT SEALING DISC																					
0H1209A	PROFILE HEAT COVER FOR MOTOR		0H1209A0	PROFILE HEAT COVER FOR MOTOR																					
RS1090A	2,9KW HEATING ELEMENT		KRS1090A	2.9 KW HEATING ELEMENT KIT	<table border="1"> <thead> <tr> <th>Code</th> <th>Description</th> <th>Qty</th> <th>UOM</th> </tr> </thead> <tbody> <tr> <td>GN1327A0</td> <td>HEATING ELEMENT GASKET</td> <td>1</td> <td>PZ</td> </tr> <tr> <td>RS1090A1</td> <td>2,9KW HEATING ELEMENT</td> <td>1</td> <td>PZ</td> </tr> <tr> <td>SL1045A0</td> <td>S53 BLACK SILICONE - 80ML CARTRIDGE</td> <td>1</td> <td>PZ</td> </tr> <tr> <td>VI1220A1</td> <td>4,2X12 TCB SELF-TAPPIN G SCREW</td> <td>5</td> <td>PZ</td> </tr> </tbody> </table>	Code	Description	Qty	UOM	GN1327A0	HEATING ELEMENT GASKET	1	PZ	RS1090A1	2,9KW HEATING ELEMENT	1	PZ	SL1045A0	S53 BLACK SILICONE - 80ML CARTRIDGE	1	PZ	VI1220A1	4,2X12 TCB SELF-TAPPIN G SCREW	5	PZ
Code	Description	Qty	UOM																						
GN1327A0	HEATING ELEMENT GASKET	1	PZ																						
RS1090A1	2,9KW HEATING ELEMENT	1	PZ																						
SL1045A0	S53 BLACK SILICONE - 80ML CARTRIDGE	1	PZ																						
VI1220A1	4,2X12 TCB SELF-TAPPIN G SCREW	5	PZ																						





COMPONENT			SPARE PART														
Code	Description	Image	Code	Description	Components list												
RS1090A	2,9KW HEATING ELEMENT		KRS1090A	2.9 KW HEATING ELEMENT KIT	<table border="1"> <thead> <tr> <th>Code</th> <th>Description</th> <th>Qty</th> <th>UOM</th> </tr> </thead> <tbody> <tr> <td>VM1794A0</td> <td>250X4.8 PA66 BLACK CLAMP</td> <td>2</td> <td>PZ</td> </tr> <tr> <td>VM2103A0</td> <td>CLAMP LOCK</td> <td>2</td> <td>PZ</td> </tr> </tbody> </table>	Code	Description	Qty	UOM	VM1794A0	250X4.8 PA66 BLACK CLAMP	2	PZ	VM2103A0	CLAMP LOCK	2	PZ
Code	Description	Qty	UOM														
VM1794A0	250X4.8 PA66 BLACK CLAMP	2	PZ														
VM2103A0	CLAMP LOCK	2	PZ														
RC1170A	STAINLESS STEEL NUT M14 H=8 CH=22		KRC1170A	M14 H8 CH22 NUT - 10 PCS. KIT	<table border="1"> <thead> <tr> <th>Code</th> <th>Description</th> <th>Qty</th> <th>UOM</th> </tr> </thead> <tbody> <tr> <td>RC1170A1</td> <td>STAINLESS STEEL NUT M14 H=8 CH=2</td> <td>10</td> <td>PZ</td> </tr> </tbody> </table>	Code	Description	Qty	UOM	RC1170A1	STAINLESS STEEL NUT M14 H=8 CH=2	10	PZ				
Code	Description	Qty	UOM														
RC1170A1	STAINLESS STEEL NUT M14 H=8 CH=2	10	PZ														
OH1990A	EXTERNAL WATER PIPE + STAINLESS		OH1990A1	EXTERNAL WATER PIPE + STAINLESS													
EL1055A	Ø10 - Ø8 INT. REDUCTION (NEW #PM201008E)		KEL1055A	Ø10-Ø8 INTERMEDIATE REDUCTION 10 PCS KIT	<table border="1"> <thead> <tr> <th>Code</th> <th>Description</th> <th>Qty</th> <th>UOM</th> </tr> </thead> <tbody> <tr> <td>EL1055A0</td> <td>Ø10 - Ø8 INT. REDUCTION (NEW #PM201008E)</td> <td>10</td> <td>PZ</td> </tr> </tbody> </table>	Code	Description	Qty	UOM	EL1055A0	Ø10 - Ø8 INT. REDUCTION (NEW #PM201008E)	10	PZ				
Code	Description	Qty	UOM														
EL1055A0	Ø10 - Ø8 INT. REDUCTION (NEW #PM201008E)	10	PZ														
TB2034A	L.MISS WATER SYSTEM - TB1815A		TB2034A0	L.MISS WATER SYSTEM - TB1815A													

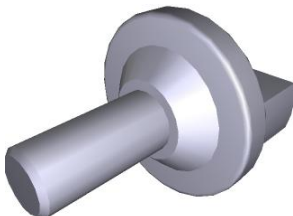

COMPONENT			SPARE PART																		
Code	Description	Image	Code	Description	Components list																
TB1098A	XFT200 INTERNAL WATER PIPE		TB1098A0	XFT200 INTERNAL WATER PIPE																	
TB2121A	LINE MISS 800 EXHAUST CHIMNEY Ø30X1		TB2121A0	LINE MISS 800 EXHAUST CHIMNEY Ø30X1																	
0H1455A	MUFFLE SUPPORT BRACKET		0H1455A2	MUFFLE SUPPORT BRACKET																	
GRL1025A	RIGHT/LEFT LAT.GRID CHROMIUM-PLATED		KGRL1025A	LINEMISS ROSSELLA 4X60X40 LAT. GRIDS KIT	<table border="1"> <thead> <tr> <th>Code</th> <th>Description</th> <th>Qty</th> <th>UOM</th> </tr> </thead> <tbody> <tr> <td>GRL1025A1</td> <td>RIGHT/LEFT LAT.GRID CHROMIUM-PLATED</td> <td>2</td> <td>PZ</td> </tr> <tr> <td>IP1508A0</td> <td></td> <td>2</td> <td>PZ</td> </tr> <tr> <td>VM1059A1</td> <td></td> <td>1.500</td> <td>M</td> </tr> </tbody> </table>	Code	Description	Qty	UOM	GRL1025A1	RIGHT/LEFT LAT.GRID CHROMIUM-PLATED	2	PZ	IP1508A0		2	PZ	VM1059A1		1.500	M
Code	Description	Qty	UOM																		
GRL1025A1	RIGHT/LEFT LAT.GRID CHROMIUM-PLATED	2	PZ																		
IP1508A0		2	PZ																		
VM1059A1		1.500	M																		
VM1815A	LATERAL SUPPORTS FIXING BOLT		KVM1815A	L.MISS/L.MICRO/S.4/ S.3 10 PAWLS KIT	<table border="1"> <thead> <tr> <th>Code</th> <th>Description</th> <th>Qty</th> <th>UOM</th> </tr> </thead> <tbody> <tr> <td>VM1815A0</td> <td>LATERAL SUPPORTS FIXING BOLT</td> <td>10</td> <td>PZ</td> </tr> </tbody> </table>	Code	Description	Qty	UOM	VM1815A0	LATERAL SUPPORTS FIXING BOLT	10	PZ								
Code	Description	Qty	UOM																		
VM1815A0	LATERAL SUPPORTS FIXING BOLT	10	PZ																		



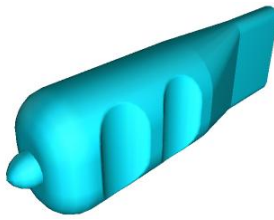

COMPONENT			SPARE PART																						
Code	Description	Image	Code	Description	Components list																				
GN1065A	LAMP GLASS COVER WHITE SEAL		KVE1005A	LIGHT BULB + SEALING KIT	<table border="1"> <thead> <tr> <th>Code</th> <th>Description</th> <th>Qty</th> <th>UOM</th> </tr> </thead> <tbody> <tr> <td>GN1065A1</td> <td>LAMP GLASS COVER WHITE SEAL</td> <td>1</td> <td>PZ</td> </tr> <tr> <td>VE1005A3</td> <td>25W HALOPIN LAMP</td> <td>1</td> <td>PZ</td> </tr> </tbody> </table>	Code	Description	Qty	UOM	GN1065A1	LAMP GLASS COVER WHITE SEAL	1	PZ	VE1005A3	25W HALOPIN LAMP	1	PZ								
			Code	Description	Qty	UOM																			
GN1065A1	LAMP GLASS COVER WHITE SEAL	1	PZ																						
VE1005A3	25W HALOPIN LAMP	1	PZ																						
KGN1065A	LAMP GLASS COVER SEAL + RED O-RING KIT	<table border="1"> <thead> <tr> <th>Code</th> <th>Description</th> <th>Qty</th> <th>UOM</th> </tr> </thead> <tbody> <tr> <td>GN1055A0</td> <td>46X2 RED O-RING LAMP GLASS COVER SEAL</td> <td>1</td> <td>PZ</td> </tr> <tr> <td>GN1065A1</td> <td>LAMP GLASS COVER WHITE SEAL</td> <td>1</td> <td>PZ</td> </tr> </tbody> </table>	Code	Description	Qty	UOM	GN1055A0	46X2 RED O-RING LAMP GLASS COVER SEAL	1	PZ	GN1065A1	LAMP GLASS COVER WHITE SEAL	1	PZ											
Code	Description	Qty	UOM																						
GN1055A0	46X2 RED O-RING LAMP GLASS COVER SEAL	1	PZ																						
GN1065A1	LAMP GLASS COVER WHITE SEAL	1	PZ																						
VT1195A	BOROSILICATE LIGHT BULB GLASS COVER		KVT1195A	LIGHT BULB + GLASS COVER + SEALING KIT	<table border="1"> <thead> <tr> <th>Code</th> <th>Description</th> <th>Qty</th> <th>UOM</th> </tr> </thead> <tbody> <tr> <td>GN1055A0</td> <td>46X2 RED O-RING LAMP GLASS COVER SEAL</td> <td>1</td> <td>PZ</td> </tr> <tr> <td>GN1065A1</td> <td>LAMP GLASS COVER WHITE SEAL</td> <td>1</td> <td>PZ</td> </tr> <tr> <td>VE1005A3</td> <td>25W HALOPIN LAMP</td> <td>1</td> <td>PZ</td> </tr> <tr> <td>VT1195A0</td> <td>BOROSILICAT E LIGHT BULB GLASS COVER</td> <td>1</td> <td>PZ</td> </tr> </tbody> </table>	Code	Description	Qty	UOM	GN1055A0	46X2 RED O-RING LAMP GLASS COVER SEAL	1	PZ	GN1065A1	LAMP GLASS COVER WHITE SEAL	1	PZ	VE1005A3	25W HALOPIN LAMP	1	PZ	VT1195A0	BOROSILICAT E LIGHT BULB GLASS COVER	1	PZ
			Code	Description	Qty	UOM																			
			GN1055A0	46X2 RED O-RING LAMP GLASS COVER SEAL	1	PZ																			
			GN1065A1	LAMP GLASS COVER WHITE SEAL	1	PZ																			
VE1005A3	25W HALOPIN LAMP	1	PZ																						
VT1195A0	BOROSILICAT E LIGHT BULB GLASS COVER	1	PZ																						
VE1015A	LAMP HOLDER SERIE 2 FOR HALOGEN LAMP		KVE1015A	LAMP HOLDER KIT FOR HALOGEN LAM	<table border="1"> <thead> <tr> <th>Code</th> <th>Description</th> <th>Qty</th> <th>UOM</th> </tr> </thead> <tbody> <tr> <td>VE1015A1</td> <td>LAMP HOLDER SERIE 2 FOR HALOGEN LAMP</td> <td>1</td> <td>PZ</td> </tr> </tbody> </table>	Code	Description	Qty	UOM	VE1015A1	LAMP HOLDER SERIE 2 FOR HALOGEN LAMP	1	PZ												
Code	Description	Qty	UOM																						
VE1015A1	LAMP HOLDER SERIE 2 FOR HALOGEN LAMP	1	PZ																						
VE1005A	25W HALOPIN LAMP		KVE1005A	LIGHT BULB + SEALING KIT	<table border="1"> <thead> <tr> <th>Code</th> <th>Description</th> <th>Qty</th> <th>UOM</th> </tr> </thead> <tbody> <tr> <td>GN1055A0</td> <td>46X2 RED O-RING LAMP GLASS COVER SEAL</td> <td>1</td> <td>PZ</td> </tr> <tr> <td>GN1065A1</td> <td>LAMP GLASS COVER WHITE SEAL</td> <td>1</td> <td>PZ</td> </tr> <tr> <td>VE1005A3</td> <td>25W HALOPIN LAMP</td> <td>1</td> <td>PZ</td> </tr> </tbody> </table>	Code	Description	Qty	UOM	GN1055A0	46X2 RED O-RING LAMP GLASS COVER SEAL	1	PZ	GN1065A1	LAMP GLASS COVER WHITE SEAL	1	PZ	VE1005A3	25W HALOPIN LAMP	1	PZ				
			Code	Description	Qty	UOM																			
			GN1055A0	46X2 RED O-RING LAMP GLASS COVER SEAL	1	PZ																			
GN1065A1	LAMP GLASS COVER WHITE SEAL	1	PZ																						
VE1005A3	25W HALOPIN LAMP	1	PZ																						



COMPONENT			SPARE PART										
Code	Description	Image	Code	Description	Components list								
GN1354A	LINEMISS ROSSELLA DOOR GASKET - GN1110A		KG1354A	LINEMISS ROSSELLA DOOR SEAL KIT	<table border="1"> <thead> <tr> <th>Code</th> <th>Description</th> <th>Qty</th> <th>UOM</th> </tr> </thead> <tbody> <tr> <td>GN1110A2</td> <td>LINE MISS/XVC105- 055/XK/XL DOOR GASKE</td> <td>1.890</td> <td>M</td> </tr> </tbody> </table>	Code	Description	Qty	UOM	GN1110A2	LINE MISS/XVC105- 055/XK/XL DOOR GASKE	1.890	M
			Code	Description	Qty	UOM							
GN1110A2	LINE MISS/XVC105- 055/XK/XL DOOR GASKE	1.890	M										
KG0010A	2,5M GN1007A DOOR SEAL KIT	<table border="1"> <thead> <tr> <th>Code</th> <th>Description</th> <th>Qty</th> <th>UOM</th> </tr> </thead> <tbody> <tr> <td>GN1110A2</td> <td>LINE MISS/XVC105- 055/XK/XL DOOR GASKE</td> <td>2.500</td> <td>M</td> </tr> </tbody> </table>	Code	Description	Qty	UOM	GN1110A2	LINE MISS/XVC105- 055/XK/XL DOOR GASKE	2.500	M			
Code	Description	Qty	UOM										
GN1110A2	LINE MISS/XVC105- 055/XK/XL DOOR GASKE	2.500	M										



**ASM2013D/0.D00 - External cover**

**FRONT**

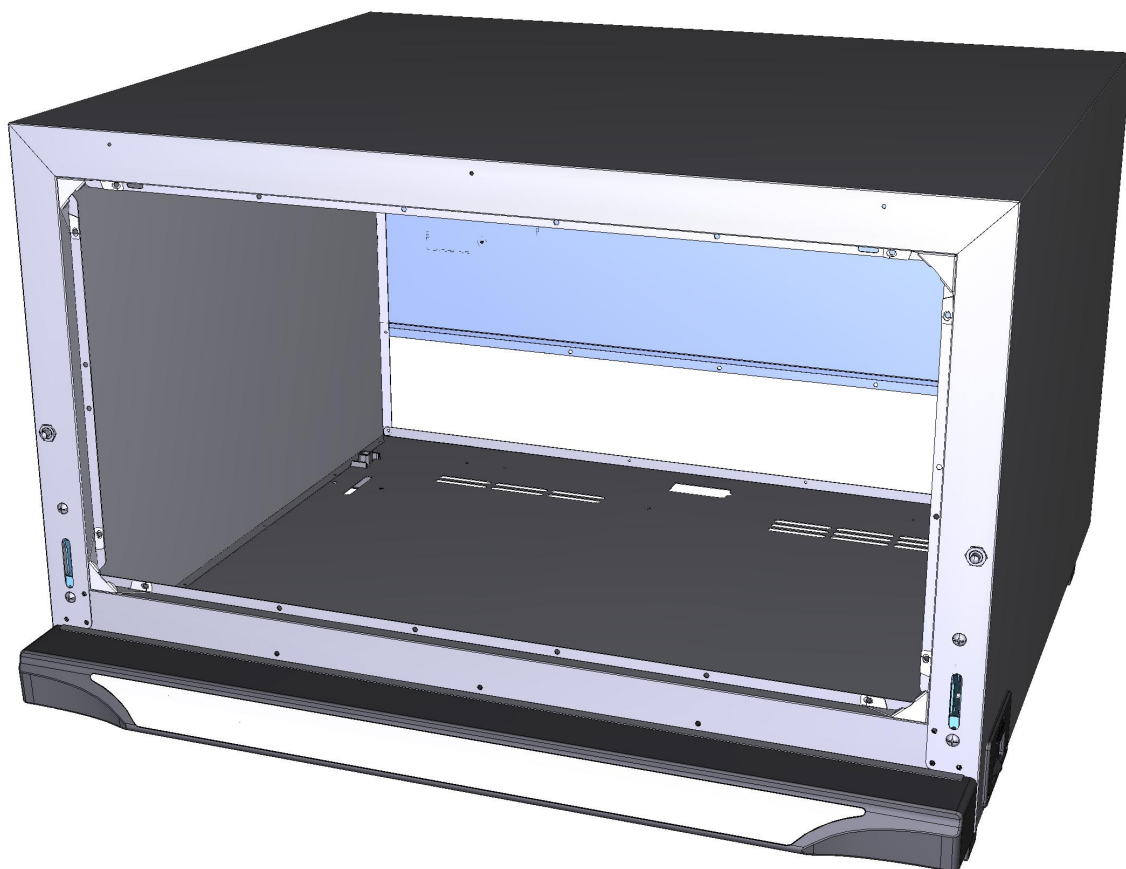

**ASM2013D/0.D00 - External cover**





**REAR**



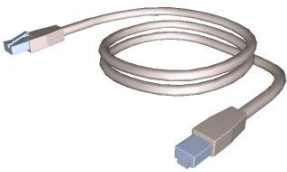

COMPONENT			SPARE PART																														
Code	Description	Image	Code	Description	Components list																												
VM1951A	IP CHIMNEY COVER		KVM1065A	LINE MISS EXHAUST CHIMNEY COVER	<table border="1"> <thead> <tr> <th>Code</th> <th>Description</th> <th>Qty</th> <th>UOM</th> </tr> </thead> <tbody> <tr> <td>VM1065A0</td> <td>L.M. EXHAUST CHIMNEY COVER</td> <td>1</td> <td>PZ</td> </tr> </tbody> </table>	Code	Description	Qty	UOM	VM1065A0	L.M. EXHAUST CHIMNEY COVER	1	PZ																				
Code	Description	Qty	UOM																														
VM1065A0	L.M. EXHAUST CHIMNEY COVER	1	PZ																														
VN1165A	230VAC 50/60HZ COOLING DOWN FA		KVN1165A	COOLING DOWN FAN KIT	<table border="1"> <thead> <tr> <th>Code</th> <th>Description</th> <th>Qty</th> <th>UOM</th> </tr> </thead> <tbody> <tr> <td>V11099A0</td> <td></td> <td>4</td> <td>PZ</td> </tr> <tr> <td>VM1555A2</td> <td></td> <td>1</td> <td>PZ</td> </tr> <tr> <td>VN1165A0</td> <td>230VAC 50/60HZ COOLING DOWN FAN</td> <td>1</td> <td>PZ</td> </tr> </tbody> </table>	Code	Description	Qty	UOM	V11099A0		4	PZ	VM1555A2		1	PZ	VN1165A0	230VAC 50/60HZ COOLING DOWN FAN	1	PZ												
Code	Description	Qty	UOM																														
V11099A0		4	PZ																														
VM1555A2		1	PZ																														
VN1165A0	230VAC 50/60HZ COOLING DOWN FAN	1	PZ																														
VM1556A	XBC-XVC COOLING FAN GUARD		KVM1556A	XBC-XVC COOLING FAN GUARD KIT	<table border="1"> <thead> <tr> <th>Code</th> <th>Description</th> <th>Qty</th> <th>UOM</th> </tr> </thead> <tbody> <tr> <td>VM1556A0</td> <td>XBC-XVC COOLING FAN GUARD</td> <td>1</td> <td>PZ</td> </tr> </tbody> </table>	Code	Description	Qty	UOM	VM1556A0	XBC-XVC COOLING FAN GUARD	1	PZ																				
Code	Description	Qty	UOM																														
VM1556A0	XBC-XVC COOLING FAN GUARD	1	PZ																														
VM2188B	LMISSTOUCH60X40 DYNAMIC COMPLETE CONTROL		KVM2188B	LM800 DYNAMIC COMPLETE CONTROL BOARD KIT	<table border="1"> <thead> <tr> <th>Code</th> <th>Description</th> <th>Qty</th> <th>UOM</th> </tr> </thead> <tbody> <tr> <td>MS1013A1</td> <td>L.MISS TOUCH DYN. CONTROL BOARD STICKER</td> <td>1</td> <td>PZ</td> </tr> <tr> <td>PE1980B0</td> <td>LINE MISS TOUCH CONTROL BOARD</td> <td>1</td> <td>PZ</td> </tr> <tr> <td>V11635A0</td> <td>M4X8 ZINC PLATED FLAT HEAD SCREW</td> <td>1</td> <td>PZ</td> </tr> <tr> <td>VM1794A0</td> <td>250X4.8 PA66 BLACK CLAMP</td> <td>2</td> <td>PZ</td> </tr> <tr> <td>VM2017A0</td> <td>600X400 LINEMISS DYNAMIC CONTROL BOARD</td> <td>1</td> <td>PZ</td> </tr> <tr> <td>VM2103A0</td> <td>CLAMP LOCK</td> <td>2</td> <td>PZ</td> </tr> </tbody> </table>	Code	Description	Qty	UOM	MS1013A1	L.MISS TOUCH DYN. CONTROL BOARD STICKER	1	PZ	PE1980B0	LINE MISS TOUCH CONTROL BOARD	1	PZ	V11635A0	M4X8 ZINC PLATED FLAT HEAD SCREW	1	PZ	VM1794A0	250X4.8 PA66 BLACK CLAMP	2	PZ	VM2017A0	600X400 LINEMISS DYNAMIC CONTROL BOARD	1	PZ	VM2103A0	CLAMP LOCK	2	PZ
Code	Description	Qty	UOM																														
MS1013A1	L.MISS TOUCH DYN. CONTROL BOARD STICKER	1	PZ																														
PE1980B0	LINE MISS TOUCH CONTROL BOARD	1	PZ																														
V11635A0	M4X8 ZINC PLATED FLAT HEAD SCREW	1	PZ																														
VM1794A0	250X4.8 PA66 BLACK CLAMP	2	PZ																														
VM2017A0	600X400 LINEMISS DYNAMIC CONTROL BOARD	1	PZ																														
VM2103A0	CLAMP LOCK	2	PZ																														

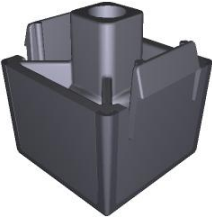



COMPONENT			SPARE PART																						
Code	Description	Image	Code	Description	Components list																				
CE1305A	L=2MT RJ45 - RJ45 CABLE		KCE1305A	RJ45 - RJ45 L=2MT CABLE KIT	<table border="1"> <thead> <tr> <th>Code</th> <th>Description</th> <th>Qty</th> <th>UOM</th> </tr> </thead> <tbody> <tr> <td>CE1305A0</td> <td>L=2MT RJ45 - RJ45 CABLE</td> <td>1</td> <td>PZ</td> </tr> </tbody> </table>	Code	Description	Qty	UOM	CE1305A0	L=2MT RJ45 - RJ45 CABLE	1	PZ												
Code	Description	Qty	UOM																						
CE1305A0	L=2MT RJ45 - RJ45 CABLE	1	PZ																						
0H1450A	XB-XV-XG ST. STEEL MUFFLE FRONT CORNER		0H1450A0	XB-XV-XG ST. STEEL MUFFLE FRONT CORNER																					
PD1001A	35X35 H26 GREY PLASTIC+RUBBER FOOT		KPD1001A	4 PCS. 35X35 H26 FEET KIT	<table border="1"> <thead> <tr> <th>Code</th> <th>Description</th> <th>Qty</th> <th>UOM</th> </tr> </thead> <tbody> <tr> <td>PD1001A0</td> <td>35X35 H26 GREY PLASTIC+RUBBER FOOT</td> <td>4</td> <td>PZ</td> </tr> </tbody> </table>	Code	Description	Qty	UOM	PD1001A0	35X35 H26 GREY PLASTIC+RUBBER FOOT	4	PZ												
Code	Description	Qty	UOM																						
PD1001A0	35X35 H26 GREY PLASTIC+RUBBER FOOT	4	PZ																						
PE2012A	LINE MISS RJ45 UNOXLINK CONNECTING POIN		KPE2012A	LINEMISS RJ45 UNOX.LINK KIT	<table border="1"> <thead> <tr> <th>Code</th> <th>Description</th> <th>Qty</th> <th>UOM</th> </tr> </thead> <tbody> <tr> <td>PE2012A0</td> <td>LINE MISS RJ45 UNOXLINK CONNECTING POINT</td> <td>1</td> <td>PZ</td> </tr> <tr> <td>VI1960A0</td> <td></td> <td>4</td> <td>PZ</td> </tr> </tbody> </table>	Code	Description	Qty	UOM	PE2012A0	LINE MISS RJ45 UNOXLINK CONNECTING POINT	1	PZ	VI1960A0		4	PZ								
Code	Description	Qty	UOM																						
PE2012A0	LINE MISS RJ45 UNOXLINK CONNECTING POINT	1	PZ																						
VI1960A0		4	PZ																						
CE1012A	L= 1MT RJ45 CABLE		KVM2190A	LINEMISS 46X33 HAUBIS CONTROL BOARD KIT	<table border="1"> <thead> <tr> <th>Code</th> <th>Description</th> <th>Qty</th> <th>UOM</th> </tr> </thead> <tbody> <tr> <td>MS1014A1</td> <td>L.M. TOUCH DYNAMIC CONTROL BOARD STICKER</td> <td>1</td> <td>PZ</td> </tr> <tr> <td>PE2018B0</td> <td>LMISS TOUCH CONTROL BOARD</td> <td>1</td> <td>PZ</td> </tr> <tr> <td>VI1635A0</td> <td>M4X8 ZINC PLATED FLAT HEAD SCREW</td> <td>5</td> <td>PZ</td> </tr> <tr> <td>VM1794A0</td> <td>250X4.8 PA66 BLACK CLAMP</td> <td>2</td> <td>PZ</td> </tr> </tbody> </table>	Code	Description	Qty	UOM	MS1014A1	L.M. TOUCH DYNAMIC CONTROL BOARD STICKER	1	PZ	PE2018B0	LMISS TOUCH CONTROL BOARD	1	PZ	VI1635A0	M4X8 ZINC PLATED FLAT HEAD SCREW	5	PZ	VM1794A0	250X4.8 PA66 BLACK CLAMP	2	PZ
Code	Description	Qty	UOM																						
MS1014A1	L.M. TOUCH DYNAMIC CONTROL BOARD STICKER	1	PZ																						
PE2018B0	LMISS TOUCH CONTROL BOARD	1	PZ																						
VI1635A0	M4X8 ZINC PLATED FLAT HEAD SCREW	5	PZ																						
VM1794A0	250X4.8 PA66 BLACK CLAMP	2	PZ																						







COMPONENT			SPARE PART																															
Code	Description	Image	Code	Description	Components list																													
CE1012A	L= 1MT RJ45 CABLE		KVM2190A	LINEMISS 46X33 HAUBIS CONTROL BOARD KIT	<table border="1"> <thead> <tr> <th>Code</th> <th>Description</th> <th>Qty</th> <th>UOM</th> </tr> </thead> <tbody> <tr> <td>VM2016A0</td> <td>L.MISS TOUCH 46X33 DYNAMIC CONTROL BOARD</td> <td>1</td> <td>PZ</td> </tr> <tr> <td>VM2103A0</td> <td>CLAMP LOCK</td> <td>2</td> <td>PZ</td> </tr> </tbody> </table>	Code	Description	Qty	UOM	VM2016A0	L.MISS TOUCH 46X33 DYNAMIC CONTROL BOARD	1	PZ	VM2103A0	CLAMP LOCK	2	PZ																	
			Code	Description	Qty	UOM																												
			VM2016A0	L.MISS TOUCH 46X33 DYNAMIC CONTROL BOARD	1	PZ																												
VM2103A0	CLAMP LOCK	2	PZ																															
KVM2186A	LMISS 46X33 MATIC-TOP CONTROL BOARD KIT	<table border="1"> <thead> <tr> <th>Code</th> <th>Description</th> <th>Qty</th> <th>UOM</th> </tr> </thead> <tbody> <tr> <td>CE1012A0</td> <td>L= 1MT RJ45 CABLE</td> <td>1</td> <td>PZ</td> </tr> <tr> <td>MS1014A0</td> <td>L.MISS TOUCH MATIC CONTROL BOARD STICKER</td> <td>1</td> <td>PZ</td> </tr> <tr> <td>PE1980B0</td> <td>LINE MISS TOUCH CONTROL BOARD</td> <td>1</td> <td>PZ</td> </tr> <tr> <td>VI1635A0</td> <td>M4X8 ZINC PLATED FLAT HEAD SCREW</td> <td>5</td> <td>PZ</td> </tr> <tr> <td>VM1794A0</td> <td>250X4.8 PA66 BLACK CLAMP</td> <td>2</td> <td>PZ</td> </tr> <tr> <td>VM2016A0</td> <td>L.MISS TOUCH 46X33 DYNAMIC CONTROL BOARD</td> <td>1</td> <td>PZ</td> </tr> <tr> <td>VM2103A0</td> <td>CLAMP LOCK</td> <td>2</td> <td>PZ</td> </tr> </tbody> </table>	Code	Description	Qty	UOM	CE1012A0	L= 1MT RJ45 CABLE	1	PZ	MS1014A0	L.MISS TOUCH MATIC CONTROL BOARD STICKER	1	PZ	PE1980B0	LINE MISS TOUCH CONTROL BOARD	1	PZ	VI1635A0	M4X8 ZINC PLATED FLAT HEAD SCREW	5	PZ	VM1794A0	250X4.8 PA66 BLACK CLAMP	2	PZ	VM2016A0	L.MISS TOUCH 46X33 DYNAMIC CONTROL BOARD	1	PZ	VM2103A0	CLAMP LOCK	2	PZ
Code	Description	Qty	UOM																															
CE1012A0	L= 1MT RJ45 CABLE	1	PZ																															
MS1014A0	L.MISS TOUCH MATIC CONTROL BOARD STICKER	1	PZ																															
PE1980B0	LINE MISS TOUCH CONTROL BOARD	1	PZ																															
VI1635A0	M4X8 ZINC PLATED FLAT HEAD SCREW	5	PZ																															
VM1794A0	250X4.8 PA66 BLACK CLAMP	2	PZ																															
VM2016A0	L.MISS TOUCH 46X33 DYNAMIC CONTROL BOARD	1	PZ																															
VM2103A0	CLAMP LOCK	2	PZ																															
KVM2185A	LMISS 46X33 DYNAMIC CONTROL BOARD KIT	<table border="1"> <thead> <tr> <th>Code</th> <th>Description</th> <th>Qty</th> <th>UOM</th> </tr> </thead> <tbody> <tr> <td>CE1012A0</td> <td>L= 1MT RJ45 CABLE</td> <td>1</td> <td>PZ</td> </tr> <tr> <td>MS1012A0</td> <td>L.MISS TOUCH DYN. CONTROL BOARD STICKER</td> <td>1</td> <td>PZ</td> </tr> <tr> <td>PE1980B0</td> <td>LINE MISS TOUCH CONTROL BOARD</td> <td>1</td> <td>PZ</td> </tr> <tr> <td>VI1635A0</td> <td>M4X8 ZINC PLATED FLAT HEAD SCREW</td> <td>5</td> <td>PZ</td> </tr> <tr> <td>VM1794A0</td> <td>250X4.8 PA66 BLACK CLAMP</td> <td>2</td> <td>PZ</td> </tr> <tr> <td>VM2016A0</td> <td>L.MISS TOUCH 46X33 DYNAMIC CONTROL BOARD</td> <td>1</td> <td>PZ</td> </tr> <tr> <td>VM2103A0</td> <td>CLAMP LOCK</td> <td>2</td> <td>PZ</td> </tr> </tbody> </table>	Code	Description	Qty	UOM	CE1012A0	L= 1MT RJ45 CABLE	1	PZ	MS1012A0	L.MISS TOUCH DYN. CONTROL BOARD STICKER	1	PZ	PE1980B0	LINE MISS TOUCH CONTROL BOARD	1	PZ	VI1635A0	M4X8 ZINC PLATED FLAT HEAD SCREW	5	PZ	VM1794A0	250X4.8 PA66 BLACK CLAMP	2	PZ	VM2016A0	L.MISS TOUCH 46X33 DYNAMIC CONTROL BOARD	1	PZ	VM2103A0	CLAMP LOCK	2	PZ
Code	Description	Qty	UOM																															
CE1012A0	L= 1MT RJ45 CABLE	1	PZ																															
MS1012A0	L.MISS TOUCH DYN. CONTROL BOARD STICKER	1	PZ																															
PE1980B0	LINE MISS TOUCH CONTROL BOARD	1	PZ																															
VI1635A0	M4X8 ZINC PLATED FLAT HEAD SCREW	5	PZ																															
VM1794A0	250X4.8 PA66 BLACK CLAMP	2	PZ																															
VM2016A0	L.MISS TOUCH 46X33 DYNAMIC CONTROL BOARD	1	PZ																															
VM2103A0	CLAMP LOCK	2	PZ																															



COMPONENT			SPARE PART																																		
Code	Description	Image	Code	Description	Components list																																
CE1012A	L= 1MT RJ45 CABLE		KVM2184A	LINEMISS 46X33 CLASSIC CONTROL BOARD KIT	<table border="1"> <thead> <tr> <th>Code</th> <th>Description</th> <th>Qty</th> <th>UOM</th> </tr> </thead> <tbody> <tr> <td>CE1012A0</td> <td>L= 1MT RJ45 CABLE</td> <td>1</td> <td>PZ</td> </tr> <tr> <td>MS1016A0</td> <td>L.M. TOUCH CLASSIC CONTROL BOARD STICKER</td> <td>1</td> <td>PZ</td> </tr> <tr> <td>PE1980B0</td> <td>LINE MISS TOUCH CONTROL BOARD</td> <td>1</td> <td>PZ</td> </tr> <tr> <td>VI1635A0</td> <td>M4X8 ZINC PLATED FLAT HEAD SCREW</td> <td>5</td> <td>PZ</td> </tr> <tr> <td>VM1794A0</td> <td>250X4.8 PA66 BLACK CLAMP</td> <td>2</td> <td>PZ</td> </tr> <tr> <td>VM2016A0</td> <td>L.MISS TOUCH 46X33 DYNAMIC CONTROL BOARD</td> <td>1</td> <td>PZ</td> </tr> <tr> <td>VM2103A0</td> <td>CLAMP LOCK</td> <td>2</td> <td>PZ</td> </tr> </tbody> </table>	Code	Description	Qty	UOM	CE1012A0	L= 1MT RJ45 CABLE	1	PZ	MS1016A0	L.M. TOUCH CLASSIC CONTROL BOARD STICKER	1	PZ	PE1980B0	LINE MISS TOUCH CONTROL BOARD	1	PZ	VI1635A0	M4X8 ZINC PLATED FLAT HEAD SCREW	5	PZ	VM1794A0	250X4.8 PA66 BLACK CLAMP	2	PZ	VM2016A0	L.MISS TOUCH 46X33 DYNAMIC CONTROL BOARD	1	PZ	VM2103A0	CLAMP LOCK	2	PZ
			Code	Description	Qty	UOM																															
CE1012A0	L= 1MT RJ45 CABLE	1	PZ																																		
MS1016A0	L.M. TOUCH CLASSIC CONTROL BOARD STICKER	1	PZ																																		
PE1980B0	LINE MISS TOUCH CONTROL BOARD	1	PZ																																		
VI1635A0	M4X8 ZINC PLATED FLAT HEAD SCREW	5	PZ																																		
VM1794A0	250X4.8 PA66 BLACK CLAMP	2	PZ																																		
VM2016A0	L.MISS TOUCH 46X33 DYNAMIC CONTROL BOARD	1	PZ																																		
VM2103A0	CLAMP LOCK	2	PZ																																		
KCE1012A	RJ45 CONTROL-POWER CONNECTING	<table border="1"> <thead> <tr> <th>Code</th> <th>Description</th> <th>Qty</th> <th>UOM</th> </tr> </thead> <tbody> <tr> <td>CE1012A0</td> <td>L= 1MT RJ45 CABLE</td> <td>1</td> <td>PZ</td> </tr> </tbody> </table>	Code	Description	Qty	UOM	CE1012A0	L= 1MT RJ45 CABLE	1	PZ																											
Code	Description	Qty	UOM																																		
CE1012A0	L= 1MT RJ45 CABLE	1	PZ																																		
0D1285G	L.MISS ROSSELLA EXTERNAL CHASIN		0D1285G0	CABLE KIT L.MISS ROSSELLA EXTERNAL CHASIN																																	
0E1081D	LM 800 BOTTOM PANEL		0E1081D0	LM 800 BOTTOM PANEL																																	





COMPONENT			SPARE PART														
Code	Description	Image	Code	Description	Components list												
0F1095D	LINEMISS ROSSELLA EXTERNAL BACK PANEL		0F1095D0	LINEMISS ROSSELLA EXTERNAL BACK PANEL													
0D1300B	L.M.800 ST. STEEL FRONT LOWER PROFILE		0D1300B0	L.M.800 ST. STEEL FRONT LOWER PROFILE													
CR1000A	HINGE LATCH L.M.		KCR1000A	LM HINGES LATCH KIT	<table border="1"> <thead> <tr> <th>Code</th> <th>Description</th> <th>Qty</th> <th>UOM</th> </tr> </thead> <tbody> <tr> <td>CR1000A0</td> <td>HINGE LATCH L.M.</td> <td>1</td> <td>PZ</td> </tr> <tr> <td>VI1875A0</td> <td></td> <td>2</td> <td>PZ</td> </tr> </tbody> </table>	Code	Description	Qty	UOM	CR1000A0	HINGE LATCH L.M.	1	PZ	VI1875A0		2	PZ
Code	Description	Qty	UOM														
CR1000A0	HINGE LATCH L.M.	1	PZ														
VI1875A0		2	PZ														
VE1295A	MK 16A 230V DOOR MICROSWITCH		KVE1295A	MK 16A 230V DOOR MICROSWITCH KIT	<table border="1"> <thead> <tr> <th>Code</th> <th>Description</th> <th>Qty</th> <th>UOM</th> </tr> </thead> <tbody> <tr> <td>VE1295A0</td> <td>MK 16A 230V DOOR MICROSWITC</td> <td>1</td> <td>PZ</td> </tr> </tbody> </table>	Code	Description	Qty	UOM	VE1295A0	MK 16A 230V DOOR MICROSWITC	1	PZ				
Code	Description	Qty	UOM														
VE1295A0	MK 16A 230V DOOR MICROSWITC	1	PZ														

**ASM0027B/0.D00 - Door**

**FRONT**

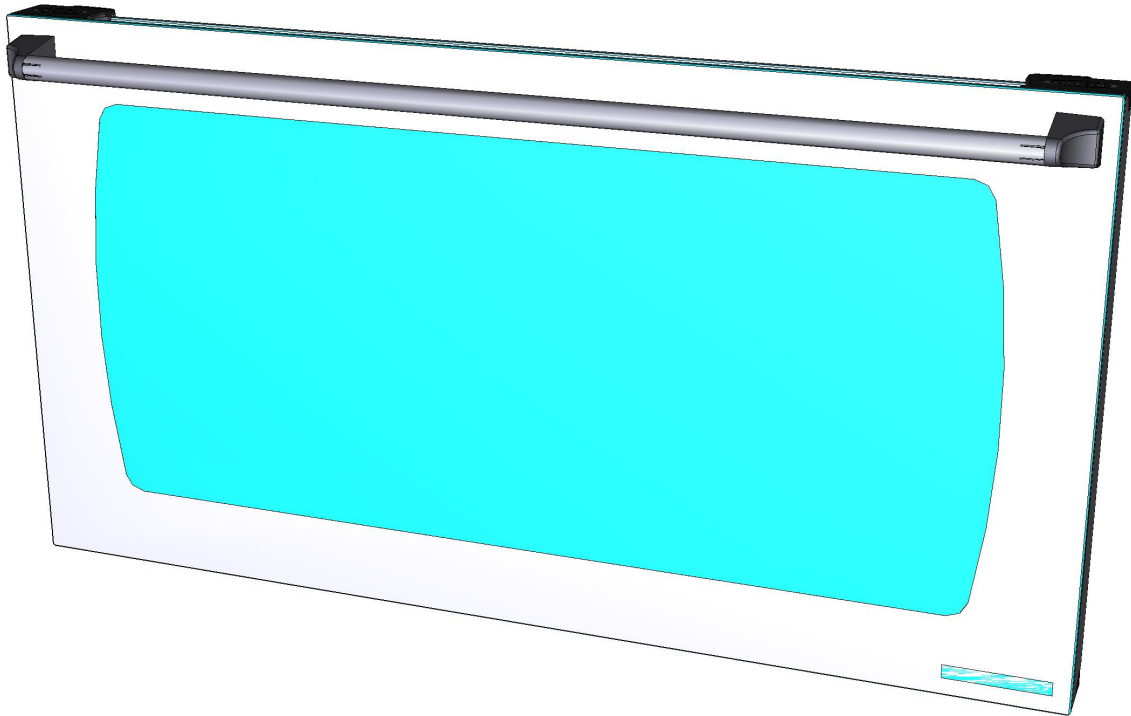

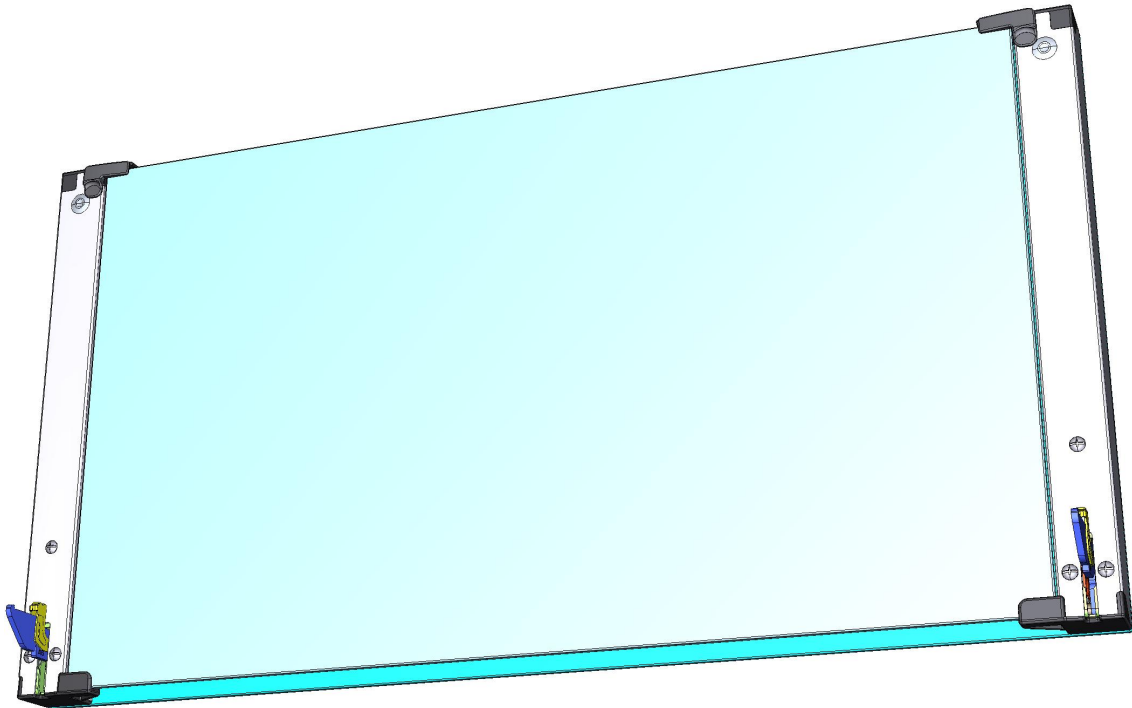

ASM0027B/0.D00 - Door

REAR

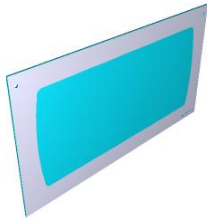

COMPONENT			SPARE PART																														
Code	Description	Image	Code	Description	Components list																												
VT1070B	LINEMISS ROSSELLA INTERNAL GLASS		KVT1070B	L.MISS ROSSELLA INTERNAL GLASS KI	<table border="1"> <thead> <tr> <th>Code</th> <th>Description</th> <th>Qty</th> <th>UOM</th> </tr> </thead> <tbody> <tr> <td>ED1011A0</td> <td></td> <td>1</td> <td>PZ</td> </tr> <tr> <td>ED1235A0</td> <td>INTERNAL GLASS LABEL</td> <td>1</td> <td>PZ</td> </tr> <tr> <td>GN1265A0</td> <td>INTERNAL GLASS SEAL</td> <td>4</td> <td>PZ</td> </tr> <tr> <td>IP1508A0</td> <td></td> <td>1.130</td> <td>PZ</td> </tr> <tr> <td>VM1059A1</td> <td></td> <td>1.700</td> <td>M</td> </tr> <tr> <td>VT1070B0</td> <td>LINEMISS ROSSELLA INTERNAL GLASS</td> <td>1</td> <td>PZ</td> </tr> </tbody> </table>	Code	Description	Qty	UOM	ED1011A0		1	PZ	ED1235A0	INTERNAL GLASS LABEL	1	PZ	GN1265A0	INTERNAL GLASS SEAL	4	PZ	IP1508A0		1.130	PZ	VM1059A1		1.700	M	VT1070B0	LINEMISS ROSSELLA INTERNAL GLASS	1	PZ
					Code	Description	Qty	UOM																									
					ED1011A0		1	PZ																									
					ED1235A0	INTERNAL GLASS LABEL	1	PZ																									
					GN1265A0	INTERNAL GLASS SEAL	4	PZ																									
					IP1508A0		1.130	PZ																									
					VM1059A1		1.700	M																									
VT1070B0	LINEMISS ROSSELLA INTERNAL GLASS	1	PZ																														
VM1025A	Ø16 GREY NYLON LI		KVM1025A	20 GREY NYLON CAPS KIT	<table border="1"> <thead> <tr> <th>Code</th> <th>Description</th> <th>Qty</th> <th>UOM</th> </tr> </thead> <tbody> <tr> <td>VM1025A0</td> <td>Ø16 GREY NYLON LID</td> <td>20</td> <td>PZ</td> </tr> </tbody> </table>	Code	Description	Qty	UOM	VM1025A0	Ø16 GREY NYLON LID	20	PZ																				
					Code	Description	Qty	UOM																									
VM1025A0	Ø16 GREY NYLON LID	20	PZ																														
MG1015B	L.MISS/L.MICRO/CH EFTOP HANDLE END		KMG1015B	2 PCS. HANDLE END KIT	<table border="1"> <thead> <tr> <th>Code</th> <th>Description</th> <th>Qty</th> <th>UOM</th> </tr> </thead> <tbody> <tr> <td>MG1015B0</td> <td>L.MISS/L.MICR O/CHEFTOP HANDLE END</td> <td>2</td> <td>PZ</td> </tr> <tr> <td>VI1855A0</td> <td>5X25 SELF-TAPPIN G SCREW</td> <td>2</td> <td>PZ</td> </tr> <tr> <td>VI1870A0</td> <td>50X50 SELF-THREADI NG SCREW FOR PLASTIC</td> <td>2</td> <td>PZ</td> </tr> <tr> <td>VM1025A0</td> <td>Ø16 GREY NYLON LID</td> <td>2</td> <td>PZ</td> </tr> </tbody> </table>	Code	Description	Qty	UOM	MG1015B0	L.MISS/L.MICR O/CHEFTOP HANDLE END	2	PZ	VI1855A0	5X25 SELF-TAPPIN G SCREW	2	PZ	VI1870A0	50X50 SELF-THREADI NG SCREW FOR PLASTIC	2	PZ	VM1025A0	Ø16 GREY NYLON LID	2	PZ								
					Code	Description	Qty	UOM																									
					MG1015B0	L.MISS/L.MICR O/CHEFTOP HANDLE END	2	PZ																									
					VI1855A0	5X25 SELF-TAPPIN G SCREW	2	PZ																									
					VI1870A0	50X50 SELF-THREADI NG SCREW FOR PLASTIC	2	PZ																									
VM1025A0	Ø16 GREY NYLON LID	2	PZ																														
VI1855A	5X25 SELF-TAPPING SCREW		KVI1855A	5X25 SELF-TAPPING SCREW 20 PCS. KIT	<table border="1"> <thead> <tr> <th>Code</th> <th>Description</th> <th>Qty</th> <th>UOM</th> </tr> </thead> <tbody> <tr> <td>VI1855A0</td> <td>5X25 SELF-TAPPIN G SCREW</td> <td>20</td> <td>PZ</td> </tr> </tbody> </table>	Code	Description	Qty	UOM	VI1855A0	5X25 SELF-TAPPIN G SCREW	20	PZ																				
					Code	Description	Qty	UOM																									
VI1855A0	5X25 SELF-TAPPIN G SCREW	20	PZ																														

COMPONENT			SPARE PART																																																																			
Code	Description	Image	Code	Description	Components list																																																																	
VT1072A	LINEMISS ROSSELLA BLACK EXTERNAL GLASS		KVT1072A	L.M. ROSSELLA BLACK EXTERNAL GLASS KIT	<table border="1"> <thead> <tr> <th>Code</th> <th>Description</th> <th>Qty</th> <th>UOM</th> </tr> </thead> <tbody> <tr> <td>IP1385A1</td> <td></td> <td>0.960</td> <td>M</td> </tr> <tr> <td>IP1508A0</td> <td></td> <td>1.280</td> <td>PZ</td> </tr> <tr> <td>RC1200A0</td> <td>ED=4 WIRE D.=0.5 COMPRESSIO N SPRING</td> <td>2</td> <td>PZ</td> </tr> <tr> <td>SL1050A1</td> <td>3M TRANSFER ADHESIVE TAPE</td> <td>0.820</td> <td>M</td> </tr> <tr> <td>TB2301A0</td> <td></td> <td>2</td> <td>PZ</td> </tr> <tr> <td>VM1025A0</td> <td>Ø16 GREY NYLON LID</td> <td>2</td> <td>PZ</td> </tr> <tr> <td>VM1059A1</td> <td></td> <td>1.300</td> <td>M</td> </tr> <tr> <td>VM1695A0</td> <td>HANDLE POSITION PIN</td> <td>2</td> <td>PZ</td> </tr> <tr> <td>VM1916A0</td> <td>RIGHT UPPER COLUMN CAP</td> <td>1</td> <td>PZ</td> </tr> <tr> <td>VM1917A0</td> <td>LEFT UPPER COLUMN CAP</td> <td>1</td> <td>PZ</td> </tr> <tr> <td>VM1918A0</td> <td>RIGHT LOWER COLUMN CAP</td> <td>1</td> <td>PZ</td> </tr> <tr> <td>VM1919A0</td> <td>LEFT LOWER COLUMN CAP</td> <td>1</td> <td>PZ</td> </tr> <tr> <td>VM1920A0</td> <td>INTERNAL GLASS CLOSING RIGHT PLATE</td> <td>1</td> <td>PZ</td> </tr> <tr> <td>VM1921A0</td> <td>INTERNAL GLASS CLOSING LEFT PLATE</td> <td>1</td> <td>PZ</td> </tr> <tr> <td>VT1072A0</td> <td>LINEMISS ROSSELLA BLACK EXTERNAL GLASS</td> <td></td> <td>1</td> <td>PZ</td> </tr> </tbody> </table>	Code	Description	Qty	UOM	IP1385A1		0.960	M	IP1508A0		1.280	PZ	RC1200A0	ED=4 WIRE D.=0.5 COMPRESSIO N SPRING	2	PZ	SL1050A1	3M TRANSFER ADHESIVE TAPE	0.820	M	TB2301A0		2	PZ	VM1025A0	Ø16 GREY NYLON LID	2	PZ	VM1059A1		1.300	M	VM1695A0	HANDLE POSITION PIN	2	PZ	VM1916A0	RIGHT UPPER COLUMN CAP	1	PZ	VM1917A0	LEFT UPPER COLUMN CAP	1	PZ	VM1918A0	RIGHT LOWER COLUMN CAP	1	PZ	VM1919A0	LEFT LOWER COLUMN CAP	1	PZ	VM1920A0	INTERNAL GLASS CLOSING RIGHT PLATE	1	PZ	VM1921A0	INTERNAL GLASS CLOSING LEFT PLATE	1	PZ	VT1072A0	LINEMISS ROSSELLA BLACK EXTERNAL GLASS		1	PZ
Code	Description	Qty	UOM																																																																			
IP1385A1		0.960	M																																																																			
IP1508A0		1.280	PZ																																																																			
RC1200A0	ED=4 WIRE D.=0.5 COMPRESSIO N SPRING	2	PZ																																																																			
SL1050A1	3M TRANSFER ADHESIVE TAPE	0.820	M																																																																			
TB2301A0		2	PZ																																																																			
VM1025A0	Ø16 GREY NYLON LID	2	PZ																																																																			
VM1059A1		1.300	M																																																																			
VM1695A0	HANDLE POSITION PIN	2	PZ																																																																			
VM1916A0	RIGHT UPPER COLUMN CAP	1	PZ																																																																			
VM1917A0	LEFT UPPER COLUMN CAP	1	PZ																																																																			
VM1918A0	RIGHT LOWER COLUMN CAP	1	PZ																																																																			
VM1919A0	LEFT LOWER COLUMN CAP	1	PZ																																																																			
VM1920A0	INTERNAL GLASS CLOSING RIGHT PLATE	1	PZ																																																																			
VM1921A0	INTERNAL GLASS CLOSING LEFT PLATE	1	PZ																																																																			
VT1072A0	LINEMISS ROSSELLA BLACK EXTERNAL GLASS		1	PZ																																																																		
CR1050A	XVC105/DECK/ROSS ELLA DOOR HINGE		KCR1050A	XVC105/DECK/ROSS ELLA HINGES KIT	<table border="1"> <thead> <tr> <th>Code</th> <th>Description</th> <th>Qty</th> <th>UOM</th> </tr> </thead> <tbody> <tr> <td>CR1050A1</td> <td>XVC105/DECK/ ROSSELLA DOOR HINGE</td> <td>2</td> <td>PZ</td> </tr> <tr> <td>VI1875A0</td> <td></td> <td>6</td> <td>PZ</td> </tr> </tbody> </table>	Code	Description	Qty	UOM	CR1050A1	XVC105/DECK/ ROSSELLA DOOR HINGE	2	PZ	VI1875A0		6	PZ																																																					
Code	Description	Qty	UOM																																																																			
CR1050A1	XVC105/DECK/ ROSSELLA DOOR HINGE	2	PZ																																																																			
VI1875A0		6	PZ																																																																			

COMPONENT			SPARE PART																																																										
Code	Description	Image	Code	Description	Components list																																																								
OH1930B	HANDLE TUBE L=718 Ø18X1		K0H1930B	LMISS 800 HANDLE KIT	<table border="1"> <thead> <tr> <th>Code</th> <th>Description</th> <th>Qty</th> <th>UOM</th> </tr> </thead> <tbody> <tr> <td>OH1930B0</td> <td>HANDLE TUBE L= 718 Ø18X1</td> <td>1</td> <td>PZ</td> </tr> <tr> <td>MG1015B0</td> <td>L.MISS/L.MICR O/CHEFTOP HANDLE END</td> <td>2</td> <td>PZ</td> </tr> <tr> <td>VI1855A0</td> <td>5X25 SELF-TAPPIN G SCREW</td> <td>2</td> <td>PZ</td> </tr> <tr> <td>VM1025A0</td> <td>Ø16 GREY NYLON LID</td> <td>2</td> <td>PZ</td> </tr> <tr> <td>VM1794A0</td> <td>250X4.8 PA66 BLACK CLAMP</td> <td>2</td> <td>PZ</td> </tr> <tr> <td>VM2103A0</td> <td>CLAMP LOCK</td> <td>2</td> <td>PZ</td> </tr> </tbody> </table>	Code	Description	Qty	UOM	OH1930B0	HANDLE TUBE L= 718 Ø18X1	1	PZ	MG1015B0	L.MISS/L.MICR O/CHEFTOP HANDLE END	2	PZ	VI1855A0	5X25 SELF-TAPPIN G SCREW	2	PZ	VM1025A0	Ø16 GREY NYLON LID	2	PZ	VM1794A0	250X4.8 PA66 BLACK CLAMP	2	PZ	VM2103A0	CLAMP LOCK	2	PZ																												
					Code	Description	Qty	UOM																																																					
					OH1930B0	HANDLE TUBE L= 718 Ø18X1	1	PZ																																																					
					MG1015B0	L.MISS/L.MICR O/CHEFTOP HANDLE END	2	PZ																																																					
					VI1855A0	5X25 SELF-TAPPIN G SCREW	2	PZ																																																					
					VM1025A0	Ø16 GREY NYLON LID	2	PZ																																																					
					VM1794A0	250X4.8 PA66 BLACK CLAMP	2	PZ																																																					
VM2103A0	CLAMP LOCK	2	PZ																																																										
VM1918A	RIGHT LOWER COLUMN CAP		KVT1253A	ENGEFOOD XF195-EG EXTERNAL GLASS KIT	<table border="1"> <thead> <tr> <th>Code</th> <th>Description</th> <th>Qty</th> <th>UOM</th> </tr> </thead> <tbody> <tr> <td>IP1235B0</td> <td></td> <td>1</td> <td>PZ</td> </tr> <tr> <td>RC1200A0</td> <td>ED=4 WIRE D.=0.5 COMPRESSIO N SPRING</td> <td>2</td> <td>PZ</td> </tr> <tr> <td>SL1050A1</td> <td>3M TRANSFER ADHESIVE TAPE</td> <td>0.820</td> <td>M</td> </tr> <tr> <td>TB2301A0</td> <td></td> <td>2</td> <td>PZ</td> </tr> <tr> <td>VM1025A0</td> <td>Ø16 GREY NYLON LID</td> <td>2</td> <td>PZ</td> </tr> <tr> <td>VM1695A0</td> <td>HANDLE POSITION PIN</td> <td>2</td> <td>PZ</td> </tr> <tr> <td>VM1916A0</td> <td>RIGHT UPPER COLUMN CAP</td> <td>1</td> <td>PZ</td> </tr> <tr> <td>VM1917A0</td> <td>LEFT UPPER COLUMN CAP</td> <td>1</td> <td>PZ</td> </tr> <tr> <td>VM1918A0</td> <td>RIGHT LOWER COLUMN CAP</td> <td>1</td> <td>PZ</td> </tr> <tr> <td>VM1919A0</td> <td>LEFT LOWER COLUMN CAP</td> <td>1</td> <td>PZ</td> </tr> <tr> <td>VM1920A0</td> <td>INTERNAL GLASS CLOSING RIGHT PLATE</td> <td>1</td> <td>PZ</td> </tr> <tr> <td>VM1921A0</td> <td>INTERNAL GLASS CLOSING LEFT PLATE</td> <td>1</td> <td>PZ</td> </tr> <tr> <td>VT1253A0</td> <td>XF195 BLACK EXTERNAL GLASS - ENGEFOOD</td> <td>1</td> <td>PZ</td> </tr> </tbody> </table>	Code	Description	Qty	UOM	IP1235B0		1	PZ	RC1200A0	ED=4 WIRE D.=0.5 COMPRESSIO N SPRING	2	PZ	SL1050A1	3M TRANSFER ADHESIVE TAPE	0.820	M	TB2301A0		2	PZ	VM1025A0	Ø16 GREY NYLON LID	2	PZ	VM1695A0	HANDLE POSITION PIN	2	PZ	VM1916A0	RIGHT UPPER COLUMN CAP	1	PZ	VM1917A0	LEFT UPPER COLUMN CAP	1	PZ	VM1918A0	RIGHT LOWER COLUMN CAP	1	PZ	VM1919A0	LEFT LOWER COLUMN CAP	1	PZ	VM1920A0	INTERNAL GLASS CLOSING RIGHT PLATE	1	PZ	VM1921A0	INTERNAL GLASS CLOSING LEFT PLATE	1	PZ	VT1253A0	XF195 BLACK EXTERNAL GLASS - ENGEFOOD	1	PZ
					Code	Description	Qty	UOM																																																					
					IP1235B0		1	PZ																																																					
					RC1200A0	ED=4 WIRE D.=0.5 COMPRESSIO N SPRING	2	PZ																																																					
					SL1050A1	3M TRANSFER ADHESIVE TAPE	0.820	M																																																					
					TB2301A0		2	PZ																																																					
					VM1025A0	Ø16 GREY NYLON LID	2	PZ																																																					
					VM1695A0	HANDLE POSITION PIN	2	PZ																																																					
					VM1916A0	RIGHT UPPER COLUMN CAP	1	PZ																																																					
					VM1917A0	LEFT UPPER COLUMN CAP	1	PZ																																																					
					VM1918A0	RIGHT LOWER COLUMN CAP	1	PZ																																																					
					VM1919A0	LEFT LOWER COLUMN CAP	1	PZ																																																					
					VM1920A0	INTERNAL GLASS CLOSING RIGHT PLATE	1	PZ																																																					
					VM1921A0	INTERNAL GLASS CLOSING LEFT PLATE	1	PZ																																																					
					VT1253A0	XF195 BLACK EXTERNAL GLASS - ENGEFOOD	1	PZ																																																					
					KVT1072A	L.M.ROSSELLA BLACK EXTERNAL GLASS KIT	<table border="1"> <thead> <tr> <th>Code</th> <th>Description</th> <th>Qty</th> <th>UOM</th> </tr> </thead> <tbody> <tr> <td>IP1385A1</td> <td></td> <td>0.960</td> <td>M</td> </tr> <tr> <td>IP1508A0</td> <td></td> <td>1.280</td> <td>PZ</td> </tr> <tr> <td>RC1200A0</td> <td>ED=4 WIRE D.=0.5 COMPRESSIO N SPRING</td> <td>2</td> <td>PZ</td> </tr> </tbody> </table>	Code	Description	Qty	UOM	IP1385A1		0.960	M	IP1508A0		1.280	PZ	RC1200A0	ED=4 WIRE D.=0.5 COMPRESSIO N SPRING	2	PZ																																						
					Code	Description	Qty	UOM																																																					
					IP1385A1		0.960	M																																																					
					IP1508A0		1.280	PZ																																																					
			RC1200A0	ED=4 WIRE D.=0.5 COMPRESSIO N SPRING	2	PZ																																																							

COMPONENT			SPARE PART																																																						
Code	Description	Image	Code	Description	Components list																																																				
VM1918A	RIGHT LOWER COLUMN CAP		KVT1072A	L.M. ROSSELLA BLACK EXTERNAL GLASS KIT	<table border="1"> <thead> <tr> <th>Code</th> <th>Description</th> <th>Qty</th> <th>UOM</th> </tr> </thead> <tbody> <tr> <td>SL1050A1</td> <td>3M TRANSFER ADHESIVE TAPE</td> <td>0.820</td> <td>M</td> </tr> <tr> <td>TB2301A0</td> <td></td> <td>2</td> <td>PZ</td> </tr> <tr> <td>VM1025A0</td> <td>Ø16 GREY NYLON LID</td> <td>2</td> <td>PZ</td> </tr> <tr> <td>VM1059A1</td> <td></td> <td>1.300</td> <td>M</td> </tr> <tr> <td>VM1695A0</td> <td>HANDLE POSITION PIN</td> <td>2</td> <td>PZ</td> </tr> <tr> <td>VM1916A0</td> <td>RIGHT UPPER COLUMN CAP</td> <td>1</td> <td>PZ</td> </tr> <tr> <td>VM1917A0</td> <td>LEFT UPPER COLUMN CAP</td> <td>1</td> <td>PZ</td> </tr> <tr> <td>VM1918A0</td> <td>RIGHT LOWER COLUMN CAP</td> <td>1</td> <td>PZ</td> </tr> <tr> <td>VM1919A0</td> <td>LEFT LOWER COLUMN CAP</td> <td>1</td> <td>PZ</td> </tr> <tr> <td>VM1920A0</td> <td>INTERNAL GLASS CLOSING RIGHT PLATE</td> <td>1</td> <td>PZ</td> </tr> <tr> <td>VM1921A0</td> <td>INTERNAL GLASS CLOSING LEFT PLATE</td> <td>1</td> <td>PZ</td> </tr> <tr> <td>VT1072A0</td> <td>LINEMISS ROSSELLA BLACK EXTERNAL GLASS</td> <td>1</td> <td>PZ</td> </tr> </tbody> </table>	Code	Description	Qty	UOM	SL1050A1	3M TRANSFER ADHESIVE TAPE	0.820	M	TB2301A0		2	PZ	VM1025A0	Ø16 GREY NYLON LID	2	PZ	VM1059A1		1.300	M	VM1695A0	HANDLE POSITION PIN	2	PZ	VM1916A0	RIGHT UPPER COLUMN CAP	1	PZ	VM1917A0	LEFT UPPER COLUMN CAP	1	PZ	VM1918A0	RIGHT LOWER COLUMN CAP	1	PZ	VM1919A0	LEFT LOWER COLUMN CAP	1	PZ	VM1920A0	INTERNAL GLASS CLOSING RIGHT PLATE	1	PZ	VM1921A0	INTERNAL GLASS CLOSING LEFT PLATE	1	PZ	VT1072A0	LINEMISS ROSSELLA BLACK EXTERNAL GLASS	1	PZ
			Code	Description	Qty	UOM																																																			
SL1050A1	3M TRANSFER ADHESIVE TAPE	0.820	M																																																						
TB2301A0		2	PZ																																																						
VM1025A0	Ø16 GREY NYLON LID	2	PZ																																																						
VM1059A1		1.300	M																																																						
VM1695A0	HANDLE POSITION PIN	2	PZ																																																						
VM1916A0	RIGHT UPPER COLUMN CAP	1	PZ																																																						
VM1917A0	LEFT UPPER COLUMN CAP	1	PZ																																																						
VM1918A0	RIGHT LOWER COLUMN CAP	1	PZ																																																						
VM1919A0	LEFT LOWER COLUMN CAP	1	PZ																																																						
VM1920A0	INTERNAL GLASS CLOSING RIGHT PLATE	1	PZ																																																						
VM1921A0	INTERNAL GLASS CLOSING LEFT PLATE	1	PZ																																																						
VT1072A0	LINEMISS ROSSELLA BLACK EXTERNAL GLASS	1	PZ																																																						
KVT1071A	L.M. ROSSELLA EXTERNAL GLASS KIT	<table border="1"> <thead> <tr> <th>Code</th> <th>Description</th> <th>Qty</th> <th>UOM</th> </tr> </thead> <tbody> <tr> <td>IP1385A1</td> <td></td> <td>0.960</td> <td>M</td> </tr> <tr> <td>IP1508A0</td> <td></td> <td>1.300</td> <td>PZ</td> </tr> <tr> <td>RC1200A0</td> <td>ED=4 WIRE D.=0.5 COMPRESSIO N SPRING</td> <td>2</td> <td>PZ</td> </tr> <tr> <td>SL1050A1</td> <td>3M TRANSFER ADHESIVE TAPE</td> <td>0.820</td> <td>M</td> </tr> <tr> <td>TB2301A0</td> <td></td> <td>2</td> <td>PZ</td> </tr> <tr> <td>VM1025A0</td> <td>Ø16 GREY NYLON LID</td> <td>2</td> <td>PZ</td> </tr> <tr> <td>VM1059A1</td> <td></td> <td>1.350</td> <td>M</td> </tr> <tr> <td>VM1695A0</td> <td>HANDLE POSITION PIN</td> <td>2</td> <td>PZ</td> </tr> <tr> <td>VM1916A0</td> <td>RIGHT UPPER COLUMN CAP</td> <td>1</td> <td>PZ</td> </tr> <tr> <td>VM1917A0</td> <td>LEFT UPPER COLUMN CAP</td> <td>1</td> <td>PZ</td> </tr> <tr> <td>VM1918A0</td> <td>RIGHT LOWER COLUMN CAP</td> <td>1</td> <td>PZ</td> </tr> <tr> <td>VM1919A0</td> <td>LEFT LOWER COLUMN CAP</td> <td>1</td> <td>PZ</td> </tr> </tbody> </table>	Code	Description	Qty	UOM	IP1385A1		0.960	M	IP1508A0		1.300	PZ	RC1200A0	ED=4 WIRE D.=0.5 COMPRESSIO N SPRING	2	PZ	SL1050A1	3M TRANSFER ADHESIVE TAPE	0.820	M	TB2301A0		2	PZ	VM1025A0	Ø16 GREY NYLON LID	2	PZ	VM1059A1		1.350	M	VM1695A0	HANDLE POSITION PIN	2	PZ	VM1916A0	RIGHT UPPER COLUMN CAP	1	PZ	VM1917A0	LEFT UPPER COLUMN CAP	1	PZ	VM1918A0	RIGHT LOWER COLUMN CAP	1	PZ	VM1919A0	LEFT LOWER COLUMN CAP	1	PZ			
Code	Description	Qty	UOM																																																						
IP1385A1		0.960	M																																																						
IP1508A0		1.300	PZ																																																						
RC1200A0	ED=4 WIRE D.=0.5 COMPRESSIO N SPRING	2	PZ																																																						
SL1050A1	3M TRANSFER ADHESIVE TAPE	0.820	M																																																						
TB2301A0		2	PZ																																																						
VM1025A0	Ø16 GREY NYLON LID	2	PZ																																																						
VM1059A1		1.350	M																																																						
VM1695A0	HANDLE POSITION PIN	2	PZ																																																						
VM1916A0	RIGHT UPPER COLUMN CAP	1	PZ																																																						
VM1917A0	LEFT UPPER COLUMN CAP	1	PZ																																																						
VM1918A0	RIGHT LOWER COLUMN CAP	1	PZ																																																						
VM1919A0	LEFT LOWER COLUMN CAP	1	PZ																																																						

COMPONENT			SPARE PART																																																															
Code	Description	Image	Code	Description	Components list																																																													
VM1918A	RIGHT LOWER COLUMN CAP		KVT1071A	L.M. ROSSELLA EXTERNAL GLASS KIT	<table border="1"> <thead> <tr> <th>Code</th> <th>Description</th> <th>Qty</th> <th>UOM</th> </tr> </thead> <tbody> <tr> <td>VM1920A0</td> <td>INTERNAL GLASS CLOSING RIGHT PLATE</td> <td>1</td> <td>PZ</td> </tr> <tr> <td>VM1921A0</td> <td>INTERNAL GLASS CLOSING LEFT PLATE</td> <td>1</td> <td>PZ</td> </tr> <tr> <td>VT1071A2</td> <td></td> <td>1</td> <td>PZ</td> </tr> </tbody> </table>	Code	Description	Qty	UOM	VM1920A0	INTERNAL GLASS CLOSING RIGHT PLATE	1	PZ	VM1921A0	INTERNAL GLASS CLOSING LEFT PLATE	1	PZ	VT1071A2		1	PZ																																													
			Code	Description	Qty	UOM																																																												
VM1920A0	INTERNAL GLASS CLOSING RIGHT PLATE	1	PZ																																																															
VM1921A0	INTERNAL GLASS CLOSING LEFT PLATE	1	PZ																																																															
VT1071A2		1	PZ																																																															
KVT1067A	L.M. ELENA BLACK EXTERNAL GLASS KIT	<table border="1"> <thead> <tr> <th>Code</th> <th>Description</th> <th>Qty</th> <th>UOM</th> </tr> </thead> <tbody> <tr> <td>IP1385A1</td> <td></td> <td>0.800</td> <td>M</td> </tr> <tr> <td>IP1508A0</td> <td></td> <td>1.710</td> <td>PZ</td> </tr> <tr> <td>RC1200A0</td> <td>ED=4 WIRE D.=0.5 COMPRESSIO N SPRING</td> <td>2</td> <td>PZ</td> </tr> <tr> <td>SL1050A1</td> <td>3M TRANSFER ADHESIVE TAPE</td> <td>0.660</td> <td>M</td> </tr> <tr> <td>TB2306A0</td> <td>LMISS STEFANIA/ELE NA DOOR RIGHT COLUM</td> <td>2</td> <td>PZ</td> </tr> <tr> <td>VM1025A0</td> <td>Ø16 GREY NYLON LID</td> <td>2</td> <td>PZ</td> </tr> <tr> <td>VM1059A1</td> <td></td> <td>1.350</td> <td>M</td> </tr> <tr> <td>VM1695A0</td> <td>HANDLE POSITION PIN</td> <td>2</td> <td>PZ</td> </tr> <tr> <td>VM1916A0</td> <td>RIGHT UPPER COLUMN CAP</td> <td>1</td> <td>PZ</td> </tr> <tr> <td>VM1917A0</td> <td>LEFT UPPER COLUMN CAP</td> <td>1</td> <td>PZ</td> </tr> <tr> <td>VM1918A0</td> <td>RIGHT LOWER COLUMN CAP</td> <td>1</td> <td>PZ</td> </tr> <tr> <td>VM1919A0</td> <td>LEFT LOWER COLUMN CAP</td> <td>1</td> <td>PZ</td> </tr> <tr> <td>VM1920A0</td> <td>INTERNAL GLASS CLOSING RIGHT PLATE</td> <td>1</td> <td>PZ</td> </tr> <tr> <td>VM1921A0</td> <td>INTERNAL GLASS CLOSING LEFT PLATE</td> <td>1</td> <td>PZ</td> </tr> <tr> <td>VT1067A0</td> <td>LINEMISS ELENA BLACK EXTERNAL DOOR GLASS</td> <td>1</td> <td>PZ</td> </tr> </tbody> </table>	Code	Description	Qty	UOM	IP1385A1		0.800	M	IP1508A0		1.710	PZ	RC1200A0	ED=4 WIRE D.=0.5 COMPRESSIO N SPRING	2	PZ	SL1050A1	3M TRANSFER ADHESIVE TAPE	0.660	M	TB2306A0	LMISS STEFANIA/ELE NA DOOR RIGHT COLUM	2	PZ	VM1025A0	Ø16 GREY NYLON LID	2	PZ	VM1059A1		1.350	M	VM1695A0	HANDLE POSITION PIN	2	PZ	VM1916A0	RIGHT UPPER COLUMN CAP	1	PZ	VM1917A0	LEFT UPPER COLUMN CAP	1	PZ	VM1918A0	RIGHT LOWER COLUMN CAP	1	PZ	VM1919A0	LEFT LOWER COLUMN CAP	1	PZ	VM1920A0	INTERNAL GLASS CLOSING RIGHT PLATE	1	PZ	VM1921A0	INTERNAL GLASS CLOSING LEFT PLATE	1	PZ	VT1067A0	LINEMISS ELENA BLACK EXTERNAL DOOR GLASS	1	PZ
Code	Description	Qty	UOM																																																															
IP1385A1		0.800	M																																																															
IP1508A0		1.710	PZ																																																															
RC1200A0	ED=4 WIRE D.=0.5 COMPRESSIO N SPRING	2	PZ																																																															
SL1050A1	3M TRANSFER ADHESIVE TAPE	0.660	M																																																															
TB2306A0	LMISS STEFANIA/ELE NA DOOR RIGHT COLUM	2	PZ																																																															
VM1025A0	Ø16 GREY NYLON LID	2	PZ																																																															
VM1059A1		1.350	M																																																															
VM1695A0	HANDLE POSITION PIN	2	PZ																																																															
VM1916A0	RIGHT UPPER COLUMN CAP	1	PZ																																																															
VM1917A0	LEFT UPPER COLUMN CAP	1	PZ																																																															
VM1918A0	RIGHT LOWER COLUMN CAP	1	PZ																																																															
VM1919A0	LEFT LOWER COLUMN CAP	1	PZ																																																															
VM1920A0	INTERNAL GLASS CLOSING RIGHT PLATE	1	PZ																																																															
VM1921A0	INTERNAL GLASS CLOSING LEFT PLATE	1	PZ																																																															
VT1067A0	LINEMISS ELENA BLACK EXTERNAL DOOR GLASS	1	PZ																																																															
KVT1066A	L.M. ELENA EXTERNAL GLASS KIT	<table border="1"> <thead> <tr> <th>Code</th> <th>Description</th> <th>Qty</th> <th>UOM</th> </tr> </thead> <tbody> <tr> <td>IP1385A1</td> <td></td> <td>0.800</td> <td>M</td> </tr> <tr> <td>IP1508A0</td> <td></td> <td>1.710</td> <td>PZ</td> </tr> </tbody> </table>	Code	Description	Qty	UOM	IP1385A1		0.800	M	IP1508A0		1.710	PZ																																																				
Code	Description	Qty	UOM																																																															
IP1385A1		0.800	M																																																															
IP1508A0		1.710	PZ																																																															





COMPONENT			SPARE PART																																																										
Code	Description	Image	Code	Description	Components list																																																								
VM1918A	RIGHT LOWER COLUMN CAP		KVT1066A	L.M. ELENA EXTERNAL GLASS KIT	<table border="1"> <thead> <tr> <th>Code</th> <th>Description</th> <th>Qty</th> <th>UOM</th> </tr> </thead> <tbody> <tr> <td>RC1200A0</td> <td>ED=4 WIRE D.=0.5 COMPRESSIO N SPRING</td> <td>2</td> <td>PZ</td> </tr> <tr> <td>SL1050A1</td> <td>3M TRANSFER ADHESIVE TAPE</td> <td>0.660</td> <td>M</td> </tr> <tr> <td>TB2306A0</td> <td>LMISS STEFANIA/ELE NA DOOR RIGHT COLUM</td> <td>2</td> <td>PZ</td> </tr> <tr> <td>VM1025A0</td> <td>Ø16 GREY NYLON LID</td> <td>2</td> <td>PZ</td> </tr> <tr> <td>VM1059A1</td> <td></td> <td>1.350</td> <td>M</td> </tr> <tr> <td>VM1695A0</td> <td>HANDLE POSITION PIN</td> <td>2</td> <td>PZ</td> </tr> <tr> <td>VM1916A0</td> <td>RIGHT UPPER COLUMN CAP</td> <td>1</td> <td>PZ</td> </tr> <tr> <td>VM1917A0</td> <td>LEFT UPPER COLUMN CAP</td> <td>1</td> <td>PZ</td> </tr> <tr> <td>VM1918A0</td> <td>RIGHT LOWER COLUMN CAP</td> <td>1</td> <td>PZ</td> </tr> <tr> <td>VM1919A0</td> <td>LEFT LOWER COLUMN CAP</td> <td>1</td> <td>PZ</td> </tr> <tr> <td>VM1920A0</td> <td>INTERNAL GLASS CLOSING RIGHT PLATE</td> <td>1</td> <td>PZ</td> </tr> <tr> <td>VM1921A0</td> <td>INTERNAL GLASS CLOSING LEFT PLATE</td> <td>1</td> <td>PZ</td> </tr> <tr> <td>VT1066A2</td> <td></td> <td>1</td> <td>PZ</td> </tr> </tbody> </table>	Code	Description	Qty	UOM	RC1200A0	ED=4 WIRE D.=0.5 COMPRESSIO N SPRING	2	PZ	SL1050A1	3M TRANSFER ADHESIVE TAPE	0.660	M	TB2306A0	LMISS STEFANIA/ELE NA DOOR RIGHT COLUM	2	PZ	VM1025A0	Ø16 GREY NYLON LID	2	PZ	VM1059A1		1.350	M	VM1695A0	HANDLE POSITION PIN	2	PZ	VM1916A0	RIGHT UPPER COLUMN CAP	1	PZ	VM1917A0	LEFT UPPER COLUMN CAP	1	PZ	VM1918A0	RIGHT LOWER COLUMN CAP	1	PZ	VM1919A0	LEFT LOWER COLUMN CAP	1	PZ	VM1920A0	INTERNAL GLASS CLOSING RIGHT PLATE	1	PZ	VM1921A0	INTERNAL GLASS CLOSING LEFT PLATE	1	PZ	VT1066A2		1	PZ
					Code	Description	Qty	UOM																																																					
					RC1200A0	ED=4 WIRE D.=0.5 COMPRESSIO N SPRING	2	PZ																																																					
					SL1050A1	3M TRANSFER ADHESIVE TAPE	0.660	M																																																					
					TB2306A0	LMISS STEFANIA/ELE NA DOOR RIGHT COLUM	2	PZ																																																					
					VM1025A0	Ø16 GREY NYLON LID	2	PZ																																																					
					VM1059A1		1.350	M																																																					
					VM1695A0	HANDLE POSITION PIN	2	PZ																																																					
					VM1916A0	RIGHT UPPER COLUMN CAP	1	PZ																																																					
					VM1917A0	LEFT UPPER COLUMN CAP	1	PZ																																																					
					VM1918A0	RIGHT LOWER COLUMN CAP	1	PZ																																																					
					VM1919A0	LEFT LOWER COLUMN CAP	1	PZ																																																					
					VM1920A0	INTERNAL GLASS CLOSING RIGHT PLATE	1	PZ																																																					
					VM1921A0	INTERNAL GLASS CLOSING LEFT PLATE	1	PZ																																																					
VT1066A2		1	PZ																																																										
VM1919A	LEFT LOWER COLUMN CAP		KVT1253A	ENGEFOOD XF195-EG EXTERNAL GLASS KIT	<table border="1"> <thead> <tr> <th>Code</th> <th>Description</th> <th>Qty</th> <th>UOM</th> </tr> </thead> <tbody> <tr> <td>IP1235B0</td> <td></td> <td>1</td> <td>PZ</td> </tr> <tr> <td>RC1200A0</td> <td>ED=4 WIRE D.=0.5 COMPRESSIO N SPRING</td> <td>2</td> <td>PZ</td> </tr> <tr> <td>SL1050A1</td> <td>3M TRANSFER ADHESIVE TAPE</td> <td>0.820</td> <td>M</td> </tr> <tr> <td>TB2301A0</td> <td></td> <td>2</td> <td>PZ</td> </tr> <tr> <td>VM1025A0</td> <td>Ø16 GREY NYLON LID</td> <td>2</td> <td>PZ</td> </tr> <tr> <td>VM1695A0</td> <td>HANDLE POSITION PIN</td> <td>2</td> <td>PZ</td> </tr> <tr> <td>VM1916A0</td> <td>RIGHT UPPER COLUMN CAP</td> <td>1</td> <td>PZ</td> </tr> <tr> <td>VM1917A0</td> <td>LEFT UPPER COLUMN CAP</td> <td>1</td> <td>PZ</td> </tr> <tr> <td>VM1918A0</td> <td>RIGHT LOWER COLUMN CAP</td> <td>1</td> <td>PZ</td> </tr> <tr> <td>VM1919A0</td> <td>LEFT LOWER COLUMN CAP</td> <td>1</td> <td>PZ</td> </tr> </tbody> </table>	Code	Description	Qty	UOM	IP1235B0		1	PZ	RC1200A0	ED=4 WIRE D.=0.5 COMPRESSIO N SPRING	2	PZ	SL1050A1	3M TRANSFER ADHESIVE TAPE	0.820	M	TB2301A0		2	PZ	VM1025A0	Ø16 GREY NYLON LID	2	PZ	VM1695A0	HANDLE POSITION PIN	2	PZ	VM1916A0	RIGHT UPPER COLUMN CAP	1	PZ	VM1917A0	LEFT UPPER COLUMN CAP	1	PZ	VM1918A0	RIGHT LOWER COLUMN CAP	1	PZ	VM1919A0	LEFT LOWER COLUMN CAP	1	PZ												
					Code	Description	Qty	UOM																																																					
					IP1235B0		1	PZ																																																					
					RC1200A0	ED=4 WIRE D.=0.5 COMPRESSIO N SPRING	2	PZ																																																					
					SL1050A1	3M TRANSFER ADHESIVE TAPE	0.820	M																																																					
					TB2301A0		2	PZ																																																					
					VM1025A0	Ø16 GREY NYLON LID	2	PZ																																																					
					VM1695A0	HANDLE POSITION PIN	2	PZ																																																					
					VM1916A0	RIGHT UPPER COLUMN CAP	1	PZ																																																					
					VM1917A0	LEFT UPPER COLUMN CAP	1	PZ																																																					
					VM1918A0	RIGHT LOWER COLUMN CAP	1	PZ																																																					
					VM1919A0	LEFT LOWER COLUMN CAP	1	PZ																																																					

COMPONENT			SPARE PART																																																															
Code	Description	Image	Code	Description	Components list																																																													
VM1919A	LEFT LOWER COLUMN CAP		KVT1253A	ENGEFOOD XF195-EG EXTERNAL GLASS KIT	<table border="1"> <thead> <tr> <th>Code</th> <th>Description</th> <th>Qty</th> <th>UOM</th> </tr> </thead> <tbody> <tr> <td>VM1920A0</td> <td>INTERNAL GLASS CLOSING RIGHT PLATE</td> <td>1</td> <td>PZ</td> </tr> <tr> <td>VM1921A0</td> <td>INTERNAL GLASS CLOSING LEFT PLATE</td> <td>1</td> <td>PZ</td> </tr> <tr> <td>VT1253A0</td> <td>XF195 BLACK EXTERNAL GLASS - ENGEFOOD</td> <td>1</td> <td>PZ</td> </tr> </tbody> </table>	Code	Description	Qty	UOM	VM1920A0	INTERNAL GLASS CLOSING RIGHT PLATE	1	PZ	VM1921A0	INTERNAL GLASS CLOSING LEFT PLATE	1	PZ	VT1253A0	XF195 BLACK EXTERNAL GLASS - ENGEFOOD	1	PZ																																													
			Code	Description	Qty	UOM																																																												
			VM1920A0	INTERNAL GLASS CLOSING RIGHT PLATE	1	PZ																																																												
VM1921A0	INTERNAL GLASS CLOSING LEFT PLATE	1	PZ																																																															
VT1253A0	XF195 BLACK EXTERNAL GLASS - ENGEFOOD	1	PZ																																																															
KVT1072A	L.M. ROSSELLA BLACK EXTERNAL GLASS KIT	<table border="1"> <thead> <tr> <th>Code</th> <th>Description</th> <th>Qty</th> <th>UOM</th> </tr> </thead> <tbody> <tr> <td>IP1385A1</td> <td></td> <td>0.960</td> <td>M</td> </tr> <tr> <td>IP1508A0</td> <td></td> <td>1.280</td> <td>PZ</td> </tr> <tr> <td>RC1200A0</td> <td>ED=4 WIRE D.=0.5 COMPRESSIO N SPRING</td> <td>2</td> <td>PZ</td> </tr> <tr> <td>SL1050A1</td> <td>3M TRANSFER ADHESIVE TAPE</td> <td>0.820</td> <td>M</td> </tr> <tr> <td>TB2301A0</td> <td></td> <td>2</td> <td>PZ</td> </tr> <tr> <td>VM1025A0</td> <td>Ø16 GREY NYLON LID</td> <td>2</td> <td>PZ</td> </tr> <tr> <td>VM1059A1</td> <td></td> <td>1.300</td> <td>M</td> </tr> <tr> <td>VM1695A0</td> <td>HANDLE POSITION PIN</td> <td>2</td> <td>PZ</td> </tr> <tr> <td>VM1916A0</td> <td>RIGHT UPPER COLUMN CAP</td> <td>1</td> <td>PZ</td> </tr> <tr> <td>VM1917A0</td> <td>LEFT UPPER COLUMN CAP</td> <td>1</td> <td>PZ</td> </tr> <tr> <td>VM1918A0</td> <td>RIGHT LOWER COLUMN CAP</td> <td>1</td> <td>PZ</td> </tr> <tr> <td>VM1919A0</td> <td>LEFT LOWER COLUMN CAP</td> <td>1</td> <td>PZ</td> </tr> <tr> <td>VM1920A0</td> <td>INTERNAL GLASS CLOSING RIGHT PLATE</td> <td>1</td> <td>PZ</td> </tr> <tr> <td>VM1921A0</td> <td>INTERNAL GLASS CLOSING LEFT PLATE</td> <td>1</td> <td>PZ</td> </tr> <tr> <td>VT1072A0</td> <td>LINEMISS ROSSELLA BLACK EXTERNAL GLASS</td> <td>1</td> <td>PZ</td> </tr> </tbody> </table>	Code	Description	Qty	UOM	IP1385A1		0.960	M	IP1508A0		1.280	PZ	RC1200A0	ED=4 WIRE D.=0.5 COMPRESSIO N SPRING	2	PZ	SL1050A1	3M TRANSFER ADHESIVE TAPE	0.820	M	TB2301A0		2	PZ	VM1025A0	Ø16 GREY NYLON LID	2	PZ	VM1059A1		1.300	M	VM1695A0	HANDLE POSITION PIN	2	PZ	VM1916A0	RIGHT UPPER COLUMN CAP	1	PZ	VM1917A0	LEFT UPPER COLUMN CAP	1	PZ	VM1918A0	RIGHT LOWER COLUMN CAP	1	PZ	VM1919A0	LEFT LOWER COLUMN CAP	1	PZ	VM1920A0	INTERNAL GLASS CLOSING RIGHT PLATE	1	PZ	VM1921A0	INTERNAL GLASS CLOSING LEFT PLATE	1	PZ	VT1072A0	LINEMISS ROSSELLA BLACK EXTERNAL GLASS	1	PZ
Code	Description	Qty	UOM																																																															
IP1385A1		0.960	M																																																															
IP1508A0		1.280	PZ																																																															
RC1200A0	ED=4 WIRE D.=0.5 COMPRESSIO N SPRING	2	PZ																																																															
SL1050A1	3M TRANSFER ADHESIVE TAPE	0.820	M																																																															
TB2301A0		2	PZ																																																															
VM1025A0	Ø16 GREY NYLON LID	2	PZ																																																															
VM1059A1		1.300	M																																																															
VM1695A0	HANDLE POSITION PIN	2	PZ																																																															
VM1916A0	RIGHT UPPER COLUMN CAP	1	PZ																																																															
VM1917A0	LEFT UPPER COLUMN CAP	1	PZ																																																															
VM1918A0	RIGHT LOWER COLUMN CAP	1	PZ																																																															
VM1919A0	LEFT LOWER COLUMN CAP	1	PZ																																																															
VM1920A0	INTERNAL GLASS CLOSING RIGHT PLATE	1	PZ																																																															
VM1921A0	INTERNAL GLASS CLOSING LEFT PLATE	1	PZ																																																															
VT1072A0	LINEMISS ROSSELLA BLACK EXTERNAL GLASS	1	PZ																																																															
KVT1071A	L.M. ROSSELLA EXTERNAL GLASS KIT	<table border="1"> <thead> <tr> <th>Code</th> <th>Description</th> <th>Qty</th> <th>UOM</th> </tr> </thead> <tbody> <tr> <td>IP1385A1</td> <td></td> <td>0.960</td> <td>M</td> </tr> <tr> <td>IP1508A0</td> <td></td> <td>1.300</td> <td>PZ</td> </tr> </tbody> </table>	Code	Description	Qty	UOM	IP1385A1		0.960	M	IP1508A0		1.300	PZ																																																				
Code	Description	Qty	UOM																																																															
IP1385A1		0.960	M																																																															
IP1508A0		1.300	PZ																																																															

COMPONENT			SPARE PART																																																										
Code	Description	Image	Code	Description	Components list																																																								
VM1919A	LEFT LOWER COLUMN CAP		KVT1071A	L.M. ROSSELLA EXTERNAL GLASS KIT	<table border="1"> <thead> <tr> <th>Code</th> <th>Description</th> <th>Qty</th> <th>UOM</th> </tr> </thead> <tbody> <tr> <td>RC1200A0</td> <td>ED=4 WIRE D.=0.5 COMPRESSIO N SPRING</td> <td>2</td> <td>PZ</td> </tr> <tr> <td>SL1050A1</td> <td>3M TRANSFER ADHESIVE TAPE</td> <td>0.820</td> <td>M</td> </tr> <tr> <td>TB2301A0</td> <td></td> <td>2</td> <td>PZ</td> </tr> <tr> <td>VM1025A0</td> <td>Ø16 GREY NYLON LID</td> <td>2</td> <td>PZ</td> </tr> <tr> <td>VM1059A1</td> <td></td> <td>1.350</td> <td>M</td> </tr> <tr> <td>VM1695A0</td> <td>HANDLE POSITION PIN</td> <td>2</td> <td>PZ</td> </tr> <tr> <td>VM1916A0</td> <td>RIGHT UPPER COLUMN CAP</td> <td>1</td> <td>PZ</td> </tr> <tr> <td>VM1917A0</td> <td>LEFT UPPER COLUMN CAP</td> <td>1</td> <td>PZ</td> </tr> <tr> <td>VM1918A0</td> <td>RIGHT LOWER COLUMN CAP</td> <td>1</td> <td>PZ</td> </tr> <tr> <td>VM1919A0</td> <td>LEFT LOWER COLUMN CAP</td> <td>1</td> <td>PZ</td> </tr> <tr> <td>VM1920A0</td> <td>INTERNAL GLASS CLOSING RIGHT PLATE</td> <td>1</td> <td>PZ</td> </tr> <tr> <td>VM1921A0</td> <td>INTERNAL GLASS CLOSING LEFT PLATE</td> <td>1</td> <td>PZ</td> </tr> <tr> <td>VT1071A2</td> <td></td> <td>1</td> <td>PZ</td> </tr> </tbody> </table>	Code	Description	Qty	UOM	RC1200A0	ED=4 WIRE D.=0.5 COMPRESSIO N SPRING	2	PZ	SL1050A1	3M TRANSFER ADHESIVE TAPE	0.820	M	TB2301A0		2	PZ	VM1025A0	Ø16 GREY NYLON LID	2	PZ	VM1059A1		1.350	M	VM1695A0	HANDLE POSITION PIN	2	PZ	VM1916A0	RIGHT UPPER COLUMN CAP	1	PZ	VM1917A0	LEFT UPPER COLUMN CAP	1	PZ	VM1918A0	RIGHT LOWER COLUMN CAP	1	PZ	VM1919A0	LEFT LOWER COLUMN CAP	1	PZ	VM1920A0	INTERNAL GLASS CLOSING RIGHT PLATE	1	PZ	VM1921A0	INTERNAL GLASS CLOSING LEFT PLATE	1	PZ	VT1071A2		1	PZ
			Code	Description	Qty	UOM																																																							
RC1200A0	ED=4 WIRE D.=0.5 COMPRESSIO N SPRING	2	PZ																																																										
SL1050A1	3M TRANSFER ADHESIVE TAPE	0.820	M																																																										
TB2301A0		2	PZ																																																										
VM1025A0	Ø16 GREY NYLON LID	2	PZ																																																										
VM1059A1		1.350	M																																																										
VM1695A0	HANDLE POSITION PIN	2	PZ																																																										
VM1916A0	RIGHT UPPER COLUMN CAP	1	PZ																																																										
VM1917A0	LEFT UPPER COLUMN CAP	1	PZ																																																										
VM1918A0	RIGHT LOWER COLUMN CAP	1	PZ																																																										
VM1919A0	LEFT LOWER COLUMN CAP	1	PZ																																																										
VM1920A0	INTERNAL GLASS CLOSING RIGHT PLATE	1	PZ																																																										
VM1921A0	INTERNAL GLASS CLOSING LEFT PLATE	1	PZ																																																										
VT1071A2		1	PZ																																																										
			KVT1067A	L.M. ELENA BLACK EXTERNAL GLASS KIT	<table border="1"> <thead> <tr> <th>Code</th> <th>Description</th> <th>Qty</th> <th>UOM</th> </tr> </thead> <tbody> <tr> <td>IP1385A1</td> <td></td> <td>0.800</td> <td>M</td> </tr> <tr> <td>IP1508A0</td> <td></td> <td>1.710</td> <td>PZ</td> </tr> <tr> <td>RC1200A0</td> <td>ED=4 WIRE D.=0.5 COMPRESSIO N SPRING</td> <td>2</td> <td>PZ</td> </tr> <tr> <td>SL1050A1</td> <td>3M TRANSFER ADHESIVE TAPE</td> <td>0.660</td> <td>M</td> </tr> <tr> <td>TB2306A0</td> <td>LMISS STEFANIA/ELE NA DOOR RIGHT COLUM</td> <td>2</td> <td>PZ</td> </tr> <tr> <td>VM1025A0</td> <td>Ø16 GREY NYLON LID</td> <td>2</td> <td>PZ</td> </tr> <tr> <td>VM1059A1</td> <td></td> <td>1.350</td> <td>M</td> </tr> <tr> <td>VM1695A0</td> <td>HANDLE POSITION PIN</td> <td>2</td> <td>PZ</td> </tr> <tr> <td>VM1916A0</td> <td>RIGHT UPPER COLUMN CAP</td> <td>1</td> <td>PZ</td> </tr> <tr> <td>VM1917A0</td> <td>LEFT UPPER COLUMN CAP</td> <td>1</td> <td>PZ</td> </tr> <tr> <td>VM1918A0</td> <td>RIGHT LOWER COLUMN CAP</td> <td>1</td> <td>PZ</td> </tr> </tbody> </table>	Code	Description	Qty	UOM	IP1385A1		0.800	M	IP1508A0		1.710	PZ	RC1200A0	ED=4 WIRE D.=0.5 COMPRESSIO N SPRING	2	PZ	SL1050A1	3M TRANSFER ADHESIVE TAPE	0.660	M	TB2306A0	LMISS STEFANIA/ELE NA DOOR RIGHT COLUM	2	PZ	VM1025A0	Ø16 GREY NYLON LID	2	PZ	VM1059A1		1.350	M	VM1695A0	HANDLE POSITION PIN	2	PZ	VM1916A0	RIGHT UPPER COLUMN CAP	1	PZ	VM1917A0	LEFT UPPER COLUMN CAP	1	PZ	VM1918A0	RIGHT LOWER COLUMN CAP	1	PZ								
Code	Description	Qty	UOM																																																										
IP1385A1		0.800	M																																																										
IP1508A0		1.710	PZ																																																										
RC1200A0	ED=4 WIRE D.=0.5 COMPRESSIO N SPRING	2	PZ																																																										
SL1050A1	3M TRANSFER ADHESIVE TAPE	0.660	M																																																										
TB2306A0	LMISS STEFANIA/ELE NA DOOR RIGHT COLUM	2	PZ																																																										
VM1025A0	Ø16 GREY NYLON LID	2	PZ																																																										
VM1059A1		1.350	M																																																										
VM1695A0	HANDLE POSITION PIN	2	PZ																																																										
VM1916A0	RIGHT UPPER COLUMN CAP	1	PZ																																																										
VM1917A0	LEFT UPPER COLUMN CAP	1	PZ																																																										
VM1918A0	RIGHT LOWER COLUMN CAP	1	PZ																																																										

COMPONENT			SPARE PART																																																															
Code	Description	Image	Code	Description	Components list																																																													
VM1919A	LEFT LOWER COLUMN CAP		KVT1067A	L.M. ELENA BLACK EXTERNAL GLASS KIT	<table border="1"> <thead> <tr> <th>Code</th> <th>Description</th> <th>Qty</th> <th>UOM</th> </tr> </thead> <tbody> <tr> <td>VM1919A0</td> <td>LEFT LOWER COLUMN CAP</td> <td>1</td> <td>PZ</td> </tr> <tr> <td>VM1920A0</td> <td>INTERNAL GLASS CLOSING RIGHT PLATE</td> <td>1</td> <td>PZ</td> </tr> <tr> <td>VM1921A0</td> <td>INTERNAL GLASS CLOSING LEFT PLATE</td> <td>1</td> <td>PZ</td> </tr> <tr> <td>VT1067A0</td> <td>LINEMISS ELENA BLACK EXTERNAL DOOR GLASS</td> <td>1</td> <td>PZ</td> </tr> </tbody> </table>	Code	Description	Qty	UOM	VM1919A0	LEFT LOWER COLUMN CAP	1	PZ	VM1920A0	INTERNAL GLASS CLOSING RIGHT PLATE	1	PZ	VM1921A0	INTERNAL GLASS CLOSING LEFT PLATE	1	PZ	VT1067A0	LINEMISS ELENA BLACK EXTERNAL DOOR GLASS	1	PZ																																									
			Code	Description	Qty	UOM																																																												
VM1919A0	LEFT LOWER COLUMN CAP	1	PZ																																																															
VM1920A0	INTERNAL GLASS CLOSING RIGHT PLATE	1	PZ																																																															
VM1921A0	INTERNAL GLASS CLOSING LEFT PLATE	1	PZ																																																															
VT1067A0	LINEMISS ELENA BLACK EXTERNAL DOOR GLASS	1	PZ																																																															
KVT1066A	L.M. ELENA EXTERNAL GLASS KIT	<table border="1"> <thead> <tr> <th>Code</th> <th>Description</th> <th>Qty</th> <th>UOM</th> </tr> </thead> <tbody> <tr> <td>IP1385A1</td> <td></td> <td>0.800</td> <td>M</td> </tr> <tr> <td>IP1508A0</td> <td></td> <td>1.710</td> <td>PZ</td> </tr> <tr> <td>RC1200A0</td> <td>ED=4 WIRE D.=0.5 COMPRESSIO N SPRING</td> <td>2</td> <td>PZ</td> </tr> <tr> <td>SL1050A1</td> <td>3M TRANSFER ADHESIVE TAPE</td> <td>0.660</td> <td>M</td> </tr> <tr> <td>TB2306A0</td> <td>LMISS STEFANIA/ELE NA DOOR RIGHT COLUM</td> <td>2</td> <td>PZ</td> </tr> <tr> <td>VM1025A0</td> <td>Ø16 GREY NYLON LID</td> <td>2</td> <td>PZ</td> </tr> <tr> <td>VM1059A1</td> <td></td> <td>1.350</td> <td>M</td> </tr> <tr> <td>VM1695A0</td> <td>HANDLE POSITION PIN</td> <td>2</td> <td>PZ</td> </tr> <tr> <td>VM1916A0</td> <td>RIGHT UPPER COLUMN CAP</td> <td>1</td> <td>PZ</td> </tr> <tr> <td>VM1917A0</td> <td>LEFT UPPER COLUMN CAP</td> <td>1</td> <td>PZ</td> </tr> <tr> <td>VM1918A0</td> <td>RIGHT LOWER COLUMN CAP</td> <td>1</td> <td>PZ</td> </tr> <tr> <td>VM1919A0</td> <td>LEFT LOWER COLUMN CAP</td> <td>1</td> <td>PZ</td> </tr> <tr> <td>VM1920A0</td> <td>INTERNAL GLASS CLOSING RIGHT PLATE</td> <td>1</td> <td>PZ</td> </tr> <tr> <td>VM1921A0</td> <td>INTERNAL GLASS CLOSING LEFT PLATE</td> <td>1</td> <td>PZ</td> </tr> <tr> <td>VT1066A2</td> <td></td> <td>1</td> <td>PZ</td> </tr> </tbody> </table>	Code	Description	Qty	UOM	IP1385A1		0.800	M	IP1508A0		1.710	PZ	RC1200A0	ED=4 WIRE D.=0.5 COMPRESSIO N SPRING	2	PZ	SL1050A1	3M TRANSFER ADHESIVE TAPE	0.660	M	TB2306A0	LMISS STEFANIA/ELE NA DOOR RIGHT COLUM	2	PZ	VM1025A0	Ø16 GREY NYLON LID	2	PZ	VM1059A1		1.350	M	VM1695A0	HANDLE POSITION PIN	2	PZ	VM1916A0	RIGHT UPPER COLUMN CAP	1	PZ	VM1917A0	LEFT UPPER COLUMN CAP	1	PZ	VM1918A0	RIGHT LOWER COLUMN CAP	1	PZ	VM1919A0	LEFT LOWER COLUMN CAP	1	PZ	VM1920A0	INTERNAL GLASS CLOSING RIGHT PLATE	1	PZ	VM1921A0	INTERNAL GLASS CLOSING LEFT PLATE	1	PZ	VT1066A2		1	PZ
Code	Description	Qty	UOM																																																															
IP1385A1		0.800	M																																																															
IP1508A0		1.710	PZ																																																															
RC1200A0	ED=4 WIRE D.=0.5 COMPRESSIO N SPRING	2	PZ																																																															
SL1050A1	3M TRANSFER ADHESIVE TAPE	0.660	M																																																															
TB2306A0	LMISS STEFANIA/ELE NA DOOR RIGHT COLUM	2	PZ																																																															
VM1025A0	Ø16 GREY NYLON LID	2	PZ																																																															
VM1059A1		1.350	M																																																															
VM1695A0	HANDLE POSITION PIN	2	PZ																																																															
VM1916A0	RIGHT UPPER COLUMN CAP	1	PZ																																																															
VM1917A0	LEFT UPPER COLUMN CAP	1	PZ																																																															
VM1918A0	RIGHT LOWER COLUMN CAP	1	PZ																																																															
VM1919A0	LEFT LOWER COLUMN CAP	1	PZ																																																															
VM1920A0	INTERNAL GLASS CLOSING RIGHT PLATE	1	PZ																																																															
VM1921A0	INTERNAL GLASS CLOSING LEFT PLATE	1	PZ																																																															
VT1066A2		1	PZ																																																															

COMPONENT			SPARE PART																																																																																													
Code	Description	Image	Code	Description	Components list																																																																																											
VM1920A	INTERNAL GLASS CLOSING RIGHT PLATE		KVT1253A	ENGEFOOD XF195-EG EXTERNAL GLASS KIT	<table border="1"> <thead> <tr> <th>Code</th> <th>Description</th> <th>Qty</th> <th>UOM</th> </tr> </thead> <tbody> <tr> <td>IP1235B0</td> <td></td> <td>1</td> <td>PZ</td> </tr> <tr> <td>RC1200A0</td> <td>ED=4 WIRE D.=0.5 COMPRESSIO N SPRING</td> <td>2</td> <td>PZ</td> </tr> <tr> <td>SL1050A1</td> <td>3M TRANSFER ADHESIVE TAPE</td> <td>0.820</td> <td>M</td> </tr> <tr> <td>TB2301A0</td> <td></td> <td>2</td> <td>PZ</td> </tr> <tr> <td>VM1025A0</td> <td>Ø16 GREY NYLON LID</td> <td>2</td> <td>PZ</td> </tr> <tr> <td>VM1695A0</td> <td>HANDLE POSITION PIN</td> <td>2</td> <td>PZ</td> </tr> <tr> <td>VM1916A0</td> <td>RIGHT UPPER COLUMN CAP</td> <td>1</td> <td>PZ</td> </tr> <tr> <td>VM1917A0</td> <td>LEFT UPPER COLUMN CAP</td> <td>1</td> <td>PZ</td> </tr> <tr> <td>VM1918A0</td> <td>RIGHT LOWER COLUMN CAP</td> <td>1</td> <td>PZ</td> </tr> <tr> <td>VM1919A0</td> <td>LEFT LOWER COLUMN CAP</td> <td>1</td> <td>PZ</td> </tr> <tr> <td>VM1920A0</td> <td>INTERNAL GLASS CLOSING RIGHT PLATE</td> <td>1</td> <td>PZ</td> </tr> <tr> <td>VM1921A0</td> <td>INTERNAL GLASS CLOSING LEFT PLATE</td> <td>1</td> <td>PZ</td> </tr> <tr> <td>VT1253A0</td> <td>XF195 BLACK EXTERNAL GLASS - ENGEFOOD</td> <td>1</td> <td>PZ</td> </tr> </tbody> </table>	Code	Description	Qty	UOM	IP1235B0		1	PZ	RC1200A0	ED=4 WIRE D.=0.5 COMPRESSIO N SPRING	2	PZ	SL1050A1	3M TRANSFER ADHESIVE TAPE	0.820	M	TB2301A0		2	PZ	VM1025A0	Ø16 GREY NYLON LID	2	PZ	VM1695A0	HANDLE POSITION PIN	2	PZ	VM1916A0	RIGHT UPPER COLUMN CAP	1	PZ	VM1917A0	LEFT UPPER COLUMN CAP	1	PZ	VM1918A0	RIGHT LOWER COLUMN CAP	1	PZ	VM1919A0	LEFT LOWER COLUMN CAP	1	PZ	VM1920A0	INTERNAL GLASS CLOSING RIGHT PLATE	1	PZ	VM1921A0	INTERNAL GLASS CLOSING LEFT PLATE	1	PZ	VT1253A0	XF195 BLACK EXTERNAL GLASS - ENGEFOOD	1	PZ	KVT1252A	ENGEFOOD XF135-EG EXTERNAL GLASS KIT	<table border="1"> <thead> <tr> <th>Code</th> <th>Description</th> <th>Qty</th> <th>UOM</th> </tr> </thead> <tbody> <tr> <td>RC1200A0</td> <td>ED=4 WIRE D.=0.5 COMPRESSIO N SPRING</td> <td>2</td> <td>PZ</td> </tr> <tr> <td>SL1050A1</td> <td>3M TRANSFER ADHESIVE TAPE</td> <td>0.820</td> <td>M</td> </tr> <tr> <td>TB2301A0</td> <td></td> <td>2</td> <td>PZ</td> </tr> <tr> <td>VM1025A0</td> <td>Ø16 GREY NYLON LID</td> <td>2</td> <td>PZ</td> </tr> <tr> <td>VM1695A0</td> <td>HANDLE POSITION PIN</td> <td>2</td> <td>PZ</td> </tr> <tr> <td>VM1920A0</td> <td>INTERNAL GLASS CLOSING RIGHT PLATE</td> <td>1</td> <td>PZ</td> </tr> <tr> <td>VM1921A0</td> <td>INTERNAL GLASS CLOSING LEFT PLATE</td> <td>1</td> <td>PZ</td> </tr> </tbody> </table>	Code	Description	Qty	UOM	RC1200A0	ED=4 WIRE D.=0.5 COMPRESSIO N SPRING	2	PZ	SL1050A1	3M TRANSFER ADHESIVE TAPE	0.820	M	TB2301A0		2	PZ	VM1025A0	Ø16 GREY NYLON LID	2	PZ	VM1695A0	HANDLE POSITION PIN	2	PZ	VM1920A0	INTERNAL GLASS CLOSING RIGHT PLATE	1	PZ	VM1921A0	INTERNAL GLASS CLOSING LEFT PLATE	1	PZ
			Code	Description	Qty	UOM																																																																																										
IP1235B0		1	PZ																																																																																													
RC1200A0	ED=4 WIRE D.=0.5 COMPRESSIO N SPRING	2	PZ																																																																																													
SL1050A1	3M TRANSFER ADHESIVE TAPE	0.820	M																																																																																													
TB2301A0		2	PZ																																																																																													
VM1025A0	Ø16 GREY NYLON LID	2	PZ																																																																																													
VM1695A0	HANDLE POSITION PIN	2	PZ																																																																																													
VM1916A0	RIGHT UPPER COLUMN CAP	1	PZ																																																																																													
VM1917A0	LEFT UPPER COLUMN CAP	1	PZ																																																																																													
VM1918A0	RIGHT LOWER COLUMN CAP	1	PZ																																																																																													
VM1919A0	LEFT LOWER COLUMN CAP	1	PZ																																																																																													
VM1920A0	INTERNAL GLASS CLOSING RIGHT PLATE	1	PZ																																																																																													
VM1921A0	INTERNAL GLASS CLOSING LEFT PLATE	1	PZ																																																																																													
VT1253A0	XF195 BLACK EXTERNAL GLASS - ENGEFOOD	1	PZ																																																																																													
Code	Description	Qty	UOM																																																																																													
RC1200A0	ED=4 WIRE D.=0.5 COMPRESSIO N SPRING	2	PZ																																																																																													
SL1050A1	3M TRANSFER ADHESIVE TAPE	0.820	M																																																																																													
TB2301A0		2	PZ																																																																																													
VM1025A0	Ø16 GREY NYLON LID	2	PZ																																																																																													
VM1695A0	HANDLE POSITION PIN	2	PZ																																																																																													
VM1920A0	INTERNAL GLASS CLOSING RIGHT PLATE	1	PZ																																																																																													
VM1921A0	INTERNAL GLASS CLOSING LEFT PLATE	1	PZ																																																																																													

COMPONENT			SPARE PART																																																															
Code	Description	Image	Code	Description	Components list																																																													
VM1920A	INTERNAL GLASS CLOSING RIGHT PLATE		KVT1252A	ENGEFOOD XF135-EG EXTERNAL GLASS KIT	<table border="1"> <thead> <tr> <th>Code</th> <th>Description</th> <th>Qty</th> <th>UOM</th> </tr> </thead> <tbody> <tr> <td>VM2062A0</td> <td>L.MISS 46X33 RIGHT UPPER DOOR COLUMN CAP</td> <td>1</td> <td>PZ</td> </tr> <tr> <td>VM2063A0</td> <td>L.MISS 46X33 LEFT UPPER DOOR COLUMN CAP</td> <td>1</td> <td>PZ</td> </tr> <tr> <td>VM2064A0</td> <td>L.MISS 46X33 RIGHT LOWER DOOR COLUMN CAP</td> <td>1</td> <td>PZ</td> </tr> <tr> <td>VM2065A0</td> <td>L.MISS 46X33 LEFT LOWER DOOR COLUMN CAP</td> <td>1</td> <td>PZ</td> </tr> <tr> <td>VT1252A0</td> <td>XF135-B ENGEFOOD EXTERNAL GLASS</td> <td>1</td> <td>PZ</td> </tr> </tbody> </table>	Code	Description	Qty	UOM	VM2062A0	L.MISS 46X33 RIGHT UPPER DOOR COLUMN CAP	1	PZ	VM2063A0	L.MISS 46X33 LEFT UPPER DOOR COLUMN CAP	1	PZ	VM2064A0	L.MISS 46X33 RIGHT LOWER DOOR COLUMN CAP	1	PZ	VM2065A0	L.MISS 46X33 LEFT LOWER DOOR COLUMN CAP	1	PZ	VT1252A0	XF135-B ENGEFOOD EXTERNAL GLASS	1	PZ																																					
			Code	Description	Qty	UOM																																																												
VM2062A0	L.MISS 46X33 RIGHT UPPER DOOR COLUMN CAP	1	PZ																																																															
VM2063A0	L.MISS 46X33 LEFT UPPER DOOR COLUMN CAP	1	PZ																																																															
VM2064A0	L.MISS 46X33 RIGHT LOWER DOOR COLUMN CAP	1	PZ																																																															
VM2065A0	L.MISS 46X33 LEFT LOWER DOOR COLUMN CAP	1	PZ																																																															
VT1252A0	XF135-B ENGEFOOD EXTERNAL GLASS	1	PZ																																																															
KVT1072A	L.M. ROSSELLA BLACK EXTERNAL GLASS KIT	<table border="1"> <thead> <tr> <th>Code</th> <th>Description</th> <th>Qty</th> <th>UOM</th> </tr> </thead> <tbody> <tr> <td>IP1385A1</td> <td></td> <td>0.960</td> <td>M</td> </tr> <tr> <td>IP1508A0</td> <td></td> <td>1.280</td> <td>PZ</td> </tr> <tr> <td>RC1200A0</td> <td>ED=4 WIRE D.=0.5 COMPRESSIO N SPRING</td> <td>2</td> <td>PZ</td> </tr> <tr> <td>SL1050A1</td> <td>3M TRANSFER ADHESIVE TAPE</td> <td>0.820</td> <td>M</td> </tr> <tr> <td>TB2301A0</td> <td></td> <td>2</td> <td>PZ</td> </tr> <tr> <td>VM1025A0</td> <td>Ø16 GREY NYLON LID</td> <td>2</td> <td>PZ</td> </tr> <tr> <td>VM1059A1</td> <td></td> <td>1.300</td> <td>M</td> </tr> <tr> <td>VM1695A0</td> <td>HANDLE POSITION PIN</td> <td>2</td> <td>PZ</td> </tr> <tr> <td>VM1916A0</td> <td>RIGHT UPPER COLUMN CAP</td> <td>1</td> <td>PZ</td> </tr> <tr> <td>VM1917A0</td> <td>LEFT UPPER COLUMN CAP</td> <td>1</td> <td>PZ</td> </tr> <tr> <td>VM1918A0</td> <td>RIGHT LOWER COLUMN CAP</td> <td>1</td> <td>PZ</td> </tr> <tr> <td>VM1919A0</td> <td>LEFT LOWER COLUMN CAP</td> <td>1</td> <td>PZ</td> </tr> <tr> <td>VM1920A0</td> <td>INTERNAL GLASS CLOSING RIGHT PLATE</td> <td>1</td> <td>PZ</td> </tr> <tr> <td>VM1921A0</td> <td>INTERNAL GLASS CLOSING LEFT PLATE</td> <td>1</td> <td>PZ</td> </tr> <tr> <td>VT1072A0</td> <td>LINEMISS ROSSELLA BLACK EXTERNAL GLASS</td> <td>1</td> <td>PZ</td> </tr> </tbody> </table>	Code	Description	Qty	UOM	IP1385A1		0.960	M	IP1508A0		1.280	PZ	RC1200A0	ED=4 WIRE D.=0.5 COMPRESSIO N SPRING	2	PZ	SL1050A1	3M TRANSFER ADHESIVE TAPE	0.820	M	TB2301A0		2	PZ	VM1025A0	Ø16 GREY NYLON LID	2	PZ	VM1059A1		1.300	M	VM1695A0	HANDLE POSITION PIN	2	PZ	VM1916A0	RIGHT UPPER COLUMN CAP	1	PZ	VM1917A0	LEFT UPPER COLUMN CAP	1	PZ	VM1918A0	RIGHT LOWER COLUMN CAP	1	PZ	VM1919A0	LEFT LOWER COLUMN CAP	1	PZ	VM1920A0	INTERNAL GLASS CLOSING RIGHT PLATE	1	PZ	VM1921A0	INTERNAL GLASS CLOSING LEFT PLATE	1	PZ	VT1072A0	LINEMISS ROSSELLA BLACK EXTERNAL GLASS	1	PZ
Code	Description	Qty	UOM																																																															
IP1385A1		0.960	M																																																															
IP1508A0		1.280	PZ																																																															
RC1200A0	ED=4 WIRE D.=0.5 COMPRESSIO N SPRING	2	PZ																																																															
SL1050A1	3M TRANSFER ADHESIVE TAPE	0.820	M																																																															
TB2301A0		2	PZ																																																															
VM1025A0	Ø16 GREY NYLON LID	2	PZ																																																															
VM1059A1		1.300	M																																																															
VM1695A0	HANDLE POSITION PIN	2	PZ																																																															
VM1916A0	RIGHT UPPER COLUMN CAP	1	PZ																																																															
VM1917A0	LEFT UPPER COLUMN CAP	1	PZ																																																															
VM1918A0	RIGHT LOWER COLUMN CAP	1	PZ																																																															
VM1919A0	LEFT LOWER COLUMN CAP	1	PZ																																																															
VM1920A0	INTERNAL GLASS CLOSING RIGHT PLATE	1	PZ																																																															
VM1921A0	INTERNAL GLASS CLOSING LEFT PLATE	1	PZ																																																															
VT1072A0	LINEMISS ROSSELLA BLACK EXTERNAL GLASS	1	PZ																																																															

COMPONENT			SPARE PART																																																																																																																	
Code	Description	Image	Code	Description	Components list																																																																																																															
VM1920A	INTERNAL GLASS CLOSING RIGHT PLATE		KVT1071A	L.M. ROSSELLA EXTERNAL GLASS KIT	<table border="1"> <thead> <tr> <th>Code</th> <th>Description</th> <th>Qty</th> <th>UOM</th> </tr> </thead> <tbody> <tr> <td>IP1385A1</td> <td></td> <td>0.960</td> <td>M</td> </tr> <tr> <td>IP1508A0</td> <td></td> <td>1.300</td> <td>PZ</td> </tr> <tr> <td>RC1200A0</td> <td>ED=4 WIRE D.=0.5 COMPRESSIO N SPRING</td> <td>2</td> <td>PZ</td> </tr> <tr> <td>SL1050A1</td> <td>3M TRANSFER ADHESIVE TAPE</td> <td>0.820</td> <td>M</td> </tr> <tr> <td>TB2301A0</td> <td></td> <td>2</td> <td>PZ</td> </tr> <tr> <td>VM1025A0</td> <td>Ø16 GREY NYLON LID</td> <td>2</td> <td>PZ</td> </tr> <tr> <td>VM1059A1</td> <td></td> <td>1.350</td> <td>M</td> </tr> <tr> <td>VM1695A0</td> <td>HANDLE POSITION PIN</td> <td>2</td> <td>PZ</td> </tr> <tr> <td>VM1916A0</td> <td>RIGHT UPPER COLUMN CAP</td> <td>1</td> <td>PZ</td> </tr> <tr> <td>VM1917A0</td> <td>LEFT UPPER COLUMN CAP</td> <td>1</td> <td>PZ</td> </tr> <tr> <td>VM1918A0</td> <td>RIGHT LOWER COLUMN CAP</td> <td>1</td> <td>PZ</td> </tr> <tr> <td>VM1919A0</td> <td>LEFT LOWER COLUMN CAP</td> <td>1</td> <td>PZ</td> </tr> <tr> <td>VM1920A0</td> <td>INTERNAL GLASS CLOSING RIGHT PLATE</td> <td>1</td> <td>PZ</td> </tr> <tr> <td>VM1921A0</td> <td>INTERNAL GLASS CLOSING LEFT PLATE</td> <td>1</td> <td>PZ</td> </tr> <tr> <td>VT1071A2</td> <td></td> <td>1</td> <td>PZ</td> </tr> </tbody> </table>	Code	Description	Qty	UOM	IP1385A1		0.960	M	IP1508A0		1.300	PZ	RC1200A0	ED=4 WIRE D.=0.5 COMPRESSIO N SPRING	2	PZ	SL1050A1	3M TRANSFER ADHESIVE TAPE	0.820	M	TB2301A0		2	PZ	VM1025A0	Ø16 GREY NYLON LID	2	PZ	VM1059A1		1.350	M	VM1695A0	HANDLE POSITION PIN	2	PZ	VM1916A0	RIGHT UPPER COLUMN CAP	1	PZ	VM1917A0	LEFT UPPER COLUMN CAP	1	PZ	VM1918A0	RIGHT LOWER COLUMN CAP	1	PZ	VM1919A0	LEFT LOWER COLUMN CAP	1	PZ	VM1920A0	INTERNAL GLASS CLOSING RIGHT PLATE	1	PZ	VM1921A0	INTERNAL GLASS CLOSING LEFT PLATE	1	PZ	VT1071A2		1	PZ	KVT1067A	L.M. ELENA BLACK EXTERNAL GLASS KIT	<table border="1"> <thead> <tr> <th>Code</th> <th>Description</th> <th>Qty</th> <th>UOM</th> </tr> </thead> <tbody> <tr> <td>IP1385A1</td> <td></td> <td>0.800</td> <td>M</td> </tr> <tr> <td>IP1508A0</td> <td></td> <td>1.710</td> <td>PZ</td> </tr> <tr> <td>RC1200A0</td> <td>ED=4 WIRE D.=0.5 COMPRESSIO N SPRING</td> <td>2</td> <td>PZ</td> </tr> <tr> <td>SL1050A1</td> <td>3M TRANSFER ADHESIVE TAPE</td> <td>0.660</td> <td>M</td> </tr> <tr> <td>TB2306A0</td> <td>LMISS STEFANIA/ELE NA DOOR RIGHT COLUM</td> <td>2</td> <td>PZ</td> </tr> <tr> <td>VM1025A0</td> <td>Ø16 GREY NYLON LID</td> <td>2</td> <td>PZ</td> </tr> <tr> <td>VM1059A1</td> <td></td> <td>1.350</td> <td>M</td> </tr> <tr> <td>VM1695A0</td> <td>HANDLE POSITION PIN</td> <td>2</td> <td>PZ</td> </tr> <tr> <td>VM1916A0</td> <td>RIGHT UPPER COLUMN CAP</td> <td>1</td> <td>PZ</td> </tr> <tr> <td>VM1917A0</td> <td>LEFT UPPER COLUMN CAP</td> <td>1</td> <td>PZ</td> </tr> </tbody> </table>	Code	Description	Qty	UOM	IP1385A1		0.800	M	IP1508A0		1.710	PZ	RC1200A0	ED=4 WIRE D.=0.5 COMPRESSIO N SPRING	2	PZ	SL1050A1	3M TRANSFER ADHESIVE TAPE	0.660	M	TB2306A0	LMISS STEFANIA/ELE NA DOOR RIGHT COLUM	2	PZ	VM1025A0	Ø16 GREY NYLON LID	2	PZ	VM1059A1		1.350	M	VM1695A0	HANDLE POSITION PIN	2	PZ	VM1916A0	RIGHT UPPER COLUMN CAP	1	PZ	VM1917A0	LEFT UPPER COLUMN CAP	1	PZ
			Code	Description	Qty	UOM																																																																																																														
IP1385A1		0.960	M																																																																																																																	
IP1508A0		1.300	PZ																																																																																																																	
RC1200A0	ED=4 WIRE D.=0.5 COMPRESSIO N SPRING	2	PZ																																																																																																																	
SL1050A1	3M TRANSFER ADHESIVE TAPE	0.820	M																																																																																																																	
TB2301A0		2	PZ																																																																																																																	
VM1025A0	Ø16 GREY NYLON LID	2	PZ																																																																																																																	
VM1059A1		1.350	M																																																																																																																	
VM1695A0	HANDLE POSITION PIN	2	PZ																																																																																																																	
VM1916A0	RIGHT UPPER COLUMN CAP	1	PZ																																																																																																																	
VM1917A0	LEFT UPPER COLUMN CAP	1	PZ																																																																																																																	
VM1918A0	RIGHT LOWER COLUMN CAP	1	PZ																																																																																																																	
VM1919A0	LEFT LOWER COLUMN CAP	1	PZ																																																																																																																	
VM1920A0	INTERNAL GLASS CLOSING RIGHT PLATE	1	PZ																																																																																																																	
VM1921A0	INTERNAL GLASS CLOSING LEFT PLATE	1	PZ																																																																																																																	
VT1071A2		1	PZ																																																																																																																	
Code	Description	Qty	UOM																																																																																																																	
IP1385A1		0.800	M																																																																																																																	
IP1508A0		1.710	PZ																																																																																																																	
RC1200A0	ED=4 WIRE D.=0.5 COMPRESSIO N SPRING	2	PZ																																																																																																																	
SL1050A1	3M TRANSFER ADHESIVE TAPE	0.660	M																																																																																																																	
TB2306A0	LMISS STEFANIA/ELE NA DOOR RIGHT COLUM	2	PZ																																																																																																																	
VM1025A0	Ø16 GREY NYLON LID	2	PZ																																																																																																																	
VM1059A1		1.350	M																																																																																																																	
VM1695A0	HANDLE POSITION PIN	2	PZ																																																																																																																	
VM1916A0	RIGHT UPPER COLUMN CAP	1	PZ																																																																																																																	
VM1917A0	LEFT UPPER COLUMN CAP	1	PZ																																																																																																																	





COMPONENT			SPARE PART																																																															
Code	Description	Image	Code	Description	Components list																																																													
VM1920A	INTERNAL GLASS CLOSING RIGHT PLATE		KVT1067A	L.M. ELENA BLACK EXTERNAL GLASS KIT	<table border="1"> <thead> <tr> <th>Code</th> <th>Description</th> <th>Qty</th> <th>UOM</th> </tr> </thead> <tbody> <tr> <td>VM1918A0</td> <td>RIGHT LOWER COLUMN CAP</td> <td>1</td> <td>PZ</td> </tr> <tr> <td>VM1919A0</td> <td>LEFT LOWER COLUMN CAP</td> <td>1</td> <td>PZ</td> </tr> <tr> <td>VM1920A0</td> <td>INTERNAL GLASS CLOSING RIGHT PLATE</td> <td>1</td> <td>PZ</td> </tr> <tr> <td>VM1921A0</td> <td>INTERNAL GLASS CLOSING LEFT PLATE</td> <td>1</td> <td>PZ</td> </tr> <tr> <td>VT1067A0</td> <td>LINEMISS ELENA BLACK EXTERNAL DOOR GLASS</td> <td>1</td> <td>PZ</td> </tr> </tbody> </table>	Code	Description	Qty	UOM	VM1918A0	RIGHT LOWER COLUMN CAP	1	PZ	VM1919A0	LEFT LOWER COLUMN CAP	1	PZ	VM1920A0	INTERNAL GLASS CLOSING RIGHT PLATE	1	PZ	VM1921A0	INTERNAL GLASS CLOSING LEFT PLATE	1	PZ	VT1067A0	LINEMISS ELENA BLACK EXTERNAL DOOR GLASS	1	PZ																																					
			Code	Description	Qty	UOM																																																												
VM1918A0	RIGHT LOWER COLUMN CAP	1	PZ																																																															
VM1919A0	LEFT LOWER COLUMN CAP	1	PZ																																																															
VM1920A0	INTERNAL GLASS CLOSING RIGHT PLATE	1	PZ																																																															
VM1921A0	INTERNAL GLASS CLOSING LEFT PLATE	1	PZ																																																															
VT1067A0	LINEMISS ELENA BLACK EXTERNAL DOOR GLASS	1	PZ																																																															
KVT1066A	L.M. ELENA EXTERNAL GLASS KIT	<table border="1"> <thead> <tr> <th>Code</th> <th>Description</th> <th>Qty</th> <th>UOM</th> </tr> </thead> <tbody> <tr> <td>IP1385A1</td> <td></td> <td>0.800</td> <td>M</td> </tr> <tr> <td>IP1508A0</td> <td></td> <td>1.710</td> <td>PZ</td> </tr> <tr> <td>RC1200A0</td> <td>ED=4 WIRE D.=0.5 COMPRESSIO N SPRING</td> <td>2</td> <td>PZ</td> </tr> <tr> <td>SL1050A1</td> <td>3M TRANSFER ADHESIVE TAPE</td> <td>0.660</td> <td>M</td> </tr> <tr> <td>TB2306A0</td> <td>LMISS STEFANIA/ELE NA DOOR RIGHT COLUM</td> <td>2</td> <td>PZ</td> </tr> <tr> <td>VM1025A0</td> <td>Ø16 GREY NYLON LID</td> <td>2</td> <td>PZ</td> </tr> <tr> <td>VM1059A1</td> <td></td> <td>1.350</td> <td>M</td> </tr> <tr> <td>VM1695A0</td> <td>HANDLE POSITION PIN</td> <td>2</td> <td>PZ</td> </tr> <tr> <td>VM1916A0</td> <td>RIGHT UPPER COLUMN CAP</td> <td>1</td> <td>PZ</td> </tr> <tr> <td>VM1917A0</td> <td>LEFT UPPER COLUMN CAP</td> <td>1</td> <td>PZ</td> </tr> <tr> <td>VM1918A0</td> <td>RIGHT LOWER COLUMN CAP</td> <td>1</td> <td>PZ</td> </tr> <tr> <td>VM1919A0</td> <td>LEFT LOWER COLUMN CAP</td> <td>1</td> <td>PZ</td> </tr> <tr> <td>VM1920A0</td> <td>INTERNAL GLASS CLOSING RIGHT PLATE</td> <td>1</td> <td>PZ</td> </tr> <tr> <td>VM1921A0</td> <td>INTERNAL GLASS CLOSING LEFT PLATE</td> <td>1</td> <td>PZ</td> </tr> <tr> <td>VT1066A2</td> <td></td> <td>1</td> <td>PZ</td> </tr> </tbody> </table>	Code	Description	Qty	UOM	IP1385A1		0.800	M	IP1508A0		1.710	PZ	RC1200A0	ED=4 WIRE D.=0.5 COMPRESSIO N SPRING	2	PZ	SL1050A1	3M TRANSFER ADHESIVE TAPE	0.660	M	TB2306A0	LMISS STEFANIA/ELE NA DOOR RIGHT COLUM	2	PZ	VM1025A0	Ø16 GREY NYLON LID	2	PZ	VM1059A1		1.350	M	VM1695A0	HANDLE POSITION PIN	2	PZ	VM1916A0	RIGHT UPPER COLUMN CAP	1	PZ	VM1917A0	LEFT UPPER COLUMN CAP	1	PZ	VM1918A0	RIGHT LOWER COLUMN CAP	1	PZ	VM1919A0	LEFT LOWER COLUMN CAP	1	PZ	VM1920A0	INTERNAL GLASS CLOSING RIGHT PLATE	1	PZ	VM1921A0	INTERNAL GLASS CLOSING LEFT PLATE	1	PZ	VT1066A2		1	PZ
Code	Description	Qty	UOM																																																															
IP1385A1		0.800	M																																																															
IP1508A0		1.710	PZ																																																															
RC1200A0	ED=4 WIRE D.=0.5 COMPRESSIO N SPRING	2	PZ																																																															
SL1050A1	3M TRANSFER ADHESIVE TAPE	0.660	M																																																															
TB2306A0	LMISS STEFANIA/ELE NA DOOR RIGHT COLUM	2	PZ																																																															
VM1025A0	Ø16 GREY NYLON LID	2	PZ																																																															
VM1059A1		1.350	M																																																															
VM1695A0	HANDLE POSITION PIN	2	PZ																																																															
VM1916A0	RIGHT UPPER COLUMN CAP	1	PZ																																																															
VM1917A0	LEFT UPPER COLUMN CAP	1	PZ																																																															
VM1918A0	RIGHT LOWER COLUMN CAP	1	PZ																																																															
VM1919A0	LEFT LOWER COLUMN CAP	1	PZ																																																															
VM1920A0	INTERNAL GLASS CLOSING RIGHT PLATE	1	PZ																																																															
VM1921A0	INTERNAL GLASS CLOSING LEFT PLATE	1	PZ																																																															
VT1066A2		1	PZ																																																															



COMPONENT			SPARE PART																																																																																													
Code	Description	Image	Code	Description	Components list																																																																																											
VM1920A	INTERNAL GLASS CLOSING RIGHT PLATE		KVT1063A	L.MISS ARIANNA FORNETTI EXT. GLASS KIT	<table border="1"> <thead> <tr> <th>Code</th> <th>Description</th> <th>Qty</th> <th>UOM</th> </tr> </thead> <tbody> <tr> <td>IP1385A1</td> <td></td> <td>0.980</td> <td>M</td> </tr> <tr> <td>IP1508A0</td> <td></td> <td>0.960</td> <td>PZ</td> </tr> <tr> <td>MS1009A0</td> <td>FORNETTI LOGO LABEL</td> <td>1</td> <td>PZ</td> </tr> <tr> <td>RC1200A0</td> <td>ED=4 WIRE D.=0.5 COMPRESSIO N SPRING</td> <td>2</td> <td>PZ</td> </tr> <tr> <td>SL1050A1</td> <td>3M TRANSFER ADHESIVE TAPE</td> <td>0.820</td> <td>M</td> </tr> <tr> <td>TB2301A0</td> <td></td> <td>2</td> <td>PZ</td> </tr> <tr> <td>VM1025A0</td> <td>Ø16 GREY NYLON LID</td> <td>2</td> <td>PZ</td> </tr> <tr> <td>VM1059A1</td> <td></td> <td>1.300</td> <td>M</td> </tr> <tr> <td>VM1695A0</td> <td>HANDLE POSITION PIN</td> <td>2</td> <td>PZ</td> </tr> <tr> <td>VM1920A0</td> <td>INTERNAL GLASS CLOSING RIGHT PLATE</td> <td>1</td> <td>PZ</td> </tr> <tr> <td>VM1921A0</td> <td>INTERNAL GLASS CLOSING LEFT PLATE</td> <td>1</td> <td>PZ</td> </tr> <tr> <td>VM2062A0</td> <td>L.MISS 46X33 RIGHT UPPER DOOR COLUMN CAP</td> <td>1</td> <td>PZ</td> </tr> <tr> <td>VM2063A0</td> <td>L.MISS 46X33 LEFT UPPER DOOR COLUMN CAP</td> <td>1</td> <td>PZ</td> </tr> <tr> <td>VM2064A0</td> <td>L.MISS 46X33 RIGHT LOWER DOOR COLUMN CAP</td> <td>1</td> <td>PZ</td> </tr> <tr> <td>VM2065A0</td> <td>L.MISS 46X33 LEFT LOWER DOOR COLUMN CAP</td> <td>1</td> <td>PZ</td> </tr> <tr> <td>VT1063A0</td> <td>XF135F EXTERNAL GLASS 598X42</td> <td>1</td> <td>PZ</td> </tr> </tbody> </table>	Code	Description	Qty	UOM	IP1385A1		0.980	M	IP1508A0		0.960	PZ	MS1009A0	FORNETTI LOGO LABEL	1	PZ	RC1200A0	ED=4 WIRE D.=0.5 COMPRESSIO N SPRING	2	PZ	SL1050A1	3M TRANSFER ADHESIVE TAPE	0.820	M	TB2301A0		2	PZ	VM1025A0	Ø16 GREY NYLON LID	2	PZ	VM1059A1		1.300	M	VM1695A0	HANDLE POSITION PIN	2	PZ	VM1920A0	INTERNAL GLASS CLOSING RIGHT PLATE	1	PZ	VM1921A0	INTERNAL GLASS CLOSING LEFT PLATE	1	PZ	VM2062A0	L.MISS 46X33 RIGHT UPPER DOOR COLUMN CAP	1	PZ	VM2063A0	L.MISS 46X33 LEFT UPPER DOOR COLUMN CAP	1	PZ	VM2064A0	L.MISS 46X33 RIGHT LOWER DOOR COLUMN CAP	1	PZ	VM2065A0	L.MISS 46X33 LEFT LOWER DOOR COLUMN CAP	1	PZ	VT1063A0	XF135F EXTERNAL GLASS 598X42	1	PZ	KVT1062A	L.M. ARIANNA BLACK EXTERNAL GLASS KIT	<table border="1"> <thead> <tr> <th>Code</th> <th>Description</th> <th>Qty</th> <th>UOM</th> </tr> </thead> <tbody> <tr> <td>IP1385A1</td> <td></td> <td>1.280</td> <td>M</td> </tr> <tr> <td>RC1200A0</td> <td>ED=4 WIRE D.=0.5 COMPRESSIO N SPRING</td> <td>2</td> <td>PZ</td> </tr> <tr> <td>SL1050A1</td> <td>3M TRANSFER ADHESIVE TAPE</td> <td>0.820</td> <td>M</td> </tr> <tr> <td>TB2301A0</td> <td></td> <td>2</td> <td>PZ</td> </tr> </tbody> </table>	Code	Description	Qty	UOM	IP1385A1		1.280	M	RC1200A0	ED=4 WIRE D.=0.5 COMPRESSIO N SPRING	2	PZ	SL1050A1	3M TRANSFER ADHESIVE TAPE	0.820	M	TB2301A0		2	PZ
			Code	Description	Qty	UOM																																																																																										
IP1385A1		0.980	M																																																																																													
IP1508A0		0.960	PZ																																																																																													
MS1009A0	FORNETTI LOGO LABEL	1	PZ																																																																																													
RC1200A0	ED=4 WIRE D.=0.5 COMPRESSIO N SPRING	2	PZ																																																																																													
SL1050A1	3M TRANSFER ADHESIVE TAPE	0.820	M																																																																																													
TB2301A0		2	PZ																																																																																													
VM1025A0	Ø16 GREY NYLON LID	2	PZ																																																																																													
VM1059A1		1.300	M																																																																																													
VM1695A0	HANDLE POSITION PIN	2	PZ																																																																																													
VM1920A0	INTERNAL GLASS CLOSING RIGHT PLATE	1	PZ																																																																																													
VM1921A0	INTERNAL GLASS CLOSING LEFT PLATE	1	PZ																																																																																													
VM2062A0	L.MISS 46X33 RIGHT UPPER DOOR COLUMN CAP	1	PZ																																																																																													
VM2063A0	L.MISS 46X33 LEFT UPPER DOOR COLUMN CAP	1	PZ																																																																																													
VM2064A0	L.MISS 46X33 RIGHT LOWER DOOR COLUMN CAP	1	PZ																																																																																													
VM2065A0	L.MISS 46X33 LEFT LOWER DOOR COLUMN CAP	1	PZ																																																																																													
VT1063A0	XF135F EXTERNAL GLASS 598X42	1	PZ																																																																																													
Code	Description	Qty	UOM																																																																																													
IP1385A1		1.280	M																																																																																													
RC1200A0	ED=4 WIRE D.=0.5 COMPRESSIO N SPRING	2	PZ																																																																																													
SL1050A1	3M TRANSFER ADHESIVE TAPE	0.820	M																																																																																													
TB2301A0		2	PZ																																																																																													

COMPONENT			SPARE PART																																														
Code	Description	Image	Code	Description	Components list																																												
VM1920A	INTERNAL GLASS CLOSING RIGHT PLATE		KVT1062A	L.M. ARIANNA BLACK EXTERNAL GLASS KIT	<table border="1"> <thead> <tr> <th>Code</th> <th>Description</th> <th>Qty</th> <th>UOM</th> </tr> </thead> <tbody> <tr> <td>VM1025A0</td> <td>Ø16 GREY NYLON LID</td> <td>2</td> <td>PZ</td> </tr> <tr> <td>VM1059A1</td> <td></td> <td>1</td> <td>M</td> </tr> <tr> <td>VM1695A0</td> <td>HANDLE POSITION PIN</td> <td>2</td> <td>PZ</td> </tr> <tr> <td>VM1920A0</td> <td>INTERNAL GLASS CLOSING RIGHT PLATE</td> <td>1</td> <td>PZ</td> </tr> <tr> <td>VM1921A0</td> <td>INTERNAL GLASS CLOSING LEFT PLATE</td> <td>1</td> <td>PZ</td> </tr> <tr> <td>VM2062A0</td> <td>L.MISS 46X33 RIGHT UPPER DOOR COLUMN CAP</td> <td>1</td> <td>PZ</td> </tr> <tr> <td>VM2063A0</td> <td>L.MISS 46X33 LEFT UPPER DOOR COLUMN CAP</td> <td>1</td> <td>PZ</td> </tr> <tr> <td>VM2064A0</td> <td>L.MISS 46X33 RIGHT LOWER DOOR COLUMN CAP</td> <td>1</td> <td>PZ</td> </tr> <tr> <td>VM2065A0</td> <td>L.MISS 46X33 LEFT LOWER DOOR COLUMN CAP</td> <td>1</td> <td>PZ</td> </tr> <tr> <td>VT1062A0</td> <td>LINEMISS ARIANNA GREY EXTERNAL GLASS</td> <td>1</td> <td>PZ</td> </tr> </tbody> </table>	Code	Description	Qty	UOM	VM1025A0	Ø16 GREY NYLON LID	2	PZ	VM1059A1		1	M	VM1695A0	HANDLE POSITION PIN	2	PZ	VM1920A0	INTERNAL GLASS CLOSING RIGHT PLATE	1	PZ	VM1921A0	INTERNAL GLASS CLOSING LEFT PLATE	1	PZ	VM2062A0	L.MISS 46X33 RIGHT UPPER DOOR COLUMN CAP	1	PZ	VM2063A0	L.MISS 46X33 LEFT UPPER DOOR COLUMN CAP	1	PZ	VM2064A0	L.MISS 46X33 RIGHT LOWER DOOR COLUMN CAP	1	PZ	VM2065A0	L.MISS 46X33 LEFT LOWER DOOR COLUMN CAP	1	PZ	VT1062A0	LINEMISS ARIANNA GREY EXTERNAL GLASS	1	PZ
			Code	Description	Qty	UOM																																											
VM1025A0	Ø16 GREY NYLON LID	2	PZ																																														
VM1059A1		1	M																																														
VM1695A0	HANDLE POSITION PIN	2	PZ																																														
VM1920A0	INTERNAL GLASS CLOSING RIGHT PLATE	1	PZ																																														
VM1921A0	INTERNAL GLASS CLOSING LEFT PLATE	1	PZ																																														
VM2062A0	L.MISS 46X33 RIGHT UPPER DOOR COLUMN CAP	1	PZ																																														
VM2063A0	L.MISS 46X33 LEFT UPPER DOOR COLUMN CAP	1	PZ																																														
VM2064A0	L.MISS 46X33 RIGHT LOWER DOOR COLUMN CAP	1	PZ																																														
VM2065A0	L.MISS 46X33 LEFT LOWER DOOR COLUMN CAP	1	PZ																																														
VT1062A0	LINEMISS ARIANNA GREY EXTERNAL GLASS	1	PZ																																														
KVT1061A	L.M. ARIANNA EXTERNAL YELLOW GLASS KIT	<table border="1"> <thead> <tr> <th>Code</th> <th>Description</th> <th>Qty</th> <th>UOM</th> </tr> </thead> <tbody> <tr> <td>IP1385A1</td> <td></td> <td>1.280</td> <td>M</td> </tr> <tr> <td>RC1200A0</td> <td>ED=4 WIRE D.=0.5 COMPRESSIO N SPRING</td> <td>2</td> <td>PZ</td> </tr> <tr> <td>SL1050A1</td> <td>3M TRANSFER ADHESIVE TAPE</td> <td>0.820</td> <td>M</td> </tr> <tr> <td>TB2301A0</td> <td></td> <td>2</td> <td>PZ</td> </tr> <tr> <td>VM1025A0</td> <td>Ø16 GREY NYLON LID</td> <td>2</td> <td>PZ</td> </tr> <tr> <td>VM1059A1</td> <td></td> <td>1.300</td> <td>M</td> </tr> <tr> <td>VM1695A0</td> <td>HANDLE POSITION PIN</td> <td>2</td> <td>PZ</td> </tr> <tr> <td>VM1920A0</td> <td>INTERNAL GLASS CLOSING RIGHT PLATE</td> <td>1</td> <td>PZ</td> </tr> </tbody> </table>	Code	Description	Qty	UOM	IP1385A1		1.280	M	RC1200A0	ED=4 WIRE D.=0.5 COMPRESSIO N SPRING	2	PZ	SL1050A1	3M TRANSFER ADHESIVE TAPE	0.820	M	TB2301A0		2	PZ	VM1025A0	Ø16 GREY NYLON LID	2	PZ	VM1059A1		1.300	M	VM1695A0	HANDLE POSITION PIN	2	PZ	VM1920A0	INTERNAL GLASS CLOSING RIGHT PLATE	1	PZ											
Code	Description	Qty	UOM																																														
IP1385A1		1.280	M																																														
RC1200A0	ED=4 WIRE D.=0.5 COMPRESSIO N SPRING	2	PZ																																														
SL1050A1	3M TRANSFER ADHESIVE TAPE	0.820	M																																														
TB2301A0		2	PZ																																														
VM1025A0	Ø16 GREY NYLON LID	2	PZ																																														
VM1059A1		1.300	M																																														
VM1695A0	HANDLE POSITION PIN	2	PZ																																														
VM1920A0	INTERNAL GLASS CLOSING RIGHT PLATE	1	PZ																																														

COMPONENT			SPARE PART																																															
Code	Description	Image	Code	Description	Components list																																													
VM1920A	INTERNAL GLASS CLOSING RIGHT PLATE		KVT1061A	L.M. ARIANNA EXTERNAL YELLOW GLASS KIT	<table border="1"> <thead> <tr> <th>Code</th> <th>Description</th> <th>Qty</th> <th>UOM</th> </tr> </thead> <tbody> <tr> <td>VM1921A0</td> <td>INTERNAL GLASS CLOSING LEFT PLATE</td> <td>1</td> <td>PZ</td> </tr> <tr> <td>VM2062A0</td> <td>L.MISS 46X33 RIGHT UPPER DOOR COLUMN CAP</td> <td>1</td> <td>PZ</td> </tr> <tr> <td>VM2063A0</td> <td>L.MISS 46X33 LEFT UPPER DOOR COLUMN CAP</td> <td>1</td> <td>PZ</td> </tr> <tr> <td>VM2064A0</td> <td>L.MISS 46X33 RIGHT LOWER DOOR COLUMN CAP</td> <td>1</td> <td>PZ</td> </tr> <tr> <td>VM2065A0</td> <td>L.MISS 46X33 LEFT LOWER DOOR COLUMN CAP</td> <td>1</td> <td>PZ</td> </tr> <tr> <td>VT1061A2</td> <td>EXTERNAL YELLOW SER.GLASS 598X424X5</td> <td>1</td> <td>PZ</td> </tr> </tbody> </table>	Code	Description	Qty	UOM	VM1921A0	INTERNAL GLASS CLOSING LEFT PLATE	1	PZ	VM2062A0	L.MISS 46X33 RIGHT UPPER DOOR COLUMN CAP	1	PZ	VM2063A0	L.MISS 46X33 LEFT UPPER DOOR COLUMN CAP	1	PZ	VM2064A0	L.MISS 46X33 RIGHT LOWER DOOR COLUMN CAP	1	PZ	VM2065A0	L.MISS 46X33 LEFT LOWER DOOR COLUMN CAP	1	PZ	VT1061A2	EXTERNAL YELLOW SER.GLASS 598X424X5	1	PZ																	
			Code	Description	Qty	UOM																																												
VM1921A0	INTERNAL GLASS CLOSING LEFT PLATE	1	PZ																																															
VM2062A0	L.MISS 46X33 RIGHT UPPER DOOR COLUMN CAP	1	PZ																																															
VM2063A0	L.MISS 46X33 LEFT UPPER DOOR COLUMN CAP	1	PZ																																															
VM2064A0	L.MISS 46X33 RIGHT LOWER DOOR COLUMN CAP	1	PZ																																															
VM2065A0	L.MISS 46X33 LEFT LOWER DOOR COLUMN CAP	1	PZ																																															
VT1061A2	EXTERNAL YELLOW SER.GLASS 598X424X5	1	PZ																																															
KVT1057A	L.MISS STEFANIA BLACK EXTERNAL GLASS KIT	<table border="1"> <thead> <tr> <th>Code</th> <th>Description</th> <th>Qty</th> <th>UOM</th> </tr> </thead> <tbody> <tr> <td>IP1385A1</td> <td></td> <td>0.810</td> <td>M</td> </tr> <tr> <td>IP1508A0</td> <td></td> <td>0.950</td> <td>PZ</td> </tr> <tr> <td>RC1200A0</td> <td>ED=4 WIRE D.=0.5 COMPRESSION SPRING</td> <td>2</td> <td>PZ</td> </tr> <tr> <td>SL1050A1</td> <td>3M TRANSFER ADHESIVE TAPE</td> <td>0.660</td> <td>M</td> </tr> <tr> <td>TB2306A0</td> <td>LMISS STEFANIA/ELENA DOOR RIGHT COLUM</td> <td>2</td> <td>PZ</td> </tr> <tr> <td>VM1025A0</td> <td>Ø16 GREY NYLON LID</td> <td>2</td> <td>PZ</td> </tr> <tr> <td>VM1059A1</td> <td></td> <td>1</td> <td>M</td> </tr> <tr> <td>VM1695A0</td> <td>HANDLE POSITION PIN</td> <td>2</td> <td>PZ</td> </tr> <tr> <td>VM1920A0</td> <td>INTERNAL GLASS CLOSING RIGHT PLATE</td> <td>1</td> <td>PZ</td> </tr> <tr> <td>VM1921A0</td> <td>INTERNAL GLASS CLOSING LEFT PLATE</td> <td>1</td> <td>PZ</td> </tr> <tr> <td>VM2062A0</td> <td>L.MISS 46X33 RIGHT UPPER DOOR COLUMN CAP</td> <td>1</td> <td>PZ</td> </tr> </tbody> </table>	Code	Description	Qty	UOM	IP1385A1		0.810	M	IP1508A0		0.950	PZ	RC1200A0	ED=4 WIRE D.=0.5 COMPRESSION SPRING	2	PZ	SL1050A1	3M TRANSFER ADHESIVE TAPE	0.660	M	TB2306A0	LMISS STEFANIA/ELENA DOOR RIGHT COLUM	2	PZ	VM1025A0	Ø16 GREY NYLON LID	2	PZ	VM1059A1		1	M	VM1695A0	HANDLE POSITION PIN	2	PZ	VM1920A0	INTERNAL GLASS CLOSING RIGHT PLATE	1	PZ	VM1921A0	INTERNAL GLASS CLOSING LEFT PLATE	1	PZ	VM2062A0	L.MISS 46X33 RIGHT UPPER DOOR COLUMN CAP	1	PZ
Code	Description	Qty	UOM																																															
IP1385A1		0.810	M																																															
IP1508A0		0.950	PZ																																															
RC1200A0	ED=4 WIRE D.=0.5 COMPRESSION SPRING	2	PZ																																															
SL1050A1	3M TRANSFER ADHESIVE TAPE	0.660	M																																															
TB2306A0	LMISS STEFANIA/ELENA DOOR RIGHT COLUM	2	PZ																																															
VM1025A0	Ø16 GREY NYLON LID	2	PZ																																															
VM1059A1		1	M																																															
VM1695A0	HANDLE POSITION PIN	2	PZ																																															
VM1920A0	INTERNAL GLASS CLOSING RIGHT PLATE	1	PZ																																															
VM1921A0	INTERNAL GLASS CLOSING LEFT PLATE	1	PZ																																															
VM2062A0	L.MISS 46X33 RIGHT UPPER DOOR COLUMN CAP	1	PZ																																															

COMPONENT			SPARE PART																																																			
Code	Description	Image	Code	Description	Components list																																																	
VM1920A	INTERNAL GLASS CLOSING RIGHT PLATE		KVT1057A	L.MISS STEFANIA BLACK EXTERNAL GLASS KIT	<table border="1"> <thead> <tr> <th>Code</th> <th>Description</th> <th>Qty</th> <th>UOM</th> </tr> </thead> <tbody> <tr> <td>VM2063A0</td> <td>L.MISS 46X33 LEFT UPPER DOOR COLUMN CAP</td> <td>1</td> <td>PZ</td> </tr> <tr> <td>VM2064A0</td> <td>L.MISS 46X33 RIGHT LOWER DOOR COLUMN CAP</td> <td>1</td> <td>PZ</td> </tr> <tr> <td>VM2065A0</td> <td>L.MISS 46X33 LEFT LOWER DOOR COLUMN CAP</td> <td>1</td> <td>PZ</td> </tr> <tr> <td>VT1057A0</td> <td>L.MISS STEFANIA EXTERNAL GLASS 598X344X5</td> <td>1</td> <td>PZ</td> </tr> </tbody> </table>	Code	Description	Qty	UOM	VM2063A0	L.MISS 46X33 LEFT UPPER DOOR COLUMN CAP	1	PZ	VM2064A0	L.MISS 46X33 RIGHT LOWER DOOR COLUMN CAP	1	PZ	VM2065A0	L.MISS 46X33 LEFT LOWER DOOR COLUMN CAP	1	PZ	VT1057A0	L.MISS STEFANIA EXTERNAL GLASS 598X344X5	1	PZ																													
			Code	Description	Qty	UOM																																																
VM2063A0	L.MISS 46X33 LEFT UPPER DOOR COLUMN CAP	1	PZ																																																			
VM2064A0	L.MISS 46X33 RIGHT LOWER DOOR COLUMN CAP	1	PZ																																																			
VM2065A0	L.MISS 46X33 LEFT LOWER DOOR COLUMN CAP	1	PZ																																																			
VT1057A0	L.MISS STEFANIA EXTERNAL GLASS 598X344X5	1	PZ																																																			
KVT1056A	L.M. STEFANIA YELLOW EXTERNAL GLASS KIT	<table border="1"> <thead> <tr> <th>Code</th> <th>Description</th> <th>Qty</th> <th>UOM</th> </tr> </thead> <tbody> <tr> <td>IP1385A1</td> <td></td> <td>0.980</td> <td>M</td> </tr> <tr> <td>IP1508A0</td> <td></td> <td>0.960</td> <td>PZ</td> </tr> <tr> <td>RC1200A0</td> <td>ED=4 WIRE D.=0.5 COMPRESSIO N SPRING</td> <td>2</td> <td>PZ</td> </tr> <tr> <td>SL1050A1</td> <td>3M TRANSFER ADHESIVE TAPE</td> <td>0.660</td> <td>M</td> </tr> <tr> <td>TB2306A0</td> <td>LMISS STEFANIA/ELE NA DOOR RIGHT COLUM</td> <td>2</td> <td>PZ</td> </tr> <tr> <td>VM1025A0</td> <td>Ø16 GREY NYLON LID</td> <td>2</td> <td>PZ</td> </tr> <tr> <td>VM1059A1</td> <td></td> <td>1.300</td> <td>M</td> </tr> <tr> <td>VM1695A0</td> <td>HANDLE POSITION PIN</td> <td>2</td> <td>PZ</td> </tr> <tr> <td>VM1920A0</td> <td>INTERNAL GLASS CLOSING RIGHT PLATE</td> <td>1</td> <td>PZ</td> </tr> <tr> <td>VM1921A0</td> <td>INTERNAL GLASS CLOSING LEFT PLATE</td> <td>1</td> <td>PZ</td> </tr> <tr> <td>VM2062A0</td> <td>L.MISS 46X33 RIGHT UPPER DOOR COLUMN CAP</td> <td>1</td> <td>PZ</td> </tr> <tr> <td>VM2063A0</td> <td>L.MISS 46X33 LEFT UPPER DOOR COLUMN CAP</td> <td>1</td> <td>PZ</td> </tr> </tbody> </table>	Code	Description	Qty	UOM	IP1385A1		0.980	M	IP1508A0		0.960	PZ	RC1200A0	ED=4 WIRE D.=0.5 COMPRESSIO N SPRING	2	PZ	SL1050A1	3M TRANSFER ADHESIVE TAPE	0.660	M	TB2306A0	LMISS STEFANIA/ELE NA DOOR RIGHT COLUM	2	PZ	VM1025A0	Ø16 GREY NYLON LID	2	PZ	VM1059A1		1.300	M	VM1695A0	HANDLE POSITION PIN	2	PZ	VM1920A0	INTERNAL GLASS CLOSING RIGHT PLATE	1	PZ	VM1921A0	INTERNAL GLASS CLOSING LEFT PLATE	1	PZ	VM2062A0	L.MISS 46X33 RIGHT UPPER DOOR COLUMN CAP	1	PZ	VM2063A0	L.MISS 46X33 LEFT UPPER DOOR COLUMN CAP	1	PZ
Code	Description	Qty	UOM																																																			
IP1385A1		0.980	M																																																			
IP1508A0		0.960	PZ																																																			
RC1200A0	ED=4 WIRE D.=0.5 COMPRESSIO N SPRING	2	PZ																																																			
SL1050A1	3M TRANSFER ADHESIVE TAPE	0.660	M																																																			
TB2306A0	LMISS STEFANIA/ELE NA DOOR RIGHT COLUM	2	PZ																																																			
VM1025A0	Ø16 GREY NYLON LID	2	PZ																																																			
VM1059A1		1.300	M																																																			
VM1695A0	HANDLE POSITION PIN	2	PZ																																																			
VM1920A0	INTERNAL GLASS CLOSING RIGHT PLATE	1	PZ																																																			
VM1921A0	INTERNAL GLASS CLOSING LEFT PLATE	1	PZ																																																			
VM2062A0	L.MISS 46X33 RIGHT UPPER DOOR COLUMN CAP	1	PZ																																																			
VM2063A0	L.MISS 46X33 LEFT UPPER DOOR COLUMN CAP	1	PZ																																																			

COMPONENT			SPARE PART																																																			
Code	Description	Image	Code	Description	Components list																																																	
VM1920A	INTERNAL GLASS CLOSING RIGHT PLATE		KVT1056A	L.M. STEFANIA YELLOW EXTERNAL GLASS KIT	<table border="1"> <thead> <tr> <th>Code</th> <th>Description</th> <th>Qty</th> <th>UOM</th> </tr> </thead> <tbody> <tr> <td>VM2064A0</td> <td>L.MISS 46X33 RIGHT LOWER DOOR COLUMN CAP</td> <td>1</td> <td>PZ</td> </tr> <tr> <td>VM2065A0</td> <td>L.MISS 46X33 LEFT LOWER DOOR COLUMN CAP</td> <td>1</td> <td>PZ</td> </tr> <tr> <td>VT1056A2</td> <td></td> <td>1</td> <td>PZ</td> </tr> </tbody> </table>	Code	Description	Qty	UOM	VM2064A0	L.MISS 46X33 RIGHT LOWER DOOR COLUMN CAP	1	PZ	VM2065A0	L.MISS 46X33 LEFT LOWER DOOR COLUMN CAP	1	PZ	VT1056A2		1	PZ																																	
			Code	Description	Qty	UOM																																																
VM2064A0	L.MISS 46X33 RIGHT LOWER DOOR COLUMN CAP	1	PZ																																																			
VM2065A0	L.MISS 46X33 LEFT LOWER DOOR COLUMN CAP	1	PZ																																																			
VT1056A2		1	PZ																																																			
KVT1052A	L.MISS CRISTINA BLACK EXTERNAL GLASS KIT	<table border="1"> <thead> <tr> <th>Code</th> <th>Description</th> <th>Qty</th> <th>UOM</th> </tr> </thead> <tbody> <tr> <td>RC1200A0</td> <td>ED=4 WIRE D.=0.5 COMPRESSIO N SPRING</td> <td>2</td> <td>PZ</td> </tr> <tr> <td>SL1050A1</td> <td>3M TRANSFER ADHESIVE TAPE</td> <td>0.660</td> <td>M</td> </tr> <tr> <td>TB2306A0</td> <td>L.MISS STEFANIA/ELE NA DOOR RIGHT COLUM</td> <td>2</td> <td>PZ</td> </tr> <tr> <td>VM1025A0</td> <td>Ø16 GREY NYLON LID</td> <td>2</td> <td>PZ</td> </tr> <tr> <td>VM1695A0</td> <td>HANDLE POSITION PIN</td> <td>2</td> <td>PZ</td> </tr> <tr> <td>VM1920A0</td> <td>INTERNAL GLASS CLOSING RIGHT PLATE</td> <td>1</td> <td>PZ</td> </tr> <tr> <td>VM1921A0</td> <td>INTERNAL GLASS CLOSING LEFT PLATE</td> <td>1</td> <td>PZ</td> </tr> <tr> <td>VM2062A0</td> <td>L.MISS 46X33 RIGHT UPPER DOOR COLUMN CAP</td> <td>1</td> <td>PZ</td> </tr> <tr> <td>VM2063A0</td> <td>L.MISS 46X33 LEFT UPPER DOOR COLUMN CAP</td> <td>1</td> <td>PZ</td> </tr> <tr> <td>VM2064A0</td> <td>L.MISS 46X33 RIGHT LOWER DOOR COLUMN CAP</td> <td>1</td> <td>PZ</td> </tr> <tr> <td>VM2065A0</td> <td>L.MISS 46X33 LEFT LOWER DOOR COLUMN CAP</td> <td>1</td> <td>PZ</td> </tr> <tr> <td>VT1052A0</td> <td>478X344X5 EXTERNAL GLASS</td> <td>1</td> <td>PZ</td> </tr> </tbody> </table>	Code	Description	Qty	UOM	RC1200A0	ED=4 WIRE D.=0.5 COMPRESSIO N SPRING	2	PZ	SL1050A1	3M TRANSFER ADHESIVE TAPE	0.660	M	TB2306A0	L.MISS STEFANIA/ELE NA DOOR RIGHT COLUM	2	PZ	VM1025A0	Ø16 GREY NYLON LID	2	PZ	VM1695A0	HANDLE POSITION PIN	2	PZ	VM1920A0	INTERNAL GLASS CLOSING RIGHT PLATE	1	PZ	VM1921A0	INTERNAL GLASS CLOSING LEFT PLATE	1	PZ	VM2062A0	L.MISS 46X33 RIGHT UPPER DOOR COLUMN CAP	1	PZ	VM2063A0	L.MISS 46X33 LEFT UPPER DOOR COLUMN CAP	1	PZ	VM2064A0	L.MISS 46X33 RIGHT LOWER DOOR COLUMN CAP	1	PZ	VM2065A0	L.MISS 46X33 LEFT LOWER DOOR COLUMN CAP	1	PZ	VT1052A0	478X344X5 EXTERNAL GLASS	1	PZ
Code	Description	Qty	UOM																																																			
RC1200A0	ED=4 WIRE D.=0.5 COMPRESSIO N SPRING	2	PZ																																																			
SL1050A1	3M TRANSFER ADHESIVE TAPE	0.660	M																																																			
TB2306A0	L.MISS STEFANIA/ELE NA DOOR RIGHT COLUM	2	PZ																																																			
VM1025A0	Ø16 GREY NYLON LID	2	PZ																																																			
VM1695A0	HANDLE POSITION PIN	2	PZ																																																			
VM1920A0	INTERNAL GLASS CLOSING RIGHT PLATE	1	PZ																																																			
VM1921A0	INTERNAL GLASS CLOSING LEFT PLATE	1	PZ																																																			
VM2062A0	L.MISS 46X33 RIGHT UPPER DOOR COLUMN CAP	1	PZ																																																			
VM2063A0	L.MISS 46X33 LEFT UPPER DOOR COLUMN CAP	1	PZ																																																			
VM2064A0	L.MISS 46X33 RIGHT LOWER DOOR COLUMN CAP	1	PZ																																																			
VM2065A0	L.MISS 46X33 LEFT LOWER DOOR COLUMN CAP	1	PZ																																																			
VT1052A0	478X344X5 EXTERNAL GLASS	1	PZ																																																			

COMPONENT			SPARE PART																																																																	
Code	Description	Image	Code	Description	Components list																																																															
VM1920A	INTERNAL GLASS CLOSING RIGHT PLATE		KVT1051A	L.M. CRISTINA YELLOW EXTERNAL GLASS KIT	<table border="1"> <thead> <tr> <th>Code</th> <th>Description</th> <th>Qty</th> <th>UOM</th> </tr> </thead> <tbody> <tr> <td>IP1385A1</td> <td></td> <td>1.040</td> <td>M</td> </tr> <tr> <td>RC1200A0</td> <td>ED=4 WIRE D.=0.5 COMPRESSIO N SPRING</td> <td>2</td> <td>PZ</td> </tr> <tr> <td>SL1050A1</td> <td>3M TRANSFER ADHESIVE TAPE</td> <td>0.660</td> <td>M</td> </tr> <tr> <td>TB2306A0</td> <td>LMISS STEFANIA/ELE NA DOOR RIGHT COLUM</td> <td>2</td> <td>PZ</td> </tr> <tr> <td>VM1025A0</td> <td>Ø16 GREY NYLON LID</td> <td>2</td> <td>PZ</td> </tr> <tr> <td>VM1059A1</td> <td></td> <td>1.500</td> <td>M</td> </tr> <tr> <td>VM1695A0</td> <td>HANDLE POSITION PIN</td> <td>2</td> <td>PZ</td> </tr> <tr> <td>VM1920A0</td> <td>INTERNAL GLASS CLOSING RIGHT PLATE</td> <td>1</td> <td>PZ</td> </tr> <tr> <td>VM1921A0</td> <td>INTERNAL GLASS CLOSING LEFT PLATE</td> <td>1</td> <td>PZ</td> </tr> <tr> <td>VM2062A0</td> <td>L.MISS 46X33 RIGHT UPPER DOOR COLUMN CAP</td> <td>1</td> <td>PZ</td> </tr> <tr> <td>VM2063A0</td> <td>L.MISS 46X33 LEFT UPPER DOOR COLUMN CAP</td> <td>1</td> <td>PZ</td> </tr> <tr> <td>VM2064A0</td> <td>L.MISS 46X33 RIGHT LOWER DOOR COLUMN CAP</td> <td>1</td> <td>PZ</td> </tr> <tr> <td>VM2065A0</td> <td>L.MISS 46X33 LEFT LOWER DOOR COLUMN CAP</td> <td>1</td> <td>PZ</td> </tr> <tr> <td></td> <td></td> <td></td> <td></td> <td>VT1051A2</td> <td>1</td> <td>PZ</td> </tr> </tbody> </table>	Code	Description	Qty	UOM	IP1385A1		1.040	M	RC1200A0	ED=4 WIRE D.=0.5 COMPRESSIO N SPRING	2	PZ	SL1050A1	3M TRANSFER ADHESIVE TAPE	0.660	M	TB2306A0	LMISS STEFANIA/ELE NA DOOR RIGHT COLUM	2	PZ	VM1025A0	Ø16 GREY NYLON LID	2	PZ	VM1059A1		1.500	M	VM1695A0	HANDLE POSITION PIN	2	PZ	VM1920A0	INTERNAL GLASS CLOSING RIGHT PLATE	1	PZ	VM1921A0	INTERNAL GLASS CLOSING LEFT PLATE	1	PZ	VM2062A0	L.MISS 46X33 RIGHT UPPER DOOR COLUMN CAP	1	PZ	VM2063A0	L.MISS 46X33 LEFT UPPER DOOR COLUMN CAP	1	PZ	VM2064A0	L.MISS 46X33 RIGHT LOWER DOOR COLUMN CAP	1	PZ	VM2065A0	L.MISS 46X33 LEFT LOWER DOOR COLUMN CAP	1	PZ					VT1051A2	1	PZ
					Code	Description	Qty	UOM																																																												
					IP1385A1		1.040	M																																																												
					RC1200A0	ED=4 WIRE D.=0.5 COMPRESSIO N SPRING	2	PZ																																																												
					SL1050A1	3M TRANSFER ADHESIVE TAPE	0.660	M																																																												
					TB2306A0	LMISS STEFANIA/ELE NA DOOR RIGHT COLUM	2	PZ																																																												
					VM1025A0	Ø16 GREY NYLON LID	2	PZ																																																												
					VM1059A1		1.500	M																																																												
					VM1695A0	HANDLE POSITION PIN	2	PZ																																																												
					VM1920A0	INTERNAL GLASS CLOSING RIGHT PLATE	1	PZ																																																												
					VM1921A0	INTERNAL GLASS CLOSING LEFT PLATE	1	PZ																																																												
					VM2062A0	L.MISS 46X33 RIGHT UPPER DOOR COLUMN CAP	1	PZ																																																												
					VM2063A0	L.MISS 46X33 LEFT UPPER DOOR COLUMN CAP	1	PZ																																																												
					VM2064A0	L.MISS 46X33 RIGHT LOWER DOOR COLUMN CAP	1	PZ																																																												
VM2065A0	L.MISS 46X33 LEFT LOWER DOOR COLUMN CAP	1	PZ																																																																	
				VT1051A2	1	PZ																																																														
VM1917A	LEFT UPPER COLUMN CAP		KVT1253A	ENGEFOOD XF195-EG EXTERNAL GLASS KIT	<table border="1"> <thead> <tr> <th>Code</th> <th>Description</th> <th>Qty</th> <th>UOM</th> </tr> </thead> <tbody> <tr> <td>IP1235B0</td> <td></td> <td>1</td> <td>PZ</td> </tr> <tr> <td>RC1200A0</td> <td>ED=4 WIRE D.=0.5 COMPRESSIO N SPRING</td> <td>2</td> <td>PZ</td> </tr> <tr> <td>SL1050A1</td> <td>3M TRANSFER ADHESIVE TAPE</td> <td>0.820</td> <td>M</td> </tr> <tr> <td>TB2301A0</td> <td></td> <td>2</td> <td>PZ</td> </tr> <tr> <td>VM1025A0</td> <td>Ø16 GREY NYLON LID</td> <td>2</td> <td>PZ</td> </tr> </tbody> </table>	Code	Description	Qty	UOM	IP1235B0		1	PZ	RC1200A0	ED=4 WIRE D.=0.5 COMPRESSIO N SPRING	2	PZ	SL1050A1	3M TRANSFER ADHESIVE TAPE	0.820	M	TB2301A0		2	PZ	VM1025A0	Ø16 GREY NYLON LID	2	PZ																																							
					Code	Description	Qty	UOM																																																												
					IP1235B0		1	PZ																																																												
					RC1200A0	ED=4 WIRE D.=0.5 COMPRESSIO N SPRING	2	PZ																																																												
					SL1050A1	3M TRANSFER ADHESIVE TAPE	0.820	M																																																												
					TB2301A0		2	PZ																																																												
VM1025A0	Ø16 GREY NYLON LID	2	PZ																																																																	



COMPONENT			SPARE PART																																																																		
Code	Description	Image	Code	Description	Components list																																																																
VM1917A	LEFT UPPER COLUMN CAP		KVT1253A	ENGEFOOD XF195-EG EXTERNAL GLASS KIT	<table border="1"> <thead> <tr> <th>Code</th> <th>Description</th> <th>Qty</th> <th>UOM</th> </tr> </thead> <tbody> <tr> <td>VM1695A0</td> <td>HANDLE POSITION PIN</td> <td>2</td> <td>PZ</td> </tr> <tr> <td>VM1916A0</td> <td>RIGHT UPPER COLUMN CAP</td> <td>1</td> <td>PZ</td> </tr> <tr> <td>VM1917A0</td> <td>LEFT UPPER COLUMN CAP</td> <td>1</td> <td>PZ</td> </tr> <tr> <td>VM1918A0</td> <td>RIGHT LOWER COLUMN CAP</td> <td>1</td> <td>PZ</td> </tr> <tr> <td>VM1919A0</td> <td>LEFT LOWER COLUMN CAP</td> <td>1</td> <td>PZ</td> </tr> <tr> <td>VM1920A0</td> <td>INTERNAL GLASS CLOSING RIGHT PLATE</td> <td>1</td> <td>PZ</td> </tr> <tr> <td>VM1921A0</td> <td>INTERNAL GLASS CLOSING LEFT PLATE</td> <td>1</td> <td>PZ</td> </tr> <tr> <td>VT1253A0</td> <td>XF195 BLACK EXTERNAL GLASS - ENGEFOOD</td> <td>1</td> <td>PZ</td> </tr> </tbody> </table>	Code	Description	Qty	UOM	VM1695A0	HANDLE POSITION PIN	2	PZ	VM1916A0	RIGHT UPPER COLUMN CAP	1	PZ	VM1917A0	LEFT UPPER COLUMN CAP	1	PZ	VM1918A0	RIGHT LOWER COLUMN CAP	1	PZ	VM1919A0	LEFT LOWER COLUMN CAP	1	PZ	VM1920A0	INTERNAL GLASS CLOSING RIGHT PLATE	1	PZ	VM1921A0	INTERNAL GLASS CLOSING LEFT PLATE	1	PZ	VT1253A0	XF195 BLACK EXTERNAL GLASS - ENGEFOOD	1	PZ																												
Code	Description	Qty	UOM																																																																		
VM1695A0	HANDLE POSITION PIN	2	PZ																																																																		
VM1916A0	RIGHT UPPER COLUMN CAP	1	PZ																																																																		
VM1917A0	LEFT UPPER COLUMN CAP	1	PZ																																																																		
VM1918A0	RIGHT LOWER COLUMN CAP	1	PZ																																																																		
VM1919A0	LEFT LOWER COLUMN CAP	1	PZ																																																																		
VM1920A0	INTERNAL GLASS CLOSING RIGHT PLATE	1	PZ																																																																		
VM1921A0	INTERNAL GLASS CLOSING LEFT PLATE	1	PZ																																																																		
VT1253A0	XF195 BLACK EXTERNAL GLASS - ENGEFOOD	1	PZ																																																																		
			KVT1072A	L.M. ROSSELLA BLACK EXTERNAL GLASS KIT	<table border="1"> <thead> <tr> <th>Code</th> <th>Description</th> <th>Qty</th> <th>UOM</th> </tr> </thead> <tbody> <tr> <td>IP1385A1</td> <td></td> <td>0.960</td> <td>M</td> </tr> <tr> <td>IP1508A0</td> <td></td> <td>1.280</td> <td>PZ</td> </tr> <tr> <td>RC1200A0</td> <td>ED=4 WIRE D.=0.5 COMPRESSIO N SPRING</td> <td>2</td> <td>PZ</td> </tr> <tr> <td>SL1050A1</td> <td>3M TRANSFER ADHESIVE TAPE</td> <td>0.820</td> <td>M</td> </tr> <tr> <td>TB2301A0</td> <td></td> <td>2</td> <td>PZ</td> </tr> <tr> <td>VM1025A0</td> <td>Ø16 GREY NYLON LID</td> <td>2</td> <td>PZ</td> </tr> <tr> <td>VM1059A1</td> <td></td> <td>1.300</td> <td>M</td> </tr> <tr> <td>VM1695A0</td> <td>HANDLE POSITION PIN</td> <td>2</td> <td>PZ</td> </tr> <tr> <td>VM1916A0</td> <td>RIGHT UPPER COLUMN CAP</td> <td>1</td> <td>PZ</td> </tr> <tr> <td>VM1917A0</td> <td>LEFT UPPER COLUMN CAP</td> <td>1</td> <td>PZ</td> </tr> <tr> <td>VM1918A0</td> <td>RIGHT LOWER COLUMN CAP</td> <td>1</td> <td>PZ</td> </tr> <tr> <td>VM1919A0</td> <td>LEFT LOWER COLUMN CAP</td> <td>1</td> <td>PZ</td> </tr> <tr> <td>VM1920A0</td> <td>INTERNAL GLASS CLOSING RIGHT PLATE</td> <td>1</td> <td>PZ</td> </tr> <tr> <td>VM1921A0</td> <td>INTERNAL GLASS CLOSING LEFT PLATE</td> <td>1</td> <td>PZ</td> </tr> <tr> <td>VT1072A0</td> <td>LINEMISS ROSSELLA BLACK EXTERNAL GLASS</td> <td>1</td> <td>PZ</td> </tr> </tbody> </table>	Code	Description	Qty	UOM	IP1385A1		0.960	M	IP1508A0		1.280	PZ	RC1200A0	ED=4 WIRE D.=0.5 COMPRESSIO N SPRING	2	PZ	SL1050A1	3M TRANSFER ADHESIVE TAPE	0.820	M	TB2301A0		2	PZ	VM1025A0	Ø16 GREY NYLON LID	2	PZ	VM1059A1		1.300	M	VM1695A0	HANDLE POSITION PIN	2	PZ	VM1916A0	RIGHT UPPER COLUMN CAP	1	PZ	VM1917A0	LEFT UPPER COLUMN CAP	1	PZ	VM1918A0	RIGHT LOWER COLUMN CAP	1	PZ	VM1919A0	LEFT LOWER COLUMN CAP	1	PZ	VM1920A0	INTERNAL GLASS CLOSING RIGHT PLATE	1	PZ	VM1921A0	INTERNAL GLASS CLOSING LEFT PLATE	1	PZ	VT1072A0	LINEMISS ROSSELLA BLACK EXTERNAL GLASS	1	PZ
Code	Description	Qty	UOM																																																																		
IP1385A1		0.960	M																																																																		
IP1508A0		1.280	PZ																																																																		
RC1200A0	ED=4 WIRE D.=0.5 COMPRESSIO N SPRING	2	PZ																																																																		
SL1050A1	3M TRANSFER ADHESIVE TAPE	0.820	M																																																																		
TB2301A0		2	PZ																																																																		
VM1025A0	Ø16 GREY NYLON LID	2	PZ																																																																		
VM1059A1		1.300	M																																																																		
VM1695A0	HANDLE POSITION PIN	2	PZ																																																																		
VM1916A0	RIGHT UPPER COLUMN CAP	1	PZ																																																																		
VM1917A0	LEFT UPPER COLUMN CAP	1	PZ																																																																		
VM1918A0	RIGHT LOWER COLUMN CAP	1	PZ																																																																		
VM1919A0	LEFT LOWER COLUMN CAP	1	PZ																																																																		
VM1920A0	INTERNAL GLASS CLOSING RIGHT PLATE	1	PZ																																																																		
VM1921A0	INTERNAL GLASS CLOSING LEFT PLATE	1	PZ																																																																		
VT1072A0	LINEMISS ROSSELLA BLACK EXTERNAL GLASS	1	PZ																																																																		

COMPONENT			SPARE PART																																																																																																																	
Code	Description	Image	Code	Description	Components list																																																																																																															
VM1917A	LEFT UPPER COLUMN CAP		KVT1071A	L.M. ROSSELLA EXTERNAL GLASS KIT	<table border="1"> <thead> <tr> <th>Code</th> <th>Description</th> <th>Qty</th> <th>UOM</th> </tr> </thead> <tbody> <tr> <td>IP1385A1</td> <td></td> <td>0.960</td> <td>M</td> </tr> <tr> <td>IP1508A0</td> <td></td> <td>1.300</td> <td>PZ</td> </tr> <tr> <td>RC1200A0</td> <td>ED=4 WIRE D.=0.5 COMPRESSIO N SPRING</td> <td>2</td> <td>PZ</td> </tr> <tr> <td>SL1050A1</td> <td>3M TRANSFER ADHESIVE TAPE</td> <td>0.820</td> <td>M</td> </tr> <tr> <td>TB2301A0</td> <td></td> <td>2</td> <td>PZ</td> </tr> <tr> <td>VM1025A0</td> <td>Ø16 GREY NYLON LID</td> <td>2</td> <td>PZ</td> </tr> <tr> <td>VM1059A1</td> <td></td> <td>1.350</td> <td>M</td> </tr> <tr> <td>VM1695A0</td> <td>HANDLE POSITION PIN</td> <td>2</td> <td>PZ</td> </tr> <tr> <td>VM1916A0</td> <td>RIGHT UPPER COLUMN CAP</td> <td>1</td> <td>PZ</td> </tr> <tr> <td>VM1917A0</td> <td>LEFT UPPER COLUMN CAP</td> <td>1</td> <td>PZ</td> </tr> <tr> <td>VM1918A0</td> <td>RIGHT LOWER COLUMN CAP</td> <td>1</td> <td>PZ</td> </tr> <tr> <td>VM1919A0</td> <td>LEFT LOWER COLUMN CAP</td> <td>1</td> <td>PZ</td> </tr> <tr> <td>VM1920A0</td> <td>INTERNAL GLASS CLOSING RIGHT PLATE</td> <td>1</td> <td>PZ</td> </tr> <tr> <td>VM1921A0</td> <td>INTERNAL GLASS CLOSING LEFT PLATE</td> <td>1</td> <td>PZ</td> </tr> <tr> <td>VT1071A2</td> <td></td> <td>1</td> <td>PZ</td> </tr> </tbody> </table>	Code	Description	Qty	UOM	IP1385A1		0.960	M	IP1508A0		1.300	PZ	RC1200A0	ED=4 WIRE D.=0.5 COMPRESSIO N SPRING	2	PZ	SL1050A1	3M TRANSFER ADHESIVE TAPE	0.820	M	TB2301A0		2	PZ	VM1025A0	Ø16 GREY NYLON LID	2	PZ	VM1059A1		1.350	M	VM1695A0	HANDLE POSITION PIN	2	PZ	VM1916A0	RIGHT UPPER COLUMN CAP	1	PZ	VM1917A0	LEFT UPPER COLUMN CAP	1	PZ	VM1918A0	RIGHT LOWER COLUMN CAP	1	PZ	VM1919A0	LEFT LOWER COLUMN CAP	1	PZ	VM1920A0	INTERNAL GLASS CLOSING RIGHT PLATE	1	PZ	VM1921A0	INTERNAL GLASS CLOSING LEFT PLATE	1	PZ	VT1071A2		1	PZ	KVT1067A	L.M. ELENA BLACK EXTERNAL GLASS KIT	<table border="1"> <thead> <tr> <th>Code</th> <th>Description</th> <th>Qty</th> <th>UOM</th> </tr> </thead> <tbody> <tr> <td>IP1385A1</td> <td></td> <td>0.800</td> <td>M</td> </tr> <tr> <td>IP1508A0</td> <td></td> <td>1.710</td> <td>PZ</td> </tr> <tr> <td>RC1200A0</td> <td>ED=4 WIRE D.=0.5 COMPRESSIO N SPRING</td> <td>2</td> <td>PZ</td> </tr> <tr> <td>SL1050A1</td> <td>3M TRANSFER ADHESIVE TAPE</td> <td>0.660</td> <td>M</td> </tr> <tr> <td>TB2306A0</td> <td>LMISS STEFANIA/ELE NA DOOR RIGHT COLUM</td> <td>2</td> <td>PZ</td> </tr> <tr> <td>VM1025A0</td> <td>Ø16 GREY NYLON LID</td> <td>2</td> <td>PZ</td> </tr> <tr> <td>VM1059A1</td> <td></td> <td>1.350</td> <td>M</td> </tr> <tr> <td>VM1695A0</td> <td>HANDLE POSITION PIN</td> <td>2</td> <td>PZ</td> </tr> <tr> <td>VM1916A0</td> <td>RIGHT UPPER COLUMN CAP</td> <td>1</td> <td>PZ</td> </tr> <tr> <td>VM1917A0</td> <td>LEFT UPPER COLUMN CAP</td> <td>1</td> <td>PZ</td> </tr> </tbody> </table>	Code	Description	Qty	UOM	IP1385A1		0.800	M	IP1508A0		1.710	PZ	RC1200A0	ED=4 WIRE D.=0.5 COMPRESSIO N SPRING	2	PZ	SL1050A1	3M TRANSFER ADHESIVE TAPE	0.660	M	TB2306A0	LMISS STEFANIA/ELE NA DOOR RIGHT COLUM	2	PZ	VM1025A0	Ø16 GREY NYLON LID	2	PZ	VM1059A1		1.350	M	VM1695A0	HANDLE POSITION PIN	2	PZ	VM1916A0	RIGHT UPPER COLUMN CAP	1	PZ	VM1917A0	LEFT UPPER COLUMN CAP	1	PZ
			Code	Description	Qty	UOM																																																																																																														
IP1385A1		0.960	M																																																																																																																	
IP1508A0		1.300	PZ																																																																																																																	
RC1200A0	ED=4 WIRE D.=0.5 COMPRESSIO N SPRING	2	PZ																																																																																																																	
SL1050A1	3M TRANSFER ADHESIVE TAPE	0.820	M																																																																																																																	
TB2301A0		2	PZ																																																																																																																	
VM1025A0	Ø16 GREY NYLON LID	2	PZ																																																																																																																	
VM1059A1		1.350	M																																																																																																																	
VM1695A0	HANDLE POSITION PIN	2	PZ																																																																																																																	
VM1916A0	RIGHT UPPER COLUMN CAP	1	PZ																																																																																																																	
VM1917A0	LEFT UPPER COLUMN CAP	1	PZ																																																																																																																	
VM1918A0	RIGHT LOWER COLUMN CAP	1	PZ																																																																																																																	
VM1919A0	LEFT LOWER COLUMN CAP	1	PZ																																																																																																																	
VM1920A0	INTERNAL GLASS CLOSING RIGHT PLATE	1	PZ																																																																																																																	
VM1921A0	INTERNAL GLASS CLOSING LEFT PLATE	1	PZ																																																																																																																	
VT1071A2		1	PZ																																																																																																																	
Code	Description	Qty	UOM																																																																																																																	
IP1385A1		0.800	M																																																																																																																	
IP1508A0		1.710	PZ																																																																																																																	
RC1200A0	ED=4 WIRE D.=0.5 COMPRESSIO N SPRING	2	PZ																																																																																																																	
SL1050A1	3M TRANSFER ADHESIVE TAPE	0.660	M																																																																																																																	
TB2306A0	LMISS STEFANIA/ELE NA DOOR RIGHT COLUM	2	PZ																																																																																																																	
VM1025A0	Ø16 GREY NYLON LID	2	PZ																																																																																																																	
VM1059A1		1.350	M																																																																																																																	
VM1695A0	HANDLE POSITION PIN	2	PZ																																																																																																																	
VM1916A0	RIGHT UPPER COLUMN CAP	1	PZ																																																																																																																	
VM1917A0	LEFT UPPER COLUMN CAP	1	PZ																																																																																																																	



COMPONENT			SPARE PART																																																															
Code	Description	Image	Code	Description	Components list																																																													
VM1917A	LEFT UPPER COLUMN CAP		KVT1067A	L.M. ELENA BLACK EXTERNAL GLASS KIT	<table border="1"> <thead> <tr> <th>Code</th> <th>Description</th> <th>Qty</th> <th>UOM</th> </tr> </thead> <tbody> <tr> <td>VM1918A0</td> <td>RIGHT LOWER COLUMN CAP</td> <td>1</td> <td>PZ</td> </tr> <tr> <td>VM1919A0</td> <td>LEFT LOWER COLUMN CAP</td> <td>1</td> <td>PZ</td> </tr> <tr> <td>VM1920A0</td> <td>INTERNAL GLASS CLOSING RIGHT PLATE</td> <td>1</td> <td>PZ</td> </tr> <tr> <td>VM1921A0</td> <td>INTERNAL GLASS CLOSING LEFT PLATE</td> <td>1</td> <td>PZ</td> </tr> <tr> <td>VT1067A0</td> <td>LINEMISS ELENA BLACK EXTERNAL DOOR GLASS</td> <td>1</td> <td>PZ</td> </tr> </tbody> </table>	Code	Description	Qty	UOM	VM1918A0	RIGHT LOWER COLUMN CAP	1	PZ	VM1919A0	LEFT LOWER COLUMN CAP	1	PZ	VM1920A0	INTERNAL GLASS CLOSING RIGHT PLATE	1	PZ	VM1921A0	INTERNAL GLASS CLOSING LEFT PLATE	1	PZ	VT1067A0	LINEMISS ELENA BLACK EXTERNAL DOOR GLASS	1	PZ																																					
			Code	Description	Qty	UOM																																																												
VM1918A0	RIGHT LOWER COLUMN CAP	1	PZ																																																															
VM1919A0	LEFT LOWER COLUMN CAP	1	PZ																																																															
VM1920A0	INTERNAL GLASS CLOSING RIGHT PLATE	1	PZ																																																															
VM1921A0	INTERNAL GLASS CLOSING LEFT PLATE	1	PZ																																																															
VT1067A0	LINEMISS ELENA BLACK EXTERNAL DOOR GLASS	1	PZ																																																															
KVT1066A	L.M. ELENA EXTERNAL GLASS KIT	<table border="1"> <thead> <tr> <th>Code</th> <th>Description</th> <th>Qty</th> <th>UOM</th> </tr> </thead> <tbody> <tr> <td>IP1385A1</td> <td></td> <td>0.800</td> <td>M</td> </tr> <tr> <td>IP1508A0</td> <td></td> <td>1.710</td> <td>PZ</td> </tr> <tr> <td>RC1200A0</td> <td>ED=4 WIRE D.=0.5 COMPRESSIO N SPRING</td> <td>2</td> <td>PZ</td> </tr> <tr> <td>SL1050A1</td> <td>3M TRANSFER ADHESIVE TAPE</td> <td>0.660</td> <td>M</td> </tr> <tr> <td>TB2306A0</td> <td>LMISS STEFANIA/ELE NA DOOR RIGHT COLUM</td> <td>2</td> <td>PZ</td> </tr> <tr> <td>VM1025A0</td> <td>Ø16 GREY NYLON LID</td> <td>2</td> <td>PZ</td> </tr> <tr> <td>VM1059A1</td> <td></td> <td>1.350</td> <td>M</td> </tr> <tr> <td>VM1695A0</td> <td>HANDLE POSITION PIN</td> <td>2</td> <td>PZ</td> </tr> <tr> <td>VM1916A0</td> <td>RIGHT UPPER COLUMN CAP</td> <td>1</td> <td>PZ</td> </tr> <tr> <td>VM1917A0</td> <td>LEFT UPPER COLUMN CAP</td> <td>1</td> <td>PZ</td> </tr> <tr> <td>VM1918A0</td> <td>RIGHT LOWER COLUMN CAP</td> <td>1</td> <td>PZ</td> </tr> <tr> <td>VM1919A0</td> <td>LEFT LOWER COLUMN CAP</td> <td>1</td> <td>PZ</td> </tr> <tr> <td>VM1920A0</td> <td>INTERNAL GLASS CLOSING RIGHT PLATE</td> <td>1</td> <td>PZ</td> </tr> <tr> <td>VM1921A0</td> <td>INTERNAL GLASS CLOSING LEFT PLATE</td> <td>1</td> <td>PZ</td> </tr> <tr> <td>VT1066A2</td> <td></td> <td>1</td> <td>PZ</td> </tr> </tbody> </table>	Code	Description	Qty	UOM	IP1385A1		0.800	M	IP1508A0		1.710	PZ	RC1200A0	ED=4 WIRE D.=0.5 COMPRESSIO N SPRING	2	PZ	SL1050A1	3M TRANSFER ADHESIVE TAPE	0.660	M	TB2306A0	LMISS STEFANIA/ELE NA DOOR RIGHT COLUM	2	PZ	VM1025A0	Ø16 GREY NYLON LID	2	PZ	VM1059A1		1.350	M	VM1695A0	HANDLE POSITION PIN	2	PZ	VM1916A0	RIGHT UPPER COLUMN CAP	1	PZ	VM1917A0	LEFT UPPER COLUMN CAP	1	PZ	VM1918A0	RIGHT LOWER COLUMN CAP	1	PZ	VM1919A0	LEFT LOWER COLUMN CAP	1	PZ	VM1920A0	INTERNAL GLASS CLOSING RIGHT PLATE	1	PZ	VM1921A0	INTERNAL GLASS CLOSING LEFT PLATE	1	PZ	VT1066A2		1	PZ
Code	Description	Qty	UOM																																																															
IP1385A1		0.800	M																																																															
IP1508A0		1.710	PZ																																																															
RC1200A0	ED=4 WIRE D.=0.5 COMPRESSIO N SPRING	2	PZ																																																															
SL1050A1	3M TRANSFER ADHESIVE TAPE	0.660	M																																																															
TB2306A0	LMISS STEFANIA/ELE NA DOOR RIGHT COLUM	2	PZ																																																															
VM1025A0	Ø16 GREY NYLON LID	2	PZ																																																															
VM1059A1		1.350	M																																																															
VM1695A0	HANDLE POSITION PIN	2	PZ																																																															
VM1916A0	RIGHT UPPER COLUMN CAP	1	PZ																																																															
VM1917A0	LEFT UPPER COLUMN CAP	1	PZ																																																															
VM1918A0	RIGHT LOWER COLUMN CAP	1	PZ																																																															
VM1919A0	LEFT LOWER COLUMN CAP	1	PZ																																																															
VM1920A0	INTERNAL GLASS CLOSING RIGHT PLATE	1	PZ																																																															
VM1921A0	INTERNAL GLASS CLOSING LEFT PLATE	1	PZ																																																															
VT1066A2		1	PZ																																																															



ASM2014E/0.D01 - Electrical system

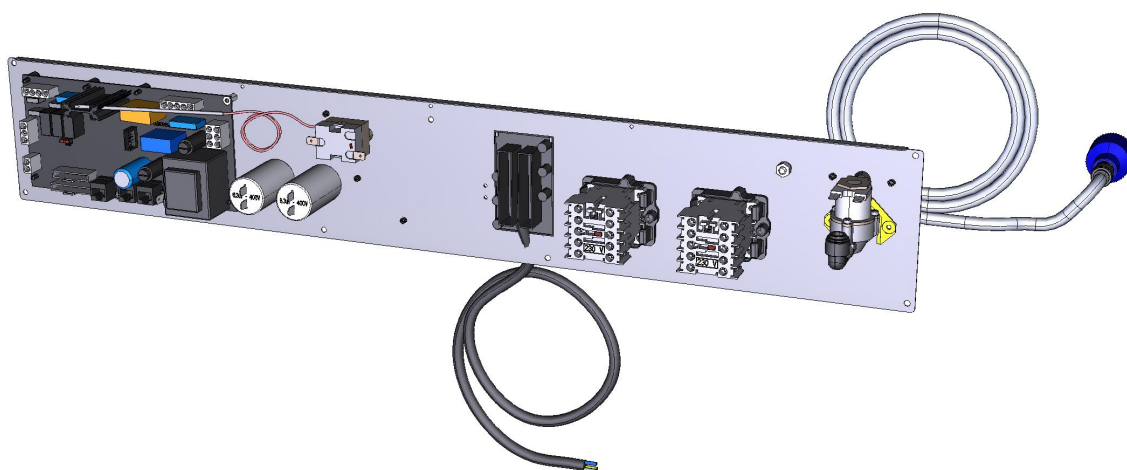

FRONT





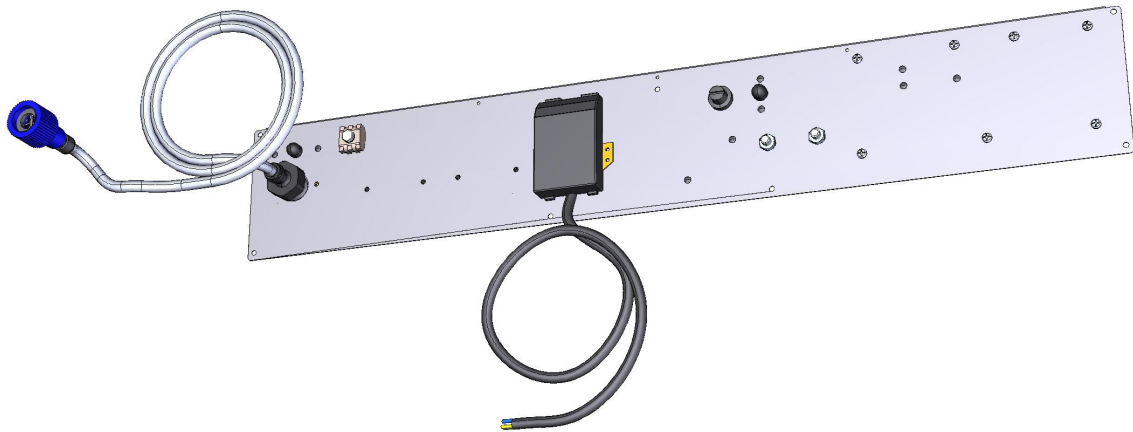

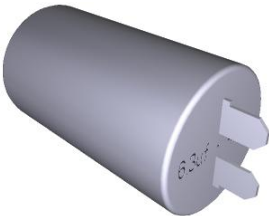
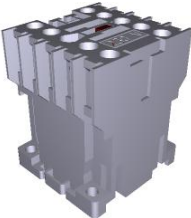

**ASM2014E/0.D01 - Electrical system**

**REAR**

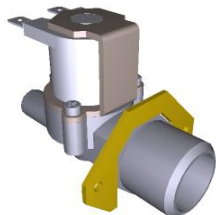

COMPONENT			SPARE PART																										
Code	Description	Image	Code	Description	Components list																								
CE1130A	5X1,5MMQ L=1,5M CABLE + TERMINAL BOARD		KCE1130A	5X1,5MMQ L=1,5M CABLE + TERMINAL BOARD	<table border="1"> <thead> <tr> <th>Code</th> <th>Description</th> <th>Qty</th> <th>UOM</th> </tr> </thead> <tbody> <tr> <td>CE1130A1</td> <td>5X1,5MMQ L=1,5M CABLE + TERMINAL BOARD</td> <td>1</td> <td>PZ</td> </tr> </tbody> </table>	Code	Description	Qty	UOM	CE1130A1	5X1,5MMQ L=1,5M CABLE + TERMINAL BOARD	1	PZ																
Code	Description	Qty	UOM																										
CE1130A1	5X1,5MMQ L=1,5M CABLE + TERMINAL BOARD	1	PZ																										
TR1136A	330°C 1 POLE SAFETY THERMOSTAT		KTR1136A	SAFETY THERMOSTAT KIT	<table border="1"> <thead> <tr> <th>Code</th> <th>Description</th> <th>Qty</th> <th>UOM</th> </tr> </thead> <tbody> <tr> <td>0H7030A0</td> <td>THERMOSTAT BULB INLET COVER</td> <td>1</td> <td>PZ</td> </tr> <tr> <td>GN1531A0</td> <td>THERMOSTAT BULB INLET SEALING</td> <td>1</td> <td>PZ</td> </tr> <tr> <td>SL1045A0</td> <td>S53 BLACK SILICONE - 80ML CARTRIDGE</td> <td>1</td> <td>PZ</td> </tr> <tr> <td>TR1136A0</td> <td>330°C 1 POLE SAFETY THERMOSTAT</td> <td>1</td> <td>PZ</td> </tr> <tr> <td>VI1220A1</td> <td>4,2X12 TCB SELF-TAPPIN G SCREW</td> <td>3</td> <td>PZ</td> </tr> </tbody> </table>	Code	Description	Qty	UOM	0H7030A0	THERMOSTAT BULB INLET COVER	1	PZ	GN1531A0	THERMOSTAT BULB INLET SEALING	1	PZ	SL1045A0	S53 BLACK SILICONE - 80ML CARTRIDGE	1	PZ	TR1136A0	330°C 1 POLE SAFETY THERMOSTAT	1	PZ	VI1220A1	4,2X12 TCB SELF-TAPPIN G SCREW	3	PZ
Code	Description	Qty	UOM																										
0H7030A0	THERMOSTAT BULB INLET COVER	1	PZ																										
GN1531A0	THERMOSTAT BULB INLET SEALING	1	PZ																										
SL1045A0	S53 BLACK SILICONE - 80ML CARTRIDGE	1	PZ																										
TR1136A0	330°C 1 POLE SAFETY THERMOSTAT	1	PZ																										
VI1220A1	4,2X12 TCB SELF-TAPPIN G SCREW	3	PZ																										
CN1003A	6,3 UF MOTOR CAPACITOR		KCN1003A	MOTOR CAPACITOR KIT	<table border="1"> <thead> <tr> <th>Code</th> <th>Description</th> <th>Qty</th> <th>UOM</th> </tr> </thead> <tbody> <tr> <td>CN1003A0</td> <td>6,3 UF MOTOR CAPACITOR</td> <td>1</td> <td>PZ</td> </tr> <tr> <td>VI1931A0</td> <td>M8 NUT+INDENTE D WASHER D=8 X COND.</td> <td>1</td> <td>PZ</td> </tr> <tr> <td>VI1932A0</td> <td>M8 NUT+INDENTE D WASHER D=8 X COND.</td> <td>1</td> <td>PZ</td> </tr> </tbody> </table>	Code	Description	Qty	UOM	CN1003A0	6,3 UF MOTOR CAPACITOR	1	PZ	VI1931A0	M8 NUT+INDENTE D WASHER D=8 X COND.	1	PZ	VI1932A0	M8 NUT+INDENTE D WASHER D=8 X COND.	1	PZ								
Code	Description	Qty	UOM																										
CN1003A0	6,3 UF MOTOR CAPACITOR	1	PZ																										
VI1931A0	M8 NUT+INDENTE D WASHER D=8 X COND.	1	PZ																										
VI1932A0	M8 NUT+INDENTE D WASHER D=8 X COND.	1	PZ																										
VE1115A	20 A 230V 4 POLES MINICONTACTOR		KVE1115A	20A 230V 4 POLES MINICONTACTOR KI	<table border="1"> <thead> <tr> <th>Code</th> <th>Description</th> <th>Qty</th> <th>UOM</th> </tr> </thead> <tbody> <tr> <td>VE1115A0</td> <td>20 A 230V 4 POLES MINICONTACT OR</td> <td>1</td> <td>PZ</td> </tr> <tr> <td>VM1075A1</td> <td>PLASTIC CLIP TO FIX CONTACTORS</td> <td>4</td> <td>PZ</td> </tr> </tbody> </table>	Code	Description	Qty	UOM	VE1115A0	20 A 230V 4 POLES MINICONTACT OR	1	PZ	VM1075A1	PLASTIC CLIP TO FIX CONTACTORS	4	PZ												
Code	Description	Qty	UOM																										
VE1115A0	20 A 230V 4 POLES MINICONTACT OR	1	PZ																										
VM1075A1	PLASTIC CLIP TO FIX CONTACTORS	4	PZ																										

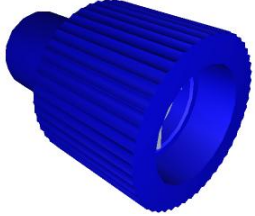
COMPONENT			SPARE PART																										
Code	Description	Image	Code	Description	Components list																								
VM1056A	SUPPORT MINI CONTACTOR VE1115A		VM1056A0	SUPPORT MINI CONTACTOR VE1115A																									
VM1750A	BRASS COMB CLAM		KVM1750A	BRASS COMB CLAMP KIT	<table border="1"> <thead> <tr> <th>Code</th> <th>Description</th> <th>Qty</th> <th>UOM</th> </tr> </thead> <tbody> <tr> <td>VM1750A0</td> <td>BRASS COMB CLAMP</td> <td>1</td> <td>PZ</td> </tr> </tbody> </table>	Code	Description	Qty	UOM	VM1750A0	BRASS COMB CLAMP	1	PZ																
Code	Description	Qty	UOM																										
VM1750A0	BRASS COMB CLAMP	1	PZ																										
EL1085A	SINGLE WATER SOLENOID VALVE + J.GUEST		KEL1085A	1 WAY WATER SOLENOID VALVE KI	<table border="1"> <thead> <tr> <th>Code</th> <th>Description</th> <th>Qty</th> <th>UOM</th> </tr> </thead> <tbody> <tr> <td>EL1085A0</td> <td>SINGLE WATER SOLENOID VALVE + J.GUEST</td> <td>1</td> <td>PZ</td> </tr> </tbody> </table>	Code	Description	Qty	UOM	EL1085A0	SINGLE WATER SOLENOID VALVE + J.GUEST	1	PZ																
Code	Description	Qty	UOM																										
EL1085A0	SINGLE WATER SOLENOID VALVE + J.GUEST	1	PZ																										
EL1195B	Ø8F-Ø8M ELBOW CONNECTION		KEL1195B	JG Ø8F-Ø8M ELB. JOINT 10 PCS (PM220808E)	<table border="1"> <thead> <tr> <th>Code</th> <th>Description</th> <th>Qty</th> <th>UOM</th> </tr> </thead> <tbody> <tr> <td>EL1195B0</td> <td>Ø8F-Ø8M ELBOW CONNECTION</td> <td>10</td> <td>PZ</td> </tr> </tbody> </table>	Code	Description	Qty	UOM	EL1195B0	Ø8F-Ø8M ELBOW CONNECTION	10	PZ																
Code	Description	Qty	UOM																										
EL1195B0	Ø8F-Ø8M ELBOW CONNECTION	10	PZ																										
TB1079A	L.MISS D8 WATER PIPE		KTB1079A	LINEMISS WATER INLET CONNECTING PIPE KIT	<table border="1"> <thead> <tr> <th>Code</th> <th>Description</th> <th>Qty</th> <th>UOM</th> </tr> </thead> <tbody> <tr> <td>GN1200A1</td> <td>3/4 CONNECTION SEAL D=24 RUBBER+NET</td> <td>1</td> <td>PZ</td> </tr> <tr> <td>RC1002A0</td> <td>JG 10M-8F TERMINAL REDUCTION FITTING</td> <td>1</td> <td>PZ</td> </tr> <tr> <td>RC1030A2</td> <td>Ø8-3/4 FEMALE JG STRAIGHT CONNECTION</td> <td>1</td> <td>PZ</td> </tr> <tr> <td>RC1365A0</td> <td>3/4"-10 JG FEMALE CONNECTION</td> <td>1</td> <td>PZ</td> </tr> <tr> <td>TB1815A0</td> <td>7,93X4,75 PE TRANSPAREN T PIPE</td> <td>1.500</td> <td>M</td> </tr> </tbody> </table>	Code	Description	Qty	UOM	GN1200A1	3/4 CONNECTION SEAL D=24 RUBBER+NET	1	PZ	RC1002A0	JG 10M-8F TERMINAL REDUCTION FITTING	1	PZ	RC1030A2	Ø8-3/4 FEMALE JG STRAIGHT CONNECTION	1	PZ	RC1365A0	3/4"-10 JG FEMALE CONNECTION	1	PZ	TB1815A0	7,93X4,75 PE TRANSPAREN T PIPE	1.500	M
Code	Description	Qty	UOM																										
GN1200A1	3/4 CONNECTION SEAL D=24 RUBBER+NET	1	PZ																										
RC1002A0	JG 10M-8F TERMINAL REDUCTION FITTING	1	PZ																										
RC1030A2	Ø8-3/4 FEMALE JG STRAIGHT CONNECTION	1	PZ																										
RC1365A0	3/4"-10 JG FEMALE CONNECTION	1	PZ																										
TB1815A0	7,93X4,75 PE TRANSPAREN T PIPE	1.500	M																										

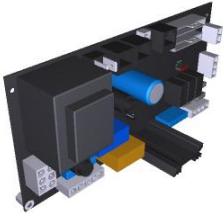
COMPONENT			SPARE PART																						
Code	Description	Image	Code	Description	Components list																				
RC1030A	Ø8-3/4 FEMALE JG STRAIGHT CONNECTION		KRC1030A	Ø8-3/4 FEM. STRAIGHT CONNECTION 5PCS KIT	<table border="1"> <thead> <tr> <th>Code</th> <th>Description</th> <th>Qty</th> <th>UOM</th> </tr> </thead> <tbody> <tr> <td>RC1030A2</td> <td>Ø8-3/4 FEMALE JG STRAIGHT CONNECTION</td> <td>5</td> <td>PZ</td> </tr> </tbody> </table>	Code	Description	Qty	UOM	RC1030A2	Ø8-3/4 FEMALE JG STRAIGHT CONNECTION	5	PZ												
Code	Description	Qty	UOM																						
RC1030A2	Ø8-3/4 FEMALE JG STRAIGHT CONNECTION	5	PZ																						
RC1002A	JG 10M-8F TERMINAL REDUCTION FITTING		KRC1002A	JG Ø10M-Ø8F REDUCTION FITTING 10 PCS KIT	<table border="1"> <thead> <tr> <th>Code</th> <th>Description</th> <th>Qty</th> <th>UOM</th> </tr> </thead> <tbody> <tr> <td>RC1002A0</td> <td>JG 10M-8F TERMINAL REDUCTION FITTING</td> <td>10</td> <td>PZ</td> </tr> </tbody> </table>	Code	Description	Qty	UOM	RC1002A0	JG 10M-8F TERMINAL REDUCTION FITTING	10	PZ												
Code	Description	Qty	UOM																						
RC1002A0	JG 10M-8F TERMINAL REDUCTION FITTING	10	PZ																						
RC1365A	3/4"-10 JG FEMALE CONNECTION		KRC1365A	3/4"-Ø10 OR Ø8 JG FEMALE CONNECTION KIT	<table border="1"> <thead> <tr> <th>Code</th> <th>Description</th> <th>Qty</th> <th>UOM</th> </tr> </thead> <tbody> <tr> <td>GN1200A1</td> <td>3/4 CONNECTION SEAL D=24 RUBBER+NET</td> <td>1</td> <td>PZ</td> </tr> <tr> <td>RC1002A0</td> <td>JG 10M-8F TERMINAL REDUCTION FITTING</td> <td>1</td> <td>PZ</td> </tr> <tr> <td>RC1365A0</td> <td>3/4"-10 JG FEMALE CONNECTION</td> <td>1</td> <td>PZ</td> </tr> </tbody> </table>	Code	Description	Qty	UOM	GN1200A1	3/4 CONNECTION SEAL D=24 RUBBER+NET	1	PZ	RC1002A0	JG 10M-8F TERMINAL REDUCTION FITTING	1	PZ	RC1365A0	3/4"-10 JG FEMALE CONNECTION	1	PZ				
Code	Description	Qty	UOM																						
GN1200A1	3/4 CONNECTION SEAL D=24 RUBBER+NET	1	PZ																						
RC1002A0	JG 10M-8F TERMINAL REDUCTION FITTING	1	PZ																						
RC1365A0	3/4"-10 JG FEMALE CONNECTION	1	PZ																						
0H6221E	LMISS800 DYN.-MAN. EL. COMPONENTS HOLDER		0H6221E0	LMISS800 DYN.-MAN. EL. COMPONENTS HOLDER																					
PE1983B	LMISS 230V DYNAMIC/CLASSIC POWER CARD		KPE1983B	LINE MISS 230V POWER CARD KIT	<table border="1"> <thead> <tr> <th>Code</th> <th>Description</th> <th>Qty</th> <th>UOM</th> </tr> </thead> <tbody> <tr> <td>PE1983B0</td> <td>LMISS 230V DYNAMIC/CLASSIC POWER CARD</td> <td>1</td> <td>PZ</td> </tr> <tr> <td>VI1850A0</td> <td>M4X6 NICKEL PLATED FIXING SCREW</td> <td>7</td> <td>PZ</td> </tr> <tr> <td>VM1745A0</td> <td>CARD SUPPORT</td> <td>6</td> <td>PZ</td> </tr> <tr> <td>VM2147A0</td> <td>ESD SPONGE PINK SMOOTH 410X343X15 M</td> <td>1</td> <td>PZ</td> </tr> </tbody> </table>	Code	Description	Qty	UOM	PE1983B0	LMISS 230V DYNAMIC/CLASSIC POWER CARD	1	PZ	VI1850A0	M4X6 NICKEL PLATED FIXING SCREW	7	PZ	VM1745A0	CARD SUPPORT	6	PZ	VM2147A0	ESD SPONGE PINK SMOOTH 410X343X15 M	1	PZ
Code	Description	Qty	UOM																						
PE1983B0	LMISS 230V DYNAMIC/CLASSIC POWER CARD	1	PZ																						
VI1850A0	M4X6 NICKEL PLATED FIXING SCREW	7	PZ																						
VM1745A0	CARD SUPPORT	6	PZ																						
VM2147A0	ESD SPONGE PINK SMOOTH 410X343X15 M	1	PZ																						