





Assembly code	Assembly revision	Assembly image
ASM0026C/0.D00	Door	
ASM2016D/0.D02	External cover	
ASM2017C/0.D00	Cooking chamber	
ASM2018E/0.D00	Electrical system	

ASM0026C/0.D00 - Door



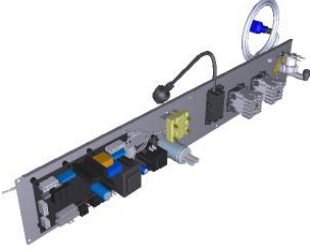
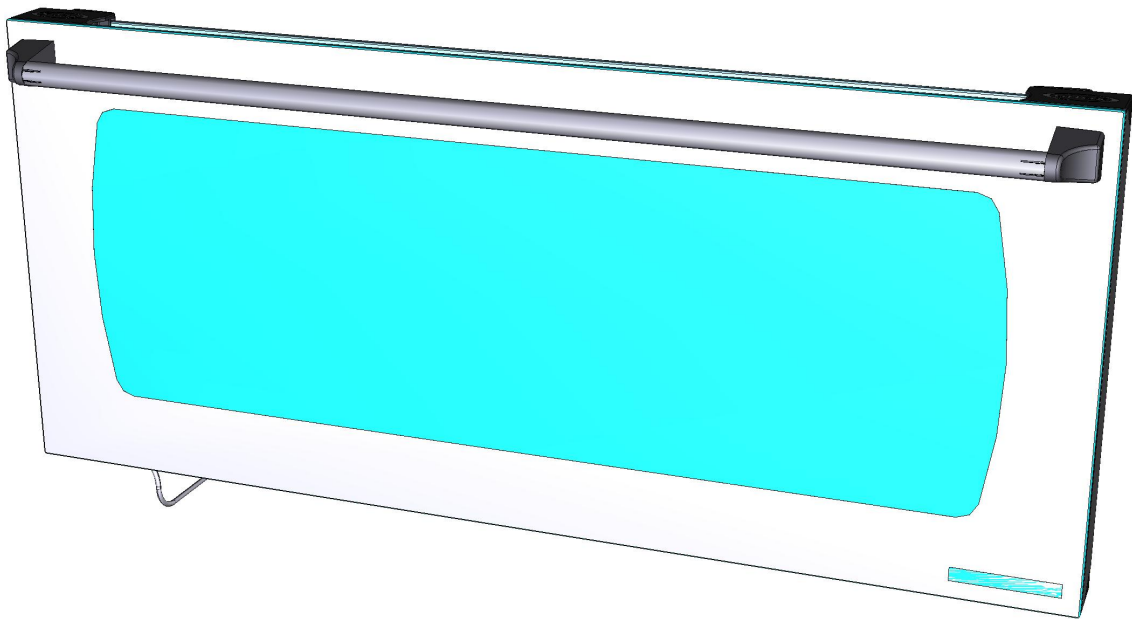

FRONT



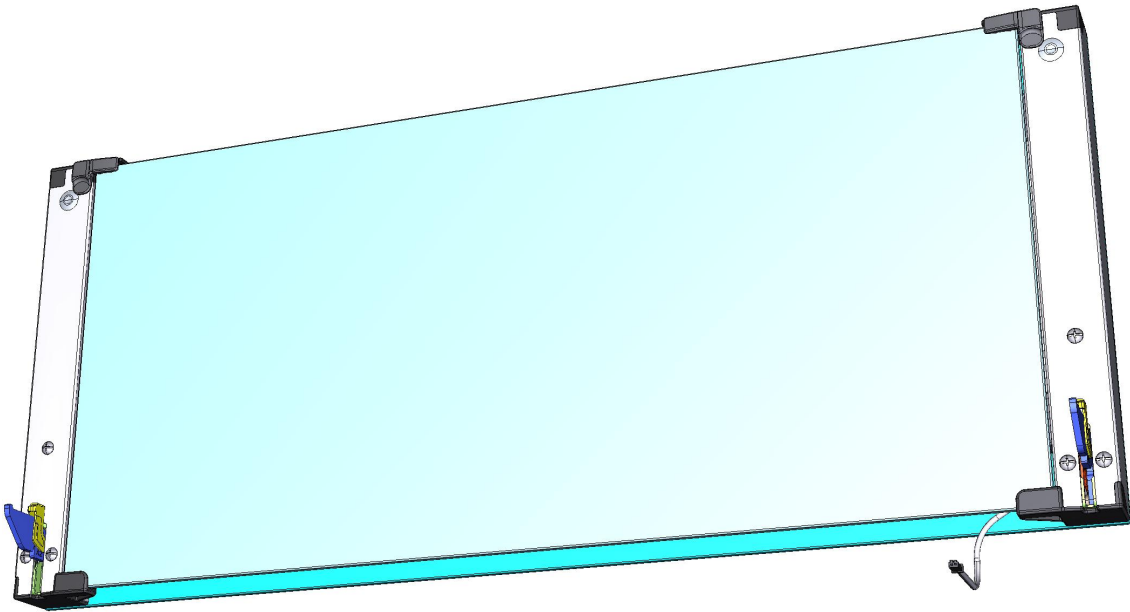

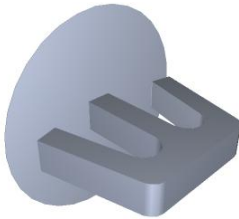
ASM0026C/0.D00 - Door

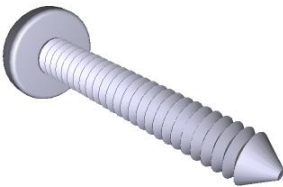
REAR



COMPONENT			SPARE PART																														
Code	Description	Image	Code	Description	Components list																												
VM1025A	Ø16 GREY NYLON LI		KVM1025A	GREY NYLON CAPS 20 PCS KIT	<table border="1"> <thead> <tr> <th>Code</th> <th>Description</th> <th>Qty</th> <th>UOM</th> </tr> </thead> <tbody> <tr> <td>VM1025A0</td> <td>Ø16 GREY NYLON LID</td> <td>20</td> <td>PZ</td> </tr> </tbody> </table>	Code	Description	Qty	UOM	VM1025A0	Ø16 GREY NYLON LID	20	PZ																				
Code	Description	Qty	UOM																														
VM1025A0	Ø16 GREY NYLON LID	20	PZ																														
MG1015B	L.MISS/L.MICRO/CH EFTOP HANDLE END		KMG1015B	2 PCS. HANDLE END KIT	<table border="1"> <thead> <tr> <th>Code</th> <th>Description</th> <th>Qty</th> <th>UOM</th> </tr> </thead> <tbody> <tr> <td>MG1015B0</td> <td>L.MISS/L.MICRO/CH EFTOP HANDLE END</td> <td>2</td> <td>PZ</td> </tr> <tr> <td>V11855A0</td> <td>5X25 SELF-TAPPING SCREW</td> <td>2</td> <td>PZ</td> </tr> <tr> <td>V11870A0</td> <td>50X50 SELF-THREADING SCREW FOR PLASTIC</td> <td>2</td> <td>PZ</td> </tr> <tr> <td>VM1025A0</td> <td>Ø16 GREY NYLON LID</td> <td>2</td> <td>PZ</td> </tr> </tbody> </table>	Code	Description	Qty	UOM	MG1015B0	L.MISS/L.MICRO/CH EFTOP HANDLE END	2	PZ	V11855A0	5X25 SELF-TAPPING SCREW	2	PZ	V11870A0	50X50 SELF-THREADING SCREW FOR PLASTIC	2	PZ	VM1025A0	Ø16 GREY NYLON LID	2	PZ								
Code	Description	Qty	UOM																														
MG1015B0	L.MISS/L.MICRO/CH EFTOP HANDLE END	2	PZ																														
V11855A0	5X25 SELF-TAPPING SCREW	2	PZ																														
V11870A0	50X50 SELF-THREADING SCREW FOR PLASTIC	2	PZ																														
VM1025A0	Ø16 GREY NYLON LID	2	PZ																														
V11855A	5X25 SELF-TAPPING SCREW		KV11855A	5X25 SELF-TAPPING SCREW 20 PCS.	<table border="1"> <thead> <tr> <th>Code</th> <th>Description</th> <th>Qty</th> <th>UOM</th> </tr> </thead> <tbody> <tr> <td>V11855A0</td> <td>5X25 SELF-TAPPING SCREW</td> <td>20</td> <td>PZ</td> </tr> </tbody> </table>	Code	Description	Qty	UOM	V11855A0	5X25 SELF-TAPPING SCREW	20	PZ																				
Code	Description	Qty	UOM																														
V11855A0	5X25 SELF-TAPPING SCREW	20	PZ																														
0H1930B	HANDLE TUBE L= 718 Ø18X1		K0H1930B	LMISS 800 HANDLE KIT	<table border="1"> <thead> <tr> <th>Code</th> <th>Description</th> <th>Qty</th> <th>UOM</th> </tr> </thead> <tbody> <tr> <td>0H1930B0</td> <td>HANDLE TUBE L= 718 Ø18X1</td> <td>1</td> <td>PZ</td> </tr> <tr> <td>MG1015B0</td> <td>L.MISS/L.MICRO/CH EFTOP HANDLE END</td> <td>2</td> <td>PZ</td> </tr> <tr> <td>V11855A0</td> <td>5X25 SELF-TAPPING SCREW</td> <td>2</td> <td>PZ</td> </tr> <tr> <td>VM1025A0</td> <td>Ø16 GREY NYLON LID</td> <td>2</td> <td>PZ</td> </tr> <tr> <td>VM1794A0</td> <td>250X4.8 PA66 BLACK CLAMP</td> <td>2</td> <td>PZ</td> </tr> <tr> <td>VM2103A0</td> <td>CLAMP LOCK</td> <td>2</td> <td>PZ</td> </tr> </tbody> </table>	Code	Description	Qty	UOM	0H1930B0	HANDLE TUBE L= 718 Ø18X1	1	PZ	MG1015B0	L.MISS/L.MICRO/CH EFTOP HANDLE END	2	PZ	V11855A0	5X25 SELF-TAPPING SCREW	2	PZ	VM1025A0	Ø16 GREY NYLON LID	2	PZ	VM1794A0	250X4.8 PA66 BLACK CLAMP	2	PZ	VM2103A0	CLAMP LOCK	2	PZ
Code	Description	Qty	UOM																														
0H1930B0	HANDLE TUBE L= 718 Ø18X1	1	PZ																														
MG1015B0	L.MISS/L.MICRO/CH EFTOP HANDLE END	2	PZ																														
V11855A0	5X25 SELF-TAPPING SCREW	2	PZ																														
VM1025A0	Ø16 GREY NYLON LID	2	PZ																														
VM1794A0	250X4.8 PA66 BLACK CLAMP	2	PZ																														
VM2103A0	CLAMP LOCK	2	PZ																														





COMPONENT			SPARE PART																																																						
Code	Description	Image	Code	Description	Components list																																																				
VM1918A	RIGHT LOWER COLUMN CAP		KVM1918A	LMISS 60X40 RIGHT LOWER DOOR COLUMN CAP	<table border="1"> <thead> <tr> <th>Code</th> <th>Description</th> <th>Qty</th> <th>UOM</th> </tr> </thead> <tbody> <tr> <td>VM1918A0</td> <td>RIGHT LOWER COLUMN CAP</td> <td>1</td> <td>PZ</td> </tr> </tbody> </table>	Code	Description	Qty	UOM	VM1918A0	RIGHT LOWER COLUMN CAP	1	PZ																																												
Code	Description	Qty	UOM																																																						
VM1918A0	RIGHT LOWER COLUMN CAP	1	PZ																																																						
VM1919A	LEFT LOWER COLUMN CAP		KVM1919A	LMISS 60X40 LEFT LOWER DOOR COLUMN CAP	<table border="1"> <thead> <tr> <th>Code</th> <th>Description</th> <th>Qty</th> <th>UOM</th> </tr> </thead> <tbody> <tr> <td>VM1919A0</td> <td>LEFT LOWER COLUMN CAP</td> <td>1</td> <td>PZ</td> </tr> </tbody> </table>	Code	Description	Qty	UOM	VM1919A0	LEFT LOWER COLUMN CAP	1	PZ																																												
Code	Description	Qty	UOM																																																						
VM1919A0	LEFT LOWER COLUMN CAP	1	PZ																																																						
VM1916A	RIGHT UPPER COLUMN CAP		KVT1253A	XF-XFT195-EG-VT1253A EXTERNAL GLASS KIT	<table border="1"> <thead> <tr> <th>Code</th> <th>Description</th> <th>Qty</th> <th>UOM</th> </tr> </thead> <tbody> <tr> <td>IP1235B0</td> <td>POLYSTYREN E FLAT PACKING</td> <td>1</td> <td>PZ</td> </tr> <tr> <td>RC1200A0</td> <td>ED=4 WIRE D.=0.5 COMPRESSIO N SPRING</td> <td>2</td> <td>PZ</td> </tr> <tr> <td>SL1050A1</td> <td>3M TRANSFER ADHESIVE TAPE</td> <td>0.820</td> <td>M</td> </tr> <tr> <td>TB2301A0</td> <td>RIGHT COLUMN XVC105E 40X40X1</td> <td>1</td> <td>PZ</td> </tr> <tr> <td>TB3081A0</td> <td>LMISS ARIANNA/ROS SELLA DOOR LEFT COLUMN</td> <td>1</td> <td>PZ</td> </tr> <tr> <td>VM1025A0</td> <td>Ø16 GREY NYLON LID</td> <td>2</td> <td>PZ</td> </tr> <tr> <td>VM1695A0</td> <td>HANDLE POSITION PIN</td> <td>2</td> <td>PZ</td> </tr> <tr> <td>VM1916A0</td> <td>RIGHT UPPER COLUMN CAP</td> <td>1</td> <td>PZ</td> </tr> <tr> <td>VM1917A0</td> <td>LEFT UPPER COLUMN CAP</td> <td>1</td> <td>PZ</td> </tr> <tr> <td>VM1918A0</td> <td>RIGHT LOWER COLUMN CAP</td> <td>1</td> <td>PZ</td> </tr> <tr> <td>VM1919A0</td> <td>LEFT LOWER COLUMN CAP</td> <td>1</td> <td>PZ</td> </tr> <tr> <td>VM1920A0</td> <td>INTERNAL GLASS CLOSING RIGHT PLATE</td> <td>1</td> <td>PZ</td> </tr> </tbody> </table>	Code	Description	Qty	UOM	IP1235B0	POLYSTYREN E FLAT PACKING	1	PZ	RC1200A0	ED=4 WIRE D.=0.5 COMPRESSIO N SPRING	2	PZ	SL1050A1	3M TRANSFER ADHESIVE TAPE	0.820	M	TB2301A0	RIGHT COLUMN XVC105E 40X40X1	1	PZ	TB3081A0	LMISS ARIANNA/ROS SELLA DOOR LEFT COLUMN	1	PZ	VM1025A0	Ø16 GREY NYLON LID	2	PZ	VM1695A0	HANDLE POSITION PIN	2	PZ	VM1916A0	RIGHT UPPER COLUMN CAP	1	PZ	VM1917A0	LEFT UPPER COLUMN CAP	1	PZ	VM1918A0	RIGHT LOWER COLUMN CAP	1	PZ	VM1919A0	LEFT LOWER COLUMN CAP	1	PZ	VM1920A0	INTERNAL GLASS CLOSING RIGHT PLATE	1	PZ
Code	Description	Qty	UOM																																																						
IP1235B0	POLYSTYREN E FLAT PACKING	1	PZ																																																						
RC1200A0	ED=4 WIRE D.=0.5 COMPRESSIO N SPRING	2	PZ																																																						
SL1050A1	3M TRANSFER ADHESIVE TAPE	0.820	M																																																						
TB2301A0	RIGHT COLUMN XVC105E 40X40X1	1	PZ																																																						
TB3081A0	LMISS ARIANNA/ROS SELLA DOOR LEFT COLUMN	1	PZ																																																						
VM1025A0	Ø16 GREY NYLON LID	2	PZ																																																						
VM1695A0	HANDLE POSITION PIN	2	PZ																																																						
VM1916A0	RIGHT UPPER COLUMN CAP	1	PZ																																																						
VM1917A0	LEFT UPPER COLUMN CAP	1	PZ																																																						
VM1918A0	RIGHT LOWER COLUMN CAP	1	PZ																																																						
VM1919A0	LEFT LOWER COLUMN CAP	1	PZ																																																						
VM1920A0	INTERNAL GLASS CLOSING RIGHT PLATE	1	PZ																																																						



COMPONENT			SPARE PART																																																							
Code	Description	Image	Code	Description	Components list																																																					
VM1916A	RIGHT UPPER COLUMN CAP		KVT1253A	XF-XFT195-EG-VT1253A EXTERNAL GLASS KIT	<table border="1"> <thead> <tr> <th>Code</th> <th>Description</th> <th>Qty</th> <th>UOM</th> </tr> </thead> <tbody> <tr> <td>VM1921A0</td> <td>INTERNAL GLASS CLOSING LEFT PLATE</td> <td>1</td> <td>PZ</td> </tr> <tr> <td>VT1253A0</td> <td>XF-XFT195 DOOR EXT. BLACK GLASS-ENGEF OOD</td> <td>1</td> <td>PZ</td> </tr> <tr> <td>VT1253A0</td> <td>XF-XFT195 DOOR EXT. BLACK GLASS-ENGEF OOD</td> <td>1</td> <td>PZ</td> </tr> </tbody> </table>	Code	Description	Qty	UOM	VM1921A0	INTERNAL GLASS CLOSING LEFT PLATE	1	PZ	VT1253A0	XF-XFT195 DOOR EXT. BLACK GLASS-ENGEF OOD	1	PZ	VT1253A0	XF-XFT195 DOOR EXT. BLACK GLASS-ENGEF OOD	1	PZ																																					
			Code	Description	Qty	UOM																																																				
VM1921A0	INTERNAL GLASS CLOSING LEFT PLATE	1	PZ																																																							
VT1253A0	XF-XFT195 DOOR EXT. BLACK GLASS-ENGEF OOD	1	PZ																																																							
VT1253A0	XF-XFT195 DOOR EXT. BLACK GLASS-ENGEF OOD	1	PZ																																																							
KVT1072A	L.M. ROSSELLA BLACK EXTERNAL GLASS KIT	<table border="1"> <thead> <tr> <th>Code</th> <th>Description</th> <th>Qty</th> <th>UOM</th> </tr> </thead> <tbody> <tr> <td>IP1385A1</td> <td>CORNER POLYSTYREN E PACKING 110X80X2000</td> <td>0.960</td> <td>M</td> </tr> <tr> <td>IP1508A1</td> <td>POLYSTYREN E U SHAPED PROFILE 2000X60X60</td> <td>1.270</td> <td>M</td> </tr> <tr> <td>RC1200A0</td> <td>ED=4 WIRE D.=0.5 COMPRESSIO N SPRING</td> <td>2</td> <td>PZ</td> </tr> <tr> <td>SL1050A1</td> <td>3M TRANSFER ADHESIVE TAPE</td> <td>0.820</td> <td>M</td> </tr> <tr> <td>TB2301A0</td> <td>RIGHT COLUMN XVC105E 40X40X1</td> <td>1</td> <td>PZ</td> </tr> <tr> <td>TB3081A0</td> <td>LMISS ARIANNA/ROS SELLA DOOR LEFT COLUMN</td> <td>1</td> <td>PZ</td> </tr> <tr> <td>VM1025A0</td> <td>Ø16 GREY NYLON LID</td> <td>2</td> <td>PZ</td> </tr> <tr> <td>VM1059A1</td> <td>HEAT SHRINK FILM H800</td> <td>1.300</td> <td>M</td> </tr> <tr> <td>VM1695A0</td> <td>HANDLE POSITION PIN</td> <td>2</td> <td>PZ</td> </tr> <tr> <td>VM1916A0</td> <td>RIGHT UPPER COLUMN CAP</td> <td>1</td> <td>PZ</td> </tr> <tr> <td>VM1917A0</td> <td>LEFT UPPER COLUMN CAP</td> <td>1</td> <td>PZ</td> </tr> <tr> <td>VM1918A0</td> <td>RIGHT LOWER COLUMN CAP</td> <td>1</td> <td>PZ</td> </tr> <tr> <td>VM1919A0</td> <td>LEFT LOWER COLUMN CAP</td> <td>1</td> <td>PZ</td> </tr> </tbody> </table>	Code	Description	Qty	UOM	IP1385A1	CORNER POLYSTYREN E PACKING 110X80X2000	0.960	M	IP1508A1	POLYSTYREN E U SHAPED PROFILE 2000X60X60	1.270	M	RC1200A0	ED=4 WIRE D.=0.5 COMPRESSIO N SPRING	2	PZ	SL1050A1	3M TRANSFER ADHESIVE TAPE	0.820	M	TB2301A0	RIGHT COLUMN XVC105E 40X40X1	1	PZ	TB3081A0	LMISS ARIANNA/ROS SELLA DOOR LEFT COLUMN	1	PZ	VM1025A0	Ø16 GREY NYLON LID	2	PZ	VM1059A1	HEAT SHRINK FILM H800	1.300	M	VM1695A0	HANDLE POSITION PIN	2	PZ	VM1916A0	RIGHT UPPER COLUMN CAP	1	PZ	VM1917A0	LEFT UPPER COLUMN CAP	1	PZ	VM1918A0	RIGHT LOWER COLUMN CAP	1	PZ	VM1919A0	LEFT LOWER COLUMN CAP	1	PZ
Code	Description	Qty	UOM																																																							
IP1385A1	CORNER POLYSTYREN E PACKING 110X80X2000	0.960	M																																																							
IP1508A1	POLYSTYREN E U SHAPED PROFILE 2000X60X60	1.270	M																																																							
RC1200A0	ED=4 WIRE D.=0.5 COMPRESSIO N SPRING	2	PZ																																																							
SL1050A1	3M TRANSFER ADHESIVE TAPE	0.820	M																																																							
TB2301A0	RIGHT COLUMN XVC105E 40X40X1	1	PZ																																																							
TB3081A0	LMISS ARIANNA/ROS SELLA DOOR LEFT COLUMN	1	PZ																																																							
VM1025A0	Ø16 GREY NYLON LID	2	PZ																																																							
VM1059A1	HEAT SHRINK FILM H800	1.300	M																																																							
VM1695A0	HANDLE POSITION PIN	2	PZ																																																							
VM1916A0	RIGHT UPPER COLUMN CAP	1	PZ																																																							
VM1917A0	LEFT UPPER COLUMN CAP	1	PZ																																																							
VM1918A0	RIGHT LOWER COLUMN CAP	1	PZ																																																							
VM1919A0	LEFT LOWER COLUMN CAP	1	PZ																																																							



COMPONENT			SPARE PART																																																			
Code	Description	Image	Code	Description	Components list																																																	
VM1916A	RIGHT UPPER COLUMN CAP		KVT1072A	L.M. ROSSELLA BLACK EXTERNAL GLASS KIT	<table border="1"> <thead> <tr> <th>Code</th> <th>Description</th> <th>Qty</th> <th>UOM</th> </tr> </thead> <tbody> <tr> <td>VM1920A0</td> <td>INTERNAL GLASS CLOSING RIGHT PLATE</td> <td>1</td> <td>PZ</td> </tr> <tr> <td>VM1921A0</td> <td>INTERNAL GLASS CLOSING LEFT PLATE</td> <td>1</td> <td>PZ</td> </tr> <tr> <td>VT1072A0</td> <td>LINEMISS ROSSELLA BLACK EXTERNAL GLASS</td> <td>1</td> <td>PZ</td> </tr> <tr> <td>VT1072A0</td> <td>LINEMISS ROSSELLA BLACK EXTERNAL GLASS</td> <td>1</td> <td>PZ</td> </tr> </tbody> </table>	Code	Description	Qty	UOM	VM1920A0	INTERNAL GLASS CLOSING RIGHT PLATE	1	PZ	VM1921A0	INTERNAL GLASS CLOSING LEFT PLATE	1	PZ	VT1072A0	LINEMISS ROSSELLA BLACK EXTERNAL GLASS	1	PZ	VT1072A0	LINEMISS ROSSELLA BLACK EXTERNAL GLASS	1	PZ																													
			Code	Description	Qty	UOM																																																
VM1920A0	INTERNAL GLASS CLOSING RIGHT PLATE	1	PZ																																																			
VM1921A0	INTERNAL GLASS CLOSING LEFT PLATE	1	PZ																																																			
VT1072A0	LINEMISS ROSSELLA BLACK EXTERNAL GLASS	1	PZ																																																			
VT1072A0	LINEMISS ROSSELLA BLACK EXTERNAL GLASS	1	PZ																																																			
KVT1071A	L.M. ROSSELLA EXTERNAL GLASS KIT	<table border="1"> <thead> <tr> <th>Code</th> <th>Description</th> <th>Qty</th> <th>UOM</th> </tr> </thead> <tbody> <tr> <td>IP1385A1</td> <td>CORNER POLYSTYREN E PACKING 110X80X2000</td> <td>0.960</td> <td>M</td> </tr> <tr> <td>IP1508A1</td> <td>POLYSTYREN E U SHAPED PROFILE 2000X60X60</td> <td>1.300</td> <td>M</td> </tr> <tr> <td>RC1200A0</td> <td>ED=4 WIRE D.=0.5 COMPRESSION SPRING</td> <td>2</td> <td>PZ</td> </tr> <tr> <td>SL1050A1</td> <td>3M TRANSFER ADHESIVE TAPE</td> <td>0.820</td> <td>M</td> </tr> <tr> <td>TB2301A0</td> <td>RIGHT COLUMN XVC105E 40X40X1</td> <td>2</td> <td>PZ</td> </tr> <tr> <td>VM1025A0</td> <td>Ø16 GREY NYLON LID</td> <td>2</td> <td>PZ</td> </tr> <tr> <td>VM1059A1</td> <td>HEAT SHRINK FILM H800</td> <td>1.350</td> <td>M</td> </tr> <tr> <td>VM1695A0</td> <td>HANDLE POSITION PIN</td> <td>2</td> <td>PZ</td> </tr> <tr> <td>VM1916A0</td> <td>RIGHT UPPER COLUMN CAP</td> <td>1</td> <td>PZ</td> </tr> <tr> <td>VM1917A0</td> <td>LEFT UPPER COLUMN CAP</td> <td>1</td> <td>PZ</td> </tr> <tr> <td>VM1918A0</td> <td>RIGHT LOWER COLUMN CAP</td> <td>1</td> <td>PZ</td> </tr> <tr> <td>VM1919A0</td> <td>LEFT LOWER COLUMN CAP</td> <td>1</td> <td>PZ</td> </tr> </tbody> </table>	Code	Description	Qty	UOM	IP1385A1	CORNER POLYSTYREN E PACKING 110X80X2000	0.960	M	IP1508A1	POLYSTYREN E U SHAPED PROFILE 2000X60X60	1.300	M	RC1200A0	ED=4 WIRE D.=0.5 COMPRESSION SPRING	2	PZ	SL1050A1	3M TRANSFER ADHESIVE TAPE	0.820	M	TB2301A0	RIGHT COLUMN XVC105E 40X40X1	2	PZ	VM1025A0	Ø16 GREY NYLON LID	2	PZ	VM1059A1	HEAT SHRINK FILM H800	1.350	M	VM1695A0	HANDLE POSITION PIN	2	PZ	VM1916A0	RIGHT UPPER COLUMN CAP	1	PZ	VM1917A0	LEFT UPPER COLUMN CAP	1	PZ	VM1918A0	RIGHT LOWER COLUMN CAP	1	PZ	VM1919A0	LEFT LOWER COLUMN CAP	1	PZ
Code	Description	Qty	UOM																																																			
IP1385A1	CORNER POLYSTYREN E PACKING 110X80X2000	0.960	M																																																			
IP1508A1	POLYSTYREN E U SHAPED PROFILE 2000X60X60	1.300	M																																																			
RC1200A0	ED=4 WIRE D.=0.5 COMPRESSION SPRING	2	PZ																																																			
SL1050A1	3M TRANSFER ADHESIVE TAPE	0.820	M																																																			
TB2301A0	RIGHT COLUMN XVC105E 40X40X1	2	PZ																																																			
VM1025A0	Ø16 GREY NYLON LID	2	PZ																																																			
VM1059A1	HEAT SHRINK FILM H800	1.350	M																																																			
VM1695A0	HANDLE POSITION PIN	2	PZ																																																			
VM1916A0	RIGHT UPPER COLUMN CAP	1	PZ																																																			
VM1917A0	LEFT UPPER COLUMN CAP	1	PZ																																																			
VM1918A0	RIGHT LOWER COLUMN CAP	1	PZ																																																			
VM1919A0	LEFT LOWER COLUMN CAP	1	PZ																																																			

COMPONENT			SPARE PART																																																							
Code	Description	Image	Code	Description	Components list																																																					
VM1916A	RIGHT UPPER COLUMN CAP		KVT1071A	L.M. ROSSELLA EXTERNAL GLASS KIT	<table border="1"> <thead> <tr> <th>Code</th> <th>Description</th> <th>Qty</th> <th>UOM</th> </tr> </thead> <tbody> <tr> <td>VM1920A0</td> <td>INTERNAL GLASS CLOSING RIGHT PLATE</td> <td>1</td> <td>PZ</td> </tr> <tr> <td>VM1921A0</td> <td>INTERNAL GLASS CLOSING LEFT PLATE</td> <td>1</td> <td>PZ</td> </tr> <tr> <td>VT1071A2</td> <td>YELLOW SER GLASS 798X424X5</td> <td>1</td> <td>PZ</td> </tr> <tr> <td>VT1071A2</td> <td>YELLOW SER GLASS 798X424X5</td> <td>1</td> <td>PZ</td> </tr> </tbody> </table>	Code	Description	Qty	UOM	VM1920A0	INTERNAL GLASS CLOSING RIGHT PLATE	1	PZ	VM1921A0	INTERNAL GLASS CLOSING LEFT PLATE	1	PZ	VT1071A2	YELLOW SER GLASS 798X424X5	1	PZ	VT1071A2	YELLOW SER GLASS 798X424X5	1	PZ																																	
			Code	Description	Qty	UOM																																																				
VM1920A0	INTERNAL GLASS CLOSING RIGHT PLATE	1	PZ																																																							
VM1921A0	INTERNAL GLASS CLOSING LEFT PLATE	1	PZ																																																							
VT1071A2	YELLOW SER GLASS 798X424X5	1	PZ																																																							
VT1071A2	YELLOW SER GLASS 798X424X5	1	PZ																																																							
KVT1067A	L.M. ELENA BLACK EXTERNAL GLASS KIT	<table border="1"> <thead> <tr> <th>Code</th> <th>Description</th> <th>Qty</th> <th>UOM</th> </tr> </thead> <tbody> <tr> <td>IP1385A1</td> <td>CORNER POLYSTYREN E PACKING 110X80X2000</td> <td>0.800</td> <td>M</td> </tr> <tr> <td>IP1508A1</td> <td>POLYSTYREN E U SHAPED PROFILE 2000X60X60</td> <td>1.710</td> <td>M</td> </tr> <tr> <td>RC1200A0</td> <td>ED=4 WIRE D.=0.5 COMPRESSIO N SPRING</td> <td>2</td> <td>PZ</td> </tr> <tr> <td>SL1050A1</td> <td>3M TRANSFER ADHESIVE TAPE</td> <td>0.660</td> <td>M</td> </tr> <tr> <td>TB2306A0</td> <td>LMISS STEFANIA/ELE NA DOOR RIGHT COLUM</td> <td>1</td> <td>PZ</td> </tr> <tr> <td>TB3080A0</td> <td>LMISS STEFANIA/ELE NA DOOR LEFT COLUMN</td> <td>1</td> <td>PZ</td> </tr> <tr> <td>VM1025A0</td> <td>Ø16 GREY NYLON LID</td> <td>2</td> <td>PZ</td> </tr> <tr> <td>VM1059A1</td> <td>HEAT SHRINK FILM H800</td> <td>1.350</td> <td>M</td> </tr> <tr> <td>VM1695A0</td> <td>HANDLE POSITION PIN</td> <td>2</td> <td>PZ</td> </tr> <tr> <td>VM1916A0</td> <td>RIGHT UPPER COLUMN CAP</td> <td>1</td> <td>PZ</td> </tr> <tr> <td>VM1917A0</td> <td>LEFT UPPER COLUMN CAP</td> <td>1</td> <td>PZ</td> </tr> <tr> <td>VM1918A0</td> <td>RIGHT LOWER COLUMN CAP</td> <td>1</td> <td>PZ</td> </tr> <tr> <td>VM1919A0</td> <td>LEFT LOWER COLUMN CAP</td> <td>1</td> <td>PZ</td> </tr> </tbody> </table>	Code	Description	Qty	UOM	IP1385A1	CORNER POLYSTYREN E PACKING 110X80X2000	0.800	M	IP1508A1	POLYSTYREN E U SHAPED PROFILE 2000X60X60	1.710	M	RC1200A0	ED=4 WIRE D.=0.5 COMPRESSIO N SPRING	2	PZ	SL1050A1	3M TRANSFER ADHESIVE TAPE	0.660	M	TB2306A0	LMISS STEFANIA/ELE NA DOOR RIGHT COLUM	1	PZ	TB3080A0	LMISS STEFANIA/ELE NA DOOR LEFT COLUMN	1	PZ	VM1025A0	Ø16 GREY NYLON LID	2	PZ	VM1059A1	HEAT SHRINK FILM H800	1.350	M	VM1695A0	HANDLE POSITION PIN	2	PZ	VM1916A0	RIGHT UPPER COLUMN CAP	1	PZ	VM1917A0	LEFT UPPER COLUMN CAP	1	PZ	VM1918A0	RIGHT LOWER COLUMN CAP	1	PZ	VM1919A0	LEFT LOWER COLUMN CAP	1	PZ
Code	Description	Qty	UOM																																																							
IP1385A1	CORNER POLYSTYREN E PACKING 110X80X2000	0.800	M																																																							
IP1508A1	POLYSTYREN E U SHAPED PROFILE 2000X60X60	1.710	M																																																							
RC1200A0	ED=4 WIRE D.=0.5 COMPRESSIO N SPRING	2	PZ																																																							
SL1050A1	3M TRANSFER ADHESIVE TAPE	0.660	M																																																							
TB2306A0	LMISS STEFANIA/ELE NA DOOR RIGHT COLUM	1	PZ																																																							
TB3080A0	LMISS STEFANIA/ELE NA DOOR LEFT COLUMN	1	PZ																																																							
VM1025A0	Ø16 GREY NYLON LID	2	PZ																																																							
VM1059A1	HEAT SHRINK FILM H800	1.350	M																																																							
VM1695A0	HANDLE POSITION PIN	2	PZ																																																							
VM1916A0	RIGHT UPPER COLUMN CAP	1	PZ																																																							
VM1917A0	LEFT UPPER COLUMN CAP	1	PZ																																																							
VM1918A0	RIGHT LOWER COLUMN CAP	1	PZ																																																							
VM1919A0	LEFT LOWER COLUMN CAP	1	PZ																																																							

COMPONENT			SPARE PART																																																							
Code	Description	Image	Code	Description	Components list																																																					
VM1916A	RIGHT UPPER COLUMN CAP		KVT1067A	L.M. ELENA BLACK EXTERNAL GLASS KIT	<table border="1"> <thead> <tr> <th>Code</th> <th>Description</th> <th>Qty</th> <th>UOM</th> </tr> </thead> <tbody> <tr> <td>VM1920A0</td> <td>INTERNAL GLASS CLOSING RIGHT PLATE</td> <td>1</td> <td>PZ</td> </tr> <tr> <td>VM1921A0</td> <td>INTERNAL GLASS CLOSING LEFT PLATE</td> <td>1</td> <td>PZ</td> </tr> <tr> <td>VT1067A0</td> <td>LINEMISS ELENA BLACK EXTERNAL DOOR GLASS</td> <td>1</td> <td>PZ</td> </tr> <tr> <td>VT1067A0</td> <td>LINEMISS ELENA BLACK EXTERNAL DOOR GLASS</td> <td>1</td> <td>PZ</td> </tr> </tbody> </table>	Code	Description	Qty	UOM	VM1920A0	INTERNAL GLASS CLOSING RIGHT PLATE	1	PZ	VM1921A0	INTERNAL GLASS CLOSING LEFT PLATE	1	PZ	VT1067A0	LINEMISS ELENA BLACK EXTERNAL DOOR GLASS	1	PZ	VT1067A0	LINEMISS ELENA BLACK EXTERNAL DOOR GLASS	1	PZ																																	
			Code	Description	Qty	UOM																																																				
VM1920A0	INTERNAL GLASS CLOSING RIGHT PLATE	1	PZ																																																							
VM1921A0	INTERNAL GLASS CLOSING LEFT PLATE	1	PZ																																																							
VT1067A0	LINEMISS ELENA BLACK EXTERNAL DOOR GLASS	1	PZ																																																							
VT1067A0	LINEMISS ELENA BLACK EXTERNAL DOOR GLASS	1	PZ																																																							
KVT1066A	L.M. ELENA EXTERNAL GLASS KIT	<table border="1"> <thead> <tr> <th>Code</th> <th>Description</th> <th>Qty</th> <th>UOM</th> </tr> </thead> <tbody> <tr> <td>IP1385A1</td> <td>CORNER POLYSTYREN E PACKING 110X80X2000</td> <td>0.800</td> <td>M</td> </tr> <tr> <td>IP1508A1</td> <td>POLYSTYREN E U SHAPED PROFILE 2000X60X60</td> <td>1.710</td> <td>M</td> </tr> <tr> <td>RC1200A0</td> <td>ED=4 WIRE D.=0.5 COMPRESSIO N SPRING</td> <td>2</td> <td>PZ</td> </tr> <tr> <td>SL1050A1</td> <td>3M TRANSFER ADHESIVE TAPE</td> <td>0.660</td> <td>M</td> </tr> <tr> <td>TB2306A0</td> <td>LMISS STEFANIA/ELENA DOOR RIGHT COLUMN</td> <td>2</td> <td>PZ</td> </tr> <tr> <td>VM1025A0</td> <td>Ø16 GREY NYLON LID</td> <td>2</td> <td>PZ</td> </tr> <tr> <td>VM1059A1</td> <td>HEAT SHRINK FILM H800</td> <td>1.350</td> <td>M</td> </tr> <tr> <td>VM1695A0</td> <td>HANDLE POSITION PIN</td> <td>2</td> <td>PZ</td> </tr> <tr> <td>VM1916A0</td> <td>RIGHT UPPER COLUMN CAP</td> <td>1</td> <td>PZ</td> </tr> <tr> <td>VM1917A0</td> <td>LEFT UPPER COLUMN CAP</td> <td>1</td> <td>PZ</td> </tr> <tr> <td>VM1918A0</td> <td>RIGHT LOWER COLUMN CAP</td> <td>1</td> <td>PZ</td> </tr> <tr> <td>VM1919A0</td> <td>LEFT LOWER COLUMN CAP</td> <td>1</td> <td>PZ</td> </tr> <tr> <td>VM1920A0</td> <td>INTERNAL GLASS CLOSING RIGHT PLATE</td> <td>1</td> <td>PZ</td> </tr> </tbody> </table>	Code	Description	Qty	UOM	IP1385A1	CORNER POLYSTYREN E PACKING 110X80X2000	0.800	M	IP1508A1	POLYSTYREN E U SHAPED PROFILE 2000X60X60	1.710	M	RC1200A0	ED=4 WIRE D.=0.5 COMPRESSIO N SPRING	2	PZ	SL1050A1	3M TRANSFER ADHESIVE TAPE	0.660	M	TB2306A0	LMISS STEFANIA/ELENA DOOR RIGHT COLUMN	2	PZ	VM1025A0	Ø16 GREY NYLON LID	2	PZ	VM1059A1	HEAT SHRINK FILM H800	1.350	M	VM1695A0	HANDLE POSITION PIN	2	PZ	VM1916A0	RIGHT UPPER COLUMN CAP	1	PZ	VM1917A0	LEFT UPPER COLUMN CAP	1	PZ	VM1918A0	RIGHT LOWER COLUMN CAP	1	PZ	VM1919A0	LEFT LOWER COLUMN CAP	1	PZ	VM1920A0	INTERNAL GLASS CLOSING RIGHT PLATE	1	PZ
Code	Description	Qty	UOM																																																							
IP1385A1	CORNER POLYSTYREN E PACKING 110X80X2000	0.800	M																																																							
IP1508A1	POLYSTYREN E U SHAPED PROFILE 2000X60X60	1.710	M																																																							
RC1200A0	ED=4 WIRE D.=0.5 COMPRESSIO N SPRING	2	PZ																																																							
SL1050A1	3M TRANSFER ADHESIVE TAPE	0.660	M																																																							
TB2306A0	LMISS STEFANIA/ELENA DOOR RIGHT COLUMN	2	PZ																																																							
VM1025A0	Ø16 GREY NYLON LID	2	PZ																																																							
VM1059A1	HEAT SHRINK FILM H800	1.350	M																																																							
VM1695A0	HANDLE POSITION PIN	2	PZ																																																							
VM1916A0	RIGHT UPPER COLUMN CAP	1	PZ																																																							
VM1917A0	LEFT UPPER COLUMN CAP	1	PZ																																																							
VM1918A0	RIGHT LOWER COLUMN CAP	1	PZ																																																							
VM1919A0	LEFT LOWER COLUMN CAP	1	PZ																																																							
VM1920A0	INTERNAL GLASS CLOSING RIGHT PLATE	1	PZ																																																							



COMPONENT			SPARE PART																																																										
Code	Description	Image	Code	Description	Components list																																																								
VM1916A	RIGHT UPPER COLUMN CAP		KVT1066A	L.M. ELENA EXTERNAL GLASS KIT	<table border="1"> <thead> <tr> <th>Code</th> <th>Description</th> <th>Qty</th> <th>UOM</th> </tr> </thead> <tbody> <tr> <td>VM1921A0</td> <td>INTERNAL GLASS CLOSING LEFT PLATE</td> <td>1</td> <td>PZ</td> </tr> <tr> <td>VT1066A2</td> <td>YELLOW SER 798X344X5</td> <td>1</td> <td>PZ</td> </tr> <tr> <td>VT1066A2</td> <td>YELLOW SER 798X344X5</td> <td>1</td> <td>PZ</td> </tr> </tbody> </table>	Code	Description	Qty	UOM	VM1921A0	INTERNAL GLASS CLOSING LEFT PLATE	1	PZ	VT1066A2	YELLOW SER 798X344X5	1	PZ	VT1066A2	YELLOW SER 798X344X5	1	PZ																																								
			Code	Description	Qty	UOM																																																							
VM1921A0	INTERNAL GLASS CLOSING LEFT PLATE	1	PZ																																																										
VT1066A2	YELLOW SER 798X344X5	1	PZ																																																										
VT1066A2	YELLOW SER 798X344X5	1	PZ																																																										
KVM1916A	LMISS 60X40 RIGHT UPPER DOOR	<table border="1"> <thead> <tr> <th>Code</th> <th>Description</th> <th>Qty</th> <th>UOM</th> </tr> </thead> <tbody> <tr> <td>VM1916A0</td> <td>RIGHT UPPER COLUMN CAP</td> <td>1</td> <td>PZ</td> </tr> </tbody> </table>	Code	Description	Qty	UOM	VM1916A0	RIGHT UPPER COLUMN CAP	1	PZ																																																			
Code	Description	Qty	UOM																																																										
VM1916A0	RIGHT UPPER COLUMN CAP	1	PZ																																																										
VM1920A	INTERNAL GLASS CLOSING RIGHT PLATE		KVT1253A	COLUMN CAP XF-XFT195-EG-VT1253A EXTERNAL GLASS KIT	<table border="1"> <thead> <tr> <th>Code</th> <th>Description</th> <th>Qty</th> <th>UOM</th> </tr> </thead> <tbody> <tr> <td>IP1235B0</td> <td>POLYSTYREN E FLAT PACKING</td> <td>1</td> <td>PZ</td> </tr> <tr> <td>RC1200A0</td> <td>ED=4 WIRE D.=0.5 COMPRESSIO N SPRING</td> <td>2</td> <td>PZ</td> </tr> <tr> <td>SL1050A1</td> <td>3M TRANSFER ADHESIVE TAPE</td> <td>0.820</td> <td>M</td> </tr> <tr> <td>TB2301A0</td> <td>RIGHT COLUMN XVC105E 40X40X1</td> <td>1</td> <td>PZ</td> </tr> <tr> <td>TB3081A0</td> <td>LMISS ARIANNA/ROS SELLA DOOR LEFT COLUMN</td> <td>1</td> <td>PZ</td> </tr> <tr> <td>VM1025A0</td> <td>Ø16 GREY NYLON LID</td> <td>2</td> <td>PZ</td> </tr> <tr> <td>VM1695A0</td> <td>HANDLE POSITION PIN</td> <td>2</td> <td>PZ</td> </tr> <tr> <td>VM1916A0</td> <td>RIGHT UPPER COLUMN CAP</td> <td>1</td> <td>PZ</td> </tr> <tr> <td>VM1917A0</td> <td>LEFT UPPER COLUMN CAP</td> <td>1</td> <td>PZ</td> </tr> <tr> <td>VM1918A0</td> <td>RIGHT LOWER COLUMN CAP</td> <td>1</td> <td>PZ</td> </tr> <tr> <td>VM1919A0</td> <td>LEFT LOWER COLUMN CAP</td> <td>1</td> <td>PZ</td> </tr> <tr> <td>VM1920A0</td> <td>INTERNAL GLASS CLOSING RIGHT PLATE</td> <td>1</td> <td>PZ</td> </tr> <tr> <td>VM1921A0</td> <td>INTERNAL GLASS CLOSING LEFT PLATE</td> <td>1</td> <td>PZ</td> </tr> </tbody> </table>	Code	Description	Qty	UOM	IP1235B0	POLYSTYREN E FLAT PACKING	1	PZ	RC1200A0	ED=4 WIRE D.=0.5 COMPRESSIO N SPRING	2	PZ	SL1050A1	3M TRANSFER ADHESIVE TAPE	0.820	M	TB2301A0	RIGHT COLUMN XVC105E 40X40X1	1	PZ	TB3081A0	LMISS ARIANNA/ROS SELLA DOOR LEFT COLUMN	1	PZ	VM1025A0	Ø16 GREY NYLON LID	2	PZ	VM1695A0	HANDLE POSITION PIN	2	PZ	VM1916A0	RIGHT UPPER COLUMN CAP	1	PZ	VM1917A0	LEFT UPPER COLUMN CAP	1	PZ	VM1918A0	RIGHT LOWER COLUMN CAP	1	PZ	VM1919A0	LEFT LOWER COLUMN CAP	1	PZ	VM1920A0	INTERNAL GLASS CLOSING RIGHT PLATE	1	PZ	VM1921A0	INTERNAL GLASS CLOSING LEFT PLATE	1	PZ
					Code	Description	Qty	UOM																																																					
					IP1235B0	POLYSTYREN E FLAT PACKING	1	PZ																																																					
					RC1200A0	ED=4 WIRE D.=0.5 COMPRESSIO N SPRING	2	PZ																																																					
					SL1050A1	3M TRANSFER ADHESIVE TAPE	0.820	M																																																					
					TB2301A0	RIGHT COLUMN XVC105E 40X40X1	1	PZ																																																					
					TB3081A0	LMISS ARIANNA/ROS SELLA DOOR LEFT COLUMN	1	PZ																																																					
					VM1025A0	Ø16 GREY NYLON LID	2	PZ																																																					
					VM1695A0	HANDLE POSITION PIN	2	PZ																																																					
					VM1916A0	RIGHT UPPER COLUMN CAP	1	PZ																																																					
					VM1917A0	LEFT UPPER COLUMN CAP	1	PZ																																																					
					VM1918A0	RIGHT LOWER COLUMN CAP	1	PZ																																																					
					VM1919A0	LEFT LOWER COLUMN CAP	1	PZ																																																					
					VM1920A0	INTERNAL GLASS CLOSING RIGHT PLATE	1	PZ																																																					
					VM1921A0	INTERNAL GLASS CLOSING LEFT PLATE	1	PZ																																																					

COMPONENT			SPARE PART																																																			
Code	Description	Image	Code	Description	Components list																																																	
VM1920A	INTERNAL GLASS CLOSING RIGHT PLATE		KVT1253A	XF-XFT195-EG- VT1253A EXTERNAL GLASS KIT	<table border="1"> <thead> <tr> <th>Code</th> <th>Description</th> <th>Qty</th> <th>UOM</th> </tr> </thead> <tbody> <tr> <td>VT1253A0</td> <td>XF-XFT195 DOOR EXT. BLACK GLASS-ENGEF OOD</td> <td>1</td> <td>PZ</td> </tr> <tr> <td>VT1253A0</td> <td>XF-XFT195 DOOR EXT. BLACK GLASS-ENGEF OOD</td> <td>1</td> <td>PZ</td> </tr> </tbody> </table>	Code	Description	Qty	UOM	VT1253A0	XF-XFT195 DOOR EXT. BLACK GLASS-ENGEF OOD	1	PZ	VT1253A0	XF-XFT195 DOOR EXT. BLACK GLASS-ENGEF OOD	1	PZ																																					
			Code	Description	Qty	UOM																																																
VT1253A0	XF-XFT195 DOOR EXT. BLACK GLASS-ENGEF OOD	1	PZ																																																			
VT1253A0	XF-XFT195 DOOR EXT. BLACK GLASS-ENGEF OOD	1	PZ																																																			
KVT1252A	XF135-EG- VT1252A EXTERNAL GLASS KIT	<table border="1"> <thead> <tr> <th>Code</th> <th>Description</th> <th>Qty</th> <th>UOM</th> </tr> </thead> <tbody> <tr> <td>RC1200A0</td> <td>ED=4 WIRE D.=0.5 COMPRESSIO N SPRING</td> <td>2</td> <td>PZ</td> </tr> <tr> <td>SL1050A1</td> <td>3M TRANSFER ADHESIVE TAPE</td> <td>0.820</td> <td>M</td> </tr> <tr> <td>TB2301A0</td> <td>RIGHT COLUMN XVC105E 40X40X1</td> <td>1</td> <td>PZ</td> </tr> <tr> <td>TB3081A0</td> <td>LMISS ARIANNA/ROS SELLA DOOR LEFT COLUMN</td> <td>1</td> <td>PZ</td> </tr> <tr> <td>VM1025A0</td> <td>Ø16 GREY NYLON LID</td> <td>2</td> <td>PZ</td> </tr> <tr> <td>VM1695A0</td> <td>HANDLE POSITION PIN</td> <td>2</td> <td>PZ</td> </tr> <tr> <td>VM1920A0</td> <td>INTERNAL GLASS CLOSING RIGHT PLATE</td> <td>1</td> <td>PZ</td> </tr> <tr> <td>VM1921A0</td> <td>INTERNAL GLASS CLOSING LEFT PLATE</td> <td>1</td> <td>PZ</td> </tr> <tr> <td>VM2062A0</td> <td>L.MISS 46X33 RIGHT UPPER DOOR COLUMN CAP</td> <td>1</td> <td>PZ</td> </tr> <tr> <td>VM2063A0</td> <td>L.MISS 46X33 LEFT UPPER DOOR COLUMN CAP</td> <td>1</td> <td>PZ</td> </tr> <tr> <td>VM2064A0</td> <td>L.MISS 46X33 RIGHT LOWER DOOR COLUMN CAP</td> <td>1</td> <td>PZ</td> </tr> <tr> <td>VM2065A0</td> <td>L.MISS 46X33 LEFT LOWER DOOR COLUMN CAP</td> <td>1</td> <td>PZ</td> </tr> </tbody> </table>	Code	Description	Qty	UOM	RC1200A0	ED=4 WIRE D.=0.5 COMPRESSIO N SPRING	2	PZ	SL1050A1	3M TRANSFER ADHESIVE TAPE	0.820	M	TB2301A0	RIGHT COLUMN XVC105E 40X40X1	1	PZ	TB3081A0	LMISS ARIANNA/ROS SELLA DOOR LEFT COLUMN	1	PZ	VM1025A0	Ø16 GREY NYLON LID	2	PZ	VM1695A0	HANDLE POSITION PIN	2	PZ	VM1920A0	INTERNAL GLASS CLOSING RIGHT PLATE	1	PZ	VM1921A0	INTERNAL GLASS CLOSING LEFT PLATE	1	PZ	VM2062A0	L.MISS 46X33 RIGHT UPPER DOOR COLUMN CAP	1	PZ	VM2063A0	L.MISS 46X33 LEFT UPPER DOOR COLUMN CAP	1	PZ	VM2064A0	L.MISS 46X33 RIGHT LOWER DOOR COLUMN CAP	1	PZ	VM2065A0	L.MISS 46X33 LEFT LOWER DOOR COLUMN CAP	1	PZ
Code	Description	Qty	UOM																																																			
RC1200A0	ED=4 WIRE D.=0.5 COMPRESSIO N SPRING	2	PZ																																																			
SL1050A1	3M TRANSFER ADHESIVE TAPE	0.820	M																																																			
TB2301A0	RIGHT COLUMN XVC105E 40X40X1	1	PZ																																																			
TB3081A0	LMISS ARIANNA/ROS SELLA DOOR LEFT COLUMN	1	PZ																																																			
VM1025A0	Ø16 GREY NYLON LID	2	PZ																																																			
VM1695A0	HANDLE POSITION PIN	2	PZ																																																			
VM1920A0	INTERNAL GLASS CLOSING RIGHT PLATE	1	PZ																																																			
VM1921A0	INTERNAL GLASS CLOSING LEFT PLATE	1	PZ																																																			
VM2062A0	L.MISS 46X33 RIGHT UPPER DOOR COLUMN CAP	1	PZ																																																			
VM2063A0	L.MISS 46X33 LEFT UPPER DOOR COLUMN CAP	1	PZ																																																			
VM2064A0	L.MISS 46X33 RIGHT LOWER DOOR COLUMN CAP	1	PZ																																																			
VM2065A0	L.MISS 46X33 LEFT LOWER DOOR COLUMN CAP	1	PZ																																																			

COMPONENT			SPARE PART																																																															
Code	Description	Image	Code	Description	Components list																																																													
VM1920A	INTERNAL GLASS CLOSING RIGHT PLATE		KVT1252A	XF135-EG- VT1252A EXTERNAL GLASS KIT	<table border="1"> <thead> <tr> <th>Code</th> <th>Description</th> <th>Qty</th> <th>UOM</th> </tr> </thead> <tbody> <tr> <td>VT1252A0</td> <td>XFT135 DOOR EXT. BLACK GLASS - ENGEFOOD</td> <td>1</td> <td>PZ</td> </tr> <tr> <td>VT1252A0</td> <td>XFT135 DOOR EXT. BLACK GLASS - ENGEFOOD</td> <td>1</td> <td>PZ</td> </tr> </tbody> </table>	Code	Description	Qty	UOM	VT1252A0	XFT135 DOOR EXT. BLACK GLASS - ENGEFOOD	1	PZ	VT1252A0	XFT135 DOOR EXT. BLACK GLASS - ENGEFOOD	1	PZ																																																	
			Code	Description	Qty	UOM																																																												
VT1252A0	XFT135 DOOR EXT. BLACK GLASS - ENGEFOOD	1	PZ																																																															
VT1252A0	XFT135 DOOR EXT. BLACK GLASS - ENGEFOOD	1	PZ																																																															
KVT1072A	L.M. ROSSELLA BLACK EXTERNAL GLASS KIT	<table border="1"> <thead> <tr> <th>Code</th> <th>Description</th> <th>Qty</th> <th>UOM</th> </tr> </thead> <tbody> <tr> <td>IP1385A1</td> <td>CORNER POLYSTYREN E PACKING 110X80X2000</td> <td>0.960</td> <td>M</td> </tr> <tr> <td>IP1508A1</td> <td>POLYSTYREN E U SHAPED PROFILE 2000X60X60</td> <td>1.270</td> <td>M</td> </tr> <tr> <td>RC1200A0</td> <td>ED=4 WIRE D.=0.5 COMPRESSIO N SPRING</td> <td>2</td> <td>PZ</td> </tr> <tr> <td>SL1050A1</td> <td>3M TRANSFER ADHESIVE TAPE</td> <td>0.820</td> <td>M</td> </tr> <tr> <td>TB2301A0</td> <td>RIGHT COLUMN XVC105E 40X40X1</td> <td>1</td> <td>PZ</td> </tr> <tr> <td>TB3081A0</td> <td>LMISS ARIANNA/ROS SELLA DOOR LEFT COLUMN</td> <td>1</td> <td>PZ</td> </tr> <tr> <td>VM1025A0</td> <td>Ø16 GREY NYLON LID</td> <td>2</td> <td>PZ</td> </tr> <tr> <td>VM1059A1</td> <td>HEAT SHRINK FILM H800</td> <td>1.300</td> <td>M</td> </tr> <tr> <td>VM1695A0</td> <td>HANDLE POSITION PIN</td> <td>2</td> <td>PZ</td> </tr> <tr> <td>VM1916A0</td> <td>RIGHT UPPER COLUMN CAP</td> <td>1</td> <td>PZ</td> </tr> <tr> <td>VM1917A0</td> <td>LEFT UPPER COLUMN CAP</td> <td>1</td> <td>PZ</td> </tr> <tr> <td>VM1918A0</td> <td>RIGHT LOWER COLUMN CAP</td> <td>1</td> <td>PZ</td> </tr> <tr> <td>VM1919A0</td> <td>LEFT LOWER COLUMN CAP</td> <td>1</td> <td>PZ</td> </tr> <tr> <td>VM1920A0</td> <td>INTERNAL GLASS CLOSING RIGHT PLATE</td> <td>1</td> <td>PZ</td> </tr> <tr> <td>VM1921A0</td> <td>INTERNAL GLASS CLOSING LEFT PLATE</td> <td>1</td> <td>PZ</td> </tr> </tbody> </table>	Code	Description	Qty	UOM	IP1385A1	CORNER POLYSTYREN E PACKING 110X80X2000	0.960	M	IP1508A1	POLYSTYREN E U SHAPED PROFILE 2000X60X60	1.270	M	RC1200A0	ED=4 WIRE D.=0.5 COMPRESSIO N SPRING	2	PZ	SL1050A1	3M TRANSFER ADHESIVE TAPE	0.820	M	TB2301A0	RIGHT COLUMN XVC105E 40X40X1	1	PZ	TB3081A0	LMISS ARIANNA/ROS SELLA DOOR LEFT COLUMN	1	PZ	VM1025A0	Ø16 GREY NYLON LID	2	PZ	VM1059A1	HEAT SHRINK FILM H800	1.300	M	VM1695A0	HANDLE POSITION PIN	2	PZ	VM1916A0	RIGHT UPPER COLUMN CAP	1	PZ	VM1917A0	LEFT UPPER COLUMN CAP	1	PZ	VM1918A0	RIGHT LOWER COLUMN CAP	1	PZ	VM1919A0	LEFT LOWER COLUMN CAP	1	PZ	VM1920A0	INTERNAL GLASS CLOSING RIGHT PLATE	1	PZ	VM1921A0	INTERNAL GLASS CLOSING LEFT PLATE	1	PZ
Code	Description	Qty	UOM																																																															
IP1385A1	CORNER POLYSTYREN E PACKING 110X80X2000	0.960	M																																																															
IP1508A1	POLYSTYREN E U SHAPED PROFILE 2000X60X60	1.270	M																																																															
RC1200A0	ED=4 WIRE D.=0.5 COMPRESSIO N SPRING	2	PZ																																																															
SL1050A1	3M TRANSFER ADHESIVE TAPE	0.820	M																																																															
TB2301A0	RIGHT COLUMN XVC105E 40X40X1	1	PZ																																																															
TB3081A0	LMISS ARIANNA/ROS SELLA DOOR LEFT COLUMN	1	PZ																																																															
VM1025A0	Ø16 GREY NYLON LID	2	PZ																																																															
VM1059A1	HEAT SHRINK FILM H800	1.300	M																																																															
VM1695A0	HANDLE POSITION PIN	2	PZ																																																															
VM1916A0	RIGHT UPPER COLUMN CAP	1	PZ																																																															
VM1917A0	LEFT UPPER COLUMN CAP	1	PZ																																																															
VM1918A0	RIGHT LOWER COLUMN CAP	1	PZ																																																															
VM1919A0	LEFT LOWER COLUMN CAP	1	PZ																																																															
VM1920A0	INTERNAL GLASS CLOSING RIGHT PLATE	1	PZ																																																															
VM1921A0	INTERNAL GLASS CLOSING LEFT PLATE	1	PZ																																																															

COMPONENT			SPARE PART																																																																			
Code	Description	Image	Code	Description	Components list																																																																	
VM1920A	INTERNAL GLASS CLOSING RIGHT PLATE		KVT1072A	L.M. ROSSELLA BLACK EXTERNAL GLASS KIT	<table border="1"> <thead> <tr> <th>Code</th> <th>Description</th> <th>Qty</th> <th>UOM</th> </tr> </thead> <tbody> <tr> <td>VT1072A0</td> <td>LINEMISS ROSSELLA BLACK EXTERNAL GLASS</td> <td>1</td> <td>PZ</td> </tr> <tr> <td>VT1072A0</td> <td>LINEMISS ROSSELLA BLACK EXTERNAL GLASS</td> <td>1</td> <td>PZ</td> </tr> </tbody> </table>	Code	Description	Qty	UOM	VT1072A0	LINEMISS ROSSELLA BLACK EXTERNAL GLASS	1	PZ	VT1072A0	LINEMISS ROSSELLA BLACK EXTERNAL GLASS	1	PZ																																																					
			Code	Description	Qty	UOM																																																																
VT1072A0	LINEMISS ROSSELLA BLACK EXTERNAL GLASS	1	PZ																																																																			
VT1072A0	LINEMISS ROSSELLA BLACK EXTERNAL GLASS	1	PZ																																																																			
KVT1071A	L.M. ROSSELLA EXTERNAL GLASS KIT	<table border="1"> <thead> <tr> <th>Code</th> <th>Description</th> <th>Qty</th> <th>UOM</th> </tr> </thead> <tbody> <tr> <td>IP1385A1</td> <td>CORNER POLYSTYREN E PACKING 110X80X2000</td> <td>0.960</td> <td>M</td> </tr> <tr> <td>IP1508A1</td> <td>POLYSTYREN E U SHAPED PROFILE 2000X60X60</td> <td>1.300</td> <td>M</td> </tr> <tr> <td>RC1200A0</td> <td>ED=4 WIRE D.=0.5 COMPRESSIO N SPRING</td> <td>2</td> <td>PZ</td> </tr> <tr> <td>SL1050A1</td> <td>3M TRANSFER ADHESIVE TAPE</td> <td>0.820</td> <td>M</td> </tr> <tr> <td>TB2301A0</td> <td>RIGHT COLUMN XVC105E 40X40X1</td> <td>2</td> <td>PZ</td> </tr> <tr> <td>VM1025A0</td> <td>Ø16 GREY NYLON LID</td> <td>2</td> <td>PZ</td> </tr> <tr> <td>VM1059A1</td> <td>HEAT SHRINK FILM H800</td> <td>1.350</td> <td>M</td> </tr> <tr> <td>VM1695A0</td> <td>HANDLE POSITION PIN</td> <td>2</td> <td>PZ</td> </tr> <tr> <td>VM1916A0</td> <td>RIGHT UPPER COLUMN CAP</td> <td>1</td> <td>PZ</td> </tr> <tr> <td>VM1917A0</td> <td>LEFT UPPER COLUMN CAP</td> <td>1</td> <td>PZ</td> </tr> <tr> <td>VM1918A0</td> <td>RIGHT LOWER COLUMN CAP</td> <td>1</td> <td>PZ</td> </tr> <tr> <td>VM1919A0</td> <td>LEFT LOWER COLUMN CAP</td> <td>1</td> <td>PZ</td> </tr> <tr> <td>VM1920A0</td> <td>INTERNAL GLASS CLOSING RIGHT PLATE</td> <td>1</td> <td>PZ</td> </tr> <tr> <td>VM1921A0</td> <td>INTERNAL GLASS CLOSING LEFT PLATE</td> <td>1</td> <td>PZ</td> </tr> <tr> <td>VT1071A2</td> <td>YELLOW SER GLASS 798X424X5</td> <td>1</td> <td>PZ</td> </tr> <tr> <td>VT1071A2</td> <td>YELLOW SER GLASS 798X424X5</td> <td>1</td> <td>PZ</td> </tr> </tbody> </table>	Code	Description	Qty	UOM	IP1385A1	CORNER POLYSTYREN E PACKING 110X80X2000	0.960	M	IP1508A1	POLYSTYREN E U SHAPED PROFILE 2000X60X60	1.300	M	RC1200A0	ED=4 WIRE D.=0.5 COMPRESSIO N SPRING	2	PZ	SL1050A1	3M TRANSFER ADHESIVE TAPE	0.820	M	TB2301A0	RIGHT COLUMN XVC105E 40X40X1	2	PZ	VM1025A0	Ø16 GREY NYLON LID	2	PZ	VM1059A1	HEAT SHRINK FILM H800	1.350	M	VM1695A0	HANDLE POSITION PIN	2	PZ	VM1916A0	RIGHT UPPER COLUMN CAP	1	PZ	VM1917A0	LEFT UPPER COLUMN CAP	1	PZ	VM1918A0	RIGHT LOWER COLUMN CAP	1	PZ	VM1919A0	LEFT LOWER COLUMN CAP	1	PZ	VM1920A0	INTERNAL GLASS CLOSING RIGHT PLATE	1	PZ	VM1921A0	INTERNAL GLASS CLOSING LEFT PLATE	1	PZ	VT1071A2	YELLOW SER GLASS 798X424X5	1	PZ	VT1071A2	YELLOW SER GLASS 798X424X5	1	PZ
Code	Description	Qty	UOM																																																																			
IP1385A1	CORNER POLYSTYREN E PACKING 110X80X2000	0.960	M																																																																			
IP1508A1	POLYSTYREN E U SHAPED PROFILE 2000X60X60	1.300	M																																																																			
RC1200A0	ED=4 WIRE D.=0.5 COMPRESSIO N SPRING	2	PZ																																																																			
SL1050A1	3M TRANSFER ADHESIVE TAPE	0.820	M																																																																			
TB2301A0	RIGHT COLUMN XVC105E 40X40X1	2	PZ																																																																			
VM1025A0	Ø16 GREY NYLON LID	2	PZ																																																																			
VM1059A1	HEAT SHRINK FILM H800	1.350	M																																																																			
VM1695A0	HANDLE POSITION PIN	2	PZ																																																																			
VM1916A0	RIGHT UPPER COLUMN CAP	1	PZ																																																																			
VM1917A0	LEFT UPPER COLUMN CAP	1	PZ																																																																			
VM1918A0	RIGHT LOWER COLUMN CAP	1	PZ																																																																			
VM1919A0	LEFT LOWER COLUMN CAP	1	PZ																																																																			
VM1920A0	INTERNAL GLASS CLOSING RIGHT PLATE	1	PZ																																																																			
VM1921A0	INTERNAL GLASS CLOSING LEFT PLATE	1	PZ																																																																			
VT1071A2	YELLOW SER GLASS 798X424X5	1	PZ																																																																			
VT1071A2	YELLOW SER GLASS 798X424X5	1	PZ																																																																			

COMPONENT			SPARE PART																																																																										
Code	Description	Image	Code	Description	Components list																																																																								
VM1920A	INTERNAL GLASS CLOSING RIGHT PLATE		KVT1067A	L.M. ELENA BLACK EXTERNAL GLASS KIT	<table border="1"> <thead> <tr> <th>Code</th> <th>Description</th> <th>Qty</th> <th>UOM</th> </tr> </thead> <tbody> <tr> <td>IP1385A1</td> <td>CORNER POLYSTYREN E PACKING 110X80X2000</td> <td>0.800</td> <td>M</td> </tr> <tr> <td>IP1508A1</td> <td>POLYSTYREN E U SHAPED PROFILE 2000X60X60</td> <td>1.710</td> <td>M</td> </tr> <tr> <td>RC1200A0</td> <td>ED=4 WIRE D.=0.5 COMPRESSIO N SPRING</td> <td>2</td> <td>PZ</td> </tr> <tr> <td>SL1050A1</td> <td>3M TRANSFER ADHESIVE TAPE</td> <td>0.660</td> <td>M</td> </tr> <tr> <td>TB2306A0</td> <td>LMISS STEFANIA/ELE NA DOOR RIGHT COLUM</td> <td>1</td> <td>PZ</td> </tr> <tr> <td>TB3080A0</td> <td>LMISS STEFANIA/ELE NA DOOR LEFT COLUMN</td> <td>1</td> <td>PZ</td> </tr> <tr> <td>VM1025A0</td> <td>Ø16 GREY NYLON LID</td> <td>2</td> <td>PZ</td> </tr> <tr> <td>VM1059A1</td> <td>HEAT SHRINK FILM H800</td> <td>1.350</td> <td>M</td> </tr> <tr> <td>VM1695A0</td> <td>HANDLE POSITION PIN</td> <td>2</td> <td>PZ</td> </tr> <tr> <td>VM1916A0</td> <td>RIGHT UPPER COLUMN CAP</td> <td>1</td> <td>PZ</td> </tr> <tr> <td>VM1917A0</td> <td>LEFT UPPER COLUMN CAP</td> <td>1</td> <td>PZ</td> </tr> <tr> <td>VM1918A0</td> <td>RIGHT LOWER COLUMN CAP</td> <td>1</td> <td>PZ</td> </tr> <tr> <td>VM1919A0</td> <td>LEFT LOWER COLUMN CAP</td> <td>1</td> <td>PZ</td> </tr> <tr> <td>VM1920A0</td> <td>INTERNAL GLASS CLOSING RIGHT PLATE</td> <td>1</td> <td>PZ</td> </tr> <tr> <td>VM1921A0</td> <td>INTERNAL GLASS CLOSING LEFT PLATE</td> <td>1</td> <td>PZ</td> </tr> <tr> <td>VT1067A0</td> <td>LINEMISS ELENA BLACK EXTERNAL DOOR GLASS</td> <td>1</td> <td>PZ</td> </tr> <tr> <td>VT1067A0</td> <td>LINEMISS ELENA BLACK EXTERNAL DOOR GLASS</td> <td>1</td> <td>PZ</td> </tr> </tbody> </table>	Code	Description	Qty	UOM	IP1385A1	CORNER POLYSTYREN E PACKING 110X80X2000	0.800	M	IP1508A1	POLYSTYREN E U SHAPED PROFILE 2000X60X60	1.710	M	RC1200A0	ED=4 WIRE D.=0.5 COMPRESSIO N SPRING	2	PZ	SL1050A1	3M TRANSFER ADHESIVE TAPE	0.660	M	TB2306A0	LMISS STEFANIA/ELE NA DOOR RIGHT COLUM	1	PZ	TB3080A0	LMISS STEFANIA/ELE NA DOOR LEFT COLUMN	1	PZ	VM1025A0	Ø16 GREY NYLON LID	2	PZ	VM1059A1	HEAT SHRINK FILM H800	1.350	M	VM1695A0	HANDLE POSITION PIN	2	PZ	VM1916A0	RIGHT UPPER COLUMN CAP	1	PZ	VM1917A0	LEFT UPPER COLUMN CAP	1	PZ	VM1918A0	RIGHT LOWER COLUMN CAP	1	PZ	VM1919A0	LEFT LOWER COLUMN CAP	1	PZ	VM1920A0	INTERNAL GLASS CLOSING RIGHT PLATE	1	PZ	VM1921A0	INTERNAL GLASS CLOSING LEFT PLATE	1	PZ	VT1067A0	LINEMISS ELENA BLACK EXTERNAL DOOR GLASS	1	PZ	VT1067A0	LINEMISS ELENA BLACK EXTERNAL DOOR GLASS	1	PZ
Code	Description	Qty	UOM																																																																										
IP1385A1	CORNER POLYSTYREN E PACKING 110X80X2000	0.800	M																																																																										
IP1508A1	POLYSTYREN E U SHAPED PROFILE 2000X60X60	1.710	M																																																																										
RC1200A0	ED=4 WIRE D.=0.5 COMPRESSIO N SPRING	2	PZ																																																																										
SL1050A1	3M TRANSFER ADHESIVE TAPE	0.660	M																																																																										
TB2306A0	LMISS STEFANIA/ELE NA DOOR RIGHT COLUM	1	PZ																																																																										
TB3080A0	LMISS STEFANIA/ELE NA DOOR LEFT COLUMN	1	PZ																																																																										
VM1025A0	Ø16 GREY NYLON LID	2	PZ																																																																										
VM1059A1	HEAT SHRINK FILM H800	1.350	M																																																																										
VM1695A0	HANDLE POSITION PIN	2	PZ																																																																										
VM1916A0	RIGHT UPPER COLUMN CAP	1	PZ																																																																										
VM1917A0	LEFT UPPER COLUMN CAP	1	PZ																																																																										
VM1918A0	RIGHT LOWER COLUMN CAP	1	PZ																																																																										
VM1919A0	LEFT LOWER COLUMN CAP	1	PZ																																																																										
VM1920A0	INTERNAL GLASS CLOSING RIGHT PLATE	1	PZ																																																																										
VM1921A0	INTERNAL GLASS CLOSING LEFT PLATE	1	PZ																																																																										
VT1067A0	LINEMISS ELENA BLACK EXTERNAL DOOR GLASS	1	PZ																																																																										
VT1067A0	LINEMISS ELENA BLACK EXTERNAL DOOR GLASS	1	PZ																																																																										

COMPONENT			SPARE PART																																																																																	
Code	Description	Image	Code	Description	Components list																																																																															
VM1920A	INTERNAL GLASS CLOSING RIGHT PLATE		KVT1066A	L.M. ELENA EXTERNAL GLASS KIT	<table border="1"> <thead> <tr> <th>Code</th> <th>Description</th> <th>Qty</th> <th>UOM</th> </tr> </thead> <tbody> <tr> <td>IP1385A1</td> <td>CORNER POLYSTYREN E PACKING 110X80X2000</td> <td>0.800</td> <td>M</td> </tr> <tr> <td>IP1508A1</td> <td>POLYSTYREN E U SHAPED PROFILE 2000X60X60</td> <td>1.710</td> <td>M</td> </tr> <tr> <td>RC1200A0</td> <td>ED=4 WIRE D.=0.5 COMPRESSIO N SPRING</td> <td>2</td> <td>PZ</td> </tr> <tr> <td>SL1050A1</td> <td>3M TRANSFER ADHESIVE TAPE</td> <td>0.660</td> <td>M</td> </tr> <tr> <td>TB2306A0</td> <td>LMISS STEFANIA/ELE NA DOOR RIGHT COLUM</td> <td>2</td> <td>PZ</td> </tr> <tr> <td>VM1025A0</td> <td>Ø16 GREY NYLON LID</td> <td>2</td> <td>PZ</td> </tr> <tr> <td>VM1059A1</td> <td>HEAT SHRINK FILM H800</td> <td>1.350</td> <td>M</td> </tr> <tr> <td>VM1695A0</td> <td>HANDLE POSITION PIN</td> <td>2</td> <td>PZ</td> </tr> <tr> <td>VM1916A0</td> <td>RIGHT UPPER COLUMN CAP</td> <td>1</td> <td>PZ</td> </tr> <tr> <td>VM1917A0</td> <td>LEFT UPPER COLUMN CAP</td> <td>1</td> <td>PZ</td> </tr> <tr> <td>VM1918A0</td> <td>RIGHT LOWER COLUMN CAP</td> <td>1</td> <td>PZ</td> </tr> <tr> <td>VM1919A0</td> <td>LEFT LOWER COLUMN CAP</td> <td>1</td> <td>PZ</td> </tr> <tr> <td>VM1920A0</td> <td>INTERNAL GLASS CLOSING RIGHT PLATE</td> <td>1</td> <td>PZ</td> </tr> <tr> <td>VM1921A0</td> <td>INTERNAL GLASS CLOSING LEFT PLATE</td> <td>1</td> <td>PZ</td> </tr> <tr> <td>VT1066A2</td> <td>YELLOW SER GLASS 798X344X5</td> <td>1</td> <td>PZ</td> </tr> <tr> <td>VT1066A2</td> <td>YELLOW SER GLASS 798X344X5</td> <td>1</td> <td>PZ</td> </tr> </tbody> </table>	Code	Description	Qty	UOM	IP1385A1	CORNER POLYSTYREN E PACKING 110X80X2000	0.800	M	IP1508A1	POLYSTYREN E U SHAPED PROFILE 2000X60X60	1.710	M	RC1200A0	ED=4 WIRE D.=0.5 COMPRESSIO N SPRING	2	PZ	SL1050A1	3M TRANSFER ADHESIVE TAPE	0.660	M	TB2306A0	LMISS STEFANIA/ELE NA DOOR RIGHT COLUM	2	PZ	VM1025A0	Ø16 GREY NYLON LID	2	PZ	VM1059A1	HEAT SHRINK FILM H800	1.350	M	VM1695A0	HANDLE POSITION PIN	2	PZ	VM1916A0	RIGHT UPPER COLUMN CAP	1	PZ	VM1917A0	LEFT UPPER COLUMN CAP	1	PZ	VM1918A0	RIGHT LOWER COLUMN CAP	1	PZ	VM1919A0	LEFT LOWER COLUMN CAP	1	PZ	VM1920A0	INTERNAL GLASS CLOSING RIGHT PLATE	1	PZ	VM1921A0	INTERNAL GLASS CLOSING LEFT PLATE	1	PZ	VT1066A2	YELLOW SER GLASS 798X344X5	1	PZ	VT1066A2	YELLOW SER GLASS 798X344X5	1	PZ	KVT1063A	L.MISS ARIANNA FORNETTI EXT. GLASS KIT	<table border="1"> <thead> <tr> <th>Code</th> <th>Description</th> <th>Qty</th> <th>UOM</th> </tr> </thead> <tbody> <tr> <td>IP1385A1</td> <td>CORNER POLYSTYREN E PACKING 110X80X2000</td> <td>0.980</td> <td>M</td> </tr> </tbody> </table>	Code	Description	Qty	UOM	IP1385A1	CORNER POLYSTYREN E PACKING 110X80X2000	0.980	M
			Code	Description	Qty	UOM																																																																														
IP1385A1	CORNER POLYSTYREN E PACKING 110X80X2000	0.800	M																																																																																	
IP1508A1	POLYSTYREN E U SHAPED PROFILE 2000X60X60	1.710	M																																																																																	
RC1200A0	ED=4 WIRE D.=0.5 COMPRESSIO N SPRING	2	PZ																																																																																	
SL1050A1	3M TRANSFER ADHESIVE TAPE	0.660	M																																																																																	
TB2306A0	LMISS STEFANIA/ELE NA DOOR RIGHT COLUM	2	PZ																																																																																	
VM1025A0	Ø16 GREY NYLON LID	2	PZ																																																																																	
VM1059A1	HEAT SHRINK FILM H800	1.350	M																																																																																	
VM1695A0	HANDLE POSITION PIN	2	PZ																																																																																	
VM1916A0	RIGHT UPPER COLUMN CAP	1	PZ																																																																																	
VM1917A0	LEFT UPPER COLUMN CAP	1	PZ																																																																																	
VM1918A0	RIGHT LOWER COLUMN CAP	1	PZ																																																																																	
VM1919A0	LEFT LOWER COLUMN CAP	1	PZ																																																																																	
VM1920A0	INTERNAL GLASS CLOSING RIGHT PLATE	1	PZ																																																																																	
VM1921A0	INTERNAL GLASS CLOSING LEFT PLATE	1	PZ																																																																																	
VT1066A2	YELLOW SER GLASS 798X344X5	1	PZ																																																																																	
VT1066A2	YELLOW SER GLASS 798X344X5	1	PZ																																																																																	
Code	Description	Qty	UOM																																																																																	
IP1385A1	CORNER POLYSTYREN E PACKING 110X80X2000	0.980	M																																																																																	

COMPONENT			SPARE PART																																																																										
Code	Description	Image	Code	Description	Components list																																																																								
VM1920A	INTERNAL GLASS CLOSING RIGHT PLATE		KVT1063A	L.MISS ARIANNA FORNETTI EXT. GLASS KIT	<table border="1"> <thead> <tr> <th>Code</th> <th>Description</th> <th>Qty</th> <th>UOM</th> </tr> </thead> <tbody> <tr> <td>IP1508A1</td> <td>POLYSTYREN E U SHAPED PROFILE 2000X60X60</td> <td>0.960</td> <td>M</td> </tr> <tr> <td>MS1009A0</td> <td>FORNETTI LOGO LABEL</td> <td>1</td> <td>PZ</td> </tr> <tr> <td>RC1200A0</td> <td>ED=4 WIRE D.=0.5 COMPRESSIO N SPRING</td> <td>2</td> <td>PZ</td> </tr> <tr> <td>SL1050A1</td> <td>3M TRANSFER ADHESIVE TAPE</td> <td>0.820</td> <td>M</td> </tr> <tr> <td>TB2301A0</td> <td>RIGHT COLUMN XVC105E 40X40X1</td> <td>1</td> <td>PZ</td> </tr> <tr> <td>TB3081A0</td> <td>LMISS ARIANNA/ROS SELLA DOOR LEFT COLUMN</td> <td>1</td> <td>PZ</td> </tr> <tr> <td>VM1025A0</td> <td>Ø16 GREY NYLON LID</td> <td>2</td> <td>PZ</td> </tr> <tr> <td>VM1059A1</td> <td>HEAT SHRINK FILM H800</td> <td>1.300</td> <td>M</td> </tr> <tr> <td>VM1695A0</td> <td>HANDLE POSITION PIN</td> <td>2</td> <td>PZ</td> </tr> <tr> <td>VM1920A0</td> <td>INTERNAL GLASS CLOSING RIGHT PLATE</td> <td>1</td> <td>PZ</td> </tr> <tr> <td>VM1921A0</td> <td>INTERNAL GLASS CLOSING LEFT PLATE</td> <td>1</td> <td>PZ</td> </tr> <tr> <td>VM2062A0</td> <td>L.MISS 46X33 RIGHT UPPER DOOR COLUMN CAP</td> <td>1</td> <td>PZ</td> </tr> <tr> <td>VM2063A0</td> <td>L.MISS 46X33 LEFT UPPER DOOR COLUMN CAP</td> <td>1</td> <td>PZ</td> </tr> <tr> <td>VM2064A0</td> <td>L.MISS 46X33 RIGHT LOWER DOOR COLUMN CAP</td> <td>1</td> <td>PZ</td> </tr> <tr> <td>VM2065A0</td> <td>L.MISS 46X33 LEFT LOWER DOOR COLUMN CAP</td> <td>1</td> <td>PZ</td> </tr> <tr> <td>VT1063A0</td> <td>XF135F EXTERNAL GLASS 598X42</td> <td>1</td> <td>PZ</td> </tr> <tr> <td>VT1063A0</td> <td>XF135F EXTERNAL GLASS 598X42</td> <td>1</td> <td>PZ</td> </tr> </tbody> </table>	Code	Description	Qty	UOM	IP1508A1	POLYSTYREN E U SHAPED PROFILE 2000X60X60	0.960	M	MS1009A0	FORNETTI LOGO LABEL	1	PZ	RC1200A0	ED=4 WIRE D.=0.5 COMPRESSIO N SPRING	2	PZ	SL1050A1	3M TRANSFER ADHESIVE TAPE	0.820	M	TB2301A0	RIGHT COLUMN XVC105E 40X40X1	1	PZ	TB3081A0	LMISS ARIANNA/ROS SELLA DOOR LEFT COLUMN	1	PZ	VM1025A0	Ø16 GREY NYLON LID	2	PZ	VM1059A1	HEAT SHRINK FILM H800	1.300	M	VM1695A0	HANDLE POSITION PIN	2	PZ	VM1920A0	INTERNAL GLASS CLOSING RIGHT PLATE	1	PZ	VM1921A0	INTERNAL GLASS CLOSING LEFT PLATE	1	PZ	VM2062A0	L.MISS 46X33 RIGHT UPPER DOOR COLUMN CAP	1	PZ	VM2063A0	L.MISS 46X33 LEFT UPPER DOOR COLUMN CAP	1	PZ	VM2064A0	L.MISS 46X33 RIGHT LOWER DOOR COLUMN CAP	1	PZ	VM2065A0	L.MISS 46X33 LEFT LOWER DOOR COLUMN CAP	1	PZ	VT1063A0	XF135F EXTERNAL GLASS 598X42	1	PZ	VT1063A0	XF135F EXTERNAL GLASS 598X42	1	PZ
Code	Description	Qty	UOM																																																																										
IP1508A1	POLYSTYREN E U SHAPED PROFILE 2000X60X60	0.960	M																																																																										
MS1009A0	FORNETTI LOGO LABEL	1	PZ																																																																										
RC1200A0	ED=4 WIRE D.=0.5 COMPRESSIO N SPRING	2	PZ																																																																										
SL1050A1	3M TRANSFER ADHESIVE TAPE	0.820	M																																																																										
TB2301A0	RIGHT COLUMN XVC105E 40X40X1	1	PZ																																																																										
TB3081A0	LMISS ARIANNA/ROS SELLA DOOR LEFT COLUMN	1	PZ																																																																										
VM1025A0	Ø16 GREY NYLON LID	2	PZ																																																																										
VM1059A1	HEAT SHRINK FILM H800	1.300	M																																																																										
VM1695A0	HANDLE POSITION PIN	2	PZ																																																																										
VM1920A0	INTERNAL GLASS CLOSING RIGHT PLATE	1	PZ																																																																										
VM1921A0	INTERNAL GLASS CLOSING LEFT PLATE	1	PZ																																																																										
VM2062A0	L.MISS 46X33 RIGHT UPPER DOOR COLUMN CAP	1	PZ																																																																										
VM2063A0	L.MISS 46X33 LEFT UPPER DOOR COLUMN CAP	1	PZ																																																																										
VM2064A0	L.MISS 46X33 RIGHT LOWER DOOR COLUMN CAP	1	PZ																																																																										
VM2065A0	L.MISS 46X33 LEFT LOWER DOOR COLUMN CAP	1	PZ																																																																										
VT1063A0	XF135F EXTERNAL GLASS 598X42	1	PZ																																																																										
VT1063A0	XF135F EXTERNAL GLASS 598X42	1	PZ																																																																										





COMPONENT			SPARE PART																																																																						
Code	Description	Image	Code	Description	Components list																																																																				
VM1920A	INTERNAL GLASS CLOSING RIGHT PLATE		KVT1062A	L.M. ARIANNA BLACK EXTERNAL GLASS KIT	<table border="1"> <thead> <tr> <th>Code</th> <th>Description</th> <th>Qty</th> <th>UOM</th> </tr> </thead> <tbody> <tr> <td>IP1385A1</td> <td>CORNER POLYSTYREN E PACKING 110X80X2000</td> <td>1.280</td> <td>M</td> </tr> <tr> <td>RC1200A0</td> <td>ED=4 WIRE D.=0.5 COMPRESSIO N SPRING</td> <td>2</td> <td>PZ</td> </tr> <tr> <td>SL1050A1</td> <td>3M TRANSFER ADHESIVE TAPE</td> <td>0.820</td> <td>M</td> </tr> <tr> <td>TB2301A0</td> <td>RIGHT COLUMN XVC105E 40X40X1</td> <td>1</td> <td>PZ</td> </tr> <tr> <td>TB3081A0</td> <td>LMISS ARIANNA/ROS SELLA DOOR LEFT COLUMN</td> <td>1</td> <td>PZ</td> </tr> <tr> <td>VM1025A0</td> <td>Ø16 GREY NYLON LID</td> <td>2</td> <td>PZ</td> </tr> <tr> <td>VM1059A1</td> <td>HEAT SHRINK FILM H800</td> <td>1</td> <td>M</td> </tr> <tr> <td>VM1695A0</td> <td>HANDLE POSITION PIN</td> <td>2</td> <td>PZ</td> </tr> <tr> <td>VM1920A0</td> <td>INTERNAL GLASS CLOSING RIGHT PLATE</td> <td>1</td> <td>PZ</td> </tr> <tr> <td>VM1921A0</td> <td>INTERNAL GLASS CLOSING LEFT PLATE</td> <td>1</td> <td>PZ</td> </tr> <tr> <td>VM2062A0</td> <td>L.MISS 46X33 RIGHT UPPER DOOR COLUMN CAP</td> <td>1</td> <td>PZ</td> </tr> <tr> <td>VM2063A0</td> <td>L.MISS 46X33 LEFT UPPER DOOR COLUMN CAP</td> <td>1</td> <td>PZ</td> </tr> <tr> <td>VM2064A0</td> <td>L.MISS 46X33 RIGHT LOWER DOOR COLUMN CAP</td> <td>1</td> <td>PZ</td> </tr> <tr> <td>VM2065A0</td> <td>L.MISS 46X33 LEFT LOWER DOOR COLUMN CAP</td> <td>1</td> <td>PZ</td> </tr> <tr> <td>VT1062A0</td> <td>LINEMISS ARIANNA GREY EXTERNAL GLASS</td> <td>1</td> <td>PZ</td> </tr> <tr> <td>VT1062A0</td> <td>LINEMISS ARIANNA GREY EXTERNAL GLASS</td> <td>1</td> <td>PZ</td> </tr> </tbody> </table>	Code	Description	Qty	UOM	IP1385A1	CORNER POLYSTYREN E PACKING 110X80X2000	1.280	M	RC1200A0	ED=4 WIRE D.=0.5 COMPRESSIO N SPRING	2	PZ	SL1050A1	3M TRANSFER ADHESIVE TAPE	0.820	M	TB2301A0	RIGHT COLUMN XVC105E 40X40X1	1	PZ	TB3081A0	LMISS ARIANNA/ROS SELLA DOOR LEFT COLUMN	1	PZ	VM1025A0	Ø16 GREY NYLON LID	2	PZ	VM1059A1	HEAT SHRINK FILM H800	1	M	VM1695A0	HANDLE POSITION PIN	2	PZ	VM1920A0	INTERNAL GLASS CLOSING RIGHT PLATE	1	PZ	VM1921A0	INTERNAL GLASS CLOSING LEFT PLATE	1	PZ	VM2062A0	L.MISS 46X33 RIGHT UPPER DOOR COLUMN CAP	1	PZ	VM2063A0	L.MISS 46X33 LEFT UPPER DOOR COLUMN CAP	1	PZ	VM2064A0	L.MISS 46X33 RIGHT LOWER DOOR COLUMN CAP	1	PZ	VM2065A0	L.MISS 46X33 LEFT LOWER DOOR COLUMN CAP	1	PZ	VT1062A0	LINEMISS ARIANNA GREY EXTERNAL GLASS	1	PZ	VT1062A0	LINEMISS ARIANNA GREY EXTERNAL GLASS	1	PZ
Code	Description	Qty	UOM																																																																						
IP1385A1	CORNER POLYSTYREN E PACKING 110X80X2000	1.280	M																																																																						
RC1200A0	ED=4 WIRE D.=0.5 COMPRESSIO N SPRING	2	PZ																																																																						
SL1050A1	3M TRANSFER ADHESIVE TAPE	0.820	M																																																																						
TB2301A0	RIGHT COLUMN XVC105E 40X40X1	1	PZ																																																																						
TB3081A0	LMISS ARIANNA/ROS SELLA DOOR LEFT COLUMN	1	PZ																																																																						
VM1025A0	Ø16 GREY NYLON LID	2	PZ																																																																						
VM1059A1	HEAT SHRINK FILM H800	1	M																																																																						
VM1695A0	HANDLE POSITION PIN	2	PZ																																																																						
VM1920A0	INTERNAL GLASS CLOSING RIGHT PLATE	1	PZ																																																																						
VM1921A0	INTERNAL GLASS CLOSING LEFT PLATE	1	PZ																																																																						
VM2062A0	L.MISS 46X33 RIGHT UPPER DOOR COLUMN CAP	1	PZ																																																																						
VM2063A0	L.MISS 46X33 LEFT UPPER DOOR COLUMN CAP	1	PZ																																																																						
VM2064A0	L.MISS 46X33 RIGHT LOWER DOOR COLUMN CAP	1	PZ																																																																						
VM2065A0	L.MISS 46X33 LEFT LOWER DOOR COLUMN CAP	1	PZ																																																																						
VT1062A0	LINEMISS ARIANNA GREY EXTERNAL GLASS	1	PZ																																																																						
VT1062A0	LINEMISS ARIANNA GREY EXTERNAL GLASS	1	PZ																																																																						



COMPONENT			SPARE PART																																																																		
Code	Description	Image	Code	Description	Components list																																																																
VM1920A	INTERNAL GLASS CLOSING RIGHT PLATE		KVT1061A	L.M. ARIANNA EXTERNAL YELLOW GLASS KIT	<table border="1"> <thead> <tr> <th>Code</th> <th>Description</th> <th>Qty</th> <th>UOM</th> </tr> </thead> <tbody> <tr> <td>IP1385A1</td> <td>CORNER POLYSTYREN E PACKING 110X80X2000</td> <td>1.280</td> <td>M</td> </tr> <tr> <td>RC1200A0</td> <td>ED=4 WIRE D.=0.5 COMPRESSIO N SPRING</td> <td>2</td> <td>PZ</td> </tr> <tr> <td>SL1050A1</td> <td>3M TRANSFER ADHESIVE TAPE</td> <td>0.820</td> <td>M</td> </tr> <tr> <td>TB2301A0</td> <td>RIGHT COLUMN XVC105E 40X40X1</td> <td>2</td> <td>PZ</td> </tr> <tr> <td>VM1025A0</td> <td>Ø16 GREY NYLON LID</td> <td>2</td> <td>PZ</td> </tr> <tr> <td>VM1059A1</td> <td>HEAT SHRINK FILM H800</td> <td>1.300</td> <td>M</td> </tr> <tr> <td>VM1695A0</td> <td>HANDLE POSITION PIN</td> <td>2</td> <td>PZ</td> </tr> <tr> <td>VM1920A0</td> <td>INTERNAL GLASS CLOSING RIGHT PLATE</td> <td>1</td> <td>PZ</td> </tr> <tr> <td>VM1921A0</td> <td>INTERNAL GLASS CLOSING LEFT PLATE</td> <td>1</td> <td>PZ</td> </tr> <tr> <td>VM2062A0</td> <td>L.MISS 46X33 RIGHT UPPER DOOR COLUMN CAP</td> <td>1</td> <td>PZ</td> </tr> <tr> <td>VM2063A0</td> <td>L.MISS 46X33 LEFT UPPER DOOR COLUMN CAP</td> <td>1</td> <td>PZ</td> </tr> <tr> <td>VM2064A0</td> <td>L.MISS 46X33 RIGHT LOWER DOOR COLUMN CAP</td> <td>1</td> <td>PZ</td> </tr> <tr> <td>VM2065A0</td> <td>L.MISS 46X33 LEFT LOWER DOOR COLUMN CAP</td> <td>1</td> <td>PZ</td> </tr> <tr> <td>VT1061A2</td> <td>EXTERNAL YELLOW SER.GLASS 598X424X5</td> <td>1</td> <td>PZ</td> </tr> <tr> <td>VT1061A2</td> <td>EXTERNAL YELLOW SER.GLASS 598X424X5</td> <td>1</td> <td>PZ</td> </tr> </tbody> </table>	Code	Description	Qty	UOM	IP1385A1	CORNER POLYSTYREN E PACKING 110X80X2000	1.280	M	RC1200A0	ED=4 WIRE D.=0.5 COMPRESSIO N SPRING	2	PZ	SL1050A1	3M TRANSFER ADHESIVE TAPE	0.820	M	TB2301A0	RIGHT COLUMN XVC105E 40X40X1	2	PZ	VM1025A0	Ø16 GREY NYLON LID	2	PZ	VM1059A1	HEAT SHRINK FILM H800	1.300	M	VM1695A0	HANDLE POSITION PIN	2	PZ	VM1920A0	INTERNAL GLASS CLOSING RIGHT PLATE	1	PZ	VM1921A0	INTERNAL GLASS CLOSING LEFT PLATE	1	PZ	VM2062A0	L.MISS 46X33 RIGHT UPPER DOOR COLUMN CAP	1	PZ	VM2063A0	L.MISS 46X33 LEFT UPPER DOOR COLUMN CAP	1	PZ	VM2064A0	L.MISS 46X33 RIGHT LOWER DOOR COLUMN CAP	1	PZ	VM2065A0	L.MISS 46X33 LEFT LOWER DOOR COLUMN CAP	1	PZ	VT1061A2	EXTERNAL YELLOW SER.GLASS 598X424X5	1	PZ	VT1061A2	EXTERNAL YELLOW SER.GLASS 598X424X5	1	PZ
Code	Description	Qty	UOM																																																																		
IP1385A1	CORNER POLYSTYREN E PACKING 110X80X2000	1.280	M																																																																		
RC1200A0	ED=4 WIRE D.=0.5 COMPRESSIO N SPRING	2	PZ																																																																		
SL1050A1	3M TRANSFER ADHESIVE TAPE	0.820	M																																																																		
TB2301A0	RIGHT COLUMN XVC105E 40X40X1	2	PZ																																																																		
VM1025A0	Ø16 GREY NYLON LID	2	PZ																																																																		
VM1059A1	HEAT SHRINK FILM H800	1.300	M																																																																		
VM1695A0	HANDLE POSITION PIN	2	PZ																																																																		
VM1920A0	INTERNAL GLASS CLOSING RIGHT PLATE	1	PZ																																																																		
VM1921A0	INTERNAL GLASS CLOSING LEFT PLATE	1	PZ																																																																		
VM2062A0	L.MISS 46X33 RIGHT UPPER DOOR COLUMN CAP	1	PZ																																																																		
VM2063A0	L.MISS 46X33 LEFT UPPER DOOR COLUMN CAP	1	PZ																																																																		
VM2064A0	L.MISS 46X33 RIGHT LOWER DOOR COLUMN CAP	1	PZ																																																																		
VM2065A0	L.MISS 46X33 LEFT LOWER DOOR COLUMN CAP	1	PZ																																																																		
VT1061A2	EXTERNAL YELLOW SER.GLASS 598X424X5	1	PZ																																																																		
VT1061A2	EXTERNAL YELLOW SER.GLASS 598X424X5	1	PZ																																																																		

COMPONENT			SPARE PART																																																																		
Code	Description	Image	Code	Description	Components list																																																																
VM1920A	INTERNAL GLASS CLOSING RIGHT PLATE		KVT1057A	LM STEFANIA BLACK EXTERNAL GLASS KIT	<table border="1"> <thead> <tr> <th>Code</th> <th>Description</th> <th>Qty</th> <th>UOM</th> </tr> </thead> <tbody> <tr> <td>IP1385A1</td> <td>CORNER POLYSTYRENE PACKING 110X80X2000</td> <td>0.810</td> <td>M</td> </tr> <tr> <td>IP1508A1</td> <td>POLYSTYRENE U SHAPED PROFILE 2000X60X60</td> <td>0.960</td> <td>M</td> </tr> <tr> <td>RC1200A0</td> <td>ED=4 WIRE D.=0.5 COMPRESSIO N SPRING</td> <td>2</td> <td>PZ</td> </tr> <tr> <td>SL1050A1</td> <td>3M TRANSFER ADHESIVE TAPE</td> <td>0.660</td> <td>M</td> </tr> <tr> <td>TB2306A0</td> <td>LMISS STEFANIA/ELE NA DOOR RIGHT COLUMN</td> <td>1</td> <td>PZ</td> </tr> <tr> <td>TB3080A0</td> <td>LMISS STEFANIA/ELE NA DOOR LEFT COLUMN</td> <td>1</td> <td>PZ</td> </tr> <tr> <td>VM1025A0</td> <td>Ø16 GREY NYLON LID</td> <td>2</td> <td>PZ</td> </tr> <tr> <td>VM1059A1</td> <td>HEAT SHRINK FILM H800</td> <td>1</td> <td>M</td> </tr> <tr> <td>VM1695A0</td> <td>HANDLE POSITION PIN</td> <td>2</td> <td>PZ</td> </tr> <tr> <td>VM1920A0</td> <td>INTERNAL GLASS CLOSING RIGHT PLATE</td> <td>1</td> <td>PZ</td> </tr> <tr> <td>VM1921A0</td> <td>INTERNAL GLASS CLOSING LEFT PLATE</td> <td>1</td> <td>PZ</td> </tr> <tr> <td>VM2062A0</td> <td>L.MISS 46X33 RIGHT UPPER DOOR COLUMN CAP</td> <td>1</td> <td>PZ</td> </tr> <tr> <td>VM2063A0</td> <td>L.MISS 46X33 LEFT UPPER DOOR COLUMN CAP</td> <td>1</td> <td>PZ</td> </tr> <tr> <td>VM2064A0</td> <td>L.MISS 46X33 RIGHT LOWER DOOR COLUMN CAP</td> <td>1</td> <td>PZ</td> </tr> <tr> <td>VM2065A0</td> <td>L.MISS 46X33 LEFT LOWER DOOR COLUMN CAP</td> <td>1</td> <td>PZ</td> </tr> </tbody> </table>	Code	Description	Qty	UOM	IP1385A1	CORNER POLYSTYRENE PACKING 110X80X2000	0.810	M	IP1508A1	POLYSTYRENE U SHAPED PROFILE 2000X60X60	0.960	M	RC1200A0	ED=4 WIRE D.=0.5 COMPRESSIO N SPRING	2	PZ	SL1050A1	3M TRANSFER ADHESIVE TAPE	0.660	M	TB2306A0	LMISS STEFANIA/ELE NA DOOR RIGHT COLUMN	1	PZ	TB3080A0	LMISS STEFANIA/ELE NA DOOR LEFT COLUMN	1	PZ	VM1025A0	Ø16 GREY NYLON LID	2	PZ	VM1059A1	HEAT SHRINK FILM H800	1	M	VM1695A0	HANDLE POSITION PIN	2	PZ	VM1920A0	INTERNAL GLASS CLOSING RIGHT PLATE	1	PZ	VM1921A0	INTERNAL GLASS CLOSING LEFT PLATE	1	PZ	VM2062A0	L.MISS 46X33 RIGHT UPPER DOOR COLUMN CAP	1	PZ	VM2063A0	L.MISS 46X33 LEFT UPPER DOOR COLUMN CAP	1	PZ	VM2064A0	L.MISS 46X33 RIGHT LOWER DOOR COLUMN CAP	1	PZ	VM2065A0	L.MISS 46X33 LEFT LOWER DOOR COLUMN CAP	1	PZ
Code	Description	Qty	UOM																																																																		
IP1385A1	CORNER POLYSTYRENE PACKING 110X80X2000	0.810	M																																																																		
IP1508A1	POLYSTYRENE U SHAPED PROFILE 2000X60X60	0.960	M																																																																		
RC1200A0	ED=4 WIRE D.=0.5 COMPRESSIO N SPRING	2	PZ																																																																		
SL1050A1	3M TRANSFER ADHESIVE TAPE	0.660	M																																																																		
TB2306A0	LMISS STEFANIA/ELE NA DOOR RIGHT COLUMN	1	PZ																																																																		
TB3080A0	LMISS STEFANIA/ELE NA DOOR LEFT COLUMN	1	PZ																																																																		
VM1025A0	Ø16 GREY NYLON LID	2	PZ																																																																		
VM1059A1	HEAT SHRINK FILM H800	1	M																																																																		
VM1695A0	HANDLE POSITION PIN	2	PZ																																																																		
VM1920A0	INTERNAL GLASS CLOSING RIGHT PLATE	1	PZ																																																																		
VM1921A0	INTERNAL GLASS CLOSING LEFT PLATE	1	PZ																																																																		
VM2062A0	L.MISS 46X33 RIGHT UPPER DOOR COLUMN CAP	1	PZ																																																																		
VM2063A0	L.MISS 46X33 LEFT UPPER DOOR COLUMN CAP	1	PZ																																																																		
VM2064A0	L.MISS 46X33 RIGHT LOWER DOOR COLUMN CAP	1	PZ																																																																		
VM2065A0	L.MISS 46X33 LEFT LOWER DOOR COLUMN CAP	1	PZ																																																																		

COMPONENT			SPARE PART																																																			
Code	Description	Image	Code	Description	Components list																																																	
VM1920A	INTERNAL GLASS CLOSING RIGHT PLATE		KVT1057A	LM STEFANIA BLACK EXTERNAL GLASS KIT	<table border="1"> <thead> <tr> <th>Code</th> <th>Description</th> <th>Qty</th> <th>UOM</th> </tr> </thead> <tbody> <tr> <td>VT1057A0</td> <td>L.MISS STEFANIA EXTERNAL GLASS 598X344X5</td> <td>1</td> <td>PZ</td> </tr> <tr> <td>VT1057A0</td> <td>L.MISS STEFANIA EXTERNAL GLASS 598X344X5</td> <td>1</td> <td>PZ</td> </tr> </tbody> </table>	Code	Description	Qty	UOM	VT1057A0	L.MISS STEFANIA EXTERNAL GLASS 598X344X5	1	PZ	VT1057A0	L.MISS STEFANIA EXTERNAL GLASS 598X344X5	1	PZ																																					
			Code	Description	Qty	UOM																																																
VT1057A0	L.MISS STEFANIA EXTERNAL GLASS 598X344X5	1	PZ																																																			
VT1057A0	L.MISS STEFANIA EXTERNAL GLASS 598X344X5	1	PZ																																																			
KVT1056A	LM STEFANIA YELLOW EXTERNAL GLASS KIT	<table border="1"> <thead> <tr> <th>Code</th> <th>Description</th> <th>Qty</th> <th>UOM</th> </tr> </thead> <tbody> <tr> <td>IP1385A1</td> <td>CORNER POLYSTYREN E PACKING 110X80X2000</td> <td>0.980</td> <td>M</td> </tr> <tr> <td>IP1508A1</td> <td>POLYSTYREN E U SHAPED PROFILE 2000X60X60</td> <td>0.960</td> <td>M</td> </tr> <tr> <td>RC1200A0</td> <td>ED=4 WIRE D.=0.5 COMPRESSIO N SPRING</td> <td>2</td> <td>PZ</td> </tr> <tr> <td>SL1050A1</td> <td>3M TRANSFER ADHESIVE TAPE</td> <td>0.660</td> <td>M</td> </tr> <tr> <td>TB2306A0</td> <td>L.MISS STEFANIA/ELE NA DOOR RIGHT COLUM</td> <td>2</td> <td>PZ</td> </tr> <tr> <td>VM1025A0</td> <td>Ø16 GREY NYLON LID</td> <td>2</td> <td>PZ</td> </tr> <tr> <td>VM1059A1</td> <td>HEAT SHRINK FILM H800</td> <td>1.300</td> <td>M</td> </tr> <tr> <td>VM1695A0</td> <td>HANDLE POSITION PIN</td> <td>2</td> <td>PZ</td> </tr> <tr> <td>VM1920A0</td> <td>INTERNAL GLASS CLOSING RIGHT PLATE</td> <td>1</td> <td>PZ</td> </tr> <tr> <td>VM1921A0</td> <td>INTERNAL GLASS CLOSING LEFT PLATE</td> <td>1</td> <td>PZ</td> </tr> <tr> <td>VM2062A0</td> <td>L.MISS 46X33 RIGHT UPPER DOOR COLUMN CAP</td> <td>1</td> <td>PZ</td> </tr> <tr> <td>VM2063A0</td> <td>L.MISS 46X33 LEFT UPPER DOOR COLUMN CAP</td> <td>1</td> <td>PZ</td> </tr> </tbody> </table>	Code	Description	Qty	UOM	IP1385A1	CORNER POLYSTYREN E PACKING 110X80X2000	0.980	M	IP1508A1	POLYSTYREN E U SHAPED PROFILE 2000X60X60	0.960	M	RC1200A0	ED=4 WIRE D.=0.5 COMPRESSIO N SPRING	2	PZ	SL1050A1	3M TRANSFER ADHESIVE TAPE	0.660	M	TB2306A0	L.MISS STEFANIA/ELE NA DOOR RIGHT COLUM	2	PZ	VM1025A0	Ø16 GREY NYLON LID	2	PZ	VM1059A1	HEAT SHRINK FILM H800	1.300	M	VM1695A0	HANDLE POSITION PIN	2	PZ	VM1920A0	INTERNAL GLASS CLOSING RIGHT PLATE	1	PZ	VM1921A0	INTERNAL GLASS CLOSING LEFT PLATE	1	PZ	VM2062A0	L.MISS 46X33 RIGHT UPPER DOOR COLUMN CAP	1	PZ	VM2063A0	L.MISS 46X33 LEFT UPPER DOOR COLUMN CAP	1	PZ
Code	Description	Qty	UOM																																																			
IP1385A1	CORNER POLYSTYREN E PACKING 110X80X2000	0.980	M																																																			
IP1508A1	POLYSTYREN E U SHAPED PROFILE 2000X60X60	0.960	M																																																			
RC1200A0	ED=4 WIRE D.=0.5 COMPRESSIO N SPRING	2	PZ																																																			
SL1050A1	3M TRANSFER ADHESIVE TAPE	0.660	M																																																			
TB2306A0	L.MISS STEFANIA/ELE NA DOOR RIGHT COLUM	2	PZ																																																			
VM1025A0	Ø16 GREY NYLON LID	2	PZ																																																			
VM1059A1	HEAT SHRINK FILM H800	1.300	M																																																			
VM1695A0	HANDLE POSITION PIN	2	PZ																																																			
VM1920A0	INTERNAL GLASS CLOSING RIGHT PLATE	1	PZ																																																			
VM1921A0	INTERNAL GLASS CLOSING LEFT PLATE	1	PZ																																																			
VM2062A0	L.MISS 46X33 RIGHT UPPER DOOR COLUMN CAP	1	PZ																																																			
VM2063A0	L.MISS 46X33 LEFT UPPER DOOR COLUMN CAP	1	PZ																																																			



COMPONENT			SPARE PART																																															
Code	Description	Image	Code	Description	Components list																																													
VM1920A	INTERNAL GLASS CLOSING RIGHT PLATE		KVT1056A	LM STEFANIA YELLOW EXTERNAL GLASS KIT	<table border="1"> <thead> <tr> <th>Code</th> <th>Description</th> <th>Qty</th> <th>UOM</th> </tr> </thead> <tbody> <tr> <td>VM2064A0</td> <td>L.MISS 46X33 RIGHT LOWER DOOR COLUMN CAP</td> <td>1</td> <td>PZ</td> </tr> <tr> <td>VM2065A0</td> <td>L.MISS 46X33 LEFT LOWER DOOR COLUMN CAP</td> <td>1</td> <td>PZ</td> </tr> <tr> <td>VT1056A2</td> <td>YELLOW SER GLASS 598X344X5</td> <td>1</td> <td>PZ</td> </tr> <tr> <td>VT1056A2</td> <td>YELLOW SER GLASS 598X344X5</td> <td>1</td> <td>PZ</td> </tr> </tbody> </table>	Code	Description	Qty	UOM	VM2064A0	L.MISS 46X33 RIGHT LOWER DOOR COLUMN CAP	1	PZ	VM2065A0	L.MISS 46X33 LEFT LOWER DOOR COLUMN CAP	1	PZ	VT1056A2	YELLOW SER GLASS 598X344X5	1	PZ	VT1056A2	YELLOW SER GLASS 598X344X5	1	PZ																									
			Code	Description	Qty	UOM																																												
VM2064A0	L.MISS 46X33 RIGHT LOWER DOOR COLUMN CAP	1	PZ																																															
VM2065A0	L.MISS 46X33 LEFT LOWER DOOR COLUMN CAP	1	PZ																																															
VT1056A2	YELLOW SER GLASS 598X344X5	1	PZ																																															
VT1056A2	YELLOW SER GLASS 598X344X5	1	PZ																																															
KVT1052A	LM CRISTINA BLACK EXTERNAL GLASS KIT	<table border="1"> <thead> <tr> <th>Code</th> <th>Description</th> <th>Qty</th> <th>UOM</th> </tr> </thead> <tbody> <tr> <td>RC1200A0</td> <td>ED=4 WIRE D.=0.5 COMPRESSIO N SPRING</td> <td>2</td> <td>PZ</td> </tr> <tr> <td>SL1050A1</td> <td>3M TRANSFER ADHESIVE TAPE</td> <td>0.660</td> <td>M</td> </tr> <tr> <td>TB2306A0</td> <td>LMISS STEFANIA/ELE NA DOOR RIGHT COLUM</td> <td>2</td> <td>PZ</td> </tr> <tr> <td>VM1025A0</td> <td>Ø16 GREY NYLON LID</td> <td>2</td> <td>PZ</td> </tr> <tr> <td>VM1695A0</td> <td>HANDLE POSITION PIN</td> <td>2</td> <td>PZ</td> </tr> <tr> <td>VM1920A0</td> <td>INTERNAL GLASS CLOSING RIGHT PLATE</td> <td>1</td> <td>PZ</td> </tr> <tr> <td>VM1921A0</td> <td>INTERNAL GLASS CLOSING LEFT PLATE</td> <td>1</td> <td>PZ</td> </tr> <tr> <td>VM2062A0</td> <td>L.MISS 46X33 RIGHT UPPER DOOR COLUMN CAP</td> <td>1</td> <td>PZ</td> </tr> <tr> <td>VM2063A0</td> <td>L.MISS 46X33 LEFT UPPER DOOR COLUMN CAP</td> <td>1</td> <td>PZ</td> </tr> <tr> <td>VM2064A0</td> <td>L.MISS 46X33 RIGHT LOWER DOOR COLUMN CAP</td> <td>1</td> <td>PZ</td> </tr> <tr> <td>VM2065A0</td> <td>L.MISS 46X33 LEFT LOWER DOOR COLUMN CAP</td> <td>1</td> <td>PZ</td> </tr> </tbody> </table>	Code	Description	Qty	UOM	RC1200A0	ED=4 WIRE D.=0.5 COMPRESSIO N SPRING	2	PZ	SL1050A1	3M TRANSFER ADHESIVE TAPE	0.660	M	TB2306A0	LMISS STEFANIA/ELE NA DOOR RIGHT COLUM	2	PZ	VM1025A0	Ø16 GREY NYLON LID	2	PZ	VM1695A0	HANDLE POSITION PIN	2	PZ	VM1920A0	INTERNAL GLASS CLOSING RIGHT PLATE	1	PZ	VM1921A0	INTERNAL GLASS CLOSING LEFT PLATE	1	PZ	VM2062A0	L.MISS 46X33 RIGHT UPPER DOOR COLUMN CAP	1	PZ	VM2063A0	L.MISS 46X33 LEFT UPPER DOOR COLUMN CAP	1	PZ	VM2064A0	L.MISS 46X33 RIGHT LOWER DOOR COLUMN CAP	1	PZ	VM2065A0	L.MISS 46X33 LEFT LOWER DOOR COLUMN CAP	1	PZ
Code	Description	Qty	UOM																																															
RC1200A0	ED=4 WIRE D.=0.5 COMPRESSIO N SPRING	2	PZ																																															
SL1050A1	3M TRANSFER ADHESIVE TAPE	0.660	M																																															
TB2306A0	LMISS STEFANIA/ELE NA DOOR RIGHT COLUM	2	PZ																																															
VM1025A0	Ø16 GREY NYLON LID	2	PZ																																															
VM1695A0	HANDLE POSITION PIN	2	PZ																																															
VM1920A0	INTERNAL GLASS CLOSING RIGHT PLATE	1	PZ																																															
VM1921A0	INTERNAL GLASS CLOSING LEFT PLATE	1	PZ																																															
VM2062A0	L.MISS 46X33 RIGHT UPPER DOOR COLUMN CAP	1	PZ																																															
VM2063A0	L.MISS 46X33 LEFT UPPER DOOR COLUMN CAP	1	PZ																																															
VM2064A0	L.MISS 46X33 RIGHT LOWER DOOR COLUMN CAP	1	PZ																																															
VM2065A0	L.MISS 46X33 LEFT LOWER DOOR COLUMN CAP	1	PZ																																															



COMPONENT			SPARE PART																																																															
Code	Description	Image	Code	Description	Components list																																																													
VM1920A	INTERNAL GLASS CLOSING RIGHT PLATE		KVT1052A	LM CRISTINA BLACK EXTERNAL GLASS KIT	<table border="1"> <thead> <tr> <th>Code</th> <th>Description</th> <th>Qty</th> <th>UOM</th> </tr> </thead> <tbody> <tr> <td>VT1052A0</td> <td>478X344X5 EXTERNAL GLASS</td> <td>1</td> <td>PZ</td> </tr> <tr> <td>VT1052A0</td> <td>478X344X5 EXTERNAL GLASS</td> <td>1</td> <td>PZ</td> </tr> </tbody> </table>	Code	Description	Qty	UOM	VT1052A0	478X344X5 EXTERNAL GLASS	1	PZ	VT1052A0	478X344X5 EXTERNAL GLASS	1	PZ																																																	
			Code	Description	Qty	UOM																																																												
VT1052A0	478X344X5 EXTERNAL GLASS	1	PZ																																																															
VT1052A0	478X344X5 EXTERNAL GLASS	1	PZ																																																															
KVT1051A	LM CRISTINA YELLOW EXTERNAL GLASS KIT	<table border="1"> <thead> <tr> <th>Code</th> <th>Description</th> <th>Qty</th> <th>UOM</th> </tr> </thead> <tbody> <tr> <td>IP1385A1</td> <td>CORNER POLYSTYRENE PACKING 110X80X2000</td> <td>1.040</td> <td>M</td> </tr> <tr> <td>RC1200A0</td> <td>ED=4 WIRE D.=0.5 COMPRESSIO N SPRING</td> <td>2</td> <td>PZ</td> </tr> <tr> <td>SL1050A1</td> <td>3M TRANSFER ADHESIVE TAPE</td> <td>0.660</td> <td>M</td> </tr> <tr> <td>TB2306A0</td> <td>LMISS STEFANIA/ELE NA DOOR RIGHT COLUM</td> <td>2</td> <td>PZ</td> </tr> <tr> <td>VM1025A0</td> <td>Ø16 GREY NYLON LID</td> <td>2</td> <td>PZ</td> </tr> <tr> <td>VM1059A1</td> <td>HEAT SHRINK FILM H800</td> <td>1.500</td> <td>M</td> </tr> <tr> <td>VM1695A0</td> <td>HANDLE POSITION PIN</td> <td>2</td> <td>PZ</td> </tr> <tr> <td>VM1920A0</td> <td>INTERNAL GLASS CLOSING RIGHT PLATE</td> <td>1</td> <td>PZ</td> </tr> <tr> <td>VM1921A0</td> <td>INTERNAL GLASS CLOSING LEFT PLATE</td> <td>1</td> <td>PZ</td> </tr> <tr> <td>VM2062A0</td> <td>L.MISS 46X33 RIGHT UPPER DOOR COLUMN CAP</td> <td>1</td> <td>PZ</td> </tr> <tr> <td>VM2063A0</td> <td>L.MISS 46X33 LEFT UPPER DOOR COLUMN CAP</td> <td>1</td> <td>PZ</td> </tr> <tr> <td>VM2064A0</td> <td>L.MISS 46X33 RIGHT LOWER DOOR COLUMN CAP</td> <td>1</td> <td>PZ</td> </tr> <tr> <td>VM2065A0</td> <td>L.MISS 46X33 LEFT LOWER DOOR COLUMN CAP</td> <td>1</td> <td>PZ</td> </tr> <tr> <td>VT1051A2</td> <td>YELLOW SER 478X344X5</td> <td>1</td> <td>PZ</td> </tr> <tr> <td>VT1051A2</td> <td>YELLOW SER 478X344X5</td> <td>1</td> <td>PZ</td> </tr> </tbody> </table>	Code	Description	Qty	UOM	IP1385A1	CORNER POLYSTYRENE PACKING 110X80X2000	1.040	M	RC1200A0	ED=4 WIRE D.=0.5 COMPRESSIO N SPRING	2	PZ	SL1050A1	3M TRANSFER ADHESIVE TAPE	0.660	M	TB2306A0	LMISS STEFANIA/ELE NA DOOR RIGHT COLUM	2	PZ	VM1025A0	Ø16 GREY NYLON LID	2	PZ	VM1059A1	HEAT SHRINK FILM H800	1.500	M	VM1695A0	HANDLE POSITION PIN	2	PZ	VM1920A0	INTERNAL GLASS CLOSING RIGHT PLATE	1	PZ	VM1921A0	INTERNAL GLASS CLOSING LEFT PLATE	1	PZ	VM2062A0	L.MISS 46X33 RIGHT UPPER DOOR COLUMN CAP	1	PZ	VM2063A0	L.MISS 46X33 LEFT UPPER DOOR COLUMN CAP	1	PZ	VM2064A0	L.MISS 46X33 RIGHT LOWER DOOR COLUMN CAP	1	PZ	VM2065A0	L.MISS 46X33 LEFT LOWER DOOR COLUMN CAP	1	PZ	VT1051A2	YELLOW SER 478X344X5	1	PZ	VT1051A2	YELLOW SER 478X344X5	1	PZ
Code	Description	Qty	UOM																																																															
IP1385A1	CORNER POLYSTYRENE PACKING 110X80X2000	1.040	M																																																															
RC1200A0	ED=4 WIRE D.=0.5 COMPRESSIO N SPRING	2	PZ																																																															
SL1050A1	3M TRANSFER ADHESIVE TAPE	0.660	M																																																															
TB2306A0	LMISS STEFANIA/ELE NA DOOR RIGHT COLUM	2	PZ																																																															
VM1025A0	Ø16 GREY NYLON LID	2	PZ																																																															
VM1059A1	HEAT SHRINK FILM H800	1.500	M																																																															
VM1695A0	HANDLE POSITION PIN	2	PZ																																																															
VM1920A0	INTERNAL GLASS CLOSING RIGHT PLATE	1	PZ																																																															
VM1921A0	INTERNAL GLASS CLOSING LEFT PLATE	1	PZ																																																															
VM2062A0	L.MISS 46X33 RIGHT UPPER DOOR COLUMN CAP	1	PZ																																																															
VM2063A0	L.MISS 46X33 LEFT UPPER DOOR COLUMN CAP	1	PZ																																																															
VM2064A0	L.MISS 46X33 RIGHT LOWER DOOR COLUMN CAP	1	PZ																																																															
VM2065A0	L.MISS 46X33 LEFT LOWER DOOR COLUMN CAP	1	PZ																																																															
VT1051A2	YELLOW SER 478X344X5	1	PZ																																																															
VT1051A2	YELLOW SER 478X344X5	1	PZ																																																															

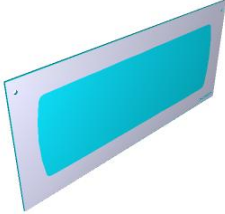

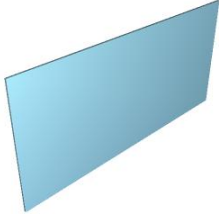
COMPONENT			SPARE PART																																																																		
Code	Description	Image	Code	Description	Components list																																																																
VM1917A	LEFT UPPER COLUMN CAP		KVM1917A	LMISS 60X40 LEFT UPPER DOOR COLUMN CAP	<table border="1"> <thead> <tr> <th>Code</th> <th>Description</th> <th>Qty</th> <th>UOM</th> </tr> </thead> <tbody> <tr> <td>VM1917A0</td> <td>LEFT UPPER COLUMN CAP</td> <td>1</td> <td>PZ</td> </tr> </tbody> </table>	Code	Description	Qty	UOM	VM1917A0	LEFT UPPER COLUMN CAP	1	PZ																																																								
Code	Description	Qty	UOM																																																																		
VM1917A0	LEFT UPPER COLUMN CAP	1	PZ																																																																		
VT1067A	LINEMISS ELENA BLACK EXTERNAL DOOR GLASS		KVT1067A	L.M. ELENA BLACK EXTERNAL GLASS KIT	<table border="1"> <thead> <tr> <th>Code</th> <th>Description</th> <th>Qty</th> <th>UOM</th> </tr> </thead> <tbody> <tr> <td>IP1385A1</td> <td>CORNER POLYSTYREN E PACKING 110X80X2000</td> <td>0.800</td> <td>M</td> </tr> <tr> <td>IP1508A1</td> <td>POLYSTYREN E U SHAPED PROFILE 2000X60X60</td> <td>1.710</td> <td>M</td> </tr> <tr> <td>RC1200A0</td> <td>ED=4 WIRE D.=0.5 COMPRESSIO N SPRING</td> <td>2</td> <td>PZ</td> </tr> <tr> <td>SL1050A1</td> <td>3M TRANSFER ADHESIVE TAPE</td> <td>0.660</td> <td>M</td> </tr> <tr> <td>TB2306A0</td> <td>LMISS STEFANIA/ELE NA DOOR RIGHT COLUM</td> <td>1</td> <td>PZ</td> </tr> <tr> <td>TB3080A0</td> <td>LMISS STEFANIA/ELE NA DOOR LEFT COLUMN</td> <td>1</td> <td>PZ</td> </tr> <tr> <td>VM1025A0</td> <td>Ø16 GREY NYLON LID</td> <td>2</td> <td>PZ</td> </tr> <tr> <td>VM1059A1</td> <td>HEAT SHRINK FILM H800</td> <td>1.350</td> <td>M</td> </tr> <tr> <td>VM1695A0</td> <td>HANDLE POSITION PIN</td> <td>2</td> <td>PZ</td> </tr> <tr> <td>VM1916A0</td> <td>RIGHT UPPER COLUMN CAP</td> <td>1</td> <td>PZ</td> </tr> <tr> <td>VM1917A0</td> <td>LEFT UPPER COLUMN CAP</td> <td>1</td> <td>PZ</td> </tr> <tr> <td>VM1918A0</td> <td>RIGHT LOWER COLUMN CAP</td> <td>1</td> <td>PZ</td> </tr> <tr> <td>VM1919A0</td> <td>LEFT LOWER COLUMN CAP</td> <td>1</td> <td>PZ</td> </tr> <tr> <td>VM1920A0</td> <td>INTERNAL GLASS CLOSING RIGHT PLATE</td> <td>1</td> <td>PZ</td> </tr> <tr> <td>VM1921A0</td> <td>INTERNAL GLASS CLOSING LEFT PLATE</td> <td>1</td> <td>PZ</td> </tr> </tbody> </table>	Code	Description	Qty	UOM	IP1385A1	CORNER POLYSTYREN E PACKING 110X80X2000	0.800	M	IP1508A1	POLYSTYREN E U SHAPED PROFILE 2000X60X60	1.710	M	RC1200A0	ED=4 WIRE D.=0.5 COMPRESSIO N SPRING	2	PZ	SL1050A1	3M TRANSFER ADHESIVE TAPE	0.660	M	TB2306A0	LMISS STEFANIA/ELE NA DOOR RIGHT COLUM	1	PZ	TB3080A0	LMISS STEFANIA/ELE NA DOOR LEFT COLUMN	1	PZ	VM1025A0	Ø16 GREY NYLON LID	2	PZ	VM1059A1	HEAT SHRINK FILM H800	1.350	M	VM1695A0	HANDLE POSITION PIN	2	PZ	VM1916A0	RIGHT UPPER COLUMN CAP	1	PZ	VM1917A0	LEFT UPPER COLUMN CAP	1	PZ	VM1918A0	RIGHT LOWER COLUMN CAP	1	PZ	VM1919A0	LEFT LOWER COLUMN CAP	1	PZ	VM1920A0	INTERNAL GLASS CLOSING RIGHT PLATE	1	PZ	VM1921A0	INTERNAL GLASS CLOSING LEFT PLATE	1	PZ
Code	Description	Qty	UOM																																																																		
IP1385A1	CORNER POLYSTYREN E PACKING 110X80X2000	0.800	M																																																																		
IP1508A1	POLYSTYREN E U SHAPED PROFILE 2000X60X60	1.710	M																																																																		
RC1200A0	ED=4 WIRE D.=0.5 COMPRESSIO N SPRING	2	PZ																																																																		
SL1050A1	3M TRANSFER ADHESIVE TAPE	0.660	M																																																																		
TB2306A0	LMISS STEFANIA/ELE NA DOOR RIGHT COLUM	1	PZ																																																																		
TB3080A0	LMISS STEFANIA/ELE NA DOOR LEFT COLUMN	1	PZ																																																																		
VM1025A0	Ø16 GREY NYLON LID	2	PZ																																																																		
VM1059A1	HEAT SHRINK FILM H800	1.350	M																																																																		
VM1695A0	HANDLE POSITION PIN	2	PZ																																																																		
VM1916A0	RIGHT UPPER COLUMN CAP	1	PZ																																																																		
VM1917A0	LEFT UPPER COLUMN CAP	1	PZ																																																																		
VM1918A0	RIGHT LOWER COLUMN CAP	1	PZ																																																																		
VM1919A0	LEFT LOWER COLUMN CAP	1	PZ																																																																		
VM1920A0	INTERNAL GLASS CLOSING RIGHT PLATE	1	PZ																																																																		
VM1921A0	INTERNAL GLASS CLOSING LEFT PLATE	1	PZ																																																																		

COMPONENT			SPARE PART																																		
Code	Description	Image	Code	Description	Components list																																
VT1067A	LINEMISS ELENA BLACK EXTERNAL DOOR GLASS		KVT1067A	L.M. ELENA BLACK EXTERNAL GLASS KIT	<table border="1"> <thead> <tr> <th>Code</th> <th>Description</th> <th>Qty</th> <th>UOM</th> </tr> </thead> <tbody> <tr> <td>VT1067A0</td> <td>LINEMISS ELENA BLACK EXTERNAL DOOR GLASS</td> <td>1</td> <td>PZ</td> </tr> </tbody> </table>	Code	Description	Qty	UOM	VT1067A0	LINEMISS ELENA BLACK EXTERNAL DOOR GLASS	1	PZ																								
					Code	Description	Qty	UOM																													
VT1067A0	LINEMISS ELENA BLACK EXTERNAL DOOR GLASS	1	PZ																																		
<table border="1"> <thead> <tr> <th>Code</th> <th>Description</th> <th>Qty</th> <th>UOM</th> </tr> </thead> <tbody> <tr> <td>VT1067A0</td> <td>LINEMISS ELENA BLACK EXTERNAL DOOR GLASS</td> <td>1</td> <td>PZ</td> </tr> </tbody> </table>	Code	Description	Qty	UOM	VT1067A0	LINEMISS ELENA BLACK EXTERNAL DOOR GLASS	1	PZ																													
Code	Description	Qty	UOM																																		
VT1067A0	LINEMISS ELENA BLACK EXTERNAL DOOR GLASS	1	PZ																																		
VT1065B	LMISS ELENA INNER GLASS 715X335X6		KVT1065B	LM ELENA INTERNAL GLASS KI	<table border="1"> <thead> <tr> <th>Code</th> <th>Description</th> <th>Qty</th> <th>UOM</th> </tr> </thead> <tbody> <tr> <td>ED1011A0</td> <td>GLASS LABEL</td> <td>1</td> <td>PZ</td> </tr> <tr> <td>ED1235A0</td> <td>INTERNAL GLASS LABEL</td> <td>1</td> <td>PZ</td> </tr> <tr> <td>GN1265A0</td> <td>INTERNAL GLASS SEAL</td> <td>4</td> <td>PZ</td> </tr> <tr> <td>IP1508A1</td> <td>POLYSTYREN E U SHAPED PROFILE 2000X60X60</td> <td>2.080</td> <td>M</td> </tr> <tr> <td>VM1059A1</td> <td>HEAT SHRINK FILM H800</td> <td>1.500</td> <td>M</td> </tr> <tr> <td>VT1065B0</td> <td>LMISS ELENA INNER GLASS 715X335X6</td> <td>1</td> <td>PZ</td> </tr> <tr> <td>VT1065B0</td> <td>LMISS ELENA INNER GLASS 715X335X6</td> <td>1</td> <td>PZ</td> </tr> </tbody> </table>	Code	Description	Qty	UOM	ED1011A0	GLASS LABEL	1	PZ	ED1235A0	INTERNAL GLASS LABEL	1	PZ	GN1265A0	INTERNAL GLASS SEAL	4	PZ	IP1508A1	POLYSTYREN E U SHAPED PROFILE 2000X60X60	2.080	M	VM1059A1	HEAT SHRINK FILM H800	1.500	M	VT1065B0	LMISS ELENA INNER GLASS 715X335X6	1	PZ	VT1065B0	LMISS ELENA INNER GLASS 715X335X6	1	PZ
					Code	Description	Qty	UOM																													
					ED1011A0	GLASS LABEL	1	PZ																													
					ED1235A0	INTERNAL GLASS LABEL	1	PZ																													
					GN1265A0	INTERNAL GLASS SEAL	4	PZ																													
					IP1508A1	POLYSTYREN E U SHAPED PROFILE 2000X60X60	2.080	M																													
					VM1059A1	HEAT SHRINK FILM H800	1.500	M																													
					VT1065B0	LMISS ELENA INNER GLASS 715X335X6	1	PZ																													
VT1065B0	LMISS ELENA INNER GLASS 715X335X6	1	PZ																																		
<table border="1"> <thead> <tr> <th>Code</th> <th>Description</th> <th>Qty</th> <th>UOM</th> </tr> </thead> <tbody> <tr> <td>CR1020B0</td> <td>LINEMISS ELENA DOOR HINGE</td> <td>2</td> <td>PZ</td> </tr> <tr> <td>VI1875A0</td> <td>SCREW M5X10 TC1/2T INOX</td> <td>6</td> <td>PZ</td> </tr> </tbody> </table>	Code	Description	Qty	UOM	CR1020B0	LINEMISS ELENA DOOR HINGE	2	PZ	VI1875A0	SCREW M5X10 TC1/2T INOX	6	PZ																									
Code	Description	Qty	UOM																																		
CR1020B0	LINEMISS ELENA DOOR HINGE	2	PZ																																		
VI1875A0	SCREW M5X10 TC1/2T INOX	6	PZ																																		
LP1036A	LINEMISS L=100 LED BAR		KLP1036A	LMISS L200 LED BAR KIT	<table border="1"> <thead> <tr> <th>Code</th> <th>Description</th> <th>Qty</th> <th>UOM</th> </tr> </thead> <tbody> <tr> <td>IP1385A1</td> <td>CORNER POLYSTYREN E PACKING 110X80X2000</td> <td>0.700</td> <td>M</td> </tr> <tr> <td>LP1036A2</td> <td>L200 E200 LM LUX COMPLETE LED BAR</td> <td>1</td> <td>PZ</td> </tr> <tr> <td>VM1059A1</td> <td>HEAT SHRINK FILM H800</td> <td>0.700</td> <td>M</td> </tr> </tbody> </table>	Code	Description	Qty	UOM	IP1385A1	CORNER POLYSTYREN E PACKING 110X80X2000	0.700	M	LP1036A2	L200 E200 LM LUX COMPLETE LED BAR	1	PZ	VM1059A1	HEAT SHRINK FILM H800	0.700	M																
					Code	Description	Qty	UOM																													
					IP1385A1	CORNER POLYSTYREN E PACKING 110X80X2000	0.700	M																													
LP1036A2	L200 E200 LM LUX COMPLETE LED BAR	1	PZ																																		
VM1059A1	HEAT SHRINK FILM H800	0.700	M																																		



ASM2016D/0.D02 - External cover

FRONT

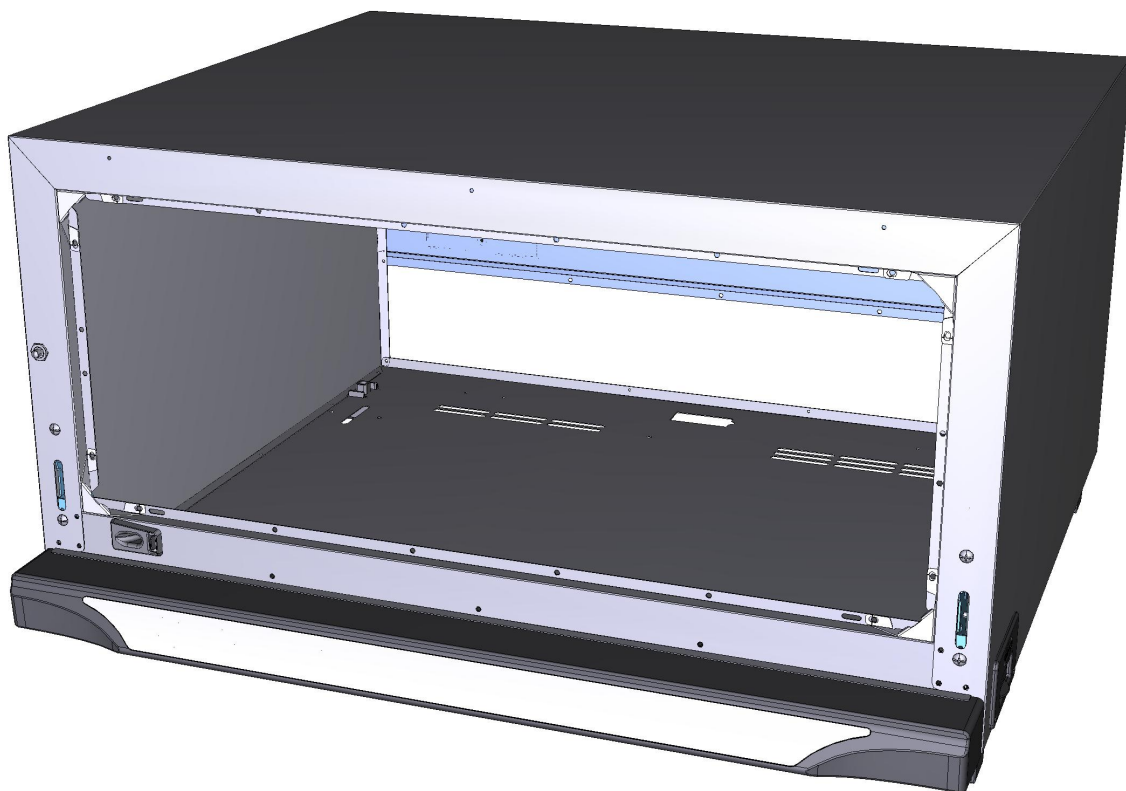







ASM2016D/0.D02 - External cover

REAR



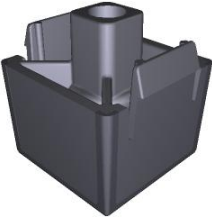









COMPONENT			SPARE PART																		
Code	Description	Image	Code	Description	Components list																
VM1951A	IP CHIMNEY COVER		KVM1951A	EXHAUST CHIMNEY COVER KIT	<table border="1"> <thead> <tr> <th>Code</th> <th>Description</th> <th>Qty</th> <th>UOM</th> </tr> </thead> <tbody> <tr> <td>VI1220A1</td> <td>4,2X12 TCB SELF-TAPPIN G SCREW</td> <td>2</td> <td>PZ</td> </tr> <tr> <td>VM1951A1</td> <td>CHIMNEY COVER</td> <td>1</td> <td>PZ</td> </tr> </tbody> </table>	Code	Description	Qty	UOM	VI1220A1	4,2X12 TCB SELF-TAPPIN G SCREW	2	PZ	VM1951A1	CHIMNEY COVER	1	PZ				
Code	Description	Qty	UOM																		
VI1220A1	4,2X12 TCB SELF-TAPPIN G SCREW	2	PZ																		
VM1951A1	CHIMNEY COVER	1	PZ																		
OH1450A	XB-XV-XG ST. STEEL MUFFLE FRONT CORNER		OH1450A0	XB-XV-XG ST. STEEL MUFFLE FRONT CORNER																	
PD1001A	35X35 H26 GREY PLASTIC+RUBBER FOOT		KPD1001A	35X35 H26 FEET 4PCS KIT	<table border="1"> <thead> <tr> <th>Code</th> <th>Description</th> <th>Qty</th> <th>UOM</th> </tr> </thead> <tbody> <tr> <td>PD1001A0</td> <td>35X35 H26 GREY PLASTIC+RUBBER FOOT</td> <td>4</td> <td>PZ</td> </tr> </tbody> </table>	Code	Description	Qty	UOM	PD1001A0	35X35 H26 GREY PLASTIC+RUBBER FOOT	4	PZ								
Code	Description	Qty	UOM																		
PD1001A0	35X35 H26 GREY PLASTIC+RUBBER FOOT	4	PZ																		
PE2012A	LINE MISS RJ45 UNOXLINK CONNECTING POIN		KPE2012A	LINEMISS RJ45 UNOX.LINK KIT	<table border="1"> <thead> <tr> <th>Code</th> <th>Description</th> <th>Qty</th> <th>UOM</th> </tr> </thead> <tbody> <tr> <td>PE2012A0</td> <td>LINE MISS RJ45 UNOXLINK CONNECTING POINT</td> <td>1</td> <td>PZ</td> </tr> <tr> <td>VI1960A0</td> <td>SELF-TAPPIN G SCREW 4.2X11 TCBS+ AISI410</td> <td>4</td> <td>PZ</td> </tr> <tr> <td>VI1960A1</td> <td></td> <td>4</td> <td>PZ</td> </tr> </tbody> </table>	Code	Description	Qty	UOM	PE2012A0	LINE MISS RJ45 UNOXLINK CONNECTING POINT	1	PZ	VI1960A0	SELF-TAPPIN G SCREW 4.2X11 TCBS+ AISI410	4	PZ	VI1960A1		4	PZ
Code	Description	Qty	UOM																		
PE2012A0	LINE MISS RJ45 UNOXLINK CONNECTING POINT	1	PZ																		
VI1960A0	SELF-TAPPIN G SCREW 4.2X11 TCBS+ AISI410	4	PZ																		
VI1960A1		4	PZ																		
CE1012A	L= 1MT RJ45 CABLE		KVM2190A	LM600 HAUBIS COMPLETE CONTROL BOARD KIT	<table border="1"> <thead> <tr> <th>Code</th> <th>Description</th> <th>Qty</th> <th>UOM</th> </tr> </thead> <tbody> <tr> <td>VM1794A0</td> <td>250X4.8 PA66 BLACK CLAMP</td> <td>2</td> <td>PZ</td> </tr> <tr> <td>VM2103A0</td> <td>CLAMP LOCK</td> <td>2</td> <td>PZ</td> </tr> <tr> <td>VM2190A0</td> <td>LINEMISS HAUBIS 46X33 COMPLETE CONTROL</td> <td>1</td> <td>PZ</td> </tr> </tbody> </table>	Code	Description	Qty	UOM	VM1794A0	250X4.8 PA66 BLACK CLAMP	2	PZ	VM2103A0	CLAMP LOCK	2	PZ	VM2190A0	LINEMISS HAUBIS 46X33 COMPLETE CONTROL	1	PZ
Code	Description	Qty	UOM																		
VM1794A0	250X4.8 PA66 BLACK CLAMP	2	PZ																		
VM2103A0	CLAMP LOCK	2	PZ																		
VM2190A0	LINEMISS HAUBIS 46X33 COMPLETE CONTROL	1	PZ																		





COMPONENT			SPARE PART																																		
Code	Description	Image	Code	Description	Components list																																
CE1012A	L= 1MT RJ45 CABLE		KVM2186A	LMISS 46X33 MATIC-TOP CONTROL BOARD KIT	<table border="1"> <thead> <tr> <th>Code</th> <th>Description</th> <th>Qty</th> <th>UOM</th> </tr> </thead> <tbody> <tr> <td>CE1012A0</td> <td>L= 1MT RJ45 CABLE</td> <td>1</td> <td>PZ</td> </tr> <tr> <td>MS1014A0</td> <td>L.MISS TOUCH MATIC CONTROL BOARD STICKER</td> <td>1</td> <td>PZ</td> </tr> <tr> <td>PE1980B0</td> <td>LINE MISS TOUCH CONTROL BOARD</td> <td>1</td> <td>PZ</td> </tr> <tr> <td>VI1635A0</td> <td>M4X8 ZINC PLATED FLAT HEAD SCREW</td> <td>5</td> <td>PZ</td> </tr> <tr> <td>VM1794A0</td> <td>250X4.8 PA66 BLACK CLAMP</td> <td>2</td> <td>PZ</td> </tr> <tr> <td>VM2016A0</td> <td>L.MISS TOUCH 46X33 DYNAMIC CONTROL BOARD</td> <td>1</td> <td>PZ</td> </tr> <tr> <td>VM2103A0</td> <td>CLAMP LOCK</td> <td>2</td> <td>PZ</td> </tr> </tbody> </table>	Code	Description	Qty	UOM	CE1012A0	L= 1MT RJ45 CABLE	1	PZ	MS1014A0	L.MISS TOUCH MATIC CONTROL BOARD STICKER	1	PZ	PE1980B0	LINE MISS TOUCH CONTROL BOARD	1	PZ	VI1635A0	M4X8 ZINC PLATED FLAT HEAD SCREW	5	PZ	VM1794A0	250X4.8 PA66 BLACK CLAMP	2	PZ	VM2016A0	L.MISS TOUCH 46X33 DYNAMIC CONTROL BOARD	1	PZ	VM2103A0	CLAMP LOCK	2	PZ
			Code	Description	Qty	UOM																															
			CE1012A0	L= 1MT RJ45 CABLE	1	PZ																															
MS1014A0	L.MISS TOUCH MATIC CONTROL BOARD STICKER	1	PZ																																		
PE1980B0	LINE MISS TOUCH CONTROL BOARD	1	PZ																																		
VI1635A0	M4X8 ZINC PLATED FLAT HEAD SCREW	5	PZ																																		
VM1794A0	250X4.8 PA66 BLACK CLAMP	2	PZ																																		
VM2016A0	L.MISS TOUCH 46X33 DYNAMIC CONTROL BOARD	1	PZ																																		
VM2103A0	CLAMP LOCK	2	PZ																																		
KVM2185A	LMISS 46X33 DYNAMIC CONTROL BOARD KIT	<table border="1"> <thead> <tr> <th>Code</th> <th>Description</th> <th>Qty</th> <th>UOM</th> </tr> </thead> <tbody> <tr> <td>CE1012A0</td> <td>L= 1MT RJ45 CABLE</td> <td>1</td> <td>PZ</td> </tr> <tr> <td>MS1012A0</td> <td>L.MISS TOUCH DYN. CONTROL BOARD STICKER</td> <td>1</td> <td>PZ</td> </tr> <tr> <td>PE1980B0</td> <td>LINE MISS TOUCH CONTROL BOARD</td> <td>1</td> <td>PZ</td> </tr> <tr> <td>VI1635A0</td> <td>M4X8 ZINC PLATED FLAT HEAD SCREW</td> <td>5</td> <td>PZ</td> </tr> <tr> <td>VM1794A0</td> <td>250X4.8 PA66 BLACK CLAMP</td> <td>2</td> <td>PZ</td> </tr> <tr> <td>VM2016A0</td> <td>L.MISS TOUCH 46X33 DYNAMIC CONTROL BOARD</td> <td>1</td> <td>PZ</td> </tr> <tr> <td>VM2103A0</td> <td>CLAMP LOCK</td> <td>2</td> <td>PZ</td> </tr> </tbody> </table>	Code	Description	Qty	UOM	CE1012A0	L= 1MT RJ45 CABLE	1	PZ	MS1012A0	L.MISS TOUCH DYN. CONTROL BOARD STICKER	1	PZ	PE1980B0	LINE MISS TOUCH CONTROL BOARD	1	PZ	VI1635A0	M4X8 ZINC PLATED FLAT HEAD SCREW	5	PZ	VM1794A0	250X4.8 PA66 BLACK CLAMP	2	PZ	VM2016A0	L.MISS TOUCH 46X33 DYNAMIC CONTROL BOARD	1	PZ	VM2103A0	CLAMP LOCK	2	PZ			
Code	Description	Qty	UOM																																		
CE1012A0	L= 1MT RJ45 CABLE	1	PZ																																		
MS1012A0	L.MISS TOUCH DYN. CONTROL BOARD STICKER	1	PZ																																		
PE1980B0	LINE MISS TOUCH CONTROL BOARD	1	PZ																																		
VI1635A0	M4X8 ZINC PLATED FLAT HEAD SCREW	5	PZ																																		
VM1794A0	250X4.8 PA66 BLACK CLAMP	2	PZ																																		
VM2016A0	L.MISS TOUCH 46X33 DYNAMIC CONTROL BOARD	1	PZ																																		
VM2103A0	CLAMP LOCK	2	PZ																																		
KVM2184A	LINEMISS 46X33 CLASSIC CONTROL BOARD KIT	<table border="1"> <thead> <tr> <th>Code</th> <th>Description</th> <th>Qty</th> <th>UOM</th> </tr> </thead> <tbody> <tr> <td>CE1012A0</td> <td>L= 1MT RJ45 CABLE</td> <td>1</td> <td>PZ</td> </tr> <tr> <td>MS1016A0</td> <td>L.M. TOUCH CLASSIC CONTROL BOARD STICKER</td> <td>1</td> <td>PZ</td> </tr> </tbody> </table>	Code	Description	Qty	UOM	CE1012A0	L= 1MT RJ45 CABLE	1	PZ	MS1016A0	L.M. TOUCH CLASSIC CONTROL BOARD STICKER	1	PZ																							
Code	Description	Qty	UOM																																		
CE1012A0	L= 1MT RJ45 CABLE	1	PZ																																		
MS1016A0	L.M. TOUCH CLASSIC CONTROL BOARD STICKER	1	PZ																																		

COMPONENT			SPARE PART																										
Code	Description	Image	Code	Description	Components list																								
CE1012A	L= 1MT RJ45 CABLE		KVM2184A	LINEMISS 46X33 CLASSIC CONTROL BOARD KIT	<table border="1"> <thead> <tr> <th>Code</th> <th>Description</th> <th>Qty</th> <th>UOM</th> </tr> </thead> <tbody> <tr> <td>PE1980B0</td> <td>LINE MISS TOUCH CONTROL BOARD</td> <td>1</td> <td>PZ</td> </tr> <tr> <td>V11635A0</td> <td>M4X8 ZINC PLATED FLAT HEAD SCREW</td> <td>5</td> <td>PZ</td> </tr> <tr> <td>VM1794A0</td> <td>250X4.8 PA66 BLACK CLAMP</td> <td>2</td> <td>PZ</td> </tr> <tr> <td>VM2016A0</td> <td>L.MISS TOUCH 46X33 DYNAMIC CONTROL BOARD</td> <td>1</td> <td>PZ</td> </tr> <tr> <td>VM2103A0</td> <td>CLAMP LOCK</td> <td>2</td> <td>PZ</td> </tr> </tbody> </table>	Code	Description	Qty	UOM	PE1980B0	LINE MISS TOUCH CONTROL BOARD	1	PZ	V11635A0	M4X8 ZINC PLATED FLAT HEAD SCREW	5	PZ	VM1794A0	250X4.8 PA66 BLACK CLAMP	2	PZ	VM2016A0	L.MISS TOUCH 46X33 DYNAMIC CONTROL BOARD	1	PZ	VM2103A0	CLAMP LOCK	2	PZ
			Code	Description	Qty	UOM																							
PE1980B0	LINE MISS TOUCH CONTROL BOARD	1	PZ																										
V11635A0	M4X8 ZINC PLATED FLAT HEAD SCREW	5	PZ																										
VM1794A0	250X4.8 PA66 BLACK CLAMP	2	PZ																										
VM2016A0	L.MISS TOUCH 46X33 DYNAMIC CONTROL BOARD	1	PZ																										
VM2103A0	CLAMP LOCK	2	PZ																										
KCE1012A	RJ45 CONTROL-POWER CONNECTING	<table border="1"> <thead> <tr> <th>Code</th> <th>Description</th> <th>Qty</th> <th>UOM</th> </tr> </thead> <tbody> <tr> <td>CE1012A0</td> <td>L= 1MT RJ45 CABLE</td> <td>1</td> <td>PZ</td> </tr> </tbody> </table>	Code	Description	Qty	UOM	CE1012A0	L= 1MT RJ45 CABLE	1	PZ																			
Code	Description	Qty	UOM																										
CE1012A0	L= 1MT RJ45 CABLE	1	PZ																										
0E1081D	LM 800 EXTERNAL BOTTOM PANEL		0E1081D0	CABLE KIT LM 800 EXTERNAL BOTTOM PANEL																									
CR1000A	HINGE LATCH L.M.		KCR1000A	LM HINGES LATCH KIT	<table border="1"> <thead> <tr> <th>Code</th> <th>Description</th> <th>Qty</th> <th>UOM</th> </tr> </thead> <tbody> <tr> <td>CR1000A0</td> <td>HINGE LATCH L.M.</td> <td>1</td> <td>PZ</td> </tr> <tr> <td>V11875A0</td> <td>SCREW M5X10 TC1/2T INOX</td> <td>2</td> <td>PZ</td> </tr> </tbody> </table>	Code	Description	Qty	UOM	CR1000A0	HINGE LATCH L.M.	1	PZ	V11875A0	SCREW M5X10 TC1/2T INOX	2	PZ												
					Code	Description	Qty	UOM																					
CR1000A0	HINGE LATCH L.M.	1	PZ																										
V11875A0	SCREW M5X10 TC1/2T INOX	2	PZ																										
VE1295A	MK 16A 230V DOOR MICROSWITCH		KVE1295A	16A 230V DOOR MICROSWITCH KIT	<table border="1"> <thead> <tr> <th>Code</th> <th>Description</th> <th>Qty</th> <th>UOM</th> </tr> </thead> <tbody> <tr> <td>VE1295A0</td> <td>MK 16A 230V DOOR MICROSWITC</td> <td>1</td> <td>PZ</td> </tr> </tbody> </table>	Code	Description	Qty	UOM	VE1295A0	MK 16A 230V DOOR MICROSWITC	1	PZ																
Code	Description	Qty	UOM																										
VE1295A0	MK 16A 230V DOOR MICROSWITC	1	PZ																										



COMPONENT			SPARE PART										
Code	Description	Image	Code	Description	Components list								
0D1280F	L.MISS ELENA EXTERNAL CASING		0D1280F0	L.MISS ELENA EXTERNAL CASING									
0F1090D	LM ELENA EXTERNAL BACK PANEL		0F1090D0	LM ELENA EXTERNAL BACK PANEL									
VM1225A	PLATE WITH HOLES FOR ELECTRONIC		VM1225A1	PLATE WITH HOLES FOR ELECTRONIC									
0D1300C	LM 800 FRONT LOWER PROFILE		0D1300C0	LM 800 FRONT LOWER PROFILE									
VM1556A	XBC-XVC COOLING FAN GUARD		KVM1556A	XBC-XVC COOLING FAN GUARD KIT	<table border="1"> <thead> <tr> <th>Code</th> <th>Description</th> <th>Qty</th> <th>UOM</th> </tr> </thead> <tbody> <tr> <td>VM1556A0</td> <td>XBC-XVC COOLING FAN GUARD</td> <td>1</td> <td>PZ</td> </tr> </tbody> </table>	Code	Description	Qty	UOM	VM1556A0	XBC-XVC COOLING FAN GUARD	1	PZ
Code	Description	Qty	UOM										
VM1556A0	XBC-XVC COOLING FAN GUARD	1	PZ										

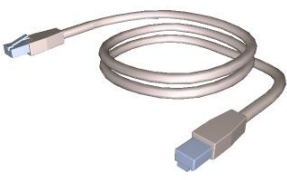

COMPONENT			SPARE PART																		
Code	Description	Image	Code	Description	Components list																
VN1175A	230V 50/60HZ 120X120 COOLING DOWN FAN		KVN1175A	120X120 230V 50/60HZ COOLING FAN KIT	<table border="1"> <thead> <tr> <th>Code</th> <th>Description</th> <th>Qty</th> <th>UOM</th> </tr> </thead> <tbody> <tr> <td>VN1175A0</td> <td>230V 50/60HZ 120X120 COOLING DOWN FAN</td> <td>1</td> <td>PZ</td> </tr> <tr> <td>VN1175A0</td> <td>230V 50/60HZ 120X120 COOLING DOWN FAN</td> <td>1</td> <td>PZ</td> </tr> </tbody> </table>	Code	Description	Qty	UOM	VN1175A0	230V 50/60HZ 120X120 COOLING DOWN FAN	1	PZ	VN1175A0	230V 50/60HZ 120X120 COOLING DOWN FAN	1	PZ				
Code	Description	Qty	UOM																		
VN1175A0	230V 50/60HZ 120X120 COOLING DOWN FAN	1	PZ																		
VN1175A0	230V 50/60HZ 120X120 COOLING DOWN FAN	1	PZ																		
VM2188B	LMISSTOUCH60X40 DYNAMIC COMPLETE CONTROL		KVM2188B	LM800 DYNAMIC COMPLETE CONTROL BOARD KIT	<table border="1"> <thead> <tr> <th>Code</th> <th>Description</th> <th>Qty</th> <th>UOM</th> </tr> </thead> <tbody> <tr> <td>VM1794A0</td> <td>250X4.8 PA66 BLACK CLAMP</td> <td>2</td> <td>PZ</td> </tr> <tr> <td>VM2103A0</td> <td>GLAMP LOCK</td> <td>2</td> <td>PZ</td> </tr> <tr> <td>VM2188B1</td> <td>LM800 DYNAMIC COMPLETE CONTROL BOARD</td> <td>1</td> <td>PZ</td> </tr> </tbody> </table>	Code	Description	Qty	UOM	VM1794A0	250X4.8 PA66 BLACK CLAMP	2	PZ	VM2103A0	GLAMP LOCK	2	PZ	VM2188B1	LM800 DYNAMIC COMPLETE CONTROL BOARD	1	PZ
Code	Description	Qty	UOM																		
VM1794A0	250X4.8 PA66 BLACK CLAMP	2	PZ																		
VM2103A0	GLAMP LOCK	2	PZ																		
VM2188B1	LM800 DYNAMIC COMPLETE CONTROL BOARD	1	PZ																		
CE1305A	L=2MT RJ45 - RJ45 CABLE		KCE1305A	RJ45 - RJ45 L=2MT CABLE KIT	<table border="1"> <thead> <tr> <th>Code</th> <th>Description</th> <th>Qty</th> <th>UOM</th> </tr> </thead> <tbody> <tr> <td>CE1305A0</td> <td>L=2MT RJ45 - RJ45 CABLE</td> <td>1</td> <td>PZ</td> </tr> </tbody> </table>	Code	Description	Qty	UOM	CE1305A0	L=2MT RJ45 - RJ45 CABLE	1	PZ								
Code	Description	Qty	UOM																		
CE1305A0	L=2MT RJ45 - RJ45 CABLE	1	PZ																		

ASM2017C/0.D00 - Cooking chamber

FRONT

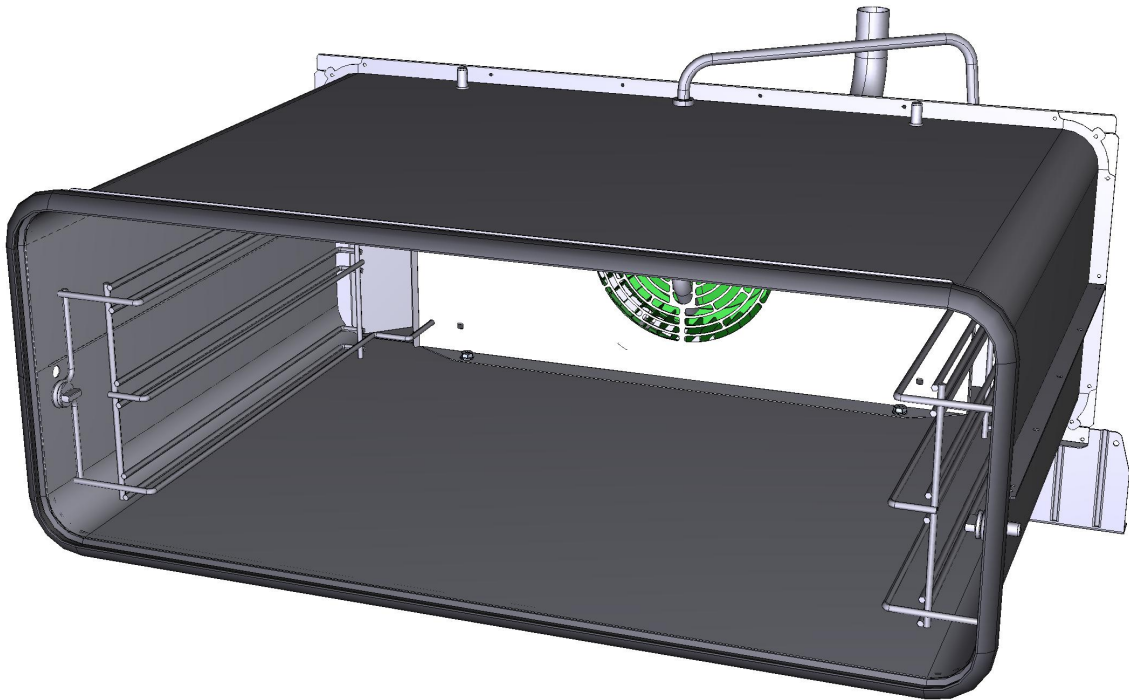







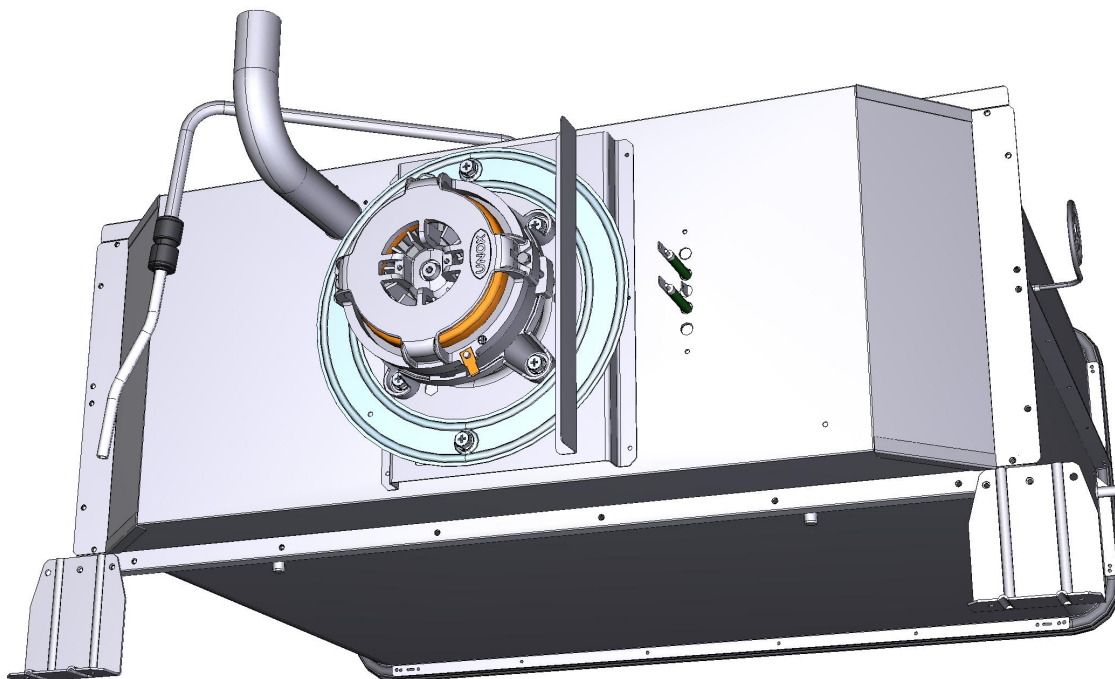



ASM2017C/0.D00 - Cooking chamber

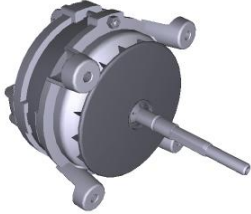

REAR



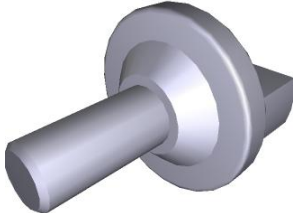



COMPONENT			SPARE PART																										
Code	Description	Image	Code	Description	Components list																								
0H3586A	ZINCED MOTOR GUARD PLATE XBC-XVC		0H3586A0	ZINCED MOTOR GUARD PLATE XBC-XVC																									
VN1025A	D=196 H=61 38 BLADES ST. STEEL FAN		KVN1025A	S.3/4/MISS/MICRO D196 H61 FAN KIT	<table border="1"> <thead> <tr> <th>Code</th> <th>Description</th> <th>Qty</th> <th>UOM</th> </tr> </thead> <tbody> <tr> <td>V11045A0</td> <td>16X8,4 TH=1,6 ST.STEEL WASHER</td> <td>1</td> <td>PZ</td> </tr> <tr> <td>V11256A0</td> <td>M8 DIN 980M ST. STEEL SELF LOCKING NUT</td> <td>1</td> <td>PZ</td> </tr> <tr> <td>VM2196A0</td> <td>MOTOR NUT FIXING BUSHING</td> <td>1</td> <td>PZ</td> </tr> <tr> <td>VN1025A2</td> <td>D=196 H=61 38 BLADES ST. STEEL FAN</td> <td>1</td> <td>PZ</td> </tr> <tr> <td>VN1025A2</td> <td>D=196 H=61 38 BLADES ST. STEEL FAN</td> <td>1</td> <td>PZ</td> </tr> </tbody> </table>	Code	Description	Qty	UOM	V11045A0	16X8,4 TH=1,6 ST.STEEL WASHER	1	PZ	V11256A0	M8 DIN 980M ST. STEEL SELF LOCKING NUT	1	PZ	VM2196A0	MOTOR NUT FIXING BUSHING	1	PZ	VN1025A2	D=196 H=61 38 BLADES ST. STEEL FAN	1	PZ	VN1025A2	D=196 H=61 38 BLADES ST. STEEL FAN	1	PZ
Code	Description	Qty	UOM																										
V11045A0	16X8,4 TH=1,6 ST.STEEL WASHER	1	PZ																										
V11256A0	M8 DIN 980M ST. STEEL SELF LOCKING NUT	1	PZ																										
VM2196A0	MOTOR NUT FIXING BUSHING	1	PZ																										
VN1025A2	D=196 H=61 38 BLADES ST. STEEL FAN	1	PZ																										
VN1025A2	D=196 H=61 38 BLADES ST. STEEL FAN	1	PZ																										
0H3020A	MOTOR SHAFT SEALING DISC		0H3020A1	MOTOR SHAFT SEALING DISC																									
0H1209A	PROFILE HEAT COVER FOR MOTOR		0H1209A0	PROFILE HEAT COVER FOR MOTOR																									

COMPONENT			SPARE PART																																										
Code	Description	Image	Code	Description	Components list																																								
GN1547A	SHAFT GASKET D11.6		GN1547A1	SHAFT GASKET D11.8																																									
VN1130A	330W 230V 50/60HZ MOTOR		KVN1130A	330W 230V 50/60HZ MOTOR KIT	<table border="1"> <thead> <tr> <th>Code</th> <th>Description</th> <th>Qty</th> <th>UOM</th> </tr> </thead> <tbody> <tr> <td>0H4305A1</td> <td>ST. STEEL MOTOR SHAFT SEALING DISC</td> <td>1</td> <td>PZ</td> </tr> <tr> <td>GN1140A2</td> <td>MOTOR HOLDER GASKET</td> <td>1</td> <td>PZ</td> </tr> <tr> <td>VI1045A0</td> <td>16X8,4 TH=1,6 ST.STEEL WASHER</td> <td>1</td> <td>PZ</td> </tr> <tr> <td>VI1256A0</td> <td>M8 DIN 980M ST. STEEL SELF LOCKING NUT</td> <td>1</td> <td>PZ</td> </tr> <tr> <td>VM1794A0</td> <td>250X4.8 PA66 BLACK CLAMP</td> <td>4</td> <td>PZ</td> </tr> <tr> <td>VM2103A0</td> <td>CLAMP LOCK</td> <td>4</td> <td>PZ</td> </tr> <tr> <td>VM2196A0</td> <td>MOTOR NUT FIXING BUSHING</td> <td>1</td> <td>PZ</td> </tr> <tr> <td>VN1130A1</td> <td>330W 230V 50/60HZ MOTO</td> <td>1</td> <td>PZ</td> </tr> <tr> <td>VN1130A1</td> <td>330W 230V 50/60HZ MOTO</td> <td>1</td> <td>PZ</td> </tr> </tbody> </table>	Code	Description	Qty	UOM	0H4305A1	ST. STEEL MOTOR SHAFT SEALING DISC	1	PZ	GN1140A2	MOTOR HOLDER GASKET	1	PZ	VI1045A0	16X8,4 TH=1,6 ST.STEEL WASHER	1	PZ	VI1256A0	M8 DIN 980M ST. STEEL SELF LOCKING NUT	1	PZ	VM1794A0	250X4.8 PA66 BLACK CLAMP	4	PZ	VM2103A0	CLAMP LOCK	4	PZ	VM2196A0	MOTOR NUT FIXING BUSHING	1	PZ	VN1130A1	330W 230V 50/60HZ MOTO	1	PZ	VN1130A1	330W 230V 50/60HZ MOTO	1	PZ
Code	Description	Qty	UOM																																										
0H4305A1	ST. STEEL MOTOR SHAFT SEALING DISC	1	PZ																																										
GN1140A2	MOTOR HOLDER GASKET	1	PZ																																										
VI1045A0	16X8,4 TH=1,6 ST.STEEL WASHER	1	PZ																																										
VI1256A0	M8 DIN 980M ST. STEEL SELF LOCKING NUT	1	PZ																																										
VM1794A0	250X4.8 PA66 BLACK CLAMP	4	PZ																																										
VM2103A0	CLAMP LOCK	4	PZ																																										
VM2196A0	MOTOR NUT FIXING BUSHING	1	PZ																																										
VN1130A1	330W 230V 50/60HZ MOTO	1	PZ																																										
VN1130A1	330W 230V 50/60HZ MOTO	1	PZ																																										
TB2121A	LINE MISS 800 EXHAUST CHIMNEY Ø30X1		TB2121A0	LINE MISS 800 EXHAUST CHIMNEY Ø30X1																																									

COMPONENT			SPARE PART																														
Code	Description	Image	Code	Description	Components list																												
0H1455A	MUFFLE SUPPORT BRACKET		0H1455A2	MUFFLE SUPPORT BRACKET																													
VM1815A	LATERAL SUPPORTS FIXING BOLT		KVM1815A	MISS/MICRO/S4/S3 THUMB SCREW 10 PCS KIT	<table border="1"> <thead> <tr> <th>Code</th> <th>Description</th> <th>Qty</th> <th>UOM</th> </tr> </thead> <tbody> <tr> <td>VM1815A0</td> <td>LATERAL SUPPORTS FIXING BOLT</td> <td>10</td> <td>PZ</td> </tr> </tbody> </table>	Code	Description	Qty	UOM	VM1815A0	LATERAL SUPPORTS FIXING BOLT	10	PZ																				
Code	Description	Qty	UOM																														
VM1815A0	LATERAL SUPPORTS FIXING BOLT	10	PZ																														
TR1105A	L=1000 PT1000 TEMPERATURE PROBE		KTR1105A	PT100 L1000 TEMPERATURE PROBE KIT	<table border="1"> <thead> <tr> <th>Code</th> <th>Description</th> <th>Qty</th> <th>UOM</th> </tr> </thead> <tbody> <tr> <td>GN1120A0</td> <td>TEMPERATUR E PROBE NTC SEAL</td> <td>1</td> <td>PZ</td> </tr> <tr> <td>GN1120A1</td> <td></td> <td>1</td> <td>PZ</td> </tr> <tr> <td>GN1285A0</td> <td>NTC TEMPERATUR E PROBE SEALING</td> <td>1</td> <td>PZ</td> </tr> <tr> <td>SL1045A0</td> <td>S57 BLACK SILICONE - 80ML CARTRIDGE</td> <td>1</td> <td>PZ</td> </tr> <tr> <td>TR1105A4</td> <td></td> <td>1</td> <td>PZ</td> </tr> <tr> <td>VI1220A1</td> <td>4,2X12 TCB SELF-TAPPIN G SCREW</td> <td>2</td> <td>PZ</td> </tr> </tbody> </table>	Code	Description	Qty	UOM	GN1120A0	TEMPERATUR E PROBE NTC SEAL	1	PZ	GN1120A1		1	PZ	GN1285A0	NTC TEMPERATUR E PROBE SEALING	1	PZ	SL1045A0	S57 BLACK SILICONE - 80ML CARTRIDGE	1	PZ	TR1105A4		1	PZ	VI1220A1	4,2X12 TCB SELF-TAPPIN G SCREW	2	PZ
Code	Description	Qty	UOM																														
GN1120A0	TEMPERATUR E PROBE NTC SEAL	1	PZ																														
GN1120A1		1	PZ																														
GN1285A0	NTC TEMPERATUR E PROBE SEALING	1	PZ																														
SL1045A0	S57 BLACK SILICONE - 80ML CARTRIDGE	1	PZ																														
TR1105A4		1	PZ																														
VI1220A1	4,2X12 TCB SELF-TAPPIN G SCREW	2	PZ																														
0G1120D	L.MISS ELENA FAN GUARD		0G1120D0	L.MISS ELENA FAN GUARD																													

COMPONENT			SPARE PART																														
Code	Description	Image	Code	Description	Components list																												
RS1090A	2,9KW HEATING ELEMENT		KRS1090A	HEATING ELEMENT 2.9KW	<table border="1"> <thead> <tr> <th>Code</th> <th>Description</th> <th>Qty</th> <th>UOM</th> </tr> </thead> <tbody> <tr> <td>GN1327A0</td> <td>HEATING ELEMENT GASKET</td> <td>1</td> <td>PZ</td> </tr> <tr> <td>RS1090A1</td> <td>2,9KW HEATING ELEMENT</td> <td>1</td> <td>PZ</td> </tr> <tr> <td>SL1045A0</td> <td>S57 BLACK SILICONE - 80ML CARTRIDGE</td> <td>1</td> <td>PZ</td> </tr> <tr> <td>VI1220A1</td> <td>4,2X12 TCB SELF-TAPPING SCREW</td> <td>5</td> <td>PZ</td> </tr> <tr> <td>VM1794A0</td> <td>250X4.8 PA66 BLACK CLAMP</td> <td>2</td> <td>PZ</td> </tr> <tr> <td>VM2103A0</td> <td>CLAMP LOCK</td> <td>2</td> <td>PZ</td> </tr> </tbody> </table>	Code	Description	Qty	UOM	GN1327A0	HEATING ELEMENT GASKET	1	PZ	RS1090A1	2,9KW HEATING ELEMENT	1	PZ	SL1045A0	S57 BLACK SILICONE - 80ML CARTRIDGE	1	PZ	VI1220A1	4,2X12 TCB SELF-TAPPING SCREW	5	PZ	VM1794A0	250X4.8 PA66 BLACK CLAMP	2	PZ	VM2103A0	CLAMP LOCK	2	PZ
					Code	Description	Qty	UOM																									
					GN1327A0	HEATING ELEMENT GASKET	1	PZ																									
					RS1090A1	2,9KW HEATING ELEMENT	1	PZ																									
					SL1045A0	S57 BLACK SILICONE - 80ML CARTRIDGE	1	PZ																									
					VI1220A1	4,2X12 TCB SELF-TAPPING SCREW	5	PZ																									
					VM1794A0	250X4.8 PA66 BLACK CLAMP	2	PZ																									
VM2103A0	CLAMP LOCK	2	PZ																														
RC1170A	STAINLESS STEEL NUT M14 H=8 CH=22		KRC1170A	M14 H8 CH22 NUT - 10 PCS. KIT	<table border="1"> <thead> <tr> <th>Code</th> <th>Description</th> <th>Qty</th> <th>UOM</th> </tr> </thead> <tbody> <tr> <td>RC1170A1</td> <td>STAINLESS STEEL NUT M14 H=8 CH=22</td> <td>10</td> <td>PZ</td> </tr> </tbody> </table>	Code	Description	Qty	UOM	RC1170A1	STAINLESS STEEL NUT M14 H=8 CH=22	10	PZ																				
					Code	Description	Qty	UOM																									
RC1170A1	STAINLESS STEEL NUT M14 H=8 CH=22	10	PZ																														
OH1990A	EXTERNAL WATER PIPE + RC1165A0		OH1990A1	EXTERNAL WATER PIPE + RC1165A0																													
EL1055A	Ø10 - Ø8 INT. REDUCTION		KEL1055A	Ø10-Ø8 JG REDUCTION 10 PCS KIT	<table border="1"> <thead> <tr> <th>Code</th> <th>Description</th> <th>Qty</th> <th>UOM</th> </tr> </thead> <tbody> <tr> <td>EL1055A0</td> <td>Ø10 - Ø8 INT. REDUCTION</td> <td>10</td> <td>PZ</td> </tr> </tbody> </table>	Code	Description	Qty	UOM	EL1055A0	Ø10 - Ø8 INT. REDUCTION	10	PZ																				
					Code	Description	Qty	UOM																									
EL1055A0	Ø10 - Ø8 INT. REDUCTION	10	PZ																														

COMPONENT			SPARE PART																		
Code	Description	Image	Code	Description	Components list																
TB2034A	L.MISS WATER SYSTEM - TB1815A		KTB2597A	Ø8 TRANSPARENT WATER PIPE 150 M KIT	<table border="1"> <thead> <tr> <th>Code</th> <th>Description</th> <th>Qty</th> <th>UOM</th> </tr> </thead> <tbody> <tr> <td>TB1815A0</td> <td>7,93X4,75 PE TRANSP. PIPE (JG #PE08100N)</td> <td>150</td> <td>M</td> </tr> <tr> <td>VM1059A1</td> <td>HEAT SHRINK FILM H800</td> <td>1.500</td> <td>M</td> </tr> </tbody> </table>	Code	Description	Qty	UOM	TB1815A0	7,93X4,75 PE TRANSP. PIPE (JG #PE08100N)	150	M	VM1059A1	HEAT SHRINK FILM H800	1.500	M				
			Code	Description	Qty	UOM															
			TB1815A0	7,93X4,75 PE TRANSP. PIPE (JG #PE08100N)	150	M															
VM1059A1	HEAT SHRINK FILM H800	1.500	M																		
KTB2529A	Ø8 TRANSPARENT HUMIDITY PIPE 2 M KIT	<table border="1"> <thead> <tr> <th>Code</th> <th>Description</th> <th>Qty</th> <th>UOM</th> </tr> </thead> <tbody> <tr> <td>TB1815A0</td> <td>7,93X4,75 PE TRANSP. PIPE (JG #PE08100N)</td> <td>2</td> <td>M</td> </tr> </tbody> </table>	Code	Description	Qty	UOM	TB1815A0	7,93X4,75 PE TRANSP. PIPE (JG #PE08100N)	2	M											
Code	Description	Qty	UOM																		
TB1815A0	7,93X4,75 PE TRANSP. PIPE (JG #PE08100N)	2	M																		
KTB1959A	7,93X4,75 PE TRANSPARENT PIPE 5M KIT	<table border="1"> <thead> <tr> <th>Code</th> <th>Description</th> <th>Qty</th> <th>UOM</th> </tr> </thead> <tbody> <tr> <td>TB1815A0</td> <td>7,93X4,75 PE TRANSP. PIPE (JG #PE08100N)</td> <td>5</td> <td>M</td> </tr> </tbody> </table>	Code	Description	Qty	UOM	TB1815A0	7,93X4,75 PE TRANSP. PIPE (JG #PE08100N)	5	M											
Code	Description	Qty	UOM																		
TB1815A0	7,93X4,75 PE TRANSP. PIPE (JG #PE08100N)	5	M																		
TB1059A	ELENA INTERNAL HUMIDITY PIPE 16X		TB1059A0	ELENA INTERNAL HUMIDITY PIPE 16X																	
GRL1015A	L/R CHROMIUM PLATED LAT.SUPPORT		KGRL1015A	R/L 3 600X400 LM ELENA LATERAL SUPP KIT	<table border="1"> <thead> <tr> <th>Code</th> <th>Description</th> <th>Qty</th> <th>UOM</th> </tr> </thead> <tbody> <tr> <td>GRL1015A0</td> <td>L/R CHROMIUM PLATED LAT.SUPPORT</td> <td>2</td> <td>PZ</td> </tr> <tr> <td>IP1508A1</td> <td>POLYSTYREN E U SHAPED PROFILE 2000X60X60</td> <td>1</td> <td>M</td> </tr> <tr> <td>VM1059A1</td> <td>HEAT SHRINK FILM H800</td> <td>1.500</td> <td>M</td> </tr> </tbody> </table>	Code	Description	Qty	UOM	GRL1015A0	L/R CHROMIUM PLATED LAT.SUPPORT	2	PZ	IP1508A1	POLYSTYREN E U SHAPED PROFILE 2000X60X60	1	M	VM1059A1	HEAT SHRINK FILM H800	1.500	M
					Code	Description	Qty	UOM													
					GRL1015A0	L/R CHROMIUM PLATED LAT.SUPPORT	2	PZ													
IP1508A1	POLYSTYREN E U SHAPED PROFILE 2000X60X60	1	M																		
VM1059A1	HEAT SHRINK FILM H800	1.500	M																		
0H2060A	ELENA PLATE FOR CHIMNEY FUMES EXIT		0H2060A1	ELENA PLATE FOR CHIMNEY FUMES EXIT																	



COMPONENT			SPARE PART																		
Code	Description	Image	Code	Description	Components list																
GN1353A	L.MISS ELENA DOOR GASKET - GN1110A		KG1353A	LM ELENA DOOR GASKET KIT	<table border="1"> <thead> <tr> <th>Code</th> <th>Description</th> <th>Qty</th> <th>UOM</th> </tr> </thead> <tbody> <tr> <td>GN1110A2</td> <td>LINE</td> <td>1.780</td> <td>M</td> </tr> <tr> <td></td> <td>MISS/XVC105- 055/XK/XL</td> <td></td> <td></td> </tr> <tr> <td></td> <td>DOOR GASKE</td> <td></td> <td></td> </tr> </tbody> </table>	Code	Description	Qty	UOM	GN1110A2	LINE	1.780	M		MISS/XVC105- 055/XK/XL				DOOR GASKE		
Code	Description	Qty	UOM																		
GN1110A2	LINE	1.780	M																		
	MISS/XVC105- 055/XK/XL																				
	DOOR GASKE																				



ASM2018E/0.D00 - Electrical system

FRONT

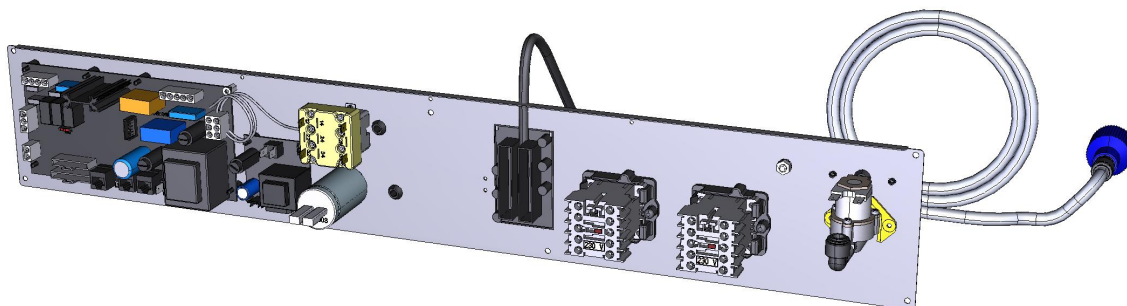

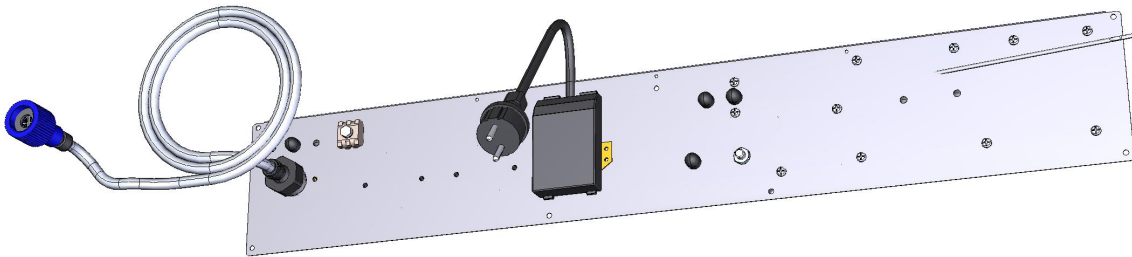

ASM2018E/0.D00 - Electrical system

REAR



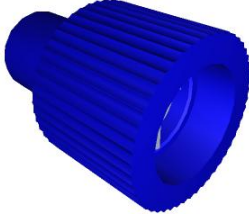

COMPONENT			SPARE PART																		
Code	Description	Image	Code	Description	Components list																
CN1003A	6,3 UF MOTOR CAPACITOR		KCN1003A	6,3 UF MOTOR CAPACITOR KIT	<table border="1"> <thead> <tr> <th>Code</th> <th>Description</th> <th>Qty</th> <th>UOM</th> </tr> </thead> <tbody> <tr> <td>CN1003A0</td> <td>6,3 UF MOTOR CAPACITOR</td> <td>1</td> <td>PZ</td> </tr> <tr> <td>VI1931A0</td> <td>M8 NUT+INDENTE D WASHER D=8 X COND.</td> <td>1</td> <td>PZ</td> </tr> <tr> <td>VI1932A0</td> <td>M8 NUT+INDENTE D WASHER D=8 X COND.</td> <td>1</td> <td>PZ</td> </tr> </tbody> </table>	Code	Description	Qty	UOM	CN1003A0	6,3 UF MOTOR CAPACITOR	1	PZ	VI1931A0	M8 NUT+INDENTE D WASHER D=8 X COND.	1	PZ	VI1932A0	M8 NUT+INDENTE D WASHER D=8 X COND.	1	PZ
					Code	Description	Qty	UOM													
CN1003A0	6,3 UF MOTOR CAPACITOR	1	PZ																		
VI1931A0	M8 NUT+INDENTE D WASHER D=8 X COND.	1	PZ																		
VI1932A0	M8 NUT+INDENTE D WASHER D=8 X COND.	1	PZ																		
VE1115A	20 A 230V 4 POLES MINICONTACTOR		KVE1115A	20A 230V 4 POLES MINICONTACTOR KI	<table border="1"> <thead> <tr> <th>Code</th> <th>Description</th> <th>Qty</th> <th>UOM</th> </tr> </thead> <tbody> <tr> <td>VE1115A0</td> <td>20 A 230V 4 POLES MINICONTACTOR</td> <td>1</td> <td>PZ</td> </tr> <tr> <td>VM1075A1</td> <td>PLASTIC CLIP TO FIX CONTACTORS</td> <td>4</td> <td>PZ</td> </tr> </tbody> </table>	Code	Description	Qty	UOM	VE1115A0	20 A 230V 4 POLES MINICONTACTOR	1	PZ	VM1075A1	PLASTIC CLIP TO FIX CONTACTORS	4	PZ				
Code	Description	Qty	UOM																		
VE1115A0	20 A 230V 4 POLES MINICONTACTOR	1	PZ																		
VM1075A1	PLASTIC CLIP TO FIX CONTACTORS	4	PZ																		
VM1056A	SMALL CONTACTOR BRACKET VE1115A		VM1056A0	SMALL CONTACTOR BRACKET VE1115A																	
VM1750A	BRASS COMB CLAM		KVM1750A	COMB TERMINAL BLOCK KIT	<table border="1"> <thead> <tr> <th>Code</th> <th>Description</th> <th>Qty</th> <th>UOM</th> </tr> </thead> <tbody> <tr> <td>VM1750A0</td> <td>BRASS COMB CLAMP</td> <td>1</td> <td>PZ</td> </tr> </tbody> </table>	Code	Description	Qty	UOM	VM1750A0	BRASS COMB CLAMP	1	PZ								
Code	Description	Qty	UOM																		
VM1750A0	BRASS COMB CLAMP	1	PZ																		
EL1085A	SINGLE WATER SOLENOID VALVE + J.GUEST		KEL1085A	1 WAY SOLENOID VALVE KIT	<table border="1"> <thead> <tr> <th>Code</th> <th>Description</th> <th>Qty</th> <th>UOM</th> </tr> </thead> <tbody> <tr> <td>EL1085A0</td> <td>SINGLE WATER SOLENOID VALVE + J.GUEST</td> <td>1</td> <td>PZ</td> </tr> </tbody> </table>	Code	Description	Qty	UOM	EL1085A0	SINGLE WATER SOLENOID VALVE + J.GUEST	1	PZ								
Code	Description	Qty	UOM																		
EL1085A0	SINGLE WATER SOLENOID VALVE + J.GUEST	1	PZ																		

COMPONENT			SPARE PART																										
Code	Description	Image	Code	Description	Components list																								
TB1079A	L.MISS D8 WATER PIPE		KTB1079A	LINEMISS WATER INLET CONNECTING PIPE KIT	<table border="1"> <thead> <tr> <th>Code</th> <th>Description</th> <th>Qty</th> <th>UOM</th> </tr> </thead> <tbody> <tr> <td>GN1200A1</td> <td>3/4 CONNECTION SEAL D=24 RUBBER+NET</td> <td>1</td> <td>PZ</td> </tr> <tr> <td>RC1002A0</td> <td>JG 10M-8F TERMINAL REDUCTION FITTING</td> <td>1</td> <td>PZ</td> </tr> <tr> <td>RC1030A2</td> <td>Ø8-3/4 FEMALE JG STRAIGHT CONNECTION</td> <td>1</td> <td>PZ</td> </tr> <tr> <td>RC1365A0</td> <td>3/4"-10 JG FEMALE CONNECTION</td> <td>1</td> <td>PZ</td> </tr> <tr> <td>TB1815A0</td> <td>7,93X4,75 PE (JG #PE08100N)</td> <td>1.500</td> <td>M</td> </tr> </tbody> </table>	Code	Description	Qty	UOM	GN1200A1	3/4 CONNECTION SEAL D=24 RUBBER+NET	1	PZ	RC1002A0	JG 10M-8F TERMINAL REDUCTION FITTING	1	PZ	RC1030A2	Ø8-3/4 FEMALE JG STRAIGHT CONNECTION	1	PZ	RC1365A0	3/4"-10 JG FEMALE CONNECTION	1	PZ	TB1815A0	7,93X4,75 PE (JG #PE08100N)	1.500	M
					Code	Description	Qty	UOM																					
					GN1200A1	3/4 CONNECTION SEAL D=24 RUBBER+NET	1	PZ																					
					RC1002A0	JG 10M-8F TERMINAL REDUCTION FITTING	1	PZ																					
					RC1030A2	Ø8-3/4 FEMALE JG STRAIGHT CONNECTION	1	PZ																					
RC1365A0	3/4"-10 JG FEMALE CONNECTION	1	PZ																										
TB1815A0	7,93X4,75 PE (JG #PE08100N)	1.500	M																										
RC1030A	Ø8-3/4 FEMALE JG STRAIGHT CONNECTION		KRC1030A	LMISS Ø8-3/4 STRAIGHT FITTING 5PCS KIT	<table border="1"> <thead> <tr> <th>Code</th> <th>Description</th> <th>Qty</th> <th>UOM</th> </tr> </thead> <tbody> <tr> <td>RC1030A2</td> <td>Ø8-3/4 FEMALE JG STRAIGHT CONNECTION</td> <td>5</td> <td>PZ</td> </tr> </tbody> </table>	Code	Description	Qty	UOM	RC1030A2	Ø8-3/4 FEMALE JG STRAIGHT CONNECTION	5	PZ																
Code	Description	Qty	UOM																										
RC1030A2	Ø8-3/4 FEMALE JG STRAIGHT CONNECTION	5	PZ																										
RC1002A	JG 10M-8F TERMINAL REDUCTION FITTIN		KRC1002A	G Ø10M-Ø8F REDUCING SPIGOT 10 PCS KIT	<table border="1"> <thead> <tr> <th>Code</th> <th>Description</th> <th>Qty</th> <th>UOM</th> </tr> </thead> <tbody> <tr> <td>RC1002A0</td> <td>JG 10M-8F TERMINAL REDUCTION FITTING</td> <td>10</td> <td>PZ</td> </tr> </tbody> </table>	Code	Description	Qty	UOM	RC1002A0	JG 10M-8F TERMINAL REDUCTION FITTING	10	PZ																
Code	Description	Qty	UOM																										
RC1002A0	JG 10M-8F TERMINAL REDUCTION FITTING	10	PZ																										
RC1365A	3/4"-10 JG FEMALE CONNECTION		KRC1365A	3/4"-10 OR 8 JG WATER CONNECTION KIT	<table border="1"> <thead> <tr> <th>Code</th> <th>Description</th> <th>Qty</th> <th>UOM</th> </tr> </thead> <tbody> <tr> <td>GN1200A1</td> <td>3/4 CONNECTION SEAL D=24 RUBBER+NET</td> <td>1</td> <td>PZ</td> </tr> <tr> <td>RC1002A0</td> <td>JG 10M-8F TERMINAL REDUCTION FITTING</td> <td>1</td> <td>PZ</td> </tr> <tr> <td>RC1365A0</td> <td>3/4"-10 JG FEMALE CONNECTION</td> <td>1</td> <td>PZ</td> </tr> </tbody> </table>	Code	Description	Qty	UOM	GN1200A1	3/4 CONNECTION SEAL D=24 RUBBER+NET	1	PZ	RC1002A0	JG 10M-8F TERMINAL REDUCTION FITTING	1	PZ	RC1365A0	3/4"-10 JG FEMALE CONNECTION	1	PZ								
Code	Description	Qty	UOM																										
GN1200A1	3/4 CONNECTION SEAL D=24 RUBBER+NET	1	PZ																										
RC1002A0	JG 10M-8F TERMINAL REDUCTION FITTING	1	PZ																										
RC1365A0	3/4"-10 JG FEMALE CONNECTION	1	PZ																										

COMPONENT			SPARE PART																						
Code	Description	Image	Code	Description	Components list																				
VM1745A	CARD SUPPORT		KVM1745A	BOARD SUPPORT 10 PCS KIT	<table border="1"> <thead> <tr> <th>Code</th> <th>Description</th> <th>Qty</th> <th>UOM</th> </tr> </thead> <tbody> <tr> <td>VM1745A0</td> <td>CARD SUPPORT</td> <td>10</td> <td>PZ</td> </tr> </tbody> </table>	Code	Description	Qty	UOM	VM1745A0	CARD SUPPORT	10	PZ												
Code	Description	Qty	UOM																						
VM1745A0	CARD SUPPORT	10	PZ																						
PE1983B	LMISS 230V DYNAMIC/CLASSIC POWER CARD		KPE1983B	LM 230V POWER BOARD KIT	<table border="1"> <thead> <tr> <th>Code</th> <th>Description</th> <th>Qty</th> <th>UOM</th> </tr> </thead> <tbody> <tr> <td>PE1983B1</td> <td>LMISS 230V POWER BOARD</td> <td>1</td> <td>PZ</td> </tr> <tr> <td>V11850A0</td> <td>M4X6 NICKEL PLATED FIXING SCRE</td> <td>7</td> <td>PZ</td> </tr> <tr> <td>VM1745A0</td> <td>CARD SUPPORT</td> <td>6</td> <td>PZ</td> </tr> <tr> <td>VM2147A0</td> <td>ESD SPONGE PINK SMOOTH 410X343X15 M</td> <td>1</td> <td>PZ</td> </tr> </tbody> </table>	Code	Description	Qty	UOM	PE1983B1	LMISS 230V POWER BOARD	1	PZ	V11850A0	M4X6 NICKEL PLATED FIXING SCRE	7	PZ	VM1745A0	CARD SUPPORT	6	PZ	VM2147A0	ESD SPONGE PINK SMOOTH 410X343X15 M	1	PZ
Code	Description	Qty	UOM																						
PE1983B1	LMISS 230V POWER BOARD	1	PZ																						
V11850A0	M4X6 NICKEL PLATED FIXING SCRE	7	PZ																						
VM1745A0	CARD SUPPORT	6	PZ																						
VM2147A0	ESD SPONGE PINK SMOOTH 410X343X15 M	1	PZ																						
TR1140A	350°C SAFETY THERMOSTAT MANUAL RESET		KTR1140A	2 POLES SAFETY THERMOSTAT KIT	<table border="1"> <thead> <tr> <th>Code</th> <th>Description</th> <th>Qty</th> <th>UOM</th> </tr> </thead> <tbody> <tr> <td>TR1140A0</td> <td>350°C SAFETY THERMOSTAT MANUAL RESE</td> <td>1</td> <td>PZ</td> </tr> </tbody> </table>	Code	Description	Qty	UOM	TR1140A0	350°C SAFETY THERMOSTAT MANUAL RESE	1	PZ												
Code	Description	Qty	UOM																						
TR1140A0	350°C SAFETY THERMOSTAT MANUAL RESE	1	PZ																						
MR1006A	CABLE 3X1.5 H07RN-F MT1.5+K1/6+SCHUK		KMR1006A	CABLE 3X1.5 H07RN-F MT1.5+K1/6+SCHUK	<table border="1"> <thead> <tr> <th>Code</th> <th>Description</th> <th>Qty</th> <th>UOM</th> </tr> </thead> <tbody> <tr> <td>MR1006A0</td> <td>CABLE 3X1.5 H07RN-F MT1.5+K1/6+S CHUKO</td> <td>1</td> <td>PZ</td> </tr> </tbody> </table>	Code	Description	Qty	UOM	MR1006A0	CABLE 3X1.5 H07RN-F MT1.5+K1/6+S CHUKO	1	PZ												
Code	Description	Qty	UOM																						
MR1006A0	CABLE 3X1.5 H07RN-F MT1.5+K1/6+S CHUKO	1	PZ																						
0H6221F	LM800 DYNAMIC MANUAL COMPONENTS HOLDER		0H6221F0	LM800 DYNAMIC MANUAL COMPONENTS HOLDER																					



COMPONENT			SPARE PART																		
Code	Description	Image	Code	Description	Components list																
VM1745A	CARD SUPPORT		KVM1745A	BOARD SUPPORT 10 PCS KIT	<table border="1"> <thead> <tr> <th>Code</th> <th>Description</th> <th>Qty</th> <th>UOM</th> </tr> </thead> <tbody> <tr> <td>VM1745A0</td> <td>CARD SUPPORT</td> <td>10</td> <td>PZ</td> </tr> </tbody> </table>	Code	Description	Qty	UOM	VM1745A0	CARD SUPPORT	10	PZ								
Code	Description	Qty	UOM																		
VM1745A0	CARD SUPPORT	10	PZ																		
PE1781A	200-240VAC 12VCC 1,5VA POWER SUPPLY		KPE1781A	240VAC 12VCC 1.5VA POWER SUPPLY KIT	<table border="1"> <thead> <tr> <th>Code</th> <th>Description</th> <th>Qty</th> <th>UOM</th> </tr> </thead> <tbody> <tr> <td>PE1781A0</td> <td>200-240VAC 12VCC 1,5VA POWER SUPPLY</td> <td>1</td> <td>PZ</td> </tr> <tr> <td>VM1745A0</td> <td>CARD SUPPORT</td> <td>4</td> <td>PZ</td> </tr> <tr> <td>VM2147A0</td> <td>ESD SPONGE PINK SMOOTH 410X343X15 M</td> <td>1</td> <td>PZ</td> </tr> </tbody> </table>	Code	Description	Qty	UOM	PE1781A0	200-240VAC 12VCC 1,5VA POWER SUPPLY	1	PZ	VM1745A0	CARD SUPPORT	4	PZ	VM2147A0	ESD SPONGE PINK SMOOTH 410X343X15 M	1	PZ
Code	Description	Qty	UOM																		
PE1781A0	200-240VAC 12VCC 1,5VA POWER SUPPLY	1	PZ																		
VM1745A0	CARD SUPPORT	4	PZ																		
VM2147A0	ESD SPONGE PINK SMOOTH 410X343X15 M	1	PZ																		