

**Apach**  
BAKERY *Line*

**FORNO VENTILATO  
VENTILATED OVEN  
FOUR VENTILE  
HORNO VENTILADO  
BELÜFTETER OFEN**

***K series***



**MANUALE RICAMBI  
SPARE PARTS MANUAL  
CATALOGUE DES PIECES DE RECHANGE  
LISTA REPUESTOS  
ERSATZTEILLISTE  
02-2020 REV. B**

**LA DITTA EUROPA S.r.l. SI RITIENE AUTORIZZATA A VARIARE I DATI RIPOSTATI  
NEL PRESENTE MANUALE SENZA DOVER AGGIORNARE QUELLI GIA' DIFUSI .**

**EUROPA S.R.L. RESERVES THE RIGHT TO VARY THE DATA GIVEN IN THIS  
MANUAL WITHOUT HAVING TO MODIFY THE DATA ALREADY GIVEN**

**LA SOCIETE EUROPA S.R.L. PEUT MODIFIER LES DONNEES INDIQUEES DANS LE  
PRESENT MANUEL SANS DEVOIR METTRE A JOUR LES DONNEES DEJA  
DIFFUSEES.**

**LA EMPRESA EUROPA S.r.l. SE CONSIDERA AUTORIZADA A CAMBIAR LOS  
DATOS DEL PRESENTE MANUAL SIN TENER QUE ACTUALIZAR AQUELLOS YA  
DIFUNDIDOS.**

**DIE FIRMA EUROPA S.r.l. IST BERECHTIGT, IN DIESEM HANDBUCH ÄNDERUNGEN  
AN DEN AUFGEFÜHRTEN DATEN VORZUNEHMEN, OHNE DIE BEREITS  
AUSGELIEFERTEN AUSGABEN ÜBERARBEITEN ZU MÜSSEN.**

## **Europa s.r.l.**

**Via Del Lavoro, 53**

**36034 MOLINA DI MALO (VI) ITALY**

**Tel.: ++ 39 0445 D637 444**

**FAX : ++ 39 0445 637 455**

**INTERNET: [www.europa-zone.com](http://www.europa-zone.com)**

**e-mail: [europa@europa-zone.com](mailto:europa@europa-zone.com)**

**INDICE  
CONTENTS  
TABLE DES MATIERES  
ÍNDICE  
INHALTSVERZEICHNIS**

|                                      |    |
|--------------------------------------|----|
| VISTA FRONTALE                       | 5  |
| FRONT VIEW                           | 5  |
| VUE FRONTALE                         | 6  |
| VISTA FRONTAL                        | 6  |
| ANSICHT VON VORN                     | 6  |
| VISTA INTERNA                        | 7  |
| INSIDE VIEW                          | 7  |
| VUE INTERNE                          | 8  |
| VISTA INTERNA                        | 8  |
| ANSICHT VON INNEN                    | 8  |
| VISTA POSTERIORE                     | 9  |
| REAR VIEW                            | 9  |
| VUE POSTERIEURE                      | 9  |
| VISTA TRASERA                        | 10 |
| ANSICHT VON HINTEN                   | 10 |
| ASPIRATORE                           | 11 |
| EXTRACTOR                            | 11 |
| EXTRACTEUR                           | 11 |
| ASPIRADOR                            | 11 |
| ABSAUGER                             | 11 |
| VENTILATORE E MOTORE                 | 12 |
| VENTILATOR AND MOTOR                 | 12 |
| VETNILATEUR ET MOTEUR                | 12 |
| VENTILADOR Y MOTOR                   | 13 |
| VENTILATOR UND MOTOR                 | 13 |
| RESISTENZE                           | 14 |
| HEATING ELEMENTS                     | 14 |
| RESISTANCES                          | 14 |
| RESISTENCIAS                         | 15 |
| WIDERSTÄNDE                          | 15 |
| VAPORIERA (OPTIONAL)                 | 17 |
| STEAM GENERATOR                      | 17 |
| GENERATEUR DE VAPEUR                 | 17 |
| GENERADOR DE VAPOR                   | 17 |
| DAMPFGENERATOR                       | 18 |
| GRUPPO ACQUA                         | 19 |
| WATER UNIT                           | 19 |
| GROUPE EAU                           | 19 |
| GRUPO AGUA                           | 20 |
| WASSEREINHEIT                        | 20 |
| AZIONAMENTO VALVOLA AUTOMATICA       | 21 |
| AUTOMATIC VALVE DRIVE                | 21 |
| ENTRAÎNEMENT DE LA VANNE AUTOMATIQUE | 21 |
| ACCIONAMIENTO VÁLVULA AUTOMÁTICA     | 21 |
| ANTRIEB DES AUTOMATISCHEN VENTILS    | 21 |
| PORTA                                | 22 |
| DOOR                                 | 23 |
| PORTE                                | 23 |
| PUERTA                               | 23 |
| TÜR                                  | 23 |

|   |    |
|---|----|
| LUCI  | 24 |
| LIGHTS  | 24 |
| LUMIERES                                      | 24 |
| LUCES   | 24 |
| LICHTE  | 24 |
| PANNELLO A SCROLLER                           | 25 |
| CONTROL PANEL WITH ROTARY SWITCH              | 26 |
| PANNEAU DE COMMANDE AVEC BOUTON MULTIFONCTION | 26 |
| PANEL CON MANDO MULTIFUNCIÓN                  | 26 |
| BEDIENFELD MIT SCROLLER                       | 26 |
| PANNELLO ELETTROMECCANICO                     | 27 |
| ELECTROMECHANIC PANEL                         | 28 |
| PANNEAU ELECTROMECHANIQUE                     | 28 |
| PANEL ELCTROMECHANICO                         | 28 |
| ELEKTOMECHANISCHES BEDIENFELD                 | 28 |
| TERMOCOPPIA                                   | 29 |
| THERMOCOUPLE                                  | 29 |
| THERMOCOUPLE                                  | 29 |
| TERMOPAR                                      | 29 |
| THERMOELEMENT                                 | 29 |
| FINECORSA PORTA                               | 30 |
| DOOR LIMIT SWITCH                             | 30 |
| FIN DE COURSE DE LA PORTE                     | 30 |
| FINAL DE CARRERA DE LA PUERTA                 | 30 |
| TÜRENDSCHLAG                                  | 30 |
| ISOLANTI                                      | 31 |
| INSULATING MATERIALS                          | 31 |
| ISOLANTS                                      | 31 |
| AISLANTES                                     | 31 |
| ISOLIERMATERIALIEN                            | 31 |
| ACESSORI                                      | 32 |
| ACCESSORIES                                   | 32 |
| ACCESSOIRES                                   | 32 |
| ACCESORIOS                                    | 32 |
| ZUBEHÖR                                       | 32 |
| CELLE   | 35 |
| PROVERS                                       | 35 |
| ETUVES  | 36 |
| ESTUFAS                                       | 36 |
| SCHRÄNKE                                      | 37 |
| CAVALLETTI                                    | 38 |
| STANDS  | 38 |
| SUPPORTS                                      | 38 |
| BASES DE APOYO                                | 38 |
| HALTEBÜGEL                                    | 38 |



**VISTA FRONTALE**

| POS. | CODICE   | DESCRIZIONE                                |
|------|----------|--|
| 1    | .....    | CAPPA COMPLETA                             |
| 2    | 44000014 | MANOPOLA VALVOLA SCARICO VAPORE            |
| 3    | .....    | CRUSCOTTO COMANDI                          |
| 4    | .....    | GRUPPO MANIGLIA PORTA (SU SEZIONE "PORTA") |
| 5    | .....    | PORTA COMPLETA K10                         |
| 6    | .....    | PORTA COMPLETA K5                          |
| 7    | .....    | CELLA COMPLETA                             |



**FRONT VIEW**

| POS. | CODE     | DESCRIPTION                             |
|------|----------|---|
| 1    | .....    | COMPLETE HOOD                           |
| 2    | 44000014 | STEAM DUMP VALVE KNOB                   |
| 3    | .....    | CONTROL PANEL                           |
| 4    | .....    | DOOR HANDLE UNIT (UNDER "DOOR" SECTION) |
| 5    | .....    | COMPLETE DOOR K10                       |
| 6    | .....    | COMPLETE DOOR K5                        |
| 7    | .....    | COMPLETE PROVER                         |

**VUE DE FACE**

| POS. | CODE     | DESCRIPTION                                      |  |  |
|------|----------|--|--|--|
| 1    | .....    | HOTTE COMPLETE                                   |  |  |
| 2    | 44000014 | BOUTON SOUPEPE EVACUATION VAPEURS                |  |  |
| 3    | .....    | TABLEAU DE BORD COMMANDES                        |  |  |
| 4    | .....    | GROUPE POIGNEE DE LA PORTE (DANS SCTION "PORTE") |  |  |
| 5    | .....    | PORTE COMPLETE K10                               |  |  |
| 6    | .....    | PORTE COMPLETE K5                                |  |  |
| 7    | .....    | ETUVE COMPLETE                                   |  |  |

**VISTA FRONTAL**

| POS. | CODE     | DESCRIPCIÓN                               |  |  |
|------|----------|---|--|--|
| 1    | .....    | CAMPANA COMPLETE                          |  |  |
| 2    | 44000014 | BOTÓN VÁLVULA DESCARGA VAPOR              |  |  |
| 3    | .....    | TABLERO DE MANDOS                         |  |  |
| 4    | .....    | GRUPO MANIJA PUERTA (EN SECCIÓN "PUERTA") |  |  |
| 5    | .....    | PUERTA COMPLETE K10                       |  |  |
| 6    | .....    | PUERTA COMPLETE K5                        |  |  |
| 7    | .....    | ESTUFA COMPLETE                           |  |  |

**VORDERANSICHT**

| POS. | CODE     | BESCHREIBUNG                             |  |  |
|------|----------|--|--|--|
| 1    | .....    | ABZUGSHAUBE KOMPLETT                     |  |  |
| 2    | 44000014 | GRIFF ZUM SCHWADENSABZUGSVENTIL          |  |  |
| 3    | .....    | BEDIENFELD                               |  |  |
| 4    | .....    | TÜRHANDGRIFFEINHEIT (IM ABSCHNITT "TÜR") |  |  |
| 5    | .....    | TÜR, KOMPLETT K10                        |  |  |
| 6    | .....    | TÜR, KOMPLETT K5                         |  |  |
| 7    | .....    | SCHRANK, KOMPLETT                        |  |  |

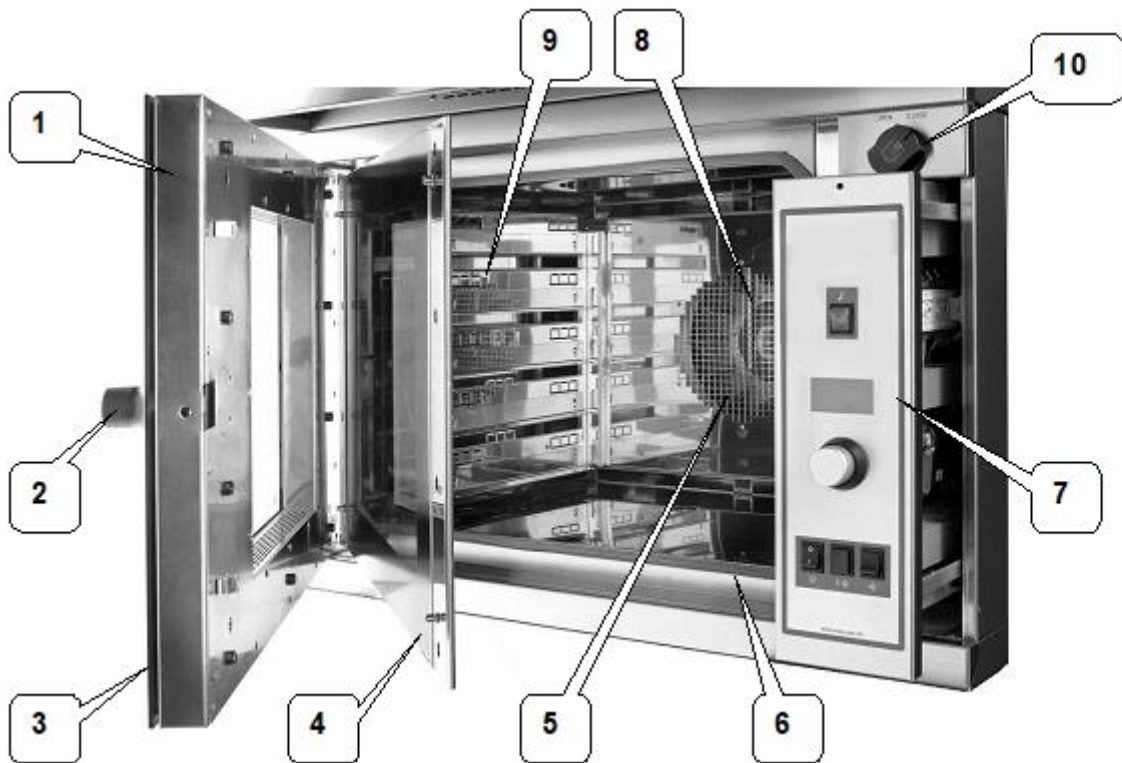

|  |        |  |  |
|---|--------|--|--|
| <b>VISTA INTERNA</b>  |        |  |  |
| POS.  | CODICE | DESCRIZIONE                                    |  |
| 1   | .....  | PORTA COMPLETA                                 |  |
| 2   | .....  | MANIGLIA PORTA                                 |  |
| 3   | .....  | VETRO ESTERNO                                  |  |
| 4   | .....  | VETRO INTERNO                                  |  |
| 5   | .....  | VENTILATORE E RESISTENZA ELETTRICA             |  |
| 6   | .....  | GUARNIZIONE PORTA                              |  |
| 7   | .....  | PANNELLO COMANDI ESTRAIBILE                    |  |
| 8   | .....  | TUBO NEBULIZZATORE ACQUA                       |  |
| 9   | .....  | RASTRELLIERA PORTA TEGLIE                      |  |
| 10  | .....  | MANOPOLA AZIONAMENTO VALVOLA DI SCARICO VAPORE |  |

|  |       |                                |  |
|---|-------|--------------------------------|--|
| <b>INSIDE VIEW</b>  |       |                                |  |
| POS.  | CODE  | DESCRIPTION                    |  |
| 1   | ..... | COMPLETE DOOR                  |  |
| 2   | ..... | DOOR HANDLE                    |  |
| 3   | ..... | EXTERNAL DOOR GLASS            |  |
| 4   | ..... | INTERNAL DOOR GLASS            |  |
| 5   | ..... | VENTILATOR AND HEATING ELEMENT |  |
| 6   | ..... | DOOR GASKET                    |  |
| 7   | ..... | REMOVABLE CONTROL-PANEL        |  |
| 8   | ..... | WATER NEBULIZING PIPE          |  |
| 9   | ..... | BAKIN PANS HOLDERS             |  |
| 10  | ..... | STEAM DUMP VALVE STARTING KNOB |  |

**VUE INTERNE**

| POS. | CODE  | DESCRIPTION                                     |  |  |
|------|-------|---|--|--|
| 1    | ----- | PORTE COMPLETE                                  |  |  |
| 2    | ----- | POIGNEE DE LA PORTE                             |  |  |
| 3    | ----- | VITRE EXTERNE                                   |  |  |
| 4    | ----- | VITRE INTERNE                                   |  |  |
| 5    | ----- | VENTILATEUR ET RESISTANCE ELECTRIQUE            |  |  |
| 6    | ----- | JOINT DE LA PORTE                               |  |  |
| 7    | ----- | PANNEAU DE COMMANDE EXTRACTIBLE                 |  |  |
| 8    | ----- | TUBE NEBULISEUR DE L'EAU                        |  |  |
| 9    | ----- | RATELIER PORTE PLATEAUX                         |  |  |
| 10   | ----- | BOUTON ENTRAINEMENT SOUPAPE D'EVACUATION VAPEUR |  |  |

**VISTA INTERIOR**

| POS. | CODE  | DESCRIPCIÓN                                  |  |  |
|------|-------|--|--|--|
| 1    | ----- | PUERTA COMPLETA                              |  |  |
| 2    | ----- | MANIJA PUERTA                                |  |  |
| 3    | ----- | VIDRIO EXTERNO                               |  |  |
| 4    | ----- | VIDRIO INTERNO                               |  |  |
| 5    | ----- | VENTILADOR Y RESISTENCIA ELÉCTRICA           |  |  |
| 6    | ----- | GUARNICIÓN PUERTA                            |  |  |
| 7    | ----- | PANEL DE MANDOS EXTRAÍBLE                    |  |  |
| 8    | ----- | TUBO NEBULIZADOR AGUA                        |  |  |
| 9    | ----- | BASTIDOR PORTA BANDEJAS                      |  |  |
| 10   | ----- | BOTÓN ACCIONAMIENTO VÁLVULA DE DESAGUE VAPOR |  |  |

**INNERE ANSICHT**

| POS. | CODE  | BESCHREIBUNG                                   |  |  |
|------|-------|--|--|--|
| 1    | ----- | TÜR KOMPLETT                                   |  |  |
| 2    | ----- | TÜRHANDGRIFF                                   |  |  |
| 3    | ----- | AUSSENGLAS                                     |  |  |
| 4    | ----- | INNENGLAS                                      |  |  |
| 5    | ----- | VENTILATOR UND ELEKTRISCHER WIDERSTAND         |  |  |
| 6    | ----- | TÜRDICHTUNG                                    |  |  |
| 7    | ----- | HERAUSZIEHBARES BEDIENFELD                     |  |  |
| 8    | ----- | WASSERZERSTEUER                                |  |  |
| 9    | ----- | GESTELL FÜR OFENBLECHE                         |  |  |
| 10   | ----- | DREHGRIF ZUM ANTRIEB DES SCHWADENABZUGSVENTILS |  |  |



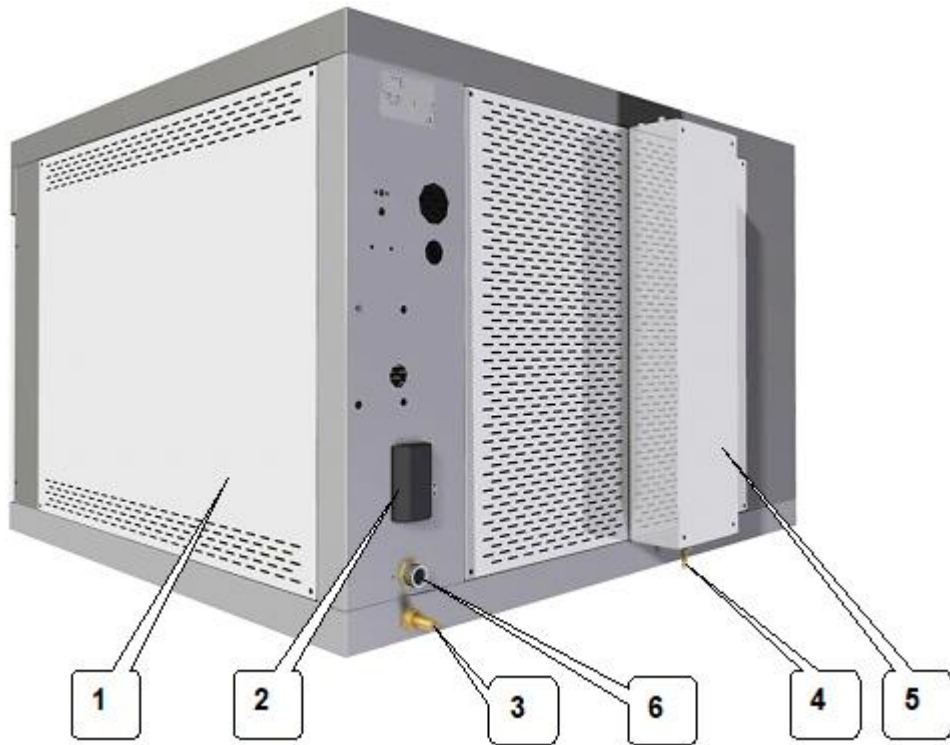

|  |        |  |  |
|--|--------|--|--|
| <b>VISTA POSTERIORE</b>  |        |  |  |
| POS.   | CODICE | DESCRIZIONE  |  |
| 1  | .....  |  |  |
| 2  | .....  |  |  |
| 3  | .....  |  |  |
| 4  | .....  |  |  |
| 5  | .....  |  |  |
| 6  | .....  | ELETTROVALVOLA/E VAPORIERA/E (SU SEZIONE GRUPPO ACQUA) |  |

|  |       |   |  |
|---|-------|---|--|
| POS.  | CODE  | DESCRIPTION   |  |
| 1   | ..... |   |  |
| 2   | ..... |   |  |
| 3   | ..... |   |  |
| 4   | ..... |   |  |
| 5   | ..... |   |  |
| 6   | ..... | SOLENOID VALVE/S STEAM GENERATOR/S (UNDER WATER UNIT SECTION) |  |

|  |       |   |  |
|---|-------|---|--|
| POS.  | CODE  | DESCRIPTION   |  |
| 1   | ..... |   |  |
| 2   | ..... |   |  |
| 3   | ..... |   |  |
| 4   | ..... |   |  |
| 5   | ..... |   |  |
| 6   | ..... | ELECTROVANNE/S GENERATEUR/S DE VAPEUR (DANS SECTION GROUPE EAU) |  |





| POS. | CÓDIGO | DESCRIPCIÓN  |  |  |
|------|--------|--|--|--|
| 1    | -----  |  |  |  |
| 2    | -----  |  |  |  |
| 3    | -----  |  |  |  |
| 4    | -----  |  |  |  |
| 5    | -----  |  |  |  |
| 6    | -----  | ELETTROVÁLVULA/S GENERADOR/ES DE VAPOR (EN SECCIÓN GRUPO AGUA) |  |  |



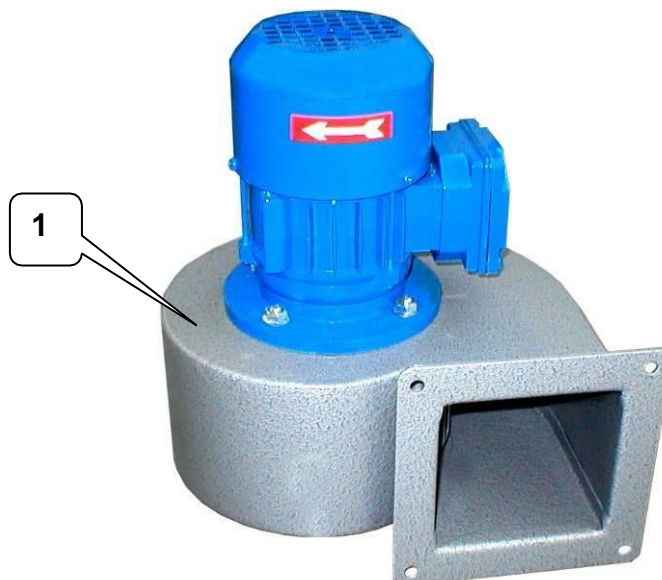

| POS. | CODE  | BESCHREIBUNG  |  |  |
|------|-------|---|--|--|
| 1    | ----- |   |  |  |
| 2    | ----- |   |  |  |
| 3    | ----- |   |  |  |
| 4    | ----- |   |  |  |
| 5    | ----- |   |  |  |
| 6    | ----- | ELEKTROVANNE/N DAMPFGENERATOR/EN (IM ABSCHNITT WASSEREINHEIT) |  |  |



|  |          |  |  |
|---|----------|--|--|
| <b>ASPIRATORE (SOLO CON ACESSORIO CAPP)</b>                                       |          |  |  |
| POS.  | CODICE   | DESCRIZIONE                                |  |
| 1   | 31900096 | VENTILATORE COMPLETO TRIFASE , 50 / 60 HZ  |  |
| 1   | 31900062 | VENTILATORE COMPLETO MONOFASE , 50 / 60 HZ |  |

|  |          |   |  |
|---|----------|---|--|
| <b>EXHAUSTER (ONLY WITH OPTIONAL HOOD)</b>  |          |   |  |
| POS.  | CODE     | DESCRIPTION                                 |  |
| 1   | 31900096 | COMPLETE ASPIRATOR THREE-PHASE , 50 / 60 HZ |  |
| 1   | 31900062 | COMPLETE ASPIRATOR ONE-FASE , 50 / 60 HZ    |  |

|  |          |   |  |
|---|----------|---|--|
| <b>ASPIRATEUR (SEULEMENT AVEC HOTTE EN OPTION)</b>                                  |          |   |  |
| POS.  | CODE     | DESCRIPTION                               |  |
| 1   | 31900096 | ASPIRATEUR COMPLET TRIPHASE , 50 / 60 HZ  |  |
| 1   | 31900062 | ASPIRATEUR COMPLET MONOPHASE , 50 / 60 HZ |  |

|  |          |  |  |
|---|----------|--|--|
| <b>EXTRACTOR (SOLAMENTE CON CAMPANA EN OPCION)</b>                                  |          |  |  |
| POS.  | CÓDIGO   | DESCRIPCIÓN                                |  |
| 1   | 31900096 | EXTRACTOR COMPLETO TRIFÁSICO , 50 / 60 HZ  |  |
| 1   | 31900062 | EXTRACTOR COMPLETO MONOFÁSICO , 50 / 60 HZ |  |

|  |          |  |  |
|---|----------|--|--|
| <b>ABSAUGER</b>   |          |  |  |
| POS.  | CODE     | BESCHREIBUNG                                     |  |
| 1   | 31900096 | DAMPFEXTRAKTOR KOMPLETT DREI-PHASIG , 50 / 60 HZ |  |
| 1   | 31900062 | DAMPFEXTRAKTOR KOMPLETT EIN-PHASIG , 50 / 60 HZ  |  |

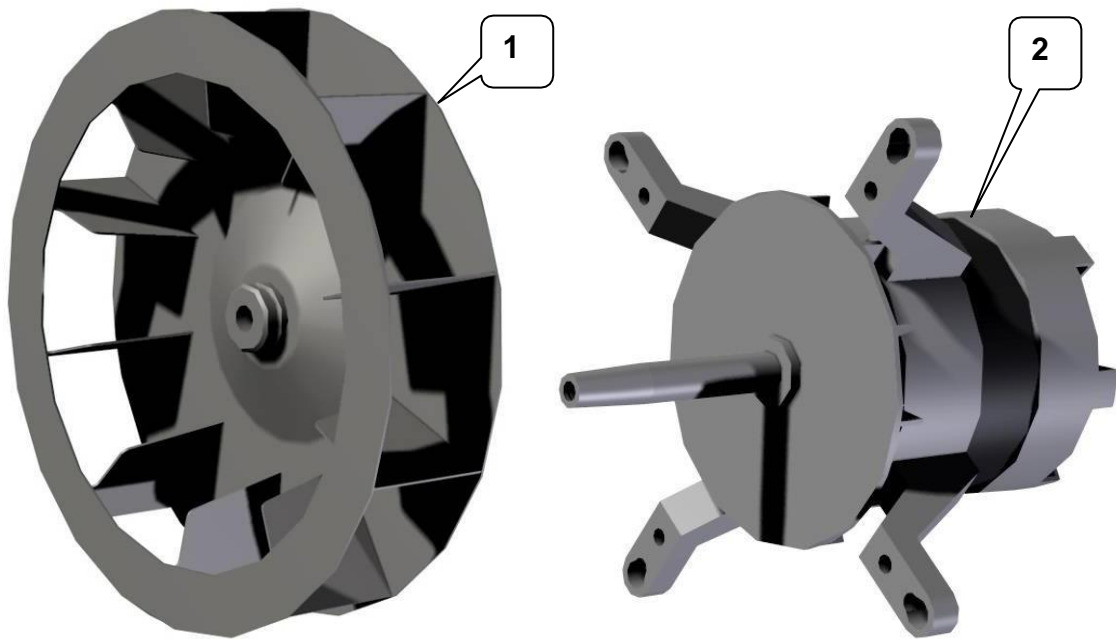

|  |          |                                  |  |
|---|----------|----------------------------------|--|
| VENTILATORE E MOTORE  |          |                                  |  |
| POS.  | CODICE   | DESCRIZIONE                      |  |
| 1   | 31900069 | GIRANTE A 12 PALE A 50HZ         |  |
| 1   | 31900070 | GIRANTE A 10 PALE A 60HZ         |  |
| 2   | 31910056 | MOTORE TRIFASE 400V , 50 / 60 HZ |  |
| 2   | 31910057 | MOTORE TRIFASE 230V , 50 / 60 HZ |  |
| 2   | 31910086 | MOTORE MONOFASE 230V A 50 HZ, 4P |  |

|  |          |                                     |  |
|---|----------|-------------------------------------|--|
| FAN AND MOTOR   |          |                                     |  |
| POS.  | CODE     | DESCRIPTION                         |  |
| 1   | 31900069 | 12 BLADE ROTOR 50HZ                 |  |
| 1   | 31900070 | 10 BLADE ROTOR A 60HZ               |  |
| 2   | 31910056 | THREE-PHASE MOTOR 400V , 50 / 60 HZ |  |
| 2   | 31910057 | THREE-PHASE MOTOR 230V , 50 / 60 HZ |  |
| 2   | 31910086 | ONE-PHASE MOTOR 230V 50 HZ, 4P      |  |

|  |          |                                   |  |
|---|----------|-----------------------------------|--|
| VENTILATEUR ET MOTEUR   |          |                                   |  |
| POS.  | CODE     | DESCRIPTION                       |  |
| 1   | 31900069 | ROTEUR A 12 PALES A 50HZ          |  |
| 1   | 31900070 | ROTEUR A 10 PALES A 60HZ          |  |
| 2   | 31910056 | MOTEUR TRIPHASE 400V , 50 / 60 HZ |  |
| 2   | 31910057 | MOTEUR TRIPHASE 230V , 50 / 60 HZ |  |
| 2   | 31910086 | MOTEUR MONOPHASE 230V A 50 HZ, 4P |  |

**VENTILADOR Y MOTOR**

| POS. | CÓDIGO   | DESCRIPCIÓN                       |  |  |
|------|----------|-----------------------------------|--|--|
| 1    | 31900069 | ROTOR A 12 PALAS A 50HZ           |  |  |
| 1    | 31900070 | ROTOR A 10 PALAS A 60HZ           |  |  |
| 2    | 31910056 | MOTOR TRIFÁSICO 400V , 50 / 60 HZ |  |  |
| 2    | 31910057 | MOTOR TRIFÁSICO 230V , 50 / 60 HZ |  |  |
| 2    | 31910086 | MOTOR MONOFÁSICO 230V A 50 HZ, 4P |  |  |

**VENTILATOR UND MOTOR**

| POS. | CODE     | BESCHREIBUNG                        |  |  |
|------|----------|-------------------------------------|--|--|
| 1    | 31900069 | LÄUFER MIT 12 FLÜGEL 50HZ           |  |  |
| 1    | 31900070 | LÄUFER MIT 10 FLÜGEL A 60HZ         |  |  |
| 2    | 31910056 | MOTOR DREI-PHASIG 400V , 50 / 60 HZ |  |  |
| 2    | 31910057 | MOTOR DREI-PHASIG 230V , 50 / 60 HZ |  |  |
| 2    | 31910086 | MOTOR EIN-PHASIG 230V 50 HZ, 4P     |  |  |

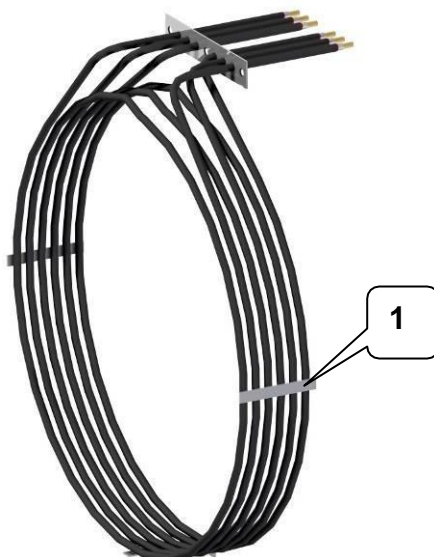

|  |          |  |  |
|---|----------|--|--|
| <b>RESISTENZE</b>   |          |  |  |
| POS.  | CODICE   | DESCRIZIONE                                      |  |
| 1   | 33010044 | RESISTENZA ELETTRICA DA 6000W                    |  |
| 1   | 33010022 | RESISTENZA ELETTRICA DA 8000W                    |  |
| 1   | 33010045 | RESISTENZA ELETTRICA DA 10.000W                  |  |
|   | 21006426 | PONTE COLLEGAMENTO RESISTENZA A STELLA INT.17    |  |
|   | 21006427 | PONTE COLLEGAMENTO RESISTENZA A TRIANGOLO INT.45 |  |
|   | 21006428 | PONTE COLLEGAMENTO RESISTENZA A TRIANGOLO INT.62 |  |
|   | 21006429 | PONTE COLLEGAMENTO RESISTENZA A TRIANGOLO INT.79 |  |

|  |          |   |  |
|---|----------|---|--|
| <b>ELECTRIC HEATING ELEMENTS</b>  |          |   |  |
| POS.  | CODE     | DESCRIPTION                                       |  |
| 1   | 33010044 | ELECTRIC HEATING ELEMENT 6000W                    |  |
| 1   | 33010022 | ELECTRIC HEATING ELEMENT 8000W                    |  |
| 1   | 33010045 | ELECTRIC HEATING ELEMENT 10.000W                  |  |
|   | 21006426 | STAR CONNECTION JUMPER OF HEATING ELEMENT INT.17  |  |
|   | 21006427 | DELTA CONNECTION JUMPER OF HEATING ELEMENT INT.45 |  |
|   | 21006428 | DELTA CONNECTION JUMPER OF HEATING ELEMENT INT.62 |  |
|   | 21006429 | DELTA CONNECTION JUMPER OF HEATING ELEMENT INT.79 |  |

|  |          |  |  |
|---|----------|--|--|
| <b>RESISTANCES</b>  |          |  |  |
| POS.  | CODE     | DESCRIPTION                                |  |
| 1   | 33010044 | RESISTANCE ELECTRIQUE DE 6000W             |  |
| 1   | 33010022 | RESISTANCE ELECTRIQUE DE 8000W             |  |
| 1   | 33010045 | RESISTANCE ELECTRIQUE DE 10.000W           |  |
|   | 21006426 | PONT CONNECTION RESISTANCE ETOILE INT.17   |  |
|   | 21006427 | PONT CONNECTION RESISTANCE TRIANGLE INT.45 |  |
|   | 21006428 | PONT CONNECTION RESISTANCE TRIANGLE INT.62 |  |
|   | 21006429 | PONT CONNECTION RESISTANCE TRIANGLE INT.79 |  |

**RESISTENCIAS**

| POS. | CÓDIGO   | DESCRIPCIÓN                                  |  |  |
|------|----------|--|--|--|
| 1    | 33010044 | RESISTENCIA ELÉCTRICA DE 6000W               |  |  |
| 1    | 33010022 | RESISTENCIA ELÉCTRICA DE 8000W               |  |  |
| 1    | 33010045 | RESISTENCIA ELÉCTRICA DE 10.000W             |  |  |
|      | 21006426 | PUENTE CONEXIÓN RESISTENCIA ESTRELLA INT.17  |  |  |
|      | 21006427 | PUENTE CONEXIÓN RESISTENCIA TRIÁNGULO INT.45 |  |  |
|      | 21006428 | PUENTE CONEXIÓN RESISTENCIA TRIÁNGULO INT.62 |  |  |
|      | 21006429 | PUENTE CONEXIÓN RESISTENCIA TRIÁNGULO INT.79 |  |  |

**WIDERSTÄNDE**

| POS. | CODE     | BESCHREIBUNG                               |  |  |
|------|----------|--|--|--|
| 1    | 33010044 | ELEKTRISCHER WIDERSTAND 6000W              |  |  |
| 1    | 33010022 | ELEKTRISCHER WIDERSTAND 8000W              |  |  |
| 1    | 33010045 | ELEKTRISCHER WIDERSTAND 10.000W            |  |  |
|      | 21006426 | BRÜCKE STERNVERBINDUNG WIDERSTAND INT.17   |  |  |
|      | 21006427 | BRÜCKE DREIECKVERBINDUNG WIDERSTAND INT.45 |  |  |
|      | 21006428 | BRÜCKE DREIECKVERBINDUNG WIDERSTAND INT.62 |  |  |
|      | 21006429 | BRÜCKE DREIECKVERBINDUNG WIDERSTAND INT.79 |  |  |

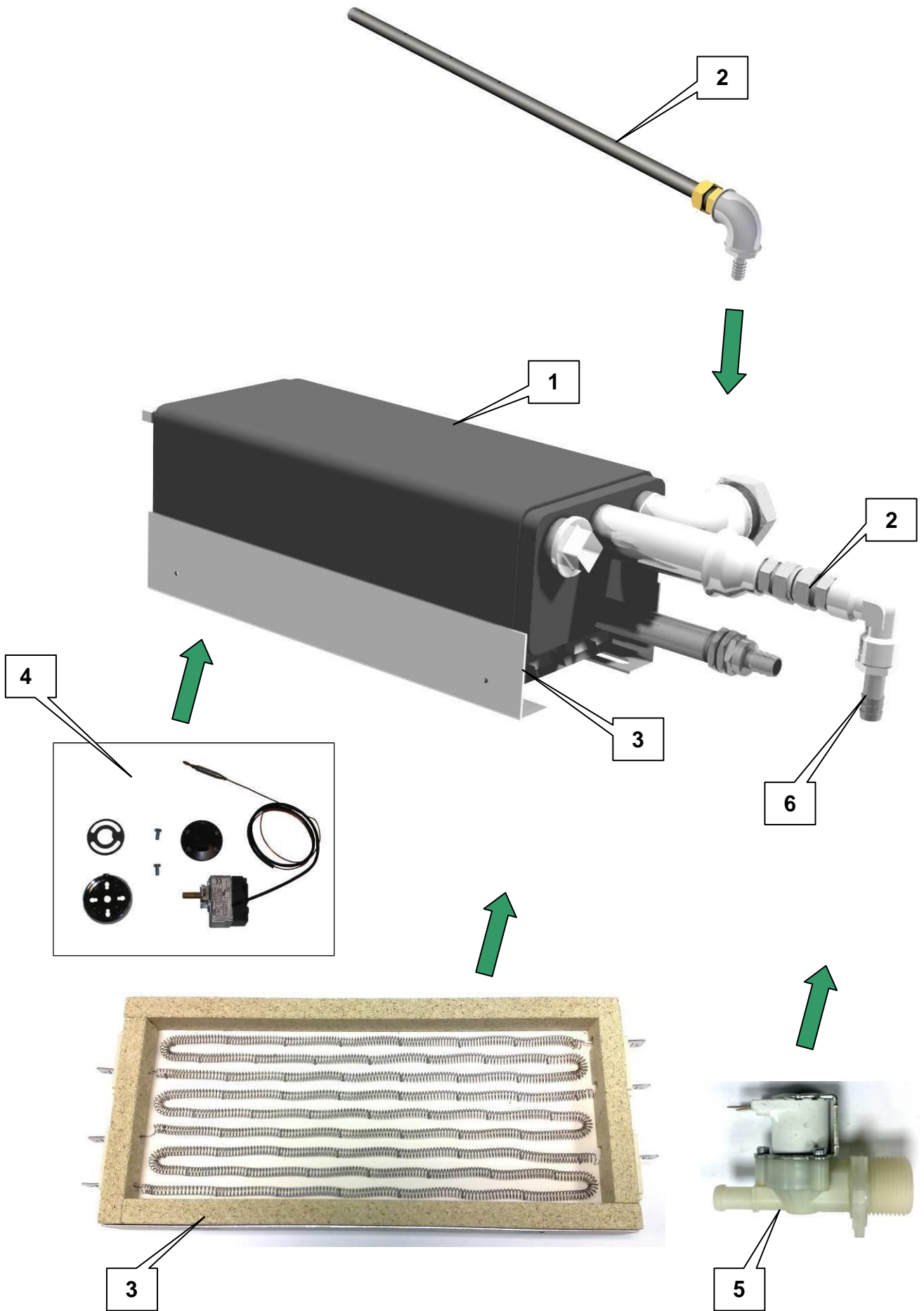



| <b>VAPORIERA (OPTIONAL)</b> |                      |   |  |
|-----------------------------|----------------------|---|--|
| POS.                        | CODICE               | DESCRIZIONE   |  |
| 1                           | 61001215             | VAPORIERA COMPLETA  |  |
| 2                           | 25000594             | SPRUZZATORE VAPORIERA                                     |  |
| 3                           | 33010038             | RESISTENZA PER VAPORIERA                                  |  |
| 4                           | 39930023             | TERMOSTATO 50 / 250°C                                     |  |
| 5                           | 55900094<br>55900156 | ELETTROVALVOLA COD104 230V<br>+ RIDUTTORE DI PORTATA NERO |  |
| 6                           | 55900150             | TUBO GOMMA MULTIFORM GIALLO 10X20 (FORNITURA MINIMA 1MT)  |  |
| 6                           | 54900009             | FASCETTE STRINGITUBO PER TUBO GOMMA                       |  |



| <b>STEAM GENERATOR (OPTIONAL)</b> |                      |   |  |
|-----------------------------------|----------------------|---|--|
| POS.                              | CODE                 | DESCRIPTION   |  |
| 1                                 | 61001215             | COMPLETE STEAM GENERATOR                                |  |
| 2                                 | 25000594             | SPRAYER STEAM GENERATOR                                 |  |
| 3                                 | 33010038             | HEATING ELEMENT FOR STEAM GENERATOR                     |  |
| 4                                 | 39930023             | THERMOSTAT 50°/250° C                                   |  |
| 5                                 | 55900094<br>55900156 | SOLENOID VALVE COD104 230V<br>+ FLOW REDUCER BLACK      |  |
| 6                                 | 55900150             | RUBBER TUBE MULTIFORM YELLOW 10X20 (MINIMUM SUPPLY 1MT) |  |
| 6                                 | 54900009             | HOSE CLAMPS FOR RUBBER TUBE                             |  |





| <b>GENERATEUR DE VAPEUR (EN OPTION)</b> |          |  |  |
|---|----------|--|--|
| POS.                                    | CODE     | DESCRIPTION  |  |
| 1                                       | 25000594 | GENERATEUR DE VAPEUR COMPLET                                   |  |
| 2                                       | 33010038 | GICLEUR GENERATEUR DE VAPEUR                                   |  |
| 3                                       | 39930032 | RESISTANCE POUR GENERATEUR DE VAPEUR                           |  |
| 4                                       | 39930023 | THERMOSTAT 50°/250° C  |  |
| 5                                       | 55900150 | ELETTROVANNE COD104 230V<br>+ LIMITATEUR DE FLUXE NOIR         |  |
| 6                                       | 54900009 | TUBE CAOUTCHOUC MULTIFORM JAUNE 10X20 (FOURNITURE MINIMUM 1MT) |  |
| 6                                       | 61001215 | BAGUES SERRE-TUBE POR TUBE DE CAOUTCHOUC                       |  |



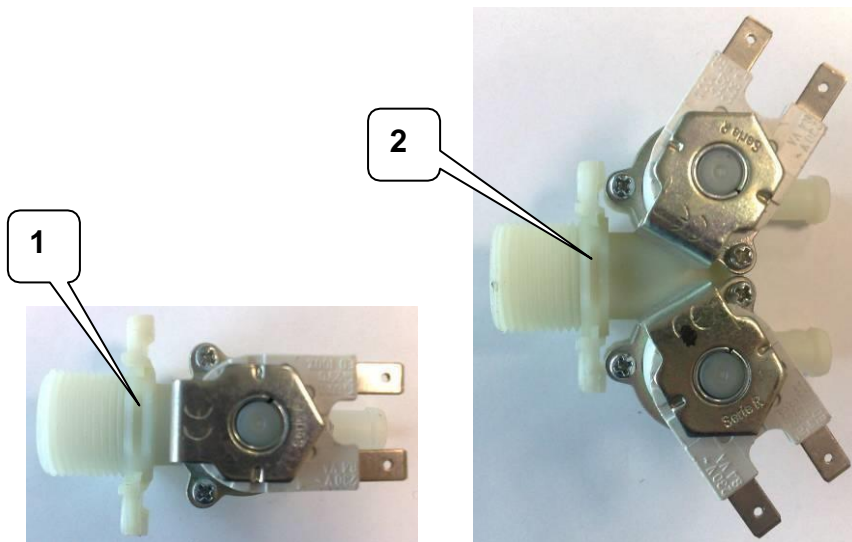

| <b>GENERADOR DE VAPOR (OPCIONAL)</b> |                      |  |  |
|--------------------------------------|----------------------|--|--|
| POS.                                 | CÓDIGO               | DESCRIPCIÓN  |  |
| 1                                    | 61001215             | GENERADOR DE VAPOR COMPLETO                                |  |
| 2                                    | 25000594             | VAPORIZADOR GENERADOR DE VAPOR                             |  |
| 3                                    | 33010038             | RESISTENCIA PARA GENERADOR DE VAPOR                        |  |
| 4                                    | 39930023             | TERMOSTATO 50°/250° C                                      |  |
| 5                                    | 55900094<br>55900156 | ELETTROVÁLVULA CÓD104 230V<br>+ LIMITADOR DE FLUJO NEGRO   |  |
| 6                                    | 55900150             | TUBO GOMA MULTIFORM AMARILLO 10X20 (SUMINISTRO MÍNIMO 1MT) |  |
| 6                                    | 54900009             | ABRAZADERAS APRIETA TUBOS PARA TUBO DE GOMA                |  |

| <b>DAMPFERZEUGER</b> |                      |   |  |
|----------------------|----------------------|---|--|
| POS.                 | CODE                 | BESCHREIBUNG  |  |
| 1                    | 61001215             | KOMPLETTER DAMPFERZEUGER                                  |  |
| 2                    | 25000594             | DAMPFERZEUGERSPRÜHER                                      |  |
| 3                    | 33010038             | HEIZWIDERSTAND FÜR DAMPFERZEUGER                          |  |
| 4                    | 39930023             | THERMOSTAT 50°/250° C                                     |  |
| 5                    | 55900094<br>55900156 | ELETTROVENTIL COD104 230V<br>+ STROMUNGSBEGRENZER SCHWARZ |  |
| 6                    | 55900150             | GUMMIROHR MULTIFORM GELB 10X20 (MINDESTLIEFERUNG 1MT)     |  |
| 6                    | 54900009             | ROHRSCHELLEN FÜR GUMMIROHR                                |  |



|  |              |  |        |
|---|--------------|--|--------|
| <b>GRUPPO ACQUA</b>   |              |  |        |
| POS.  | CODICE       | DESCRIZIONE                            | PREZZO |
| 1   | 55900094/198 | ELETTROVALVOLA 3/4" MINI 230 V         |        |
| 2   | 55900153     | DOPPIA ELETTROVALVOLA 3/4" MINI 230 V  |        |
|   | 55900150     | TUBO GOMMA EDPM 10X20 GIALLO , MT. 0,5 |        |
|   | 54900009     | FASCETTA STRINGI TUBO                  |        |
|   | 55900159     | RACCORDO PORTAGOMMA 1/2" DIAM.10       |        |
|   | 25000624     | TUBO NEBULIZZATORE ACQUA PER K5T       |        |
|   | 25000625     | TUBO NEBULIZZATORE ACQUA PER K10T      |        |

|  |          |  |       |
|---|----------|--|-------|
| <b>WATER UNIT</b>   |          |  |       |
| POS.  | CODE     | DESCRIPTION  | PRICE |
| 1   | 55900094 | SOLENOID VALVE 3/4" MINI 230 V   |       |
| 2   | 55900153 | DOUBLE SOLENOID VALVE 3/4" MINI 230 V (ONLY WITH OPTIONAL PLATE STEAM GENERATOR) |       |
|   | 55900150 | RUBBER TUBE EDPM 10X20 YELLOW , MT. 0,5  |       |
|   | 54900009 | HOSE CLAMP   |       |
|   | 55900159 | HOSE CLAMP FITTING 1/2" DIAM.10  |       |
|   | 25000624 | WATER NEBULIZING TUBE FOR K5T  |       |
|   | 25000625 | WATER NEBULIZING TUBE FOR K10T   |       |

|  |          |  |      |
|---|----------|--|------|
| <b>GROUPE EAU</b>   |          |  |      |
| POS.  | CODE     | DESCRIPTION  | PRIX |
| 1   | 55900094 | ELETTROVANNE 3/4" MINI 230 V   |      |
| 2   | 55900153 | DOUBLE ELETTROVANNE 3/4" MINI 230 V (SEULEMENT AVEC OPTION GENERATEUR DE VAPEUR A PLAQUES) |      |
|   | 55900150 | TUBE CAOUTCHOUC EDPM 10X20 JAUNE , MT. 0,5   |      |
|   | 54900009 | BAGUE SERRE TUBE   |      |
|   | 55900159 | RACCORD PORTE-JOINT 1/2" DIAM.10   |      |
|   | 25000624 | TUBE NEBULISEUR EAU POUR K5T   |      |
|   | 25000625 | TUBE NEBULISEUR EAU POUR K10T  |      |

**GRUPO AGUA**

| POS. | CÓDIGO   | DESCRIPCIÓN                             | PRECIO |
|------|----------|---|--------|
| 1    | 55900094 | ELECTROVÁLVULA ¼" MINI 230 V            |        |
| 2    | 55900153 | DOBLE ELECTROVÁLVULA ¼" MINI 230 V      |        |
|      | 55900150 | TUBO GOMA EDPM 10X20 AMARILLO , MT. 0,5 |        |
|      | 54900009 | BRIDA DE APRIETE DE TUBOS               |        |
|      | 55900159 | EMPALME PORTAGOMA ½" DIÁM.10            |        |
|      | 25000624 | TUBO NEBULIZADOR AGUA PARA K5T          |        |
|      | 25000625 | TUBO NEBULIZADOR AGUA PARA K10T         |        |

**WASSERGRUPPE**

| POS. | CODE     | BESCHREIBUNG  | PREIS |
|------|----------|---|-------|
| 1    | 55900094 | ELETTROVENTIL ¼" MINI 230 V   |       |
| 2    | 55900153 | DOPPELTES ELEKTROVENTIL ¼" MINI 230 V (NUR MIT OPTION PLATTENDAMPFERZEUGER) |       |
|      | 55900150 | GUMMIROHR EDPM 10X20 GELB , MT. 0,5   |       |
|      | 54900009 | ROHRSCHELLE   |       |
|      | 55900159 | SCHLAUCHANSCHLUSSSTÜCK ½" DURCHM. 10  |       |
|      | 25000624 | WASSERZERSTÄUBER FÜR K5T  |       |
|      | 25000625 | WASSERZERSTÄUBER FÜR K10T   |       |



### AZIONAMENTO VALVOLA AUTOMATICA

| POS. | CODICE   | DESCRIZIONE                          |
|------|----------|--------------------------------------|
| 1    | 31920011 | MOTORIDUTTORE 45.K60 KIWI 12Nm 6 RPM |
| 2    | 39970010 | FINECORSA 5A 250V MINIATURA          |



### AUTOMATIC VALVE DRIVE

| POS. | CODE     | DESCRIPTION                          |
|------|----------|--------------------------------------|
| 1    | 31920011 | MOTOR REDUCER 45.K60 KIWI 12Nm 6 RPM |
| 2    | 39970010 | LIMIT SWITCH 5A 250V TINY            |



### ACTIVATION SOUPAPE AUTOMATIQUE

| POS. | CODE     | DESCRIPTION                          |
|------|----------|--------------------------------------|
| 1    | 31920011 | MOTOREDUCTEUR 45.K60 KIWI 12Nm 6 RPM |
| 2    | 39970010 | FIN DE COURSE 5A 250V EN MINIATURE   |



### AZIONAMENTO VALVULA AUTOMATICA

| POS. | CÓDIGO   | DESCRIPCIÓN                          |
|------|----------|--------------------------------------|
| 1    | 31920011 | MOTORREDUCTOR 45.K60 KIWI 12Nm 6 RPM |
| 2    | 39970010 | FINAL DE CARRERA 5A 250V MINÚSC.     |



### AUTOMATISCHE AKTIVIERUNG DES VENTILS

| POS. | CODE     | BESCHREIBUNG                         |
|------|----------|--------------------------------------|
| 1    | 31920011 | GETRIEBEMOTOR 45.K60 KIWI 12Nm 6 RPM |
| 2    | 39970010 | ENDSCHALTER 5A 250V MINIATUR         |

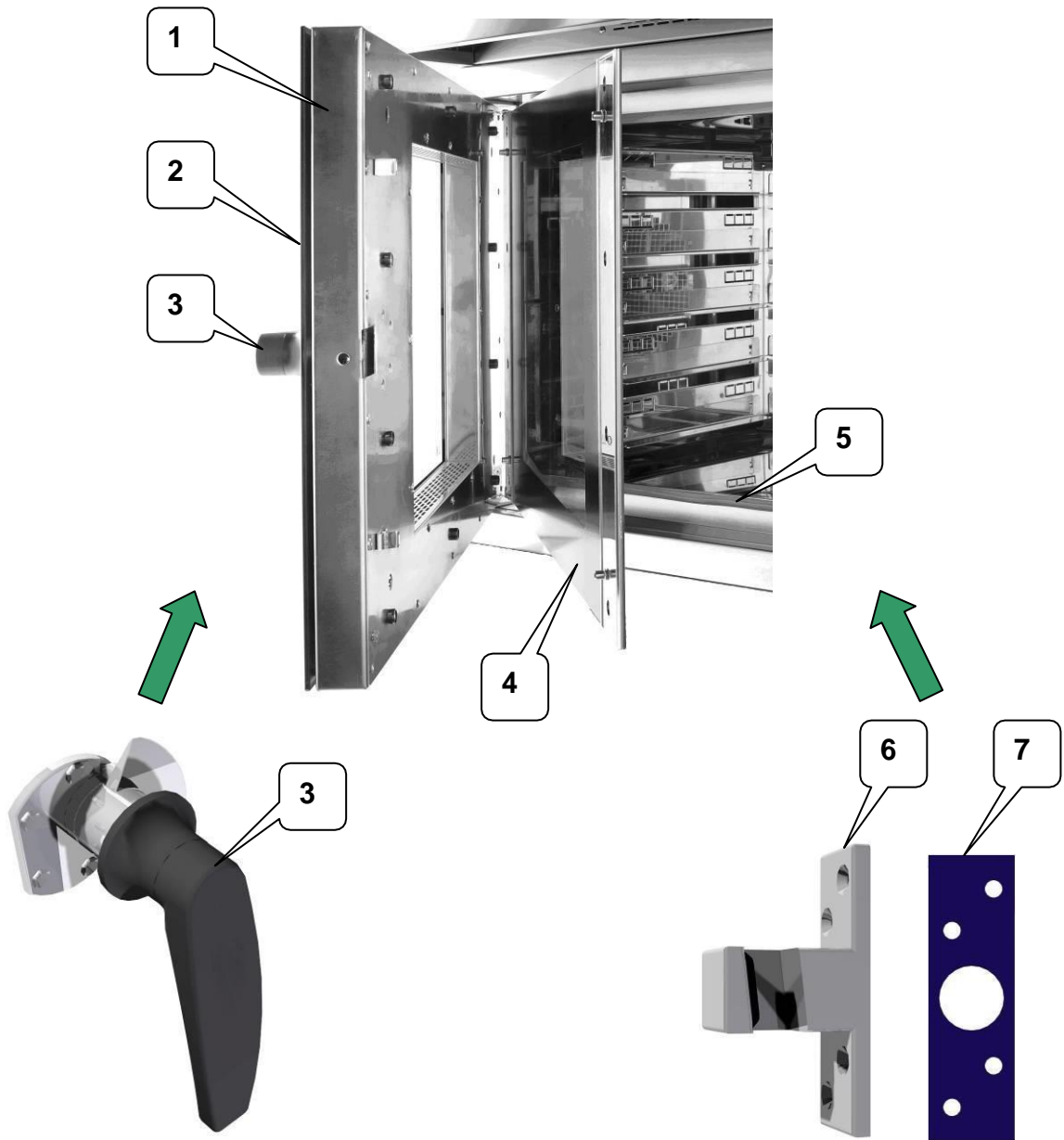

|  |          |   |  |
|---|----------|---|--|
| PORTA   |          |   |  |
| POS.  | CODICE   | DESCRIZIONE                                   |  |
| 1A  | 61001318 | PORTA COMPLETA K5T                            |  |
| 1B  | 61001319 | PORTA COMPLETA K10T                           |  |
| 2A  | 41000069 | VETRO ESTERNO TEMPERATO SERIGRAFATO K5T       |  |
| 2B  | 41000070 | VETRO ESTERNO TEMPERATO SERIGRAFATO K10T      |  |
| 3   | 54000040 | MANIGLIA COMPLETA                             |  |
| 4A  | 41000071 | VETRO INTERNO TEMPERATO K5T                   |  |
| 4B  | 41000072 | VETRO INTERNO TEMPERATO K10T                  |  |
| 5   | 43900067 | GUARNIZIONE SILICONE PORTA AL MT              |  |
| 6   | 54900224 | NASELLO (AGGANCIO MANIGLIA FISSATO SUL FORNO) |  |
| 7   | 21006432 | SPESSORE PER NASELLO                          |  |

**DOOR**

| POS. | CODE     | DESCRIPTION   |  |  |
|------|----------|---|--|--|
| 1A   | 61001318 | COMPLETE DOOR K5T                                       |  |  |
| 1B   | 61001319 | COMPLETE DOOR K10T                                      |  |  |
| 2A   | 41000069 | EXTERNAL DOOR TEMPERED GLASS PANE TOUGHENED K5T         |  |  |
| 2B   | 41000070 | EXTERNAL DOOR TEMPERED GLASS PANE TOUGHENED K10T        |  |  |
| 3    | 54000040 | COMPLETE DOOR HANDLE                                    |  |  |
| 4A   | 41000071 | INTERNAL DOOR TEMPERED GLASS PANE K5T                   |  |  |
| 4B   | 41000072 | INTERNAL DOOR TEMPERED GLASS PANE K10T                  |  |  |
| 5    | 43900067 | SILICONE DOOR GASKET PER MT                             |  |  |
| 6    | 54900224 | DOOR HANDLENOSE PIECE (HANDLE HOOKINGFIXED ON THE OVEN) |  |  |
| 7    | 21006432 | THICKNESS FOR DOOR NOSE PIECE                           |  |  |

**PORTE**

| POS. | CODE     | DESCRIPTION                                   |  |  |
|------|----------|---|--|--|
| 1A   | 61001318 | PORTE COMPLETE K5T                            |  |  |
| 1B   | 61001319 | PORTE COMPLETE K10T                           |  |  |
| 2A   | 41000069 | VITRE EXTERNE TREMPEE SERIGRAPHIEE K5T        |  |  |
| 2B   | 41000070 | VITRE EXTERNE TREMPEE SERIGRAPHIEE K10T       |  |  |
| 3    | 54000040 | POIGNEE COMPLETE                              |  |  |
| 4A   | 41000071 | VITRE INTERNE TREMPEE K5T                     |  |  |
| 4B   | 41000072 | VITRE INTERNE TREMPEE K10T                    |  |  |
| 5    | 43900067 | BOURRELET DE SILICONE POUR LA PORTE CHAQUE MT |  |  |
| 6    | 54900224 | ERGOT (ACCROCHAGE POIGNEE FIXE SUR LE FOUR)   |  |  |
| 7    | 21006432 | EPAISSEUR POUR ERGOT                          |  |  |

**PUERTA**

| POS. | CÓDIGO   | DESCRIPCIÓN                                       |  |  |
|------|----------|---|--|--|
| 1A   | 61001318 | PUERTA COMPLETA K5T                               |  |  |
| 1B   | 61001319 | PUERTA COMPLETA K10T                              |  |  |
| 2A   | 41000069 | VIDRIO EXTERNO TEMPLADO SERIGR. K5T               |  |  |
| 2B   | 41000070 | VIDRIO EXTERNO TEMPLADO SERIGR. K10T              |  |  |
| 3    | 54000040 | MANIJA COMPLETA                                   |  |  |
| 4A   | 41000071 | VIDRIO INTERNO TEMPLADO K5T                       |  |  |
| 4B   | 41000072 | VIDRIO INTERNO TEMPLADO K10T                      |  |  |
| 5    | 43900067 | GUARNICIÓN SILICONA PUERTA AL MT                  |  |  |
| 6    | 54900224 | GUIADOR (ENGANCHE MANIJA FIJADO ENCIMA DEL HORNO) |  |  |
| 7    | 21006432 | ESPEJOR PARA GUIADOR                              |  |  |

**TÜR**

| POS. | CODE     | BESCHREIBUNG  |  |  |
|------|----------|---|--|--|
| 1A   | 61001318 | TÜR KOMPLETT K5T  |  |  |
| 1B   | 61001319 | TÜR KOMPLETT K10T   |  |  |
| 2A   | 41000069 | TEMPERIERTES AUSSENGLAS SIEBDRUCK K5T                     |  |  |
| 2B   | 41000070 | TEMPERIERTES AUSSENGLAS SIEBDRUCK K10T                    |  |  |
| 3    | 54000040 | HANDGRIFF KOMPLETT  |  |  |
| 4A   | 41000071 | TEMPERIERTES INNENGLAS K5T                                |  |  |
| 4B   | 41000072 | TEMPERIERTES INNENGLAS K10T                               |  |  |
| 5    | 43900067 | SILIKONDICHTUNG ZUR TÜR JE MT                             |  |  |
| 6    | 54900224 | ARRETIERSTIFT (HANDGRIFFEINHÄNGEN AUF DEM OFEN BEFESTIGT) |  |  |
| 7    | 21006432 | DISTANZSCHEIBE FÜR ARRETIERSTIFT                          |  |  |

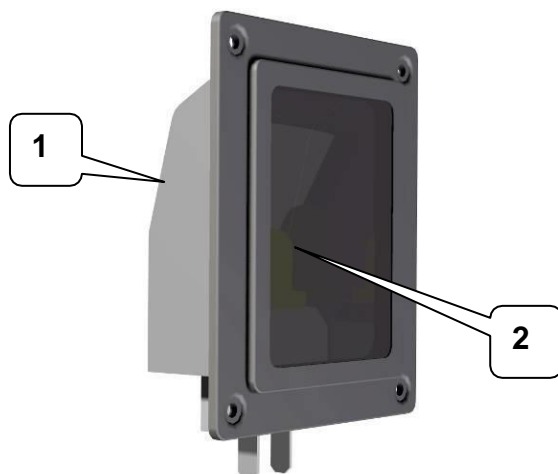

|  |          |  |  |
|---|----------|--|--|
| <b>LUCI</b>   |          |  |  |
| POS.  | CODICE   | DESCRIZIONE  |  |
| 1   | 39950035 | PORTALAMPADA PER LAMPADINA ALOGENA , COMPLETO DI VETRO E GUARNIZIONE |  |
| 2   | 39950038 | LAMPADINA ALOGENA G9 , 40W , 230V                                    |  |
| 2 B   | 39950046 | LAMPADINA INCANDESCENZA 25W 230V ATTACCO E14                         |  |
| 1 B   | 39950044 | PORTALAMPADA PER LAMPADINE ATTACCO E14                               |  |

|  |          |   |  |
|---|----------|---|--|
| <b>EXPLODED VIEW: LIGHTS</b>  |          |   |  |
| POS.  | CODE     | DESCRIPTION   |  |
| 1   | 39950035 | BULB HOLDER FOR HALOGENE LAMP, COMPLETE WITH GLASS AND GASKET |  |
| 2   | 39950038 | HALOGEN LAMP G9 , 40W , 230V                                  |  |
| 2B  | 39950046 | INCANDESCENT BULB 25W 230V ATTACHMENT E14                     |  |
| 1B  | 39950044 | LAMP HOLDER FOR BULB ATTACHMENT E14                           |  |

|  |          |  |  |
|---|----------|--|--|
| <b>VUE ECLATEE DES LUMIERES</b>   |          |  |  |
| POS.  | CODE     | DESCRIPTION  |  |
| 1   | 39950035 | DOUILLE POUR LAMPE HALOGENE, AVEC VERRE ET BOURRELET |  |
| 2   | 39950038 | AMPOULE HALOGENE G9 , 40W , 230V                     |  |
| 2 B   | 39950046 | AMPOULE INCANDESCENTE 25W 230V ATTACHE E14           |  |
| 1 B   | 39950044 | SUPPORT-LAMPE POUR AMPOULE ATTACHE E14               |  |

|  |          |  |  |
|---|----------|--|--|
| <b>VISTA DESPIEZADA DE LAS LUCES</b>  |          |  |  |
| POS.  | CÓDIGO   | DESCRIPCIÓN  |  |
| 1   | 39950035 | PORTALÁMPARAS PARA LÁMPARA DE HALÓGENO, COMPLETO CON VIDRIO Y GUARNICIÓN |  |
| 2   | 39950038 | LÁMPARA DE HALÓGENO G9 , 40W , 230V                                      |  |
| 2 B   | 39950046 | BOMBILLA INCANDESCENTE 25W 230V MONTAGE E14                              |  |
| 1 B   | 39950044 | PORTALAMPARA PARA BOMBILLA MONTAJE E14                                   |  |

|  |          |  |  |
|---|----------|--|--|
| <b>EXPLOSIONSZEICHNUNG FÜR LICHTER</b>  |          |  |  |
| POS.  | CODE     | BESCHREIBUNG   |  |
| 1   | 39950035 | LAMPENFASSUNG FÜR HALOGENLAMPE, KOMPLETT MIT GLAS UND DICHTUNG |  |
| 2   | 39950038 | HALOGENLAMPE G9 , 40W , 230V                                   |  |



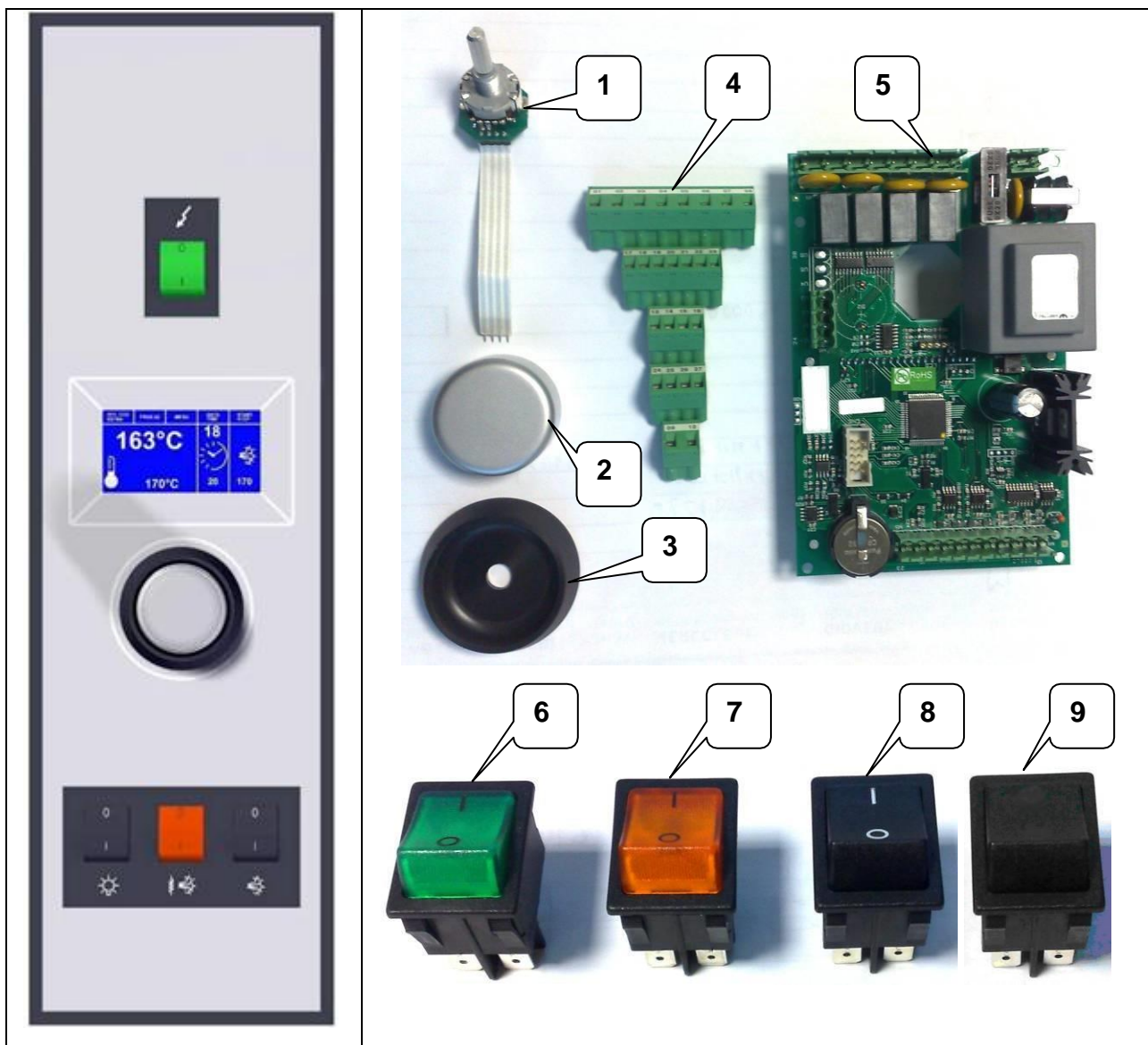

|  <b>PANNELLO A SCROLLER</b> |          |  |  |
|--|----------|--|--|
| POS.   | CODICE   | DESCRIZIONE                                      |  |
| 1  | 39080088 | ROTARY SWITCH 18 IMPULSI/GIRO                    |  |
| 2  | 39960081 | MANOPOLA DIAM. 40 PERNO D. 6 COLORE INOX         |  |
| 3  | 44000017 | RINFORZO MANOPOLA SCROLLER DIAM. 55X15           |  |
| 4  | 39080111 | MORSETTIERE PER CENTRALINA POLIFUNZIONALE        |  |
| 5  | 39080087 | SCHEDA CENTRALINA POLIFUNZIONALE S/MORS.         |  |
| 6  | 39960074 | INTERRUTTORE 0-1 LUMINOSO VERDE 250V BASCULA     |  |
| 7  | 39960073 | INTERRUTTORE 0-1 LUMINOSO ARANCIONE 250V BASCULA |  |
| 8  | 39960075 | INTERRUTTORE 0-1 NERO 250V BASCULA               |  |
| 9  | 39960076 | PULSANTE NERO 250V BASCULA                       |  |

**ROTARY SWITCH CONTROL PANEL**

|   |          |  |  |  |
|---|----------|--|--|--|
| 1 | 39080088 | ROTARY SWITCH 18 PULSES/REVOLUTION                     |  |  |
| 2 | 39960081 | SWITCH DIAM. 40 PIN D. 6 STAINLESS STEEL COLOUR        |  |  |
| 3 | 44000017 | STIFFENER FOR ROTARY SWITCH DIAM. 55X15                |  |  |
| 4 | 39080111 | TERMINAL STRIP FOR MULTIFUNCTION CENTRAL UNIT          |  |  |
| 5 | 39080087 | MULTIFUNCTION CENTRAL UNIT CARD WITHOUT TERMINAL STRIP |  |  |
| 6 | 39960074 | 0-1 LUMINOUS TOGGLE SWITCH GREEN 250V                  |  |  |
| 7 | 39960073 | 0-1 LUMINOUS TOGGLE SWITCH ORANGE 250V                 |  |  |
| 8 | 39960075 | 0-1 TOGGLE SWITCH BLACK 250V                           |  |  |
| 9 | 39960076 | 250V BLACK TOGGLE BUTTON                               |  |  |

**PANNEAU AVEC BOUTON MULTIFONCTION**

|   |          |   |  |  |
|---|----------|---|--|--|
| 1 | 39080088 | BOUTON MULTIFONCTION 18 PULSATIONS/ REVOLUTION  |  |  |
| 2 | 39960081 | BOUTON DIAM. 40 PIVOT D. 6 COULEUR INOX         |  |  |
| 3 | 44000017 | RENFORT BOUTON MULTIFONCTION DIAM. 55X15        |  |  |
| 4 | 39080111 | BORNIERS POUR CENTRALE MULTIFONCTION            |  |  |
| 5 | 39080087 | CARTE CENTRALE MULTIFONCTION SANS BORNIER       |  |  |
| 6 | 39960074 | INTERRUPTEUR A BASCULE 0-1 LUMINEUX VERT 250V   |  |  |
| 7 | 39960073 | INTERRUPTEUR A BASCULE 0-1 LUMINEUX ORANGE 250V |  |  |
| 8 | 39960075 | INTERRUPTEUR A BASCULE 0-1 NOIR 250V            |  |  |
| 9 | 39960076 | POUSSOIR NOIR 250V BASCULE                      |  |  |

**PANEL MANDO MULTIFUNCIÓN**

|   |          |  |  |  |
|---|----------|--|--|--|
| 1 | 39080088 | MANDO MULTIFUNCIÓN 18 PULSACIONES/REVOLUCIÓN                 |  |  |
| 2 | 39960081 | MANDO DIÁM. 40 PERNO D. 6 COLOR INOX                         |  |  |
| 3 | 44000017 | REFUERZO MANDO MULTIFUNCIÓN DIÁM. 55X15                      |  |  |
| 4 | 39080111 | REGLETAS DE BORNES PARA CIRCUITO DE CONTROL MULTIFUNCIÓN     |  |  |
| 5 | 39080087 | FICHA CIRCUITO DE CONTROL MULTIFUNCIÓN SIN REGLETA DE BORNES |  |  |
| 6 | 39960074 | INTERRUPTOR BASCULANTE 0-1 LUMINOSO VERDE 250V               |  |  |
| 7 | 39960073 | INTERRUPTOR BASCULANTE 0-1 LUMINOSO NARANJA 250V             |  |  |
| 8 | 39960075 | INTERRUPTOR BASCULANTE 0-1 NEGRO 250V                        |  |  |
| 9 | 39960076 | PULSADOR NEGRO 250V BASCULANTE                               |  |  |

**ROTARY-SWITCH-PANEL**

|   |          |  |  |  |
|---|----------|--|--|--|
| 1 | 39080088 | ROTARY SWITCH 18 IMPULSE/UMDREHUNG                         |  |  |
| 2 | 39960081 | GRIFF DURCHM. 40 ZAPFEN D. 6 FARBE ROSTFREIER STAHL        |  |  |
| 3 | 44000017 | VERSTÄRKUNG ZUM GRIFF DURCHM. 55X15                        |  |  |
| 4 | 39080111 | KLEMMLEISTEN FÜR POLYFUNKTIONELLEN SCHALTKASTEN            |  |  |
| 5 | 39080087 | KARTE ZUM POLYFUNKTIONELLEN SCHALTKASTEN OHNE KLEMMLEISTE. |  |  |
| 6 | 39960074 | LEUCHT- TOGGLE SCHALTER 0-1 GRÜN 250V                      |  |  |
| 7 | 39960073 | LEUCHT- TOGGLE SCHALTER 0-1 ORANGE 250V                    |  |  |
| 8 | 39960075 | LEUCHT- TOGGLE SCHALTER 0-1 SCHWARZ 250V                   |  |  |
| 9 | 39960076 | LEUCHT- TOGGLE DRUCKTASTE SCHWARZ 250V                     |  |  |

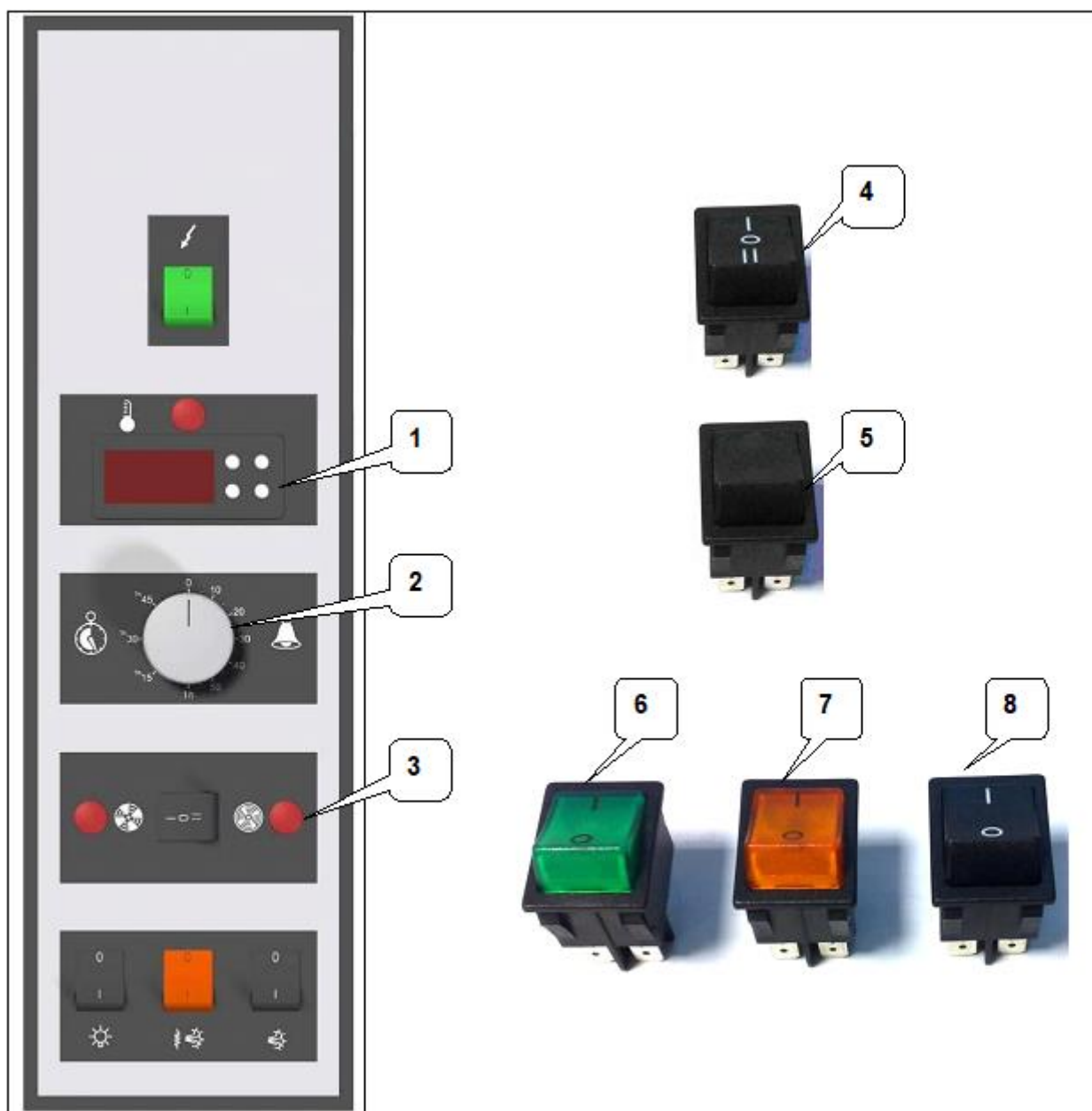

|  <b>PANNELLO ELETTROMECCANICO</b> |          |  |
|--|----------|--|
| POS.   | CODICE   | DESCRIZIONE                                      |
| 1  | 35000021 | TERMOREGOLATORE MOD. TLK 38HRC 230V              |
| 2  | 35900023 | TIMER CONTAMINUTI CON SUONERIA FINE COTTURA      |
| 3  | 39950013 | LAMPADINA SPIA SIGNALUX 230V ROSSA               |
| 4  | 39960077 | INTERRUTTORE 1-0-2 NERO 250V BASCULA             |
| 5  | 39960076 | PULSANTE NERO 250V BASCULA                       |
| 6  | 39960074 | INTERRUTTORE 0-1 LUMINOSO VERDE 250V BASCULA     |
| 7  | 39960073 | INTERRUTTORE 0-1 LUMINOSO ARANCIONE 250V BASCULA |
| 8  | 39960075 | INTERRUTTORE 0-1 NERO 250V BASCULA               |

**ELECTROMECHANICAL PANEL**

| POS. | CODE     | DESCRIPTION                                    |  |  |
|------|----------|--|--|--|
| 1    | 35000021 | THERMOREGULATOR MOD.TLK 38HRC 230V             |  |  |
| 2    | 35900023 | MINUTE COUNTER TIMER WITH END-OF-BAKING BUZZER |  |  |
| 3    | 39950013 | TELLTALE LIGHT BULB SIGNALUX 230V RED          |  |  |
| 4    | 39960077 | 1-0-2 250V BLACK TOGGLE SWITCH                 |  |  |
| 5    | 39960076 | 250V BLACK TOGGLE BUTTON                       |  |  |
| 6    | 39960074 | LUMINOUS 0-1 GREEN 250V TOGGLE SWITCH          |  |  |
| 7    | 39960073 | LUMINOUS 0-1 ORANGE 250V TOGGLE SWITCH         |  |  |
| 8    | 39960075 | 0-1 BLACK 250V TOGGLE SWITCH                   |  |  |

**TABLEAU ELECTROMECHANIQUE**

| POS. | CODE     | DESCRIPTION                                   |  |  |
|------|----------|---|--|--|
| 1    | 35000021 | THERMOREGULATEUR MOD.TLK 38HRC 230V           |  |  |
| 2    | 35900023 | MINUTERIE AVEC SONNERIE DE FIN DE CUISSON     |  |  |
| 3    | 39950013 | LAMPE POUR VOYANT SIGNALUX 230V ROUGE         |  |  |
| 4    | 39960077 | INTERRUPTEUR 1-0-2 NOIR 250V BASCULE          |  |  |
| 5    | 39960076 | POUSSOIR NOIR 250V BASCULE                    |  |  |
| 6    | 39960074 | INTERRUPTEUR 0-1 LUMINEUX VERT 250V BASCULE   |  |  |
| 7    | 39960073 | INTERRUPTEUR 0-1 LUMINEUX ORANGE 250V BASCULE |  |  |
| 8    | 39960075 | INTERRUPTEUR 0-1 NOIR 250V BASCULE            |  |  |

**PANEL DE MANDOS ELECTROMECHANICO**

| POS. | CÓDIGO   | DESCRIPCIÓN   |  |  |
|------|----------|---|--|--|
| 1    | 35000021 | TERMORREGULADOR MOD.TLK 38HRC 230V                                  |  |  |
| 2    | 35900023 | TEMPORIZADOR CUENTA-MINUTOS CON ZUMBADOR DE FINALIZACIÓN DE COCCIÓN |  |  |
| 3    | 39950013 | LÁMPARA INDICADOR LUMINOSO SIGNALUX 230V ROJA                       |  |  |
| 4    | 39960077 | INTERRUPTOR 1-0-2 NEGRO 250V BASCULANTE                             |  |  |
| 5    | 39960076 | PULSADOR NEGRO 250V BASCULANTE                                      |  |  |
| 6    | 39960074 | INTERRUPTOR 0-1 LUMINOSO VERDE 250V BASCULANTE                      |  |  |
| 7    | 39960073 | INTERRUPTOR 0-1 LUMINOSO NARANJA 250V BASCULANTE                    |  |  |
| 8    | 39960075 | INTERRUPTOR 0-1 NEGRO 250V BASCULANTE                               |  |  |

**ELEKTROMECHANISCHE STEUERUNG**

| POS. | CODE     | BESCHREIBUNG  |  |  |
|------|----------|---|--|--|
| 1    | 35000021 | TEMPERATURREGLER MOD.TLK 38HRC 230V                     |  |  |
| 2    | 35900023 | MINUTENTIMER MIT CON LÄUTWERK ZUM ENDE DES BACKVORGANGS |  |  |
| 3    | 39950013 | LAMPE ZUR KONTROLLLEUCHTE SIGNALUX 230V ROT             |  |  |
| 4    | 39960077 | LEUCHT-TOGGLE SCHALTER 1-0-2 SCHWARZ 250V               |  |  |
| 5    | 39960076 | LEUCHT-TOGGLE DRUCKTASTE SCHWARZ 250V                   |  |  |
| 6    | 39960074 | LEUCHT – TOGGLE WAHLSCHALTER 0-1 GRÜN 250V              |  |  |
| 7    | 39960073 | LEUCHT – TOGGLE WAHLSCHALTER ORANGE 250V                |  |  |
| 8    | 39960075 | LEUCHT – TOGGLE WAHLSCHALTER 0-1 SCHWARZ 250V           |  |  |

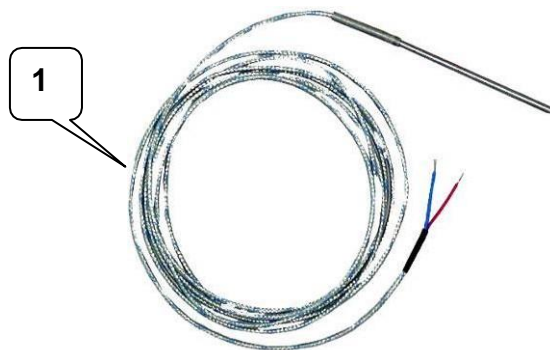

|   |          |                            |  |
|---|----------|----------------------------|--|
|  |          |                            |  |
| <b>TERMOCOPPIA - TERMOSTATO SICUREZZA CAMERA - TERMOSTATI FUMI</b>                |          |                            |  |
| POS.  | CODICE   | DESCRIZIONE                |  |
| 1   | 39970050 | TERMOCOPPIA 8X100 , L=2000 |  |

|   |          |                             |  |
|---|----------|-----------------------------|--|
|  |          |                             |  |
| <b>THERMOCOUPLE - CHAMBER SAFETY THERMOSTAT - FUMES THERMOSTATS</b>                 |          |                             |  |
| POS.  | CODE     | DESCRIPTION                 |  |
| 1   | 39970050 | THERMOCOUPLE 8X100 , L=2000 |  |

|   |          |                             |  |
|---|----------|-----------------------------|--|
|  |          |                             |  |
| <b>THERMOCOUPLE - THERMOSTAT DE SECURITE DE LA CHAMBRE - THERMOSTATS DES FUMES</b>  |          |                             |  |
| POS.  | CODE     | DESCRIPTION                 |  |
| 1   | 39970050 | THERMOCOUPLE 8X100 , L=2000 |  |

|   |          |                         |  |
|---|----------|-------------------------|--|
|  |          |                         |  |
| <b>TERMOPAR - TERMOSTATO DE SEGURIDAD DE LA CAMARA - TERMOSTATOS DE HUMOS</b>       |          |                         |  |
| POS.  | CÓDIGO   | DESCRIPCIÓN             |  |
| 1   | 39970050 | TERMOPAR 8X100 , L=2000 |  |

|   |          |                              |  |
|---|----------|------------------------------|--|
|  |          |                              |  |
| <b>THERMOPAAR - THERMOSTAT FÜR KAMMERSICHERHEIT - RAUCHTHERMOSTATE</b>              |          |                              |  |
| POS.  | CODE     | BESCHREIBUNG                 |  |
| 1   | 39970050 | THERMOELEMENT 8X100 , L=2000 |  |

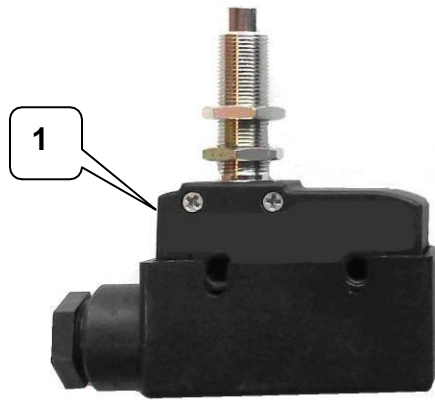

**FINECORSA PORTA**

| POS. | CODICE   | DESCRIZIONE     |  |
|------|----------|-----------------|--|
| 1    | 39970053 | FINECORSA PORTA |  |



**DOOR LIMIT SWITCH**

| POS. | CODE     | DESCRIPTION       |  |
|------|----------|-------------------|--|
| 1    | 39970053 | DOOR LIMIT SWITCH |  |



**FIN DE COURSE DE LA PORTE**

| POS. | CODE     | DESCRIPTION         |  |
|------|----------|---------------------|--|
| 1    | 39970053 | FIN DE COURSE PORTE |  |



**FINAL DE CARRERA PUERTA**

| POS. | CÓDIGO   | DESCRIPCIÓN             |  |
|------|----------|-------------------------|--|
| 1    | 39970053 | FINAL DE CARRERA PUERTA |  |





**TÜRENDSCHALTER**

| POS. | CODE     | BESCHREIBUNG   |  |
|------|----------|----------------|--|
| 1    | 39970053 | ENDCHALTER TÜR |  |

1



|   |          |   |  |
|---|----------|---|--|
|  |          |   |  |
| <b>ISOLANTI</b>   |          |   |  |
| POS.  | CODICE   | DESCRIZIONE                                       |  |
| 1   | 43900017 | PANNELLO ALTA TEMPERATURA 1000X600X40 DENSITA' 80 |  |
| 1   | 43900026 | PANNELLO ALTA TEMPERATURA 1000X600X30 DENSITA' 80 |  |

|   |          |   |  |
|---|----------|---|--|
|  |          |   |  |
| <b>INSULATORS</b>   |          |   |  |
| POS.  | CODE     | DESCRIPTION   |  |
| 1   | 43900017 | PANEL RESISTANT TO HIGH TEMPERATURES 1000X600X40 DENSITY 80 |  |
| 1   | 43900026 | PANEL RESISTANT TO HIGH TEMPERATURE 1000X600X30 DENSITY 80  |  |

|  |          |  |  |
|--|----------|--|--|
|  |          |  |  |
| <b>MATERIELS ISOLANTS</b>  |          |  |  |
| POS.   | CODE     | DESCRIPTION                                      |  |
| 1  | 43900017 | PANNEAU HAUTE TEMPERATURE 1000X600X40 DENSITE 80 |  |
| 1  | 43900026 | PANNEAU HAUTE TEMPERATURE 1000X600X30 DENSITE 80 |  |

|   |          |  |  |
|---|----------|--|--|
|  |          |  |  |
| <b>MATERIALES AISLANTES</b>   |          |  |  |
| POS.  | CÓDIGO   | DESCRIPCIÓN                                    |  |
| 1   | 43900017 | PANEL ALTA TEMPERATURA 1000X600X40 DENSIDAD 80 |  |
| 1   | 43900026 | PANEL ALTA TEMPERATURA 1000X600X30 DENSIDAD 80 |  |

|   |          |   |  |
|---|----------|---|--|
|  |          |   |  |
| <b>ISOLATIONSMATERIALIEN</b>  |          |   |  |
| POS.  | CODE     | BESCHREIBUNG                                      |  |
| 1   | 43900017 | TEMPERATURBESTÄNDIGES PANEEL 1000X600X40 DICHT 80 |  |
| 1   | 43900026 | TEMPERATURBESTÄNDIGES PANEEL 1000X600X30 DICHT 80 |  |

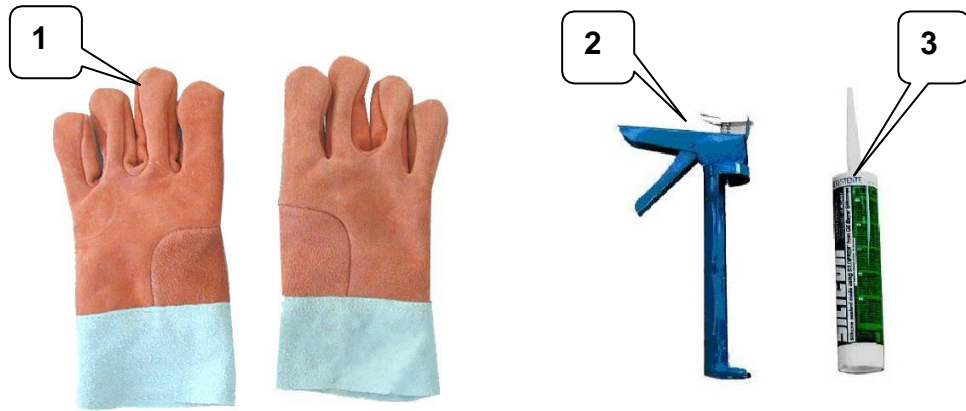

|  |          |   |  |
|---|----------|---|--|
| <b>ACCESSORI</b>  |          |   |  |
| POS.  | CODICE   | DESCRIZIONE   |  |
| 1   | 54900007 | GUANTI ANTICALORE FODERATI  |  |
| 2   | 54900002 | PISTOLA PER SILICONE  |  |
| 3   | 43900008 | SILICONE ACETATO TERMORESISTENTE CARTUCCIA 310 PER ALTE TEMPERATURE |  |

|  |          |  |  |
|---|----------|--|--|
| <b>ACCESSORIES</b>  |          |  |  |
| POS.  | CODE     | DESCRIPTION  |  |
| 1   | 54900007 | HEAT RESISTANT LINED GLOVES  |  |
| 2   | 54900002 | SILICONE GUN   |  |
| 3   | 43900008 | HEAT-RESISTANT ACETATE SILICONE, CARTRIDGE 310 FOR HIGH TEMPERATURES |  |

|  |          |   |  |
|---|----------|---|--|
| <b>ACCESSOIRES</b>  |          |   |  |
| POS.  | CODE     | DESCRIPTION   |  |
| 1   | 54900007 | GANTS RESISTANTS A LA CHALEUR DOUBLES                                 |  |
| 2   | 54900002 | PISTOLET POUR SILICONE  |  |
| 3   | 43900008 | SILICONE ACET. THERMORESISTANT CARTOUCHE 310 POUR HAUTES TEMPERATURES |  |

|  |          |   |  |
|---|----------|---|--|
| <b>ACCESORIOS</b>   |          |   |  |
| POS.  | CÓDIGO   | DESCRIPCIÓN   |  |
| 1   | 54900007 | GUANTES REVESTIDOS RESISTENTES AL CALOR                             |  |
| 2   | 54900002 | PISTOLA PARA SILICONA   |  |
| 3   | 43900008 | SILICONA ACÉT. TERMORESISTENTE CARTUCHO 310 PARA ALTAS TEMPERATURAS |  |

|  |          |  |  |
|---|----------|--|--|
| <b>ZUBEHÖR</b>  |          |  |  |
| POS.  | CODE     | BESCHREIBUNG   |  |
| 1   | 54900007 | HITZERESISTENTE GEFÜTTERTE HANDSCHUHE                              |  |
| 2   | 54900002 | SILIKONPISTOLE   |  |
| 3   | 43900008 | ACET. SILIKON THERMORESISTENTE KARTUSCHE 310 FÜR HOHE TEMPERATUREN |  |



**CELLE  
PROVERS  
ETUVES  
ESTUFAS  
SCHRÄNKE**

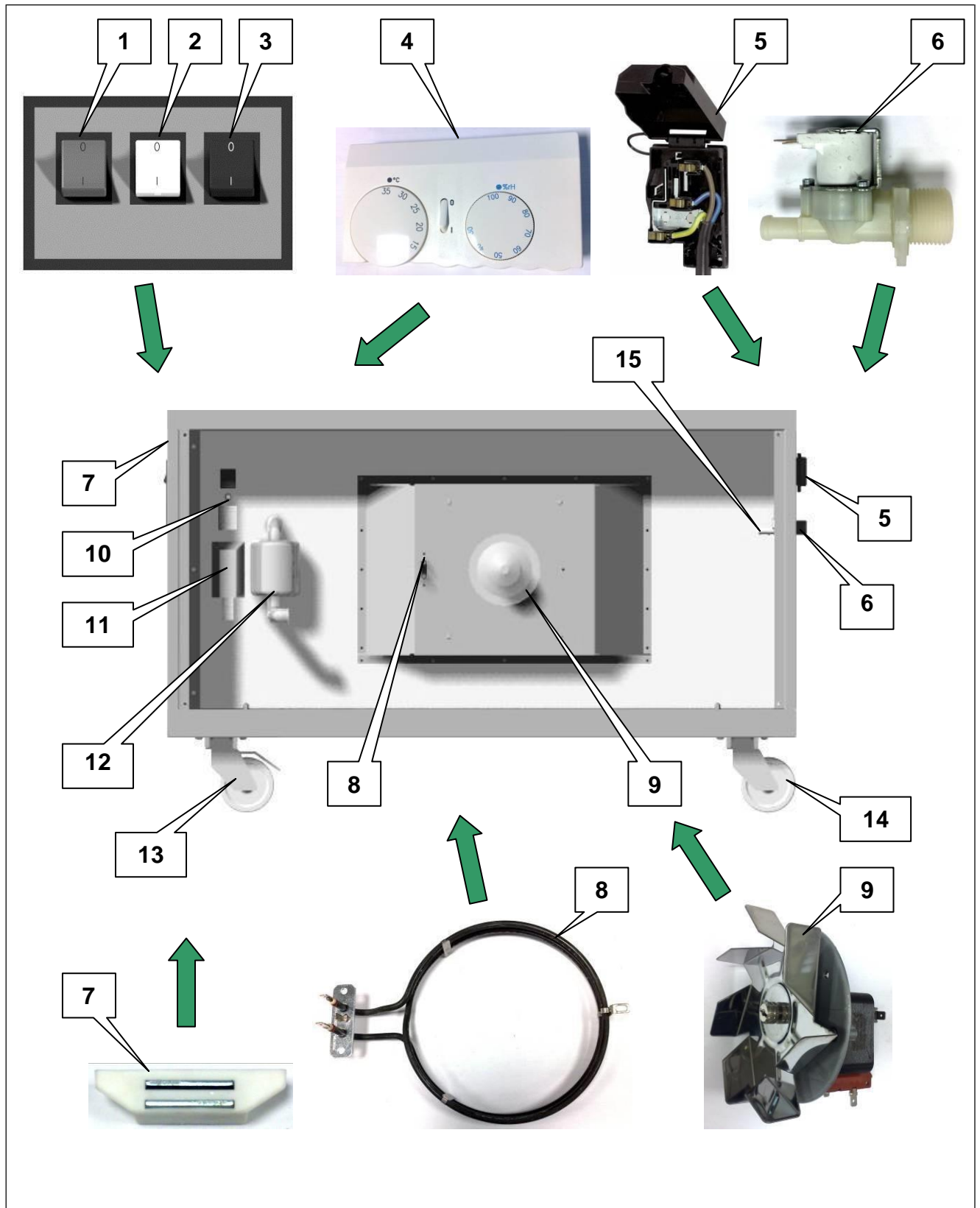

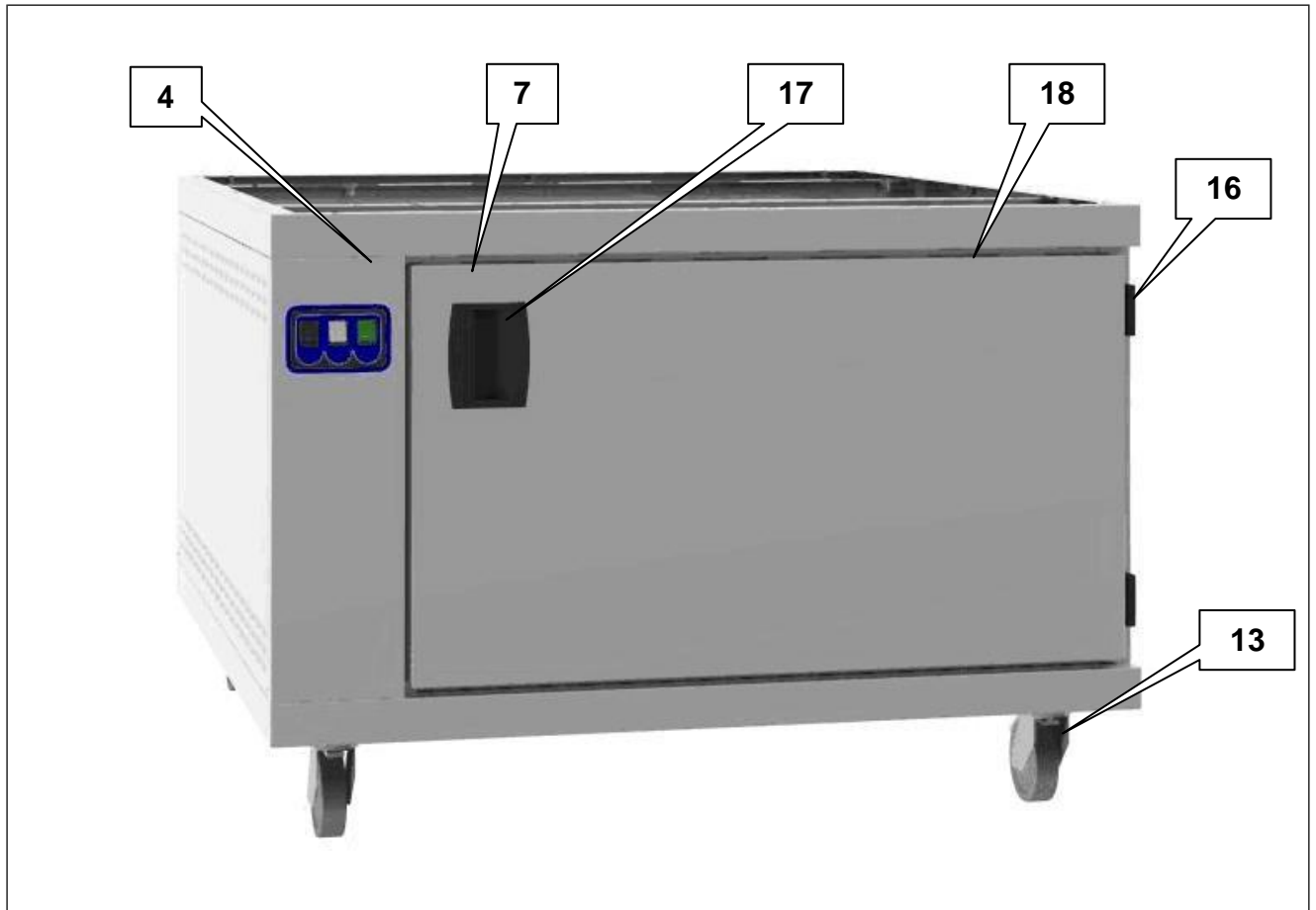

**Generatore di vapore completo di termostati INDIVISIBILE**  
**Steam generator complete with thermostats (IT CANNOT BE SEPARATED)**  
**Générateur de vapeur complet avec thermostats (INDIVISIBLE)**  
**Generador de vapor completo con termostatos (INDIVISIBLE)**  
**Dampferzeuger komplett mit Thermostaten (UNTRENNBAR)**

**CELLE**

| POS. | CODICE               | DESCRIZIONE  |  |  |
|------|----------------------|--|--|--|
| 1    | 39960074             | INTERRUTTORE 0-1 LUMINOSO VERDE 250V BASCULA                             |  |  |
| 2    | 39960073             | INTERRUTTORE 0-1 LUMINOSO ARANCIONE 250V BASCULA                         |  |  |
| 3    | 39960075             | INTERRUTTORE 0-1 NERO 250V BASCULA                                       |  |  |
| 4    | 39970020             | TERMO-IGROSTATO UR % / °C  |  |  |
| 5    | 39080083             | MORSETTIERA AD20   |  |  |
| 6    | 55900094<br>55900133 | ELETTROVALVOLA COD104 230V(V250-CELLE/V)<br>+ RIDUTTORE DI PORTATA VERDE |  |  |
| 7    | 45900010             | MAGNETE PER CHIUSURA PORTE   |  |  |
| 8    | 33010039             | RESISTENZA ELETTRICA DIAM. .. 240V 1000W                                 |  |  |
| 9    | 31900066             | MOTO-VENTILATORE PER CELLA   |  |  |
| 10   | 39950034             | LAMPADINA SPIA SIGNALUX 230V VERDE                                       |  |  |
| 11   | 39950037             | LAMPADA  |  |  |
| 11   | 39950031             | PORTALAMPADA   |  |  |
| 12   | 33010063             | GENERATORE VAPORE 1000W-230V (COMPLETO DI TERMOSTATI )                   |  |  |
| 13   | 54900195             | RUOTE SNODATE DIAM. 100 CON FRENO  |  |  |
| 14   | 54900194             | RUOTE SNODATE DIAM. 100  |  |  |
| 15   | 55900150             | TUBO GOMMA MULTIFORM GIALLO 10X20 (FORNITURA MINIMA 1MT)                 |  |  |
| 15   | 54900009             | FASCETTE STRINGITUBO PER TUBO GOMMA                                      |  |  |
| 16   | 45900011             | CERNIERA NERA PER PORTA  |  |  |
| 17   | 44900001             | MANIGLIA NERA DA INCASSO   |  |  |
| 18   | 43000020             | GUARNIZIONE BIANCA ADESIVA PER CELLA                                     |  |  |

**PROVERS**

| POS. | CODICE               | DESCRIZIONE  |  |  |
|------|----------------------|--|--|--|
| 1    | 39960074             | 0-1 LUMINOUS TOGGLE SWITCH GREEN 250V                              |  |  |
| 2    | 39960073             | 0-1 LUMINOUS TOGGLE SWITCH ORANGE 250V                             |  |  |
| 3    | 39960075             | 0-1 TOGGLE SWITCH BLACK 250V                                       |  |  |
| 4    | 39970020             | HYGRO-THERMOSTAT RELATIVE HUMIDITY % / °C                          |  |  |
| 5    | 39080083             | TERMINAL STRIP AD20  |  |  |
| 6    | 55900094<br>55900133 | SOLENOID VALVE COD104 230V(V250-PROVERS/V)<br>+ FLOW REDUCER GREEN |  |  |
| 7    | 45900010             | MAGNET FOR DOOR LOCK   |  |  |
| 8    | 33010039             | ELECTRIC HEATING ELEMENT DIAM. .. 240V 1000W                       |  |  |
| 9    | 31900066             | FAN MOTOR FOR PROVER   |  |  |
| 10   | 39950034             | LIGHT BULB FOR WARNING LIGHT SIGNALUX 230V GREEN                   |  |  |
| 11   | 39950037             | LAMP   |  |  |
| 11   | 39950031             | LAMP HOLDER  |  |  |
| 12   | 33010063             | STEAMGENERATOR 1000W-230V (COMPLETE WITH THERMOSTATS )             |  |  |
| 13   | 54900195             | SWIVEL WHEELS DIAM. 100 WITH BRAKE                                 |  |  |
| 14   | 54900194             | SWIVEL WHEELS DIAM. 100  |  |  |
| 15   | 55900150             | RUBBER TUBE MULTIFORM YELLOW 10X20 (MINIMUM SUPPLY 1MT)            |  |  |
| 15   | 54900009             | HOSE CPLAMPS FOR RUBBER TUBE                                       |  |  |
| 16   | 45900011             | BLACK HINGE FOR DOORS  |  |  |
| 17   | 44900001             | BUILT-IN BLACK HANDLE  |  |  |
| 18   | 43000020             | WHITE ADHESIVE GASKET FOR PROVER                                   |  |  |

**ETUVES**

| POS. | CODE                 | DESCRIPTION   |  |  |
|------|----------------------|---|--|--|
| 1    | 39960074             | INTERRUPTEUR A BASCULE 0-1 LUMINEUX VERT 250V                       |  |  |
| 2    | 39960073             | INTERRUPTEUR A BASCULE 0-1 LUMINEUX ORANGE 250V                     |  |  |
| 3    | 39960075             | INTERRUPTEUR A BASCULE 0-1 NOIR 250V                                |  |  |
| 4    | 39970020             | HYGRO- THERMOSTAT HUMIDITE RELATIVE % / °C                          |  |  |
| 5    | 39080083             | BORNIER AD20  |  |  |
| 6    | 55900094<br>55900133 | ELETTROVANNE COD104 230V(V250-ETUVES/V)<br>+ LIMITEUR DE FLUXE VERT |  |  |
| 7    | 45900010             | AIMANT POUR VERROUILLAGE PORTES                                     |  |  |
| 8    | 33010039             | RESISTANCE ELECTRIQUE DIAM. .. 240V 1000W                           |  |  |
| 9    | 31900066             | MOTO-VENTILATEUR POUR ETUVE   |  |  |
| 10   | 39950034             | LAMPE INDICATEUR SIGNALUX 230V VERT                                 |  |  |
| 11   | 39950037             | LAMPE   |  |  |
| 11   | 39950031             | PORTELAMPE  |  |  |
| 12   | 33010063             | GENERATEUR VAPEUR 1000W-230V (COMPLET AVEC THERMOSTATS )            |  |  |
| 13   | 54900195             | ROUES ARTICULEES DIAM. 100 AVEC FREIN                               |  |  |
| 14   | 54900194             | ROUES ARTICULEES DIAM. 100  |  |  |
| 15   | 55900150             | TUBE CAOUTCHOUC MULTIFORM JAUNE 10X20 (FOURNITURE MINIMUM 1MT)      |  |  |
| 15   | 54900009             | BAGUES SERRE-TUBE POUR TUBE CAOUTCHOUC                              |  |  |
| 16   | 45900011             | CHARNIERE NOIRE POUR PORTE  |  |  |
| 17   | 44900001             | POIGNEE NOIRE A ENCASTRER   |  |  |
| 18   | 43000020             | BOURRELET BLANC ADHESIF POUR ETUVE                                  |  |  |

**ESTUFAS**

| POS. | CÓDIGO               | DESCRIPCIÓN   |  |  |
|------|----------------------|---|--|--|
| 1    | 39960074             | INTERRUPTOR BASCULANTE 0-1 LUMINOSO VERDE 250V                            |  |  |
| 2    | 39960073             | INTERRUPTOR BASCULANTE 0-1 LUMINOSO NARANJA 250V                          |  |  |
| 3    | 39960075             | INTERRUPTOR BASCULANTE 0-1 NEGRO 250V                                     |  |  |
| 4    | 39970020             | HIGRÓSTATO TÉRMICO HUMEDAD ELATIVA % / °C                                 |  |  |
| 5    | 39080083             | REGLETA DE BORNES AD20  |  |  |
| 6    | 55900094<br>55900133 | ELETTROVÁLVULA CÓD 104 230V(V250-ESTUFAS/V)<br>+ LIMITADOR DE FLUJO VERDE |  |  |
| 7    | 45900010             | IMANE PARA CIERRE PUERTAS   |  |  |
| 8    | 33010039             | RESISTENCIA ELÉCTRICA DIÁM. .. 240V 1000W                                 |  |  |
| 9    | 31900066             | MOTO-VENTILADOR PARA ESTUFA   |  |  |
| 10   | 39950034             | BOMBILLA INDICADOR SIGNALUX 230V VERDE                                    |  |  |
| 11   | 39950037             | LÁMPARA   |  |  |
| 11   | 39950031             | PORTALÁMPARA  |  |  |
| 12   | 33010063             | GENERADOR DE VAPOR 1000W-230V (COMPLETO CON THERMOSTATOS )                |  |  |
| 13   | 54900195             | RUEDAS ARTICULADAS DIÁM. 100 CON FRENO                                    |  |  |
| 14   | 54900194             | RUEDAS ARTICULADAS DIÁM. 100  |  |  |
| 15   | 55900150             | TUBO GOMA MULTIFORM AMARILLO 10X20 (SUMINISTRO MÍNIMO 1MT)                |  |  |
| 15   | 54900009             | ABRAZADERAS APRIETA TUBOS PARA TUBO GOMA                                  |  |  |
| 16   | 45900011             | BISAGRA NEGRA PARA PUERTA   |  |  |
| 17   | 44900001             | MANIJA NEGRA DE ENCAJE  |  |  |
| 18   | 43000020             | GUARNICIÓN BLANCA ENGOMADA PARA ESTUFA                                    |  |  |





## GÄRSCHRÄNKE

| POS. | CODE                 | BESCHREIBUNG   |  |  |
|------|----------------------|--|--|--|
| 1    | 39960074             | TOGGLE- LEUCHTSCHALTER 0-1 GRÜN 250V                                       |  |  |
| 2    | 39960073             | TOGGLE- LEUCHTSCHALTER 0-1 ORANGE 250V                                     |  |  |
| 3    | 39960075             | TOGGLESCHALTER 0-1 SCHWARZ 250V  |  |  |
| 4    | 39970020             | THERMO-HYGROSTAT RELATIVE LUFTFEUCHTIGKEIT % / °C                          |  |  |
| 5    | 39080083             | KLEMMLEISTE AD20   |  |  |
| 6    | 55900094<br>55900133 | ELETTROVENTIL COD104 230V(V250-GÄRSCHRÄNKE/V)<br>+ STROMUNGSBEGRENZER GRÜN |  |  |
| 7    | 45900010             | MAGNET ZUR TÜRVERSCHLUSS   |  |  |
| 8    | 33010039             | HEIZWIDERSTAND DURCHM. .. 240V 1000W                                       |  |  |
| 9    | 31900066             | MOTO-VENTILATOR FÜR GÄRSCHRANK   |  |  |
| 10   | 39950034             | GLÜHLAMPE FÜR KONTROLLLEUCHE SIGNALUX 230V GRÜN                            |  |  |
| 11   | 39950037             | GLÜHLAMPE  |  |  |
| 11   | 39950031             | LAMPENFASSUNG  |  |  |
| 11   | 33010063             | DAMPFERZEUGER 1000W-230V (KOMPLETT MIT THERMOSTATEN )                      |  |  |
| 12   | 54900195             | LENKRÄDER DURCHM. 100 MIT BREMSE   |  |  |
| 13   | 54900194             | LENKRÄDER DURCHM. 100  |  |  |
| 14   | 55900150             | GUMMIROHR MULTIFORM GELB 10X20 (MINDESTLIEFERUNG 1MT)                      |  |  |
| 15   | 54900009             | ROHRSCHELLEN FÜR GUMMIROHR   |  |  |
| 15   | 45900011             | SCHARZES SCHARNIER FÜR TÜR   |  |  |
| 16   | 44900001             | SCHWARZER EINBAUHANDGRIFF  |  |  |
| 17   | 43000020             | WEISSE DICHTUNG KLEBEND FÜR GÄRSCHRANK                                     |  |  |
| 18   | 39960074             | TOGGLE-LEUCHTSCHALTER 0-1 GRÜN 250V  |  |  |

**CAVALLETTI  
STANDS  
SUPPORTS  
SOPORTES  
HALTERUNGEN**



|   |          |                                   |  |
|---|----------|-----------------------------------|--|
|  |          |                                   |  |
| <b>CAVALLETTI</b>   |          |                                   |  |
| POS.  | CODICE   | DESCRIZIONE                       |  |
| 1   | 54900195 | RUOTE SNODATE DIAM. 100 CON FRENO |  |
| 2   | 54900194 | RUOTE SNODATE DIAM. 100           |  |

|   |          |                                    |  |
|---|----------|------------------------------------|--|
|  |          |                                    |  |
| <b>STANDS</b>   |          |                                    |  |
| POS.  | CODE     | DESCRIPTION                        |  |
| 1   | 54900195 | SWIVEL WHEELS DIAM. 100 WITH BRAKE |  |
| 2   | 54900194 | SWIVEL WHEELS DIAM. 100            |  |

|   |          |                                       |  |
|---|----------|---------------------------------------|--|
|  |          |                                       |  |
| <b>SUPPORTS</b>   |          |                                       |  |
| POS.  | CODE     | DESCRIPTION                           |  |
| 1   | 54900194 | ROUES ARTICULEES DIAM. 100 AVEC FREIN |  |
| 2   | 54900204 | ROUES ARTICULEES DIAM. 100            |  |

|   |          |  |  |
|---|----------|--|--|
|  |          |  |  |
| <b>SOPORTES</b>   |          |  |  |
| POS.  | CÓDIGO   | DESCRIPCIÓN                            |  |
| 1   | 54900195 | RUEDAS ARTICULADAS DIÁM. 100 CON FRENO |  |
| 2   | 54900194 | RUEDAS ARTICULADAS DIÁM. 100           |  |

|   |          |                                  |  |
|---|----------|----------------------------------|--|
|  |          |                                  |  |
| <b>HALTERUNGEN</b>  |          |                                  |  |
| POS.  | CODE     | BESCHREIBUNG                     |  |
| 1   | 54900195 | LENKRÄDER DURCHM. 100 MIT BREMSE |  |
| 2   | 54900194 | LENKRÄDER DURCHM. 100            |  |