







Assembly code	Assembly revision	Assembly image
ASM4275C/0.D00	External cover	
ASM4278C/0.D01		
ASM3520A/0.D02	General overview	
ASM4262B/0.D01	Cooking chamber	

ASM4275C/0.D00 - External cover











**ASM4275C/0.D00 - External cover**

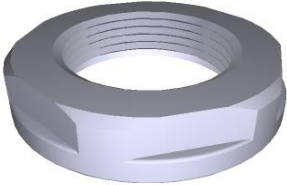







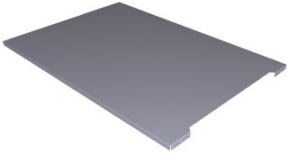
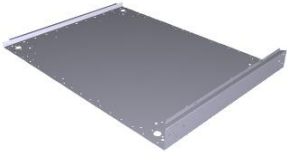

COMPONENT			SPARE PART														
Code	Description	Image	Code	Description	Components list												
VM1750A	BRASS COMB CLAM		KVM1750A	COMB TERMINAL BLOCK KIT	<table border="1"> <thead> <tr> <th>Code</th> <th>Description</th> <th>Qty</th> <th>UOM</th> </tr> </thead> <tbody> <tr> <td>VM1224A0</td> <td>65MY 220MM 2 COLOURS SHRINK TUBE</td> <td>0.150</td> <td>M</td> </tr> <tr> <td>VM1750A0</td> <td>BRASS COMB CLAMP</td> <td>1</td> <td>PZ</td> </tr> </tbody> </table>	Code	Description	Qty	UOM	VM1224A0	65MY 220MM 2 COLOURS SHRINK TUBE	0.150	M	VM1750A0	BRASS COMB CLAMP	1	PZ
Code	Description	Qty	UOM														
VM1224A0	65MY 220MM 2 COLOURS SHRINK TUBE	0.150	M														
VM1750A0	BRASS COMB CLAMP	1	PZ														
VM2249A	COOKING CHAMBER FRONT CORNER		KVM2249A	CHAMBER FRONT PROFILE CORNER KIT	<table border="1"> <thead> <tr> <th>Code</th> <th>Description</th> <th>Qty</th> <th>UOM</th> </tr> </thead> <tbody> <tr> <td>VM1224A0</td> <td>65MY 220MM 2 COLOURS SHRINK TUBE</td> <td>0.150</td> <td>M</td> </tr> <tr> <td>VM2249A0</td> <td>COOKING CHAMBER FRONT CORNER</td> <td>1</td> <td>PZ</td> </tr> </tbody> </table>	Code	Description	Qty	UOM	VM1224A0	65MY 220MM 2 COLOURS SHRINK TUBE	0.150	M	VM2249A0	COOKING CHAMBER FRONT CORNER	1	PZ
Code	Description	Qty	UOM														
VM1224A0	65MY 220MM 2 COLOURS SHRINK TUBE	0.150	M														
VM2249A0	COOKING CHAMBER FRONT CORNER	1	PZ														
VM2311A	SCREWS COVER		KVM2311A	SCREWS COVER PLATE KIT	<table border="1"> <thead> <tr> <th>Code</th> <th>Description</th> <th>Qty</th> <th>UOM</th> </tr> </thead> <tbody> <tr> <td>VM1224A0</td> <td>65MY 220MM 2 COLOURS SHRINK TUBE</td> <td>0.200</td> <td>M</td> </tr> <tr> <td>VM2311A0</td> <td>SCREWS COVER</td> <td>1</td> <td>PZ</td> </tr> </tbody> </table>	Code	Description	Qty	UOM	VM1224A0	65MY 220MM 2 COLOURS SHRINK TUBE	0.200	M	VM2311A0	SCREWS COVER	1	PZ
Code	Description	Qty	UOM														
VM1224A0	65MY 220MM 2 COLOURS SHRINK TUBE	0.200	M														
VM2311A0	SCREWS COVER	1	PZ														
VM1195A	HOLES BLANKING PLATE XVC204/304/504/704		VM1195A0	HOLES BLANKING PLATE XVC204/304/504/704													
VE1275A	STRAIN RELIEF PG 13.5		VE1275A0	STRAIN RELIEF PG 13.5													

COMPONENT			SPARE PART																										
Code	Description	Image	Code	Description	Components list																								
VE1280A	NUT WITH COLLAR FOR STRAIN RELIEF PG13,5		VE1280A0	NUT WITH COLLAR FOR STRAIN RELIEF PG13,5																									
VM2061A	ACCESSORIES CABLES WALL PASSING		KVM1505A	THROUGH-WALL CONNECTION+DIAPHRAGM KIT	<table border="1"> <thead> <tr> <th>Code</th> <th>Description</th> <th>Qty</th> <th>UOM</th> </tr> </thead> <tbody> <tr> <td>VI1220A1</td> <td>4,2X12 TCB SELF-TAPPING SCREW</td> <td>1</td> <td>PZ</td> </tr> <tr> <td>VM1224A0</td> <td>65MY 220MM 2 COLOURS SHRINK TUBE</td> <td>0.200</td> <td>M</td> </tr> <tr> <td>VM1505A0</td> <td>WALL PASSING WITH DIAPHRAGM</td> <td>3</td> <td>PZ</td> </tr> <tr> <td>VM2055A0</td> <td>UPPER WALL PASSING ACCESSORY CABLES</td> <td>1</td> <td>PZ</td> </tr> <tr> <td>VM2056A0</td> <td>LOWER WALL PASSING ACCESSORY CABLES</td> <td>1</td> <td>PZ</td> </tr> </tbody> </table>	Code	Description	Qty	UOM	VI1220A1	4,2X12 TCB SELF-TAPPING SCREW	1	PZ	VM1224A0	65MY 220MM 2 COLOURS SHRINK TUBE	0.200	M	VM1505A0	WALL PASSING WITH DIAPHRAGM	3	PZ	VM2055A0	UPPER WALL PASSING ACCESSORY CABLES	1	PZ	VM2056A0	LOWER WALL PASSING ACCESSORY CABLES	1	PZ
Code	Description	Qty	UOM																										
VI1220A1	4,2X12 TCB SELF-TAPPING SCREW	1	PZ																										
VM1224A0	65MY 220MM 2 COLOURS SHRINK TUBE	0.200	M																										
VM1505A0	WALL PASSING WITH DIAPHRAGM	3	PZ																										
VM2055A0	UPPER WALL PASSING ACCESSORY CABLES	1	PZ																										
VM2056A0	LOWER WALL PASSING ACCESSORY CABLES	1	PZ																										
0H7858A	LOWER THREADED COUNTER BRACKET		0H7858A0	LOWER THREADED COUNTER BRACKET																									
0H7853A	RIGHT AIR DUCT		0H7853A0	RIGHT AIR DUCT																									

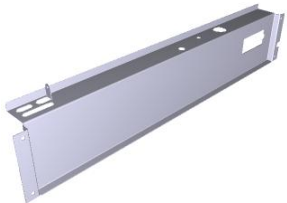
COMPONENT			SPARE PART																																						
Code	Description	Image	Code	Description	Components list																																				
0H7854A	LEFT AIR DUCT		0H7854A0	LEFT AIR DUCT																																					
VE1020B	MAGNET DOOR MICROSWITCH		KVE1020B	MICROSWITCH KIT	<table border="1"> <thead> <tr> <th>Code</th> <th>Description</th> <th>Qty</th> <th>UOM</th> </tr> </thead> <tbody> <tr> <td>CE1030A0</td> <td>FEMALE FASTON COVER 6.3X0.8 0.5-1MMQ</td> <td>2</td> <td>PZ</td> </tr> <tr> <td>CE1660A0</td> <td>6.3X0.8 FEMALE FASTON COVE</td> <td>2</td> <td>PZ</td> </tr> <tr> <td>CE1730A0</td> <td>PVC CABLE NP 2 X AWG22 STYLE 2095</td> <td>0.150</td> <td>M</td> </tr> <tr> <td>CE1740A0</td> <td>MINIFIT MALE END FITTING</td> <td>2</td> <td>PZ</td> </tr> <tr> <td>CE1745A0</td> <td>2 WAYS FEMALE MINIFIT CONNECTOR</td> <td>1</td> <td>PZ</td> </tr> <tr> <td>VE1020B0</td> <td>MAGNET DOOR MICROSWITC</td> <td>1</td> <td>PZ</td> </tr> <tr> <td>VE1030A1</td> <td>MAGNET FOR DOOR MICROSWITC H D=22.9MM</td> <td>1</td> <td>PZ</td> </tr> <tr> <td>VM1224A0</td> <td>65MY 220MM 2 COLOURS SHRINK TUBE</td> <td>0.250</td> <td>M</td> </tr> </tbody> </table>	Code	Description	Qty	UOM	CE1030A0	FEMALE FASTON COVER 6.3X0.8 0.5-1MMQ	2	PZ	CE1660A0	6.3X0.8 FEMALE FASTON COVE	2	PZ	CE1730A0	PVC CABLE NP 2 X AWG22 STYLE 2095	0.150	M	CE1740A0	MINIFIT MALE END FITTING	2	PZ	CE1745A0	2 WAYS FEMALE MINIFIT CONNECTOR	1	PZ	VE1020B0	MAGNET DOOR MICROSWITC	1	PZ	VE1030A1	MAGNET FOR DOOR MICROSWITC H D=22.9MM	1	PZ	VM1224A0	65MY 220MM 2 COLOURS SHRINK TUBE	0.250	M
Code	Description	Qty	UOM																																						
CE1030A0	FEMALE FASTON COVER 6.3X0.8 0.5-1MMQ	2	PZ																																						
CE1660A0	6.3X0.8 FEMALE FASTON COVE	2	PZ																																						
CE1730A0	PVC CABLE NP 2 X AWG22 STYLE 2095	0.150	M																																						
CE1740A0	MINIFIT MALE END FITTING	2	PZ																																						
CE1745A0	2 WAYS FEMALE MINIFIT CONNECTOR	1	PZ																																						
VE1020B0	MAGNET DOOR MICROSWITC	1	PZ																																						
VE1030A1	MAGNET FOR DOOR MICROSWITC H D=22.9MM	1	PZ																																						
VM1224A0	65MY 220MM 2 COLOURS SHRINK TUBE	0.250	M																																						
VM1201A	DOOR MAGNETIC MICROSWITCH SUPPORT PLATE		VM1201A1	DOOR MAGNETIC MICROSWITCH SUPPORT PLATE																																					

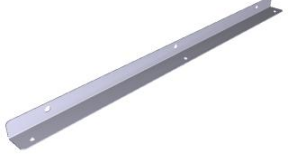





COMPONENT			SPARE PART		
Code	Description	Image	Code	Description	Components list
0D2392B	EVEREO 1013 FOOD PRESERVER COVER		0D2392B0	EVEREO 1013 FOOD PRESERVER COVER	
0E1380B	EVEREO 1013 EXTERNAL BOTTOM PANEL		0E1380B0	EVEREO 1013 EXTERNAL BOTTOM PANEL	
0F1533B	EVEREO 1013 BACK PANEL		0F1533B0	EVEREO 1013 BACK PANEL	
0H7825B	FRONT UPPER PROFILE		0H7825B1	FRONT UPPER PROFILE	
0H7852B	EVEREO 1013 LOWER BACK PANE		0H7852B0	EVEREO 1013 LOWER BACK PANE	





COMPONENT			SPARE PART																														
Code	Description	Image	Code	Description	Components list																												
0H7859B	CONTROL PANEL FASTENING FRONT PROFILE		0H7859B1	CONTROL PANEL FASTENING FRONT PROFILE																													
0H7857A			0H7857A1																														
CR1013A	SP PUSH-TO-CLOSE CLOSING LATCH		KCR1013A	BLSP LATCH PUSH TO CLOSE LOCK KIT	<table border="1"> <thead> <tr> <th>Code</th> <th>Description</th> <th>Qty</th> <th>UOM</th> </tr> </thead> <tbody> <tr> <td>CR1013A0</td> <td>SHOP PRO PUSH TO CLOSE COMPLETE LATCH</td> <td>1</td> <td>PZ</td> </tr> <tr> <td>CR1013A1</td> <td></td> <td>1</td> <td>PZ</td> </tr> <tr> <td>CR1013A2</td> <td>SP PUSH-TO-CLOSE CLOSING LATCH</td> <td>1</td> <td>PZ</td> </tr> <tr> <td>VI1014A0</td> <td>STAINLESS STEEL WASHER 4.5X9X0.8</td> <td>2</td> <td>PZ</td> </tr> <tr> <td>VI1024A0</td> <td>SCREW M4X12 TCB + INOX DIN 7985</td> <td>2</td> <td>PZ</td> </tr> <tr> <td>VM1224A0</td> <td>65MY 220MM COLOURS SHRINK TUBE</td> <td>2 0.200</td> <td>M</td> </tr> </tbody> </table>	Code	Description	Qty	UOM	CR1013A0	SHOP PRO PUSH TO CLOSE COMPLETE LATCH	1	PZ	CR1013A1		1	PZ	CR1013A2	SP PUSH-TO-CLOSE CLOSING LATCH	1	PZ	VI1014A0	STAINLESS STEEL WASHER 4.5X9X0.8	2	PZ	VI1024A0	SCREW M4X12 TCB + INOX DIN 7985	2	PZ	VM1224A0	65MY 220MM COLOURS SHRINK TUBE	2 0.200	M
Code	Description	Qty	UOM																														
CR1013A0	SHOP PRO PUSH TO CLOSE COMPLETE LATCH	1	PZ																														
CR1013A1		1	PZ																														
CR1013A2	SP PUSH-TO-CLOSE CLOSING LATCH	1	PZ																														
VI1014A0	STAINLESS STEEL WASHER 4.5X9X0.8	2	PZ																														
VI1024A0	SCREW M4X12 TCB + INOX DIN 7985	2	PZ																														
VM1224A0	65MY 220MM COLOURS SHRINK TUBE	2 0.200	M																														
VM1354A	EVEREO 2.0 SIDE LATCH COVER		VM1354A0	EVEREO 2.0 SIDE LATCH COVER																													









COMPONENT			SPARE PART																										
Code	Description	Image	Code	Description	Components list																								
VM1342A	EVEREO 2.0 SIDE BLIND COVER		VM1342A0	EVEREO 2.0 SIDE BLIND COVER																									
GN0056A			GN0056A0																										
CR1124A	EVEREO DOOR RIGHT LOWER BRACKET		KCR1124A	EVEREO LOWER BRACKET DOOR KIT	<table border="1"> <thead> <tr> <th>Code</th> <th>Description</th> <th>Qty</th> <th>UOM</th> </tr> </thead> <tbody> <tr> <td>0H7831B0</td> <td>FOOD PRESERVER DOOR BRACKET</td> <td>1</td> <td>PZ</td> </tr> <tr> <td>0H7831B1</td> <td>FOOD PRESERVER HOLDING BRACKET</td> <td>1</td> <td>PZ</td> </tr> <tr> <td>VI1065A0</td> <td>M6X16 TSPEI STAINLESS STEEL SCREW</td> <td>6</td> <td>PZ</td> </tr> <tr> <td>VM1224A0</td> <td>65MY 220MM 2 COLOURS SHRINK TUBE</td> <td>0.200</td> <td>M</td> </tr> <tr> <td>VM2500A0</td> <td>EVEREO BUSHING FOR DOOR</td> <td>1</td> <td>PZ</td> </tr> </tbody> </table>	Code	Description	Qty	UOM	0H7831B0	FOOD PRESERVER DOOR BRACKET	1	PZ	0H7831B1	FOOD PRESERVER HOLDING BRACKET	1	PZ	VI1065A0	M6X16 TSPEI STAINLESS STEEL SCREW	6	PZ	VM1224A0	65MY 220MM 2 COLOURS SHRINK TUBE	0.200	M	VM2500A0	EVEREO BUSHING FOR DOOR	1	PZ
Code	Description	Qty	UOM																										
0H7831B0	FOOD PRESERVER DOOR BRACKET	1	PZ																										
0H7831B1	FOOD PRESERVER HOLDING BRACKET	1	PZ																										
VI1065A0	M6X16 TSPEI STAINLESS STEEL SCREW	6	PZ																										
VM1224A0	65MY 220MM 2 COLOURS SHRINK TUBE	0.200	M																										
VM2500A0	EVEREO BUSHING FOR DOOR	1	PZ																										
CR1125A	EVEREO DOOR RIGHT UPPER BRACKET		KCR1125A	EVEREO UPPER BRACKET DOOR KIT	<table border="1"> <thead> <tr> <th>Code</th> <th>Description</th> <th>Qty</th> <th>UOM</th> </tr> </thead> <tbody> <tr> <td>0H7831B0</td> <td>FOOD PRESERVER DOOR BRACKET</td> <td>1</td> <td>PZ</td> </tr> <tr> <td>0H7831B1</td> <td>FOOD PRESERVER HOLDING BRACKET</td> <td>1</td> <td>PZ</td> </tr> <tr> <td>VI1065A0</td> <td>M6X16 TSPEI STAINLESS STEEL SCREW</td> <td>6</td> <td>PZ</td> </tr> <tr> <td>VM1224A0</td> <td>65MY 220MM 2 COLOURS SHRINK TUBE</td> <td>0.200</td> <td>M</td> </tr> <tr> <td>VM2500A0</td> <td>EVEREO BUSHING FOR DOOR</td> <td>1</td> <td>PZ</td> </tr> </tbody> </table>	Code	Description	Qty	UOM	0H7831B0	FOOD PRESERVER DOOR BRACKET	1	PZ	0H7831B1	FOOD PRESERVER HOLDING BRACKET	1	PZ	VI1065A0	M6X16 TSPEI STAINLESS STEEL SCREW	6	PZ	VM1224A0	65MY 220MM 2 COLOURS SHRINK TUBE	0.200	M	VM2500A0	EVEREO BUSHING FOR DOOR	1	PZ
Code	Description	Qty	UOM																										
0H7831B0	FOOD PRESERVER DOOR BRACKET	1	PZ																										
0H7831B1	FOOD PRESERVER HOLDING BRACKET	1	PZ																										
VI1065A0	M6X16 TSPEI STAINLESS STEEL SCREW	6	PZ																										
VM1224A0	65MY 220MM 2 COLOURS SHRINK TUBE	0.200	M																										
VM2500A0	EVEREO BUSHING FOR DOOR	1	PZ																										



COMPONENT			SPARE PART																		
Code	Description	Image	Code	Description	Components list																
0D2390C	EVEREO 1013 LEFT SIDE		0D2390C0	EVEREO 1013 LEFT SIDE																	
0D2391C	EVEREO 1013 RIGHT SIDE		0D2391C0	EVEREO 1013 RIGHT SIDE																	
0H1944A	EVEREO CUBE CONTROL PANEL SUPPORT		0H1944A1	EVEREO CUBE CONTROL PANEL SUPPORT																	
PE2136A	EVEREO COMPLETE CONTROL		KPE2136A	EVEREO CONTROL BOARD KIT 2.0	<table border="1"> <thead> <tr> <th>Code</th> <th>Description</th> <th>Qty</th> <th>UOM</th> </tr> </thead> <tbody> <tr> <td>PE2136A0</td> <td>EVEREO COMPLETE CONTROL</td> <td>1</td> <td>PZ</td> </tr> <tr> <td>PE2136A1</td> <td>EVEREO COMPLETE CONTROL</td> <td>1</td> <td>PZ</td> </tr> <tr> <td>VM2147A0</td> <td>410X343X15 MM PINK SMOOTH ESD SPONGE</td> <td>1</td> <td>PZ</td> </tr> </tbody> </table>	Code	Description	Qty	UOM	PE2136A0	EVEREO COMPLETE CONTROL	1	PZ	PE2136A1	EVEREO COMPLETE CONTROL	1	PZ	VM2147A0	410X343X15 MM PINK SMOOTH ESD SPONGE	1	PZ
Code	Description	Qty	UOM																		
PE2136A0	EVEREO COMPLETE CONTROL	1	PZ																		
PE2136A1	EVEREO COMPLETE CONTROL	1	PZ																		
VM2147A0	410X343X15 MM PINK SMOOTH ESD SPONGE	1	PZ																		
0H7913C	EVEREO 1013 CONTROL PANEL PLATE		0H7913C2	EVEREO 1013 CONTROL PANEL PLATE																	



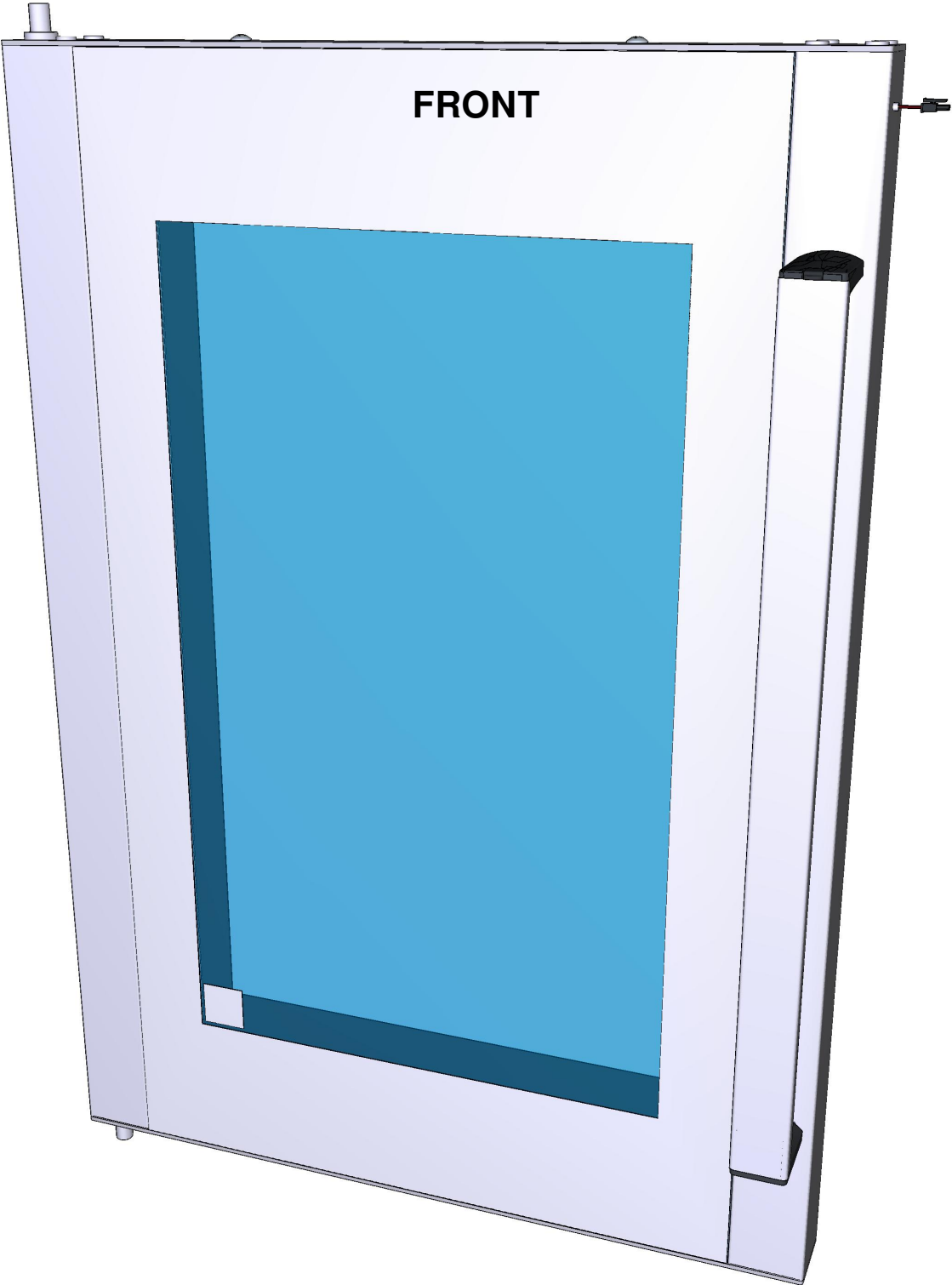

COMPONENT			SPARE PART																														
Code	Description	Image	Code	Description	Components list																												
TR1136A	330 °C 1 POLE SAFETY THERMOSTAT		KTR1136A	330 °C SAFETY THERMOSTAT KIT	<table border="1"> <thead> <tr> <th>Code</th> <th>Description</th> <th>Qty</th> <th>UOM</th> </tr> </thead> <tbody> <tr> <td>0H7030A0</td> <td>THERMOSTAT BULB INLET COVER</td> <td>1</td> <td>PZ</td> </tr> <tr> <td>GN1531A0</td> <td>THERMOSTAT BULB INLET SEALING</td> <td>1</td> <td>PZ</td> </tr> <tr> <td>MOV0011A0</td> <td>HOOD RING GASKET GN1110A2</td> <td>0.100</td> <td>PZ</td> </tr> <tr> <td>SL1045A0</td> <td>S57 BLACK SILICONE - 80ML CARTRIDGE</td> <td>1</td> <td>PZ</td> </tr> <tr> <td>TR1136A0</td> <td>330 °C 1 POLE SAFETY THERMOSTAT</td> <td>1</td> <td>PZ</td> </tr> <tr> <td>VI1220A1</td> <td>4,2X12 TCB SELF-TAPPING SCREW</td> <td>3</td> <td>PZ</td> </tr> </tbody> </table>	Code	Description	Qty	UOM	0H7030A0	THERMOSTAT BULB INLET COVER	1	PZ	GN1531A0	THERMOSTAT BULB INLET SEALING	1	PZ	MOV0011A0	HOOD RING GASKET GN1110A2	0.100	PZ	SL1045A0	S57 BLACK SILICONE - 80ML CARTRIDGE	1	PZ	TR1136A0	330 °C 1 POLE SAFETY THERMOSTAT	1	PZ	VI1220A1	4,2X12 TCB SELF-TAPPING SCREW	3	PZ
Code	Description	Qty	UOM																														
0H7030A0	THERMOSTAT BULB INLET COVER	1	PZ																														
GN1531A0	THERMOSTAT BULB INLET SEALING	1	PZ																														
MOV0011A0	HOOD RING GASKET GN1110A2	0.100	PZ																														
SL1045A0	S57 BLACK SILICONE - 80ML CARTRIDGE	1	PZ																														
TR1136A0	330 °C 1 POLE SAFETY THERMOSTAT	1	PZ																														
VI1220A1	4,2X12 TCB SELF-TAPPING SCREW	3	PZ																														
VM2406A	XECC FRONT EXTERNAL BOTTOM PANEL GASKET		OUTOFPRODUCTIO	ITEM OUT OF PRODUCTION																													
VM2407A	XECC SIDE EXTERNAL BOTTOM PANEL GASKET		OUTOFPRODUCTIO	ITEM OUT OF PRODUCTION																													
VM2408A	XECC EXTERNAL BOTTOM PANEL GASKET - EXTE		OUTOFPRODUCTIO	ITEM OUT OF PRODUCTION																													



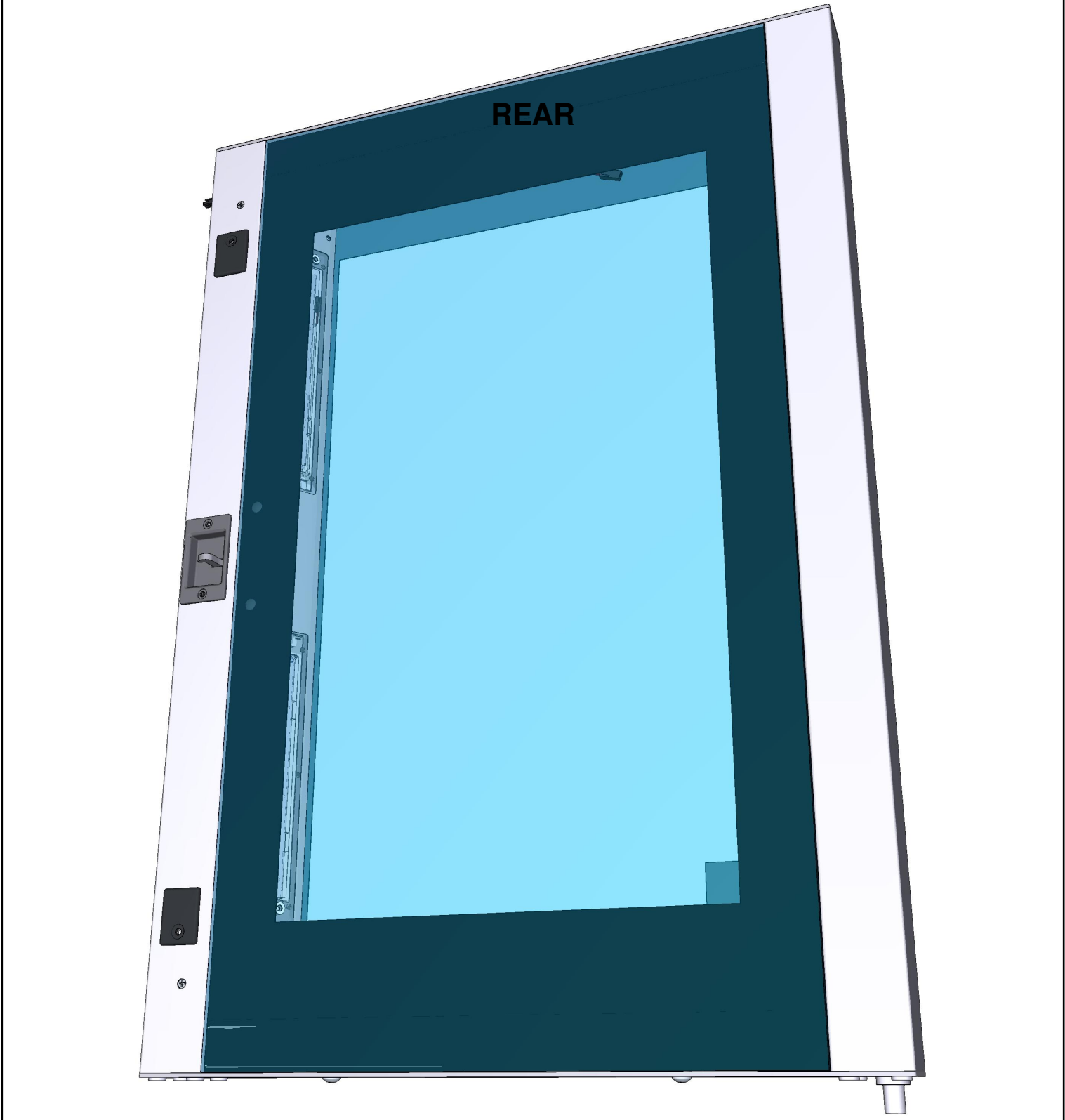

ASM4278C/0.D01 -





ASM4278C/0.D01 -





COMPONENT			SPARE PART																										
Code	Description	Image	Code	Description	Components list																								
VM2268A	DOOR MAGNET COVER		KVM2268A	DOOR MAGNET COVER KIT	<table border="1"> <thead> <tr> <th>Code</th> <th>Description</th> <th>Qty</th> <th>UOM</th> </tr> </thead> <tbody> <tr> <td>VM1224A0</td> <td>65MY 220MM 2 COLOURS SHRINK TUBE</td> <td>0.200</td> <td>M</td> </tr> <tr> <td>VM2268A0</td> <td>DOOR MAGNET COVER</td> <td>1</td> <td>PZ</td> </tr> </tbody> </table>	Code	Description	Qty	UOM	VM1224A0	65MY 220MM 2 COLOURS SHRINK TUBE	0.200	M	VM2268A0	DOOR MAGNET COVER	1	PZ												
Code	Description	Qty	UOM																										
VM1224A0	65MY 220MM 2 COLOURS SHRINK TUBE	0.200	M																										
VM2268A0	DOOR MAGNET COVER	1	PZ																										
VM1631A	PLUS INNER GLASS PUSHING CAP		KVM1631A	CAP FOR INTERNAL GLASS 10 PCS KIT	<table border="1"> <thead> <tr> <th>Code</th> <th>Description</th> <th>Qty</th> <th>UOM</th> </tr> </thead> <tbody> <tr> <td>VM1224A0</td> <td>65MY 220MM 2 COLOURS SHRINK TUBE</td> <td>0.200</td> <td>M</td> </tr> <tr> <td>VM1631A0</td> <td>PLUS INNER GLASS PUSHING CAP</td> <td>10</td> <td>PZ</td> </tr> </tbody> </table>	Code	Description	Qty	UOM	VM1224A0	65MY 220MM 2 COLOURS SHRINK TUBE	0.200	M	VM1631A0	PLUS INNER GLASS PUSHING CAP	10	PZ												
Code	Description	Qty	UOM																										
VM1224A0	65MY 220MM 2 COLOURS SHRINK TUBE	0.200	M																										
VM1631A0	PLUS INNER GLASS PUSHING CAP	10	PZ																										
LP1050A	BL SHOP.PRO L180 COMPLETE LED BA		KLP1050A	BAKERLUX SHOP.PRO L180 LED BAR KIT	<table border="1"> <thead> <tr> <th>Code</th> <th>Description</th> <th>Qty</th> <th>UOM</th> </tr> </thead> <tbody> <tr> <td>IP1385A1</td> <td>CORNER POLYSTYREN E PACKING 110X80X2000</td> <td>0.300</td> <td>M</td> </tr> <tr> <td>LP1050A0</td> <td>BL SHOP.PRO L180 COMPLETE LED BAR</td> <td>1</td> <td>PZ</td> </tr> <tr> <td>VI1014A0</td> <td>STAINLESS STEEL WASHER 4.5X9X0.8</td> <td>1</td> <td>PZ</td> </tr> <tr> <td>VI1220A1</td> <td>4,2X12 TCB SELF-TAPPING SCREW</td> <td>1</td> <td>PZ</td> </tr> <tr> <td>VM1059A1</td> <td>HEAT SHRINK FILM H800</td> <td>0.300</td> <td>M</td> </tr> </tbody> </table>	Code	Description	Qty	UOM	IP1385A1	CORNER POLYSTYREN E PACKING 110X80X2000	0.300	M	LP1050A0	BL SHOP.PRO L180 COMPLETE LED BAR	1	PZ	VI1014A0	STAINLESS STEEL WASHER 4.5X9X0.8	1	PZ	VI1220A1	4,2X12 TCB SELF-TAPPING SCREW	1	PZ	VM1059A1	HEAT SHRINK FILM H800	0.300	M
Code	Description	Qty	UOM																										
IP1385A1	CORNER POLYSTYREN E PACKING 110X80X2000	0.300	M																										
LP1050A0	BL SHOP.PRO L180 COMPLETE LED BAR	1	PZ																										
VI1014A0	STAINLESS STEEL WASHER 4.5X9X0.8	1	PZ																										
VI1220A1	4,2X12 TCB SELF-TAPPING SCREW	1	PZ																										
VM1059A1	HEAT SHRINK FILM H800	0.300	M																										
ML1006A	L.21 ED7 DF1 ST STEEL TRACTION SPRING		KML1006A	L21 DE7 DF1 TRACTION SPRING 10PCS KIT	<table border="1"> <thead> <tr> <th>Code</th> <th>Description</th> <th>Qty</th> <th>UOM</th> </tr> </thead> <tbody> <tr> <td>ML1006A0</td> <td>L.21 ED7 DF1 ST STEEL TRACTION SPRING</td> <td>10</td> <td>PZ</td> </tr> </tbody> </table>	Code	Description	Qty	UOM	ML1006A0	L.21 ED7 DF1 ST STEEL TRACTION SPRING	10	PZ																
Code	Description	Qty	UOM																										
ML1006A0	L.21 ED7 DF1 ST STEEL TRACTION SPRING	10	PZ																										

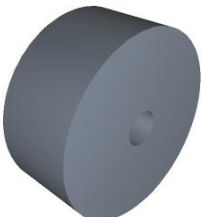



COMPONENT			SPARE PART		
Code	Description	Image	Code	Description	Components list
VM2549A	SP PUSH-TO-CLOSE DOOR HANDLE SPRING EYEL		VM2549A0	SP PUSH-TO-CLOSE DOOR HANDLE SPRING EYEL	
0H1549B			0H1549B1		
0B1342A			0B1342A1		
0B1357A			0B1357A1		
VM1351A	EVEREO 2.0 DOOR INTERNAL TUBE GUIDE		VM1351A0	EVEREO 2.0 DOOR INTERNAL TUBE GUIDE	



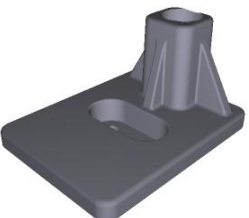



COMPONENT			SPARE PART																		
Code	Description	Image	Code	Description	Components list																
VM2305A	6 SERIES DOOR CAP FIXING PAWL		KVM2305A	MM FIXING DOOR THUB SCREWS 10 PCS KIT	<table border="1"> <thead> <tr> <th>Code</th> <th>Description</th> <th>Qty</th> <th>UOM</th> </tr> </thead> <tbody> <tr> <td>VM1224A0</td> <td>65MY 220MM 2 COLOURS SHRINK TUBE</td> <td>0.200</td> <td>M</td> </tr> <tr> <td>VM2305A0</td> <td>6 SERIES DOOR CAP FIXING PAWL</td> <td>10</td> <td>PZ</td> </tr> </tbody> </table>	Code	Description	Qty	UOM	VM1224A0	65MY 220MM 2 COLOURS SHRINK TUBE	0.200	M	VM2305A0	6 SERIES DOOR CAP FIXING PAWL	10	PZ				
Code	Description	Qty	UOM																		
VM1224A0	65MY 220MM 2 COLOURS SHRINK TUBE	0.200	M																		
VM2305A0	6 SERIES DOOR CAP FIXING PAWL	10	PZ																		
VE1030A	MAGNET FOR DOOR MICROSWITCH D=22,9MM		KVE1030A	2 PCS MAGNET KIT FOR DOOR SWITCH	<table border="1"> <thead> <tr> <th>Code</th> <th>Description</th> <th>Qty</th> <th>UOM</th> </tr> </thead> <tbody> <tr> <td>VE1030A1</td> <td>MAGNET FOR DOOR MICROSWITC H D=22,9MM</td> <td>2</td> <td>PZ</td> </tr> <tr> <td>VM1224A0</td> <td>65MY 220MM 2 COLOURS SHRINK TUBE</td> <td>0.150</td> <td>M</td> </tr> </tbody> </table>	Code	Description	Qty	UOM	VE1030A1	MAGNET FOR DOOR MICROSWITC H D=22,9MM	2	PZ	VM1224A0	65MY 220MM 2 COLOURS SHRINK TUBE	0.150	M				
Code	Description	Qty	UOM																		
VE1030A1	MAGNET FOR DOOR MICROSWITC H D=22,9MM	2	PZ																		
VM1224A0	65MY 220MM 2 COLOURS SHRINK TUBE	0.150	M																		
			KVE1020A	MICROSWITCH KIT	<table border="1"> <thead> <tr> <th>Code</th> <th>Description</th> <th>Qty</th> <th>UOM</th> </tr> </thead> <tbody> <tr> <td>VE1020A2</td> <td>MAGNETIC DOOR MICROSWITC</td> <td>1</td> <td>PZ</td> </tr> <tr> <td>VE1030A1</td> <td>MAGNET FOR DOOR MICROSWITC H D=22,9MM</td> <td>4</td> <td>PZ</td> </tr> <tr> <td>VM1224A0</td> <td>65MY 220MM 2 COLOURS SHRINK TUBE</td> <td>0.250</td> <td>M</td> </tr> </tbody> </table>	Code	Description	Qty	UOM	VE1020A2	MAGNETIC DOOR MICROSWITC	1	PZ	VE1030A1	MAGNET FOR DOOR MICROSWITC H D=22,9MM	4	PZ	VM1224A0	65MY 220MM 2 COLOURS SHRINK TUBE	0.250	M
Code	Description	Qty	UOM																		
VE1020A2	MAGNETIC DOOR MICROSWITC	1	PZ																		
VE1030A1	MAGNET FOR DOOR MICROSWITC H D=22,9MM	4	PZ																		
VM1224A0	65MY 220MM 2 COLOURS SHRINK TUBE	0.250	M																		
VI1996A	M5X35 SCREW		VI1996A0	M5X35 SCREW																	
CE1065A	4X0.5 MICROFIT WIRE 4P-500MM-MICROFIT4P		KCE1065A	4P-500MM MICROFIT CABLE KI	<table border="1"> <thead> <tr> <th>Code</th> <th>Description</th> <th>Qty</th> <th>UOM</th> </tr> </thead> <tbody> <tr> <td>CE1065A0</td> <td>4X0.5 MICROFIT WIRE 4P-500MM-MICROFIT4P</td> <td>1</td> <td>PZ</td> </tr> <tr> <td>VM1224A0</td> <td>65MY 220MM 2 COLOURS SHRINK TUBE</td> <td>0.200</td> <td>M</td> </tr> </tbody> </table>	Code	Description	Qty	UOM	CE1065A0	4X0.5 MICROFIT WIRE 4P-500MM-MICROFIT4P	1	PZ	VM1224A0	65MY 220MM 2 COLOURS SHRINK TUBE	0.200	M				
Code	Description	Qty	UOM																		
CE1065A0	4X0.5 MICROFIT WIRE 4P-500MM-MICROFIT4P	1	PZ																		
VM1224A0	65MY 220MM 2 COLOURS SHRINK TUBE	0.200	M																		





COMPONENT			SPARE PART														
Code	Description	Image	Code	Description	Components list												
CE1887A	MICROFIT CABLE 2PF-800-MICROFIT 2PM AWG2		KCE1887A		<table border="1"> <thead> <tr> <th>Code</th> <th>Description</th> <th>Qty</th> <th>UOM</th> </tr> </thead> <tbody> <tr> <td>CE1887A0</td> <td>MICROFIT CABLE 2PF-800-MICR OFIT 2PM AWG2</td> <td>1</td> <td>PZ</td> </tr> </tbody> </table>	Code	Description	Qty	UOM	CE1887A0	MICROFIT CABLE 2PF-800-MICR OFIT 2PM AWG2	1	PZ				
Code	Description	Qty	UOM														
CE1887A0	MICROFIT CABLE 2PF-800-MICR OFIT 2PM AWG2	1	PZ														
VM2305A	6 SERIES DOOR CAP FIXING PAWL		KVM2305A	MM FIXING DOOR THUB SCREWS 10 PCS KIT	<table border="1"> <thead> <tr> <th>Code</th> <th>Description</th> <th>Qty</th> <th>UOM</th> </tr> </thead> <tbody> <tr> <td>VM1224A0</td> <td>65MY 220MM 2 COLOURS SHRINK TUBE</td> <td>0.200</td> <td>M</td> </tr> <tr> <td>VM2305A0</td> <td>6 SERIES DOOR CAP FIXING PAWL</td> <td>10</td> <td>PZ</td> </tr> </tbody> </table>	Code	Description	Qty	UOM	VM1224A0	65MY 220MM 2 COLOURS SHRINK TUBE	0.200	M	VM2305A0	6 SERIES DOOR CAP FIXING PAWL	10	PZ
Code	Description	Qty	UOM														
VM1224A0	65MY 220MM 2 COLOURS SHRINK TUBE	0.200	M														
VM2305A0	6 SERIES DOOR CAP FIXING PAWL	10	PZ														
VI1996A	M5X35 SCREW		VI1996A0	M5X35 SCREW													
VM2577A	EVEREO DOOR CAP		VM2577A1	EVEREO DOOR CAP													
VM1352A	EVEREO 2.0 FULCRUM COUNTERCAP		VM1352A0	EVEREO 2.0 FULCRUM COUNTERCAP													

COMPONENT			SPARE PART																										
Code	Description	Image	Code	Description	Components list																								
VM2305A	6 SERIES DOOR CAP FIXING PAWL		KVM2305A	MM FIXING DOOR THUB SCREWS 10 PCS KIT	<table border="1"> <thead> <tr> <th>Code</th> <th>Description</th> <th>Qty</th> <th>UOM</th> </tr> </thead> <tbody> <tr> <td>VM1224A0</td> <td>65MY 220MM 2 COLOURS SHRINK TUBE</td> <td>0.200</td> <td>M</td> </tr> <tr> <td>VM2305A0</td> <td>6 SERIES DOOR CAP FIXING PAWL</td> <td>10</td> <td>PZ</td> </tr> </tbody> </table>	Code	Description	Qty	UOM	VM1224A0	65MY 220MM 2 COLOURS SHRINK TUBE	0.200	M	VM2305A0	6 SERIES DOOR CAP FIXING PAWL	10	PZ												
Code	Description	Qty	UOM																										
VM1224A0	65MY 220MM 2 COLOURS SHRINK TUBE	0.200	M																										
VM2305A0	6 SERIES DOOR CAP FIXING PAWL	10	PZ																										
VI1996A	M5X35 SCREW		VI1996A0	M5X35 SCREW																									
VM2577A	EVEREO DOOR CAP		VM2577A1	EVEREO DOOR CAP																									
VM1352A	EVEREO 2.0 FULCRUM COUNTERCAP		VM1352A0	EVEREO 2.0 FULCRUM COUNTERCAP																									
TB1709A	EVEREO HANDLY TUBE		KTB1709A	EVEREO 2.0 HANDLE TUBE KIT	<table border="1"> <thead> <tr> <th>Code</th> <th>Description</th> <th>Qty</th> <th>UOM</th> </tr> </thead> <tbody> <tr> <td>TB1709A0</td> <td>EVEREO HANDLY TUBE</td> <td>1</td> <td>PZ</td> </tr> <tr> <td>VI1930A0</td> <td>5X25 ST. STEEL SCREW CHIP</td> <td>2</td> <td>PZ</td> </tr> <tr> <td>VM2527A0</td> <td>STYLUS PEN FOR SP</td> <td>1</td> <td>PZ</td> </tr> <tr> <td>VM2593A0</td> <td>H50 DOOR HANDLE END</td> <td>1</td> <td>PZ</td> </tr> <tr> <td>VM2594A0</td> <td>H50 DOOR HANDLE END WITH STYLUS</td> <td>1</td> <td>PZ</td> </tr> </tbody> </table>	Code	Description	Qty	UOM	TB1709A0	EVEREO HANDLY TUBE	1	PZ	VI1930A0	5X25 ST. STEEL SCREW CHIP	2	PZ	VM2527A0	STYLUS PEN FOR SP	1	PZ	VM2593A0	H50 DOOR HANDLE END	1	PZ	VM2594A0	H50 DOOR HANDLE END WITH STYLUS	1	PZ
Code	Description	Qty	UOM																										
TB1709A0	EVEREO HANDLY TUBE	1	PZ																										
VI1930A0	5X25 ST. STEEL SCREW CHIP	2	PZ																										
VM2527A0	STYLUS PEN FOR SP	1	PZ																										
VM2593A0	H50 DOOR HANDLE END	1	PZ																										
VM2594A0	H50 DOOR HANDLE END WITH STYLUS	1	PZ																										

COMPONENT			SPARE PART																														
Code	Description	Image	Code	Description	Components list																												
VM2527A	STYLUS PEN FOR S		KVM2527A	EVEREO-BLSP TOUCH STYLUS 5 PCS KIT	<table border="1"> <thead> <tr> <th>Code</th> <th>Description</th> <th>Qty</th> <th>UOM</th> </tr> </thead> <tbody> <tr> <td>VM1224A0</td> <td>65MY 220MM 2 COLOURS SHRINK TUBE</td> <td>0.150</td> <td>M</td> </tr> <tr> <td>VM2527A0</td> <td>STYLUS PEN FOR SP</td> <td>5</td> <td>PZ</td> </tr> </tbody> </table>	Code	Description	Qty	UOM	VM1224A0	65MY 220MM 2 COLOURS SHRINK TUBE	0.150	M	VM2527A0	STYLUS PEN FOR SP	5	PZ																
Code	Description	Qty	UOM																														
VM1224A0	65MY 220MM 2 COLOURS SHRINK TUBE	0.150	M																														
VM2527A0	STYLUS PEN FOR SP	5	PZ																														
VM2456A	BAKERLUX SHOP.PRO HANDLE END		KVM2456A	2 PCS BAKERLUX SHOP.PRO HANDLE END KIT	<table border="1"> <thead> <tr> <th>Code</th> <th>Description</th> <th>Qty</th> <th>UOM</th> </tr> </thead> <tbody> <tr> <td>VI1930A0</td> <td>5X25 ST. STEEL SCREW CHIP</td> <td>4</td> <td>PZ</td> </tr> <tr> <td>VM1224A0</td> <td>65MY 220MM 2 COLOURS SHRINK TUBE</td> <td>0.300</td> <td>M</td> </tr> <tr> <td>VM2456A0</td> <td>BAKERLUX SHOP.PRO HANDLE END</td> <td>2</td> <td>PZ</td> </tr> <tr> <td>VM2456A0</td> <td>BAKERLUX SHOP.PRO HANDLE END</td> <td>2</td> <td>PZ</td> </tr> <tr> <td>VM2489A0</td> <td>SP HANDLE END KIT + STYLUS KIT</td> <td>1</td> <td>PZ</td> </tr> <tr> <td>VM2527A0</td> <td>STYLUS PEN FOR SP</td> <td>1</td> <td>PZ</td> </tr> </tbody> </table>	Code	Description	Qty	UOM	VI1930A0	5X25 ST. STEEL SCREW CHIP	4	PZ	VM1224A0	65MY 220MM 2 COLOURS SHRINK TUBE	0.300	M	VM2456A0	BAKERLUX SHOP.PRO HANDLE END	2	PZ	VM2456A0	BAKERLUX SHOP.PRO HANDLE END	2	PZ	VM2489A0	SP HANDLE END KIT + STYLUS KIT	1	PZ	VM2527A0	STYLUS PEN FOR SP	1	PZ
Code	Description	Qty	UOM																														
VI1930A0	5X25 ST. STEEL SCREW CHIP	4	PZ																														
VM1224A0	65MY 220MM 2 COLOURS SHRINK TUBE	0.300	M																														
VM2456A0	BAKERLUX SHOP.PRO HANDLE END	2	PZ																														
VM2456A0	BAKERLUX SHOP.PRO HANDLE END	2	PZ																														
VM2489A0	SP HANDLE END KIT + STYLUS KIT	1	PZ																														
VM2527A0	STYLUS PEN FOR SP	1	PZ																														
TB3266C	EVEREO 2.0 RIGHT DOOR COLUMN		TB3266C0	EVEREO 2.0 RIGHT DOOR COLUMN																													
TB3267B	EVEREO 2.0 LEFT DOOR COLUMN		TB3267B0	EVEREO 2.0 LEFT DOOR COLUMN																													

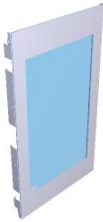
COMPONENT			SPARE PART																										
Code	Description	Image	Code	Description	Components list																								
VM2577A	EVEREO DOOR CAP		VM2577A1	EVEREO DOOR CAP																									
0H1898A	EVEREO 1013 DOOR UPPER BEAM		0H1898A1	EVEREO 1013 DOOR UPPER BEAM																									
0H1899A	EVEREO 1013 DOOR LOWER BEAM		0H1899A1	EVEREO 1013 DOOR LOWER BEAM																									
VM1349A	EVEREO 2.0 DOOR HOOK COVER		VM1349A0	EVEREO 2.0 DOOR HOOK COVER																									
VT1338D			KVT1338A	EVEREO 1.0 EXTERNAL GLASS KIT	<table border="1"> <thead> <tr> <th>Code</th> <th>Description</th> <th>Qty</th> <th>UOM</th> </tr> </thead> <tbody> <tr> <td>0B1342A1</td> <td></td> <td>1</td> <td>PZ</td> </tr> <tr> <td>0B1357A1</td> <td></td> <td>1</td> <td>PZ</td> </tr> <tr> <td>0H7832A0</td> <td>FOOD PRESERVER EXT GLASS SUPP PROFIL</td> <td>2</td> <td>PZ</td> </tr> <tr> <td>0H7832B2</td> <td>FOOD PRESERVER EXTERNAL GLASS SUPPORT</td> <td>2</td> <td>PZ</td> </tr> <tr> <td>IP1508A1</td> <td>POLYSTYREN E U SHAPED PROFILE 2000X60X60</td> <td>2</td> <td>M</td> </tr> </tbody> </table>	Code	Description	Qty	UOM	0B1342A1		1	PZ	0B1357A1		1	PZ	0H7832A0	FOOD PRESERVER EXT GLASS SUPP PROFIL	2	PZ	0H7832B2	FOOD PRESERVER EXTERNAL GLASS SUPPORT	2	PZ	IP1508A1	POLYSTYREN E U SHAPED PROFILE 2000X60X60	2	M
Code	Description	Qty	UOM																										
0B1342A1		1	PZ																										
0B1357A1		1	PZ																										
0H7832A0	FOOD PRESERVER EXT GLASS SUPP PROFIL	2	PZ																										
0H7832B2	FOOD PRESERVER EXTERNAL GLASS SUPPORT	2	PZ																										
IP1508A1	POLYSTYREN E U SHAPED PROFILE 2000X60X60	2	M																										

COMPONENT			SPARE PART																																		
Code	Description	Image	Code	Description	Components list																																
VT1338D			KVT1338A	EVEREO 1.0 EXTERNAL GLASS KIT	<table border="1"> <thead> <tr> <th>Code</th> <th>Description</th> <th>Qty</th> <th>UOM</th> </tr> </thead> <tbody> <tr> <td>SL1155A1</td> <td>LOCTITE BICOMPONEN T SILICON</td> <td>15</td> <td>ML</td> </tr> <tr> <td>VM1059A1</td> <td>HEAT SHRINK FILM H800</td> <td>1.500</td> <td>M</td> </tr> <tr> <td>VT1322A0</td> <td></td> <td>1</td> <td>PZ</td> </tr> <tr> <td>VT1322A0</td> <td></td> <td>1</td> <td>PZ</td> </tr> <tr> <td>VT1340B0</td> <td>EVEREO 900 EXTERNAL GLASS</td> <td>1</td> <td>PZ</td> </tr> </tbody> </table>	Code	Description	Qty	UOM	SL1155A1	LOCTITE BICOMPONEN T SILICON	15	ML	VM1059A1	HEAT SHRINK FILM H800	1.500	M	VT1322A0		1	PZ	VT1322A0		1	PZ	VT1340B0	EVEREO 900 EXTERNAL GLASS	1	PZ								
Code	Description	Qty	UOM																																		
SL1155A1	LOCTITE BICOMPONEN T SILICON	15	ML																																		
VM1059A1	HEAT SHRINK FILM H800	1.500	M																																		
VT1322A0		1	PZ																																		
VT1322A0		1	PZ																																		
VT1340B0	EVEREO 900 EXTERNAL GLASS	1	PZ																																		
VT1339C			KVT1339A	EVEREO 1.0 INTERNAL GLASS KI	<table border="1"> <thead> <tr> <th>Code</th> <th>Description</th> <th>Qty</th> <th>UOM</th> </tr> </thead> <tbody> <tr> <td>0H7837A0</td> <td></td> <td>2</td> <td>PZ</td> </tr> <tr> <td>IP1508A1</td> <td>POLYSTYREN E U SHAPED PROFILE 2000X60X60</td> <td>2</td> <td>M</td> </tr> <tr> <td>VI1982A0</td> <td>M6 ST. STEEL BLIND THREADED INSERT</td> <td>4</td> <td>PZ</td> </tr> <tr> <td>VM1059A1</td> <td>HEAT SHRINK FILM H800</td> <td>1.500</td> <td>M</td> </tr> <tr> <td>VT1322A0</td> <td></td> <td>1</td> <td>PZ</td> </tr> <tr> <td>VT1322A0</td> <td></td> <td>1</td> <td>PZ</td> </tr> <tr> <td>VT1322C0</td> <td>EVEREO 900 10 GN1/1 INNER GLASS</td> <td>1</td> <td>PZ</td> </tr> </tbody> </table>	Code	Description	Qty	UOM	0H7837A0		2	PZ	IP1508A1	POLYSTYREN E U SHAPED PROFILE 2000X60X60	2	M	VI1982A0	M6 ST. STEEL BLIND THREADED INSERT	4	PZ	VM1059A1	HEAT SHRINK FILM H800	1.500	M	VT1322A0		1	PZ	VT1322A0		1	PZ	VT1322C0	EVEREO 900 10 GN1/1 INNER GLASS	1	PZ
Code	Description	Qty	UOM																																		
0H7837A0		2	PZ																																		
IP1508A1	POLYSTYREN E U SHAPED PROFILE 2000X60X60	2	M																																		
VI1982A0	M6 ST. STEEL BLIND THREADED INSERT	4	PZ																																		
VM1059A1	HEAT SHRINK FILM H800	1.500	M																																		
VT1322A0		1	PZ																																		
VT1322A0		1	PZ																																		
VT1322C0	EVEREO 900 10 GN1/1 INNER GLASS	1	PZ																																		



**ASM3520A/0.D02 - General overview**

**FRONT**

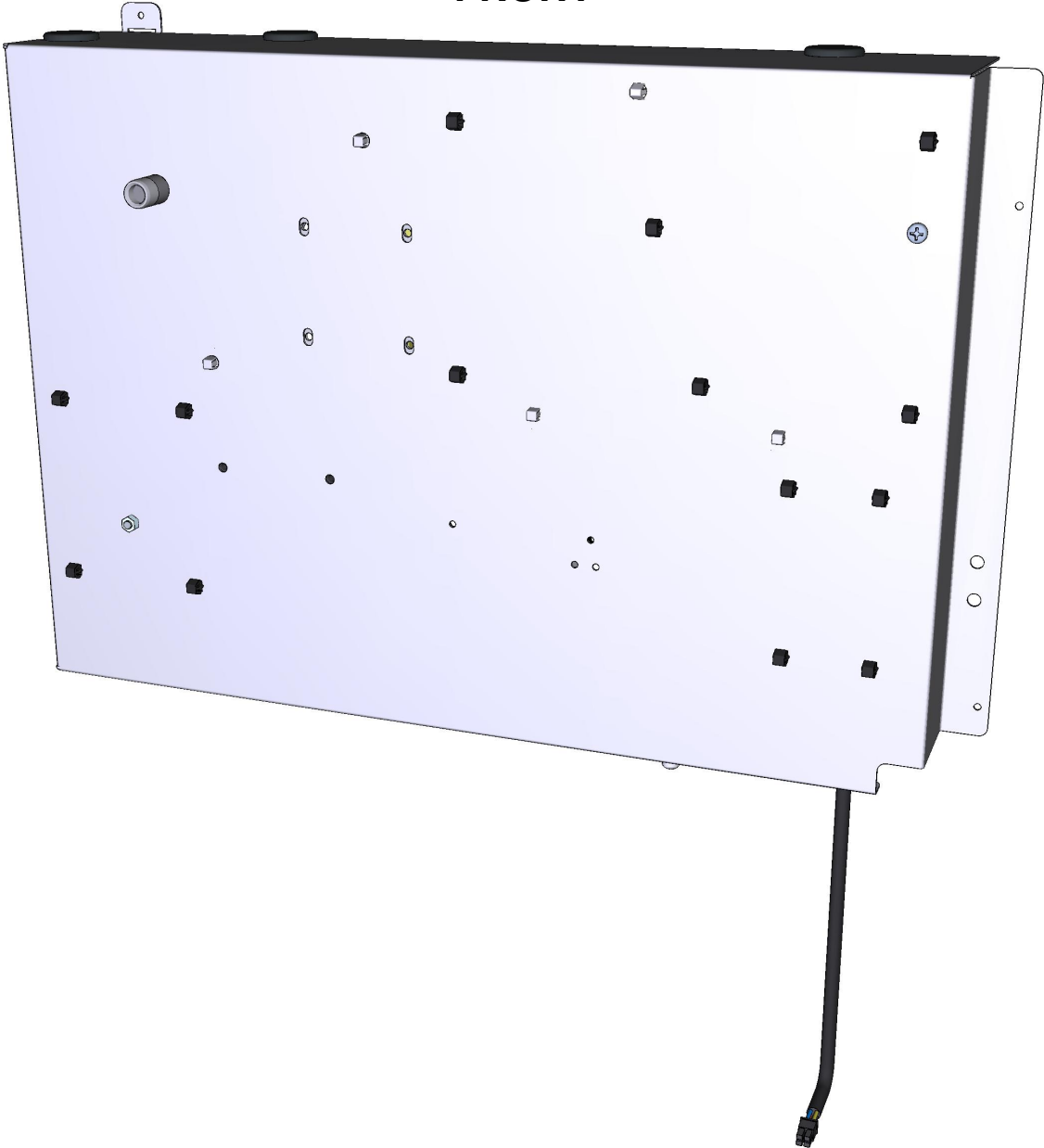



**ASM3520A/0.D02 - General overview**

**REAR**

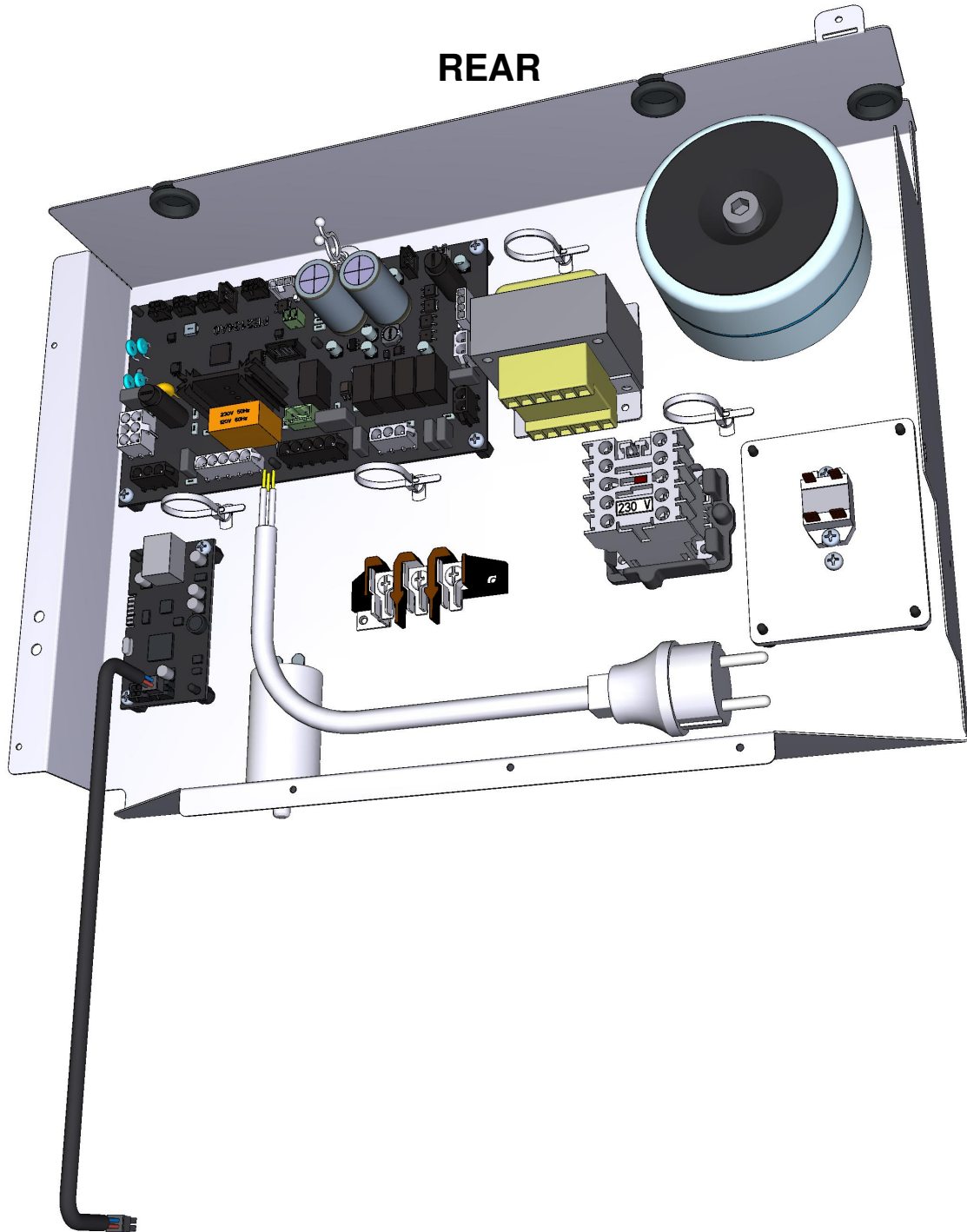







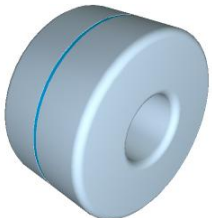
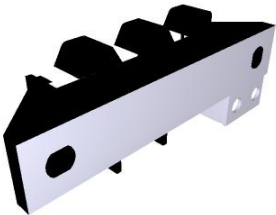
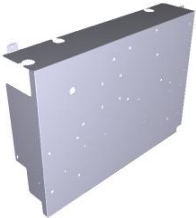



COMPONENT			SPARE PART																										
Code	Description	Image	Code	Description	Components list																								
VE1115A	20 A 230V 4 POLES MINICONTACTOR		KVE1115A	20A 230V 4 POLES MINICONTACTOR KI	<table border="1"> <thead> <tr> <th>Code</th> <th>Description</th> <th>Qty</th> <th>UOM</th> </tr> </thead> <tbody> <tr> <td>VE1115A0</td> <td>20 A 230V 4 POLES MINICONTACT OR</td> <td>1</td> <td>PZ</td> </tr> <tr> <td>VM1075A1</td> <td>PLASTIC CLIP TO FIX CONTACTORS</td> <td>4</td> <td>PZ</td> </tr> <tr> <td>VM1224A0</td> <td>65MY 220MM 2 COLOURS SHRINK TUBE</td> <td>0.250</td> <td>M</td> </tr> </tbody> </table>	Code	Description	Qty	UOM	VE1115A0	20 A 230V 4 POLES MINICONTACT OR	1	PZ	VM1075A1	PLASTIC CLIP TO FIX CONTACTORS	4	PZ	VM1224A0	65MY 220MM 2 COLOURS SHRINK TUBE	0.250	M								
					Code	Description	Qty	UOM																					
					VE1115A0	20 A 230V 4 POLES MINICONTACT OR	1	PZ																					
					VM1075A1	PLASTIC CLIP TO FIX CONTACTORS	4	PZ																					
VM1224A0	65MY 220MM 2 COLOURS SHRINK TUBE	0.250	M																										
VM1056A	SMALL CONTACTOR BRACKET VE1115A		VM1056A0	SMALL CONTACTOR BRACKET VE1115A																									
VE1150A	CAPACITOR 10 ?F 240 VAC 50/60		KVE1150A	10 ?F 240 VAC 50/60 CAPACITOR KIT	<table border="1"> <thead> <tr> <th>Code</th> <th>Description</th> <th>Qty</th> <th>UOM</th> </tr> </thead> <tbody> <tr> <td>VE1150A0</td> <td>CAPACITOR 10 ?F 240 VAC 50/60</td> <td>1</td> <td>PZ</td> </tr> <tr> <td>VI1931A0</td> <td>M8 NUT+INDENTE D WASHER D=8 X COND.</td> <td>1</td> <td>PZ</td> </tr> <tr> <td>VI1932A0</td> <td>M8 NUT+INDENTE D WASHER D=8 X COND.</td> <td>1</td> <td>PZ</td> </tr> <tr> <td>VM1224A0</td> <td>65MY 220MM 2 COLOURS SHRINK TUBE</td> <td>0.200</td> <td>M</td> </tr> </tbody> </table>	Code	Description	Qty	UOM	VE1150A0	CAPACITOR 10 ?F 240 VAC 50/60	1	PZ	VI1931A0	M8 NUT+INDENTE D WASHER D=8 X COND.	1	PZ	VI1932A0	M8 NUT+INDENTE D WASHER D=8 X COND.	1	PZ	VM1224A0	65MY 220MM 2 COLOURS SHRINK TUBE	0.200	M				
					Code	Description	Qty	UOM																					
					VE1150A0	CAPACITOR 10 ?F 240 VAC 50/60	1	PZ																					
					VI1931A0	M8 NUT+INDENTE D WASHER D=8 X COND.	1	PZ																					
VI1932A0	M8 NUT+INDENTE D WASHER D=8 X COND.	1	PZ																										
VM1224A0	65MY 220MM 2 COLOURS SHRINK TUBE	0.200	M																										
VM1505A	WALL PASSING WITH DIAPHRAGM		KVM1505A	THROUGH-WALL CONNECTION+DIAPHRAGM KIT	<table border="1"> <thead> <tr> <th>Code</th> <th>Description</th> <th>Qty</th> <th>UOM</th> </tr> </thead> <tbody> <tr> <td>VI1220A1</td> <td>4.2X12 TCB SELF-TAPPIN G SCREW</td> <td>1</td> <td>PZ</td> </tr> <tr> <td>VM1224A0</td> <td>65MY 220MM 2 COLOURS SHRINK TUBE</td> <td>0.200</td> <td>M</td> </tr> <tr> <td>VM1505A0</td> <td>WALL PASSING WITH DIAPHRAGM</td> <td>3</td> <td>PZ</td> </tr> <tr> <td>VM2055A0</td> <td>UPPER WALL PASSING ACCESSORY CABLES</td> <td>1</td> <td>PZ</td> </tr> <tr> <td>VM2056A0</td> <td>LOWER WALL PASSING ACCESSORY CABLES</td> <td>1</td> <td>PZ</td> </tr> </tbody> </table>	Code	Description	Qty	UOM	VI1220A1	4.2X12 TCB SELF-TAPPIN G SCREW	1	PZ	VM1224A0	65MY 220MM 2 COLOURS SHRINK TUBE	0.200	M	VM1505A0	WALL PASSING WITH DIAPHRAGM	3	PZ	VM2055A0	UPPER WALL PASSING ACCESSORY CABLES	1	PZ	VM2056A0	LOWER WALL PASSING ACCESSORY CABLES	1	PZ
					Code	Description	Qty	UOM																					
					VI1220A1	4.2X12 TCB SELF-TAPPIN G SCREW	1	PZ																					
					VM1224A0	65MY 220MM 2 COLOURS SHRINK TUBE	0.200	M																					
					VM1505A0	WALL PASSING WITH DIAPHRAGM	3	PZ																					
VM2055A0	UPPER WALL PASSING ACCESSORY CABLES	1	PZ																										
VM2056A0	LOWER WALL PASSING ACCESSORY CABLES	1	PZ																										





COMPONENT			SPARE PART																										
Code	Description	Image	Code	Description	Components list																								
VE1639A	TRANSFORMER 230-12VAC 60VA		KVE1639A	230-12VAC 60VA TRANSFORMER KIT	<table border="1"> <thead> <tr> <th>Code</th> <th>Description</th> <th>Qty</th> <th>UOM</th> </tr> </thead> <tbody> <tr> <td>VE1639A0</td> <td>TRANSFORME R 230-12VAC 60VA</td> <td>1</td> <td>PZ</td> </tr> <tr> <td>VI1950A0</td> <td>ST. STEEL 4,2X13 TCB SELF-DRILLIN G SCREW</td> <td>4</td> <td>PZ</td> </tr> </tbody> </table>	Code	Description	Qty	UOM	VE1639A0	TRANSFORME R 230-12VAC 60VA	1	PZ	VI1950A0	ST. STEEL 4,2X13 TCB SELF-DRILLIN G SCREW	4	PZ												
Code	Description	Qty	UOM																										
VE1639A0	TRANSFORME R 230-12VAC 60VA	1	PZ																										
VI1950A0	ST. STEEL 4,2X13 TCB SELF-DRILLIN G SCREW	4	PZ																										
VE1650A	0.5KVA 0-120-240V FAST AUTOTRANSFORME		KVE1650A	FAST 0.5KVA 0-120-240 AUTOTRANSF. KIT	<table border="1"> <thead> <tr> <th>Code</th> <th>Description</th> <th>Qty</th> <th>UOM</th> </tr> </thead> <tbody> <tr> <td>CE1155A0</td> <td>6,3X0,81 - 2,5 ALPACA FEMALE FASTON</td> <td>3</td> <td>PZ</td> </tr> <tr> <td>CE1660A0</td> <td>6,3X0,8 FEMALE FASTON COVE</td> <td>3</td> <td>PZ</td> </tr> <tr> <td>ED1378A0</td> <td>DECALCOMAN IA LABEL T500.S.010</td> <td>1</td> <td>PZ</td> </tr> <tr> <td>VE1027A0</td> <td>AUTOTRANSF ORMER 0.5KVA 0-120-240V</td> <td>1</td> <td>PZ</td> </tr> <tr> <td>VE1027A1</td> <td>0.5KVA 0-120-240V AUTOTRANSF ORMER</td> <td>1</td> <td>PZ</td> </tr> </tbody> </table>	Code	Description	Qty	UOM	CE1155A0	6,3X0,81 - 2,5 ALPACA FEMALE FASTON	3	PZ	CE1660A0	6,3X0,8 FEMALE FASTON COVE	3	PZ	ED1378A0	DECALCOMAN IA LABEL T500.S.010	1	PZ	VE1027A0	AUTOTRANSF ORMER 0.5KVA 0-120-240V	1	PZ	VE1027A1	0.5KVA 0-120-240V AUTOTRANSF ORMER	1	PZ
Code	Description	Qty	UOM																										
CE1155A0	6,3X0,81 - 2,5 ALPACA FEMALE FASTON	3	PZ																										
CE1660A0	6,3X0,8 FEMALE FASTON COVE	3	PZ																										
ED1378A0	DECALCOMAN IA LABEL T500.S.010	1	PZ																										
VE1027A0	AUTOTRANSF ORMER 0.5KVA 0-120-240V	1	PZ																										
VE1027A1	0.5KVA 0-120-240V AUTOTRANSF ORMER	1	PZ																										
MR1025A	3 POLES 450V 41A+GROUND TERMINAL BLOCK		KMR1025A	3 POLES TERMINAL BLOCK KIT	<table border="1"> <thead> <tr> <th>Code</th> <th>Description</th> <th>Qty</th> <th>UOM</th> </tr> </thead> <tbody> <tr> <td>MR1025A1</td> <td>3 POLES 450V 41A+GROUND TERMINAL BLOCK</td> <td>1</td> <td>PZ</td> </tr> <tr> <td>VM1224A0</td> <td>65MY 220MM 2 COLOURS SHRINK TUBE</td> <td>0.150</td> <td>M</td> </tr> </tbody> </table>	Code	Description	Qty	UOM	MR1025A1	3 POLES 450V 41A+GROUND TERMINAL BLOCK	1	PZ	VM1224A0	65MY 220MM 2 COLOURS SHRINK TUBE	0.150	M												
Code	Description	Qty	UOM																										
MR1025A1	3 POLES 450V 41A+GROUND TERMINAL BLOCK	1	PZ																										
VM1224A0	65MY 220MM 2 COLOURS SHRINK TUBE	0.150	M																										
0H8020A	GN1/1 EVEREO COMPONENT HOLDER PLATE		0H8020A1	GN1/1 EVEREO COMPONENT HOLDER PLATE																									

COMPONENT			SPARE PART														
Code	Description	Image	Code	Description	Components list												
VM1746A	H10 M4 JOINT BOARD FASTENING CLIP		KVM1746A	BOARD FIXING CLIP JOINT-M4 KIT	<table border="1"> <thead> <tr> <th>Code</th> <th>Description</th> <th>Qty</th> <th>UOM</th> </tr> </thead> <tbody> <tr> <td>VM1224A0</td> <td>65MY 220MM 2 COLOURS SHRINK TUBE</td> <td>0.250</td> <td>M</td> </tr> <tr> <td>VM1746A0</td> <td>H10 M4 JOINT BOARD FASTENING CLIP</td> <td>10</td> <td>PZ</td> </tr> </tbody> </table>	Code	Description	Qty	UOM	VM1224A0	65MY 220MM 2 COLOURS SHRINK TUBE	0.250	M	VM1746A0	H10 M4 JOINT BOARD FASTENING CLIP	10	PZ
Code	Description	Qty	UOM														
VM1224A0	65MY 220MM 2 COLOURS SHRINK TUBE	0.250	M														
VM1746A0	H10 M4 JOINT BOARD FASTENING CLIP	10	PZ														
VM1747A	JOINT-PIN H10 POWER BOARD FASTENING CLIP		KVM1747A	BOARD FIXING CLIP JOINT-PIN KIT	<table border="1"> <thead> <tr> <th>Code</th> <th>Description</th> <th>Qty</th> <th>UOM</th> </tr> </thead> <tbody> <tr> <td>VM1224A0</td> <td>65MY 220MM 2 COLOURS SHRINK TUBE</td> <td>0.250</td> <td>M</td> </tr> <tr> <td>VM1747A0</td> <td>JOINT-PIN H10 POWER BOARD FASTENING CLIP</td> <td>10</td> <td>PZ</td> </tr> </tbody> </table>	Code	Description	Qty	UOM	VM1224A0	65MY 220MM 2 COLOURS SHRINK TUBE	0.250	M	VM1747A0	JOINT-PIN H10 POWER BOARD FASTENING CLIP	10	PZ
Code	Description	Qty	UOM														
VM1224A0	65MY 220MM 2 COLOURS SHRINK TUBE	0.250	M														
VM1747A0	JOINT-PIN H10 POWER BOARD FASTENING CLIP	10	PZ														
PE2134A	EVEREO POWER BOARD		KPE2134A	EVEREO POWER BOARD KIT 2.0	<table border="1"> <thead> <tr> <th>Code</th> <th>Description</th> <th>Qty</th> <th>UOM</th> </tr> </thead> <tbody> <tr> <td>PE2134A0</td> <td>EVEREO POWER BOARD</td> <td>1</td> <td>PZ</td> </tr> <tr> <td>VM2147A0</td> <td>410X343X15 MM PINK SMOOTH ESD SPONGE</td> <td>1</td> <td>PZ</td> </tr> </tbody> </table>	Code	Description	Qty	UOM	PE2134A0	EVEREO POWER BOARD	1	PZ	VM2147A0	410X343X15 MM PINK SMOOTH ESD SPONGE	1	PZ
Code	Description	Qty	UOM														
PE2134A0	EVEREO POWER BOARD	1	PZ														
VM2147A0	410X343X15 MM PINK SMOOTH ESD SPONGE	1	PZ														
VM1747A	JOINT-PIN H10 POWER BOARD FASTENING CLIP		KVM1747A	BOARD FIXING CLIP JOINT-PIN KIT	<table border="1"> <thead> <tr> <th>Code</th> <th>Description</th> <th>Qty</th> <th>UOM</th> </tr> </thead> <tbody> <tr> <td>VM1224A0</td> <td>65MY 220MM 2 COLOURS SHRINK TUBE</td> <td>0.250</td> <td>M</td> </tr> <tr> <td>VM1747A0</td> <td>JOINT-PIN H10 POWER BOARD FASTENING CLIP</td> <td>10</td> <td>PZ</td> </tr> </tbody> </table>	Code	Description	Qty	UOM	VM1224A0	65MY 220MM 2 COLOURS SHRINK TUBE	0.250	M	VM1747A0	JOINT-PIN H10 POWER BOARD FASTENING CLIP	10	PZ
Code	Description	Qty	UOM														
VM1224A0	65MY 220MM 2 COLOURS SHRINK TUBE	0.250	M														
VM1747A0	JOINT-PIN H10 POWER BOARD FASTENING CLIP	10	PZ														
0H1906A	EVEREO SSR HEAT SINKS		0H1906A0	EVEREO SSR HEAT SINKS													

COMPONENT			SPARE PART																																						
Code	Description	Image	Code	Description	Components list																																				
VE1675A	25A 12VCC MINI-PUCK SSR		KVE1675A	25A MINI-PUCK SOLID STATE RELAY PAD KIT	<table border="1"> <thead> <tr> <th>Code</th> <th>Description</th> <th>Qty</th> <th>UOM</th> </tr> </thead> <tbody> <tr> <td>0H1906A0</td> <td>EVEREO SSR HEAT SINKS</td> <td>1</td> <td>PZ</td> </tr> <tr> <td>VE1675A0</td> <td>25A 12VCC MINI-PUCK SS</td> <td>1</td> <td>PZ</td> </tr> <tr> <td>V11075A0</td> <td>NUT M4 H=4 UNI5587 INOX</td> <td>1</td> <td>PZ</td> </tr> <tr> <td>V11945A0</td> <td>ENG-VITE M4X20 TCB+ INOX</td> <td>1</td> <td>PZ</td> </tr> <tr> <td>VM1224A0</td> <td>65MY 220MM 2 COLOURS SHRINK TUBE</td> <td>0.300</td> <td>M</td> </tr> </tbody> </table>	Code	Description	Qty	UOM	0H1906A0	EVEREO SSR HEAT SINKS	1	PZ	VE1675A0	25A 12VCC MINI-PUCK SS	1	PZ	V11075A0	NUT M4 H=4 UNI5587 INOX	1	PZ	V11945A0	ENG-VITE M4X20 TCB+ INOX	1	PZ	VM1224A0	65MY 220MM 2 COLOURS SHRINK TUBE	0.300	M												
Code	Description	Qty	UOM																																						
0H1906A0	EVEREO SSR HEAT SINKS	1	PZ																																						
VE1675A0	25A 12VCC MINI-PUCK SS	1	PZ																																						
V11075A0	NUT M4 H=4 UNI5587 INOX	1	PZ																																						
V11945A0	ENG-VITE M4X20 TCB+ INOX	1	PZ																																						
VM1224A0	65MY 220MM 2 COLOURS SHRINK TUBE	0.300	M																																						
PE2052A	MM LAN CONNECTION BRIDGE		XEC001	UNOX.LINK ETHERNET CONNECTION ONE/PLUS	<table border="1"> <thead> <tr> <th>Code</th> <th>Description</th> <th>Qty</th> <th>UOM</th> </tr> </thead> <tbody> <tr> <td>0H7386B0</td> <td>SOUS VIDE PROBE BOARD SUPPORT</td> <td>1</td> <td>PZ</td> </tr> <tr> <td>0H7451A0</td> <td>LAN SUPPORT PLATE</td> <td>1</td> <td>PZ</td> </tr> <tr> <td>CE1065A0</td> <td>4X0.5 MICROFIT WIRE 4P-500MM-MIC ROFIT4P</td> <td>1</td> <td>PZ</td> </tr> <tr> <td>PE2052A0</td> <td>MM LAN CONNECTION BRIDGE</td> <td>1</td> <td>PZ</td> </tr> <tr> <td>V11220A1</td> <td>4,2X12 TCB SELF-TAPPIN G SCREW</td> <td>2</td> <td>PZ</td> </tr> <tr> <td>V11850A0</td> <td>M4X6 NICKEL PLATED FIXING SCRE</td> <td>6</td> <td>PZ</td> </tr> <tr> <td>VM1745A0</td> <td>CARD SUPPORT</td> <td>4</td> <td>PZ</td> </tr> <tr> <td>VM2147A0</td> <td>410X343X15 MM PINK SMOOTH ESD SPONGE</td> <td>1</td> <td>PZ</td> </tr> </tbody> </table>	Code	Description	Qty	UOM	0H7386B0	SOUS VIDE PROBE BOARD SUPPORT	1	PZ	0H7451A0	LAN SUPPORT PLATE	1	PZ	CE1065A0	4X0.5 MICROFIT WIRE 4P-500MM-MIC ROFIT4P	1	PZ	PE2052A0	MM LAN CONNECTION BRIDGE	1	PZ	V11220A1	4,2X12 TCB SELF-TAPPIN G SCREW	2	PZ	V11850A0	M4X6 NICKEL PLATED FIXING SCRE	6	PZ	VM1745A0	CARD SUPPORT	4	PZ	VM2147A0	410X343X15 MM PINK SMOOTH ESD SPONGE	1	PZ
Code	Description	Qty	UOM																																						
0H7386B0	SOUS VIDE PROBE BOARD SUPPORT	1	PZ																																						
0H7451A0	LAN SUPPORT PLATE	1	PZ																																						
CE1065A0	4X0.5 MICROFIT WIRE 4P-500MM-MIC ROFIT4P	1	PZ																																						
PE2052A0	MM LAN CONNECTION BRIDGE	1	PZ																																						
V11220A1	4,2X12 TCB SELF-TAPPIN G SCREW	2	PZ																																						
V11850A0	M4X6 NICKEL PLATED FIXING SCRE	6	PZ																																						
VM1745A0	CARD SUPPORT	4	PZ																																						
VM2147A0	410X343X15 MM PINK SMOOTH ESD SPONGE	1	PZ																																						
VM1746A	H10 M4 JOINT BOARD FASTENING CLIP		KVM1746A	BOARD FIXING CLIP JOINT-M4 KIT	<table border="1"> <thead> <tr> <th>Code</th> <th>Description</th> <th>Qty</th> <th>UOM</th> </tr> </thead> <tbody> <tr> <td>VM1224A0</td> <td>65MY 220MM 2 COLOURS SHRINK TUBE</td> <td>0.250</td> <td>M</td> </tr> <tr> <td>VM1746A0</td> <td>H10 M4 JOINT BOARD FASTENING CLIP</td> <td>10</td> <td>PZ</td> </tr> </tbody> </table>	Code	Description	Qty	UOM	VM1224A0	65MY 220MM 2 COLOURS SHRINK TUBE	0.250	M	VM1746A0	H10 M4 JOINT BOARD FASTENING CLIP	10	PZ																								
Code	Description	Qty	UOM																																						
VM1224A0	65MY 220MM 2 COLOURS SHRINK TUBE	0.250	M																																						
VM1746A0	H10 M4 JOINT BOARD FASTENING CLIP	10	PZ																																						



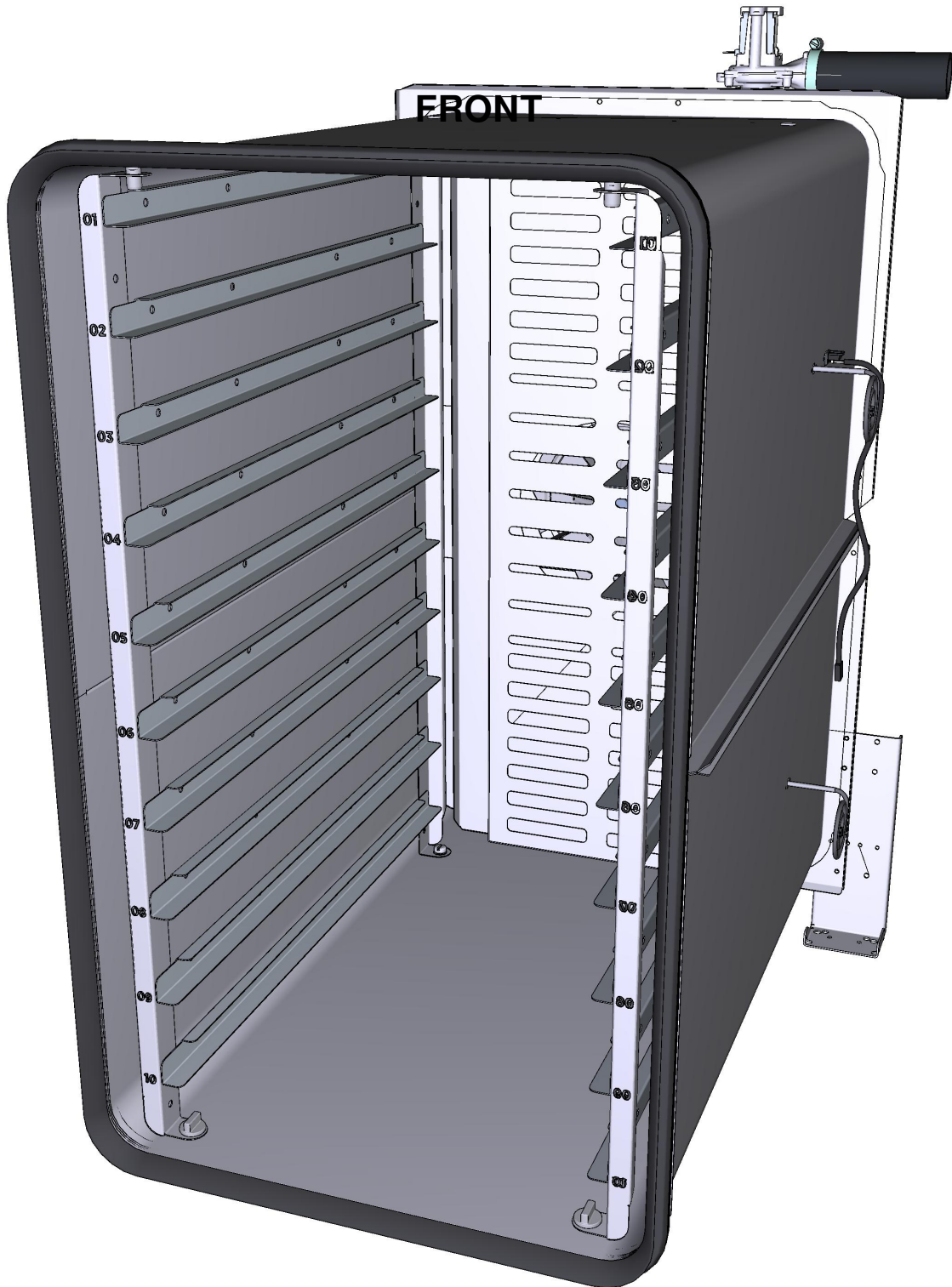

COMPONENT			SPARE PART														
Code	Description	Image	Code	Description	Components list												
VM1747A	JOINT-PIN H10 POWER BOARD FASTENING CLIP		KVM1747A	BOARD FIXING CLIP JOINT-PIN KIT	<table border="1"> <thead> <tr> <th>Code</th> <th>Description</th> <th>Qty</th> <th>UOM</th> </tr> </thead> <tbody> <tr> <td>VM1224A0</td> <td>65MY 220MM 2 COLOURS SHRINK TUBE</td> <td>0.250</td> <td>M</td> </tr> <tr> <td>VM1747A0</td> <td>JOINT-PIN H10 POWER BOARD FASTENING CLIP</td> <td>10</td> <td>PZ</td> </tr> </tbody> </table>	Code	Description	Qty	UOM	VM1224A0	65MY 220MM 2 COLOURS SHRINK TUBE	0.250	M	VM1747A0	JOINT-PIN H10 POWER BOARD FASTENING CLIP	10	PZ
Code	Description	Qty	UOM														
VM1224A0	65MY 220MM 2 COLOURS SHRINK TUBE	0.250	M														
VM1747A0	JOINT-PIN H10 POWER BOARD FASTENING CLIP	10	PZ														
CE1065A	4X0.5 MICROFIT WIRE 4P-500MM-MICROFI T4P		KCE1065A	4P-500MM MICROFIT CABLE KI	<table border="1"> <thead> <tr> <th>Code</th> <th>Description</th> <th>Qty</th> <th>UOM</th> </tr> </thead> <tbody> <tr> <td>CE1065A0</td> <td>4X0.5 MICROFIT WIRE 4P-500MM-MIC ROFIT4P</td> <td>1</td> <td>PZ</td> </tr> <tr> <td>VM1224A0</td> <td>65MY 220MM 2 COLOURS SHRINK TUBE</td> <td>0.200</td> <td>M</td> </tr> </tbody> </table>	Code	Description	Qty	UOM	CE1065A0	4X0.5 MICROFIT WIRE 4P-500MM-MIC ROFIT4P	1	PZ	VM1224A0	65MY 220MM 2 COLOURS SHRINK TUBE	0.200	M
Code	Description	Qty	UOM														
CE1065A0	4X0.5 MICROFIT WIRE 4P-500MM-MIC ROFIT4P	1	PZ														
VM1224A0	65MY 220MM 2 COLOURS SHRINK TUBE	0.200	M														

ASM4262B/0.D01 - Cooking chamber

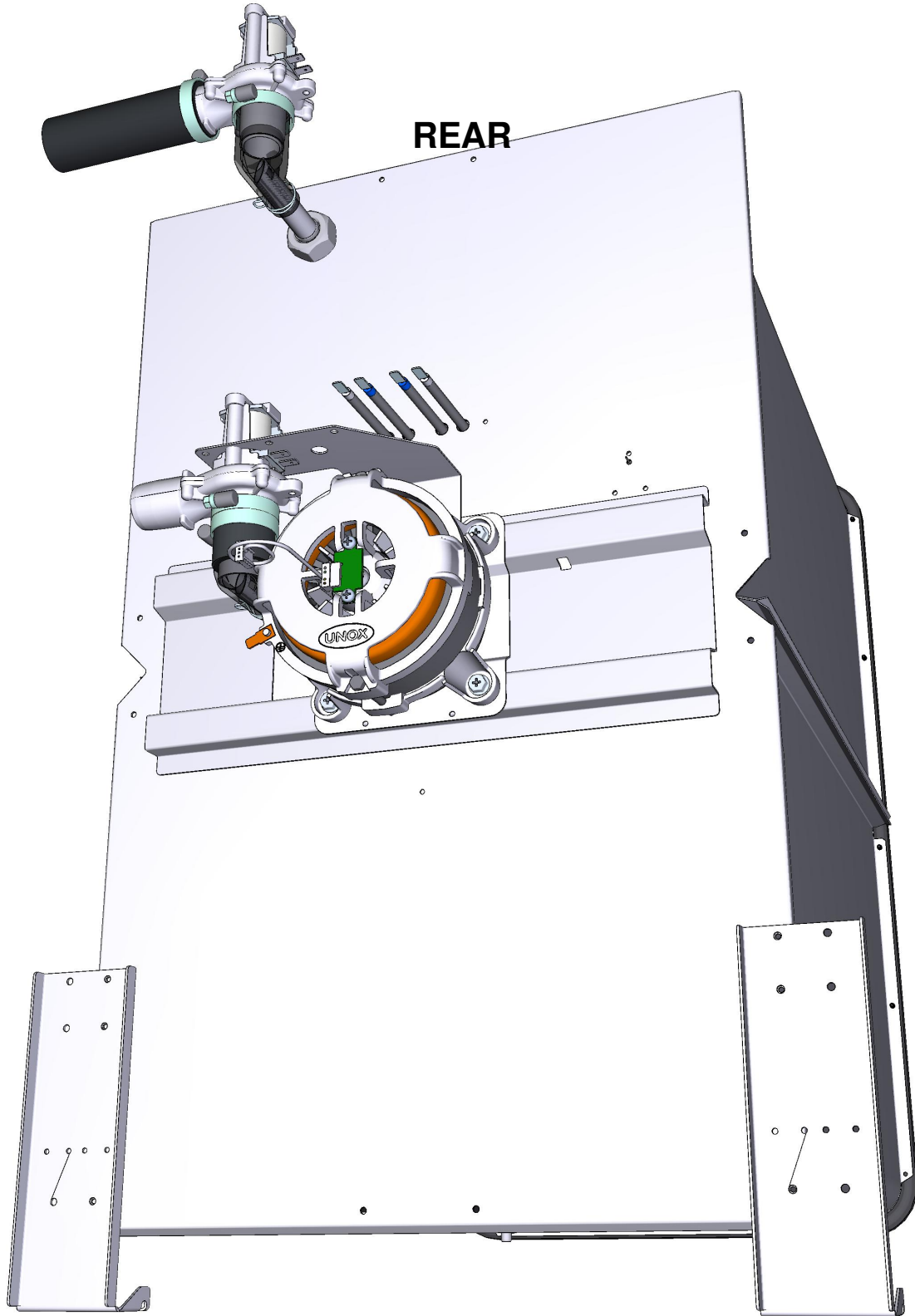

ASM4262B/0.D01 - Cooking chamber



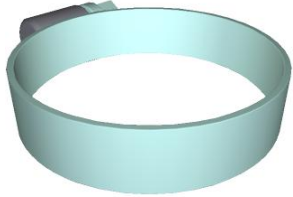



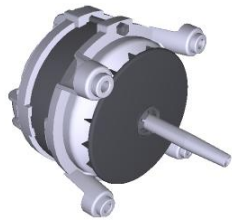

COMPONENT			SPARE PART																																																														
Code	Description	Image	Code	Description	Components list																																																												
VM1820A	LATERAL SUPPORTS M6 FIXING BOLT		KVM1820A	THUMB SCREW 10PCS KIT	<table border="1"> <thead> <tr> <th>Code</th> <th>Description</th> <th>Qty</th> <th>UOM</th> </tr> </thead> <tbody> <tr> <td>VM1224A0</td> <td>65MY 220MM 2 COLOURS SHRINK TUBE</td> <td>0.200</td> <td>M</td> </tr> <tr> <td>VM1820A0</td> <td>LATERAL SUPPORTS M6 FIXING BOLT</td> <td>10</td> <td>PZ</td> </tr> </tbody> </table>	Code	Description	Qty	UOM	VM1224A0	65MY 220MM 2 COLOURS SHRINK TUBE	0.200	M	VM1820A0	LATERAL SUPPORTS M6 FIXING BOLT	10	PZ																																																
Code	Description	Qty	UOM																																																														
VM1224A0	65MY 220MM 2 COLOURS SHRINK TUBE	0.200	M																																																														
VM1820A0	LATERAL SUPPORTS M6 FIXING BOLT	10	PZ																																																														
RC1378A	HOSE CLAMP		KVE1135A	SERIES 5/5E VENTURI KIT	<table border="1"> <thead> <tr> <th>Code</th> <th>Description</th> <th>Qty</th> <th>UOM</th> </tr> </thead> <tbody> <tr> <td>GN1556A0</td> <td>MM VENTURI SEAL</td> <td>1</td> <td>PZ</td> </tr> <tr> <td>RC1378A0</td> <td>HOSE CLAMP</td> <td>2</td> <td>PZ</td> </tr> <tr> <td>TB1520A0</td> <td>INT. Ø=38 TH=4 DRAIN BLACK RUBBER PIPE</td> <td>0.050</td> <td>M</td> </tr> <tr> <td>VE1135A0</td> <td>220 V 50/60 HZ VENTURI ACTUATOR</td> <td>1</td> <td>PZ</td> </tr> <tr> <td>VI1032A0</td> <td>SCREW M4X16 TCB+ INOX</td> <td>1</td> <td>PZ</td> </tr> <tr> <td>VI1511A0</td> <td>STAINLESS STEEL WASHER 4.2X12X1</td> <td>2</td> <td>PZ</td> </tr> <tr> <td>VI1850A0</td> <td>M4X6 NICKEL PLATED FIXING SCREW</td> <td>2</td> <td>PZ</td> </tr> <tr> <td>VI1865A0</td> <td>5X10 TCB+ SELF-THREADING SCREW</td> <td>3</td> <td>PZ</td> </tr> <tr> <td>VI1965A0</td> <td>M4X6 CROSS-HEAD ST. STEEL SCREW</td> <td>2</td> <td>PZ</td> </tr> <tr> <td>VM1224A0</td> <td>65MY 220MM 2 COLOURS SHRINK TUBE</td> <td>0.250</td> <td>M</td> </tr> <tr> <td>VM1565B0</td> <td>VENTURI LOWER COIL SUPPORT</td> <td>1</td> <td>PZ</td> </tr> <tr> <td>VM1566A0</td> <td>VENTURI UPPER COIL SUPPORT</td> <td>1</td> <td>PZ</td> </tr> <tr> <td>VM1567A0</td> <td>VENTURI LOWER BUSHING</td> <td>1</td> <td>PZ</td> </tr> <tr> <td>VM1568A0</td> <td>VENTURI PLATE SPACE</td> <td>1</td> <td>PZ</td> </tr> </tbody> </table>	Code	Description	Qty	UOM	GN1556A0	MM VENTURI SEAL	1	PZ	RC1378A0	HOSE CLAMP	2	PZ	TB1520A0	INT. Ø=38 TH=4 DRAIN BLACK RUBBER PIPE	0.050	M	VE1135A0	220 V 50/60 HZ VENTURI ACTUATOR	1	PZ	VI1032A0	SCREW M4X16 TCB+ INOX	1	PZ	VI1511A0	STAINLESS STEEL WASHER 4.2X12X1	2	PZ	VI1850A0	M4X6 NICKEL PLATED FIXING SCREW	2	PZ	VI1865A0	5X10 TCB+ SELF-THREADING SCREW	3	PZ	VI1965A0	M4X6 CROSS-HEAD ST. STEEL SCREW	2	PZ	VM1224A0	65MY 220MM 2 COLOURS SHRINK TUBE	0.250	M	VM1565B0	VENTURI LOWER COIL SUPPORT	1	PZ	VM1566A0	VENTURI UPPER COIL SUPPORT	1	PZ	VM1567A0	VENTURI LOWER BUSHING	1	PZ	VM1568A0	VENTURI PLATE SPACE	1	PZ
Code	Description	Qty	UOM																																																														
GN1556A0	MM VENTURI SEAL	1	PZ																																																														
RC1378A0	HOSE CLAMP	2	PZ																																																														
TB1520A0	INT. Ø=38 TH=4 DRAIN BLACK RUBBER PIPE	0.050	M																																																														
VE1135A0	220 V 50/60 HZ VENTURI ACTUATOR	1	PZ																																																														
VI1032A0	SCREW M4X16 TCB+ INOX	1	PZ																																																														
VI1511A0	STAINLESS STEEL WASHER 4.2X12X1	2	PZ																																																														
VI1850A0	M4X6 NICKEL PLATED FIXING SCREW	2	PZ																																																														
VI1865A0	5X10 TCB+ SELF-THREADING SCREW	3	PZ																																																														
VI1965A0	M4X6 CROSS-HEAD ST. STEEL SCREW	2	PZ																																																														
VM1224A0	65MY 220MM 2 COLOURS SHRINK TUBE	0.250	M																																																														
VM1565B0	VENTURI LOWER COIL SUPPORT	1	PZ																																																														
VM1566A0	VENTURI UPPER COIL SUPPORT	1	PZ																																																														
VM1567A0	VENTURI LOWER BUSHING	1	PZ																																																														
VM1568A0	VENTURI PLATE SPACE	1	PZ																																																														

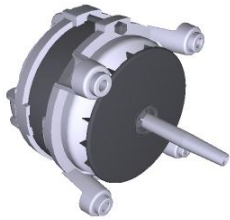

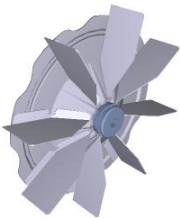





COMPONENT			SPARE PART																																														
Code	Description	Image	Code	Description	Components list																																												
MT1012A	330W 230V MOTOR		KVN1130A	LUX =08.2017/S.5/S.5E 330W MOTOR KIT	<table border="1"> <thead> <tr> <th>Code</th> <th>Description</th> <th>Qty</th> <th>UOM</th> </tr> </thead> <tbody> <tr> <td>0H4305A1</td> <td>ST. STEEL MOTOR SHAFT SEALING DISC</td> <td>1</td> <td>PZ</td> </tr> <tr> <td>GN1140A2</td> <td>MOTOR HOLDER GASKET</td> <td>1</td> <td>PZ</td> </tr> <tr> <td>GN1140A3</td> <td>MOLDED MOTOR HOLDER GASKET</td> <td>1</td> <td>PZ</td> </tr> <tr> <td>VI1045A0</td> <td>16X8,4 TH=1,6 ST.STEEL WASHER</td> <td>1</td> <td>PZ</td> </tr> <tr> <td>VI1256A0</td> <td>M8 DIN 980M ST. STEEL SELF LOCKING NUT</td> <td>1</td> <td>PZ</td> </tr> <tr> <td>VM1794A0</td> <td>250X4.8 PA66 BLACK CLAMP</td> <td>4</td> <td>PZ</td> </tr> <tr> <td>VM2103A0</td> <td>CLAMP LOCK</td> <td>4</td> <td>PZ</td> </tr> <tr> <td>VM2196A0</td> <td>MOTOR NUT FASTENING BUSHING</td> <td>1</td> <td>PZ</td> </tr> <tr> <td>VN1130A1</td> <td>330W 230V 50/60HZ MOTO</td> <td>1</td> <td>PZ</td> </tr> <tr> <td>VN1130A1</td> <td>330W 230V 50/60HZ MOTO</td> <td>1</td> <td>PZ</td> </tr> </tbody> </table>	Code	Description	Qty	UOM	0H4305A1	ST. STEEL MOTOR SHAFT SEALING DISC	1	PZ	GN1140A2	MOTOR HOLDER GASKET	1	PZ	GN1140A3	MOLDED MOTOR HOLDER GASKET	1	PZ	VI1045A0	16X8,4 TH=1,6 ST.STEEL WASHER	1	PZ	VI1256A0	M8 DIN 980M ST. STEEL SELF LOCKING NUT	1	PZ	VM1794A0	250X4.8 PA66 BLACK CLAMP	4	PZ	VM2103A0	CLAMP LOCK	4	PZ	VM2196A0	MOTOR NUT FASTENING BUSHING	1	PZ	VN1130A1	330W 230V 50/60HZ MOTO	1	PZ	VN1130A1	330W 230V 50/60HZ MOTO	1	PZ
			Code	Description	Qty	UOM																																											
0H4305A1	ST. STEEL MOTOR SHAFT SEALING DISC	1	PZ																																														
GN1140A2	MOTOR HOLDER GASKET	1	PZ																																														
GN1140A3	MOLDED MOTOR HOLDER GASKET	1	PZ																																														
VI1045A0	16X8,4 TH=1,6 ST.STEEL WASHER	1	PZ																																														
VI1256A0	M8 DIN 980M ST. STEEL SELF LOCKING NUT	1	PZ																																														
VM1794A0	250X4.8 PA66 BLACK CLAMP	4	PZ																																														
VM2103A0	CLAMP LOCK	4	PZ																																														
VM2196A0	MOTOR NUT FASTENING BUSHING	1	PZ																																														
VN1130A1	330W 230V 50/60HZ MOTO	1	PZ																																														
VN1130A1	330W 230V 50/60HZ MOTO	1	PZ																																														
KMT1012A	MIND.MAPS 330W 230V MOTOR KIT	<table border="1"> <thead> <tr> <th>Code</th> <th>Description</th> <th>Qty</th> <th>UOM</th> </tr> </thead> <tbody> <tr> <td>0H2842A0</td> <td></td> <td>1</td> <td>PZ</td> </tr> <tr> <td>0H4305A1</td> <td>ST. STEEL MOTOR SHAFT SEALING DISC</td> <td>1</td> <td>PZ</td> </tr> <tr> <td>GN1140A2</td> <td>MOTOR HOLDER GASKET</td> <td>1</td> <td>PZ</td> </tr> <tr> <td>GN1140A3</td> <td>MOLDED MOTOR HOLDER GASKET</td> <td>1</td> <td>PZ</td> </tr> <tr> <td>MOV0007A0</td> <td>HOOD RING GASKET GN1110A2</td> <td>0.100</td> <td>PZ</td> </tr> <tr> <td>MT1012A0</td> <td>330W 230V MOTOR</td> <td>1</td> <td>PZ</td> </tr> <tr> <td>VE1550A0</td> <td>5X3 MM NEODYMIUM MAGNET</td> <td>1</td> <td>PZ</td> </tr> <tr> <td>VI1077A1</td> <td>SCREW M6X12 TE INOX</td> <td>1</td> <td>PZ</td> </tr> </tbody> </table>	Code	Description	Qty	UOM	0H2842A0		1	PZ	0H4305A1	ST. STEEL MOTOR SHAFT SEALING DISC	1	PZ	GN1140A2	MOTOR HOLDER GASKET	1	PZ	GN1140A3	MOLDED MOTOR HOLDER GASKET	1	PZ	MOV0007A0	HOOD RING GASKET GN1110A2	0.100	PZ	MT1012A0	330W 230V MOTOR	1	PZ	VE1550A0	5X3 MM NEODYMIUM MAGNET	1	PZ	VI1077A1	SCREW M6X12 TE INOX	1	PZ											
Code	Description	Qty	UOM																																														
0H2842A0		1	PZ																																														
0H4305A1	ST. STEEL MOTOR SHAFT SEALING DISC	1	PZ																																														
GN1140A2	MOTOR HOLDER GASKET	1	PZ																																														
GN1140A3	MOLDED MOTOR HOLDER GASKET	1	PZ																																														
MOV0007A0	HOOD RING GASKET GN1110A2	0.100	PZ																																														
MT1012A0	330W 230V MOTOR	1	PZ																																														
VE1550A0	5X3 MM NEODYMIUM MAGNET	1	PZ																																														
VI1077A1	SCREW M6X12 TE INOX	1	PZ																																														

COMPONENT			SPARE PART																										
Code	Description	Image	Code	Description	Components list																								
MT1012A	330W 230V MOTOR		KMT1012A	MIND.MAPS 330W 230V MOTOR KIT	<table border="1"> <thead> <tr> <th>Code</th> <th>Description</th> <th>Qty</th> <th>UOM</th> </tr> </thead> <tbody> <tr> <td>VI1521A0</td> <td>STAINLESS STEEL WASHER D=6 6592</td> <td>1</td> <td>PZ</td> </tr> <tr> <td>VI1966A0</td> <td>M4X14 FLATHEAD SCREW</td> <td>1</td> <td>PZ</td> </tr> <tr> <td>VM1635A0</td> <td>MAGNET HOLDING DIS</td> <td>1</td> <td>PZ</td> </tr> <tr> <td>VM1794A0</td> <td>250X4.8 PA66 BLACK CLAMP</td> <td>4</td> <td>PZ</td> </tr> <tr> <td>VM2103A0</td> <td>CLAMP LOCK</td> <td>4</td> <td>PZ</td> </tr> </tbody> </table>	Code	Description	Qty	UOM	VI1521A0	STAINLESS STEEL WASHER D=6 6592	1	PZ	VI1966A0	M4X14 FLATHEAD SCREW	1	PZ	VM1635A0	MAGNET HOLDING DIS	1	PZ	VM1794A0	250X4.8 PA66 BLACK CLAMP	4	PZ	VM2103A0	CLAMP LOCK	4	PZ
					Code	Description	Qty	UOM																					
					VI1521A0	STAINLESS STEEL WASHER D=6 6592	1	PZ																					
					VI1966A0	M4X14 FLATHEAD SCREW	1	PZ																					
					VM1635A0	MAGNET HOLDING DIS	1	PZ																					
VM1794A0	250X4.8 PA66 BLACK CLAMP	4	PZ																										
VM2103A0	CLAMP LOCK	4	PZ																										
OH4305A	ST. STEEL MOTOR SHAFT SEALING DIS		KOH4305A	SEALING DISC FOR MOTOR SHAFT KIT	<table border="1"> <thead> <tr> <th>Code</th> <th>Description</th> <th>Qty</th> <th>UOM</th> </tr> </thead> <tbody> <tr> <td>OH4305A1</td> <td>ST. STEEL MOTOR SHAFT SEALING DISC</td> <td>1</td> <td>PZ</td> </tr> <tr> <td>GN1140A2</td> <td>MOTOR HOLDER GASKET</td> <td>1</td> <td>PZ</td> </tr> <tr> <td>GN1140A3</td> <td>MOLDED MOTOR HOLDER GASKET</td> <td>1</td> <td>PZ</td> </tr> <tr> <td>SL1045A0</td> <td>S57 BLACK SILICONE - 80ML CARTRIDGE</td> <td>1</td> <td>PZ</td> </tr> <tr> <td>VI1220A1</td> <td>4,2X12 TCB SELF-TAPPIN G SCREW</td> <td>3</td> <td>PZ</td> </tr> </tbody> </table>	Code	Description	Qty	UOM	OH4305A1	ST. STEEL MOTOR SHAFT SEALING DISC	1	PZ	GN1140A2	MOTOR HOLDER GASKET	1	PZ	GN1140A3	MOLDED MOTOR HOLDER GASKET	1	PZ	SL1045A0	S57 BLACK SILICONE - 80ML CARTRIDGE	1	PZ	VI1220A1	4,2X12 TCB SELF-TAPPIN G SCREW	3	PZ
					Code	Description	Qty	UOM																					
					OH4305A1	ST. STEEL MOTOR SHAFT SEALING DISC	1	PZ																					
					GN1140A2	MOTOR HOLDER GASKET	1	PZ																					
					GN1140A3	MOLDED MOTOR HOLDER GASKET	1	PZ																					
					SL1045A0	S57 BLACK SILICONE - 80ML CARTRIDGE	1	PZ																					
VI1220A1	4,2X12 TCB SELF-TAPPIN G SCREW	3	PZ																										
VN1172A	M8 NUT 8 BLADES H40 D195 FAN		KVN1172A	D195 H40 8 BLADES FAN+NUT M8 KIT	<table border="1"> <thead> <tr> <th>Code</th> <th>Description</th> <th>Qty</th> <th>UOM</th> </tr> </thead> <tbody> <tr> <td>VI1077A1</td> <td>SCREW M6X12 TE INOX</td> <td>1</td> <td>PZ</td> </tr> <tr> <td>VI1521A0</td> <td>STAINLESS STEEL WASHER D=6 6592</td> <td>1</td> <td>PZ</td> </tr> <tr> <td>VN1172A0</td> <td>M8 NUT 8 BLADES H40 D195 FAN</td> <td>1</td> <td>PZ</td> </tr> <tr> <td>VN1172A0</td> <td>M8 NUT 8 BLADES H40 D195 FAN</td> <td>1</td> <td>PZ</td> </tr> </tbody> </table>	Code	Description	Qty	UOM	VI1077A1	SCREW M6X12 TE INOX	1	PZ	VI1521A0	STAINLESS STEEL WASHER D=6 6592	1	PZ	VN1172A0	M8 NUT 8 BLADES H40 D195 FAN	1	PZ	VN1172A0	M8 NUT 8 BLADES H40 D195 FAN	1	PZ				
					Code	Description	Qty	UOM																					
					VI1077A1	SCREW M6X12 TE INOX	1	PZ																					
					VI1521A0	STAINLESS STEEL WASHER D=6 6592	1	PZ																					
					VN1172A0	M8 NUT 8 BLADES H40 D195 FAN	1	PZ																					
VN1172A0	M8 NUT 8 BLADES H40 D195 FAN	1	PZ																										

COMPONENT			SPARE PART																														
Code	Description	Image	Code	Description	Components list																												
0H7170A	MM MOTOR GLASS WOOL PLATE		0H7170A0	MM MOTOR GLASS WOOL PLATE																													
GN1642A	D12 DRIVE SHAFT GASKET		GN1642A0	D12 DRIVE SHAFT GASKET																													
PE1710B	MOTOR REVOLUTION AND DIRECTION SENSO		KPE1710B	MOTOR REVOLUTIONS SENSOR KIT	<table border="1"> <thead> <tr> <th>Code</th> <th>Description</th> <th>Qty</th> <th>UOM</th> </tr> </thead> <tbody> <tr> <td>CE1119A0</td> <td>AMPMODU2 4P 4XAWG22 L1500 RAST 4P CABLE</td> <td>1</td> <td>PZ</td> </tr> <tr> <td>PE1040A0</td> <td>RAST MOTOR SENSOR</td> <td>1</td> <td>PZ</td> </tr> <tr> <td>PE1710B0</td> <td>MOTOR REVOLUTION AND DIRECTION SENSOR</td> <td>1</td> <td>PZ</td> </tr> <tr> <td>VE1550A0</td> <td>5X3 MM NEODYMIUM MAGNET</td> <td>1</td> <td>PZ</td> </tr> <tr> <td>VI1966A0</td> <td>M4X14 FLATHEAD SCREW</td> <td>1</td> <td>PZ</td> </tr> <tr> <td>VM1635A0</td> <td>MAGNET HOLDING DIS</td> <td>1</td> <td>PZ</td> </tr> </tbody> </table>	Code	Description	Qty	UOM	CE1119A0	AMPMODU2 4P 4XAWG22 L1500 RAST 4P CABLE	1	PZ	PE1040A0	RAST MOTOR SENSOR	1	PZ	PE1710B0	MOTOR REVOLUTION AND DIRECTION SENSOR	1	PZ	VE1550A0	5X3 MM NEODYMIUM MAGNET	1	PZ	VI1966A0	M4X14 FLATHEAD SCREW	1	PZ	VM1635A0	MAGNET HOLDING DIS	1	PZ
Code	Description	Qty	UOM																														
CE1119A0	AMPMODU2 4P 4XAWG22 L1500 RAST 4P CABLE	1	PZ																														
PE1040A0	RAST MOTOR SENSOR	1	PZ																														
PE1710B0	MOTOR REVOLUTION AND DIRECTION SENSOR	1	PZ																														
VE1550A0	5X3 MM NEODYMIUM MAGNET	1	PZ																														
VI1966A0	M4X14 FLATHEAD SCREW	1	PZ																														
VM1635A0	MAGNET HOLDING DIS	1	PZ																														
GRL1509A	FOOD PRESERVER 10 GN1/1 LEFT LAT SUPP		KGRL1509A	EVEREO 900 LATERAL SUPPORTS KIT	<table border="1"> <thead> <tr> <th>Code</th> <th>Description</th> <th>Qty</th> <th>UOM</th> </tr> </thead> <tbody> <tr> <td>0H7204A1</td> <td>L514 GASTRONOM Y TRAYS GUIDE PROFIL</td> <td>20</td> <td>PZ</td> </tr> <tr> <td>0H7827A0</td> <td>EVEREO TRAY HOLDING BACK LEFT SUPP PROF</td> <td>1</td> <td>PZ</td> </tr> <tr> <td>0H7827A1</td> <td>EVEREO TRAY HOLDING BACK LEFT SUPP PROF</td> <td>1</td> <td>PZ</td> </tr> </tbody> </table>	Code	Description	Qty	UOM	0H7204A1	L514 GASTRONOM Y TRAYS GUIDE PROFIL	20	PZ	0H7827A0	EVEREO TRAY HOLDING BACK LEFT SUPP PROF	1	PZ	0H7827A1	EVEREO TRAY HOLDING BACK LEFT SUPP PROF	1	PZ												
Code	Description	Qty	UOM																														
0H7204A1	L514 GASTRONOM Y TRAYS GUIDE PROFIL	20	PZ																														
0H7827A0	EVEREO TRAY HOLDING BACK LEFT SUPP PROF	1	PZ																														
0H7827A1	EVEREO TRAY HOLDING BACK LEFT SUPP PROF	1	PZ																														

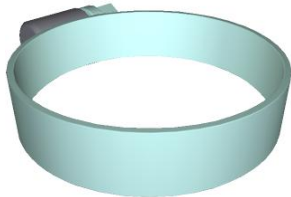

COMPONENT			SPARE PART																														
Code	Description	Image	Code	Description	Components list																												
GRL1509A	FOOD PRESERVER 10 GN1/1 LEFT LAT SUPP		KGRL1509A	EVEREO 900 LATERAL SUPPORTS KIT	<table border="1"> <thead> <tr> <th>Code</th> <th>Description</th> <th>Qty</th> <th>UOM</th> </tr> </thead> <tbody> <tr> <td>0H7829A1</td> <td>EVEREO TRAY HOLDING BACK RIGHT SUPP PROF</td> <td>2</td> <td>PZ</td> </tr> <tr> <td>IP1508A1</td> <td>POLYSTYREN E U SHAPED PROFILE 2000X60X60</td> <td>2</td> <td>M</td> </tr> <tr> <td>VM1059A1</td> <td>HEAT SHRINK FILM H800</td> <td>1.500</td> <td>M</td> </tr> </tbody> </table>	Code	Description	Qty	UOM	0H7829A1	EVEREO TRAY HOLDING BACK RIGHT SUPP PROF	2	PZ	IP1508A1	POLYSTYREN E U SHAPED PROFILE 2000X60X60	2	M	VM1059A1	HEAT SHRINK FILM H800	1.500	M												
Code	Description	Qty	UOM																														
0H7829A1	EVEREO TRAY HOLDING BACK RIGHT SUPP PROF	2	PZ																														
IP1508A1	POLYSTYREN E U SHAPED PROFILE 2000X60X60	2	M																														
VM1059A1	HEAT SHRINK FILM H800	1.500	M																														
GRL1510A	FOOD PRESERVER 10 GN1/1 RIGHT LAT SUPP		KGRL1509A	EVEREO 900 LATERAL SUPPORTS KIT	<table border="1"> <thead> <tr> <th>Code</th> <th>Description</th> <th>Qty</th> <th>UOM</th> </tr> </thead> <tbody> <tr> <td>0H7204A1</td> <td>L514 GASTRONOM Y TRAYS GUIDE PROFIL</td> <td>20</td> <td>PZ</td> </tr> <tr> <td>0H7827A0</td> <td>EVEREO TRAY HOLDING BACK LEFT SUPP PROF</td> <td>1</td> <td>PZ</td> </tr> <tr> <td>0H7827A1</td> <td>EVEREO TRAY HOLDING BACK LEFT SUPP PROF</td> <td>1</td> <td>PZ</td> </tr> <tr> <td>0H7829A1</td> <td>EVEREO TRAY HOLDING BACK RIGHT SUPP PROF</td> <td>2</td> <td>PZ</td> </tr> <tr> <td>IP1508A1</td> <td>POLYSTYREN E U SHAPED PROFILE 2000X60X60</td> <td>2</td> <td>M</td> </tr> <tr> <td>VM1059A1</td> <td>HEAT SHRINK FILM H800</td> <td>1.500</td> <td>M</td> </tr> </tbody> </table>	Code	Description	Qty	UOM	0H7204A1	L514 GASTRONOM Y TRAYS GUIDE PROFIL	20	PZ	0H7827A0	EVEREO TRAY HOLDING BACK LEFT SUPP PROF	1	PZ	0H7827A1	EVEREO TRAY HOLDING BACK LEFT SUPP PROF	1	PZ	0H7829A1	EVEREO TRAY HOLDING BACK RIGHT SUPP PROF	2	PZ	IP1508A1	POLYSTYREN E U SHAPED PROFILE 2000X60X60	2	M	VM1059A1	HEAT SHRINK FILM H800	1.500	M
Code	Description	Qty	UOM																														
0H7204A1	L514 GASTRONOM Y TRAYS GUIDE PROFIL	20	PZ																														
0H7827A0	EVEREO TRAY HOLDING BACK LEFT SUPP PROF	1	PZ																														
0H7827A1	EVEREO TRAY HOLDING BACK LEFT SUPP PROF	1	PZ																														
0H7829A1	EVEREO TRAY HOLDING BACK RIGHT SUPP PROF	2	PZ																														
IP1508A1	POLYSTYREN E U SHAPED PROFILE 2000X60X60	2	M																														
VM1059A1	HEAT SHRINK FILM H800	1.500	M																														
0C1748A	FOOD PRESERVER BACK FAN GUARD		0C1748A0	FOOD PRESERVER BACK FAN GUARD																													
0C1749A	FOOD PRESERVER FRONT FAN GUARD		0C1749A0	FOOD PRESERVER FRONT FAN GUARD																													

COMPONENT			SPARE PART																																																														
Code	Description	Image	Code	Description	Components list																																																												
0H7855A	FOOD PRESERVER MUFFLE SUPPORT		0H7855A1	FOOD PRESERVER MUFFLE SUPPORT																																																													
RC1378A	HOSE CLAMP		KVE1135A	SERIES 5/5E VENTURI KIT	<table border="1"> <thead> <tr> <th>Code</th> <th>Description</th> <th>Qty</th> <th>UOM</th> </tr> </thead> <tbody> <tr> <td>GN1556A0</td> <td>MM VENTURI SEAL</td> <td>1</td> <td>PZ</td> </tr> <tr> <td>RC1378A0</td> <td>HOSE CLAMP</td> <td>2</td> <td>PZ</td> </tr> <tr> <td>TB1520A0</td> <td>INT. Ø=38 TH=4 DRAIN BLACK RUBBER PIPE</td> <td>0.050</td> <td>M</td> </tr> <tr> <td>VE1135A0</td> <td>220 V 50/60 HZ VENTURI ACTUATOR</td> <td>1</td> <td>PZ</td> </tr> <tr> <td>VI1032A0</td> <td>SCREW M4X16 TCB+ INOX</td> <td>1</td> <td>PZ</td> </tr> <tr> <td>VI1511A0</td> <td>STAINLESS STEEL WASHER 4.2X12X1</td> <td>2</td> <td>PZ</td> </tr> <tr> <td>VI1850A0</td> <td>M4X6 NICKEL PLATED FIXING SCRE</td> <td>2</td> <td>PZ</td> </tr> <tr> <td>VI1865A0</td> <td>5X10 TCB+ SELF-THREADI NG SCREW</td> <td>3</td> <td>PZ</td> </tr> <tr> <td>VI1965A0</td> <td>M4X6 CROSS-HEAD ST. STEEL SCREW</td> <td>2</td> <td>PZ</td> </tr> <tr> <td>VM1224A0</td> <td>65MY 220MM 2 COLOURS SHRINK TUBE</td> <td>0.250</td> <td>M</td> </tr> <tr> <td>VM1565B0</td> <td>VENTURI LOWER COIL SUPPORT</td> <td>1</td> <td>PZ</td> </tr> <tr> <td>VM1566A0</td> <td>VENTURI UPPER COIL SUPPORT</td> <td>1</td> <td>PZ</td> </tr> <tr> <td>VM1567A0</td> <td>VENTURI LOWER BUSHING</td> <td>1</td> <td>PZ</td> </tr> <tr> <td>VM1568A0</td> <td>VENTURI PLATE SPACE</td> <td>1</td> <td>PZ</td> </tr> </tbody> </table>	Code	Description	Qty	UOM	GN1556A0	MM VENTURI SEAL	1	PZ	RC1378A0	HOSE CLAMP	2	PZ	TB1520A0	INT. Ø=38 TH=4 DRAIN BLACK RUBBER PIPE	0.050	M	VE1135A0	220 V 50/60 HZ VENTURI ACTUATOR	1	PZ	VI1032A0	SCREW M4X16 TCB+ INOX	1	PZ	VI1511A0	STAINLESS STEEL WASHER 4.2X12X1	2	PZ	VI1850A0	M4X6 NICKEL PLATED FIXING SCRE	2	PZ	VI1865A0	5X10 TCB+ SELF-THREADI NG SCREW	3	PZ	VI1965A0	M4X6 CROSS-HEAD ST. STEEL SCREW	2	PZ	VM1224A0	65MY 220MM 2 COLOURS SHRINK TUBE	0.250	M	VM1565B0	VENTURI LOWER COIL SUPPORT	1	PZ	VM1566A0	VENTURI UPPER COIL SUPPORT	1	PZ	VM1567A0	VENTURI LOWER BUSHING	1	PZ	VM1568A0	VENTURI PLATE SPACE	1	PZ
Code	Description	Qty	UOM																																																														
GN1556A0	MM VENTURI SEAL	1	PZ																																																														
RC1378A0	HOSE CLAMP	2	PZ																																																														
TB1520A0	INT. Ø=38 TH=4 DRAIN BLACK RUBBER PIPE	0.050	M																																																														
VE1135A0	220 V 50/60 HZ VENTURI ACTUATOR	1	PZ																																																														
VI1032A0	SCREW M4X16 TCB+ INOX	1	PZ																																																														
VI1511A0	STAINLESS STEEL WASHER 4.2X12X1	2	PZ																																																														
VI1850A0	M4X6 NICKEL PLATED FIXING SCRE	2	PZ																																																														
VI1865A0	5X10 TCB+ SELF-THREADI NG SCREW	3	PZ																																																														
VI1965A0	M4X6 CROSS-HEAD ST. STEEL SCREW	2	PZ																																																														
VM1224A0	65MY 220MM 2 COLOURS SHRINK TUBE	0.250	M																																																														
VM1565B0	VENTURI LOWER COIL SUPPORT	1	PZ																																																														
VM1566A0	VENTURI UPPER COIL SUPPORT	1	PZ																																																														
VM1567A0	VENTURI LOWER BUSHING	1	PZ																																																														
VM1568A0	VENTURI PLATE SPACE	1	PZ																																																														

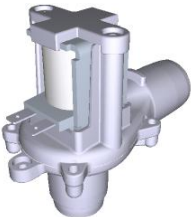
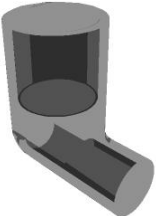
COMPONENT			SPARE PART																																																																														
Code	Description	Image	Code	Description	Components list																																																																												
VM2377A	220 V 50/60 HZ VENTURI KIT		KVM2377A	MM 220 V VENTURI ACTUATOR SYSTEM KIT	<table border="1"> <thead> <tr> <th>Code</th> <th>Description</th> <th>Qty</th> <th>UOM</th> </tr> </thead> <tbody> <tr> <td>GN1556A0</td> <td>MM VENTURI SEAL</td> <td>1</td> <td>PZ</td> </tr> <tr> <td>MOV0016A0</td> <td>HOOD RING GASKET GN1110A2</td> <td>0.100</td> <td>PZ</td> </tr> <tr> <td>RC1378A0</td> <td>HOSE CLAMP</td> <td>3</td> <td>PZ</td> </tr> <tr> <td>TB1520A0</td> <td>INT. Ø=38 TH=4 DRAIN BLACK RUBBER PIPE</td> <td>0.170</td> <td>M</td> </tr> <tr> <td>VE1135A0</td> <td>220 V 50/60 HZ VENTURI ACTUATOR</td> <td>1</td> <td>PZ</td> </tr> <tr> <td>VI1032A0</td> <td>SCREW M4X16 TCB+ INOX</td> <td>1</td> <td>PZ</td> </tr> <tr> <td>VI1220A1</td> <td>4,2X12 TCB SELF-TAPPIN G SCREW</td> <td>6</td> <td>PZ</td> </tr> <tr> <td>VM2345A0</td> <td>MM VENTURI UPPER BODY</td> <td>1</td> <td>PZ</td> </tr> <tr> <td>VM2345A0</td> <td>MM VENTURI UPPER BODY</td> <td>1</td> <td>PZ</td> </tr> <tr> <td>VM2346A0</td> <td>MM VENTURI LOWER BODY</td> <td>1</td> <td>PZ</td> </tr> <tr> <td>VM2346A0</td> <td>MM VENTURI LOWER BODY</td> <td>1</td> <td>PZ</td> </tr> <tr> <td>VM2346A1</td> <td>S6 VENTURI LOWER HALF</td> <td>1</td> <td>PZ</td> </tr> <tr> <td>VM2347A0</td> <td>VENTURI MIND.MAPS COVER</td> <td>1</td> <td>PZ</td> </tr> <tr> <td>VM2347A0</td> <td>VENTURI MIND.MAPS COVER</td> <td>1</td> <td>PZ</td> </tr> <tr> <td>VM2348A0</td> <td>VENTURI PLATE SPACE</td> <td>1</td> <td>PZ</td> </tr> <tr> <td>VM2348A0</td> <td>VENTURI PLATE SPACE</td> <td>1</td> <td>PZ</td> </tr> <tr> <td>VM2349A0</td> <td>VENTURI LOWER BUSHING</td> <td>1</td> <td>PZ</td> </tr> <tr> <td>VM2349A0</td> <td>VENTURI LOWER BUSHING</td> <td>1</td> <td>PZ</td> </tr> </tbody> </table>	Code	Description	Qty	UOM	GN1556A0	MM VENTURI SEAL	1	PZ	MOV0016A0	HOOD RING GASKET GN1110A2	0.100	PZ	RC1378A0	HOSE CLAMP	3	PZ	TB1520A0	INT. Ø=38 TH=4 DRAIN BLACK RUBBER PIPE	0.170	M	VE1135A0	220 V 50/60 HZ VENTURI ACTUATOR	1	PZ	VI1032A0	SCREW M4X16 TCB+ INOX	1	PZ	VI1220A1	4,2X12 TCB SELF-TAPPIN G SCREW	6	PZ	VM2345A0	MM VENTURI UPPER BODY	1	PZ	VM2345A0	MM VENTURI UPPER BODY	1	PZ	VM2346A0	MM VENTURI LOWER BODY	1	PZ	VM2346A0	MM VENTURI LOWER BODY	1	PZ	VM2346A1	S6 VENTURI LOWER HALF	1	PZ	VM2347A0	VENTURI MIND.MAPS COVER	1	PZ	VM2347A0	VENTURI MIND.MAPS COVER	1	PZ	VM2348A0	VENTURI PLATE SPACE	1	PZ	VM2348A0	VENTURI PLATE SPACE	1	PZ	VM2349A0	VENTURI LOWER BUSHING	1	PZ	VM2349A0	VENTURI LOWER BUSHING	1	PZ
					Code	Description	Qty	UOM																																																																									
					GN1556A0	MM VENTURI SEAL	1	PZ																																																																									
					MOV0016A0	HOOD RING GASKET GN1110A2	0.100	PZ																																																																									
					RC1378A0	HOSE CLAMP	3	PZ																																																																									
					TB1520A0	INT. Ø=38 TH=4 DRAIN BLACK RUBBER PIPE	0.170	M																																																																									
					VE1135A0	220 V 50/60 HZ VENTURI ACTUATOR	1	PZ																																																																									
					VI1032A0	SCREW M4X16 TCB+ INOX	1	PZ																																																																									
					VI1220A1	4,2X12 TCB SELF-TAPPIN G SCREW	6	PZ																																																																									
					VM2345A0	MM VENTURI UPPER BODY	1	PZ																																																																									
					VM2345A0	MM VENTURI UPPER BODY	1	PZ																																																																									
					VM2346A0	MM VENTURI LOWER BODY	1	PZ																																																																									
					VM2346A0	MM VENTURI LOWER BODY	1	PZ																																																																									
					VM2346A1	S6 VENTURI LOWER HALF	1	PZ																																																																									
					VM2347A0	VENTURI MIND.MAPS COVER	1	PZ																																																																									
					VM2347A0	VENTURI MIND.MAPS COVER	1	PZ																																																																									
					VM2348A0	VENTURI PLATE SPACE	1	PZ																																																																									
					VM2348A0	VENTURI PLATE SPACE	1	PZ																																																																									
					VM2349A0	VENTURI LOWER BUSHING	1	PZ																																																																									
					VM2349A0	VENTURI LOWER BUSHING	1	PZ																																																																									
GN1584A	CORNER FITTING D30-D16		KGN1584A	D30-D16 CORNER FITTING KIT	<table border="1"> <thead> <tr> <th>Code</th> <th>Description</th> <th>Qty</th> <th>UOM</th> </tr> </thead> <tbody> <tr> <td>GN1584A0</td> <td>CORNER FITTING D30-D16</td> <td>1</td> <td>PZ</td> </tr> <tr> <td>VM1224A0</td> <td>65MY 220MM 2 COLOURS SHRINK TUBE</td> <td>0.150</td> <td>M</td> </tr> </tbody> </table>	Code	Description	Qty	UOM	GN1584A0	CORNER FITTING D30-D16	1	PZ	VM1224A0	65MY 220MM 2 COLOURS SHRINK TUBE	0.150	M																																																																
					Code	Description	Qty	UOM																																																																									
GN1584A0	CORNER FITTING D30-D16	1	PZ																																																																														
VM1224A0	65MY 220MM 2 COLOURS SHRINK TUBE	0.150	M																																																																														



COMPONENT			SPARE PART																										
Code	Description	Image	Code	Description	Components list																								
RC1042A	DOUBLE WIRE SPRING CLAMP D21.5-22.6		KTB3074B	XEVC-0711-G VENTURI COLLECTOR PIPE KI	<table border="1"> <thead> <tr> <th>Code</th> <th>Description</th> <th>Qty</th> <th>UOM</th> </tr> </thead> <tbody> <tr> <td>GN1544A0</td> <td>AIR INLET GASKET</td> <td>1</td> <td>PZ</td> </tr> <tr> <td>GN1584A0</td> <td>CORNER FITTING D30-D16</td> <td>1</td> <td>PZ</td> </tr> <tr> <td>RC1042A0</td> <td>DOUBLE WIRE SPRING CLAMP D21.5-22.6</td> <td>1</td> <td>PZ</td> </tr> <tr> <td>TB3074B0</td> <td>XEVC-07EU-G VENTURI COLLECTOR PIPE D30</td> <td>1</td> <td>PZ</td> </tr> <tr> <td>VM1794A0</td> <td>250X4.8 PA66 BLACK CLAMP</td> <td>1</td> <td>PZ</td> </tr> </tbody> </table>	Code	Description	Qty	UOM	GN1544A0	AIR INLET GASKET	1	PZ	GN1584A0	CORNER FITTING D30-D16	1	PZ	RC1042A0	DOUBLE WIRE SPRING CLAMP D21.5-22.6	1	PZ	TB3074B0	XEVC-07EU-G VENTURI COLLECTOR PIPE D30	1	PZ	VM1794A0	250X4.8 PA66 BLACK CLAMP	1	PZ
					Code	Description	Qty	UOM																					
					GN1544A0	AIR INLET GASKET	1	PZ																					
					GN1584A0	CORNER FITTING D30-D16	1	PZ																					
			RC1042A0	DOUBLE WIRE SPRING CLAMP D21.5-22.6	1	PZ																							
			TB3074B0	XEVC-07EU-G VENTURI COLLECTOR PIPE D30	1	PZ																							
			VM1794A0	250X4.8 PA66 BLACK CLAMP	1	PZ																							
			KTB3068B	10FS/EU/2-G VENTURI COLLECTOR PIPE KI	<table border="1"> <thead> <tr> <th>Code</th> <th>Description</th> <th>Qty</th> <th>UOM</th> </tr> </thead> <tbody> <tr> <td>GN1544A0</td> <td>AIR INLET GASKET</td> <td>2</td> <td>PZ</td> </tr> <tr> <td>GN1584A0</td> <td>CORNER FITTING D30-D16</td> <td>1</td> <td>PZ</td> </tr> <tr> <td>RC1042A0</td> <td>DOUBLE WIRE SPRING CLAMP D21.5-22.6</td> <td>1</td> <td>PZ</td> </tr> <tr> <td>TB3068B0</td> <td>XEBC-10 VENTURI AIR COLLECTOR PIPE D30</td> <td>1</td> <td>PZ</td> </tr> <tr> <td>VM1794A0</td> <td>250X4.8 PA66 BLACK CLAMP</td> <td>1</td> <td>PZ</td> </tr> </tbody> </table>	Code	Description	Qty	UOM	GN1544A0	AIR INLET GASKET	2	PZ	GN1584A0	CORNER FITTING D30-D16	1	PZ	RC1042A0	DOUBLE WIRE SPRING CLAMP D21.5-22.6	1	PZ	TB3068B0	XEBC-10 VENTURI AIR COLLECTOR PIPE D30	1	PZ	VM1794A0	250X4.8 PA66 BLACK CLAMP	1	PZ
					Code	Description	Qty	UOM																					
					GN1544A0	AIR INLET GASKET	2	PZ																					
					GN1584A0	CORNER FITTING D30-D16	1	PZ																					
			RC1042A0	DOUBLE WIRE SPRING CLAMP D21.5-22.6	1	PZ																							
TB3068B0	XEBC-10 VENTURI AIR COLLECTOR PIPE D30	1	PZ																										
VM1794A0	250X4.8 PA66 BLACK CLAMP	1	PZ																										
KTB3019A	20XX/16XX UPPER VENTURI COLLECT PIPE KIT	<table border="1"> <thead> <tr> <th>Code</th> <th>Description</th> <th>Qty</th> <th>UOM</th> </tr> </thead> <tbody> <tr> <td>GN1544A0</td> <td>AIR INLET GASKET</td> <td>1</td> <td>PZ</td> </tr> <tr> <td>GN1584A0</td> <td>CORNER FITTING D30-D16</td> <td>1</td> <td>PZ</td> </tr> <tr> <td>RC1042A0</td> <td>DOUBLE WIRE SPRING CLAMP D21.5-22.6</td> <td>1</td> <td>PZ</td> </tr> <tr> <td>TB3019A1</td> <td>XEVC-2011 UPPER AIR INLET PIPE D3</td> <td>1</td> <td>PZ</td> </tr> <tr> <td>VM1794A0</td> <td>250X4.8 PA66 BLACK CLAMP</td> <td>1</td> <td>PZ</td> </tr> </tbody> </table>	Code	Description	Qty	UOM	GN1544A0	AIR INLET GASKET	1	PZ	GN1584A0	CORNER FITTING D30-D16	1	PZ	RC1042A0	DOUBLE WIRE SPRING CLAMP D21.5-22.6	1	PZ	TB3019A1	XEVC-2011 UPPER AIR INLET PIPE D3	1	PZ	VM1794A0	250X4.8 PA66 BLACK CLAMP	1	PZ			
		Code	Description	Qty	UOM																								
		GN1544A0	AIR INLET GASKET	1	PZ																								
		GN1584A0	CORNER FITTING D30-D16	1	PZ																								
RC1042A0	DOUBLE WIRE SPRING CLAMP D21.5-22.6	1	PZ																										
TB3019A1	XEVC-2011 UPPER AIR INLET PIPE D3	1	PZ																										
VM1794A0	250X4.8 PA66 BLACK CLAMP	1	PZ																										
KTB2979C	XEBC-10XX-E VENTURI COLLECTOR PIPE KI	<table border="1"> <thead> <tr> <th>Code</th> <th>Description</th> <th>Qty</th> <th>UOM</th> </tr> </thead> <tbody> <tr> <td>GN1544A0</td> <td>AIR INLET GASKET</td> <td>2</td> <td>PZ</td> </tr> </tbody> </table>	Code	Description	Qty	UOM	GN1544A0	AIR INLET GASKET	2	PZ																			
Code	Description	Qty	UOM																										
GN1544A0	AIR INLET GASKET	2	PZ																										







COMPONENT			SPARE PART																										
Code	Description	Image	Code	Description	Components list																								
RC1042A	DOUBLE WIRE SPRING CLAMP D21.5-22.6		KTB2979C	XEBC-10XX-E VENTURI COLLECTOR PIPE KI	<table border="1"> <thead> <tr> <th>Code</th> <th>Description</th> <th>Qty</th> <th>UOM</th> </tr> </thead> <tbody> <tr> <td>GN1584A0</td> <td>CORNER FITTING D30-D16</td> <td>1</td> <td>PZ</td> </tr> <tr> <td>RC1042A0</td> <td>DOUBLE WIRE SPRING CLAMP D21.5-22.6</td> <td>1</td> <td>PZ</td> </tr> <tr> <td>TB2979C0</td> <td>XEBC-10 VENTURI AIR COLLECTOR PIPE D30</td> <td>1</td> <td>PZ</td> </tr> <tr> <td>VM1794A0</td> <td>250X4.8 PA66 BLACK CLAMP</td> <td>1</td> <td>PZ</td> </tr> </tbody> </table>	Code	Description	Qty	UOM	GN1584A0	CORNER FITTING D30-D16	1	PZ	RC1042A0	DOUBLE WIRE SPRING CLAMP D21.5-22.6	1	PZ	TB2979C0	XEBC-10 VENTURI AIR COLLECTOR PIPE D30	1	PZ	VM1794A0	250X4.8 PA66 BLACK CLAMP	1	PZ				
					Code	Description	Qty	UOM																					
					GN1584A0	CORNER FITTING D30-D16	1	PZ																					
					RC1042A0	DOUBLE WIRE SPRING CLAMP D21.5-22.6	1	PZ																					
			TB2979C0	XEBC-10 VENTURI AIR COLLECTOR PIPE D30	1	PZ																							
			VM1794A0	250X4.8 PA66 BLACK CLAMP	1	PZ																							
			KTB2978B	XEBC-06 VENTURI COLLECTOR PIPE KI	<table border="1"> <thead> <tr> <th>Code</th> <th>Description</th> <th>Qty</th> <th>UOM</th> </tr> </thead> <tbody> <tr> <td>GN1544A0</td> <td>AIR INLET GASKET</td> <td>1</td> <td>PZ</td> </tr> <tr> <td>GN1584A0</td> <td>CORNER FITTING D30-D16</td> <td>1</td> <td>PZ</td> </tr> <tr> <td>RC1042A0</td> <td>DOUBLE WIRE SPRING CLAMP D21.5-22.6</td> <td>1</td> <td>PZ</td> </tr> <tr> <td>TB2978B0</td> <td>XEBC-06 VENTURI AIR COLLECTOR PIPE D30</td> <td>1</td> <td>PZ</td> </tr> <tr> <td>VM1794A0</td> <td>250X4.8 PA66 BLACK CLAMP</td> <td>1</td> <td>PZ</td> </tr> </tbody> </table>	Code	Description	Qty	UOM	GN1544A0	AIR INLET GASKET	1	PZ	GN1584A0	CORNER FITTING D30-D16	1	PZ	RC1042A0	DOUBLE WIRE SPRING CLAMP D21.5-22.6	1	PZ	TB2978B0	XEBC-06 VENTURI AIR COLLECTOR PIPE D30	1	PZ	VM1794A0	250X4.8 PA66 BLACK CLAMP	1	PZ
					Code	Description	Qty	UOM																					
					GN1544A0	AIR INLET GASKET	1	PZ																					
					GN1584A0	CORNER FITTING D30-D16	1	PZ																					
			RC1042A0	DOUBLE WIRE SPRING CLAMP D21.5-22.6	1	PZ																							
			TB2978B0	XEBC-06 VENTURI AIR COLLECTOR PIPE D30	1	PZ																							
VM1794A0	250X4.8 PA66 BLACK CLAMP	1	PZ																										
KTB2959B	XEVC-1011-E VENTURI COLLECTOR PIPE KI	<table border="1"> <thead> <tr> <th>Code</th> <th>Description</th> <th>Qty</th> <th>UOM</th> </tr> </thead> <tbody> <tr> <td>GN1544A0</td> <td>AIR INLET GASKET</td> <td>2</td> <td>PZ</td> </tr> <tr> <td>GN1584A0</td> <td>CORNER FITTING D30-D16</td> <td>1</td> <td>PZ</td> </tr> <tr> <td>RC1042A0</td> <td>DOUBLE WIRE SPRING CLAMP D21.5-22.6</td> <td>1</td> <td>PZ</td> </tr> <tr> <td>TB2959B0</td> <td>XEVC-1011-E VENTURI PIPE</td> <td>1</td> <td>PZ</td> </tr> <tr> <td>VM1794A0</td> <td>250X4.8 PA66 BLACK CLAMP</td> <td>1</td> <td>PZ</td> </tr> </tbody> </table>	Code	Description	Qty	UOM	GN1544A0	AIR INLET GASKET	2	PZ	GN1584A0	CORNER FITTING D30-D16	1	PZ	RC1042A0	DOUBLE WIRE SPRING CLAMP D21.5-22.6	1	PZ	TB2959B0	XEVC-1011-E VENTURI PIPE	1	PZ	VM1794A0	250X4.8 PA66 BLACK CLAMP	1	PZ			
		Code	Description	Qty	UOM																								
		GN1544A0	AIR INLET GASKET	2	PZ																								
		GN1584A0	CORNER FITTING D30-D16	1	PZ																								
RC1042A0	DOUBLE WIRE SPRING CLAMP D21.5-22.6	1	PZ																										
TB2959B0	XEVC-1011-E VENTURI PIPE	1	PZ																										
VM1794A0	250X4.8 PA66 BLACK CLAMP	1	PZ																										
KTB2958B	XEVC-0711-E VENTURI COLLECTOR PIPE KI	<table border="1"> <thead> <tr> <th>Code</th> <th>Description</th> <th>Qty</th> <th>UOM</th> </tr> </thead> <tbody> <tr> <td>GN1544A0</td> <td>AIR INLET GASKET</td> <td>1</td> <td>PZ</td> </tr> <tr> <td>GN1584A0</td> <td>CORNER FITTING D30-D16</td> <td>1</td> <td>PZ</td> </tr> </tbody> </table>	Code	Description	Qty	UOM	GN1544A0	AIR INLET GASKET	1	PZ	GN1584A0	CORNER FITTING D30-D16	1	PZ															
		Code	Description	Qty	UOM																								
GN1544A0	AIR INLET GASKET	1	PZ																										
GN1584A0	CORNER FITTING D30-D16	1	PZ																										





COMPONENT			SPARE PART																										
Code	Description	Image	Code	Description	Components list																								
RC1042A	DOUBLE WIRE SPRING CLAMP D21.5-22.6		KTB2958B	XEVC-0711-E VENTURI COLLECTOR PIPE KI	<table border="1"> <thead> <tr> <th>Code</th> <th>Description</th> <th>Qty</th> <th>UOM</th> </tr> </thead> <tbody> <tr> <td>RC1042A0</td> <td>DOUBLE WIRE SPRING CLAMP D21.5-22.6</td> <td>1</td> <td>PZ</td> </tr> <tr> <td>TB2958B0</td> <td>XEVC-0711-E VENTURI PIPE</td> <td>1</td> <td>PZ</td> </tr> <tr> <td>VM1794A0</td> <td>250X4.8 PA66 BLACK CLAMP</td> <td>1</td> <td>PZ</td> </tr> </tbody> </table>	Code	Description	Qty	UOM	RC1042A0	DOUBLE WIRE SPRING CLAMP D21.5-22.6	1	PZ	TB2958B0	XEVC-0711-E VENTURI PIPE	1	PZ	VM1794A0	250X4.8 PA66 BLACK CLAMP	1	PZ								
					Code	Description	Qty	UOM																					
					RC1042A0	DOUBLE WIRE SPRING CLAMP D21.5-22.6	1	PZ																					
			TB2958B0	XEVC-0711-E VENTURI PIPE	1	PZ																							
			VM1794A0	250X4.8 PA66 BLACK CLAMP	1	PZ																							
			KTB2957B	0511/04EU-E VENTURI COLLECTOR PIPE KI	<table border="1"> <thead> <tr> <th>Code</th> <th>Description</th> <th>Qty</th> <th>UOM</th> </tr> </thead> <tbody> <tr> <td>GN1544A0</td> <td>AIR INLET GASKET</td> <td>1</td> <td>PZ</td> </tr> <tr> <td>GN1584A0</td> <td>CORNER FITTING D30-D16</td> <td>1</td> <td>PZ</td> </tr> <tr> <td>RC1042A0</td> <td>DOUBLE WIRE SPRING CLAMP D21.5-22.6</td> <td>1</td> <td>PZ</td> </tr> <tr> <td>TB2957B0</td> <td>XEVC-0511-E VENTURI PIPE</td> <td>1</td> <td>PZ</td> </tr> <tr> <td>VM1794A0</td> <td>250X4.8 PA66 BLACK CLAMP</td> <td>1</td> <td>PZ</td> </tr> </tbody> </table>	Code	Description	Qty	UOM	GN1544A0	AIR INLET GASKET	1	PZ	GN1584A0	CORNER FITTING D30-D16	1	PZ	RC1042A0	DOUBLE WIRE SPRING CLAMP D21.5-22.6	1	PZ	TB2957B0	XEVC-0511-E VENTURI PIPE	1	PZ	VM1794A0	250X4.8 PA66 BLACK CLAMP	1	PZ
					Code	Description	Qty	UOM																					
					GN1544A0	AIR INLET GASKET	1	PZ																					
			GN1584A0	CORNER FITTING D30-D16	1	PZ																							
			RC1042A0	DOUBLE WIRE SPRING CLAMP D21.5-22.6	1	PZ																							
			TB2957B0	XEVC-0511-E VENTURI PIPE	1	PZ																							
			VM1794A0	250X4.8 PA66 BLACK CLAMP	1	PZ																							
KTB2956A	XEVC-0311-E VENTURI COLLECTOR PIPE KI	<table border="1"> <thead> <tr> <th>Code</th> <th>Description</th> <th>Qty</th> <th>UOM</th> </tr> </thead> <tbody> <tr> <td>GN1544A0</td> <td>AIR INLET GASKET</td> <td>1</td> <td>PZ</td> </tr> <tr> <td>RC1042A0</td> <td>DOUBLE WIRE SPRING CLAMP D21.5-22.6</td> <td>1</td> <td>PZ</td> </tr> <tr> <td>TB2956A0</td> <td>XEVC-0311-E VENTURI PIPE</td> <td>1</td> <td>PZ</td> </tr> </tbody> </table>	Code	Description	Qty	UOM	GN1544A0	AIR INLET GASKET	1	PZ	RC1042A0	DOUBLE WIRE SPRING CLAMP D21.5-22.6	1	PZ	TB2956A0	XEVC-0311-E VENTURI PIPE	1	PZ											
		Code	Description	Qty	UOM																								
		GN1544A0	AIR INLET GASKET	1	PZ																								
RC1042A0	DOUBLE WIRE SPRING CLAMP D21.5-22.6	1	PZ																										
TB2956A0	XEVC-0311-E VENTURI PIPE	1	PZ																										
KTB2944A	20XX/16XX LOWER VENTURI COLLECT PIPE KIT	<table border="1"> <thead> <tr> <th>Code</th> <th>Description</th> <th>Qty</th> <th>UOM</th> </tr> </thead> <tbody> <tr> <td>GN1544A0</td> <td>AIR INLET GASKET</td> <td>2</td> <td>PZ</td> </tr> <tr> <td>GN1584A0</td> <td>CORNER FITTING D30-D16</td> <td>1</td> <td>PZ</td> </tr> <tr> <td>RC1042A0</td> <td>DOUBLE WIRE SPRING CLAMP D21.5-22.6</td> <td>1</td> <td>PZ</td> </tr> <tr> <td>TB2944A1</td> <td>XEVC-2011 AIR INLET PIPE D3</td> <td>1</td> <td>PZ</td> </tr> <tr> <td>VM1794A0</td> <td>250X4.8 PA66 BLACK CLAMP</td> <td>1</td> <td>PZ</td> </tr> </tbody> </table>	Code	Description	Qty	UOM	GN1544A0	AIR INLET GASKET	2	PZ	GN1584A0	CORNER FITTING D30-D16	1	PZ	RC1042A0	DOUBLE WIRE SPRING CLAMP D21.5-22.6	1	PZ	TB2944A1	XEVC-2011 AIR INLET PIPE D3	1	PZ	VM1794A0	250X4.8 PA66 BLACK CLAMP	1	PZ			
		Code	Description	Qty	UOM																								
		GN1544A0	AIR INLET GASKET	2	PZ																								
		GN1584A0	CORNER FITTING D30-D16	1	PZ																								
		RC1042A0	DOUBLE WIRE SPRING CLAMP D21.5-22.6	1	PZ																								
TB2944A1	XEVC-2011 AIR INLET PIPE D3	1	PZ																										
VM1794A0	250X4.8 PA66 BLACK CLAMP	1	PZ																										
KTB1323A	XECC-05XX-E VENTURI COLLECTOR PIPE KI	<table border="1"> <thead> <tr> <th>Code</th> <th>Description</th> <th>Qty</th> <th>UOM</th> </tr> </thead> <tbody> <tr> <td>GN1544A0</td> <td>AIR INLET GASKET</td> <td>1</td> <td>PZ</td> </tr> </tbody> </table>	Code	Description	Qty	UOM	GN1544A0	AIR INLET GASKET	1	PZ																			
		Code	Description	Qty	UOM																								
GN1544A0	AIR INLET GASKET	1	PZ																										





COMPONENT			SPARE PART																						
Code	Description	Image	Code	Description	Components list																				
RC1042A	DOUBLE WIRE SPRING CLAMP D21.5-22.6		KTB1323A	XECC-05XX-E VENTURI COLLECTOR PIPE KI	<table border="1"> <thead> <tr> <th>Code</th> <th>Description</th> <th>Qty</th> <th>UOM</th> </tr> </thead> <tbody> <tr> <td>GN1584A0</td> <td>CORNER FITTING D30-D16</td> <td>1</td> <td>PZ</td> </tr> <tr> <td>RC1042A0</td> <td>DOUBLE WIRE SPRING CLAMP D21.5-22.6</td> <td>1</td> <td>PZ</td> </tr> <tr> <td>TB1323A1</td> <td>XECC-05XX VENTURI AIR EXIT PIPE</td> <td>1</td> <td>PZ</td> </tr> </tbody> </table>	Code	Description	Qty	UOM	GN1584A0	CORNER FITTING D30-D16	1	PZ	RC1042A0	DOUBLE WIRE SPRING CLAMP D21.5-22.6	1	PZ	TB1323A1	XECC-05XX VENTURI AIR EXIT PIPE	1	PZ				
					Code	Description	Qty	UOM																	
GN1584A0	CORNER FITTING D30-D16	1	PZ																						
RC1042A0	DOUBLE WIRE SPRING CLAMP D21.5-22.6	1	PZ																						
TB1323A1	XECC-05XX VENTURI AIR EXIT PIPE	1	PZ																						
0H7358A	COMPACT MM VENTURI PIPE SUPPORT		0H7358A0	COMPACT MM VENTURI PIPE SUPPORT																					
TB1783A			TB1783A0																						
VM1690A	HUMIDITY PROBE SUPPORT XL405		KVM1690A	HUMIDITY SENSOR SUPPORT KIT	<table border="1"> <thead> <tr> <th>Code</th> <th>Description</th> <th>Qty</th> <th>UOM</th> </tr> </thead> <tbody> <tr> <td>VM1224A0</td> <td>65MY 220MM 2 COLOURS SHRINK TUBE</td> <td>0.150</td> <td>M</td> </tr> <tr> <td>VM1690A0</td> <td>HUMIDITY PROBE SUPPORT XL405</td> <td>1</td> <td>PZ</td> </tr> </tbody> </table>	Code	Description	Qty	UOM	VM1224A0	65MY 220MM 2 COLOURS SHRINK TUBE	0.150	M	VM1690A0	HUMIDITY PROBE SUPPORT XL405	1	PZ								
					Code	Description	Qty	UOM																	
VM1224A0	65MY 220MM 2 COLOURS SHRINK TUBE	0.150	M																						
VM1690A0	HUMIDITY PROBE SUPPORT XL405	1	PZ																						
GN1285A	NTC TEMPERATURE PROBE SEALING		KTR1106B	MIND.MAPS L2000 CHAMBER TEMP. PROBE KIT	<table border="1"> <thead> <tr> <th>Code</th> <th>Description</th> <th>Qty</th> <th>UOM</th> </tr> </thead> <tbody> <tr> <td>GN1285A0</td> <td>NTC TEMPERATUR E PROBE SEALING</td> <td>1</td> <td>PZ</td> </tr> <tr> <td>SL1045A0</td> <td>S57 BLACK SILICONE - 80ML CARTRIDGE</td> <td>1</td> <td>PZ</td> </tr> <tr> <td>TR1106B0</td> <td></td> <td>1</td> <td>PZ</td> </tr> <tr> <td>V11220A1</td> <td>4,2X12 TCB SELF-TAPPIN G SCREW</td> <td>2</td> <td>PZ</td> </tr> </tbody> </table>	Code	Description	Qty	UOM	GN1285A0	NTC TEMPERATUR E PROBE SEALING	1	PZ	SL1045A0	S57 BLACK SILICONE - 80ML CARTRIDGE	1	PZ	TR1106B0		1	PZ	V11220A1	4,2X12 TCB SELF-TAPPIN G SCREW	2	PZ
Code	Description	Qty	UOM																						
GN1285A0	NTC TEMPERATUR E PROBE SEALING	1	PZ																						
SL1045A0	S57 BLACK SILICONE - 80ML CARTRIDGE	1	PZ																						
TR1106B0		1	PZ																						
V11220A1	4,2X12 TCB SELF-TAPPIN G SCREW	2	PZ																						





COMPONENT			SPARE PART																											
Code	Description	Image	Code	Description	Components list																									
GN1285A	NTC TEMPERATURE PROBE SEALING		KTR1106B	MIND.MAPS L2000 CHAMBER TEMP. PROBE KIT	<table border="1"> <thead> <tr> <th>Code</th> <th>Description</th> <th>Qty</th> <th>UOM</th> </tr> </thead> <tbody> <tr> <td>VM1464A1</td> <td>CT BT TEMPERATUR E PROBE COVER</td> <td>1</td> <td>PZ</td> </tr> <tr> <td>VM1465A0</td> <td>CHEFTOP TEMPERATUR E PROBE COVER</td> <td>1</td> <td>PZ</td> </tr> <tr> <td>VM1465A1</td> <td>CT BT TEMPERATUR E PROBE COVER</td> <td>1</td> <td>PZ</td> </tr> </tbody> </table>	Code	Description	Qty	UOM	VM1464A1	CT BT TEMPERATUR E PROBE COVER	1	PZ	VM1465A0	CHEFTOP TEMPERATUR E PROBE COVER	1	PZ	VM1465A1	CT BT TEMPERATUR E PROBE COVER	1	PZ									
			Code	Description	Qty	UOM																								
			VM1464A1	CT BT TEMPERATUR E PROBE COVER	1	PZ																								
VM1465A0	CHEFTOP TEMPERATUR E PROBE COVER	1	PZ																											
VM1465A1	CT BT TEMPERATUR E PROBE COVER	1	PZ																											
KTR1106A	5-5E S. L2000 CHAMBER TEMP. PROBE KIT	<table border="1"> <thead> <tr> <th>Code</th> <th>Description</th> <th>Qty</th> <th>UOM</th> </tr> </thead> <tbody> <tr> <td>GN1285A0</td> <td>NTC TEMPERATUR E PROBE SEALING</td> <td>1</td> <td>PZ</td> </tr> <tr> <td>SL1045A0</td> <td>S57 BLACK SILICONE - 80ML CARTRIDGE</td> <td>1</td> <td>PZ</td> </tr> <tr> <td>TR1106A3</td> <td>PT100 L=2000 TEMPERATUR E PROBE</td> <td>1</td> <td>PZ</td> </tr> <tr> <td>VI1220A1</td> <td>4,2X12 TCB SELF-TAPPIN G SCREW</td> <td>2</td> <td>PZ</td> </tr> <tr> <td>VM1465A0</td> <td>CHEFTOP TEMPERATUR E PROBE COVER</td> <td>1</td> <td>PZ</td> </tr> <tr> <td>VM1465A1</td> <td>CT BT TEMPERATUR E PROBE COVER</td> <td>1</td> <td>PZ</td> </tr> </tbody> </table>	Code	Description	Qty	UOM	GN1285A0	NTC TEMPERATUR E PROBE SEALING	1	PZ	SL1045A0	S57 BLACK SILICONE - 80ML CARTRIDGE	1	PZ	TR1106A3	PT100 L=2000 TEMPERATUR E PROBE	1	PZ	VI1220A1	4,2X12 TCB SELF-TAPPIN G SCREW	2	PZ	VM1465A0	CHEFTOP TEMPERATUR E PROBE COVER	1	PZ	VM1465A1	CT BT TEMPERATUR E PROBE COVER	1	PZ
Code	Description	Qty	UOM																											
GN1285A0	NTC TEMPERATUR E PROBE SEALING	1	PZ																											
SL1045A0	S57 BLACK SILICONE - 80ML CARTRIDGE	1	PZ																											
TR1106A3	PT100 L=2000 TEMPERATUR E PROBE	1	PZ																											
VI1220A1	4,2X12 TCB SELF-TAPPIN G SCREW	2	PZ																											
VM1465A0	CHEFTOP TEMPERATUR E PROBE COVER	1	PZ																											
VM1465A1	CT BT TEMPERATUR E PROBE COVER	1	PZ																											
KTR1105A	PT100 L1000 TEMPERATURE PROBE KIT	<table border="1"> <thead> <tr> <th>Code</th> <th>Description</th> <th>Qty</th> <th>UOM</th> </tr> </thead> <tbody> <tr> <td>GN1120A0</td> <td>NTC TEMPERATUR E PROBE SEAL</td> <td>1</td> <td>PZ</td> </tr> <tr> <td>GN1120A1</td> <td>NTC TEMPERATUR E PROBE SEAL</td> <td>1</td> <td>PZ</td> </tr> <tr> <td>GN1285A0</td> <td>NTC TEMPERATUR E PROBE SEALING</td> <td>1</td> <td>PZ</td> </tr> <tr> <td>MOV0010A0</td> <td>HOOD RING GASKET GN1110A2</td> <td>0.100</td> <td>PZ</td> </tr> <tr> <td>SL1045A0</td> <td>S57 BLACK SILICONE - 80ML CARTRIDGE</td> <td>1</td> <td>PZ</td> </tr> </tbody> </table>	Code	Description	Qty	UOM	GN1120A0	NTC TEMPERATUR E PROBE SEAL	1	PZ	GN1120A1	NTC TEMPERATUR E PROBE SEAL	1	PZ	GN1285A0	NTC TEMPERATUR E PROBE SEALING	1	PZ	MOV0010A0	HOOD RING GASKET GN1110A2	0.100	PZ	SL1045A0	S57 BLACK SILICONE - 80ML CARTRIDGE	1	PZ				
Code	Description	Qty	UOM																											
GN1120A0	NTC TEMPERATUR E PROBE SEAL	1	PZ																											
GN1120A1	NTC TEMPERATUR E PROBE SEAL	1	PZ																											
GN1285A0	NTC TEMPERATUR E PROBE SEALING	1	PZ																											
MOV0010A0	HOOD RING GASKET GN1110A2	0.100	PZ																											
SL1045A0	S57 BLACK SILICONE - 80ML CARTRIDGE	1	PZ																											



COMPONENT			SPARE PART																																			
Code	Description	Image	Code	Description	Components list																																	
GN1285A	NTC TEMPERATURE PROBE SEALING		KTR1105A	PT100 L1000 TEMPERATURE PROBE KIT	<table border="1"> <thead> <tr> <th>Code</th> <th>Description</th> <th>Qty</th> <th>UOM</th> </tr> </thead> <tbody> <tr> <td>TR1105A4</td> <td>L1000 PT100 TEMPERATUR E PROBE</td> <td>1</td> <td>PZ</td> </tr> <tr> <td>VI1220A1</td> <td>4,2X12 TCB SELF-TAPPIN G SCREW</td> <td>2</td> <td>PZ</td> </tr> <tr> <td>VM1464A1</td> <td>CT BT TEMPERATUR E PROBE COVER</td> <td>1</td> <td>PZ</td> </tr> <tr> <td>VM1465A1</td> <td>CT BT TEMPERATUR E PROBE COVER</td> <td>1</td> <td>PZ</td> </tr> <tr> <td>VM2052A0</td> <td>LM CORE PROBE COVE</td> <td>1</td> <td>PZ</td> </tr> </tbody> </table>	Code	Description	Qty	UOM	TR1105A4	L1000 PT100 TEMPERATUR E PROBE	1	PZ	VI1220A1	4,2X12 TCB SELF-TAPPIN G SCREW	2	PZ	VM1464A1	CT BT TEMPERATUR E PROBE COVER	1	PZ	VM1465A1	CT BT TEMPERATUR E PROBE COVER	1	PZ	VM2052A0	LM CORE PROBE COVE	1	PZ									
			Code	Description	Qty	UOM																																
			TR1105A4	L1000 PT100 TEMPERATUR E PROBE	1	PZ																																
VI1220A1	4,2X12 TCB SELF-TAPPIN G SCREW	2	PZ																																			
VM1464A1	CT BT TEMPERATUR E PROBE COVER	1	PZ																																			
VM1465A1	CT BT TEMPERATUR E PROBE COVER	1	PZ																																			
VM2052A0	LM CORE PROBE COVE	1	PZ																																			
KTR1096A	NTC 150 L=1500 TEMPERATURE PROBE KIT	<table border="1"> <thead> <tr> <th>Code</th> <th>Description</th> <th>Qty</th> <th>UOM</th> </tr> </thead> <tbody> <tr> <td>GN1120A0</td> <td>NTC TEMPERATUR E PROBE SEAL</td> <td>1</td> <td>PZ</td> </tr> <tr> <td>GN1120A1</td> <td>NTC TEMPERATUR E PROBE SEAL</td> <td>1</td> <td>PZ</td> </tr> <tr> <td>GN1285A0</td> <td>NTC TEMPERATUR E PROBE SEALING</td> <td>2</td> <td>PZ</td> </tr> <tr> <td>SL1045A0</td> <td>S57 BLACK SILICONE - 80ML CARTRIDGE</td> <td>1</td> <td>PZ</td> </tr> <tr> <td>TR1096A0</td> <td>TEMPERATUR E PROBE NTC 150 L=1500</td> <td>1</td> <td>PZ</td> </tr> <tr> <td>VI1220A1</td> <td>4,2X12 TCB SELF-TAPPIN G SCREW</td> <td>2</td> <td>PZ</td> </tr> <tr> <td>VM1465A0</td> <td>CHEFTOP TEMPERATUR E PROBE COVER</td> <td>1</td> <td>PZ</td> </tr> <tr> <td>VM1465A1</td> <td>CT BT TEMPERATUR E PROBE COVER</td> <td>1</td> <td>PZ</td> </tr> </tbody> </table>	Code	Description	Qty	UOM	GN1120A0	NTC TEMPERATUR E PROBE SEAL	1	PZ	GN1120A1	NTC TEMPERATUR E PROBE SEAL	1	PZ	GN1285A0	NTC TEMPERATUR E PROBE SEALING	2	PZ	SL1045A0	S57 BLACK SILICONE - 80ML CARTRIDGE	1	PZ	TR1096A0	TEMPERATUR E PROBE NTC 150 L=1500	1	PZ	VI1220A1	4,2X12 TCB SELF-TAPPIN G SCREW	2	PZ	VM1465A0	CHEFTOP TEMPERATUR E PROBE COVER	1	PZ	VM1465A1	CT BT TEMPERATUR E PROBE COVER	1	PZ
Code	Description	Qty	UOM																																			
GN1120A0	NTC TEMPERATUR E PROBE SEAL	1	PZ																																			
GN1120A1	NTC TEMPERATUR E PROBE SEAL	1	PZ																																			
GN1285A0	NTC TEMPERATUR E PROBE SEALING	2	PZ																																			
SL1045A0	S57 BLACK SILICONE - 80ML CARTRIDGE	1	PZ																																			
TR1096A0	TEMPERATUR E PROBE NTC 150 L=1500	1	PZ																																			
VI1220A1	4,2X12 TCB SELF-TAPPIN G SCREW	2	PZ																																			
VM1465A0	CHEFTOP TEMPERATUR E PROBE COVER	1	PZ																																			
VM1465A1	CT BT TEMPERATUR E PROBE COVER	1	PZ																																			
KTR1095A	NTC 150 L=1050 TEMPERATURE PROBE KIT	<table border="1"> <thead> <tr> <th>Code</th> <th>Description</th> <th>Qty</th> <th>UOM</th> </tr> </thead> <tbody> <tr> <td>GN1120A0</td> <td>NTC TEMPERATUR E PROBE SEAL</td> <td>1</td> <td>PZ</td> </tr> <tr> <td>GN1120A1</td> <td>NTC TEMPERATUR E PROBE SEAL</td> <td>1</td> <td>PZ</td> </tr> </tbody> </table>	Code	Description	Qty	UOM	GN1120A0	NTC TEMPERATUR E PROBE SEAL	1	PZ	GN1120A1	NTC TEMPERATUR E PROBE SEAL	1	PZ																								
Code	Description	Qty	UOM																																			
GN1120A0	NTC TEMPERATUR E PROBE SEAL	1	PZ																																			
GN1120A1	NTC TEMPERATUR E PROBE SEAL	1	PZ																																			

COMPONENT			SPARE PART																														
Code	Description	Image	Code	Description	Components list																												
GN1285A	NTC TEMPERATURE PROBE SEALING		KTR1095A	NTC 150 L=1050 TEMPERATURE PROBE KIT	<table border="1"> <thead> <tr> <th>Code</th> <th>Description</th> <th>Qty</th> <th>UOM</th> </tr> </thead> <tbody> <tr> <td>GN1285A0</td> <td>NTC TEMPERATUR E PROBE SEALING</td> <td>1</td> <td>PZ</td> </tr> <tr> <td>SL1045A0</td> <td>S57 BLACK SILICONE - 80ML CARTRIDGE</td> <td>1</td> <td>PZ</td> </tr> <tr> <td>TR1095A0</td> <td>TEMPERATUR E PROBE NTC 150 L=1050</td> <td>1</td> <td>PZ</td> </tr> <tr> <td>VI1220A1</td> <td>4,2X12 TCB SELF-TAPPIN G SCREW</td> <td>2</td> <td>PZ</td> </tr> <tr> <td>VM1465A0</td> <td>CHEFTOP TEMPERATUR E PROBE COVER</td> <td>1</td> <td>PZ</td> </tr> <tr> <td>VM1465A1</td> <td>CT BT TEMPERATUR E PROBE COVER</td> <td>1</td> <td>PZ</td> </tr> </tbody> </table>	Code	Description	Qty	UOM	GN1285A0	NTC TEMPERATUR E PROBE SEALING	1	PZ	SL1045A0	S57 BLACK SILICONE - 80ML CARTRIDGE	1	PZ	TR1095A0	TEMPERATUR E PROBE NTC 150 L=1050	1	PZ	VI1220A1	4,2X12 TCB SELF-TAPPIN G SCREW	2	PZ	VM1465A0	CHEFTOP TEMPERATUR E PROBE COVER	1	PZ	VM1465A1	CT BT TEMPERATUR E PROBE COVER	1	PZ
			Code	Description	Qty	UOM																											
GN1285A0	NTC TEMPERATUR E PROBE SEALING	1	PZ																														
SL1045A0	S57 BLACK SILICONE - 80ML CARTRIDGE	1	PZ																														
TR1095A0	TEMPERATUR E PROBE NTC 150 L=1050	1	PZ																														
VI1220A1	4,2X12 TCB SELF-TAPPIN G SCREW	2	PZ																														
VM1465A0	CHEFTOP TEMPERATUR E PROBE COVER	1	PZ																														
VM1465A1	CT BT TEMPERATUR E PROBE COVER	1	PZ																														
KTR1002A	PT100 L1000 UL TEMPERATURE PROBE KIT	<table border="1"> <thead> <tr> <th>Code</th> <th>Description</th> <th>Qty</th> <th>UOM</th> </tr> </thead> <tbody> <tr> <td>GN1285A0</td> <td>NTC TEMPERATUR E PROBE SEALING</td> <td>2</td> <td>PZ</td> </tr> <tr> <td>SL1045A0</td> <td>S57 BLACK SILICONE - 80ML CARTRIDGE</td> <td>1</td> <td>PZ</td> </tr> <tr> <td>TR1002A1</td> <td></td> <td>1</td> <td>PZ</td> </tr> <tr> <td>VI1220A1</td> <td>4,2X12 TCB SELF-TAPPIN G SCREW</td> <td>2</td> <td>PZ</td> </tr> <tr> <td>VM1465A0</td> <td>CHEFTOP TEMPERATUR E PROBE COVER</td> <td>1</td> <td>PZ</td> </tr> <tr> <td>VM1465A1</td> <td>CT BT TEMPERATUR E PROBE COVER</td> <td>1</td> <td>PZ</td> </tr> </tbody> </table>	Code	Description	Qty	UOM	GN1285A0	NTC TEMPERATUR E PROBE SEALING	2	PZ	SL1045A0	S57 BLACK SILICONE - 80ML CARTRIDGE	1	PZ	TR1002A1		1	PZ	VI1220A1	4,2X12 TCB SELF-TAPPIN G SCREW	2	PZ	VM1465A0	CHEFTOP TEMPERATUR E PROBE COVER	1	PZ	VM1465A1	CT BT TEMPERATUR E PROBE COVER	1	PZ			
Code	Description	Qty	UOM																														
GN1285A0	NTC TEMPERATUR E PROBE SEALING	2	PZ																														
SL1045A0	S57 BLACK SILICONE - 80ML CARTRIDGE	1	PZ																														
TR1002A1		1	PZ																														
VI1220A1	4,2X12 TCB SELF-TAPPIN G SCREW	2	PZ																														
VM1465A0	CHEFTOP TEMPERATUR E PROBE COVER	1	PZ																														
VM1465A1	CT BT TEMPERATUR E PROBE COVER	1	PZ																														
VM1465A	CT BT TEMPERATURE PROBE COVER		KTR1150B	PT1000 L1200 TEMPERATURE PROBE KIT	<table border="1"> <thead> <tr> <th>Code</th> <th>Description</th> <th>Qty</th> <th>UOM</th> </tr> </thead> <tbody> <tr> <td>GN1285A0</td> <td>NTC TEMPERATUR E PROBE SEALING</td> <td>1</td> <td>PZ</td> </tr> <tr> <td>TR1150B0</td> <td></td> <td>1</td> <td>PZ</td> </tr> <tr> <td>TR1150B1</td> <td></td> <td>1</td> <td>PZ</td> </tr> <tr> <td>VI1220A1</td> <td>4,2X12 TCB SELF-TAPPIN G SCREW</td> <td>1</td> <td>PZ</td> </tr> </tbody> </table>	Code	Description	Qty	UOM	GN1285A0	NTC TEMPERATUR E PROBE SEALING	1	PZ	TR1150B0		1	PZ	TR1150B1		1	PZ	VI1220A1	4,2X12 TCB SELF-TAPPIN G SCREW	1	PZ								
Code	Description	Qty	UOM																														
GN1285A0	NTC TEMPERATUR E PROBE SEALING	1	PZ																														
TR1150B0		1	PZ																														
TR1150B1		1	PZ																														
VI1220A1	4,2X12 TCB SELF-TAPPIN G SCREW	1	PZ																														

COMPONENT			SPARE PART																															
Code	Description	Image	Code	Description	Components list																													
VM1465A	CT BT TEMPERATURE PROBE COVER		KTR1150B	PT1000 L1200 TEMPERATURE PROBE KIT	<table border="1"> <thead> <tr> <th>Code</th> <th>Description</th> <th>Qty</th> <th>UOM</th> </tr> </thead> <tbody> <tr> <td>VM1465A0</td> <td>CHEFTOP TEMPERATUR E PROBE COVER</td> <td>1</td> <td>PZ</td> </tr> <tr> <td>VM1465A1</td> <td>CT BT TEMPERATUR E PROBE COVER</td> <td>1</td> <td>PZ</td> </tr> </tbody> </table>	Code	Description	Qty	UOM	VM1465A0	CHEFTOP TEMPERATUR E PROBE COVER	1	PZ	VM1465A1	CT BT TEMPERATUR E PROBE COVER	1	PZ																	
			Code	Description	Qty	UOM																												
			VM1465A0	CHEFTOP TEMPERATUR E PROBE COVER	1	PZ																												
VM1465A1	CT BT TEMPERATUR E PROBE COVER	1	PZ																															
KTR1150A	EVEREO PT100 L2000 TEMPERATURE PROBE KIT	<table border="1"> <thead> <tr> <th>Code</th> <th>Description</th> <th>Qty</th> <th>UOM</th> </tr> </thead> <tbody> <tr> <td>CE1880A0</td> <td>CPM 4P 3P81 CONNECTION CABLE EXIT 90</td> <td>1</td> <td>PZ</td> </tr> <tr> <td>GN1285A0</td> <td>NTC TEMPERATUR E PROBE SEALING</td> <td>1</td> <td>PZ</td> </tr> <tr> <td>TR1150A0</td> <td>PT100 3F L2000 TEMPERATUR E PROBE</td> <td>1</td> <td>PZ</td> </tr> <tr> <td>VM1465A0</td> <td>CHEFTOP TEMPERATUR E PROBE COVER</td> <td>1</td> <td>PZ</td> </tr> <tr> <td>VM1465A1</td> <td>CT BT TEMPERATUR E PROBE COVER</td> <td>1</td> <td>PZ</td> </tr> </tbody> </table>	Code	Description	Qty	UOM	CE1880A0	CPM 4P 3P81 CONNECTION CABLE EXIT 90	1	PZ	GN1285A0	NTC TEMPERATUR E PROBE SEALING	1	PZ	TR1150A0	PT100 3F L2000 TEMPERATUR E PROBE	1	PZ	VM1465A0	CHEFTOP TEMPERATUR E PROBE COVER	1	PZ	VM1465A1	CT BT TEMPERATUR E PROBE COVER	1	PZ								
Code	Description	Qty	UOM																															
CE1880A0	CPM 4P 3P81 CONNECTION CABLE EXIT 90	1	PZ																															
GN1285A0	NTC TEMPERATUR E PROBE SEALING	1	PZ																															
TR1150A0	PT100 3F L2000 TEMPERATUR E PROBE	1	PZ																															
VM1465A0	CHEFTOP TEMPERATUR E PROBE COVER	1	PZ																															
VM1465A1	CT BT TEMPERATUR E PROBE COVER	1	PZ																															
KTR1106B	MIND.MAPS L2000 CHAMBER TEMP. PROBE KIT	<table border="1"> <thead> <tr> <th>Code</th> <th>Description</th> <th>Qty</th> <th>UOM</th> </tr> </thead> <tbody> <tr> <td>GN1285A0</td> <td>NTC TEMPERATUR E PROBE SEALING</td> <td>1</td> <td>PZ</td> </tr> <tr> <td>SL1045A0</td> <td>S57 BLACK SILICONE - 80ML CARTRIDGE</td> <td>1</td> <td>PZ</td> </tr> <tr> <td>TR1106B0</td> <td></td> <td>1</td> <td>PZ</td> </tr> <tr> <td>VI1220A1</td> <td>4,2X12 TCB SELF-TAPPIN G SCREW</td> <td>2</td> <td>PZ</td> </tr> <tr> <td>VM1464A1</td> <td>CT BT TEMPERATUR E PROBE COVER</td> <td>1</td> <td>PZ</td> </tr> <tr> <td>VM1465A0</td> <td>CHEFTOP TEMPERATUR E PROBE COVER</td> <td>1</td> <td>PZ</td> </tr> <tr> <td>VM1465A1</td> <td>CT BT TEMPERATUR E PROBE COVER</td> <td>1</td> <td>PZ</td> </tr> </tbody> </table>	Code	Description	Qty	UOM	GN1285A0	NTC TEMPERATUR E PROBE SEALING	1	PZ	SL1045A0	S57 BLACK SILICONE - 80ML CARTRIDGE	1	PZ	TR1106B0		1	PZ	VI1220A1	4,2X12 TCB SELF-TAPPIN G SCREW	2	PZ	VM1464A1	CT BT TEMPERATUR E PROBE COVER	1	PZ	VM1465A0	CHEFTOP TEMPERATUR E PROBE COVER	1	PZ	VM1465A1	CT BT TEMPERATUR E PROBE COVER	1	PZ
Code	Description	Qty	UOM																															
GN1285A0	NTC TEMPERATUR E PROBE SEALING	1	PZ																															
SL1045A0	S57 BLACK SILICONE - 80ML CARTRIDGE	1	PZ																															
TR1106B0		1	PZ																															
VI1220A1	4,2X12 TCB SELF-TAPPIN G SCREW	2	PZ																															
VM1464A1	CT BT TEMPERATUR E PROBE COVER	1	PZ																															
VM1465A0	CHEFTOP TEMPERATUR E PROBE COVER	1	PZ																															
VM1465A1	CT BT TEMPERATUR E PROBE COVER	1	PZ																															



COMPONENT			SPARE PART																																											
Code	Description	Image	Code	Description	Components list																																									
VM1465A	CT BT TEMPERATURE PROBE COVER		KTR1106A	5-5E S. L2000 CHAMBER TEMP. PROBE KIT	<table border="1"> <thead> <tr> <th>Code</th> <th>Description</th> <th>Qty</th> <th>UOM</th> </tr> </thead> <tbody> <tr> <td>GN1285A0</td> <td>NTC TEMPERATUR E PROBE SEALING</td> <td>1</td> <td>PZ</td> </tr> <tr> <td>SL1045A0</td> <td>S57 BLACK SILICONE - 80ML CARTRIDGE</td> <td>1</td> <td>PZ</td> </tr> <tr> <td>TR1106A3</td> <td>PT100 L-2000 TEMPERATUR E PROBE</td> <td>1</td> <td>PZ</td> </tr> <tr> <td>VI1220A1</td> <td>4,2X12 TCB SELF-TAPPIN G SCREW</td> <td>2</td> <td>PZ</td> </tr> <tr> <td>VM1465A0</td> <td>CHEFTOP TEMPERATUR E PROBE COVER</td> <td>1</td> <td>PZ</td> </tr> <tr> <td>VM1465A1</td> <td>CT BT TEMPERATUR E PROBE COVER</td> <td>1</td> <td>PZ</td> </tr> </tbody> </table>	Code	Description	Qty	UOM	GN1285A0	NTC TEMPERATUR E PROBE SEALING	1	PZ	SL1045A0	S57 BLACK SILICONE - 80ML CARTRIDGE	1	PZ	TR1106A3	PT100 L-2000 TEMPERATUR E PROBE	1	PZ	VI1220A1	4,2X12 TCB SELF-TAPPIN G SCREW	2	PZ	VM1465A0	CHEFTOP TEMPERATUR E PROBE COVER	1	PZ	VM1465A1	CT BT TEMPERATUR E PROBE COVER	1	PZ													
			Code	Description	Qty	UOM																																								
GN1285A0	NTC TEMPERATUR E PROBE SEALING	1	PZ																																											
SL1045A0	S57 BLACK SILICONE - 80ML CARTRIDGE	1	PZ																																											
TR1106A3	PT100 L-2000 TEMPERATUR E PROBE	1	PZ																																											
VI1220A1	4,2X12 TCB SELF-TAPPIN G SCREW	2	PZ																																											
VM1465A0	CHEFTOP TEMPERATUR E PROBE COVER	1	PZ																																											
VM1465A1	CT BT TEMPERATUR E PROBE COVER	1	PZ																																											
KTR1105A	PT100 L1000 TEMPERATURE PROBE KIT	<table border="1"> <thead> <tr> <th>Code</th> <th>Description</th> <th>Qty</th> <th>UOM</th> </tr> </thead> <tbody> <tr> <td>GN1120A0</td> <td>NTC TEMPERATUR E PROBE SEAL</td> <td>1</td> <td>PZ</td> </tr> <tr> <td>GN1120A1</td> <td>NTC TEMPERATUR E PROBE SEAL</td> <td>1</td> <td>PZ</td> </tr> <tr> <td>GN1285A0</td> <td>NTC TEMPERATUR E PROBE SEALING</td> <td>1</td> <td>PZ</td> </tr> <tr> <td>MOV0010A0</td> <td>HOOD RING GASKET GN1110A2</td> <td>0.100</td> <td>PZ</td> </tr> <tr> <td>SL1045A0</td> <td>S57 BLACK SILICONE - 80ML CARTRIDGE</td> <td>1</td> <td>PZ</td> </tr> <tr> <td>TR1105A4</td> <td>L1000 PT100 TEMPERATUR E PROBE</td> <td>1</td> <td>PZ</td> </tr> <tr> <td>VI1220A1</td> <td>4,2X12 TCB SELF-TAPPIN G SCREW</td> <td>2</td> <td>PZ</td> </tr> <tr> <td>VM1464A1</td> <td>CT BT TEMPERATUR E PROBE COVER</td> <td>1</td> <td>PZ</td> </tr> <tr> <td>VM1465A1</td> <td>CT BT TEMPERATUR E PROBE COVER</td> <td>1</td> <td>PZ</td> </tr> <tr> <td>VM2052A0</td> <td>LM CORE PROBE COVE</td> <td>1</td> <td>PZ</td> </tr> </tbody> </table>	Code	Description	Qty	UOM	GN1120A0	NTC TEMPERATUR E PROBE SEAL	1	PZ	GN1120A1	NTC TEMPERATUR E PROBE SEAL	1	PZ	GN1285A0	NTC TEMPERATUR E PROBE SEALING	1	PZ	MOV0010A0	HOOD RING GASKET GN1110A2	0.100	PZ	SL1045A0	S57 BLACK SILICONE - 80ML CARTRIDGE	1	PZ	TR1105A4	L1000 PT100 TEMPERATUR E PROBE	1	PZ	VI1220A1	4,2X12 TCB SELF-TAPPIN G SCREW	2	PZ	VM1464A1	CT BT TEMPERATUR E PROBE COVER	1	PZ	VM1465A1	CT BT TEMPERATUR E PROBE COVER	1	PZ	VM2052A0	LM CORE PROBE COVE	1	PZ
Code	Description	Qty	UOM																																											
GN1120A0	NTC TEMPERATUR E PROBE SEAL	1	PZ																																											
GN1120A1	NTC TEMPERATUR E PROBE SEAL	1	PZ																																											
GN1285A0	NTC TEMPERATUR E PROBE SEALING	1	PZ																																											
MOV0010A0	HOOD RING GASKET GN1110A2	0.100	PZ																																											
SL1045A0	S57 BLACK SILICONE - 80ML CARTRIDGE	1	PZ																																											
TR1105A4	L1000 PT100 TEMPERATUR E PROBE	1	PZ																																											
VI1220A1	4,2X12 TCB SELF-TAPPIN G SCREW	2	PZ																																											
VM1464A1	CT BT TEMPERATUR E PROBE COVER	1	PZ																																											
VM1465A1	CT BT TEMPERATUR E PROBE COVER	1	PZ																																											
VM2052A0	LM CORE PROBE COVE	1	PZ																																											





COMPONENT			SPARE PART																																						
Code	Description	Image	Code	Description	Components list																																				
VM1465A	CT BT TEMPERATURE PROBE COVER		KTR1096A	NTC 150 L=1500 TEMPERATURE PROBE KIT	<table border="1"> <thead> <tr> <th>Code</th> <th>Description</th> <th>Qty</th> <th>UOM</th> </tr> </thead> <tbody> <tr> <td>GN1120A0</td> <td>NTC TEMPERATUR E PROBE SEAL</td> <td>1</td> <td>PZ</td> </tr> <tr> <td>GN1120A1</td> <td>NTC TEMPERATUR E PROBE SEAL</td> <td>1</td> <td>PZ</td> </tr> <tr> <td>GN1285A0</td> <td>NTC TEMPERATUR E PROBE SEALING</td> <td>2</td> <td>PZ</td> </tr> <tr> <td>SL1045A0</td> <td>S57 BLACK SILICONE - 80ML CARTRIDGE</td> <td>1</td> <td>PZ</td> </tr> <tr> <td>TR1096A0</td> <td>TEMPERATUR E PROBE NTC 150 L=1500</td> <td>1</td> <td>PZ</td> </tr> <tr> <td>VI1220A1</td> <td>4,2X12 TCB SELF-TAPPIN G SCREW</td> <td>2</td> <td>PZ</td> </tr> <tr> <td>VM1465A0</td> <td>CHEFTOP TEMPERATUR E PROBE COVER</td> <td>1</td> <td>PZ</td> </tr> <tr> <td>VM1465A1</td> <td>CT BT TEMPERATUR E PROBE COVER</td> <td>1</td> <td>PZ</td> </tr> </tbody> </table>	Code	Description	Qty	UOM	GN1120A0	NTC TEMPERATUR E PROBE SEAL	1	PZ	GN1120A1	NTC TEMPERATUR E PROBE SEAL	1	PZ	GN1285A0	NTC TEMPERATUR E PROBE SEALING	2	PZ	SL1045A0	S57 BLACK SILICONE - 80ML CARTRIDGE	1	PZ	TR1096A0	TEMPERATUR E PROBE NTC 150 L=1500	1	PZ	VI1220A1	4,2X12 TCB SELF-TAPPIN G SCREW	2	PZ	VM1465A0	CHEFTOP TEMPERATUR E PROBE COVER	1	PZ	VM1465A1	CT BT TEMPERATUR E PROBE COVER	1	PZ
			Code	Description	Qty	UOM																																			
GN1120A0	NTC TEMPERATUR E PROBE SEAL	1	PZ																																						
GN1120A1	NTC TEMPERATUR E PROBE SEAL	1	PZ																																						
GN1285A0	NTC TEMPERATUR E PROBE SEALING	2	PZ																																						
SL1045A0	S57 BLACK SILICONE - 80ML CARTRIDGE	1	PZ																																						
TR1096A0	TEMPERATUR E PROBE NTC 150 L=1500	1	PZ																																						
VI1220A1	4,2X12 TCB SELF-TAPPIN G SCREW	2	PZ																																						
VM1465A0	CHEFTOP TEMPERATUR E PROBE COVER	1	PZ																																						
VM1465A1	CT BT TEMPERATUR E PROBE COVER	1	PZ																																						
KTR1095A	NTC 150 L=1050 TEMPERATURE PROBE KIT	<table border="1"> <thead> <tr> <th>Code</th> <th>Description</th> <th>Qty</th> <th>UOM</th> </tr> </thead> <tbody> <tr> <td>GN1120A0</td> <td>NTC TEMPERATUR E PROBE SEAL</td> <td>1</td> <td>PZ</td> </tr> <tr> <td>GN1120A1</td> <td>NTC TEMPERATUR E PROBE SEAL</td> <td>1</td> <td>PZ</td> </tr> <tr> <td>GN1285A0</td> <td>NTC TEMPERATUR E PROBE SEALING</td> <td>1</td> <td>PZ</td> </tr> <tr> <td>SL1045A0</td> <td>S57 BLACK SILICONE - 80ML CARTRIDGE</td> <td>1</td> <td>PZ</td> </tr> <tr> <td>TR1095A0</td> <td>TEMPERATUR E PROBE NTC 150 L=1050</td> <td>1</td> <td>PZ</td> </tr> <tr> <td>VI1220A1</td> <td>4,2X12 TCB SELF-TAPPIN G SCREW</td> <td>2</td> <td>PZ</td> </tr> <tr> <td>VM1465A0</td> <td>CHEFTOP TEMPERATUR E PROBE COVER</td> <td>1</td> <td>PZ</td> </tr> <tr> <td>VM1465A1</td> <td>CT BT TEMPERATUR E PROBE COVER</td> <td>1</td> <td>PZ</td> </tr> </tbody> </table>	Code	Description	Qty	UOM	GN1120A0	NTC TEMPERATUR E PROBE SEAL	1	PZ	GN1120A1	NTC TEMPERATUR E PROBE SEAL	1	PZ	GN1285A0	NTC TEMPERATUR E PROBE SEALING	1	PZ	SL1045A0	S57 BLACK SILICONE - 80ML CARTRIDGE	1	PZ	TR1095A0	TEMPERATUR E PROBE NTC 150 L=1050	1	PZ	VI1220A1	4,2X12 TCB SELF-TAPPIN G SCREW	2	PZ	VM1465A0	CHEFTOP TEMPERATUR E PROBE COVER	1	PZ	VM1465A1	CT BT TEMPERATUR E PROBE COVER	1	PZ			
Code	Description	Qty	UOM																																						
GN1120A0	NTC TEMPERATUR E PROBE SEAL	1	PZ																																						
GN1120A1	NTC TEMPERATUR E PROBE SEAL	1	PZ																																						
GN1285A0	NTC TEMPERATUR E PROBE SEALING	1	PZ																																						
SL1045A0	S57 BLACK SILICONE - 80ML CARTRIDGE	1	PZ																																						
TR1095A0	TEMPERATUR E PROBE NTC 150 L=1050	1	PZ																																						
VI1220A1	4,2X12 TCB SELF-TAPPIN G SCREW	2	PZ																																						
VM1465A0	CHEFTOP TEMPERATUR E PROBE COVER	1	PZ																																						
VM1465A1	CT BT TEMPERATUR E PROBE COVER	1	PZ																																						





COMPONENT			SPARE PART																																		
Code	Description	Image	Code	Description	Components list																																
VM1465A	CT BT TEMPERATURE PROBE COVER		KTR1003B	US MM L2000 CHAMBER TEMP. PROBE KIT	<table border="1"> <thead> <tr> <th>Code</th> <th>Description</th> <th>Qty</th> <th>UOM</th> </tr> </thead> <tbody> <tr> <td>GN1285A0</td> <td>NTC TEMPERATUR E PROBE SEALING</td> <td>1</td> <td>PZ</td> </tr> <tr> <td>SL1045A0</td> <td>S57 BLACK SILICONE - 80ML CARTRIDGE</td> <td>1</td> <td>PZ</td> </tr> <tr> <td>TR1003B0</td> <td></td> <td>1</td> <td>PZ</td> </tr> <tr> <td>VI1220A1</td> <td>4,2X12 TCB SELF-TAPPIN G SCREW</td> <td>2</td> <td>PZ</td> </tr> <tr> <td>VM1464A1</td> <td>CT BT TEMPERATUR E PROBE COVER</td> <td>1</td> <td>PZ</td> </tr> <tr> <td>VM1465A0</td> <td>CHEFTOP TEMPERATUR E PROBE COVER</td> <td>1</td> <td>PZ</td> </tr> <tr> <td>VM1465A1</td> <td>CT BT TEMPERATUR E PROBE COVER</td> <td>1</td> <td>PZ</td> </tr> </tbody> </table>	Code	Description	Qty	UOM	GN1285A0	NTC TEMPERATUR E PROBE SEALING	1	PZ	SL1045A0	S57 BLACK SILICONE - 80ML CARTRIDGE	1	PZ	TR1003B0		1	PZ	VI1220A1	4,2X12 TCB SELF-TAPPIN G SCREW	2	PZ	VM1464A1	CT BT TEMPERATUR E PROBE COVER	1	PZ	VM1465A0	CHEFTOP TEMPERATUR E PROBE COVER	1	PZ	VM1465A1	CT BT TEMPERATUR E PROBE COVER	1	PZ
			Code	Description	Qty	UOM																															
			GN1285A0	NTC TEMPERATUR E PROBE SEALING	1	PZ																															
SL1045A0	S57 BLACK SILICONE - 80ML CARTRIDGE	1	PZ																																		
TR1003B0		1	PZ																																		
VI1220A1	4,2X12 TCB SELF-TAPPIN G SCREW	2	PZ																																		
VM1464A1	CT BT TEMPERATUR E PROBE COVER	1	PZ																																		
VM1465A0	CHEFTOP TEMPERATUR E PROBE COVER	1	PZ																																		
VM1465A1	CT BT TEMPERATUR E PROBE COVER	1	PZ																																		
KTR1003A	5-5E S.CHEFTOP US TEMPERATURE PROBE KIT	<table border="1"> <thead> <tr> <th>Code</th> <th>Description</th> <th>Qty</th> <th>UOM</th> </tr> </thead> <tbody> <tr> <td>GN1285A0</td> <td>NTC TEMPERATUR E PROBE SEALING</td> <td>1</td> <td>PZ</td> </tr> <tr> <td>SL1045A0</td> <td>S57 BLACK SILICONE - 80ML CARTRIDGE</td> <td>1</td> <td>PZ</td> </tr> <tr> <td>TR1003A0</td> <td>PT100 L2000 TEMPERATUR E PROBE-US VERSION</td> <td>1</td> <td>PZ</td> </tr> <tr> <td>VI1220A1</td> <td>4,2X12 TCB SELF-TAPPIN G SCREW</td> <td>2</td> <td>PZ</td> </tr> <tr> <td>VM1465A0</td> <td>CHEFTOP TEMPERATUR E PROBE COVER</td> <td>1</td> <td>PZ</td> </tr> <tr> <td>VM1465A1</td> <td>CT BT TEMPERATUR E PROBE COVER</td> <td>1</td> <td>PZ</td> </tr> </tbody> </table>	Code	Description	Qty	UOM	GN1285A0	NTC TEMPERATUR E PROBE SEALING	1	PZ	SL1045A0	S57 BLACK SILICONE - 80ML CARTRIDGE	1	PZ	TR1003A0	PT100 L2000 TEMPERATUR E PROBE-US VERSION	1	PZ	VI1220A1	4,2X12 TCB SELF-TAPPIN G SCREW	2	PZ	VM1465A0	CHEFTOP TEMPERATUR E PROBE COVER	1	PZ	VM1465A1	CT BT TEMPERATUR E PROBE COVER	1	PZ							
Code	Description	Qty	UOM																																		
GN1285A0	NTC TEMPERATUR E PROBE SEALING	1	PZ																																		
SL1045A0	S57 BLACK SILICONE - 80ML CARTRIDGE	1	PZ																																		
TR1003A0	PT100 L2000 TEMPERATUR E PROBE-US VERSION	1	PZ																																		
VI1220A1	4,2X12 TCB SELF-TAPPIN G SCREW	2	PZ																																		
VM1465A0	CHEFTOP TEMPERATUR E PROBE COVER	1	PZ																																		
VM1465A1	CT BT TEMPERATUR E PROBE COVER	1	PZ																																		
KTR1002A	PT100 L1000 UL TEMPERATURE PROBE KIT	<table border="1"> <thead> <tr> <th>Code</th> <th>Description</th> <th>Qty</th> <th>UOM</th> </tr> </thead> <tbody> <tr> <td>GN1285A0</td> <td>NTC TEMPERATUR E PROBE SEALING</td> <td>2</td> <td>PZ</td> </tr> </tbody> </table>	Code	Description	Qty	UOM	GN1285A0	NTC TEMPERATUR E PROBE SEALING	2	PZ																											
Code	Description	Qty	UOM																																		
GN1285A0	NTC TEMPERATUR E PROBE SEALING	2	PZ																																		

COMPONENT			SPARE PART																														
Code	Description	Image	Code	Description	Components list																												
VM1465A	CT BT TEMPERATURE PROBE COVER		KTR1002A	PT100 L1000 UL TEMPERATURE PROBE KIT	<table border="1"> <thead> <tr> <th>Code</th> <th>Description</th> <th>Qty</th> <th>UOM</th> </tr> </thead> <tbody> <tr> <td>SL1045A0</td> <td>S57 BLACK SILICONE - 80ML CARTRIDGE</td> <td>1</td> <td>PZ</td> </tr> <tr> <td>TR1002A1</td> <td></td> <td>1</td> <td>PZ</td> </tr> <tr> <td>VI1220A1</td> <td>4,2X12 TCB SELF-TAPPIN G SCREW</td> <td>2</td> <td>PZ</td> </tr> <tr> <td>VM1465A0</td> <td>CHEFTOP TEMPERATUR E PROBE COVER</td> <td>1</td> <td>PZ</td> </tr> <tr> <td>VM1465A1</td> <td>CT BT TEMPERATUR E PROBE COVER</td> <td>1</td> <td>PZ</td> </tr> </tbody> </table>	Code	Description	Qty	UOM	SL1045A0	S57 BLACK SILICONE - 80ML CARTRIDGE	1	PZ	TR1002A1		1	PZ	VI1220A1	4,2X12 TCB SELF-TAPPIN G SCREW	2	PZ	VM1465A0	CHEFTOP TEMPERATUR E PROBE COVER	1	PZ	VM1465A1	CT BT TEMPERATUR E PROBE COVER	1	PZ				
Code	Description	Qty	UOM																														
SL1045A0	S57 BLACK SILICONE - 80ML CARTRIDGE	1	PZ																														
TR1002A1		1	PZ																														
VI1220A1	4,2X12 TCB SELF-TAPPIN G SCREW	2	PZ																														
VM1465A0	CHEFTOP TEMPERATUR E PROBE COVER	1	PZ																														
VM1465A1	CT BT TEMPERATUR E PROBE COVER	1	PZ																														
TR1150B			KTR1150B	PT1000 L1200 TEMPERATURE PROBE KIT	<table border="1"> <thead> <tr> <th>Code</th> <th>Description</th> <th>Qty</th> <th>UOM</th> </tr> </thead> <tbody> <tr> <td>GN1285A0</td> <td>NTC TEMPERATUR E PROBE SEALING</td> <td>1</td> <td>PZ</td> </tr> <tr> <td>TR1150B0</td> <td></td> <td>1</td> <td>PZ</td> </tr> <tr> <td>TR1150B1</td> <td></td> <td>1</td> <td>PZ</td> </tr> <tr> <td>VI1220A1</td> <td>4,2X12 TCB SELF-TAPPIN G SCREW</td> <td>1</td> <td>PZ</td> </tr> <tr> <td>VM1465A0</td> <td>CHEFTOP TEMPERATUR E PROBE COVER</td> <td>1</td> <td>PZ</td> </tr> <tr> <td>VM1465A1</td> <td>CT BT TEMPERATUR E PROBE COVER</td> <td>1</td> <td>PZ</td> </tr> </tbody> </table>	Code	Description	Qty	UOM	GN1285A0	NTC TEMPERATUR E PROBE SEALING	1	PZ	TR1150B0		1	PZ	TR1150B1		1	PZ	VI1220A1	4,2X12 TCB SELF-TAPPIN G SCREW	1	PZ	VM1465A0	CHEFTOP TEMPERATUR E PROBE COVER	1	PZ	VM1465A1	CT BT TEMPERATUR E PROBE COVER	1	PZ
Code	Description	Qty	UOM																														
GN1285A0	NTC TEMPERATUR E PROBE SEALING	1	PZ																														
TR1150B0		1	PZ																														
TR1150B1		1	PZ																														
VI1220A1	4,2X12 TCB SELF-TAPPIN G SCREW	1	PZ																														
VM1465A0	CHEFTOP TEMPERATUR E PROBE COVER	1	PZ																														
VM1465A1	CT BT TEMPERATUR E PROBE COVER	1	PZ																														
GN1531A	THERMOSTAT BULB INLET SEALING		KTR1136A	330°C SAFETY THERMOSTAT KIT	<table border="1"> <thead> <tr> <th>Code</th> <th>Description</th> <th>Qty</th> <th>UOM</th> </tr> </thead> <tbody> <tr> <td>0H7030A0</td> <td>THERMOSTAT BULB INLET COVER</td> <td>1</td> <td>PZ</td> </tr> <tr> <td>GN1531A0</td> <td>THERMOSTAT BULB INLET SEALING</td> <td>1</td> <td>PZ</td> </tr> <tr> <td>MOV0011A0</td> <td>HOOD RING GASKET GN1110A2</td> <td>0.100</td> <td>PZ</td> </tr> <tr> <td>SL1045A0</td> <td>S57 BLACK SILICONE - 80ML CARTRIDGE</td> <td>1</td> <td>PZ</td> </tr> <tr> <td>TR1136A0</td> <td>330°C 1 POLE SAFETY THERMOSTAT</td> <td>1</td> <td>PZ</td> </tr> <tr> <td>VI1220A1</td> <td>4,2X12 TCB SELF-TAPPIN G SCREW</td> <td>3</td> <td>PZ</td> </tr> </tbody> </table>	Code	Description	Qty	UOM	0H7030A0	THERMOSTAT BULB INLET COVER	1	PZ	GN1531A0	THERMOSTAT BULB INLET SEALING	1	PZ	MOV0011A0	HOOD RING GASKET GN1110A2	0.100	PZ	SL1045A0	S57 BLACK SILICONE - 80ML CARTRIDGE	1	PZ	TR1136A0	330°C 1 POLE SAFETY THERMOSTAT	1	PZ	VI1220A1	4,2X12 TCB SELF-TAPPIN G SCREW	3	PZ
Code	Description	Qty	UOM																														
0H7030A0	THERMOSTAT BULB INLET COVER	1	PZ																														
GN1531A0	THERMOSTAT BULB INLET SEALING	1	PZ																														
MOV0011A0	HOOD RING GASKET GN1110A2	0.100	PZ																														
SL1045A0	S57 BLACK SILICONE - 80ML CARTRIDGE	1	PZ																														
TR1136A0	330°C 1 POLE SAFETY THERMOSTAT	1	PZ																														
VI1220A1	4,2X12 TCB SELF-TAPPIN G SCREW	3	PZ																														

COMPONENT			SPARE PART																																		
Code	Description	Image	Code	Description	Components list																																
0H7030A	THERMOSTAT BULB INLET COVER		K0H7030A	THERMOSTAT BULB INLET COVER KIT	<table border="1"> <thead> <tr> <th>Code</th> <th>Description</th> <th>Qty</th> <th>UOM</th> </tr> </thead> <tbody> <tr> <td>0H7030A0</td> <td>THERMOSTAT BULB INLET COVER</td> <td>1</td> <td>PZ</td> </tr> <tr> <td>VM1224A0</td> <td>65MY 220MM 2 COLOURS SHRINK TUBE</td> <td>0.200</td> <td>M</td> </tr> </tbody> </table>	Code	Description	Qty	UOM	0H7030A0	THERMOSTAT BULB INLET COVER	1	PZ	VM1224A0	65MY 220MM 2 COLOURS SHRINK TUBE	0.200	M																				
					Code	Description	Qty	UOM																													
0H7030A0	THERMOSTAT BULB INLET COVER	1	PZ																																		
VM1224A0	65MY 220MM 2 COLOURS SHRINK TUBE	0.200	M																																		
0H8120A	XEVL BULB PASS-THROUGH COVER		0H8120A0	XEVL BULB PASS-THROUGH COVER																																	
RS1282B			KRS1282B	4TURN HEAT ELEM 2700W 230V+260W 135V KIT	<table border="1"> <thead> <tr> <th>Code</th> <th>Description</th> <th>Qty</th> <th>UOM</th> </tr> </thead> <tbody> <tr> <td>GN1327A0</td> <td>HEATING ELEMENT GASKET</td> <td>1</td> <td>PZ</td> </tr> <tr> <td>RS1282B0</td> <td></td> <td>1</td> <td>PZ</td> </tr> <tr> <td>SL1045A0</td> <td>S57 BLACK SILICONE - 80ML CARTRIDGE</td> <td>1</td> <td>PZ</td> </tr> <tr> <td>VI1220A1</td> <td>4,2X12 TCB SELF-TAPPING SCREW</td> <td>1</td> <td>PZ</td> </tr> <tr> <td>VM1794A0</td> <td>250X4.8 PA66 BLACK CLAMP</td> <td>2</td> <td>PZ</td> </tr> <tr> <td>VM2103A0</td> <td>CLAMP LOCK</td> <td>2</td> <td>PZ</td> </tr> </tbody> </table>	Code	Description	Qty	UOM	GN1327A0	HEATING ELEMENT GASKET	1	PZ	RS1282B0		1	PZ	SL1045A0	S57 BLACK SILICONE - 80ML CARTRIDGE	1	PZ	VI1220A1	4,2X12 TCB SELF-TAPPING SCREW	1	PZ	VM1794A0	250X4.8 PA66 BLACK CLAMP	2	PZ	VM2103A0	CLAMP LOCK	2	PZ				
					Code	Description	Qty	UOM																													
					GN1327A0	HEATING ELEMENT GASKET	1	PZ																													
					RS1282B0		1	PZ																													
					SL1045A0	S57 BLACK SILICONE - 80ML CARTRIDGE	1	PZ																													
					VI1220A1	4,2X12 TCB SELF-TAPPING SCREW	1	PZ																													
					VM1794A0	250X4.8 PA66 BLACK CLAMP	2	PZ																													
VM2103A0	CLAMP LOCK	2	PZ																																		
GN1679A			KGN1592A	EVEREO 900 DOOR GASKET KIT	<table border="1"> <thead> <tr> <th>Code</th> <th>Description</th> <th>Qty</th> <th>UOM</th> </tr> </thead> <tbody> <tr> <td>GN0050A0</td> <td>EVEREO FRONT GASKE</td> <td>2.100</td> <td>M</td> </tr> <tr> <td>GN1006A1</td> <td>DOOR GASKE</td> <td>2.020</td> <td>M</td> </tr> <tr> <td>GN1008A0</td> <td>DOOR SEAL INTERNAL CONNECTION</td> <td>0.030</td> <td>M</td> </tr> <tr> <td>GN1250A0</td> <td>DOOR GASKET XVC-XBC</td> <td>2.120</td> <td>M</td> </tr> <tr> <td>SL1025A0</td> <td>CLEAR SILICON DOW CORNING 734</td> <td>0.010</td> <td>PZ</td> </tr> <tr> <td>VM1224A0</td> <td>65MY 220MM 2 COLOURS SHRINK TUBE</td> <td>0.450</td> <td>M</td> </tr> <tr> <td>VM2277A0</td> <td>DOOR SEAL KIT INTERNAL CONNECTION</td> <td>1</td> <td>PZ</td> </tr> </tbody> </table>	Code	Description	Qty	UOM	GN0050A0	EVEREO FRONT GASKE	2.100	M	GN1006A1	DOOR GASKE	2.020	M	GN1008A0	DOOR SEAL INTERNAL CONNECTION	0.030	M	GN1250A0	DOOR GASKET XVC-XBC	2.120	M	SL1025A0	CLEAR SILICON DOW CORNING 734	0.010	PZ	VM1224A0	65MY 220MM 2 COLOURS SHRINK TUBE	0.450	M	VM2277A0	DOOR SEAL KIT INTERNAL CONNECTION	1	PZ
					Code	Description	Qty	UOM																													
					GN0050A0	EVEREO FRONT GASKE	2.100	M																													
					GN1006A1	DOOR GASKE	2.020	M																													
					GN1008A0	DOOR SEAL INTERNAL CONNECTION	0.030	M																													
					GN1250A0	DOOR GASKET XVC-XBC	2.120	M																													
					SL1025A0	CLEAR SILICON DOW CORNING 734	0.010	PZ																													
					VM1224A0	65MY 220MM 2 COLOURS SHRINK TUBE	0.450	M																													
VM2277A0	DOOR SEAL KIT INTERNAL CONNECTION	1	PZ																																		