







Assembly code	Assembly description	Assembly image
ASM3404A/0.D02	Cooking chamber	
ASM3410A/0.D04	External cover	
ASM3422B/0.D00	Door	
ASM8226A/0.D00	Electrical system	



ASM3404A/0.D02 - Cooking chamber - FRONT

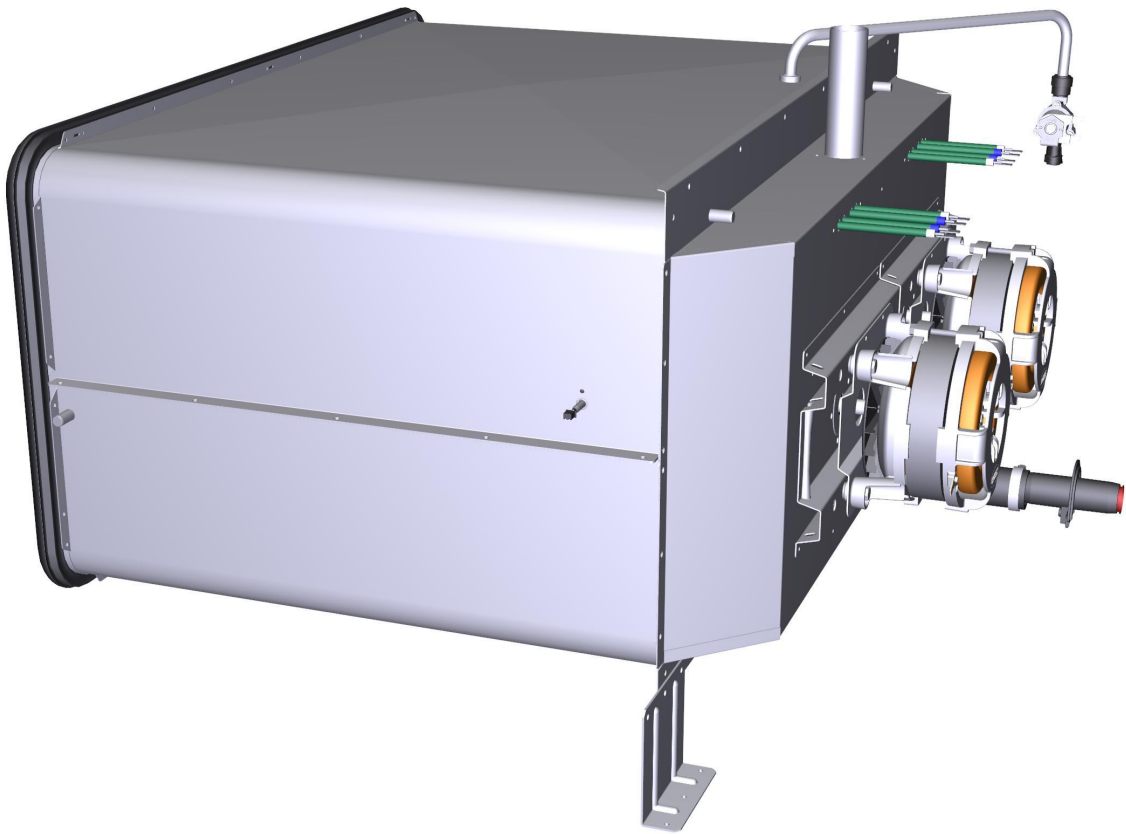





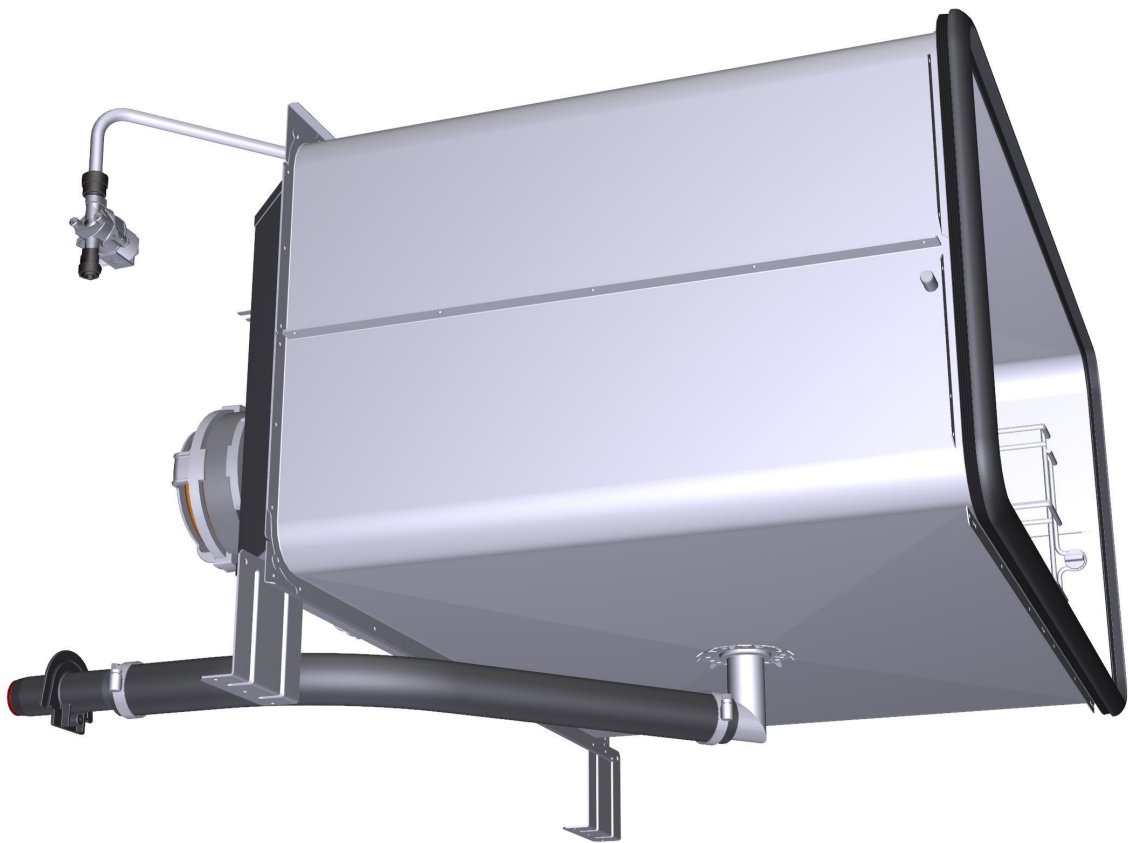



ASM3404A/0.D02 - Cooking chamber - REAR

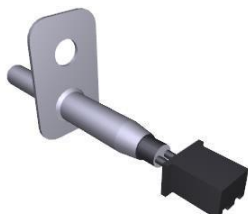



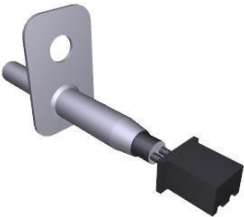

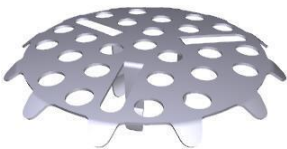
COMPONENT			SPARE PART																														
Code	Description	Image	Code	Description	Kit components																												
0G1654A	ROSSELLA SHOP PRO FAN GUARD		0G1654A1	ROSSELLA SHOP PRO FAN GUARD																													
0G1658A	ROSSELLA SP FAN GUARD DIVIDING PLATE		0G1658A0	ROSSELLA SP FAN GUARD DIVIDING PLATE																													
0H7875A	SHOP.PRO MUFFLE SUPPORT BRACKET		0H7875A1	SHOP.PRO MUFFLE SUPPORT BRACKET																													
TR1105A	SONDA TEMPERATURA PT100 L1000		KTR1105A	PT100 L1000 TEMPERATURE PROBE KIT	<table border="1"> <thead> <tr> <th>Code</th> <th>Description</th> <th>Qty</th> <th>UOM</th> </tr> </thead> <tbody> <tr> <td>0H4302A0</td> <td>PIASTRINA SILICONE SONDE</td> <td>1.000</td> <td>PZ</td> </tr> <tr> <td>GN1120A1</td> <td>GUARNIZIONE SONDA TEMPERATURA NTC LM</td> <td>1.000</td> <td>PZ</td> </tr> <tr> <td>GN1285A0</td> <td>GUARNIZIONE SONDA DI TEMPERATURA NTC</td> <td>1.000</td> <td>PZ</td> </tr> <tr> <td>SL1045A0</td> <td>SILICONE ANTRACITE S57 80 ml</td> <td>1.000</td> <td>PZ</td> </tr> <tr> <td>TR1105A4</td> <td>SONDA TEMPERATURA A PT100 L1000</td> <td>1.000</td> <td>PZ</td> </tr> <tr> <td>VI1220A1</td> <td>VITE AUTOFIL 4.2X11 TCS+ MARUTEX</td> <td>2.000</td> <td>PZ</td> </tr> </tbody> </table>	Code	Description	Qty	UOM	0H4302A0	PIASTRINA SILICONE SONDE	1.000	PZ	GN1120A1	GUARNIZIONE SONDA TEMPERATURA NTC LM	1.000	PZ	GN1285A0	GUARNIZIONE SONDA DI TEMPERATURA NTC	1.000	PZ	SL1045A0	SILICONE ANTRACITE S57 80 ml	1.000	PZ	TR1105A4	SONDA TEMPERATURA A PT100 L1000	1.000	PZ	VI1220A1	VITE AUTOFIL 4.2X11 TCS+ MARUTEX	2.000	PZ
Code	Description	Qty	UOM																														
0H4302A0	PIASTRINA SILICONE SONDE	1.000	PZ																														
GN1120A1	GUARNIZIONE SONDA TEMPERATURA NTC LM	1.000	PZ																														
GN1285A0	GUARNIZIONE SONDA DI TEMPERATURA NTC	1.000	PZ																														
SL1045A0	SILICONE ANTRACITE S57 80 ml	1.000	PZ																														
TR1105A4	SONDA TEMPERATURA A PT100 L1000	1.000	PZ																														
VI1220A1	VITE AUTOFIL 4.2X11 TCS+ MARUTEX	2.000	PZ																														



COMPONENT			SPARE PART																		
Code	Description	Image	Code	Description	Kit components																
TR1105A	SONDA TEMPERATURA PT100 L1000		KTR1105A	PT100 L1000 TEMPERATURE PROBE KIT	<table border="1"> <thead> <tr> <th>Code</th> <th>Description</th> <th>Qty</th> <th>UOM</th> </tr> </thead> <tbody> <tr> <td>VM1464A1</td> <td>COPERCHIO SONDA TEMPERATUR A CT BT CON PA</td> <td>1.000</td> <td>PZ</td> </tr> <tr> <td>VM1465A1</td> <td>COPERCHIO SONDA TEMPERATUR A CT BT</td> <td>1.000</td> <td>PZ</td> </tr> <tr> <td>VM2052A0</td> <td>COPERCHIO SONDA TEMPERATUR A LM</td> <td>1.000</td> <td>PZ</td> </tr> </tbody> </table>	Code	Description	Qty	UOM	VM1464A1	COPERCHIO SONDA TEMPERATUR A CT BT CON PA	1.000	PZ	VM1465A1	COPERCHIO SONDA TEMPERATUR A CT BT	1.000	PZ	VM2052A0	COPERCHIO SONDA TEMPERATUR A LM	1.000	PZ
Code	Description	Qty	UOM																		
VM1464A1	COPERCHIO SONDA TEMPERATUR A CT BT CON PA	1.000	PZ																		
VM1465A1	COPERCHIO SONDA TEMPERATUR A CT BT	1.000	PZ																		
VM2052A0	COPERCHIO SONDA TEMPERATUR A LM	1.000	PZ																		
EL1251A	ELETTROVALVOLA H2O 1 VIA RID. MARRONE		KEL1251A	JG D8-D10 1 WAY SOLENOID VALVE KI	<table border="1"> <thead> <tr> <th>Code</th> <th>Description</th> <th>Qty</th> <th>UOM</th> </tr> </thead> <tbody> <tr> <td>EL1251A0</td> <td>ELETTROVALV OLA H2O 1 VIA RID. MARRON</td> <td>1.000</td> <td>PZ</td> </tr> </tbody> </table>	Code	Description	Qty	UOM	EL1251A0	ELETTROVALV OLA H2O 1 VIA RID. MARRON	1.000	PZ								
Code	Description	Qty	UOM																		
EL1251A0	ELETTROVALV OLA H2O 1 VIA RID. MARRON	1.000	PZ																		
0H2551A	ST STEEL DRAIN GRID		K0H2551A	DRAIN COVER KIT	<table border="1"> <thead> <tr> <th>Code</th> <th>Description</th> <th>Qty</th> <th>UOM</th> </tr> </thead> <tbody> <tr> <td>0H2617A0</td> <td>GRIGLIA DI SCARICO AISI316</td> <td>1.000</td> <td>PZ</td> </tr> </tbody> </table>	Code	Description	Qty	UOM	0H2617A0	GRIGLIA DI SCARICO AISI316	1.000	PZ								
Code	Description	Qty	UOM																		
0H2617A0	GRIGLIA DI SCARICO AISI316	1.000	PZ																		
RC1378A	FASCETTA STRINGI TUBO D25-40 ZINCATA		KVM2379A	MM 200V VENTURI ACTUATOR SYSTEM KIT	<table border="1"> <thead> <tr> <th>Code</th> <th>Description</th> <th>Qty</th> <th>UOM</th> </tr> </thead> <tbody> <tr> <td>RC1378A0</td> <td>FASCETTA STRINGI TUBO D25-40 ZINCAT</td> <td>3.000</td> <td>PZ</td> </tr> <tr> <td>TB1520A0</td> <td>TUBO D.INT=30 SP=4 GOMMA EPDM NERO</td> <td>0.050</td> <td>M</td> </tr> <tr> <td>VM2379A1</td> <td>ASM VENTURI 200V 50/60 HZ JAP</td> <td>1.000</td> <td>PZ</td> </tr> </tbody> </table>	Code	Description	Qty	UOM	RC1378A0	FASCETTA STRINGI TUBO D25-40 ZINCAT	3.000	PZ	TB1520A0	TUBO D.INT=30 SP=4 GOMMA EPDM NERO	0.050	M	VM2379A1	ASM VENTURI 200V 50/60 HZ JAP	1.000	PZ
Code	Description	Qty	UOM																		
RC1378A0	FASCETTA STRINGI TUBO D25-40 ZINCAT	3.000	PZ																		
TB1520A0	TUBO D.INT=30 SP=4 GOMMA EPDM NERO	0.050	M																		
VM2379A1	ASM VENTURI 200V 50/60 HZ JAP	1.000	PZ																		
			KVM2378A	MM 240V VENTURI ACTUATOR SYSTEM KIT	<table border="1"> <thead> <tr> <th>Code</th> <th>Description</th> <th>Qty</th> <th>UOM</th> </tr> </thead> <tbody> <tr> <td>RC1378A0</td> <td>FASCETTA STRINGI TUBO D25-40 ZINCAT</td> <td>3.000</td> <td>PZ</td> </tr> <tr> <td>TB1520A0</td> <td>TUBO D.INT=30 SP=4 GOMMA EPDM NERO</td> <td>0.120</td> <td>M</td> </tr> <tr> <td>VM2378A1</td> <td>ASM VENTURI 240V 50/60 HZ UL USA</td> <td>1.000</td> <td>PZ</td> </tr> </tbody> </table>	Code	Description	Qty	UOM	RC1378A0	FASCETTA STRINGI TUBO D25-40 ZINCAT	3.000	PZ	TB1520A0	TUBO D.INT=30 SP=4 GOMMA EPDM NERO	0.120	M	VM2378A1	ASM VENTURI 240V 50/60 HZ UL USA	1.000	PZ
Code	Description	Qty	UOM																		
RC1378A0	FASCETTA STRINGI TUBO D25-40 ZINCAT	3.000	PZ																		
TB1520A0	TUBO D.INT=30 SP=4 GOMMA EPDM NERO	0.120	M																		
VM2378A1	ASM VENTURI 240V 50/60 HZ UL USA	1.000	PZ																		



COMPONENT			SPARE PART																		
Code	Description	Image	Code	Description	Kit components																
RC1378A	FASCETTA STRINGI TUBO D25-40 ZINCATA		KVM2377A	MM 220 V VENTURI ACTUATOR SYSTEM KIT	<table border="1"> <thead> <tr> <th>Code</th> <th>Description</th> <th>Qty</th> <th>UOM</th> </tr> </thead> <tbody> <tr> <td>RC1378A0</td> <td>FASCETTA STRINGI TUBO D25-40 ZINCAT</td> <td>3.000</td> <td>PZ</td> </tr> <tr> <td>TB1520A0</td> <td>TUBO D.INT=30 SP=4 GOMMA EPDM NERO</td> <td>0.050</td> <td>M</td> </tr> <tr> <td>VM2377A1</td> <td>ASM VENTURI 220V 50/60 HZ EU</td> <td>1.000</td> <td>PZ</td> </tr> </tbody> </table>	Code	Description	Qty	UOM	RC1378A0	FASCETTA STRINGI TUBO D25-40 ZINCAT	3.000	PZ	TB1520A0	TUBO D.INT=30 SP=4 GOMMA EPDM NERO	0.050	M	VM2377A1	ASM VENTURI 220V 50/60 HZ EU	1.000	PZ
					Code	Description	Qty	UOM													
					RC1378A0	FASCETTA STRINGI TUBO D25-40 ZINCAT	3.000	PZ													
					TB1520A0	TUBO D.INT=30 SP=4 GOMMA EPDM NERO	0.050	M													
VM2377A1	ASM VENTURI 220V 50/60 HZ EU	1.000	PZ																		
<table border="1"> <thead> <tr> <th>Code</th> <th>Description</th> <th>Qty</th> <th>UOM</th> </tr> </thead> <tbody> <tr> <td>RC1378A0</td> <td>FASCETTA STRINGI TUBO D25-40 ZINCAT</td> <td>2.000</td> <td>PZ</td> </tr> <tr> <td>TB1520A0</td> <td>TUBO D.INT=30 SP=4 GOMMA EPDM NERO</td> <td>0.050</td> <td>M</td> </tr> <tr> <td>VI1220A1</td> <td>VITE AUTOFIL. 4.2X11 TCS+ MARUTEX</td> <td>1.000</td> <td>PZ</td> </tr> <tr> <td>VM2632A0</td> <td>ASM BOBINA VENTURI S.5 VE1140A JAP</td> <td>1.000</td> <td>PZ</td> </tr> </tbody> </table>	Code	Description	Qty	UOM	RC1378A0	FASCETTA STRINGI TUBO D25-40 ZINCAT	2.000	PZ	TB1520A0	TUBO D.INT=30 SP=4 GOMMA EPDM NERO	0.050	M	VI1220A1	VITE AUTOFIL. 4.2X11 TCS+ MARUTEX	1.000	PZ	VM2632A0	ASM BOBINA VENTURI S.5 VE1140A JAP	1.000	PZ	
Code	Description	Qty	UOM																		
RC1378A0	FASCETTA STRINGI TUBO D25-40 ZINCAT	2.000	PZ																		
TB1520A0	TUBO D.INT=30 SP=4 GOMMA EPDM NERO	0.050	M																		
VI1220A1	VITE AUTOFIL. 4.2X11 TCS+ MARUTEX	1.000	PZ																		
VM2632A0	ASM BOBINA VENTURI S.5 VE1140A JAP	1.000	PZ																		
<table border="1"> <thead> <tr> <th>Code</th> <th>Description</th> <th>Qty</th> <th>UOM</th> </tr> </thead> <tbody> <tr> <td>RC1378A0</td> <td>FASCETTA STRINGI TUBO D25-40 ZINCAT</td> <td>2.000</td> <td>PZ</td> </tr> <tr> <td>TB1520A0</td> <td>TUBO D.INT=30 SP=4 GOMMA EPDM NERO</td> <td>0.050</td> <td>M</td> </tr> <tr> <td>VM2633A0</td> <td>ASM BOBINA VENTURI 120V S.5 VE1014A0 USA</td> <td>1.000</td> <td>PZ</td> </tr> </tbody> </table>	Code	Description	Qty	UOM	RC1378A0	FASCETTA STRINGI TUBO D25-40 ZINCAT	2.000	PZ	TB1520A0	TUBO D.INT=30 SP=4 GOMMA EPDM NERO	0.050	M	VM2633A0	ASM BOBINA VENTURI 120V S.5 VE1014A0 USA	1.000	PZ					
Code	Description	Qty	UOM																		
RC1378A0	FASCETTA STRINGI TUBO D25-40 ZINCAT	2.000	PZ																		
TB1520A0	TUBO D.INT=30 SP=4 GOMMA EPDM NERO	0.050	M																		
VM2633A0	ASM BOBINA VENTURI 120V S.5 VE1014A0 USA	1.000	PZ																		
<table border="1"> <thead> <tr> <th>Code</th> <th>Description</th> <th>Qty</th> <th>UOM</th> </tr> </thead> <tbody> <tr> <td>RC1378A0</td> <td>FASCETTA STRINGI TUBO D25-40 ZINCAT</td> <td>10.000</td> <td>PZ</td> </tr> </tbody> </table>	Code	Description	Qty	UOM	RC1378A0	FASCETTA STRINGI TUBO D25-40 ZINCAT	10.000	PZ													
Code	Description	Qty	UOM																		
RC1378A0	FASCETTA STRINGI TUBO D25-40 ZINCAT	10.000	PZ																		
RC1378A	FASCETTA STRINGI TUBO D25-40 ZINCATA		KVM2379A	MM 200V VENTURI ACTUATOR SYSTEM KIT	<table border="1"> <thead> <tr> <th>Code</th> <th>Description</th> <th>Qty</th> <th>UOM</th> </tr> </thead> <tbody> <tr> <td>RC1378A0</td> <td>FASCETTA STRINGI TUBO D25-40 ZINCAT</td> <td>3.000</td> <td>PZ</td> </tr> <tr> <td>TB1520A0</td> <td>TUBO D.INT=30 SP=4 GOMMA EPDM NERO</td> <td>0.050</td> <td>M</td> </tr> <tr> <td>VM2379A1</td> <td>ASM VENTURI 200V 50/60 HZ JAP</td> <td>1.000</td> <td>PZ</td> </tr> </tbody> </table>	Code	Description	Qty	UOM	RC1378A0	FASCETTA STRINGI TUBO D25-40 ZINCAT	3.000	PZ	TB1520A0	TUBO D.INT=30 SP=4 GOMMA EPDM NERO	0.050	M	VM2379A1	ASM VENTURI 200V 50/60 HZ JAP	1.000	PZ
					Code	Description	Qty	UOM													
					RC1378A0	FASCETTA STRINGI TUBO D25-40 ZINCAT	3.000	PZ													
					TB1520A0	TUBO D.INT=30 SP=4 GOMMA EPDM NERO	0.050	M													
VM2379A1	ASM VENTURI 200V 50/60 HZ JAP	1.000	PZ																		
<table border="1"> <thead> <tr> <th>Code</th> <th>Description</th> <th>Qty</th> <th>UOM</th> </tr> </thead> <tbody> <tr> <td>RC1378A0</td> <td>FASCETTA STRINGI TUBO D25-40 ZINCAT</td> <td>2.000</td> <td>PZ</td> </tr> <tr> <td>TB1520A0</td> <td>TUBO D.INT=30 SP=4 GOMMA EPDM NERO</td> <td>0.050</td> <td>M</td> </tr> <tr> <td>VM2633A0</td> <td>ASM BOBINA VENTURI 120V S.5 VE1014A0 USA</td> <td>1.000</td> <td>PZ</td> </tr> </tbody> </table>	Code	Description	Qty	UOM	RC1378A0	FASCETTA STRINGI TUBO D25-40 ZINCAT	2.000	PZ	TB1520A0	TUBO D.INT=30 SP=4 GOMMA EPDM NERO	0.050	M	VM2633A0	ASM BOBINA VENTURI 120V S.5 VE1014A0 USA	1.000	PZ					
Code	Description	Qty	UOM																		
RC1378A0	FASCETTA STRINGI TUBO D25-40 ZINCAT	2.000	PZ																		
TB1520A0	TUBO D.INT=30 SP=4 GOMMA EPDM NERO	0.050	M																		
VM2633A0	ASM BOBINA VENTURI 120V S.5 VE1014A0 USA	1.000	PZ																		
<table border="1"> <thead> <tr> <th>Code</th> <th>Description</th> <th>Qty</th> <th>UOM</th> </tr> </thead> <tbody> <tr> <td>RC1378A0</td> <td>FASCETTA STRINGI TUBO D25-40 ZINCAT</td> <td>2.000</td> <td>PZ</td> </tr> <tr> <td>TB1520A0</td> <td>TUBO D.INT=30 SP=4 GOMMA EPDM NERO</td> <td>0.050</td> <td>M</td> </tr> <tr> <td>VM2633A0</td> <td>ASM BOBINA VENTURI 120V S.5 VE1014A0 USA</td> <td>1.000</td> <td>PZ</td> </tr> </tbody> </table>	Code	Description	Qty	UOM	RC1378A0	FASCETTA STRINGI TUBO D25-40 ZINCAT	2.000	PZ	TB1520A0	TUBO D.INT=30 SP=4 GOMMA EPDM NERO	0.050	M	VM2633A0	ASM BOBINA VENTURI 120V S.5 VE1014A0 USA	1.000	PZ					
Code	Description	Qty	UOM																		
RC1378A0	FASCETTA STRINGI TUBO D25-40 ZINCAT	2.000	PZ																		
TB1520A0	TUBO D.INT=30 SP=4 GOMMA EPDM NERO	0.050	M																		
VM2633A0	ASM BOBINA VENTURI 120V S.5 VE1014A0 USA	1.000	PZ																		
<table border="1"> <thead> <tr> <th>Code</th> <th>Description</th> <th>Qty</th> <th>UOM</th> </tr> </thead> <tbody> <tr> <td>RC1378A0</td> <td>FASCETTA STRINGI TUBO D25-40 ZINCAT</td> <td>10.000</td> <td>PZ</td> </tr> </tbody> </table>	Code	Description	Qty	UOM	RC1378A0	FASCETTA STRINGI TUBO D25-40 ZINCAT	10.000	PZ													
Code	Description	Qty	UOM																		
RC1378A0	FASCETTA STRINGI TUBO D25-40 ZINCAT	10.000	PZ																		



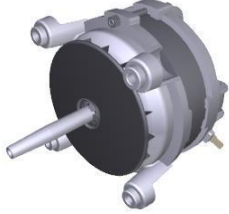

COMPONENT			SPARE PART																			
Code	Description	Image	Code	Description	Kit components																	
RC1378A	FASCETTA STRINGI TUBO D25-40 ZINCATA		KVM2378A	MM 240V VENTURI ACTUATOR SYSTEM KIT	<table border="1"> <thead> <tr> <th>Code</th> <th>Description</th> <th>Qty</th> <th>UOM</th> </tr> </thead> <tbody> <tr> <td>RC1378A0</td> <td>FASCETTA STRINGI TUBO D25-40 ZINCAT</td> <td>3.000</td> <td>PZ</td> </tr> <tr> <td>TB1520A0</td> <td>TUBO D.INT=30 SP=4 GOMMA EPDM NERO</td> <td>0.120</td> <td>M</td> </tr> <tr> <td>VM2378A1</td> <td>ASM VENTURI 240V 50/60 HZ UL USA</td> <td>1.000</td> <td>PZ</td> </tr> </tbody> </table>	Code	Description	Qty	UOM	RC1378A0	FASCETTA STRINGI TUBO D25-40 ZINCAT	3.000	PZ	TB1520A0	TUBO D.INT=30 SP=4 GOMMA EPDM NERO	0.120	M	VM2378A1	ASM VENTURI 240V 50/60 HZ UL USA	1.000	PZ	
			Code	Description	Qty	UOM																
			RC1378A0	FASCETTA STRINGI TUBO D25-40 ZINCAT	3.000	PZ																
			TB1520A0	TUBO D.INT=30 SP=4 GOMMA EPDM NERO	0.120	M																
VM2378A1	ASM VENTURI 240V 50/60 HZ UL USA	1.000	PZ																			
KVM2377A	MM 220 V VENTURI ACTUATOR SYSTEM KIT	<table border="1"> <thead> <tr> <th>Code</th> <th>Description</th> <th>Qty</th> <th>UOM</th> </tr> </thead> <tbody> <tr> <td>RC1378A0</td> <td>FASCETTA STRINGI TUBO D25-40 ZINCAT</td> <td>3.000</td> <td>PZ</td> </tr> <tr> <td>TB1520A0</td> <td>TUBO D.INT=30 SP=4 GOMMA EPDM NERO</td> <td>0.050</td> <td>M</td> </tr> <tr> <td>VM2377A1</td> <td>ASM VENTURI 220V 50/60 HZ EU</td> <td>1.000</td> <td>PZ</td> </tr> </tbody> </table>	Code	Description	Qty	UOM	RC1378A0	FASCETTA STRINGI TUBO D25-40 ZINCAT	3.000	PZ	TB1520A0	TUBO D.INT=30 SP=4 GOMMA EPDM NERO	0.050	M	VM2377A1	ASM VENTURI 220V 50/60 HZ EU	1.000	PZ				
Code	Description	Qty	UOM																			
RC1378A0	FASCETTA STRINGI TUBO D25-40 ZINCAT	3.000	PZ																			
TB1520A0	TUBO D.INT=30 SP=4 GOMMA EPDM NERO	0.050	M																			
VM2377A1	ASM VENTURI 220V 50/60 HZ EU	1.000	PZ																			
KVE1140A	S.5/5E JAPAN VERSION VENTURI COIL KIT	<table border="1"> <thead> <tr> <th>Code</th> <th>Description</th> <th>Qty</th> <th>UOM</th> </tr> </thead> <tbody> <tr> <td>RC1378A0</td> <td>FASCETTA STRINGI TUBO D25-40 ZINCAT</td> <td>2.000</td> <td>PZ</td> </tr> <tr> <td>TB1520A0</td> <td>TUBO D.INT=30 SP=4 GOMMA EPDM NERO</td> <td>0.050</td> <td>M</td> </tr> <tr> <td>VI1220A1</td> <td>VITE AUTOFIL. 4.2X11 TCS+ MARUTEX</td> <td>1.000</td> <td>PZ</td> </tr> <tr> <td>VM2632A0</td> <td>ASM BOBINA VENTURI S.5 VE1140A JAP</td> <td>1.000</td> <td>PZ</td> </tr> </tbody> </table>	Code	Description	Qty	UOM	RC1378A0	FASCETTA STRINGI TUBO D25-40 ZINCAT	2.000	PZ	TB1520A0	TUBO D.INT=30 SP=4 GOMMA EPDM NERO	0.050	M	VI1220A1	VITE AUTOFIL. 4.2X11 TCS+ MARUTEX	1.000	PZ	VM2632A0	ASM BOBINA VENTURI S.5 VE1140A JAP	1.000	PZ
Code	Description	Qty	UOM																			
RC1378A0	FASCETTA STRINGI TUBO D25-40 ZINCAT	2.000	PZ																			
TB1520A0	TUBO D.INT=30 SP=4 GOMMA EPDM NERO	0.050	M																			
VI1220A1	VITE AUTOFIL. 4.2X11 TCS+ MARUTEX	1.000	PZ																			
VM2632A0	ASM BOBINA VENTURI S.5 VE1140A JAP	1.000	PZ																			
KVE1014A	US VERSION SERIES 5 VENTURI COIL KIT	<table border="1"> <thead> <tr> <th>Code</th> <th>Description</th> <th>Qty</th> <th>UOM</th> </tr> </thead> <tbody> <tr> <td>RC1378A0</td> <td>FASCETTA STRINGI TUBO D25-40 ZINCAT</td> <td>2.000</td> <td>PZ</td> </tr> <tr> <td>TB1520A0</td> <td>TUBO D.INT=30 SP=4 GOMMA EPDM NERO</td> <td>0.050</td> <td>M</td> </tr> <tr> <td>VM2633A0</td> <td>ASM BOBINA VENTURI 120V S.5 VE1014A0 USA</td> <td>1.000</td> <td>PZ</td> </tr> </tbody> </table>	Code	Description	Qty	UOM	RC1378A0	FASCETTA STRINGI TUBO D25-40 ZINCAT	2.000	PZ	TB1520A0	TUBO D.INT=30 SP=4 GOMMA EPDM NERO	0.050	M	VM2633A0	ASM BOBINA VENTURI 120V S.5 VE1014A0 USA	1.000	PZ				
Code	Description	Qty	UOM																			
RC1378A0	FASCETTA STRINGI TUBO D25-40 ZINCAT	2.000	PZ																			
TB1520A0	TUBO D.INT=30 SP=4 GOMMA EPDM NERO	0.050	M																			
VM2633A0	ASM BOBINA VENTURI 120V S.5 VE1014A0 USA	1.000	PZ																			
KRC1378A	HOSE CLAMP 10 PCS KIT	<table border="1"> <thead> <tr> <th>Code</th> <th>Description</th> <th>Qty</th> <th>UOM</th> </tr> </thead> <tbody> <tr> <td>RC1378A0</td> <td>FASCETTA STRINGI TUBO D25-40 ZINCAT</td> <td>10.000</td> <td>PZ</td> </tr> </tbody> </table>	Code	Description	Qty	UOM	RC1378A0	FASCETTA STRINGI TUBO D25-40 ZINCAT	10.000	PZ												
Code	Description	Qty	UOM																			
RC1378A0	FASCETTA STRINGI TUBO D25-40 ZINCAT	10.000	PZ																			

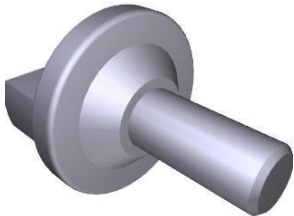
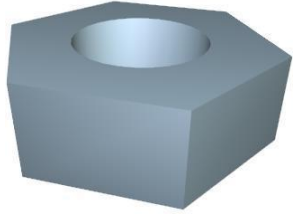

COMPONENT			SPARE PART														
Code	Description	Image	Code	Description	Kit components												
VL1022B	TERMINALE SCARICO LIQUIDI D3		KVL1022B	D30 WATER DRAIN END KIT	<table border="1"> <thead> <tr> <th>Code</th> <th>Description</th> <th>Qty</th> <th>UOM</th> </tr> </thead> <tbody> <tr> <td>VL1022B0</td> <td>TERMINALE SCARICO LIQUIDI D30</td> <td>1.000</td> <td>PZ</td> </tr> </tbody> </table>	Code	Description	Qty	UOM	VL1022B0	TERMINALE SCARICO LIQUIDI D30	1.000	PZ				
Code	Description	Qty	UOM														
VL1022B0	TERMINALE SCARICO LIQUIDI D30	1.000	PZ														
VM1223A	RED PE-LD CONICAL CAP D.22.7-24.9		VM1223A0	RED PE-LD CONICAL CAP D.22.7-24.9													
0H3020A	DISCO TENUTA ALBERO MOTORE		K0H3020A	CRANKSHAFT SEAL DISC	<table border="1"> <thead> <tr> <th>Code</th> <th>Description</th> <th>Qty</th> <th>UOM</th> </tr> </thead> <tbody> <tr> <td>0H3020A1</td> <td>DISCO TENUTA ALBERO MOTORE</td> <td>1.000</td> <td>PZ</td> </tr> <tr> <td>GN1546A0</td> <td>GUARNIZIONE ALBERO MOTORE D8</td> <td>1.000</td> <td>PZ</td> </tr> </tbody> </table>	Code	Description	Qty	UOM	0H3020A1	DISCO TENUTA ALBERO MOTORE	1.000	PZ	GN1546A0	GUARNIZIONE ALBERO MOTORE D8	1.000	PZ
Code	Description	Qty	UOM														
0H3020A1	DISCO TENUTA ALBERO MOTORE	1.000	PZ														
GN1546A0	GUARNIZIONE ALBERO MOTORE D8	1.000	PZ														
0H7170A	MM MOTOR GLASS WOOL PLATE		0H7170A0	MM MOTOR GLASS WOOL PLATE													
GN1547A	GUARNIZIONE ALBERO MOTORE D11.8		KGN1547A	D11.6 MOTOR SHAFT GASKET 3PCS KIT	<table border="1"> <thead> <tr> <th>Code</th> <th>Description</th> <th>Qty</th> <th>UOM</th> </tr> </thead> <tbody> <tr> <td>GN1547A1</td> <td>GUARNIZIONE ALBERO MOTORE D11.</td> <td>3.000</td> <td>PZ</td> </tr> </tbody> </table>	Code	Description	Qty	UOM	GN1547A1	GUARNIZIONE ALBERO MOTORE D11.	3.000	PZ				
Code	Description	Qty	UOM														
GN1547A1	GUARNIZIONE ALBERO MOTORE D11.	3.000	PZ														

COMPONENT			SPARE PART																																			
Code	Description	Image	Code	Description	Kit components																																	
MT1012A	MOTORE SIMMETRICO 330W 230V ALBERO D12		KVN1130A	LUX ≤08.2017/L.MISS/S.5/ 5E MOTOR KIT	<table border="1"> <thead> <tr> <th>Code</th> <th>Description</th> <th>Qty</th> <th>UOM</th> </tr> </thead> <tbody> <tr> <td>0H8118A0</td> <td>DISCO TENUTA ALBERO MOTORE XEVL</td> <td>1.000</td> <td>PZ</td> </tr> <tr> <td>GN1140A3</td> <td>GUARNIZIONE PORTAMOTO RE STAMPAT</td> <td>1.000</td> <td>PZ</td> </tr> <tr> <td>V11034A0</td> <td>RONDELLA PIANA 8.4x16x1 INOX</td> <td>1.000</td> <td>PZ</td> </tr> <tr> <td>V11256A0</td> <td>DADO M8 DIN 980M AUTOBLOCCA NTE INOX</td> <td>1.000</td> <td>PZ</td> </tr> <tr> <td>VM2196A0</td> <td>BOCCOLA FISSAGGIO DADO MOTOR</td> <td>1.000</td> <td>PZ</td> </tr> <tr> <td>VN1130A1</td> <td>MOTORE FORNO 330W 230V 50/60Hz ALBERO M8</td> <td>1.000</td> <td>PZ</td> </tr> </tbody> </table>	Code	Description	Qty	UOM	0H8118A0	DISCO TENUTA ALBERO MOTORE XEVL	1.000	PZ	GN1140A3	GUARNIZIONE PORTAMOTO RE STAMPAT	1.000	PZ	V11034A0	RONDELLA PIANA 8.4x16x1 INOX	1.000	PZ	V11256A0	DADO M8 DIN 980M AUTOBLOCCA NTE INOX	1.000	PZ	VM2196A0	BOCCOLA FISSAGGIO DADO MOTOR	1.000	PZ	VN1130A1	MOTORE FORNO 330W 230V 50/60Hz ALBERO M8	1.000	PZ					
			Code	Description	Qty	UOM																																
0H8118A0	DISCO TENUTA ALBERO MOTORE XEVL	1.000	PZ																																			
GN1140A3	GUARNIZIONE PORTAMOTO RE STAMPAT	1.000	PZ																																			
V11034A0	RONDELLA PIANA 8.4x16x1 INOX	1.000	PZ																																			
V11256A0	DADO M8 DIN 980M AUTOBLOCCA NTE INOX	1.000	PZ																																			
VM2196A0	BOCCOLA FISSAGGIO DADO MOTOR	1.000	PZ																																			
VN1130A1	MOTORE FORNO 330W 230V 50/60Hz ALBERO M8	1.000	PZ																																			
KMT1012A	LUX >08.2017 / MIND.MAPS 330W MOTOR KIT	<table border="1"> <thead> <tr> <th>Code</th> <th>Description</th> <th>Qty</th> <th>UOM</th> </tr> </thead> <tbody> <tr> <td>0H2842A0</td> <td>MASCHERA CENTRAGGIO MT1012</td> <td>1.000</td> <td>PZ</td> </tr> <tr> <td>0H8118A0</td> <td>DISCO TENUTA ALBERO MOTORE XEVL</td> <td>1.000</td> <td>PZ</td> </tr> <tr> <td>GN1140A3</td> <td>GUARNIZIONE PORTAMOTO RE STAMPAT</td> <td>1.000</td> <td>PZ</td> </tr> <tr> <td>MT1012A0</td> <td>MOTORE SIMMETRICO 330W 230V ALBERO D12</td> <td>1.000</td> <td>PZ</td> </tr> <tr> <td>V11077A1</td> <td>VITE M6x12 TE INOX</td> <td>1.000</td> <td>PZ</td> </tr> <tr> <td>V11521A0</td> <td>RONDELLA PIANA 6x12x1 INOX</td> <td>1.000</td> <td>PZ</td> </tr> <tr> <td>V11966A1</td> <td>VITE M4X14 TSP+ ZN</td> <td>1.000</td> <td>PZ</td> </tr> <tr> <td>VM2880A0</td> <td>ASM MGT MISURA NUMERO GIRI</td> <td>1.000</td> <td>PZ</td> </tr> </tbody> </table>	Code	Description	Qty	UOM	0H2842A0	MASCHERA CENTRAGGIO MT1012	1.000	PZ	0H8118A0	DISCO TENUTA ALBERO MOTORE XEVL	1.000	PZ	GN1140A3	GUARNIZIONE PORTAMOTO RE STAMPAT	1.000	PZ	MT1012A0	MOTORE SIMMETRICO 330W 230V ALBERO D12	1.000	PZ	V11077A1	VITE M6x12 TE INOX	1.000	PZ	V11521A0	RONDELLA PIANA 6x12x1 INOX	1.000	PZ	V11966A1	VITE M4X14 TSP+ ZN	1.000	PZ	VM2880A0	ASM MGT MISURA NUMERO GIRI	1.000	PZ
Code	Description	Qty	UOM																																			
0H2842A0	MASCHERA CENTRAGGIO MT1012	1.000	PZ																																			
0H8118A0	DISCO TENUTA ALBERO MOTORE XEVL	1.000	PZ																																			
GN1140A3	GUARNIZIONE PORTAMOTO RE STAMPAT	1.000	PZ																																			
MT1012A0	MOTORE SIMMETRICO 330W 230V ALBERO D12	1.000	PZ																																			
V11077A1	VITE M6x12 TE INOX	1.000	PZ																																			
V11521A0	RONDELLA PIANA 6x12x1 INOX	1.000	PZ																																			
V11966A1	VITE M4X14 TSP+ ZN	1.000	PZ																																			
VM2880A0	ASM MGT MISURA NUMERO GIRI	1.000	PZ																																			

COMPONENT			SPARE PART																						
Code	Description	Image	Code	Description	Kit components																				
VN1181A	VENTOLA D196 H81 39 PALE VITE M6		KVN1181A	D196 H81 39 BLADES FAN+SCREW M6 KIT	<table border="1"> <thead> <tr> <th>Code</th> <th>Description</th> <th>Qty</th> <th>UOM</th> </tr> </thead> <tbody> <tr> <td>VH1077A1</td> <td>VITE M6x12 TE INOX</td> <td>1.000</td> <td>PZ</td> </tr> <tr> <td>VI1521A0</td> <td>RONDELLA PIANA 6x12x1 INOX</td> <td>1.000</td> <td>PZ</td> </tr> <tr> <td>VN1181A0</td> <td>VENTOLA D196 H81 39 PALE VITE M6</td> <td>1.000</td> <td>PZ</td> </tr> </tbody> </table>	Code	Description	Qty	UOM	VH1077A1	VITE M6x12 TE INOX	1.000	PZ	VI1521A0	RONDELLA PIANA 6x12x1 INOX	1.000	PZ	VN1181A0	VENTOLA D196 H81 39 PALE VITE M6	1.000	PZ				
			Code	Description	Qty	UOM																			
VH1077A1	VITE M6x12 TE INOX	1.000	PZ																						
VI1521A0	RONDELLA PIANA 6x12x1 INOX	1.000	PZ																						
VN1181A0	VENTOLA D196 H81 39 PALE VITE M6	1.000	PZ																						
KVN1030A	LUX ≤08.2017S.5/S.5E D196 FAN KIT	<table border="1"> <thead> <tr> <th>Code</th> <th>Description</th> <th>Qty</th> <th>UOM</th> </tr> </thead> <tbody> <tr> <td>VH1256A0</td> <td>DADO M8 DIN 980M AUTOBLOCCA NTE INOX</td> <td>1.000</td> <td>PZ</td> </tr> <tr> <td>VM2196A0</td> <td>BOCCOLA FISSAGGIO DADO MOTOR</td> <td>1.000</td> <td>PZ</td> </tr> <tr> <td>VN1030A5</td> <td>VENTOLA D196 H81 39 PALE DADO M</td> <td>1.000</td> <td>PZ</td> </tr> </tbody> </table>	Code	Description	Qty	UOM	VH1256A0	DADO M8 DIN 980M AUTOBLOCCA NTE INOX	1.000	PZ	VM2196A0	BOCCOLA FISSAGGIO DADO MOTOR	1.000	PZ	VN1030A5	VENTOLA D196 H81 39 PALE DADO M	1.000	PZ							
Code	Description	Qty	UOM																						
VH1256A0	DADO M8 DIN 980M AUTOBLOCCA NTE INOX	1.000	PZ																						
VM2196A0	BOCCOLA FISSAGGIO DADO MOTOR	1.000	PZ																						
VN1030A5	VENTOLA D196 H81 39 PALE DADO M	1.000	PZ																						
RS1284A	RES. CIRC. 3200W 230V+400W 190V 4SP H80		KRS1284A	4TURN 3200W 230V+400W 190V HEAT ELEM KIT	<table border="1"> <thead> <tr> <th>Code</th> <th>Description</th> <th>Qty</th> <th>UOM</th> </tr> </thead> <tbody> <tr> <td>GN1327A0</td> <td>GUARNIZIONE RESISTENZA 100x22</td> <td>1.000</td> <td>PZ</td> </tr> <tr> <td>RS1284A0</td> <td>RES. CIRC. 3200W 230V+400W 190V 4SP H80</td> <td>1.000</td> <td>PZ</td> </tr> <tr> <td>SL1045A0</td> <td>SILICONE ANTRACITE S57 80 ml</td> <td>1.000</td> <td>PZ</td> </tr> <tr> <td>VI1220A1</td> <td>VITE AUTOFIL. 4.2X11 TCS+ MARUTEX</td> <td>2.000</td> <td>PZ</td> </tr> </tbody> </table>	Code	Description	Qty	UOM	GN1327A0	GUARNIZIONE RESISTENZA 100x22	1.000	PZ	RS1284A0	RES. CIRC. 3200W 230V+400W 190V 4SP H80	1.000	PZ	SL1045A0	SILICONE ANTRACITE S57 80 ml	1.000	PZ	VI1220A1	VITE AUTOFIL. 4.2X11 TCS+ MARUTEX	2.000	PZ
			Code	Description	Qty	UOM																			
			GN1327A0	GUARNIZIONE RESISTENZA 100x22	1.000	PZ																			
			RS1284A0	RES. CIRC. 3200W 230V+400W 190V 4SP H80	1.000	PZ																			
SL1045A0	SILICONE ANTRACITE S57 80 ml	1.000	PZ																						
VI1220A1	VITE AUTOFIL. 4.2X11 TCS+ MARUTEX	2.000	PZ																						
GRL1025A	GRIGLIA LAT DX/SX 4 600x400 LM ROSSELLA		KGRL1025A	LM ROSSELLA 4X60X40 LAT. SUPPORT KIT	<table border="1"> <thead> <tr> <th>Code</th> <th>Description</th> <th>Qty</th> <th>UOM</th> </tr> </thead> <tbody> <tr> <td>GRL1025A1</td> <td>GRIGLIA LAT DX/SX 4 600x400 LM ROSSELLA</td> <td>2.000</td> <td>PZ</td> </tr> </tbody> </table>	Code	Description	Qty	UOM	GRL1025A1	GRIGLIA LAT DX/SX 4 600x400 LM ROSSELLA	2.000	PZ												
Code	Description	Qty	UOM																						
GRL1025A1	GRIGLIA LAT DX/SX 4 600x400 LM ROSSELLA	2.000	PZ																						

COMPONENT			SPARE PART										
Code	Description	Image	Code	Description	Kit components								
VM1815A	NOTTOLINO M6 CROMATO FISS. GRIGLIE		KVM1815A	MISS/MICRO/S4/S3 THUMB SCREW 10 PCS KIT	<table border="1"> <thead> <tr> <th>Code</th> <th>Description</th> <th>Qty</th> <th>UOM</th> </tr> </thead> <tbody> <tr> <td>VM1815A0</td> <td>NOTTOLINO M6 CROMATO FISS. GRIGLIE</td> <td>10.000</td> <td>PZ</td> </tr> </tbody> </table>	Code	Description	Qty	UOM	VM1815A0	NOTTOLINO M6 CROMATO FISS. GRIGLIE	10.000	PZ
Code	Description	Qty	UOM										
VM1815A0	NOTTOLINO M6 CROMATO FISS. GRIGLIE	10.000	PZ										
RC1170A	DADO M14 H7 CH22 INOX DIN 439		KRC1170A	M14 H8 CH22 NUT - 10 PCS. KIT	<table border="1"> <thead> <tr> <th>Code</th> <th>Description</th> <th>Qty</th> <th>UOM</th> </tr> </thead> <tbody> <tr> <td>RC1170A1</td> <td>DADO M14 H7 CH22 INOX DIN 439</td> <td>10.000</td> <td>PZ</td> </tr> </tbody> </table>	Code	Description	Qty	UOM	RC1170A1	DADO M14 H7 CH22 INOX DIN 439	10.000	PZ
Code	Description	Qty	UOM										
RC1170A1	DADO M14 H7 CH22 INOX DIN 439	10.000	PZ										
TB1567A	ROSSELLA SHOP PRO FUME CHIMNEY D30		TB1567A0	ROSSELLA SHOP PRO FUME CHIMNEY D30									
TB1568A	ARI-STE-ROS SP WELDED EXT HUMIDITY PIPE		TB1568A0	ARI-STE-ROS SP WELDED EXT HUMIDITY PIPE									
TB1581A	ROSSELLA SHOP PRO INTERNAL HUMIDITY PIPE		TB1581A0	ROSSELLA SHOP PRO INTERNAL HUMIDITY PIPE									



COMPONENT			SPARE PART										
Code	Description	Image	Code	Description	Kit components								
VM2331A	PERNO M6 FERMA CARTER-SUPPORT O TEGLIE		KVM2331A	FAN GUARD-TRAYS HOLDER PIN 4 PCS KIT	<table border="1"> <thead> <tr> <th>Code</th> <th>Description</th> <th>Qty</th> <th>UOM</th> </tr> </thead> <tbody> <tr> <td>VM2331A0</td> <td>PERNO M6 FERMA CARTER-SUPP ORTO TEGLIE</td> <td>4.000</td> <td>PZ</td> </tr> </tbody> </table>	Code	Description	Qty	UOM	VM2331A0	PERNO M6 FERMA CARTER-SUPP ORTO TEGLIE	4.000	PZ
Code	Description	Qty	UOM										
VM2331A0	PERNO M6 FERMA CARTER-SUPP ORTO TEGLIE	4.000	PZ										



ASM3410A/0.D04 - External cover - FRONT









ASM3410A/0.D04 - External cover - REAR





COMPONENT			SPARE PART														
Code	Description	Image	Code	Description	Kit components												
0D2404B	SP DROP-DOWN ROSSELLA OVEN EXT CASING		0D2404B2	SP DROP-DOWN ROSSELLA OVEN EXT CASING													
0D2411A	SP800 INF FRONT PROFILE DROP DOWN DOOR		0D2411A1	SP800 INF FRONT PROFILE DROP DOWN DOOR													
0E1382A	SHOP.Pro800 EXTERNAL BOTTOM PANEL		0E1382A2	SHOP.Pro800 EXTERNAL BOTTOM PANEL													
0F1544B	ROSSELLA SHOP PRO BACK PANEL		0F1544B2	ROSSELLA SHOP PRO BACK PANEL													
CR1000A	ATTACCO CERNIERA PORTA FORNO RIBALTA		KCR1000A	LM HINGES LATCH KIT	<table border="1"> <thead> <tr> <th>Code</th> <th>Description</th> <th>Qty</th> <th>UOM</th> </tr> </thead> <tbody> <tr> <td>CR1000A0</td> <td>ATTACCO CERNIERA PORTA FORNO RIBALTA</td> <td>1.000</td> <td>PZ</td> </tr> <tr> <td>VI1280A3</td> <td>VITE M5X10 TC1/2T COMBI ZN-NI</td> <td>2.000</td> <td>PZ</td> </tr> </tbody> </table>	Code	Description	Qty	UOM	CR1000A0	ATTACCO CERNIERA PORTA FORNO RIBALTA	1.000	PZ	VI1280A3	VITE M5X10 TC1/2T COMBI ZN-NI	2.000	PZ
Code	Description	Qty	UOM														
CR1000A0	ATTACCO CERNIERA PORTA FORNO RIBALTA	1.000	PZ														
VI1280A3	VITE M5X10 TC1/2T COMBI ZN-NI	2.000	PZ														



COMPONENT			SPARE PART														
Code	Description	Image	Code	Description	Kit components												
VM1750A	MORSETTO A PETTINE		KVM1750A	COMB TERMINAL BLOCK KIT	<table border="1"> <thead> <tr> <th>Code</th> <th>Description</th> <th>Qty</th> <th>UOM</th> </tr> </thead> <tbody> <tr> <td>VH1040A0</td> <td>ROSETTA DENTELLATA INTERNA ø6 Z</td> <td>2.000</td> <td>PZ</td> </tr> <tr> <td>VM1750A0</td> <td>MORSETTO A PETTINE</td> <td>1.000</td> <td>PZ</td> </tr> </tbody> </table>	Code	Description	Qty	UOM	VH1040A0	ROSETTA DENTELLATA INTERNA ø6 Z	2.000	PZ	VM1750A0	MORSETTO A PETTINE	1.000	PZ
Code	Description	Qty	UOM														
VH1040A0	ROSETTA DENTELLATA INTERNA ø6 Z	2.000	PZ														
VM1750A0	MORSETTO A PETTINE	1.000	PZ														
VM2502A	ANELLO CAMINO SP		KVM2502A	BAKERLUX SHOP.PRO CHIMNEY RING KIT	<table border="1"> <thead> <tr> <th>Code</th> <th>Description</th> <th>Qty</th> <th>UOM</th> </tr> </thead> <tbody> <tr> <td>VM2502A0</td> <td>ANELLO CAMINO SP</td> <td>1.000</td> <td>PZ</td> </tr> </tbody> </table>	Code	Description	Qty	UOM	VM2502A0	ANELLO CAMINO SP	1.000	PZ				
Code	Description	Qty	UOM														
VM2502A0	ANELLO CAMINO SP	1.000	PZ														
VM2495A	SUPPORTO VENTOLA RAFFREDDAMENTO SP		KVM2495A	COOLING FAN SUPPORT KIT	<table border="1"> <thead> <tr> <th>Code</th> <th>Description</th> <th>Qty</th> <th>UOM</th> </tr> </thead> <tbody> <tr> <td>VH1220A1</td> <td>VITE AUTOFIL. 4.2X11 TCS+ MARUTEX</td> <td>2.000</td> <td>PZ</td> </tr> <tr> <td>VM2495A0</td> <td>SUPPORTO VENTOLA RAFFREDDAM ENTO SP</td> <td>1.000</td> <td>PZ</td> </tr> </tbody> </table>	Code	Description	Qty	UOM	VH1220A1	VITE AUTOFIL. 4.2X11 TCS+ MARUTEX	2.000	PZ	VM2495A0	SUPPORTO VENTOLA RAFFREDDAM ENTO SP	1.000	PZ
Code	Description	Qty	UOM														
VH1220A1	VITE AUTOFIL. 4.2X11 TCS+ MARUTEX	2.000	PZ														
VM2495A0	SUPPORTO VENTOLA RAFFREDDAM ENTO SP	1.000	PZ														
VN1175A	VENTOLA RAFFR. 120x120 230V 50/60Hz 80°C		KVN1175A	120x120 230V 50/60Hz COOLING FAN KIT	<table border="1"> <thead> <tr> <th>Code</th> <th>Description</th> <th>Qty</th> <th>UOM</th> </tr> </thead> <tbody> <tr> <td>VN1175A0</td> <td>VENTOLA RAFFR. 120x120 230V 50/60Hz 80°C</td> <td>1.000</td> <td>PZ</td> </tr> </tbody> </table>	Code	Description	Qty	UOM	VN1175A0	VENTOLA RAFFR. 120x120 230V 50/60Hz 80°C	1.000	PZ				
Code	Description	Qty	UOM														
VN1175A0	VENTOLA RAFFR. 120x120 230V 50/60Hz 80°C	1.000	PZ														
VE1295A	MICROINTERRUTTO RE PORTA MK 16A 230V UL		KVE1295A	16A 230V DOOR MICROSWITCH KIT	<table border="1"> <thead> <tr> <th>Code</th> <th>Description</th> <th>Qty</th> <th>UOM</th> </tr> </thead> <tbody> <tr> <td>VE1295A0</td> <td>MICROINTERR UTTORE PORTA MK 16A 230V UL</td> <td>1.000</td> <td>PZ</td> </tr> </tbody> </table>	Code	Description	Qty	UOM	VE1295A0	MICROINTERR UTTORE PORTA MK 16A 230V UL	1.000	PZ				
Code	Description	Qty	UOM														
VE1295A0	MICROINTERR UTTORE PORTA MK 16A 230V UL	1.000	PZ														



COMPONENT			SPARE PART														
Code	Description	Image	Code	Description	Kit components												
VM2508A	COVER MICRO PORTA BAKERLUX SHOP.PRO		KVM2508A	BAKERLUX SHOP.PRO MICROSWITCH COVER KIT	<table border="1"> <thead> <tr> <th>Code</th> <th>Description</th> <th>Qty</th> <th>UOM</th> </tr> </thead> <tbody> <tr> <td>VM2508A0</td> <td>COVER MICRO PORTA BAKERLUX SHOP.PRO</td> <td>1.000</td> <td>PZ</td> </tr> </tbody> </table>	Code	Description	Qty	UOM	VM2508A0	COVER MICRO PORTA BAKERLUX SHOP.PRO	1.000	PZ				
Code	Description	Qty	UOM														
VM2508A0	COVER MICRO PORTA BAKERLUX SHOP.PRO	1.000	PZ														
VM2481A	TAPPO FACCIATA COPERTURA ESTERNA SX SP		KVM2481A	BL SP LEFT EXT COVER FRONT PANEL CAP KIT	<table border="1"> <thead> <tr> <th>Code</th> <th>Description</th> <th>Qty</th> <th>UOM</th> </tr> </thead> <tbody> <tr> <td>VM2481A0</td> <td>TAPPO FACCIATA COPERTURA ESTERNA SX SP</td> <td>1.000</td> <td>PZ</td> </tr> </tbody> </table>	Code	Description	Qty	UOM	VM2481A0	TAPPO FACCIATA COPERTURA ESTERNA SX SP	1.000	PZ				
Code	Description	Qty	UOM														
VM2481A0	TAPPO FACCIATA COPERTURA ESTERNA SX SP	1.000	PZ														
VM2480A	TAPPO FACCIATA COPERTURA ESTERNA DX SP		KVM2480A	BL SP RIGHT EXT COVER FRONT PANEL CAP	<table border="1"> <thead> <tr> <th>Code</th> <th>Description</th> <th>Qty</th> <th>UOM</th> </tr> </thead> <tbody> <tr> <td>VM2480A0</td> <td>TAPPO FACCIATA COPERTURA ESTERNA DX SP</td> <td>1.000</td> <td>PZ</td> </tr> </tbody> </table>	Code	Description	Qty	UOM	VM2480A0	TAPPO FACCIATA COPERTURA ESTERNA DX SP	1.000	PZ				
Code	Description	Qty	UOM														
VM2480A0	TAPPO FACCIATA COPERTURA ESTERNA DX SP	1.000	PZ														
VM1631A	TAPPO PREMI VETRO INTERNO PLUS		KVM1631A	CAP FOR INTERNAL GLASS 10 PCS KIT	<table border="1"> <thead> <tr> <th>Code</th> <th>Description</th> <th>Qty</th> <th>UOM</th> </tr> </thead> <tbody> <tr> <td>VM1631A0</td> <td>TAPPO PREMI VETRO INTERNO PLU</td> <td>10.000</td> <td>PZ</td> </tr> </tbody> </table>	Code	Description	Qty	UOM	VM1631A0	TAPPO PREMI VETRO INTERNO PLU	10.000	PZ				
Code	Description	Qty	UOM														
VM1631A0	TAPPO PREMI VETRO INTERNO PLU	10.000	PZ														
VM2492A	GUARNIZIONE FONDO EST. FRONTALE L800 SP		KVM2492A	SP 600X400 EXT BOT PANEL GASKET 2PC KIT	<table border="1"> <thead> <tr> <th>Code</th> <th>Description</th> <th>Qty</th> <th>UOM</th> </tr> </thead> <tbody> <tr> <td>VM1794A0</td> <td>FASCETTA 430X4.8 PA66 NERA</td> <td>1.000</td> <td>PZ</td> </tr> <tr> <td>VM2492A0</td> <td>GUARNIZIONE FONDO EST. FRONTALE L800 SP</td> <td>2.000</td> <td>PZ</td> </tr> </tbody> </table>	Code	Description	Qty	UOM	VM1794A0	FASCETTA 430X4.8 PA66 NERA	1.000	PZ	VM2492A0	GUARNIZIONE FONDO EST. FRONTALE L800 SP	2.000	PZ
Code	Description	Qty	UOM														
VM1794A0	FASCETTA 430X4.8 PA66 NERA	1.000	PZ														
VM2492A0	GUARNIZIONE FONDO EST. FRONTALE L800 SP	2.000	PZ														



COMPONENT			SPARE PART																		
Code	Description	Image	Code	Description	Kit components																
VM2493A	GUARNIZIONE FONDO EST. LATERALE SP800		KVM2493A	SP 600X400 BOT LAT PANEL GASKET 2PC KIT	<table border="1"> <thead> <tr> <th>Code</th> <th>Description</th> <th>Qty</th> <th>UOM</th> </tr> </thead> <tbody> <tr> <td>VM1631A0</td> <td>TAPPO PREMI VETRO INTERNO PLU</td> <td>4.000</td> <td>PZ</td> </tr> <tr> <td>VM1794A0</td> <td>FASCETTA 430X4.8 PA66 NERA</td> <td>1.000</td> <td>PZ</td> </tr> <tr> <td>VM2493A1</td> <td>GUARNIZIONE FONDO EST. LATERALE SP800</td> <td>2.000</td> <td>PZ</td> </tr> </tbody> </table>	Code	Description	Qty	UOM	VM1631A0	TAPPO PREMI VETRO INTERNO PLU	4.000	PZ	VM1794A0	FASCETTA 430X4.8 PA66 NERA	1.000	PZ	VM2493A1	GUARNIZIONE FONDO EST. LATERALE SP800	2.000	PZ
Code	Description	Qty	UOM																		
VM1631A0	TAPPO PREMI VETRO INTERNO PLU	4.000	PZ																		
VM1794A0	FASCETTA 430X4.8 PA66 NERA	1.000	PZ																		
VM2493A1	GUARNIZIONE FONDO EST. LATERALE SP800	2.000	PZ																		
VM1222A	CABLE LOCKS SP ACCESSORIES EL CONNECTION		VM1222A0	CABLE LOCKS SP ACCESSORIES EL CONNECTION																	
VM2249A	ANGOLO FACCIATA MUFFOLA PPS		KVM2249A	CHAMBER FRONT PROFILE CORNER KIT	<table border="1"> <thead> <tr> <th>Code</th> <th>Description</th> <th>Qty</th> <th>UOM</th> </tr> </thead> <tbody> <tr> <td>VM2249A0</td> <td>ANGOLO FACCIATA MUFFOLA PPS</td> <td>1.000</td> <td>PZ</td> </tr> </tbody> </table>	Code	Description	Qty	UOM	VM2249A0	ANGOLO FACCIATA MUFFOLA PPS	1.000	PZ								
Code	Description	Qty	UOM																		
VM2249A0	ANGOLO FACCIATA MUFFOLA PPS	1.000	PZ																		
VM2455A	CLIP PASSAGGIO CAVO CONTROLLO COMANDI SP		KVM2455A	BL SP CONTR BOARD CABLE PASS-THROUGH KIT	<table border="1"> <thead> <tr> <th>Code</th> <th>Description</th> <th>Qty</th> <th>UOM</th> </tr> </thead> <tbody> <tr> <td>VM2455A1</td> <td>CLIP PASSAGGIO CAVO CONTROLLO COMANDI SP</td> <td>1.000</td> <td>PZ</td> </tr> </tbody> </table>	Code	Description	Qty	UOM	VM2455A1	CLIP PASSAGGIO CAVO CONTROLLO COMANDI SP	1.000	PZ								
Code	Description	Qty	UOM																		
VM2455A1	CLIP PASSAGGIO CAVO CONTROLLO COMANDI SP	1.000	PZ																		





ASM3422B/0.D00 - Door - FRONT





ASM3422B/0.D00 - Door - REAR



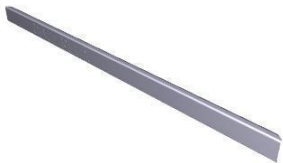



COMPONENT			SPARE PART																						
Code	Description	Image	Code	Description	Kit components																				
0B1290A	COLONNINA INT SX RIBALTA ARI-ROS S		0B1290A0	COLONNINA INT SX RIBALTA ARI-ROS S																					
0B1292A	COLONNINA INT DX RIBALTA ARI-ROS S		0B1292A0	COLONNINA INT DX RIBALTA ARI-ROS S																					
LP1050A	BARRA ILLUMINAZIONE LED L180 SP COMPLETA		KLP1050A	L180 COMPLETE LED LIGHT BAR KIT	<table border="1"> <thead> <tr> <th>Code</th> <th>Description</th> <th>Qty</th> <th>UOM</th> </tr> </thead> <tbody> <tr> <td>LP1050A0</td> <td>BARRA ILLUMINAZIONE LED L180 SP COMPLETA</td> <td>1.000</td> <td>PZ</td> </tr> <tr> <td>VI1014A0</td> <td>RONDELLA PIANA 4.5X9X0.8 INO</td> <td>1.000</td> <td>PZ</td> </tr> <tr> <td>VI1220A1</td> <td>VITE AUTOFIL. 4.2X11 TCS+ MARUTEX</td> <td>1.000</td> <td>PZ</td> </tr> <tr> <td>VM1447A0</td> <td>BUSTA AIRBALL ESD ROSA 230X450 MM</td> <td>0.500</td> <td>PZ</td> </tr> </tbody> </table>	Code	Description	Qty	UOM	LP1050A0	BARRA ILLUMINAZIONE LED L180 SP COMPLETA	1.000	PZ	VI1014A0	RONDELLA PIANA 4.5X9X0.8 INO	1.000	PZ	VI1220A1	VITE AUTOFIL. 4.2X11 TCS+ MARUTEX	1.000	PZ	VM1447A0	BUSTA AIRBALL ESD ROSA 230X450 MM	0.500	PZ
Code	Description	Qty	UOM																						
LP1050A0	BARRA ILLUMINAZIONE LED L180 SP COMPLETA	1.000	PZ																						
VI1014A0	RONDELLA PIANA 4.5X9X0.8 INO	1.000	PZ																						
VI1220A1	VITE AUTOFIL. 4.2X11 TCS+ MARUTEX	1.000	PZ																						
VM1447A0	BUSTA AIRBALL ESD ROSA 230X450 MM	0.500	PZ																						
TB3302A	TUBO MANIGLIA RIBALTA SP800		KTB3302A	BL SP 600X400 DROPDOWN HANDLE TUBE KIT	<table border="1"> <thead> <tr> <th>Code</th> <th>Description</th> <th>Qty</th> <th>UOM</th> </tr> </thead> <tbody> <tr> <td>TB3302A0</td> <td>TUBO MANIGLIA RIBALTA SP800</td> <td>1.000</td> <td>PZ</td> </tr> <tr> <td>VI1147A0</td> <td>VITE 5X25 TRUCIOLARE INOX</td> <td>4.000</td> <td>PZ</td> </tr> <tr> <td>VM2456A0</td> <td>TERMINALE MANIGLIA BL SP</td> <td>2.000</td> <td>PZ</td> </tr> </tbody> </table>	Code	Description	Qty	UOM	TB3302A0	TUBO MANIGLIA RIBALTA SP800	1.000	PZ	VI1147A0	VITE 5X25 TRUCIOLARE INOX	4.000	PZ	VM2456A0	TERMINALE MANIGLIA BL SP	2.000	PZ				
Code	Description	Qty	UOM																						
TB3302A0	TUBO MANIGLIA RIBALTA SP800	1.000	PZ																						
VI1147A0	VITE 5X25 TRUCIOLARE INOX	4.000	PZ																						
VM2456A0	TERMINALE MANIGLIA BL SP	2.000	PZ																						

COMPONENT			SPARE PART																		
Code	Description	Image	Code	Description	Kit components																
VM2456A	TERMINALE MANIGLIA BL SP		KVM2456A	2 PCS BAKERLUX SHOP.PRO HANDLE END KIT	<table border="1"> <thead> <tr> <th>Code</th> <th>Description</th> <th>Qty</th> <th>UOM</th> </tr> </thead> <tbody> <tr> <td>V11147A0</td> <td>VITE 5X25 TRUCIOLARE INOX</td> <td>4.000</td> <td>PZ</td> </tr> <tr> <td>VM2456A0</td> <td>TERMINALE MANIGLIA BL SP</td> <td>2.000</td> <td>PZ</td> </tr> </tbody> </table>	Code	Description	Qty	UOM	V11147A0	VITE 5X25 TRUCIOLARE INOX	4.000	PZ	VM2456A0	TERMINALE MANIGLIA BL SP	2.000	PZ				
Code	Description	Qty	UOM																		
V11147A0	VITE 5X25 TRUCIOLARE INOX	4.000	PZ																		
VM2456A0	TERMINALE MANIGLIA BL SP	2.000	PZ																		
VM2471A	SEDE INF CORSOIO BLOCCA VETRO INTERNO SP		KVM2471A	BL SP INTERNAL GLASS LOCK HOLDER KIT	<table border="1"> <thead> <tr> <th>Code</th> <th>Description</th> <th>Qty</th> <th>UOM</th> </tr> </thead> <tbody> <tr> <td>V11998A0</td> <td>VITE TRUCIOLARE 5X30 TCB ZINCATA</td> <td>2.000</td> <td>PZ</td> </tr> <tr> <td>VM2471A0</td> <td>SEDE INF CORSOIO BLOCCA VETRO INTERNO SP</td> <td>1.000</td> <td>PZ</td> </tr> <tr> <td>VM2472A0</td> <td>SEDE SUP CORSOIO BLOCCA VETRO INTERNO SP</td> <td>1.000</td> <td>PZ</td> </tr> </tbody> </table>	Code	Description	Qty	UOM	V11998A0	VITE TRUCIOLARE 5X30 TCB ZINCATA	2.000	PZ	VM2471A0	SEDE INF CORSOIO BLOCCA VETRO INTERNO SP	1.000	PZ	VM2472A0	SEDE SUP CORSOIO BLOCCA VETRO INTERNO SP	1.000	PZ
Code	Description	Qty	UOM																		
V11998A0	VITE TRUCIOLARE 5X30 TCB ZINCATA	2.000	PZ																		
VM2471A0	SEDE INF CORSOIO BLOCCA VETRO INTERNO SP	1.000	PZ																		
VM2472A0	SEDE SUP CORSOIO BLOCCA VETRO INTERNO SP	1.000	PZ																		
VM2503A	CORSOIO BLOCCA VETRO INTERNO FISSO SP		KVM2503A	BL SP INT FIXED GLASS LOCK 2 PCS KIT	<table border="1"> <thead> <tr> <th>Code</th> <th>Description</th> <th>Qty</th> <th>UOM</th> </tr> </thead> <tbody> <tr> <td>VM2503A0</td> <td>CORSOIO BLOCCA VETRO INTERNO FISSO SP</td> <td>2.000</td> <td>PZ</td> </tr> </tbody> </table>	Code	Description	Qty	UOM	VM2503A0	CORSOIO BLOCCA VETRO INTERNO FISSO SP	2.000	PZ								
Code	Description	Qty	UOM																		
VM2503A0	CORSOIO BLOCCA VETRO INTERNO FISSO SP	2.000	PZ																		
VM2464A	TAPPO SUPERIORE SX PORTA RIBALTA SP		KVM2464A	BL SP LEFT UPPER DROPDOWN DOOR CAP KIT	<table border="1"> <thead> <tr> <th>Code</th> <th>Description</th> <th>Qty</th> <th>UOM</th> </tr> </thead> <tbody> <tr> <td>VM2464A0</td> <td>TAPPO SUPERIORE SX PORTA RIBALTA SP</td> <td>1.000</td> <td>PZ</td> </tr> </tbody> </table>	Code	Description	Qty	UOM	VM2464A0	TAPPO SUPERIORE SX PORTA RIBALTA SP	1.000	PZ								
Code	Description	Qty	UOM																		
VM2464A0	TAPPO SUPERIORE SX PORTA RIBALTA SP	1.000	PZ																		

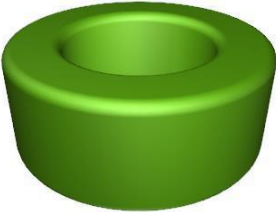
COMPONENT			SPARE PART																		
Code	Description	Image	Code	Description	Kit components																
VM2472A	SEDE SUP CORSOIO BLOCCA VETRO INTERNO SP		KVM2471A	BL SP INTERNAL GLASS LOCK HOLDER KIT	<table border="1"> <thead> <tr> <th>Code</th> <th>Description</th> <th>Qty</th> <th>UOM</th> </tr> </thead> <tbody> <tr> <td>VI1998A0</td> <td>VITE TRUCIOLARE 5X30 TCB ZINCATA</td> <td>2.000</td> <td>PZ</td> </tr> <tr> <td>VM2471A0</td> <td>SEDE INF CORSOIO BLOCCA VETRO INTERNO SP</td> <td>1.000</td> <td>PZ</td> </tr> <tr> <td>VM2472A0</td> <td>SEDE SUP CORSOIO BLOCCA VETRO INTERNO SP</td> <td>1.000</td> <td>PZ</td> </tr> </tbody> </table>	Code	Description	Qty	UOM	VI1998A0	VITE TRUCIOLARE 5X30 TCB ZINCATA	2.000	PZ	VM2471A0	SEDE INF CORSOIO BLOCCA VETRO INTERNO SP	1.000	PZ	VM2472A0	SEDE SUP CORSOIO BLOCCA VETRO INTERNO SP	1.000	PZ
Code	Description	Qty	UOM																		
VI1998A0	VITE TRUCIOLARE 5X30 TCB ZINCATA	2.000	PZ																		
VM2471A0	SEDE INF CORSOIO BLOCCA VETRO INTERNO SP	1.000	PZ																		
VM2472A0	SEDE SUP CORSOIO BLOCCA VETRO INTERNO SP	1.000	PZ																		
VM2503A	CORSOIO BLOCCA VETRO INTERNO FISSO SP		KVM2503A	BL SP INT FIXED GLASS LOCK 2 PCS KIT	<table border="1"> <thead> <tr> <th>Code</th> <th>Description</th> <th>Qty</th> <th>UOM</th> </tr> </thead> <tbody> <tr> <td>VM2503A0</td> <td>CORSOIO BLOCCA VETRO INTERNO FISSO SP</td> <td>2.000</td> <td>PZ</td> </tr> </tbody> </table>	Code	Description	Qty	UOM	VM2503A0	CORSOIO BLOCCA VETRO INTERNO FISSO SP	2.000	PZ								
Code	Description	Qty	UOM																		
VM2503A0	CORSOIO BLOCCA VETRO INTERNO FISSO SP	2.000	PZ																		
VM2463A	TAPPO SUPERIORE DX PORTA RIBALTA SP		KVM2463A	BL SP RIGHT UPPER DROPDOWN DOOR CAP KIT	<table border="1"> <thead> <tr> <th>Code</th> <th>Description</th> <th>Qty</th> <th>UOM</th> </tr> </thead> <tbody> <tr> <td>VM2463A0</td> <td>TAPPO SUPERIORE DX PORTA RIBALTA SP</td> <td>1.000</td> <td>PZ</td> </tr> </tbody> </table>	Code	Description	Qty	UOM	VM2463A0	TAPPO SUPERIORE DX PORTA RIBALTA SP	1.000	PZ								
Code	Description	Qty	UOM																		
VM2463A0	TAPPO SUPERIORE DX PORTA RIBALTA SP	1.000	PZ																		
TB1563A	TUBO TRAVERSO PORTA SP800		TB1563A0	TUBO TRAVERSO PORTA SP800																	

COMPONENT			SPARE PART														
Code	Description	Image	Code	Description	Kit components												
VI1174A	VITE 5X20 PER PLASTICA ZN-NI		VI1174A0	VITE 5X20 PER PLASTICA ZN-NI													
VM2461A	TAPPO INFERIORE DX PORTA RIBALTA SP		KVM2461A	BL SP RIGHT LOWER DROPDOWN DOOR CAP KIT	<table border="1"> <thead> <tr> <th>Code</th> <th>Description</th> <th>Qty</th> <th>UOM</th> </tr> </thead> <tbody> <tr> <td>VM2461A0</td> <td>TAPPO INFERIORE DX PORTA RIBALTA SP</td> <td>1.000</td> <td>PZ</td> </tr> </tbody> </table>	Code	Description	Qty	UOM	VM2461A0	TAPPO INFERIORE DX PORTA RIBALTA SP	1.000	PZ				
Code	Description	Qty	UOM														
VM2461A0	TAPPO INFERIORE DX PORTA RIBALTA SP	1.000	PZ														
VM2462A	TAPPO INFERIORE SX PORTA RIBALTA SP		KVM2462A	BL SP LEFT LOWER DROPDOWN DOOR CAP KIT	<table border="1"> <thead> <tr> <th>Code</th> <th>Description</th> <th>Qty</th> <th>UOM</th> </tr> </thead> <tbody> <tr> <td>VM2462A0</td> <td>TAPPO INFERIORE SX PORTA RIBALTA SP</td> <td>1.000</td> <td>PZ</td> </tr> </tbody> </table>	Code	Description	Qty	UOM	VM2462A0	TAPPO INFERIORE SX PORTA RIBALTA SP	1.000	PZ				
Code	Description	Qty	UOM														
VM2462A0	TAPPO INFERIORE SX PORTA RIBALTA SP	1.000	PZ														
VM1630A	TAPPO PREMI VETRO INTERNO		KVM1630A	CAP FOR INTERNAL GLASS 10 PCS KIT	<table border="1"> <thead> <tr> <th>Code</th> <th>Description</th> <th>Qty</th> <th>UOM</th> </tr> </thead> <tbody> <tr> <td>VM1630A1</td> <td>TAPPO PREMI VETRO INTERNO</td> <td>10.000</td> <td>PZ</td> </tr> </tbody> </table>	Code	Description	Qty	UOM	VM1630A1	TAPPO PREMI VETRO INTERNO	10.000	PZ				
Code	Description	Qty	UOM														
VM1630A1	TAPPO PREMI VETRO INTERNO	10.000	PZ														
VM2479A	SPINGIVETRO VETRO H6 BL SP		KVM2479A	BL SHOP.PRO H6 GLASS SUPPORT 6 PCS KIT	<table border="1"> <thead> <tr> <th>Code</th> <th>Description</th> <th>Qty</th> <th>UOM</th> </tr> </thead> <tbody> <tr> <td>VM1630A1</td> <td>TAPPO PREMI VETRO INTERNO</td> <td>6.000</td> <td>PZ</td> </tr> <tr> <td>VM2479A0</td> <td>SPINGIVETRO VETRO H6 BL SP</td> <td>6.000</td> <td>PZ</td> </tr> </tbody> </table>	Code	Description	Qty	UOM	VM1630A1	TAPPO PREMI VETRO INTERNO	6.000	PZ	VM2479A0	SPINGIVETRO VETRO H6 BL SP	6.000	PZ
Code	Description	Qty	UOM														
VM1630A1	TAPPO PREMI VETRO INTERNO	6.000	PZ														
VM2479A0	SPINGIVETRO VETRO H6 BL SP	6.000	PZ														

COMPONENT			SPARE PART																		
Code	Description	Image	Code	Description	Kit components																
CE1095A	CAVO BUS MICROFIT 4POLI 2M		KCE1095A	4POLES 2M BUS CABLE KIT POWER-CONTROL	<table border="1"> <thead> <tr> <th>Code</th> <th>Description</th> <th>Qty</th> <th>UOM</th> </tr> </thead> <tbody> <tr> <td>CE1095A0</td> <td>CAVO BUS MICROFIT 4POLI 2M</td> <td>1.000</td> <td>PZ</td> </tr> </tbody> </table>	Code	Description	Qty	UOM	CE1095A0	CAVO BUS MICROFIT 4POLI 2M	1.000	PZ								
Code	Description	Qty	UOM																		
CE1095A0	CAVO BUS MICROFIT 4POLI 2M	1.000	PZ																		
CE1285A	FERRITE EMI ROUND MOD. 2643801502		KCE1285A	ROUND FERRITE ELECTROMAGN PROT. 2PCS KIT	<table border="1"> <thead> <tr> <th>Code</th> <th>Description</th> <th>Qty</th> <th>UOM</th> </tr> </thead> <tbody> <tr> <td>CE1285A0</td> <td>FERRITE EMI ROUND MOD. 2643801502</td> <td>2.000</td> <td>PZ</td> </tr> </tbody> </table>	Code	Description	Qty	UOM	CE1285A0	FERRITE EMI ROUND MOD. 2643801502	2.000	PZ								
Code	Description	Qty	UOM																		
CE1285A0	FERRITE EMI ROUND MOD. 2643801502	2.000	PZ																		
CR1114A	CERNIERA PORTA RIBALTA SP ROSSELLA		KCR1114A	BL SP ROSSELLA DROPDOWN DOOR HINGE KIT	<table border="1"> <thead> <tr> <th>Code</th> <th>Description</th> <th>Qty</th> <th>UOM</th> </tr> </thead> <tbody> <tr> <td>CR1114A0</td> <td>CERNIERA PORTA RIBALTA SP ROSSELLA</td> <td>1.000</td> <td>PZ</td> </tr> <tr> <td>VI1280A3</td> <td>VITE M5X10 TC1/2T COMBI ZN-NI</td> <td>3.000</td> <td>PZ</td> </tr> </tbody> </table>	Code	Description	Qty	UOM	CR1114A0	CERNIERA PORTA RIBALTA SP ROSSELLA	1.000	PZ	VI1280A3	VITE M5X10 TC1/2T COMBI ZN-NI	3.000	PZ				
Code	Description	Qty	UOM																		
CR1114A0	CERNIERA PORTA RIBALTA SP ROSSELLA	1.000	PZ																		
VI1280A3	VITE M5X10 TC1/2T COMBI ZN-NI	3.000	PZ																		
PE2107A	CONTROLLO COMPLETO SP Led		KPE2107A	BAKERLUX SP LED CONTROL BOARD KIT	<table border="1"> <thead> <tr> <th>Code</th> <th>Description</th> <th>Qty</th> <th>UOM</th> </tr> </thead> <tbody> <tr> <td>PE2107A2</td> <td>CONTROLLO COMPLETO SP Led</td> <td>1.000</td> <td>PZ</td> </tr> <tr> <td>VI1147A0</td> <td>VITE 5X25 TRUCIOLARE INOX</td> <td>2.000</td> <td>PZ</td> </tr> <tr> <td>VM1447A0</td> <td>BUSTA AIRBALL ESD ROSA 230X450 MM</td> <td>1.000</td> <td>PZ</td> </tr> </tbody> </table>	Code	Description	Qty	UOM	PE2107A2	CONTROLLO COMPLETO SP Led	1.000	PZ	VI1147A0	VITE 5X25 TRUCIOLARE INOX	2.000	PZ	VM1447A0	BUSTA AIRBALL ESD ROSA 230X450 MM	1.000	PZ
Code	Description	Qty	UOM																		
PE2107A2	CONTROLLO COMPLETO SP Led	1.000	PZ																		
VI1147A0	VITE 5X25 TRUCIOLARE INOX	2.000	PZ																		
VM1447A0	BUSTA AIRBALL ESD ROSA 230X450 MM	1.000	PZ																		
VI1174A	VITE 5X20 PER PLASTICA ZN-NI		VI1174A0	VITE 5X20 PER PLASTICA ZN-NI																	

COMPONENT			SPARE PART																																																																							
Code	Description	Image	Code	Description	Kit components																																																																					
VT1221A	VETRO EST NERO SER ROSSELLA SP 557x439x4		KDR1491A	ROSSELLA BLSP EXT LEFT DOOR KIT	<table border="1"> <thead> <tr> <th>Code</th> <th>Description</th> <th>Qty</th> <th>UOM</th> </tr> </thead> <tbody> <tr> <td>ML1005A0</td> <td>MOLLA A COMPRESSIO NE DE5 DF0.6 H18</td> <td>2.000</td> <td>PZ</td> </tr> <tr> <td>SL1186A2</td> <td>SILICONE BICOMP. VETRO EXT ARI-ROS SP</td> <td>2.000</td> <td>PZ</td> </tr> <tr> <td>TB1563A0</td> <td>TUBO TRAVERSO PORTA SP800</td> <td>2.000</td> <td>PZ</td> </tr> <tr> <td>TB1722A1</td> <td>TUBO RINVIO ARI-ROS COMPLETO LANCIO SP</td> <td>1.000</td> <td>PZ</td> </tr> <tr> <td>TB3304A0</td> <td>TUBO MANIGLIA BANDIERA ARI-ROS SP</td> <td>1.000</td> <td>PZ</td> </tr> <tr> <td>VI1036A0</td> <td>INSERTO FILETTATO M10 FTT/C INOX RIGATO</td> <td>1.000</td> <td>PZ</td> </tr> <tr> <td>VI1174A0</td> <td>VITE 5X20 PER PLASTICA ZN-NI</td> <td>10.000</td> <td>PZ</td> </tr> <tr> <td>VI1220A1</td> <td>VITE AUTOFIL. 4.2X11 TCS+ MARUTEX</td> <td>14.000</td> <td>PZ</td> </tr> <tr> <td>VI1930A1</td> <td>VITE 5X20 TRUCIOLARE INOX</td> <td>10.000</td> <td>PZ</td> </tr> <tr> <td>VI1998A0</td> <td>VITE TRUCIOLARE 5X30 TCB ZINCATA</td> <td>2.000</td> <td>PZ</td> </tr> <tr> <td>VM1209A0</td> <td>BOCCOLA PERNO ELETTROSER RATURA SP</td> <td>1.000</td> <td>PZ</td> </tr> <tr> <td>VM1630A1</td> <td>TAPPO PREMI VETRO INTERNO</td> <td>4.000</td> <td>PZ</td> </tr> <tr> <td>VM2274A0</td> <td>BOCCOLA SCANALATA CORTA</td> <td>1.000</td> <td>PZ</td> </tr> <tr> <td>VM2275A0</td> <td>BOCCOLA LISCIA CORTA</td> <td>1.000</td> <td>PZ</td> </tr> <tr> <td>VM2456A0</td> <td>TERMINALE MANIGLIA BL SP</td> <td>2.000</td> <td>PZ</td> </tr> <tr> <td>VM2465A0</td> <td>TAPPO INFERIORE DX PORTA BANDIERA SP</td> <td>1.000</td> <td>PZ</td> </tr> </tbody> </table>		Code	Description	Qty	UOM	ML1005A0	MOLLA A COMPRESSIO NE DE5 DF0.6 H18	2.000	PZ	SL1186A2	SILICONE BICOMP. VETRO EXT ARI-ROS SP	2.000	PZ	TB1563A0	TUBO TRAVERSO PORTA SP800	2.000	PZ	TB1722A1	TUBO RINVIO ARI-ROS COMPLETO LANCIO SP	1.000	PZ	TB3304A0	TUBO MANIGLIA BANDIERA ARI-ROS SP	1.000	PZ	VI1036A0	INSERTO FILETTATO M10 FTT/C INOX RIGATO	1.000	PZ	VI1174A0	VITE 5X20 PER PLASTICA ZN-NI	10.000	PZ	VI1220A1	VITE AUTOFIL. 4.2X11 TCS+ MARUTEX	14.000	PZ	VI1930A1	VITE 5X20 TRUCIOLARE INOX	10.000	PZ	VI1998A0	VITE TRUCIOLARE 5X30 TCB ZINCATA	2.000	PZ	VM1209A0	BOCCOLA PERNO ELETTROSER RATURA SP	1.000	PZ	VM1630A1	TAPPO PREMI VETRO INTERNO	4.000	PZ	VM2274A0	BOCCOLA SCANALATA CORTA	1.000	PZ	VM2275A0	BOCCOLA LISCIA CORTA	1.000	PZ	VM2456A0	TERMINALE MANIGLIA BL SP	2.000	PZ	VM2465A0	TAPPO INFERIORE DX PORTA BANDIERA SP	1.000	PZ
Code	Description	Qty	UOM																																																																							
ML1005A0	MOLLA A COMPRESSIO NE DE5 DF0.6 H18	2.000	PZ																																																																							
SL1186A2	SILICONE BICOMP. VETRO EXT ARI-ROS SP	2.000	PZ																																																																							
TB1563A0	TUBO TRAVERSO PORTA SP800	2.000	PZ																																																																							
TB1722A1	TUBO RINVIO ARI-ROS COMPLETO LANCIO SP	1.000	PZ																																																																							
TB3304A0	TUBO MANIGLIA BANDIERA ARI-ROS SP	1.000	PZ																																																																							
VI1036A0	INSERTO FILETTATO M10 FTT/C INOX RIGATO	1.000	PZ																																																																							
VI1174A0	VITE 5X20 PER PLASTICA ZN-NI	10.000	PZ																																																																							
VI1220A1	VITE AUTOFIL. 4.2X11 TCS+ MARUTEX	14.000	PZ																																																																							
VI1930A1	VITE 5X20 TRUCIOLARE INOX	10.000	PZ																																																																							
VI1998A0	VITE TRUCIOLARE 5X30 TCB ZINCATA	2.000	PZ																																																																							
VM1209A0	BOCCOLA PERNO ELETTROSER RATURA SP	1.000	PZ																																																																							
VM1630A1	TAPPO PREMI VETRO INTERNO	4.000	PZ																																																																							
VM2274A0	BOCCOLA SCANALATA CORTA	1.000	PZ																																																																							
VM2275A0	BOCCOLA LISCIA CORTA	1.000	PZ																																																																							
VM2456A0	TERMINALE MANIGLIA BL SP	2.000	PZ																																																																							
VM2465A0	TAPPO INFERIORE DX PORTA BANDIERA SP	1.000	PZ																																																																							



COMPONENT			SPARE PART																																																																			
Code	Description	Image	Code	Description	Kit components																																																																	
VT1221A	VETRO EST NERO SER ROSSELLA SP 557x439x4		KDR1491A	ROSSELLA BLSP EXT LEFT DOOR KIT	<table border="1"> <thead> <tr> <th>Code</th> <th>Description</th> <th>Qty</th> <th>UOM</th> </tr> </thead> <tbody> <tr> <td>VM2466A0</td> <td>TAPPO INFERIORE SX PORTA BANDIERA SP</td> <td>1.000</td> <td>PZ</td> </tr> <tr> <td>VM2467A0</td> <td>TAPPO SUPERIORE DX PORTA BANDIERA SP</td> <td>1.000</td> <td>PZ</td> </tr> <tr> <td>VM2468A0</td> <td>TAPPO SUPERIORE SX PORTA BANDIERA SP</td> <td>1.000</td> <td>PZ</td> </tr> <tr> <td>VM2470A0</td> <td>CORSOIO BLOCCA VETRO INTERNO SHOP.PRO</td> <td>2.000</td> <td>PZ</td> </tr> <tr> <td>VM2471A0</td> <td>SEDE INF CORSOIO BLOCCA VETRO INTERNO SP</td> <td>1.000</td> <td>PZ</td> </tr> <tr> <td>VM2472A0</td> <td>SEDE SUP CORSOIO BLOCCA VETRO INTERNO SP</td> <td>1.000</td> <td>PZ</td> </tr> <tr> <td>VM2473A0</td> <td>BLOCCA PERNO INF CERNIERA VETRO INT SP</td> <td>1.000</td> <td>PZ</td> </tr> <tr> <td>VM2474A0</td> <td>BLOCCA PERNO SUP CERNIERA VETRO INT SP</td> <td>1.000</td> <td>PZ</td> </tr> <tr> <td>VM2479A0</td> <td>SPINGIVETRO VETRO H6 BL SP</td> <td>4.000</td> <td>PZ</td> </tr> <tr> <td>VM2504A0</td> <td>PIOLINO GUIDA MOLLA CORSOIO SHOP.PRO</td> <td>2.000</td> <td>PZ</td> </tr> <tr> <td>VM2548A1</td> <td>GUIDA TUBO INTERNO PORTA LANCIO SP</td> <td>1.000</td> <td>PZ</td> </tr> <tr> <td>VT1221A0</td> <td>VETRO EST NERO SER ROSSELLA SP 557x439x4</td> <td></td> <td></td> <td>1.000</td> <td>PZ</td> </tr> </tbody> </table>	Code	Description	Qty	UOM	VM2466A0	TAPPO INFERIORE SX PORTA BANDIERA SP	1.000	PZ	VM2467A0	TAPPO SUPERIORE DX PORTA BANDIERA SP	1.000	PZ	VM2468A0	TAPPO SUPERIORE SX PORTA BANDIERA SP	1.000	PZ	VM2470A0	CORSOIO BLOCCA VETRO INTERNO SHOP.PRO	2.000	PZ	VM2471A0	SEDE INF CORSOIO BLOCCA VETRO INTERNO SP	1.000	PZ	VM2472A0	SEDE SUP CORSOIO BLOCCA VETRO INTERNO SP	1.000	PZ	VM2473A0	BLOCCA PERNO INF CERNIERA VETRO INT SP	1.000	PZ	VM2474A0	BLOCCA PERNO SUP CERNIERA VETRO INT SP	1.000	PZ	VM2479A0	SPINGIVETRO VETRO H6 BL SP	4.000	PZ	VM2504A0	PIOLINO GUIDA MOLLA CORSOIO SHOP.PRO	2.000	PZ	VM2548A1	GUIDA TUBO INTERNO PORTA LANCIO SP	1.000	PZ	VT1221A0	VETRO EST NERO SER ROSSELLA SP 557x439x4			1.000	PZ	KDR1490A	ROSSELLA BLSP EXT RIGHT DOOR KI	<table border="1"> <thead> <tr> <th>Code</th> <th>Description</th> <th>Qty</th> <th>UOM</th> </tr> </thead> <tbody> <tr> <td>0B1297A0</td> <td>COLONNINA EST SX RIGHT ARI-ROS SP</td> <td>1.000</td> <td>PZ</td> </tr> </tbody> </table>	Code	Description	Qty	UOM	0B1297A0	COLONNINA EST SX RIGHT ARI-ROS SP	1.000	PZ
			Code	Description	Qty	UOM																																																																
VM2466A0	TAPPO INFERIORE SX PORTA BANDIERA SP	1.000	PZ																																																																			
VM2467A0	TAPPO SUPERIORE DX PORTA BANDIERA SP	1.000	PZ																																																																			
VM2468A0	TAPPO SUPERIORE SX PORTA BANDIERA SP	1.000	PZ																																																																			
VM2470A0	CORSOIO BLOCCA VETRO INTERNO SHOP.PRO	2.000	PZ																																																																			
VM2471A0	SEDE INF CORSOIO BLOCCA VETRO INTERNO SP	1.000	PZ																																																																			
VM2472A0	SEDE SUP CORSOIO BLOCCA VETRO INTERNO SP	1.000	PZ																																																																			
VM2473A0	BLOCCA PERNO INF CERNIERA VETRO INT SP	1.000	PZ																																																																			
VM2474A0	BLOCCA PERNO SUP CERNIERA VETRO INT SP	1.000	PZ																																																																			
VM2479A0	SPINGIVETRO VETRO H6 BL SP	4.000	PZ																																																																			
VM2504A0	PIOLINO GUIDA MOLLA CORSOIO SHOP.PRO	2.000	PZ																																																																			
VM2548A1	GUIDA TUBO INTERNO PORTA LANCIO SP	1.000	PZ																																																																			
VT1221A0	VETRO EST NERO SER ROSSELLA SP 557x439x4			1.000	PZ																																																																	
Code	Description	Qty	UOM																																																																			
0B1297A0	COLONNINA EST SX RIGHT ARI-ROS SP	1.000	PZ																																																																			

COMPONENT			SPARE PART			
Code	Description	Image	Code	Description	Kit components	
VT1221A	VETRO EST NERO SER ROSSELLA SP 557x439x4		KDR1490A	ROSSELLA BLSP EXT RIGHT DOOR KI	Code	Description Qty UOM
					0B1298A0	COLONNINA 1.000 PZ INT SX RIGHT ARI-ROS SP
					0B1299B0	COLONNINA 1.000 PZ EST DX RIGHT ARI-ROS SP
					0B1300A0	COLONNINA 1.000 PZ INT DX RIGHT ARI-ROS SP
					0H10283A0	DIMA 1.000 PZ REGOLAZION E PERNO SHOPPRO
					CR1040A0	PERNO 1.000 PZ CHIUSURA ELETTROMEC C. L.M. MATIC
					ML1005A0	MOLLA A 2.000 PZ COMPRESSIO NE DE5 DF0.6 H18
					SL1186A2	SILICONE 2.000 PZ BICOMP. VETRO EXT ARI-ROS SP
					TB1563A0	TUBO 2.000 PZ TRAVERSO PORTA SP800
					TB1722A1	TUBO RINVIO 1.000 PZ ARI-ROS COMPLETO LANCIO SP
					TB3304A0	TUBO 1.000 PZ MANIGLIA BANDIERA ARI-ROS SP
					VI1036A0	INSERTO 1.000 PZ FILETTATO M10 FTT/C INOX RIGATO
					VH1174A0	VITE 5X20 PER 10.000 PZ PLASTICA ZN-NI
					VH1220A1	VITE AUTOFIL. 14.000 PZ 4.2X11 TCS+ MARUTEX
					VI1930A1	VITE 5X20 10.000 PZ TRUCIOLARE INOX
					VI1998A0	VITE 2.000 PZ TRUCIOLARE 5X30 TCB ZINCATA

COMPONENT			SPARE PART					
Code	Description	Image	Code	Description	Kit components			
VT1221A	VETRO EST NERO SER ROSSELLA SP 557x439x4		KDR1490A	ROSSELLA BLSP EXT RIGHT DOOR KI	Code	Description	Qty	UOM
					VM1209A0	BOCCOLA PERNO ELETTROSER RATURA SP	1.000	PZ
					VM1630A1	TAPPO PREMI VETRO INTERNO	4.000	PZ
					VM2274A0	BOCCOLA SCANALATA CORTA	1.000	PZ
					VM2275A0	BOCCOLA LISCIA CORTA	1.000	PZ
					VM2456A0	TERMINALE MANIGLIA BL SP	2.000	PZ
					VM2465A0	TAPPO INFERIORE DX PORTA BANDIERA SP	1.000	PZ
					VM2466A0	TAPPO INFERIORE SX PORTA BANDIERA SP	1.000	PZ
					VM2467A0	TAPPO SUPERIORE DX PORTA BANDIERA SP	1.000	PZ
					VM2468A0	TAPPO SUPERIORE SX PORTA BANDIERA SP	1.000	PZ
					VM2470A0	CORSOIO BLOCCA VETRO INTERNO SHOP.PRO	2.000	PZ
					VM2471A0	SEDE INF CORSOIO BLOCCA VETRO INTERNO SP	1.000	PZ
					VM2472A0	SEDE SUP CORSOIO BLOCCA VETRO INTERNO SP	1.000	PZ
					VM2473A0	BLOCCA PERNO INF CERNIERA VETRO INT SP	1.000	PZ
					VM2474A0	BLOCCA PERNO SUP CERNIERA VETRO INT SP	1.000	PZ

COMPONENT			SPARE PART																																											
Code	Description	Image	Code	Description	Kit components																																									
VT1221A	VETRO EST NERO SER ROSSELLA SP 557x439x4		KDR1490A	ROSSELLA BLSP EXT RIGHT DOOR KI	<table border="1"> <thead> <tr> <th>Code</th> <th>Description</th> <th>Qty</th> <th>UOM</th> </tr> </thead> <tbody> <tr> <td>VM2479A0</td> <td>SPINGIVETRO VETRO H6 BL SP</td> <td>4.000</td> <td>PZ</td> </tr> <tr> <td>VM2504A0</td> <td>PIOLINO GUIDA MOLLA CORSOIO SHOP.PRO</td> <td>2.000</td> <td>PZ</td> </tr> <tr> <td>VM2548A1</td> <td>GUIDA TUBO INTERNO PORTA LANCIO SP</td> <td>1.000</td> <td>PZ</td> </tr> <tr> <td>VT1221A0</td> <td>VETRO EST NERO SER ROSSELLA SP 557x439x4</td> <td>1.000</td> <td>PZ</td> </tr> </tbody> </table>	Code	Description	Qty	UOM	VM2479A0	SPINGIVETRO VETRO H6 BL SP	4.000	PZ	VM2504A0	PIOLINO GUIDA MOLLA CORSOIO SHOP.PRO	2.000	PZ	VM2548A1	GUIDA TUBO INTERNO PORTA LANCIO SP	1.000	PZ	VT1221A0	VETRO EST NERO SER ROSSELLA SP 557x439x4	1.000	PZ																					
			Code	Description	Qty	UOM																																								
VM2479A0	SPINGIVETRO VETRO H6 BL SP	4.000	PZ																																											
VM2504A0	PIOLINO GUIDA MOLLA CORSOIO SHOP.PRO	2.000	PZ																																											
VM2548A1	GUIDA TUBO INTERNO PORTA LANCIO SP	1.000	PZ																																											
VT1221A0	VETRO EST NERO SER ROSSELLA SP 557x439x4	1.000	PZ																																											
KDR1483A	ROSSELLA BLSP COMPL DROP DOWN DOOR KIT	<table border="1"> <thead> <tr> <th>Code</th> <th>Description</th> <th>Qty</th> <th>UOM</th> </tr> </thead> <tbody> <tr> <td>0B1289A0</td> <td>COLONNINA EST SX RIBALTA ARI-ROS SP</td> <td>1.000</td> <td>PZ</td> </tr> <tr> <td>0B1290A0</td> <td>COLONNINA INT SX RIBALTA ARI-ROS SP</td> <td>1.000</td> <td>PZ</td> </tr> <tr> <td>0B1291A0</td> <td>COLONNINA EST DX RIBALTA ARI-ROS SP</td> <td>1.000</td> <td>PZ</td> </tr> <tr> <td>0B1292A0</td> <td>COLONNINA INT DX RIBALTA ARI-ROS SP</td> <td>1.000</td> <td>PZ</td> </tr> <tr> <td>CR1114A0</td> <td>CERNIERA PORTA RIBALTA SP ROSSELLA</td> <td>2.000</td> <td>PZ</td> </tr> <tr> <td>LP1050A0</td> <td>BARRA ILLUMINAZION E LED L180 SP COMPLETA</td> <td>1.000</td> <td>PZ</td> </tr> <tr> <td>SL1186A1</td> <td>SILICONE VETRO EXT ARI-ROS SP</td> <td>2.000</td> <td>PZ</td> </tr> <tr> <td>TB1563A0</td> <td>TUBO TRAVERSO PORTA SP800</td> <td>1.000</td> <td>PZ</td> </tr> <tr> <td>TB3302A0</td> <td>TUBO MANIGLIA RIBALTA SP80</td> <td>1.000</td> <td>PZ</td> </tr> <tr> <td>TB3342A0</td> <td>TUBO MANIGLIA RIBALTA SP800 NEUTR</td> <td>1.000</td> <td>PZ</td> </tr> </tbody> </table>	Code	Description	Qty	UOM	0B1289A0	COLONNINA EST SX RIBALTA ARI-ROS SP	1.000	PZ	0B1290A0	COLONNINA INT SX RIBALTA ARI-ROS SP	1.000	PZ	0B1291A0	COLONNINA EST DX RIBALTA ARI-ROS SP	1.000	PZ	0B1292A0	COLONNINA INT DX RIBALTA ARI-ROS SP	1.000	PZ	CR1114A0	CERNIERA PORTA RIBALTA SP ROSSELLA	2.000	PZ	LP1050A0	BARRA ILLUMINAZION E LED L180 SP COMPLETA	1.000	PZ	SL1186A1	SILICONE VETRO EXT ARI-ROS SP	2.000	PZ	TB1563A0	TUBO TRAVERSO PORTA SP800	1.000	PZ	TB3302A0	TUBO MANIGLIA RIBALTA SP80	1.000	PZ	TB3342A0	TUBO MANIGLIA RIBALTA SP800 NEUTR	1.000	PZ
Code	Description	Qty	UOM																																											
0B1289A0	COLONNINA EST SX RIBALTA ARI-ROS SP	1.000	PZ																																											
0B1290A0	COLONNINA INT SX RIBALTA ARI-ROS SP	1.000	PZ																																											
0B1291A0	COLONNINA EST DX RIBALTA ARI-ROS SP	1.000	PZ																																											
0B1292A0	COLONNINA INT DX RIBALTA ARI-ROS SP	1.000	PZ																																											
CR1114A0	CERNIERA PORTA RIBALTA SP ROSSELLA	2.000	PZ																																											
LP1050A0	BARRA ILLUMINAZION E LED L180 SP COMPLETA	1.000	PZ																																											
SL1186A1	SILICONE VETRO EXT ARI-ROS SP	2.000	PZ																																											
TB1563A0	TUBO TRAVERSO PORTA SP800	1.000	PZ																																											
TB3302A0	TUBO MANIGLIA RIBALTA SP80	1.000	PZ																																											
TB3342A0	TUBO MANIGLIA RIBALTA SP800 NEUTR	1.000	PZ																																											

COMPONENT			SPARE PART																																																																			
Code	Description	Image	Code	Description	Kit components																																																																	
VT1221A	VETRO EST NERO SER ROSSELLA SP 557x439x4		KDR1483A	ROSSELLA BLSP COMPL DROP DOWN DOOR KIT	<table border="1"> <thead> <tr> <th>Code</th> <th>Description</th> <th>Qty</th> <th>UOM</th> </tr> </thead> <tbody> <tr> <td>TB3370A0</td> <td>TUBO MANIGLIA RIBALTA DECK SP</td> <td>1.000</td> <td>PZ</td> </tr> <tr> <td>VI1014A0</td> <td>RONDELLA PIANA 4.5X9X0.8 INO</td> <td>1.000</td> <td>PZ</td> </tr> <tr> <td>VI1174A0</td> <td>VITE 5X20 PER PLASTICA ZN-NI</td> <td>4.000</td> <td>PZ</td> </tr> <tr> <td>VI1220A1</td> <td>VITE AUTOFIL. 4.2X11 TCS+ MARUTEX</td> <td>13.000</td> <td>PZ</td> </tr> <tr> <td>VI1280A3</td> <td>VITE M5X10 TC1/2T COMBI ZN-NI</td> <td>6.000</td> <td>PZ</td> </tr> <tr> <td>VI1930A1</td> <td>VITE 5X20 TRUCIOLARE INOX</td> <td>8.000</td> <td>PZ</td> </tr> <tr> <td>VI1998A0</td> <td>VITE TRUCIOLARE 5X30 TCB ZINCATA</td> <td>2.000</td> <td>PZ</td> </tr> <tr> <td>VM1630A1</td> <td>TAPPO PREMI VETRO INTERNO</td> <td>4.000</td> <td>PZ</td> </tr> <tr> <td>VM2456A0</td> <td>TERMINALE MANIGLIA BL SP</td> <td>2.000</td> <td>PZ</td> </tr> <tr> <td>VM2461A0</td> <td>TAPPO INFERIORE DX PORTA RIBALTA SP</td> <td>1.000</td> <td>PZ</td> </tr> <tr> <td>VM2462A0</td> <td>TAPPO INFERIORE SX PORTA RIBALTA SP</td> <td>1.000</td> <td>PZ</td> </tr> <tr> <td>VM2463A0</td> <td>TAPPO SUPERIORE DX PORTA RIBALTA SP</td> <td>1.000</td> <td>PZ</td> </tr> <tr> <td>VM2464A0</td> <td>TAPPO SUPERIORE SX PORTA RIBALTA SP</td> <td>1.000</td> <td>PZ</td> </tr> <tr> <td>VM2471A0</td> <td>SEDE INF CORSOIO BLOCCA VETRO INTERNO SP</td> <td>1.000</td> <td>PZ</td> </tr> <tr> <td>VM2472A0</td> <td>SEDE SUP CORSOIO BLOCCA VETRO INTERNO SP</td> <td>1.000</td> <td>PZ</td> </tr> </tbody> </table>	Code	Description	Qty	UOM	TB3370A0	TUBO MANIGLIA RIBALTA DECK SP	1.000	PZ	VI1014A0	RONDELLA PIANA 4.5X9X0.8 INO	1.000	PZ	VI1174A0	VITE 5X20 PER PLASTICA ZN-NI	4.000	PZ	VI1220A1	VITE AUTOFIL. 4.2X11 TCS+ MARUTEX	13.000	PZ	VI1280A3	VITE M5X10 TC1/2T COMBI ZN-NI	6.000	PZ	VI1930A1	VITE 5X20 TRUCIOLARE INOX	8.000	PZ	VI1998A0	VITE TRUCIOLARE 5X30 TCB ZINCATA	2.000	PZ	VM1630A1	TAPPO PREMI VETRO INTERNO	4.000	PZ	VM2456A0	TERMINALE MANIGLIA BL SP	2.000	PZ	VM2461A0	TAPPO INFERIORE DX PORTA RIBALTA SP	1.000	PZ	VM2462A0	TAPPO INFERIORE SX PORTA RIBALTA SP	1.000	PZ	VM2463A0	TAPPO SUPERIORE DX PORTA RIBALTA SP	1.000	PZ	VM2464A0	TAPPO SUPERIORE SX PORTA RIBALTA SP	1.000	PZ	VM2471A0	SEDE INF CORSOIO BLOCCA VETRO INTERNO SP	1.000	PZ	VM2472A0	SEDE SUP CORSOIO BLOCCA VETRO INTERNO SP	1.000	PZ	
Code	Description	Qty	UOM																																																																			
TB3370A0	TUBO MANIGLIA RIBALTA DECK SP	1.000	PZ																																																																			
VI1014A0	RONDELLA PIANA 4.5X9X0.8 INO	1.000	PZ																																																																			
VI1174A0	VITE 5X20 PER PLASTICA ZN-NI	4.000	PZ																																																																			
VI1220A1	VITE AUTOFIL. 4.2X11 TCS+ MARUTEX	13.000	PZ																																																																			
VI1280A3	VITE M5X10 TC1/2T COMBI ZN-NI	6.000	PZ																																																																			
VI1930A1	VITE 5X20 TRUCIOLARE INOX	8.000	PZ																																																																			
VI1998A0	VITE TRUCIOLARE 5X30 TCB ZINCATA	2.000	PZ																																																																			
VM1630A1	TAPPO PREMI VETRO INTERNO	4.000	PZ																																																																			
VM2456A0	TERMINALE MANIGLIA BL SP	2.000	PZ																																																																			
VM2461A0	TAPPO INFERIORE DX PORTA RIBALTA SP	1.000	PZ																																																																			
VM2462A0	TAPPO INFERIORE SX PORTA RIBALTA SP	1.000	PZ																																																																			
VM2463A0	TAPPO SUPERIORE DX PORTA RIBALTA SP	1.000	PZ																																																																			
VM2464A0	TAPPO SUPERIORE SX PORTA RIBALTA SP	1.000	PZ																																																																			
VM2471A0	SEDE INF CORSOIO BLOCCA VETRO INTERNO SP	1.000	PZ																																																																			
VM2472A0	SEDE SUP CORSOIO BLOCCA VETRO INTERNO SP	1.000	PZ																																																																			

COMPONENT			SPARE PART					
Code	Description	Image	Code	Description	Kit components			
VT1221A	VETRO EST NERO SER ROSSELLA SP 557x439x4		KDR1483A	ROSSELLA BLSP COMPL DROP DOWN DOOR KIT	Code	Description	Qty	UOM
					VM2479A0	SPINGIVETRO VETRO H6 BL SP	4.000	PZ
					VM2503A0	CORSOIO BLOCCA VETRO INTERNO FISSO SP	2.000	PZ
					VM2512A0	BATTUTA SOFT MICRO PORTA BAKERLUX SP	1.000	PZ
					VT1221A0	VETRO EST NERO SER ROSSELLA SP 557x439x4	1.000	PZ
VT1332A	VETRO INT ROSSELLA SP 715x393.5x6		KVT1332A	BL SP ROSSELLA INTERNAL GLASS KI	Code	Description	Qty	UOM
					VT1332A0	VETRO INT ROSSELLA SP 715x393.5x6	1.000	PZ

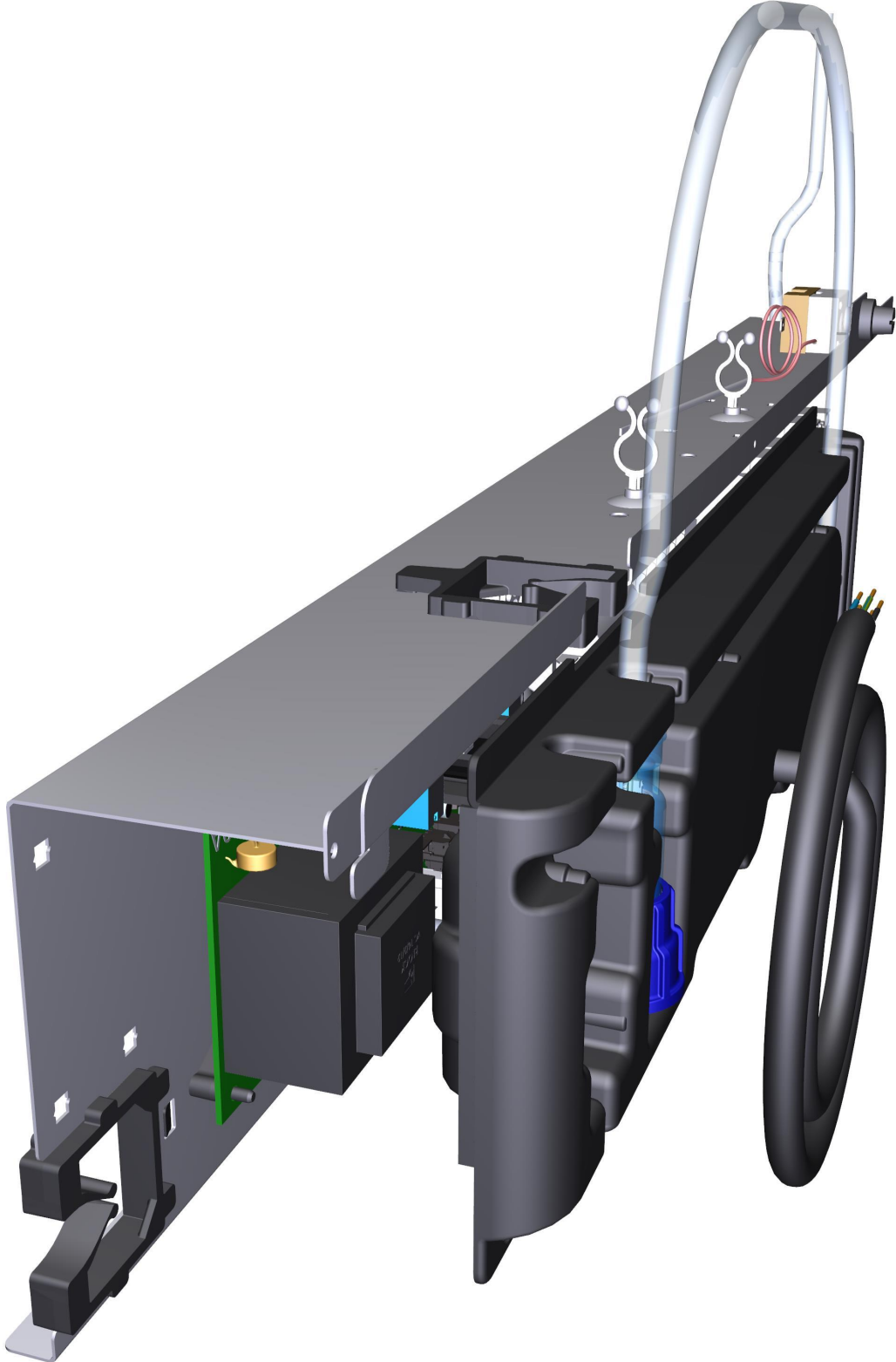

ASM8226A/0.D00 - Electrical system - FRONT



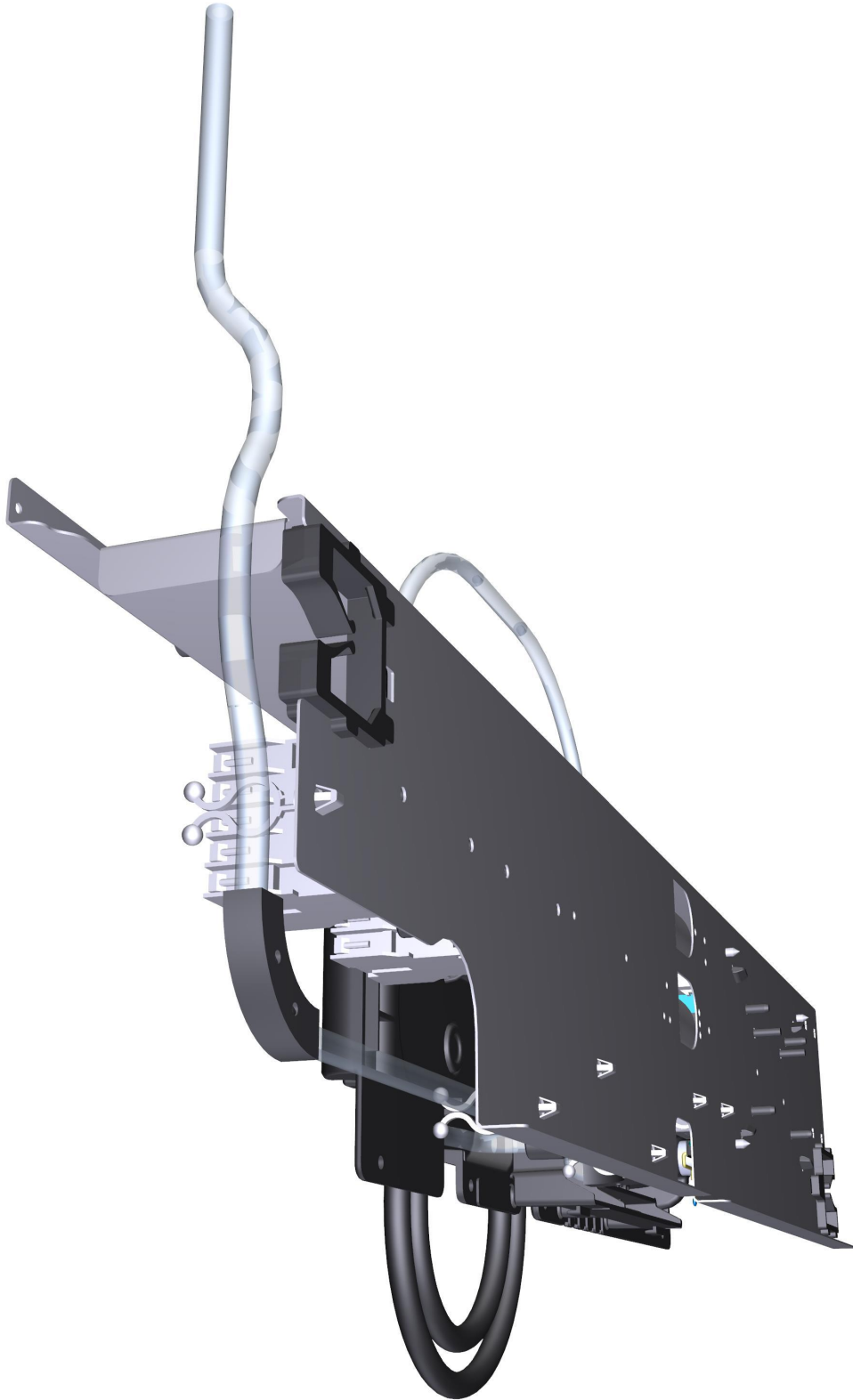

ASM8226A/0.D00 - Electrical system - REAR

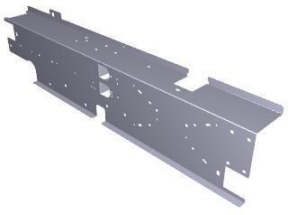
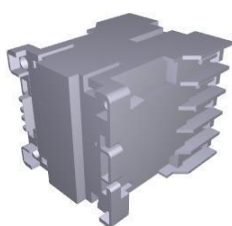



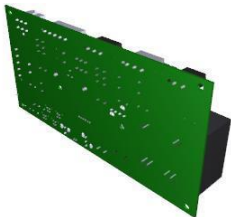

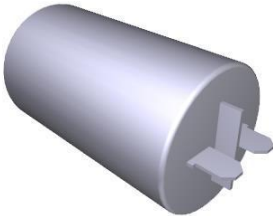
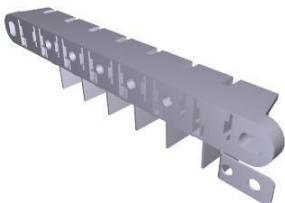

COMPONENT			SPARE PART																		
Code	Description	Image	Code	Description	Kit components																
0P1032A	SP ELE-ROS EL COMPONENTS HOLDER		0P1032A0	SP ELE-ROS EL COMPONENTS HOLDER																	
VE1115A	MINICONTATTORE QUADRIPOLE 20 A 230V		KVE1115A	20A 230V 4 POLES MINICONTACTOR KI	<table border="1"> <thead> <tr> <th>Code</th> <th>Description</th> <th>Qty</th> <th>UOM</th> </tr> </thead> <tbody> <tr> <td>VE1115A0</td> <td>MINICONTATT ORE QUADRIPOLA RE 20 A 230V</td> <td>1.000</td> <td>PZ</td> </tr> <tr> <td>VM1075A1</td> <td>CLIP DI FISSAGGIO PER TELERUTTORI</td> <td>4.000</td> <td>PZ</td> </tr> </tbody> </table>	Code	Description	Qty	UOM	VE1115A0	MINICONTATT ORE QUADRIPOLA RE 20 A 230V	1.000	PZ	VM1075A1	CLIP DI FISSAGGIO PER TELERUTTORI	4.000	PZ				
Code	Description	Qty	UOM																		
VE1115A0	MINICONTATT ORE QUADRIPOLA RE 20 A 230V	1.000	PZ																		
VM1075A1	CLIP DI FISSAGGIO PER TELERUTTORI	4.000	PZ																		
VM1056A	SMALL CONTACTOR BRACKET VE1115A		VM1056A0	SMALL CONTACTOR BRACKET VE1115A																	
VL1145A	RACCORDO 3/4-JG8 CON FILTRO E VNR		KVL1145A	3/4-JG8 FITTING WITH FILTER AND NRV KIT	<table border="1"> <thead> <tr> <th>Code</th> <th>Description</th> <th>Qty</th> <th>UOM</th> </tr> </thead> <tbody> <tr> <td>VL1145A1</td> <td>RACCORDO 3/4-JG8 CON FILTRO E VNR</td> <td>1.000</td> <td>PZ</td> </tr> </tbody> </table>	Code	Description	Qty	UOM	VL1145A1	RACCORDO 3/4-JG8 CON FILTRO E VNR	1.000	PZ								
Code	Description	Qty	UOM																		
VL1145A1	RACCORDO 3/4-JG8 CON FILTRO E VNR	1.000	PZ																		
PE2260A	BL SHOP.PRO 230V POWER BOARD		KPE2260A	BL SHOP.PRO 230V POWER CARD KIT	<table border="1"> <thead> <tr> <th>Code</th> <th>Description</th> <th>Qty</th> <th>UOM</th> </tr> </thead> <tbody> <tr> <td>PE2260A2</td> <td>SCHEDA POTENZA BL SHOP.PRO 230V</td> <td>1.000</td> <td>PZ</td> </tr> <tr> <td>VI1988A0</td> <td>VITE AUTOFIL. 4.2X19 TCB+ INOX</td> <td>3.000</td> <td>PZ</td> </tr> <tr> <td>VM1187A0</td> <td>TELAIO SCHEDA POTENZA SHOP.PRO</td> <td>1.000</td> <td>PZ</td> </tr> </tbody> </table>	Code	Description	Qty	UOM	PE2260A2	SCHEDA POTENZA BL SHOP.PRO 230V	1.000	PZ	VI1988A0	VITE AUTOFIL. 4.2X19 TCB+ INOX	3.000	PZ	VM1187A0	TELAIO SCHEDA POTENZA SHOP.PRO	1.000	PZ
Code	Description	Qty	UOM																		
PE2260A2	SCHEDA POTENZA BL SHOP.PRO 230V	1.000	PZ																		
VI1988A0	VITE AUTOFIL. 4.2X19 TCB+ INOX	3.000	PZ																		
VM1187A0	TELAIO SCHEDA POTENZA SHOP.PRO	1.000	PZ																		

COMPONENT			SPARE PART																		
Code	Description	Image	Code	Description	Kit components																
PE2260A	BL SHOP.PRO 230V POWER BOARD		KPE2260A	BL SHOP.PRO 230V POWER CARD KIT	<table border="1"> <thead> <tr> <th>Code</th> <th>Description</th> <th>Qty</th> <th>UOM</th> </tr> </thead> <tbody> <tr> <td>VM1447A0</td> <td>BUSTA AIRBALL ESD ROSA 230X450 MM</td> <td>1.000</td> <td>PZ</td> </tr> <tr> <td>VM1748A0</td> <td>CLIP FISSAGGIO SCHEDA H10 INCASTRO-IN CAS</td> <td>6.000</td> <td>PZ</td> </tr> </tbody> </table>	Code	Description	Qty	UOM	VM1447A0	BUSTA AIRBALL ESD ROSA 230X450 MM	1.000	PZ	VM1748A0	CLIP FISSAGGIO SCHEDA H10 INCASTRO-IN CAS	6.000	PZ				
Code	Description	Qty	UOM																		
VM1447A0	BUSTA AIRBALL ESD ROSA 230X450 MM	1.000	PZ																		
VM1748A0	CLIP FISSAGGIO SCHEDA H10 INCASTRO-IN CAS	6.000	PZ																		
VM1187A	TELAIO SCHEDA POTENZA SHOP.PR		VM1187A0	TELAIO SCHEDA POTENZA SHOP.PR																	
CE1356A	5X1.5 MMQ L1.5 MT POWER SUPPLY WIRE		CE1356A0	5X1.5 MMQ L1.5 MT POWER SUPPLY WIRE																	
CN1003A	CONDENSATORE CORAZZATO 6,3 uF		KCN1003A	6,3 uF MOTOR CAPACITOR KIT	<table border="1"> <thead> <tr> <th>Code</th> <th>Description</th> <th>Qty</th> <th>UOM</th> </tr> </thead> <tbody> <tr> <td>CN1003A0</td> <td>CONDENSATO RE CORAZZATO 6,3 uF</td> <td>1.000</td> <td>PZ</td> </tr> <tr> <td>VI1931A0</td> <td>DADO CONDENSATO RE M8x1.65 H4 CH13 ZINC</td> <td>1.000</td> <td>PZ</td> </tr> <tr> <td>VI1932A0</td> <td>RONDELLA DENTELLATA CONDENSATO RE D8 ZINC</td> <td>1.000</td> <td>PZ</td> </tr> </tbody> </table>	Code	Description	Qty	UOM	CN1003A0	CONDENSATO RE CORAZZATO 6,3 uF	1.000	PZ	VI1931A0	DADO CONDENSATO RE M8x1.65 H4 CH13 ZINC	1.000	PZ	VI1932A0	RONDELLA DENTELLATA CONDENSATO RE D8 ZINC	1.000	PZ
Code	Description	Qty	UOM																		
CN1003A0	CONDENSATO RE CORAZZATO 6,3 uF	1.000	PZ																		
VI1931A0	DADO CONDENSATO RE M8x1.65 H4 CH13 ZINC	1.000	PZ																		
VI1932A0	RONDELLA DENTELLATA CONDENSATO RE D8 ZINC	1.000	PZ																		
MR1004A	MORSETTIERA 7POLI 41A 450V		KMR1004A	FTW 1+2+3/4+5+6 TERMINAL BLOCK KIT	<table border="1"> <thead> <tr> <th>Code</th> <th>Description</th> <th>Qty</th> <th>UOM</th> </tr> </thead> <tbody> <tr> <td>MR1004A1</td> <td>MORSETTIERA A 7POLI 41A 450V</td> <td>1.000</td> <td>PZ</td> </tr> </tbody> </table>	Code	Description	Qty	UOM	MR1004A1	MORSETTIERA A 7POLI 41A 450V	1.000	PZ								
Code	Description	Qty	UOM																		
MR1004A1	MORSETTIERA A 7POLI 41A 450V	1.000	PZ																		



COMPONENT			SPARE PART																										
Code	Description	Image	Code	Description	Kit components																								
RC1006A	CURVA GUIDA TUBO PET D8		KRC1006A	20 PCS. Ø8 PET PIPE GUIDE BEND KI	<table border="1"> <thead> <tr> <th>Code</th> <th>Description</th> <th>Qty</th> <th>UOM</th> </tr> </thead> <tbody> <tr> <td>RC1006A0</td> <td>CURVA GUIDA TUBO PET D8</td> <td>20.000</td> <td>PZ</td> </tr> </tbody> </table>	Code	Description	Qty	UOM	RC1006A0	CURVA GUIDA TUBO PET D8	20.000	PZ																
Code	Description	Qty	UOM																										
RC1006A0	CURVA GUIDA TUBO PET D8	20.000	PZ																										
TB3283A	TB3283A0		KTB1959A	Ø8 TB1815 TRANSPARENT PIPE 5M KIT	<table border="1"> <thead> <tr> <th>Code</th> <th>Description</th> <th>Qty</th> <th>UOM</th> </tr> </thead> <tbody> <tr> <td>TB1815A0</td> <td>TUBO PE 7,93x4,75 TRASPARENT</td> <td>5.000</td> <td>M</td> </tr> </tbody> </table>	Code	Description	Qty	UOM	TB1815A0	TUBO PE 7,93x4,75 TRASPARENT	5.000	M																
Code	Description	Qty	UOM																										
TB1815A0	TUBO PE 7,93x4,75 TRASPARENT	5.000	M																										
TR1136A	TERMOSTATO SIC. UNIP. 318°C -0/+24		KTR1136A	318°C -0/+24 SAFETY THERMOSTAT KIT	<table border="1"> <thead> <tr> <th>Code</th> <th>Description</th> <th>Qty</th> <th>UOM</th> </tr> </thead> <tbody> <tr> <td>0H8120A0</td> <td>COPERCHIO INGRESSO BULBO XEVL</td> <td>1.000</td> <td>PZ</td> </tr> <tr> <td>GN1531A0</td> <td>GUARNIZIONE TENUTA INGRESSO BULBO</td> <td>1.000</td> <td>PZ</td> </tr> <tr> <td>SL1045A0</td> <td>SILICONE ANTRACITE S57 80 ml</td> <td>1.000</td> <td>PZ</td> </tr> <tr> <td>TR1136A0</td> <td>TERMOSTATO SIC. UNIP. 318°C -0/+24</td> <td>1.000</td> <td>PZ</td> </tr> <tr> <td>VI1220A1</td> <td>VITE AUTOFIL. 4.2X11 TCS+ MARUTEX</td> <td>3.000</td> <td>PZ</td> </tr> </tbody> </table>	Code	Description	Qty	UOM	0H8120A0	COPERCHIO INGRESSO BULBO XEVL	1.000	PZ	GN1531A0	GUARNIZIONE TENUTA INGRESSO BULBO	1.000	PZ	SL1045A0	SILICONE ANTRACITE S57 80 ml	1.000	PZ	TR1136A0	TERMOSTATO SIC. UNIP. 318°C -0/+24	1.000	PZ	VI1220A1	VITE AUTOFIL. 4.2X11 TCS+ MARUTEX	3.000	PZ
Code	Description	Qty	UOM																										
0H8120A0	COPERCHIO INGRESSO BULBO XEVL	1.000	PZ																										
GN1531A0	GUARNIZIONE TENUTA INGRESSO BULBO	1.000	PZ																										
SL1045A0	SILICONE ANTRACITE S57 80 ml	1.000	PZ																										
TR1136A0	TERMOSTATO SIC. UNIP. 318°C -0/+24	1.000	PZ																										
VI1220A1	VITE AUTOFIL. 4.2X11 TCS+ MARUTEX	3.000	PZ																										
VI1328A	VI1328A0		VI1328A0	VI1328A0																									



COMPONENT			SPARE PART														
Code	Description	Image	Code	Description	Kit components												
VM1188A	PASSACAVI SCHEDA POTENZA		KVM1188A	POWER BOARD WIRES PASS-THROUGH 10PCS KIT	<table border="1"> <thead> <tr> <th>Code</th> <th>Description</th> <th>Qty</th> <th>UOM</th> </tr> </thead> <tbody> <tr> <td>VM1188A0</td> <td>PASSACAVI SCHEDA POTENZA</td> <td>10.000</td> <td>PZ</td> </tr> </tbody> </table>	Code	Description	Qty	UOM	VM1188A0	PASSACAVI SCHEDA POTENZA	10.000	PZ				
Code	Description	Qty	UOM														
VM1188A0	PASSACAVI SCHEDA POTENZA	10.000	PZ														
VM2482A	TELAIO PORTA COMPONENTI ELETTRICI SP		KVM2482A	BAKERLUX SP ELECTR COMPONENTS HOLDER KIT	<table border="1"> <thead> <tr> <th>Code</th> <th>Description</th> <th>Qty</th> <th>UOM</th> </tr> </thead> <tbody> <tr> <td>VM2482A0</td> <td>TELAIO PORTA COMPONENTI ELETTRICI SP</td> <td>1.000</td> <td>PZ</td> </tr> <tr> <td>VM2484A0</td> <td>FERMACAVO ALLACCIAMEN TO ELETTRIC</td> <td>1.000</td> <td>PZ</td> </tr> </tbody> </table>	Code	Description	Qty	UOM	VM2482A0	TELAIO PORTA COMPONENTI ELETTRICI SP	1.000	PZ	VM2484A0	FERMACAVO ALLACCIAMEN TO ELETTRIC	1.000	PZ
Code	Description	Qty	UOM														
VM2482A0	TELAIO PORTA COMPONENTI ELETTRICI SP	1.000	PZ														
VM2484A0	FERMACAVO ALLACCIAMEN TO ELETTRIC	1.000	PZ														
VM2483A	COPERCHIO PORTA COMPONENTI SP		KVM2483A	BL SHOP.PRO COMPONENTS HOLDER COVER KIT	<table border="1"> <thead> <tr> <th>Code</th> <th>Description</th> <th>Qty</th> <th>UOM</th> </tr> </thead> <tbody> <tr> <td>VM2483A1</td> <td>COPERCHIO PORTA COMPONENTI SP</td> <td>1.000</td> <td>PZ</td> </tr> </tbody> </table>	Code	Description	Qty	UOM	VM2483A1	COPERCHIO PORTA COMPONENTI SP	1.000	PZ				
Code	Description	Qty	UOM														
VM2483A1	COPERCHIO PORTA COMPONENTI SP	1.000	PZ														
VM2484A	FERMACAVO ALLACCIAMENTO ELETTRICO		KVM2484A	CABLE LOCKS ELECTRICAL CONNECTION KIT	<table border="1"> <thead> <tr> <th>Code</th> <th>Description</th> <th>Qty</th> <th>UOM</th> </tr> </thead> <tbody> <tr> <td>VM2484A0</td> <td>FERMACAVO ALLACCIAMEN TO ELETTRIC</td> <td>1.000</td> <td>PZ</td> </tr> </tbody> </table>	Code	Description	Qty	UOM	VM2484A0	FERMACAVO ALLACCIAMEN TO ELETTRIC	1.000	PZ				
Code	Description	Qty	UOM														
VM2484A0	FERMACAVO ALLACCIAMEN TO ELETTRIC	1.000	PZ														
			KVM2482A	BAKERLUX SP ELECTR COMPONENTS HOLDER KIT	<table border="1"> <thead> <tr> <th>Code</th> <th>Description</th> <th>Qty</th> <th>UOM</th> </tr> </thead> <tbody> <tr> <td>VM2482A0</td> <td>TELAIO PORTA COMPONENTI ELETTRICI SP</td> <td>1.000</td> <td>PZ</td> </tr> <tr> <td>VM2484A0</td> <td>FERMACAVO ALLACCIAMEN TO ELETTRIC</td> <td>1.000</td> <td>PZ</td> </tr> </tbody> </table>	Code	Description	Qty	UOM	VM2482A0	TELAIO PORTA COMPONENTI ELETTRICI SP	1.000	PZ	VM2484A0	FERMACAVO ALLACCIAMEN TO ELETTRIC	1.000	PZ
Code	Description	Qty	UOM														
VM2482A0	TELAIO PORTA COMPONENTI ELETTRICI SP	1.000	PZ														
VM2484A0	FERMACAVO ALLACCIAMEN TO ELETTRIC	1.000	PZ														