







Assembly code	Assembly revision	Assembly image
ASM3008B/0.D02	Door	
ASM3069A/0.D05	Electrical system	
ASM1746B/0.D05	Cooking chamber	
ASM1772C/0.D01	External cover	



ASM3008B/0.D02 - Door



ASM3008B/0.D02 - Door

REAR



COMPONENT			SPARE PART																																										
Code	Description	Image	Code	Description	Components list																																								
CE1053B	MM MICROFIT LED BAR POWER SUPPLY CABLE		KCE1053B	LED BAR EXTENSION CABLE KIT	<table border="1"> <thead> <tr> <th>Code</th> <th>Description</th> <th>Qty</th> <th>UOM</th> </tr> </thead> <tbody> <tr> <td>CE1053B0</td> <td>MM MICROFIT LED BAR POWER SUPPLY CABL</td> <td>1</td> <td>PZ</td> </tr> </tbody> </table>	Code	Description	Qty	UOM	CE1053B0	MM MICROFIT LED BAR POWER SUPPLY CABL	1	PZ																																
Code	Description	Qty	UOM																																										
CE1053B0	MM MICROFIT LED BAR POWER SUPPLY CABL	1	PZ																																										
VT1292A	XEBC-10EU-E EXTERNAL GLASS		KVT1292A	10EU-10FS-1021 EXTERNAL GLASS KIT	<table border="1"> <thead> <tr> <th>Code</th> <th>Description</th> <th>Qty</th> <th>UOM</th> </tr> </thead> <tbody> <tr> <td>0B1173A0</td> <td>EXT. GLASS SUPPORT PROFILE</td> <td>2</td> <td>PZ</td> </tr> <tr> <td>IP1508A1</td> <td>POLYSTYREN E U SHAPED PROFILE 2000X60X60</td> <td>1</td> <td>M</td> </tr> <tr> <td>SL1155A1</td> <td>LOCTITE BICOMPONEN T SILICON</td> <td>150</td> <td>ML</td> </tr> <tr> <td>SL1156A0</td> <td>NOZZLE FOR SILICON GUN</td> <td>1</td> <td>PZ</td> </tr> <tr> <td>VM1059A1</td> <td>HEAT SHRINK FILM H800</td> <td>1.500</td> <td>M</td> </tr> <tr> <td>VT1292A0</td> <td>XEBC-10EU-E EXTERNAL GLASS</td> <td>1</td> <td>PZ</td> </tr> <tr> <td>VT1292A0</td> <td>XEBC-10EU-E EXTERNAL GLASS</td> <td>1</td> <td>PZ</td> </tr> </tbody> </table>	Code	Description	Qty	UOM	0B1173A0	EXT. GLASS SUPPORT PROFILE	2	PZ	IP1508A1	POLYSTYREN E U SHAPED PROFILE 2000X60X60	1	M	SL1155A1	LOCTITE BICOMPONEN T SILICON	150	ML	SL1156A0	NOZZLE FOR SILICON GUN	1	PZ	VM1059A1	HEAT SHRINK FILM H800	1.500	M	VT1292A0	XEBC-10EU-E EXTERNAL GLASS	1	PZ	VT1292A0	XEBC-10EU-E EXTERNAL GLASS	1	PZ								
Code	Description	Qty	UOM																																										
0B1173A0	EXT. GLASS SUPPORT PROFILE	2	PZ																																										
IP1508A1	POLYSTYREN E U SHAPED PROFILE 2000X60X60	1	M																																										
SL1155A1	LOCTITE BICOMPONEN T SILICON	150	ML																																										
SL1156A0	NOZZLE FOR SILICON GUN	1	PZ																																										
VM1059A1	HEAT SHRINK FILM H800	1.500	M																																										
VT1292A0	XEBC-10EU-E EXTERNAL GLASS	1	PZ																																										
VT1292A0	XEBC-10EU-E EXTERNAL GLASS	1	PZ																																										
			KDR1278B	BT-10EU -M EXTERNAL DOOR	<table border="1"> <thead> <tr> <th>Code</th> <th>Description</th> <th>Qty</th> <th>UOM</th> </tr> </thead> <tbody> <tr> <td>0B1126B0</td> <td></td> <td>1</td> <td>PZ</td> </tr> <tr> <td>0B1173A0</td> <td>EXT. GLASS SUPPORT PROFILE</td> <td>2</td> <td>PZ</td> </tr> <tr> <td>0B1218B0</td> <td></td> <td>1</td> <td>PZ</td> </tr> <tr> <td>0B1219A1</td> <td>MM DOUBLE GLASS DOOR INT UPPER BEAM 860</td> <td>1</td> <td>PZ</td> </tr> <tr> <td>0B1220A0</td> <td>XEBC-10E LEFT - RIGHT EXT DOOR COLUMN</td> <td>1</td> <td>PZ</td> </tr> <tr> <td>0B1221A2</td> <td>XEBC-10E LEFT - RIGHT INT DOOR COLUMN</td> <td>1</td> <td>PZ</td> </tr> <tr> <td>0B1222B0</td> <td></td> <td>1</td> <td>PZ</td> </tr> <tr> <td>0B1222B1</td> <td></td> <td>1</td> <td>PZ</td> </tr> <tr> <td>0B1223A2</td> <td>XEBC-10E LEFT - LEFT INT DOOR COLUMN</td> <td>1</td> <td>PZ</td> </tr> </tbody> </table>	Code	Description	Qty	UOM	0B1126B0		1	PZ	0B1173A0	EXT. GLASS SUPPORT PROFILE	2	PZ	0B1218B0		1	PZ	0B1219A1	MM DOUBLE GLASS DOOR INT UPPER BEAM 860	1	PZ	0B1220A0	XEBC-10E LEFT - RIGHT EXT DOOR COLUMN	1	PZ	0B1221A2	XEBC-10E LEFT - RIGHT INT DOOR COLUMN	1	PZ	0B1222B0		1	PZ	0B1222B1		1	PZ	0B1223A2	XEBC-10E LEFT - LEFT INT DOOR COLUMN	1	PZ
Code	Description	Qty	UOM																																										
0B1126B0		1	PZ																																										
0B1173A0	EXT. GLASS SUPPORT PROFILE	2	PZ																																										
0B1218B0		1	PZ																																										
0B1219A1	MM DOUBLE GLASS DOOR INT UPPER BEAM 860	1	PZ																																										
0B1220A0	XEBC-10E LEFT - RIGHT EXT DOOR COLUMN	1	PZ																																										
0B1221A2	XEBC-10E LEFT - RIGHT INT DOOR COLUMN	1	PZ																																										
0B1222B0		1	PZ																																										
0B1222B1		1	PZ																																										
0B1223A2	XEBC-10E LEFT - LEFT INT DOOR COLUMN	1	PZ																																										

COMPONENT			SPARE PART																																																																		
Code	Description	Image	Code	Description	Components list																																																																
VT1292A	XEBC-10EU-E EXTERNAL GLASS		KDR1278B	BT-10EU -M EXTERNAL DOOR	<table border="1"> <thead> <tr> <th>Code</th> <th>Description</th> <th>Qty</th> <th>UOM</th> </tr> </thead> <tbody> <tr> <td>0H7321A0</td> <td>MM STAINLESS STEEL HANDLE COVE</td> <td>1</td> <td>PZ</td> </tr> <tr> <td>CE1052A1</td> <td>CABLE CONNECTION CONTROL - USB MM 750M</td> <td>1</td> <td>PZ</td> </tr> <tr> <td>CE1053B0</td> <td>MM MICROFIT LED BAR POWER SUPPLY CABL</td> <td>1</td> <td>PZ</td> </tr> <tr> <td>CE1097A0</td> <td>4M SIHF 4 POLES MICROFIT CANBUS</td> <td>1</td> <td>PZ</td> </tr> <tr> <td>CE1285A0</td> <td>EMI ROUND FERRITE MOD.26438015 02</td> <td>1</td> <td>PZ</td> </tr> <tr> <td>IP1508A1</td> <td>POLYSTYREN E U SHAPED PROFILE 2000X60X60</td> <td>2</td> <td>M</td> </tr> <tr> <td>LP1022A0</td> <td>6 SERIES L600 LED LIGHT BAR - E903</td> <td>1</td> <td>PZ</td> </tr> <tr> <td>LP1028A0</td> <td>L=903 S6 NO LED LIGHT BAR COVER</td> <td>1</td> <td>PZ</td> </tr> <tr> <td>MG1099A1</td> <td></td> <td>1</td> <td>PZ</td> </tr> <tr> <td>RC1200A0</td> <td>ED=4 WIRE D.=0.5 COMPRESSIO N SPRING</td> <td>8</td> <td>PZ</td> </tr> <tr> <td>SL1155A1</td> <td>LOCTITE BICOMPONEN T SILICON</td> <td>100</td> <td>ML</td> </tr> <tr> <td>SL1170A1</td> <td>S57 BLACK SILICON - 310ML CARTRIDGE</td> <td>52</td> <td>ML</td> </tr> <tr> <td>VE1030A1</td> <td>MAGNET FOR DOOR MICROSWITC H D=22,9MM</td> <td>2</td> <td>PZ</td> </tr> <tr> <td>VI0239A1</td> <td>SELF-TAPPIN G SCREW 4.2X25 TCB+ INOX</td> <td>4</td> <td>PZ</td> </tr> <tr> <td>VI1103A0</td> <td>40X12 TBSP SCREW FOR PLASTIC</td> <td>2</td> <td>PZ</td> </tr> </tbody> </table>	Code	Description	Qty	UOM	0H7321A0	MM STAINLESS STEEL HANDLE COVE	1	PZ	CE1052A1	CABLE CONNECTION CONTROL - USB MM 750M	1	PZ	CE1053B0	MM MICROFIT LED BAR POWER SUPPLY CABL	1	PZ	CE1097A0	4M SIHF 4 POLES MICROFIT CANBUS	1	PZ	CE1285A0	EMI ROUND FERRITE MOD.26438015 02	1	PZ	IP1508A1	POLYSTYREN E U SHAPED PROFILE 2000X60X60	2	M	LP1022A0	6 SERIES L600 LED LIGHT BAR - E903	1	PZ	LP1028A0	L=903 S6 NO LED LIGHT BAR COVER	1	PZ	MG1099A1		1	PZ	RC1200A0	ED=4 WIRE D.=0.5 COMPRESSIO N SPRING	8	PZ	SL1155A1	LOCTITE BICOMPONEN T SILICON	100	ML	SL1170A1	S57 BLACK SILICON - 310ML CARTRIDGE	52	ML	VE1030A1	MAGNET FOR DOOR MICROSWITC H D=22,9MM	2	PZ	VI0239A1	SELF-TAPPIN G SCREW 4.2X25 TCB+ INOX	4	PZ	VI1103A0	40X12 TBSP SCREW FOR PLASTIC	2	PZ
Code	Description	Qty	UOM																																																																		
0H7321A0	MM STAINLESS STEEL HANDLE COVE	1	PZ																																																																		
CE1052A1	CABLE CONNECTION CONTROL - USB MM 750M	1	PZ																																																																		
CE1053B0	MM MICROFIT LED BAR POWER SUPPLY CABL	1	PZ																																																																		
CE1097A0	4M SIHF 4 POLES MICROFIT CANBUS	1	PZ																																																																		
CE1285A0	EMI ROUND FERRITE MOD.26438015 02	1	PZ																																																																		
IP1508A1	POLYSTYREN E U SHAPED PROFILE 2000X60X60	2	M																																																																		
LP1022A0	6 SERIES L600 LED LIGHT BAR - E903	1	PZ																																																																		
LP1028A0	L=903 S6 NO LED LIGHT BAR COVER	1	PZ																																																																		
MG1099A1		1	PZ																																																																		
RC1200A0	ED=4 WIRE D.=0.5 COMPRESSIO N SPRING	8	PZ																																																																		
SL1155A1	LOCTITE BICOMPONEN T SILICON	100	ML																																																																		
SL1170A1	S57 BLACK SILICON - 310ML CARTRIDGE	52	ML																																																																		
VE1030A1	MAGNET FOR DOOR MICROSWITC H D=22,9MM	2	PZ																																																																		
VI0239A1	SELF-TAPPIN G SCREW 4.2X25 TCB+ INOX	4	PZ																																																																		
VI1103A0	40X12 TBSP SCREW FOR PLASTIC	2	PZ																																																																		





COMPONENT			SPARE PART																																																																															
Code	Description	Image	Code	Description	Components list																																																																													
VT1292A	XEBC-10EU-E EXTERNAL GLASS		KDR1278B	BT-10EU -M EXTERNAL DOOR	<table border="1"> <thead> <tr> <th>Code</th> <th>Description</th> <th>Qty</th> <th>UOM</th> </tr> </thead> <tbody> <tr> <td>VI1220A1</td> <td>4,2X12 TCB SELF-TAPPIN G SCREW</td> <td>34</td> <td>PZ</td> </tr> <tr> <td>VI1930A1</td> <td>ST. STEEL 5X20 CHIP SCREW</td> <td>16</td> <td>PZ</td> </tr> <tr> <td>VI1996A0</td> <td>M5X35 SCREW</td> <td>13</td> <td>PZ</td> </tr> <tr> <td>VM1059A1</td> <td>HEAT SHRINK FILM H800</td> <td>1.500</td> <td>M</td> </tr> <tr> <td>VM1182B1</td> <td>E S. CT BT HANDLE JUNCTION + PIN GUIDE</td> <td>1</td> <td>PZ</td> </tr> <tr> <td>VM1490A0</td> <td>CHEFTOP/BAK ERTOP HANDLE SCREWS COVER</td> <td>2</td> <td>PZ</td> </tr> <tr> <td>VM1630A1</td> <td>INTERNAL GLASS PUSHING CAP</td> <td>5</td> <td>PZ</td> </tr> <tr> <td>VM1631A0</td> <td>PLUS INNER GLASS PUSHING CAP</td> <td>5</td> <td>PZ</td> </tr> <tr> <td>VM1695A0</td> <td>HANDLE POSITION PIN</td> <td>4</td> <td>PZ</td> </tr> <tr> <td>VM2245A0</td> <td>HANDLE SHAFT WITH LATCH</td> <td>1</td> <td>PZ</td> </tr> <tr> <td>VM2247B0</td> <td>HANDLE SHAFT COVER VM2245-2246</td> <td>1</td> <td>PZ</td> </tr> <tr> <td>VM2248B0</td> <td>HANDLE WITH LATCH CLOSING KEY</td> <td>1</td> <td>PZ</td> </tr> <tr> <td>VM2267A0</td> <td>INTERNAL GLASS LOCKING SYSTEM SLIDER</td> <td>2</td> <td>PZ</td> </tr> <tr> <td>VM2268A0</td> <td>DOOR MAGNET COVER</td> <td>2</td> <td>PZ</td> </tr> <tr> <td>VM2269B0</td> <td>INNER GLASS FIXING CAP</td> <td>2</td> <td>PZ</td> </tr> <tr> <td>VM2274A0</td> <td>GROOVED BUSHING</td> <td>1</td> <td>PZ</td> </tr> <tr> <td>VM2275A0</td> <td>SMOOTH BUSHING</td> <td>1</td> <td>PZ</td> </tr> <tr> <td>VM2285B0</td> <td>860 SERIES DRIP PROFILE KIT</td> <td>1</td> <td>PZ</td> </tr> </tbody> </table>	Code	Description	Qty	UOM	VI1220A1	4,2X12 TCB SELF-TAPPIN G SCREW	34	PZ	VI1930A1	ST. STEEL 5X20 CHIP SCREW	16	PZ	VI1996A0	M5X35 SCREW	13	PZ	VM1059A1	HEAT SHRINK FILM H800	1.500	M	VM1182B1	E S. CT BT HANDLE JUNCTION + PIN GUIDE	1	PZ	VM1490A0	CHEFTOP/BAK ERTOP HANDLE SCREWS COVER	2	PZ	VM1630A1	INTERNAL GLASS PUSHING CAP	5	PZ	VM1631A0	PLUS INNER GLASS PUSHING CAP	5	PZ	VM1695A0	HANDLE POSITION PIN	4	PZ	VM2245A0	HANDLE SHAFT WITH LATCH	1	PZ	VM2247B0	HANDLE SHAFT COVER VM2245-2246	1	PZ	VM2248B0	HANDLE WITH LATCH CLOSING KEY	1	PZ	VM2267A0	INTERNAL GLASS LOCKING SYSTEM SLIDER	2	PZ	VM2268A0	DOOR MAGNET COVER	2	PZ	VM2269B0	INNER GLASS FIXING CAP	2	PZ	VM2274A0	GROOVED BUSHING	1	PZ	VM2275A0	SMOOTH BUSHING	1	PZ	VM2285B0	860 SERIES DRIP PROFILE KIT	1	PZ	
Code	Description	Qty	UOM																																																																															
VI1220A1	4,2X12 TCB SELF-TAPPIN G SCREW	34	PZ																																																																															
VI1930A1	ST. STEEL 5X20 CHIP SCREW	16	PZ																																																																															
VI1996A0	M5X35 SCREW	13	PZ																																																																															
VM1059A1	HEAT SHRINK FILM H800	1.500	M																																																																															
VM1182B1	E S. CT BT HANDLE JUNCTION + PIN GUIDE	1	PZ																																																																															
VM1490A0	CHEFTOP/BAK ERTOP HANDLE SCREWS COVER	2	PZ																																																																															
VM1630A1	INTERNAL GLASS PUSHING CAP	5	PZ																																																																															
VM1631A0	PLUS INNER GLASS PUSHING CAP	5	PZ																																																																															
VM1695A0	HANDLE POSITION PIN	4	PZ																																																																															
VM2245A0	HANDLE SHAFT WITH LATCH	1	PZ																																																																															
VM2247B0	HANDLE SHAFT COVER VM2245-2246	1	PZ																																																																															
VM2248B0	HANDLE WITH LATCH CLOSING KEY	1	PZ																																																																															
VM2267A0	INTERNAL GLASS LOCKING SYSTEM SLIDER	2	PZ																																																																															
VM2268A0	DOOR MAGNET COVER	2	PZ																																																																															
VM2269B0	INNER GLASS FIXING CAP	2	PZ																																																																															
VM2274A0	GROOVED BUSHING	1	PZ																																																																															
VM2275A0	SMOOTH BUSHING	1	PZ																																																																															
VM2285B0	860 SERIES DRIP PROFILE KIT	1	PZ																																																																															



COMPONENT			SPARE PART																																																																												
Code	Description	Image	Code	Description	Components list																																																																										
VT1292A	XEBC-10EU-E EXTERNAL GLASS		KDR1278B	BT-10EU -M EXTERNAL DOOR	<table border="1"> <thead> <tr> <th>Code</th> <th>Description</th> <th>Qty</th> <th>UOM</th> </tr> </thead> <tbody> <tr> <td>VM2295A1</td> <td>MIND.MAPS TOUCH CONTROL STYLUS KIT</td> <td>1</td> <td>PZ</td> </tr> <tr> <td>VM2305A0</td> <td>6 SERIES DOOR CAP FIXING PAWL</td> <td>14</td> <td>PZ</td> </tr> <tr> <td>VM2313A0</td> <td>TUBE DX DISCHARGE DRIP MM</td> <td>1</td> <td>PZ</td> </tr> <tr> <td>VM2314A0</td> <td>6 S. DRIP PROFILE CAP</td> <td>1</td> <td>PZ</td> </tr> <tr> <td>VM2315B0</td> <td>S6 INTERNAL GLASS SUPPORT</td> <td>5</td> <td>PZ</td> </tr> <tr> <td>VM2383B0</td> <td>S6 LEFT OVENS UPPER RIGHT CAP</td> <td>1</td> <td>PZ</td> </tr> <tr> <td>VM2384B0</td> <td></td> <td>1</td> <td>PZ</td> </tr> <tr> <td>VM2385B0</td> <td>S6 LEFT OVENS UPPER LEFT CAP</td> <td>1</td> <td>PZ</td> </tr> <tr> <td>VM2386B0</td> <td>MM -M LEFT DOOR LEFT LOWER CAP KI</td> <td>1</td> <td>PZ</td> </tr> <tr> <td>VM2410A0</td> <td>PLATE TO STOP EXTRUDED LED BAR</td> <td>4</td> <td>PZ</td> </tr> <tr> <td>VM2505B0</td> <td>MM PLUS INTERNAL GLASS SUPPORT</td> <td>5</td> <td>PZ</td> </tr> <tr> <td>VM2518A0</td> <td>BOARD COOLING FAN SUPPORT</td> <td>1</td> <td>PZ</td> </tr> <tr> <td>VN1179A1</td> <td>CONTROL BOARD 40X40X20MM 12V COOLING FAN</td> <td>1</td> <td>PZ</td> </tr> <tr> <td>VP1076A0</td> <td>PLUS ONE ZERO HANDLE PIN</td> <td>1</td> <td>PZ</td> </tr> <tr> <td>VP1080A0</td> <td>UPPER HINGE CAP FOR LOWER INNER GLASS</td> <td>1</td> <td>PZ</td> </tr> <tr> <td>VP1081A0</td> <td>UPPER HINGE CAP FOR UPPER INNER GLASS</td> <td>1</td> <td>PZ</td> </tr> <tr> <td>VT1292A0</td> <td>XEBC-10EU-E EXTERNAL GLASS</td> <td></td> <td></td> <td>1</td> <td>PZ</td> </tr> </tbody> </table>	Code	Description	Qty	UOM	VM2295A1	MIND.MAPS TOUCH CONTROL STYLUS KIT	1	PZ	VM2305A0	6 SERIES DOOR CAP FIXING PAWL	14	PZ	VM2313A0	TUBE DX DISCHARGE DRIP MM	1	PZ	VM2314A0	6 S. DRIP PROFILE CAP	1	PZ	VM2315B0	S6 INTERNAL GLASS SUPPORT	5	PZ	VM2383B0	S6 LEFT OVENS UPPER RIGHT CAP	1	PZ	VM2384B0		1	PZ	VM2385B0	S6 LEFT OVENS UPPER LEFT CAP	1	PZ	VM2386B0	MM -M LEFT DOOR LEFT LOWER CAP KI	1	PZ	VM2410A0	PLATE TO STOP EXTRUDED LED BAR	4	PZ	VM2505B0	MM PLUS INTERNAL GLASS SUPPORT	5	PZ	VM2518A0	BOARD COOLING FAN SUPPORT	1	PZ	VN1179A1	CONTROL BOARD 40X40X20MM 12V COOLING FAN	1	PZ	VP1076A0	PLUS ONE ZERO HANDLE PIN	1	PZ	VP1080A0	UPPER HINGE CAP FOR LOWER INNER GLASS	1	PZ	VP1081A0	UPPER HINGE CAP FOR UPPER INNER GLASS	1	PZ	VT1292A0	XEBC-10EU-E EXTERNAL GLASS			1	PZ
Code	Description	Qty	UOM																																																																												
VM2295A1	MIND.MAPS TOUCH CONTROL STYLUS KIT	1	PZ																																																																												
VM2305A0	6 SERIES DOOR CAP FIXING PAWL	14	PZ																																																																												
VM2313A0	TUBE DX DISCHARGE DRIP MM	1	PZ																																																																												
VM2314A0	6 S. DRIP PROFILE CAP	1	PZ																																																																												
VM2315B0	S6 INTERNAL GLASS SUPPORT	5	PZ																																																																												
VM2383B0	S6 LEFT OVENS UPPER RIGHT CAP	1	PZ																																																																												
VM2384B0		1	PZ																																																																												
VM2385B0	S6 LEFT OVENS UPPER LEFT CAP	1	PZ																																																																												
VM2386B0	MM -M LEFT DOOR LEFT LOWER CAP KI	1	PZ																																																																												
VM2410A0	PLATE TO STOP EXTRUDED LED BAR	4	PZ																																																																												
VM2505B0	MM PLUS INTERNAL GLASS SUPPORT	5	PZ																																																																												
VM2518A0	BOARD COOLING FAN SUPPORT	1	PZ																																																																												
VN1179A1	CONTROL BOARD 40X40X20MM 12V COOLING FAN	1	PZ																																																																												
VP1076A0	PLUS ONE ZERO HANDLE PIN	1	PZ																																																																												
VP1080A0	UPPER HINGE CAP FOR LOWER INNER GLASS	1	PZ																																																																												
VP1081A0	UPPER HINGE CAP FOR UPPER INNER GLASS	1	PZ																																																																												
VT1292A0	XEBC-10EU-E EXTERNAL GLASS			1	PZ																																																																										



COMPONENT			SPARE PART																																																																														
Code	Description	Image	Code	Description	Components list																																																																												
VT1292A	XEBC-10EU-E EXTERNAL GLASS		KDR1278A	BT-10EU EXTERNAL DOOR	<table border="1"> <thead> <tr> <th>Code</th> <th>Description</th> <th>Qty</th> <th>UOM</th> </tr> </thead> <tbody> <tr> <td>0B1126A1</td> <td></td> <td>1</td> <td>PZ</td> </tr> <tr> <td>0B1173A0</td> <td>EXT. GLASS SUPPORT PROFILE</td> <td>2</td> <td>PZ</td> </tr> <tr> <td>0B1218A1</td> <td></td> <td>1</td> <td>PZ</td> </tr> <tr> <td>0B1219A1</td> <td>MM DOUBLE GLASS DOOR INT UPPER BEAM 860</td> <td>1</td> <td>PZ</td> </tr> <tr> <td>0B1220A0</td> <td>XEBC-10E LEFT - RIGHT EXT DOOR COLUMN</td> <td>1</td> <td>PZ</td> </tr> <tr> <td>0B1221A2</td> <td>XEBC-10E LEFT - RIGHT INT DOOR COLUMN</td> <td>1</td> <td>PZ</td> </tr> <tr> <td>0B1222A0</td> <td>XEBC-10E LEFT - LEFT EXT DOOR COLUMN</td> <td>1</td> <td>PZ</td> </tr> <tr> <td>0B1222B0</td> <td></td> <td>1</td> <td>PZ</td> </tr> <tr> <td>0B1222B1</td> <td></td> <td>1</td> <td>PZ</td> </tr> <tr> <td>0B1223A2</td> <td>XEBC-10E LEFT - LEFT INT DOOR COLUMN</td> <td>1</td> <td>PZ</td> </tr> <tr> <td>0H7321A0</td> <td>MM STAINLESS STEEL HANDLE COVE</td> <td>1</td> <td>PZ</td> </tr> <tr> <td>CE1052A1</td> <td>CABLE CONNECTION CONTROL - USB MM 750M</td> <td>1</td> <td>PZ</td> </tr> <tr> <td>CE1053B0</td> <td>MM MICROFIT LED BAR POWER SUPPLY CABL</td> <td>1</td> <td>PZ</td> </tr> <tr> <td>CE1285A0</td> <td>EMI ROUND FERRITE MOD.26438015 02</td> <td>1</td> <td>PZ</td> </tr> <tr> <td>CE1290A0</td> <td>EXTRACTABL E FEMALE TERMINAL CPF 5/4</td> <td>1</td> <td>PZ</td> </tr> <tr> <td>CE1455A0</td> <td>TIP END FITTING</td> <td>4</td> <td>PZ</td> </tr> <tr> <td>CE1725A0</td> <td>ROBOTICS SILICON PIPE 4X0,5 MMQ</td> <td>4</td> <td>M</td> </tr> <tr> <td>CE1735A0</td> <td>MINIFIT FEMALE END FITTING</td> <td>4</td> <td>PZ</td> </tr> </tbody> </table>	Code	Description	Qty	UOM	0B1126A1		1	PZ	0B1173A0	EXT. GLASS SUPPORT PROFILE	2	PZ	0B1218A1		1	PZ	0B1219A1	MM DOUBLE GLASS DOOR INT UPPER BEAM 860	1	PZ	0B1220A0	XEBC-10E LEFT - RIGHT EXT DOOR COLUMN	1	PZ	0B1221A2	XEBC-10E LEFT - RIGHT INT DOOR COLUMN	1	PZ	0B1222A0	XEBC-10E LEFT - LEFT EXT DOOR COLUMN	1	PZ	0B1222B0		1	PZ	0B1222B1		1	PZ	0B1223A2	XEBC-10E LEFT - LEFT INT DOOR COLUMN	1	PZ	0H7321A0	MM STAINLESS STEEL HANDLE COVE	1	PZ	CE1052A1	CABLE CONNECTION CONTROL - USB MM 750M	1	PZ	CE1053B0	MM MICROFIT LED BAR POWER SUPPLY CABL	1	PZ	CE1285A0	EMI ROUND FERRITE MOD.26438015 02	1	PZ	CE1290A0	EXTRACTABL E FEMALE TERMINAL CPF 5/4	1	PZ	CE1455A0	TIP END FITTING	4	PZ	CE1725A0	ROBOTICS SILICON PIPE 4X0,5 MMQ	4	M	CE1735A0	MINIFIT FEMALE END FITTING	4	PZ
Code	Description	Qty	UOM																																																																														
0B1126A1		1	PZ																																																																														
0B1173A0	EXT. GLASS SUPPORT PROFILE	2	PZ																																																																														
0B1218A1		1	PZ																																																																														
0B1219A1	MM DOUBLE GLASS DOOR INT UPPER BEAM 860	1	PZ																																																																														
0B1220A0	XEBC-10E LEFT - RIGHT EXT DOOR COLUMN	1	PZ																																																																														
0B1221A2	XEBC-10E LEFT - RIGHT INT DOOR COLUMN	1	PZ																																																																														
0B1222A0	XEBC-10E LEFT - LEFT EXT DOOR COLUMN	1	PZ																																																																														
0B1222B0		1	PZ																																																																														
0B1222B1		1	PZ																																																																														
0B1223A2	XEBC-10E LEFT - LEFT INT DOOR COLUMN	1	PZ																																																																														
0H7321A0	MM STAINLESS STEEL HANDLE COVE	1	PZ																																																																														
CE1052A1	CABLE CONNECTION CONTROL - USB MM 750M	1	PZ																																																																														
CE1053B0	MM MICROFIT LED BAR POWER SUPPLY CABL	1	PZ																																																																														
CE1285A0	EMI ROUND FERRITE MOD.26438015 02	1	PZ																																																																														
CE1290A0	EXTRACTABL E FEMALE TERMINAL CPF 5/4	1	PZ																																																																														
CE1455A0	TIP END FITTING	4	PZ																																																																														
CE1725A0	ROBOTICS SILICON PIPE 4X0,5 MMQ	4	M																																																																														
CE1735A0	MINIFIT FEMALE END FITTING	4	PZ																																																																														

COMPONENT			SPARE PART																																																																														
Code	Description	Image	Code	Description	Components list																																																																												
VT1292A	XEBC-10EU-E EXTERNAL GLASS		KDR1278A	BT-10EU EXTERNAL DOOR	<table border="1"> <thead> <tr> <th>Code</th> <th>Description</th> <th>Qty</th> <th>UOM</th> </tr> </thead> <tbody> <tr> <td>CE1755A0</td> <td>4 WAYS MALE MINIFIT CONNECTOR</td> <td>1</td> <td>PZ</td> </tr> <tr> <td>IP1508A1</td> <td>POLYSTYREN E U SHAPED PROFILE 2000X60X60</td> <td>2</td> <td>M</td> </tr> <tr> <td>LP1022A0</td> <td>6 SERIES L600 LED LIGHT BAR - E903</td> <td>1</td> <td>PZ</td> </tr> <tr> <td>LP1028A0</td> <td>L=903 S6 NO LED LIGHT BAR COVER</td> <td>1</td> <td>PZ</td> </tr> <tr> <td>MG1083A2</td> <td></td> <td>1</td> <td>PZ</td> </tr> <tr> <td>RC1200A0</td> <td>ED=4 WIRE D.=0.5 COMPRESSIO N SPRING</td> <td>8</td> <td>PZ</td> </tr> <tr> <td>VE1030A1</td> <td>MAGNET FOR DOOR MICROSWITC H D=22.9MM</td> <td>2</td> <td>PZ</td> </tr> <tr> <td>VI1220A1</td> <td>4,2X12 TCB SELF-TAPPIN G SCREW</td> <td>19</td> <td>PZ</td> </tr> <tr> <td>VI1930A1</td> <td>ST. STEEL 5X20 CHIP SCREW</td> <td>16</td> <td>PZ</td> </tr> <tr> <td>VI1960A1</td> <td>4.2X9.5 CROSS ZN-NI SELF-THREADI NG SCREW</td> <td>10</td> <td>PZ</td> </tr> <tr> <td>VI1962A0</td> <td>ST. STEEL M10 BLIND NUT</td> <td>1</td> <td>PZ</td> </tr> <tr> <td>VI1996A0</td> <td>M5X35 SCREW</td> <td>13</td> <td>PZ</td> </tr> <tr> <td>VM1059A1</td> <td>HEAT SHRINK FILM H800</td> <td>1.500</td> <td>M</td> </tr> <tr> <td>VM1182B1</td> <td>E.S. CT BT HANDLE JUNCTION + PIN GUIDE</td> <td>1</td> <td>PZ</td> </tr> <tr> <td>VM1183C0</td> <td>CT BT HANDLE T-SHAPED PIN KIT</td> <td>1</td> <td>PZ</td> </tr> <tr> <td>VM1183C1</td> <td>CT BT HANDLE T-SHAPED PIN KIT</td> <td>1</td> <td>PZ</td> </tr> <tr> <td>VM1630A1</td> <td>INTERNAL GLASS PUSHING CAP</td> <td>5</td> <td>PZ</td> </tr> <tr> <td>VM1631A0</td> <td>PLUS INNER GLASS PUSHING CAP</td> <td>5</td> <td>PZ</td> </tr> </tbody> </table>	Code	Description	Qty	UOM	CE1755A0	4 WAYS MALE MINIFIT CONNECTOR	1	PZ	IP1508A1	POLYSTYREN E U SHAPED PROFILE 2000X60X60	2	M	LP1022A0	6 SERIES L600 LED LIGHT BAR - E903	1	PZ	LP1028A0	L=903 S6 NO LED LIGHT BAR COVER	1	PZ	MG1083A2		1	PZ	RC1200A0	ED=4 WIRE D.=0.5 COMPRESSIO N SPRING	8	PZ	VE1030A1	MAGNET FOR DOOR MICROSWITC H D=22.9MM	2	PZ	VI1220A1	4,2X12 TCB SELF-TAPPIN G SCREW	19	PZ	VI1930A1	ST. STEEL 5X20 CHIP SCREW	16	PZ	VI1960A1	4.2X9.5 CROSS ZN-NI SELF-THREADI NG SCREW	10	PZ	VI1962A0	ST. STEEL M10 BLIND NUT	1	PZ	VI1996A0	M5X35 SCREW	13	PZ	VM1059A1	HEAT SHRINK FILM H800	1.500	M	VM1182B1	E.S. CT BT HANDLE JUNCTION + PIN GUIDE	1	PZ	VM1183C0	CT BT HANDLE T-SHAPED PIN KIT	1	PZ	VM1183C1	CT BT HANDLE T-SHAPED PIN KIT	1	PZ	VM1630A1	INTERNAL GLASS PUSHING CAP	5	PZ	VM1631A0	PLUS INNER GLASS PUSHING CAP	5	PZ
					Code	Description	Qty	UOM																																																																									
					CE1755A0	4 WAYS MALE MINIFIT CONNECTOR	1	PZ																																																																									
					IP1508A1	POLYSTYREN E U SHAPED PROFILE 2000X60X60	2	M																																																																									
					LP1022A0	6 SERIES L600 LED LIGHT BAR - E903	1	PZ																																																																									
					LP1028A0	L=903 S6 NO LED LIGHT BAR COVER	1	PZ																																																																									
					MG1083A2		1	PZ																																																																									
					RC1200A0	ED=4 WIRE D.=0.5 COMPRESSIO N SPRING	8	PZ																																																																									
					VE1030A1	MAGNET FOR DOOR MICROSWITC H D=22.9MM	2	PZ																																																																									
					VI1220A1	4,2X12 TCB SELF-TAPPIN G SCREW	19	PZ																																																																									
					VI1930A1	ST. STEEL 5X20 CHIP SCREW	16	PZ																																																																									
					VI1960A1	4.2X9.5 CROSS ZN-NI SELF-THREADI NG SCREW	10	PZ																																																																									
					VI1962A0	ST. STEEL M10 BLIND NUT	1	PZ																																																																									
					VI1996A0	M5X35 SCREW	13	PZ																																																																									
					VM1059A1	HEAT SHRINK FILM H800	1.500	M																																																																									
VM1182B1	E.S. CT BT HANDLE JUNCTION + PIN GUIDE	1	PZ																																																																														
VM1183C0	CT BT HANDLE T-SHAPED PIN KIT	1	PZ																																																																														
VM1183C1	CT BT HANDLE T-SHAPED PIN KIT	1	PZ																																																																														
VM1630A1	INTERNAL GLASS PUSHING CAP	5	PZ																																																																														
VM1631A0	PLUS INNER GLASS PUSHING CAP	5	PZ																																																																														



COMPONENT			SPARE PART																																																																														
Code	Description	Image	Code	Description	Components list																																																																												
VT1292A	XEBC-10EU-E EXTERNAL GLASS		KDR1278A	BT-10EU EXTERNAL DOOR	<table border="1"> <thead> <tr> <th>Code</th> <th>Description</th> <th>Qty</th> <th>UOM</th> </tr> </thead> <tbody> <tr> <td>VM1695A0</td> <td>HANDLE POSITION PIN</td> <td>4</td> <td>PZ</td> </tr> <tr> <td>VM2245A0</td> <td>HANDLE SHAFT WITH LATCH</td> <td>1</td> <td>PZ</td> </tr> <tr> <td>VM2247B0</td> <td>HANDLE SHAFT COVER VM2245-2246</td> <td>1</td> <td>PZ</td> </tr> <tr> <td>VM2248B0</td> <td>HANDLE WITH LATCH CLOSING KEY</td> <td>1</td> <td>PZ</td> </tr> <tr> <td>VM2267A0</td> <td>INTERNAL GLASS LOCKING SYSTEM SLIDER</td> <td>2</td> <td>PZ</td> </tr> <tr> <td>VM2268A0</td> <td>DOOR MAGNET COVER</td> <td>2</td> <td>PZ</td> </tr> <tr> <td>VM2269A0</td> <td>INTERNAL GLASS LOCKING SYSTEM CAP</td> <td>2</td> <td>PZ</td> </tr> <tr> <td>VM2274A0</td> <td>GROOVED BUSHING</td> <td>1</td> <td>PZ</td> </tr> <tr> <td>VM2275A0</td> <td>SMOOTH BUSHING</td> <td>1</td> <td>PZ</td> </tr> <tr> <td>VM2285A0</td> <td>860 SERIES DRIP PROFILE</td> <td>1</td> <td>PZ</td> </tr> <tr> <td>VM2295A0</td> <td>STYLUS PEN FOR MM</td> <td>1</td> <td>PZ</td> </tr> <tr> <td>VM2305A0</td> <td>6 SERIES DOOR CAP FIXING PAWL</td> <td>14</td> <td>PZ</td> </tr> <tr> <td>VM2312A0</td> <td>6 S. DRIP PROFILE DRAIN LEFT PIPE</td> <td>1</td> <td>PZ</td> </tr> <tr> <td>VM2313A0</td> <td>TUBE DX DISCHARGE DRIP MM</td> <td>1</td> <td>PZ</td> </tr> <tr> <td>VM2314A0</td> <td>6 S. DRIP PROFILE CAP</td> <td>2</td> <td>PZ</td> </tr> <tr> <td>VM2315A0</td> <td>MIND.MAPS INTERNAL GLASS CAP SUPPORT</td> <td>5</td> <td>PZ</td> </tr> <tr> <td>VM2383A0</td> <td>MM LEFT DOOR RIGHT UPPER CAP</td> <td>1</td> <td>PZ</td> </tr> <tr> <td>VM2384A0</td> <td>MM LEFT DOOR RIGHT LOWER CAP</td> <td>1</td> <td>PZ</td> </tr> </tbody> </table>	Code	Description	Qty	UOM	VM1695A0	HANDLE POSITION PIN	4	PZ	VM2245A0	HANDLE SHAFT WITH LATCH	1	PZ	VM2247B0	HANDLE SHAFT COVER VM2245-2246	1	PZ	VM2248B0	HANDLE WITH LATCH CLOSING KEY	1	PZ	VM2267A0	INTERNAL GLASS LOCKING SYSTEM SLIDER	2	PZ	VM2268A0	DOOR MAGNET COVER	2	PZ	VM2269A0	INTERNAL GLASS LOCKING SYSTEM CAP	2	PZ	VM2274A0	GROOVED BUSHING	1	PZ	VM2275A0	SMOOTH BUSHING	1	PZ	VM2285A0	860 SERIES DRIP PROFILE	1	PZ	VM2295A0	STYLUS PEN FOR MM	1	PZ	VM2305A0	6 SERIES DOOR CAP FIXING PAWL	14	PZ	VM2312A0	6 S. DRIP PROFILE DRAIN LEFT PIPE	1	PZ	VM2313A0	TUBE DX DISCHARGE DRIP MM	1	PZ	VM2314A0	6 S. DRIP PROFILE CAP	2	PZ	VM2315A0	MIND.MAPS INTERNAL GLASS CAP SUPPORT	5	PZ	VM2383A0	MM LEFT DOOR RIGHT UPPER CAP	1	PZ	VM2384A0	MM LEFT DOOR RIGHT LOWER CAP	1	PZ
					Code	Description	Qty	UOM																																																																									
					VM1695A0	HANDLE POSITION PIN	4	PZ																																																																									
					VM2245A0	HANDLE SHAFT WITH LATCH	1	PZ																																																																									
					VM2247B0	HANDLE SHAFT COVER VM2245-2246	1	PZ																																																																									
					VM2248B0	HANDLE WITH LATCH CLOSING KEY	1	PZ																																																																									
					VM2267A0	INTERNAL GLASS LOCKING SYSTEM SLIDER	2	PZ																																																																									
					VM2268A0	DOOR MAGNET COVER	2	PZ																																																																									
					VM2269A0	INTERNAL GLASS LOCKING SYSTEM CAP	2	PZ																																																																									
					VM2274A0	GROOVED BUSHING	1	PZ																																																																									
					VM2275A0	SMOOTH BUSHING	1	PZ																																																																									
					VM2285A0	860 SERIES DRIP PROFILE	1	PZ																																																																									
					VM2295A0	STYLUS PEN FOR MM	1	PZ																																																																									
					VM2305A0	6 SERIES DOOR CAP FIXING PAWL	14	PZ																																																																									
					VM2312A0	6 S. DRIP PROFILE DRAIN LEFT PIPE	1	PZ																																																																									
					VM2313A0	TUBE DX DISCHARGE DRIP MM	1	PZ																																																																									
					VM2314A0	6 S. DRIP PROFILE CAP	2	PZ																																																																									
					VM2315A0	MIND.MAPS INTERNAL GLASS CAP SUPPORT	5	PZ																																																																									
					VM2383A0	MM LEFT DOOR RIGHT UPPER CAP	1	PZ																																																																									
					VM2384A0	MM LEFT DOOR RIGHT LOWER CAP	1	PZ																																																																									



COMPONENT			SPARE PART																																											
Code	Description	Image	Code	Description	Components list																																									
VT1292A	XEBC-10EU-E EXTERNAL GLASS		KDR1278A	BT-10EU EXTERNAL DOOR	<table border="1"> <thead> <tr> <th>Code</th> <th>Description</th> <th>Qty</th> <th>UOM</th> </tr> </thead> <tbody> <tr> <td>VM2385A1</td> <td>LEFT MM DOOR UPPER LEFT CAP</td> <td>1</td> <td>PZ</td> </tr> <tr> <td>VM2386A1</td> <td>LEFT MM DOOR LOWER LEFT CAP</td> <td>1</td> <td>PZ</td> </tr> <tr> <td>VM2410A0</td> <td>PLATE TO STOP EXTRUDED LED BAR</td> <td>4</td> <td>PZ</td> </tr> <tr> <td>VM2417A0</td> <td>PIN M10 DOOR CAP 6 SERIES MV</td> <td>1</td> <td>PZ</td> </tr> <tr> <td>VM2505A0</td> <td>MM PLUS INTERNAL GLASS SUPPORT</td> <td>5</td> <td>PZ</td> </tr> <tr> <td>VM2518A0</td> <td>BOARD COOLING FAN SUPPORT</td> <td>1</td> <td>PZ</td> </tr> <tr> <td>VN1179A1</td> <td>CONTROL BOARD 40X40X20MM 12V COOLING FAN</td> <td>1</td> <td>PZ</td> </tr> <tr> <td>VT1292A0</td> <td>XEBC-10EU-E EXTERNAL GLASS</td> <td>1</td> <td>PZ</td> </tr> </tbody> </table>	Code	Description	Qty	UOM	VM2385A1	LEFT MM DOOR UPPER LEFT CAP	1	PZ	VM2386A1	LEFT MM DOOR LOWER LEFT CAP	1	PZ	VM2410A0	PLATE TO STOP EXTRUDED LED BAR	4	PZ	VM2417A0	PIN M10 DOOR CAP 6 SERIES MV	1	PZ	VM2505A0	MM PLUS INTERNAL GLASS SUPPORT	5	PZ	VM2518A0	BOARD COOLING FAN SUPPORT	1	PZ	VN1179A1	CONTROL BOARD 40X40X20MM 12V COOLING FAN	1	PZ	VT1292A0	XEBC-10EU-E EXTERNAL GLASS	1	PZ					
			Code	Description	Qty	UOM																																								
VM2385A1	LEFT MM DOOR UPPER LEFT CAP	1	PZ																																											
VM2386A1	LEFT MM DOOR LOWER LEFT CAP	1	PZ																																											
VM2410A0	PLATE TO STOP EXTRUDED LED BAR	4	PZ																																											
VM2417A0	PIN M10 DOOR CAP 6 SERIES MV	1	PZ																																											
VM2505A0	MM PLUS INTERNAL GLASS SUPPORT	5	PZ																																											
VM2518A0	BOARD COOLING FAN SUPPORT	1	PZ																																											
VN1179A1	CONTROL BOARD 40X40X20MM 12V COOLING FAN	1	PZ																																											
VT1292A0	XEBC-10EU-E EXTERNAL GLASS	1	PZ																																											
KDR1275B	BAKERTOP 10EU -M RIGHT EXTERNAL DOOR	<table border="1"> <thead> <tr> <th>Code</th> <th>Description</th> <th>Qty</th> <th>UOM</th> </tr> </thead> <tbody> <tr> <td>0B1126B0</td> <td></td> <td>1</td> <td>PZ</td> </tr> <tr> <td>0B1169A0</td> <td>XEBC-10EU-E LEFT EXT DOOR COLUM</td> <td>1</td> <td>PZ</td> </tr> <tr> <td>0B1170A2</td> <td>XEBC-10EU-E LEFT INT DOOR COLUM</td> <td>1</td> <td>PZ</td> </tr> <tr> <td>0B1171B0</td> <td></td> <td>1</td> <td>PZ</td> </tr> <tr> <td>0B1171B1</td> <td></td> <td>1</td> <td>PZ</td> </tr> <tr> <td>0B1172A2</td> <td>XEBC-10EU-E RIGHT INT DOOR COLUM</td> <td>1</td> <td>PZ</td> </tr> <tr> <td>0B1173A0</td> <td>EXT. GLASS SUPPORT PROFILE</td> <td>2</td> <td>PZ</td> </tr> <tr> <td>0B1218B0</td> <td></td> <td>1</td> <td>PZ</td> </tr> <tr> <td>0B1219A1</td> <td>MM DOUBLE GLASS DOOR INT UPPER BEAM 860</td> <td>1</td> <td>PZ</td> </tr> <tr> <td>0H7321A0</td> <td>MM STAINLESS STEEL HANDLE COVE</td> <td>1</td> <td>PZ</td> </tr> </tbody> </table>	Code	Description	Qty	UOM	0B1126B0		1	PZ	0B1169A0	XEBC-10EU-E LEFT EXT DOOR COLUM	1	PZ	0B1170A2	XEBC-10EU-E LEFT INT DOOR COLUM	1	PZ	0B1171B0		1	PZ	0B1171B1		1	PZ	0B1172A2	XEBC-10EU-E RIGHT INT DOOR COLUM	1	PZ	0B1173A0	EXT. GLASS SUPPORT PROFILE	2	PZ	0B1218B0		1	PZ	0B1219A1	MM DOUBLE GLASS DOOR INT UPPER BEAM 860	1	PZ	0H7321A0	MM STAINLESS STEEL HANDLE COVE	1	PZ
Code	Description	Qty	UOM																																											
0B1126B0		1	PZ																																											
0B1169A0	XEBC-10EU-E LEFT EXT DOOR COLUM	1	PZ																																											
0B1170A2	XEBC-10EU-E LEFT INT DOOR COLUM	1	PZ																																											
0B1171B0		1	PZ																																											
0B1171B1		1	PZ																																											
0B1172A2	XEBC-10EU-E RIGHT INT DOOR COLUM	1	PZ																																											
0B1173A0	EXT. GLASS SUPPORT PROFILE	2	PZ																																											
0B1218B0		1	PZ																																											
0B1219A1	MM DOUBLE GLASS DOOR INT UPPER BEAM 860	1	PZ																																											
0H7321A0	MM STAINLESS STEEL HANDLE COVE	1	PZ																																											

COMPONENT			SPARE PART																																																																						
Code	Description	Image	Code	Description	Components list																																																																				
VT1292A	XEBC-10EU-E EXTERNAL GLASS		KDR1275B	BAKERTOP 10EU -M RIGHT EXTERNAL DOOR	<table border="1"> <thead> <tr> <th>Code</th> <th>Description</th> <th>Qty</th> <th>UOM</th> </tr> </thead> <tbody> <tr> <td>CE1052A1</td> <td>CABLE CONNECTION CONTROL - USB MM 750M</td> <td>1</td> <td>PZ</td> </tr> <tr> <td>CE1053B0</td> <td>MM MICROFIT LED BAR POWER SUPPLY CABL</td> <td>1</td> <td>PZ</td> </tr> <tr> <td>CE1097A0</td> <td>4M SIHF 4 POLES MICROFIT CANBUS</td> <td>1</td> <td>PZ</td> </tr> <tr> <td>CE1285A0</td> <td>EMI ROUND FERRITE MOD.26438015 02</td> <td>1</td> <td>PZ</td> </tr> <tr> <td>IP1508A1</td> <td>POLYSTYREN E U SHAPED PROFILE 2000X60X60</td> <td>2</td> <td>M</td> </tr> <tr> <td>LP1022A0</td> <td>6 SERIES L600 LED LIGHT BAR - E903</td> <td>1</td> <td>PZ</td> </tr> <tr> <td>LP1028A0</td> <td>L=903 S6 NO LED LIGHT BAR COVER</td> <td>1</td> <td>PZ</td> </tr> <tr> <td>MG1099A1</td> <td></td> <td>1</td> <td>PZ</td> </tr> <tr> <td>RC1200A0</td> <td>ED=4 WIRE D.=0.5 COMPRESSIO N SPRING</td> <td>8</td> <td>PZ</td> </tr> <tr> <td>SL1155A1</td> <td>LOCTITE BICOMPONEN T SILICON</td> <td>100</td> <td>ML</td> </tr> <tr> <td>SL1170A1</td> <td>S57 BLACK SILICON - 310ML CARTRIDGE</td> <td>52</td> <td>ML</td> </tr> <tr> <td>VE1030A1</td> <td>MAGNET FOR DOOR MICROSWITC H D=22.9MM</td> <td>2</td> <td>PZ</td> </tr> <tr> <td>VI0239A1</td> <td>SELF-TAPPIN G SCREW 4.2X25 TCB+ INOX</td> <td>4</td> <td>PZ</td> </tr> <tr> <td>VI1103A0</td> <td>40X12 TBSP SCREW FOR PLASTIC</td> <td>2</td> <td>PZ</td> </tr> <tr> <td>VI1220A1</td> <td>4,2X12 TCB SELF-TAPPIN G SCREW</td> <td>29</td> <td>PZ</td> </tr> <tr> <td>VI1930A1</td> <td>ST. STEEL 5X20 CHIP SCREW</td> <td>16</td> <td>PZ</td> </tr> </tbody> </table>	Code	Description	Qty	UOM	CE1052A1	CABLE CONNECTION CONTROL - USB MM 750M	1	PZ	CE1053B0	MM MICROFIT LED BAR POWER SUPPLY CABL	1	PZ	CE1097A0	4M SIHF 4 POLES MICROFIT CANBUS	1	PZ	CE1285A0	EMI ROUND FERRITE MOD.26438015 02	1	PZ	IP1508A1	POLYSTYREN E U SHAPED PROFILE 2000X60X60	2	M	LP1022A0	6 SERIES L600 LED LIGHT BAR - E903	1	PZ	LP1028A0	L=903 S6 NO LED LIGHT BAR COVER	1	PZ	MG1099A1		1	PZ	RC1200A0	ED=4 WIRE D.=0.5 COMPRESSIO N SPRING	8	PZ	SL1155A1	LOCTITE BICOMPONEN T SILICON	100	ML	SL1170A1	S57 BLACK SILICON - 310ML CARTRIDGE	52	ML	VE1030A1	MAGNET FOR DOOR MICROSWITC H D=22.9MM	2	PZ	VI0239A1	SELF-TAPPIN G SCREW 4.2X25 TCB+ INOX	4	PZ	VI1103A0	40X12 TBSP SCREW FOR PLASTIC	2	PZ	VI1220A1	4,2X12 TCB SELF-TAPPIN G SCREW	29	PZ	VI1930A1	ST. STEEL 5X20 CHIP SCREW	16	PZ
Code	Description	Qty	UOM																																																																						
CE1052A1	CABLE CONNECTION CONTROL - USB MM 750M	1	PZ																																																																						
CE1053B0	MM MICROFIT LED BAR POWER SUPPLY CABL	1	PZ																																																																						
CE1097A0	4M SIHF 4 POLES MICROFIT CANBUS	1	PZ																																																																						
CE1285A0	EMI ROUND FERRITE MOD.26438015 02	1	PZ																																																																						
IP1508A1	POLYSTYREN E U SHAPED PROFILE 2000X60X60	2	M																																																																						
LP1022A0	6 SERIES L600 LED LIGHT BAR - E903	1	PZ																																																																						
LP1028A0	L=903 S6 NO LED LIGHT BAR COVER	1	PZ																																																																						
MG1099A1		1	PZ																																																																						
RC1200A0	ED=4 WIRE D.=0.5 COMPRESSIO N SPRING	8	PZ																																																																						
SL1155A1	LOCTITE BICOMPONEN T SILICON	100	ML																																																																						
SL1170A1	S57 BLACK SILICON - 310ML CARTRIDGE	52	ML																																																																						
VE1030A1	MAGNET FOR DOOR MICROSWITC H D=22.9MM	2	PZ																																																																						
VI0239A1	SELF-TAPPIN G SCREW 4.2X25 TCB+ INOX	4	PZ																																																																						
VI1103A0	40X12 TBSP SCREW FOR PLASTIC	2	PZ																																																																						
VI1220A1	4,2X12 TCB SELF-TAPPIN G SCREW	29	PZ																																																																						
VI1930A1	ST. STEEL 5X20 CHIP SCREW	16	PZ																																																																						



COMPONENT			SPARE PART																																																																																										
Code	Description	Image	Code	Description	Components list																																																																																								
VT1292A	XEBC-10EU-E EXTERNAL GLASS		KDR1275B	BAKERTOP 10EU -M RIGHT EXTERNAL DOOR	<table border="1"> <thead> <tr> <th>Code</th> <th>Description</th> <th>Qty</th> <th>UOM</th> </tr> </thead> <tbody> <tr> <td>VI1996A0</td> <td>M5X35 SCREW</td> <td>13</td> <td>PZ</td> </tr> <tr> <td>VM1059A1</td> <td>HEAT SHRINK FILM H800</td> <td>1.500</td> <td>M</td> </tr> <tr> <td>VM1182B1</td> <td>E.S. CT BT HANDLE JUNCTION + PIN GUIDE</td> <td>1</td> <td>PZ</td> </tr> <tr> <td>VM1490A0</td> <td>CHEFTOP/BAK ERTOP HANDLE SCREWS COVER</td> <td>2</td> <td>PZ</td> </tr> <tr> <td>VM1630A1</td> <td>INTERNAL GLASS PUSHING CAP</td> <td>5</td> <td>PZ</td> </tr> <tr> <td>VM1631A0</td> <td>PLUS INNER GLASS PUSHING CAP</td> <td>3</td> <td>PZ</td> </tr> <tr> <td>VM1695A0</td> <td>HANDLE POSITION PIN</td> <td>4</td> <td>PZ</td> </tr> <tr> <td>VM2245A0</td> <td>HANDLE SHAFT WITH LATCH</td> <td>1</td> <td>PZ</td> </tr> <tr> <td>VM2247B0</td> <td>HANDLE SHAFT COVER VM2245-2246</td> <td>1</td> <td>PZ</td> </tr> <tr> <td>VM2248B0</td> <td>HANDLE WITH LATCH CLOSING KEY</td> <td>1</td> <td>PZ</td> </tr> <tr> <td>VM2259B0</td> <td></td> <td>1</td> <td>PZ</td> </tr> <tr> <td>VM2260B0</td> <td>S6 LEFT UPPER CAP</td> <td>1</td> <td>PZ</td> </tr> <tr> <td>VM2261B0</td> <td></td> <td>1</td> <td>PZ</td> </tr> <tr> <td>VM2262B0</td> <td></td> <td>1</td> <td>PZ</td> </tr> <tr> <td>VM2267A0</td> <td>INTERNAL GLASS LOCKING SYSTEM SLIDER</td> <td>2</td> <td>PZ</td> </tr> <tr> <td>VM2268A0</td> <td>DOOR MAGNET COVER</td> <td>2</td> <td>PZ</td> </tr> <tr> <td>VM2269B0</td> <td>INNER GLASS FIXING CAP</td> <td>2</td> <td>PZ</td> </tr> <tr> <td>VM2274A0</td> <td>GROOVED BUSHING</td> <td>1</td> <td>PZ</td> </tr> <tr> <td>VM2275A0</td> <td>SMOOTH BUSHING</td> <td>1</td> <td>PZ</td> </tr> <tr> <td>VM2285B0</td> <td>860 SERIES DRIP PROFILE KIT</td> <td>1</td> <td>PZ</td> </tr> <tr> <td>VM2295A1</td> <td>MIND.MAPS TOUCH CONTROL STYLUS KIT</td> <td>1</td> <td>PZ</td> </tr> </tbody> </table>	Code	Description	Qty	UOM	VI1996A0	M5X35 SCREW	13	PZ	VM1059A1	HEAT SHRINK FILM H800	1.500	M	VM1182B1	E.S. CT BT HANDLE JUNCTION + PIN GUIDE	1	PZ	VM1490A0	CHEFTOP/BAK ERTOP HANDLE SCREWS COVER	2	PZ	VM1630A1	INTERNAL GLASS PUSHING CAP	5	PZ	VM1631A0	PLUS INNER GLASS PUSHING CAP	3	PZ	VM1695A0	HANDLE POSITION PIN	4	PZ	VM2245A0	HANDLE SHAFT WITH LATCH	1	PZ	VM2247B0	HANDLE SHAFT COVER VM2245-2246	1	PZ	VM2248B0	HANDLE WITH LATCH CLOSING KEY	1	PZ	VM2259B0		1	PZ	VM2260B0	S6 LEFT UPPER CAP	1	PZ	VM2261B0		1	PZ	VM2262B0		1	PZ	VM2267A0	INTERNAL GLASS LOCKING SYSTEM SLIDER	2	PZ	VM2268A0	DOOR MAGNET COVER	2	PZ	VM2269B0	INNER GLASS FIXING CAP	2	PZ	VM2274A0	GROOVED BUSHING	1	PZ	VM2275A0	SMOOTH BUSHING	1	PZ	VM2285B0	860 SERIES DRIP PROFILE KIT	1	PZ	VM2295A1	MIND.MAPS TOUCH CONTROL STYLUS KIT	1	PZ
Code	Description	Qty	UOM																																																																																										
VI1996A0	M5X35 SCREW	13	PZ																																																																																										
VM1059A1	HEAT SHRINK FILM H800	1.500	M																																																																																										
VM1182B1	E.S. CT BT HANDLE JUNCTION + PIN GUIDE	1	PZ																																																																																										
VM1490A0	CHEFTOP/BAK ERTOP HANDLE SCREWS COVER	2	PZ																																																																																										
VM1630A1	INTERNAL GLASS PUSHING CAP	5	PZ																																																																																										
VM1631A0	PLUS INNER GLASS PUSHING CAP	3	PZ																																																																																										
VM1695A0	HANDLE POSITION PIN	4	PZ																																																																																										
VM2245A0	HANDLE SHAFT WITH LATCH	1	PZ																																																																																										
VM2247B0	HANDLE SHAFT COVER VM2245-2246	1	PZ																																																																																										
VM2248B0	HANDLE WITH LATCH CLOSING KEY	1	PZ																																																																																										
VM2259B0		1	PZ																																																																																										
VM2260B0	S6 LEFT UPPER CAP	1	PZ																																																																																										
VM2261B0		1	PZ																																																																																										
VM2262B0		1	PZ																																																																																										
VM2267A0	INTERNAL GLASS LOCKING SYSTEM SLIDER	2	PZ																																																																																										
VM2268A0	DOOR MAGNET COVER	2	PZ																																																																																										
VM2269B0	INNER GLASS FIXING CAP	2	PZ																																																																																										
VM2274A0	GROOVED BUSHING	1	PZ																																																																																										
VM2275A0	SMOOTH BUSHING	1	PZ																																																																																										
VM2285B0	860 SERIES DRIP PROFILE KIT	1	PZ																																																																																										
VM2295A1	MIND.MAPS TOUCH CONTROL STYLUS KIT	1	PZ																																																																																										



COMPONENT			SPARE PART																																																																													
Code	Description	Image	Code	Description	Components list																																																																											
VT1292A	XEBC-10EU-E EXTERNAL GLASS		KDR1275B	BAKERTOP 10EU -M RIGHT EXTERNAL DOOR	<table border="1"> <thead> <tr> <th>Code</th> <th>Description</th> <th>Qty</th> <th>UOM</th> </tr> </thead> <tbody> <tr> <td>VM2305A0</td> <td>6 SERIES DOOR CAP FIXING PAWL</td> <td>14</td> <td>PZ</td> </tr> <tr> <td>VM2312A0</td> <td>6 S. DRIP PROFILE DRAIN LEFT PIPE</td> <td>1</td> <td>PZ</td> </tr> <tr> <td>VM2314A0</td> <td>6 S. DRIP PROFILE CAP</td> <td>1</td> <td>PZ</td> </tr> <tr> <td>VM2315B0</td> <td>S6 INTERNAL GLASS SUPPORT</td> <td>5</td> <td>PZ</td> </tr> <tr> <td>VM2410A0</td> <td>PLATE TO STOP EXTRUDED LED BAR</td> <td>4</td> <td>PZ</td> </tr> <tr> <td>VM2505B0</td> <td>MM PLUS INTERNAL GLASS SUPPORT</td> <td>3</td> <td>PZ</td> </tr> <tr> <td>VM2518A0</td> <td>BOARD COOLING FAN SUPPORT</td> <td>1</td> <td>PZ</td> </tr> <tr> <td>VN1179A1</td> <td>CONTROL BOARD 40X40X20MM 12V COOLING FAN</td> <td>1</td> <td>PZ</td> </tr> <tr> <td>VP1076A0</td> <td>PLUS ONE ZERO HANDLE PIN</td> <td>1</td> <td>PZ</td> </tr> <tr> <td>VP1080A0</td> <td>UPPER HINGE CAP FOR LOWER INNER GLASS</td> <td>1</td> <td>PZ</td> </tr> <tr> <td>VP1081A0</td> <td>UPPER HINGE CAP FOR UPPER INNER GLASS</td> <td>1</td> <td>PZ</td> </tr> <tr> <td>VT1292A0</td> <td>XEBC-10EU-E EXTERNAL GLASS</td> <td>1</td> <td>PZ</td> </tr> </tbody> </table>	Code	Description	Qty	UOM	VM2305A0	6 SERIES DOOR CAP FIXING PAWL	14	PZ	VM2312A0	6 S. DRIP PROFILE DRAIN LEFT PIPE	1	PZ	VM2314A0	6 S. DRIP PROFILE CAP	1	PZ	VM2315B0	S6 INTERNAL GLASS SUPPORT	5	PZ	VM2410A0	PLATE TO STOP EXTRUDED LED BAR	4	PZ	VM2505B0	MM PLUS INTERNAL GLASS SUPPORT	3	PZ	VM2518A0	BOARD COOLING FAN SUPPORT	1	PZ	VN1179A1	CONTROL BOARD 40X40X20MM 12V COOLING FAN	1	PZ	VP1076A0	PLUS ONE ZERO HANDLE PIN	1	PZ	VP1080A0	UPPER HINGE CAP FOR LOWER INNER GLASS	1	PZ	VP1081A0	UPPER HINGE CAP FOR UPPER INNER GLASS	1	PZ	VT1292A0	XEBC-10EU-E EXTERNAL GLASS	1	PZ	KDR1275A	BAKERTOP 10EU RIGHT EXTERNAL DOOR	<table border="1"> <thead> <tr> <th>Code</th> <th>Description</th> <th>Qty</th> <th>UOM</th> </tr> </thead> <tbody> <tr> <td>0B1126A0</td> <td>DOOR LOWER FRAME SHAPE 860 MM</td> <td>1</td> <td>PZ</td> </tr> <tr> <td>0B1126A1</td> <td></td> <td>1</td> <td>PZ</td> </tr> <tr> <td>0B1169A0</td> <td>XEBC-10EU-E LEFT EXT DOOR COLUM</td> <td>1</td> <td>PZ</td> </tr> <tr> <td>0B1170A2</td> <td>XEBC-10EU-E LEFT INT DOOR COLUM</td> <td>1</td> <td>PZ</td> </tr> </tbody> </table>	Code	Description	Qty	UOM	0B1126A0	DOOR LOWER FRAME SHAPE 860 MM	1	PZ	0B1126A1		1	PZ	0B1169A0	XEBC-10EU-E LEFT EXT DOOR COLUM	1	PZ	0B1170A2	XEBC-10EU-E LEFT INT DOOR COLUM	1	PZ
			Code	Description	Qty	UOM																																																																										
VM2305A0	6 SERIES DOOR CAP FIXING PAWL	14	PZ																																																																													
VM2312A0	6 S. DRIP PROFILE DRAIN LEFT PIPE	1	PZ																																																																													
VM2314A0	6 S. DRIP PROFILE CAP	1	PZ																																																																													
VM2315B0	S6 INTERNAL GLASS SUPPORT	5	PZ																																																																													
VM2410A0	PLATE TO STOP EXTRUDED LED BAR	4	PZ																																																																													
VM2505B0	MM PLUS INTERNAL GLASS SUPPORT	3	PZ																																																																													
VM2518A0	BOARD COOLING FAN SUPPORT	1	PZ																																																																													
VN1179A1	CONTROL BOARD 40X40X20MM 12V COOLING FAN	1	PZ																																																																													
VP1076A0	PLUS ONE ZERO HANDLE PIN	1	PZ																																																																													
VP1080A0	UPPER HINGE CAP FOR LOWER INNER GLASS	1	PZ																																																																													
VP1081A0	UPPER HINGE CAP FOR UPPER INNER GLASS	1	PZ																																																																													
VT1292A0	XEBC-10EU-E EXTERNAL GLASS	1	PZ																																																																													
Code	Description	Qty	UOM																																																																													
0B1126A0	DOOR LOWER FRAME SHAPE 860 MM	1	PZ																																																																													
0B1126A1		1	PZ																																																																													
0B1169A0	XEBC-10EU-E LEFT EXT DOOR COLUM	1	PZ																																																																													
0B1170A2	XEBC-10EU-E LEFT INT DOOR COLUM	1	PZ																																																																													

COMPONENT			SPARE PART																																																																														
Code	Description	Image	Code	Description	Components list																																																																												
VT1292A	XEBC-10EU-E EXTERNAL GLASS		KDR1275A	BAKERTOP 10EU RIGHT EXTERNAL DOOR	<table border="1"> <thead> <tr> <th>Code</th> <th>Description</th> <th>Qty</th> <th>UOM</th> </tr> </thead> <tbody> <tr> <td>0B1171A0</td> <td>XEBC-10EU-E RIGHT EXT DOOR COLUM</td> <td>1</td> <td>PZ</td> </tr> <tr> <td>0B1171B0</td> <td></td> <td>1</td> <td>PZ</td> </tr> <tr> <td>0B1171B1</td> <td></td> <td>1</td> <td>PZ</td> </tr> <tr> <td>0B1172A2</td> <td>XEBC-10EU-E RIGHT INT DOOR COLUM</td> <td>1</td> <td>PZ</td> </tr> <tr> <td>0B1173A0</td> <td>EXT. GLASS SUPPORT PROFILE</td> <td>2</td> <td>PZ</td> </tr> <tr> <td>0B1190A0</td> <td>PLATE TO STOP EXTRUDED LED BAR</td> <td>4</td> <td>PZ</td> </tr> <tr> <td>0B1218A0</td> <td>MM DOUBLE GLASS DOOR UPPER BEAM 860</td> <td>1</td> <td>PZ</td> </tr> <tr> <td>0B1218A1</td> <td></td> <td>1</td> <td>PZ</td> </tr> <tr> <td>0B1219A1</td> <td>MM DOUBLE GLASS DOOR INT UPPER BEAM 860</td> <td>1</td> <td>PZ</td> </tr> <tr> <td>0H7321A0</td> <td>MM STAINLESS STEEL HANDLE COVE</td> <td>1</td> <td>PZ</td> </tr> <tr> <td>CE1052A1</td> <td>CABLE CONNECTION CONTROL - USB MM 750M</td> <td>1</td> <td>PZ</td> </tr> <tr> <td>CE1053B0</td> <td>MM MICROFIT LED BAR POWER SUPPLY CABL</td> <td>1</td> <td>PZ</td> </tr> <tr> <td>CE1285A0</td> <td>EMI ROUND FERRITE MOD.26438015 02</td> <td>1</td> <td>PZ</td> </tr> <tr> <td>CE1290A0</td> <td>EXTRACTABL E FEMALE TERMINAL CPF 5/4</td> <td>1</td> <td>PZ</td> </tr> <tr> <td>CE1455A0</td> <td>TIP END FITTING</td> <td>4</td> <td>PZ</td> </tr> <tr> <td>CE1725A0</td> <td>ROBOTICS SILICON PIPE 4X0,5 MMQ</td> <td>4</td> <td>M</td> </tr> <tr> <td>CE1735A0</td> <td>MINIFIT FEMALE END FITTING</td> <td>4</td> <td>PZ</td> </tr> <tr> <td>CE1755A0</td> <td>4 WAYS MALE MINIFIT CONNECTOR</td> <td>1</td> <td>PZ</td> </tr> </tbody> </table>	Code	Description	Qty	UOM	0B1171A0	XEBC-10EU-E RIGHT EXT DOOR COLUM	1	PZ	0B1171B0		1	PZ	0B1171B1		1	PZ	0B1172A2	XEBC-10EU-E RIGHT INT DOOR COLUM	1	PZ	0B1173A0	EXT. GLASS SUPPORT PROFILE	2	PZ	0B1190A0	PLATE TO STOP EXTRUDED LED BAR	4	PZ	0B1218A0	MM DOUBLE GLASS DOOR UPPER BEAM 860	1	PZ	0B1218A1		1	PZ	0B1219A1	MM DOUBLE GLASS DOOR INT UPPER BEAM 860	1	PZ	0H7321A0	MM STAINLESS STEEL HANDLE COVE	1	PZ	CE1052A1	CABLE CONNECTION CONTROL - USB MM 750M	1	PZ	CE1053B0	MM MICROFIT LED BAR POWER SUPPLY CABL	1	PZ	CE1285A0	EMI ROUND FERRITE MOD.26438015 02	1	PZ	CE1290A0	EXTRACTABL E FEMALE TERMINAL CPF 5/4	1	PZ	CE1455A0	TIP END FITTING	4	PZ	CE1725A0	ROBOTICS SILICON PIPE 4X0,5 MMQ	4	M	CE1735A0	MINIFIT FEMALE END FITTING	4	PZ	CE1755A0	4 WAYS MALE MINIFIT CONNECTOR	1	PZ
Code	Description	Qty	UOM																																																																														
0B1171A0	XEBC-10EU-E RIGHT EXT DOOR COLUM	1	PZ																																																																														
0B1171B0		1	PZ																																																																														
0B1171B1		1	PZ																																																																														
0B1172A2	XEBC-10EU-E RIGHT INT DOOR COLUM	1	PZ																																																																														
0B1173A0	EXT. GLASS SUPPORT PROFILE	2	PZ																																																																														
0B1190A0	PLATE TO STOP EXTRUDED LED BAR	4	PZ																																																																														
0B1218A0	MM DOUBLE GLASS DOOR UPPER BEAM 860	1	PZ																																																																														
0B1218A1		1	PZ																																																																														
0B1219A1	MM DOUBLE GLASS DOOR INT UPPER BEAM 860	1	PZ																																																																														
0H7321A0	MM STAINLESS STEEL HANDLE COVE	1	PZ																																																																														
CE1052A1	CABLE CONNECTION CONTROL - USB MM 750M	1	PZ																																																																														
CE1053B0	MM MICROFIT LED BAR POWER SUPPLY CABL	1	PZ																																																																														
CE1285A0	EMI ROUND FERRITE MOD.26438015 02	1	PZ																																																																														
CE1290A0	EXTRACTABL E FEMALE TERMINAL CPF 5/4	1	PZ																																																																														
CE1455A0	TIP END FITTING	4	PZ																																																																														
CE1725A0	ROBOTICS SILICON PIPE 4X0,5 MMQ	4	M																																																																														
CE1735A0	MINIFIT FEMALE END FITTING	4	PZ																																																																														
CE1755A0	4 WAYS MALE MINIFIT CONNECTOR	1	PZ																																																																														

COMPONENT			SPARE PART																																																																														
Code	Description	Image	Code	Description	Components list																																																																												
VT1292A	XEBC-10EU-E EXTERNAL GLASS		KDR1275A	BAKERTOP 10EU RIGHT EXTERNAL DOOR	<table border="1"> <thead> <tr> <th>Code</th> <th>Description</th> <th>Qty</th> <th>UOM</th> </tr> </thead> <tbody> <tr> <td>IL1206C0</td> <td>968X1053 H126 XBC WOOD PALLE</td> <td>1</td> <td>PZ</td> </tr> <tr> <td>IL1206D0</td> <td></td> <td>1</td> <td>PZ</td> </tr> <tr> <td>IP1508A1</td> <td>POLYSTYREN E U SHAPED PROFILE 2000X60X60</td> <td>2</td> <td>M</td> </tr> <tr> <td>LP1022A0</td> <td>6 SERIES L600 LED LIGHT BAR - E903</td> <td>1</td> <td>PZ</td> </tr> <tr> <td>LP1028A0</td> <td>L=903 S6 NO LED LIGHT BAR COVER</td> <td>1</td> <td>PZ</td> </tr> <tr> <td>MG1083A2</td> <td></td> <td>1</td> <td>PZ</td> </tr> <tr> <td>RC1200A0</td> <td>ED=4 WIRE D.=0.5 COMPRESSIO N SPRING</td> <td>4</td> <td>PZ</td> </tr> <tr> <td>SL1170A1</td> <td>S57 BLACK SILICON - 310ML CARTRIDGE</td> <td>51</td> <td>ML</td> </tr> <tr> <td>VE1030A1</td> <td>MAGNET FOR DOOR MICROSWITC H D=22,9MM</td> <td>2</td> <td>PZ</td> </tr> <tr> <td>VI0239A1</td> <td>SELF-TAPPIN G SCREW 4.2X25 TCB+ INOX</td> <td>4</td> <td>PZ</td> </tr> <tr> <td>VI1220A1</td> <td>4,2X12 TCB SELF-TAPPIN G SCREW</td> <td>19</td> <td>PZ</td> </tr> <tr> <td>VI1930A0</td> <td>5X25 ST. STEEL SCREW CHIP</td> <td>16</td> <td>PZ</td> </tr> <tr> <td>VI1930A1</td> <td>ST. STEEL 5X20 CHIP SCREW</td> <td>16</td> <td>PZ</td> </tr> <tr> <td>VI1960A0</td> <td>SELF-TAPPIN G SCREW 4.2X11 TCBS+ AISI410</td> <td>10</td> <td>PZ</td> </tr> <tr> <td>VI1960A1</td> <td>4.2X9.5 CROSS ZN-NI SELF-THREADI NG SCREW</td> <td>10</td> <td>PZ</td> </tr> <tr> <td>VI1962A0</td> <td>ST. STEEL M10 BLIND NUT</td> <td>1</td> <td>PZ</td> </tr> <tr> <td>VI1996A0</td> <td>M5X35 SCREW</td> <td>13</td> <td>PZ</td> </tr> <tr> <td>VM1059A1</td> <td>HEAT SHRINK FILM H800</td> <td>1.500</td> <td>M</td> </tr> </tbody> </table>	Code	Description	Qty	UOM	IL1206C0	968X1053 H126 XBC WOOD PALLE	1	PZ	IL1206D0		1	PZ	IP1508A1	POLYSTYREN E U SHAPED PROFILE 2000X60X60	2	M	LP1022A0	6 SERIES L600 LED LIGHT BAR - E903	1	PZ	LP1028A0	L=903 S6 NO LED LIGHT BAR COVER	1	PZ	MG1083A2		1	PZ	RC1200A0	ED=4 WIRE D.=0.5 COMPRESSIO N SPRING	4	PZ	SL1170A1	S57 BLACK SILICON - 310ML CARTRIDGE	51	ML	VE1030A1	MAGNET FOR DOOR MICROSWITC H D=22,9MM	2	PZ	VI0239A1	SELF-TAPPIN G SCREW 4.2X25 TCB+ INOX	4	PZ	VI1220A1	4,2X12 TCB SELF-TAPPIN G SCREW	19	PZ	VI1930A0	5X25 ST. STEEL SCREW CHIP	16	PZ	VI1930A1	ST. STEEL 5X20 CHIP SCREW	16	PZ	VI1960A0	SELF-TAPPIN G SCREW 4.2X11 TCBS+ AISI410	10	PZ	VI1960A1	4.2X9.5 CROSS ZN-NI SELF-THREADI NG SCREW	10	PZ	VI1962A0	ST. STEEL M10 BLIND NUT	1	PZ	VI1996A0	M5X35 SCREW	13	PZ	VM1059A1	HEAT SHRINK FILM H800	1.500	M
Code	Description	Qty	UOM																																																																														
IL1206C0	968X1053 H126 XBC WOOD PALLE	1	PZ																																																																														
IL1206D0		1	PZ																																																																														
IP1508A1	POLYSTYREN E U SHAPED PROFILE 2000X60X60	2	M																																																																														
LP1022A0	6 SERIES L600 LED LIGHT BAR - E903	1	PZ																																																																														
LP1028A0	L=903 S6 NO LED LIGHT BAR COVER	1	PZ																																																																														
MG1083A2		1	PZ																																																																														
RC1200A0	ED=4 WIRE D.=0.5 COMPRESSIO N SPRING	4	PZ																																																																														
SL1170A1	S57 BLACK SILICON - 310ML CARTRIDGE	51	ML																																																																														
VE1030A1	MAGNET FOR DOOR MICROSWITC H D=22,9MM	2	PZ																																																																														
VI0239A1	SELF-TAPPIN G SCREW 4.2X25 TCB+ INOX	4	PZ																																																																														
VI1220A1	4,2X12 TCB SELF-TAPPIN G SCREW	19	PZ																																																																														
VI1930A0	5X25 ST. STEEL SCREW CHIP	16	PZ																																																																														
VI1930A1	ST. STEEL 5X20 CHIP SCREW	16	PZ																																																																														
VI1960A0	SELF-TAPPIN G SCREW 4.2X11 TCBS+ AISI410	10	PZ																																																																														
VI1960A1	4.2X9.5 CROSS ZN-NI SELF-THREADI NG SCREW	10	PZ																																																																														
VI1962A0	ST. STEEL M10 BLIND NUT	1	PZ																																																																														
VI1996A0	M5X35 SCREW	13	PZ																																																																														
VM1059A1	HEAT SHRINK FILM H800	1.500	M																																																																														



COMPONENT			SPARE PART																																																																										
Code	Description	Image	Code	Description	Components list																																																																								
VT1292A	XEBC-10EU-E EXTERNAL GLASS		KDR1275A	BAKERTOP 10EU RIGHT EXTERNAL DOOR	<table border="1"> <thead> <tr> <th>Code</th> <th>Description</th> <th>Qty</th> <th>UOM</th> </tr> </thead> <tbody> <tr> <td>VM1182B1</td> <td>E S. CT BT HANDLE JUNCTION + PIN GUIDE</td> <td>1</td> <td>PZ</td> </tr> <tr> <td>VM1183B0</td> <td>CHEFTOP/BAK ERTOP HANDLE PIN</td> <td>1</td> <td>PZ</td> </tr> <tr> <td>VM1183B1</td> <td>CT BT HANDLE PIN</td> <td>1</td> <td>PZ</td> </tr> <tr> <td>VM1183C0</td> <td>CT BT HANDLE T-SHAPED PIN KIT</td> <td>1</td> <td>PZ</td> </tr> <tr> <td>VM1183C1</td> <td>CT BT HANDLE T-SHAPED PIN KIT</td> <td>1</td> <td>PZ</td> </tr> <tr> <td>VM1490A0</td> <td>CHEFTOP/BAK ERTOP HANDLE SCREWS COVER</td> <td>2</td> <td>PZ</td> </tr> <tr> <td>VM1630A0</td> <td>INTERNAL GLASS PUSHING CAP</td> <td>5</td> <td>PZ</td> </tr> <tr> <td>VM1630A1</td> <td>INTERNAL GLASS PUSHING CAP</td> <td>5</td> <td>PZ</td> </tr> <tr> <td>VM1631A0</td> <td>PLUS INNER GLASS PUSHING CAP</td> <td>3</td> <td>PZ</td> </tr> <tr> <td>VM1695A0</td> <td>HANDLE POSITION PIN</td> <td>4</td> <td>PZ</td> </tr> <tr> <td>VM2245A0</td> <td>HANDLE SHAFT WITH LATCH</td> <td>1</td> <td>PZ</td> </tr> <tr> <td>VM2247A0</td> <td>HANDLE SHAFT COVER VM2245-2246</td> <td>1</td> <td>PZ</td> </tr> <tr> <td>VM2247B0</td> <td>HANDLE SHAFT COVER VM2245-2246</td> <td>1</td> <td>PZ</td> </tr> <tr> <td>VM2248B0</td> <td>HANDLE WITH LATCH CLOSING KEY</td> <td>1</td> <td>PZ</td> </tr> <tr> <td>VM2259A1</td> <td>6 SERIES DOOR LOWER LEFT CAP</td> <td>1</td> <td>PZ</td> </tr> <tr> <td>VM2260A1</td> <td>6 SERIES DOOR UPPER LEFT CAP</td> <td>1</td> <td>PZ</td> </tr> <tr> <td>VM2261A1</td> <td>6 SERIES DOOR LOWER RIGHT CAP</td> <td>1</td> <td>PZ</td> </tr> </tbody> </table>	Code	Description	Qty	UOM	VM1182B1	E S. CT BT HANDLE JUNCTION + PIN GUIDE	1	PZ	VM1183B0	CHEFTOP/BAK ERTOP HANDLE PIN	1	PZ	VM1183B1	CT BT HANDLE PIN	1	PZ	VM1183C0	CT BT HANDLE T-SHAPED PIN KIT	1	PZ	VM1183C1	CT BT HANDLE T-SHAPED PIN KIT	1	PZ	VM1490A0	CHEFTOP/BAK ERTOP HANDLE SCREWS COVER	2	PZ	VM1630A0	INTERNAL GLASS PUSHING CAP	5	PZ	VM1630A1	INTERNAL GLASS PUSHING CAP	5	PZ	VM1631A0	PLUS INNER GLASS PUSHING CAP	3	PZ	VM1695A0	HANDLE POSITION PIN	4	PZ	VM2245A0	HANDLE SHAFT WITH LATCH	1	PZ	VM2247A0	HANDLE SHAFT COVER VM2245-2246	1	PZ	VM2247B0	HANDLE SHAFT COVER VM2245-2246	1	PZ	VM2248B0	HANDLE WITH LATCH CLOSING KEY	1	PZ	VM2259A1	6 SERIES DOOR LOWER LEFT CAP	1	PZ	VM2260A1	6 SERIES DOOR UPPER LEFT CAP	1	PZ	VM2261A1	6 SERIES DOOR LOWER RIGHT CAP	1	PZ
Code	Description	Qty	UOM																																																																										
VM1182B1	E S. CT BT HANDLE JUNCTION + PIN GUIDE	1	PZ																																																																										
VM1183B0	CHEFTOP/BAK ERTOP HANDLE PIN	1	PZ																																																																										
VM1183B1	CT BT HANDLE PIN	1	PZ																																																																										
VM1183C0	CT BT HANDLE T-SHAPED PIN KIT	1	PZ																																																																										
VM1183C1	CT BT HANDLE T-SHAPED PIN KIT	1	PZ																																																																										
VM1490A0	CHEFTOP/BAK ERTOP HANDLE SCREWS COVER	2	PZ																																																																										
VM1630A0	INTERNAL GLASS PUSHING CAP	5	PZ																																																																										
VM1630A1	INTERNAL GLASS PUSHING CAP	5	PZ																																																																										
VM1631A0	PLUS INNER GLASS PUSHING CAP	3	PZ																																																																										
VM1695A0	HANDLE POSITION PIN	4	PZ																																																																										
VM2245A0	HANDLE SHAFT WITH LATCH	1	PZ																																																																										
VM2247A0	HANDLE SHAFT COVER VM2245-2246	1	PZ																																																																										
VM2247B0	HANDLE SHAFT COVER VM2245-2246	1	PZ																																																																										
VM2248B0	HANDLE WITH LATCH CLOSING KEY	1	PZ																																																																										
VM2259A1	6 SERIES DOOR LOWER LEFT CAP	1	PZ																																																																										
VM2260A1	6 SERIES DOOR UPPER LEFT CAP	1	PZ																																																																										
VM2261A1	6 SERIES DOOR LOWER RIGHT CAP	1	PZ																																																																										



COMPONENT			SPARE PART																																																																										
Code	Description	Image	Code	Description	Components list																																																																								
VT1292A	XEBC-10EU-E EXTERNAL GLASS		KDR1275A	BAKERTOP 10EU RIGHT EXTERNAL DOOR	<table border="1"> <thead> <tr> <th>Code</th> <th>Description</th> <th>Qty</th> <th>UOM</th> </tr> </thead> <tbody> <tr> <td>VM2262A1</td> <td>6 SERIES DOOR UPPER RIGHT CAP</td> <td>1</td> <td>PZ</td> </tr> <tr> <td>VM2267A0</td> <td>INTERNAL GLASS LOCKING SYSTEM SLIDER</td> <td>2</td> <td>PZ</td> </tr> <tr> <td>VM2268A0</td> <td>DOOR MAGNET COVER</td> <td>2</td> <td>PZ</td> </tr> <tr> <td>VM2269A0</td> <td>INTERNAL GLASS LOCKING SYSTEM CAP</td> <td>2</td> <td>PZ</td> </tr> <tr> <td>VM2274A0</td> <td>GROOVED BUSHING</td> <td>1</td> <td>PZ</td> </tr> <tr> <td>VM2275A0</td> <td>SMOOTH BUSHING</td> <td>1</td> <td>PZ</td> </tr> <tr> <td>VM2285A0</td> <td>860 SERIES DRIP PROFILE</td> <td>1</td> <td>PZ</td> </tr> <tr> <td>VM2295A0</td> <td>STYLUS PEN FOR MM</td> <td>1</td> <td>PZ</td> </tr> <tr> <td>VM2305A0</td> <td>6 SERIES DOOR CAP FIXING PAWL</td> <td>14</td> <td>PZ</td> </tr> <tr> <td>VM2312A0</td> <td>6 S. DRIP PROFILE DRAIN LEFT PIPE</td> <td>1</td> <td>PZ</td> </tr> <tr> <td>VM2313A0</td> <td>TUBE DX DISCHARGE DRIP MM</td> <td>1</td> <td>PZ</td> </tr> <tr> <td>VM2314A0</td> <td>6 S. DRIP PROFILE CAP</td> <td>1</td> <td>PZ</td> </tr> <tr> <td>VM2315A0</td> <td>MIND.MAPS INTERNAL GLASS CAP SUPPORT</td> <td>5</td> <td>PZ</td> </tr> <tr> <td>VM2371A0</td> <td>DOUBLE GLASS DOOR PUSHING BRACKET</td> <td>3</td> <td>PZ</td> </tr> <tr> <td>VM2371A0</td> <td>DOUBLE GLASS DOOR PUSHING BRACKET</td> <td>3</td> <td>PZ</td> </tr> <tr> <td>VM2410A0</td> <td>PLATE TO STOP EXTRUDED LED BAR</td> <td>4</td> <td>PZ</td> </tr> <tr> <td>VM2410A0</td> <td>PLATE TO STOP EXTRUDED LED BAR</td> <td>4</td> <td>PZ</td> </tr> </tbody> </table>	Code	Description	Qty	UOM	VM2262A1	6 SERIES DOOR UPPER RIGHT CAP	1	PZ	VM2267A0	INTERNAL GLASS LOCKING SYSTEM SLIDER	2	PZ	VM2268A0	DOOR MAGNET COVER	2	PZ	VM2269A0	INTERNAL GLASS LOCKING SYSTEM CAP	2	PZ	VM2274A0	GROOVED BUSHING	1	PZ	VM2275A0	SMOOTH BUSHING	1	PZ	VM2285A0	860 SERIES DRIP PROFILE	1	PZ	VM2295A0	STYLUS PEN FOR MM	1	PZ	VM2305A0	6 SERIES DOOR CAP FIXING PAWL	14	PZ	VM2312A0	6 S. DRIP PROFILE DRAIN LEFT PIPE	1	PZ	VM2313A0	TUBE DX DISCHARGE DRIP MM	1	PZ	VM2314A0	6 S. DRIP PROFILE CAP	1	PZ	VM2315A0	MIND.MAPS INTERNAL GLASS CAP SUPPORT	5	PZ	VM2371A0	DOUBLE GLASS DOOR PUSHING BRACKET	3	PZ	VM2371A0	DOUBLE GLASS DOOR PUSHING BRACKET	3	PZ	VM2410A0	PLATE TO STOP EXTRUDED LED BAR	4	PZ	VM2410A0	PLATE TO STOP EXTRUDED LED BAR	4	PZ
Code	Description	Qty	UOM																																																																										
VM2262A1	6 SERIES DOOR UPPER RIGHT CAP	1	PZ																																																																										
VM2267A0	INTERNAL GLASS LOCKING SYSTEM SLIDER	2	PZ																																																																										
VM2268A0	DOOR MAGNET COVER	2	PZ																																																																										
VM2269A0	INTERNAL GLASS LOCKING SYSTEM CAP	2	PZ																																																																										
VM2274A0	GROOVED BUSHING	1	PZ																																																																										
VM2275A0	SMOOTH BUSHING	1	PZ																																																																										
VM2285A0	860 SERIES DRIP PROFILE	1	PZ																																																																										
VM2295A0	STYLUS PEN FOR MM	1	PZ																																																																										
VM2305A0	6 SERIES DOOR CAP FIXING PAWL	14	PZ																																																																										
VM2312A0	6 S. DRIP PROFILE DRAIN LEFT PIPE	1	PZ																																																																										
VM2313A0	TUBE DX DISCHARGE DRIP MM	1	PZ																																																																										
VM2314A0	6 S. DRIP PROFILE CAP	1	PZ																																																																										
VM2315A0	MIND.MAPS INTERNAL GLASS CAP SUPPORT	5	PZ																																																																										
VM2371A0	DOUBLE GLASS DOOR PUSHING BRACKET	3	PZ																																																																										
VM2371A0	DOUBLE GLASS DOOR PUSHING BRACKET	3	PZ																																																																										
VM2410A0	PLATE TO STOP EXTRUDED LED BAR	4	PZ																																																																										
VM2410A0	PLATE TO STOP EXTRUDED LED BAR	4	PZ																																																																										





COMPONENT			SPARE PART																																										
Code	Description	Image	Code	Description	Components list																																								
VT1292A	XEBC-10EU-E EXTERNAL GLASS		KDR1275A	BAKERTOP 10EU RIGHT EXTERNAL DOOR	<table border="1"> <thead> <tr> <th>Code</th> <th>Description</th> <th>Qty</th> <th>UOM</th> </tr> </thead> <tbody> <tr> <td>VM2417A0</td> <td>PIN M10 DOOR CAP 6 SERIES MV</td> <td>1</td> <td>PZ</td> </tr> <tr> <td>VM2505A0</td> <td>MM PLUS INTERNAL GLASS SUPPORT</td> <td>3</td> <td>PZ</td> </tr> <tr> <td>VM2518A0</td> <td>BOARD COOLING FAN SUPPORT</td> <td>1</td> <td>PZ</td> </tr> <tr> <td>VM2518A0</td> <td>BOARD COOLING FAN SUPPORT</td> <td>1</td> <td>PZ</td> </tr> <tr> <td>VN1179A0</td> <td>CONTROL BOARD 40X40X20MM 12V COOLING FAN</td> <td>1</td> <td>PZ</td> </tr> <tr> <td>VN1179A0</td> <td>CONTROL BOARD 40X40X20MM 12V COOLING FAN</td> <td>1</td> <td>PZ</td> </tr> <tr> <td>VN1179A1</td> <td>CONTROL BOARD 40X40X20MM 12V COOLING FAN</td> <td>1</td> <td>PZ</td> </tr> <tr> <td>VT1292A0</td> <td>XEBC-10EU-E EXTERNAL GLASS</td> <td>1</td> <td>PZ</td> </tr> <tr> <td>VT1292A0</td> <td>XEBC-10EU-E EXTERNAL GLASS</td> <td>1</td> <td>PZ</td> </tr> </tbody> </table>	Code	Description	Qty	UOM	VM2417A0	PIN M10 DOOR CAP 6 SERIES MV	1	PZ	VM2505A0	MM PLUS INTERNAL GLASS SUPPORT	3	PZ	VM2518A0	BOARD COOLING FAN SUPPORT	1	PZ	VM2518A0	BOARD COOLING FAN SUPPORT	1	PZ	VN1179A0	CONTROL BOARD 40X40X20MM 12V COOLING FAN	1	PZ	VN1179A0	CONTROL BOARD 40X40X20MM 12V COOLING FAN	1	PZ	VN1179A1	CONTROL BOARD 40X40X20MM 12V COOLING FAN	1	PZ	VT1292A0	XEBC-10EU-E EXTERNAL GLASS	1	PZ	VT1292A0	XEBC-10EU-E EXTERNAL GLASS	1	PZ
			Code	Description	Qty	UOM																																							
VM2417A0	PIN M10 DOOR CAP 6 SERIES MV	1	PZ																																										
VM2505A0	MM PLUS INTERNAL GLASS SUPPORT	3	PZ																																										
VM2518A0	BOARD COOLING FAN SUPPORT	1	PZ																																										
VM2518A0	BOARD COOLING FAN SUPPORT	1	PZ																																										
VN1179A0	CONTROL BOARD 40X40X20MM 12V COOLING FAN	1	PZ																																										
VN1179A0	CONTROL BOARD 40X40X20MM 12V COOLING FAN	1	PZ																																										
VN1179A1	CONTROL BOARD 40X40X20MM 12V COOLING FAN	1	PZ																																										
VT1292A0	XEBC-10EU-E EXTERNAL GLASS	1	PZ																																										
VT1292A0	XEBC-10EU-E EXTERNAL GLASS	1	PZ																																										
KDR1274B	CHEFTOP 10FS-2/1 -M LEFT EXTERNAL DOOR	<table border="1"> <thead> <tr> <th>Code</th> <th>Description</th> <th>Qty</th> <th>UOM</th> </tr> </thead> <tbody> <tr> <td>0B1126B0</td> <td></td> <td>1</td> <td>PZ</td> </tr> <tr> <td>0B1173A0</td> <td>EXT. GLASS SUPPORT PROFILE</td> <td>2</td> <td>PZ</td> </tr> <tr> <td>0B1218B0</td> <td></td> <td>1</td> <td>PZ</td> </tr> <tr> <td>0B1219A1</td> <td>MM DOUBLE GLASS DOOR INT UPPER BEAM 860</td> <td>1</td> <td>PZ</td> </tr> <tr> <td>0B1221A2</td> <td>XEBC-10E LEFT - RIGHT INT DOOR COLUMN</td> <td>1</td> <td>PZ</td> </tr> <tr> <td>0B1222B0</td> <td></td> <td>1</td> <td>PZ</td> </tr> <tr> <td>0B1222B1</td> <td></td> <td>1</td> <td>PZ</td> </tr> <tr> <td>0B1223A2</td> <td>XEBC-10E LEFT - LEFT INT DOOR COLUMN</td> <td>1</td> <td>PZ</td> </tr> </tbody> </table>	Code	Description	Qty	UOM	0B1126B0		1	PZ	0B1173A0	EXT. GLASS SUPPORT PROFILE	2	PZ	0B1218B0		1	PZ	0B1219A1	MM DOUBLE GLASS DOOR INT UPPER BEAM 860	1	PZ	0B1221A2	XEBC-10E LEFT - RIGHT INT DOOR COLUMN	1	PZ	0B1222B0		1	PZ	0B1222B1		1	PZ	0B1223A2	XEBC-10E LEFT - LEFT INT DOOR COLUMN	1	PZ							
Code	Description	Qty	UOM																																										
0B1126B0		1	PZ																																										
0B1173A0	EXT. GLASS SUPPORT PROFILE	2	PZ																																										
0B1218B0		1	PZ																																										
0B1219A1	MM DOUBLE GLASS DOOR INT UPPER BEAM 860	1	PZ																																										
0B1221A2	XEBC-10E LEFT - RIGHT INT DOOR COLUMN	1	PZ																																										
0B1222B0		1	PZ																																										
0B1222B1		1	PZ																																										
0B1223A2	XEBC-10E LEFT - LEFT INT DOOR COLUMN	1	PZ																																										



COMPONENT			SPARE PART																																																																		
Code	Description	Image	Code	Description	Components list																																																																
VT1292A	XEBC-10EU-E EXTERNAL GLASS		KDR1274B	CHEFTOP 10FS-2/1 -M LEFT EXTERNAL DOOR	<table border="1"> <thead> <tr> <th>Code</th> <th>Description</th> <th>Qty</th> <th>UOM</th> </tr> </thead> <tbody> <tr> <td>0B1224A0</td> <td>XAVC-10F LEFT - RIGHT EXT DOOR COLUMN</td> <td>1</td> <td>PZ</td> </tr> <tr> <td>0H7321A0</td> <td>MM STAINLESS STEEL HANDLE COVE</td> <td>1</td> <td>PZ</td> </tr> <tr> <td>CE1052A1</td> <td>CABLE CONNECTION CONTROL - USB MM 750M</td> <td>1</td> <td>PZ</td> </tr> <tr> <td>CE1053B0</td> <td>MM MICROFIT LED BAR POWER SUPPLY CABL</td> <td>1</td> <td>PZ</td> </tr> <tr> <td>CE1097A0</td> <td>4M SIHF 4 POLES MICROFIT CANBUS</td> <td>1</td> <td>PZ</td> </tr> <tr> <td>CE1285A0</td> <td>EMI ROUND FERRITE MOD.26438015 02</td> <td>1</td> <td>PZ</td> </tr> <tr> <td>IP1508A1</td> <td>POLYSTYREN E U SHAPED PROFILE 2000X60X60</td> <td>2</td> <td>M</td> </tr> <tr> <td>LP1022A0</td> <td>6 SERIES L600 LED LIGHT BAR - E903</td> <td>1</td> <td>PZ</td> </tr> <tr> <td>LP1028A0</td> <td>L=903 S6 NO LED LIGHT BAR COVER</td> <td>1</td> <td>PZ</td> </tr> <tr> <td>MG1099A1</td> <td></td> <td>1</td> <td>PZ</td> </tr> <tr> <td>RC1200A0</td> <td>ED=4 WIRE D.=0.5 COMPRESSIO N SPRING</td> <td>8</td> <td>PZ</td> </tr> <tr> <td>SL1155A1</td> <td>LOCTITE BICOMPONEN T SILICON</td> <td>100</td> <td>ML</td> </tr> <tr> <td>SL1170A1</td> <td>S57 BLACK SILICON - 310ML CARTRIDGE</td> <td>52</td> <td>ML</td> </tr> <tr> <td>VE1030A1</td> <td>MAGNET FOR DOOR MICROSWITC H D=22.9MM</td> <td>2</td> <td>PZ</td> </tr> <tr> <td>VI0239A1</td> <td>SELF-TAPPIN G SCREW 4.2X25 TCB+ INOX</td> <td>4</td> <td>PZ</td> </tr> </tbody> </table>	Code	Description	Qty	UOM	0B1224A0	XAVC-10F LEFT - RIGHT EXT DOOR COLUMN	1	PZ	0H7321A0	MM STAINLESS STEEL HANDLE COVE	1	PZ	CE1052A1	CABLE CONNECTION CONTROL - USB MM 750M	1	PZ	CE1053B0	MM MICROFIT LED BAR POWER SUPPLY CABL	1	PZ	CE1097A0	4M SIHF 4 POLES MICROFIT CANBUS	1	PZ	CE1285A0	EMI ROUND FERRITE MOD.26438015 02	1	PZ	IP1508A1	POLYSTYREN E U SHAPED PROFILE 2000X60X60	2	M	LP1022A0	6 SERIES L600 LED LIGHT BAR - E903	1	PZ	LP1028A0	L=903 S6 NO LED LIGHT BAR COVER	1	PZ	MG1099A1		1	PZ	RC1200A0	ED=4 WIRE D.=0.5 COMPRESSIO N SPRING	8	PZ	SL1155A1	LOCTITE BICOMPONEN T SILICON	100	ML	SL1170A1	S57 BLACK SILICON - 310ML CARTRIDGE	52	ML	VE1030A1	MAGNET FOR DOOR MICROSWITC H D=22.9MM	2	PZ	VI0239A1	SELF-TAPPIN G SCREW 4.2X25 TCB+ INOX	4	PZ
Code	Description	Qty	UOM																																																																		
0B1224A0	XAVC-10F LEFT - RIGHT EXT DOOR COLUMN	1	PZ																																																																		
0H7321A0	MM STAINLESS STEEL HANDLE COVE	1	PZ																																																																		
CE1052A1	CABLE CONNECTION CONTROL - USB MM 750M	1	PZ																																																																		
CE1053B0	MM MICROFIT LED BAR POWER SUPPLY CABL	1	PZ																																																																		
CE1097A0	4M SIHF 4 POLES MICROFIT CANBUS	1	PZ																																																																		
CE1285A0	EMI ROUND FERRITE MOD.26438015 02	1	PZ																																																																		
IP1508A1	POLYSTYREN E U SHAPED PROFILE 2000X60X60	2	M																																																																		
LP1022A0	6 SERIES L600 LED LIGHT BAR - E903	1	PZ																																																																		
LP1028A0	L=903 S6 NO LED LIGHT BAR COVER	1	PZ																																																																		
MG1099A1		1	PZ																																																																		
RC1200A0	ED=4 WIRE D.=0.5 COMPRESSIO N SPRING	8	PZ																																																																		
SL1155A1	LOCTITE BICOMPONEN T SILICON	100	ML																																																																		
SL1170A1	S57 BLACK SILICON - 310ML CARTRIDGE	52	ML																																																																		
VE1030A1	MAGNET FOR DOOR MICROSWITC H D=22.9MM	2	PZ																																																																		
VI0239A1	SELF-TAPPIN G SCREW 4.2X25 TCB+ INOX	4	PZ																																																																		



COMPONENT			SPARE PART																																																																																		
Code	Description	Image	Code	Description	Components list																																																																																
VT1292A	XEBC-10EU-E EXTERNAL GLASS		KDR1274B	CHEFTOP 10FS-2/1 -M LEFT EXTERNAL DOOR	<table border="1"> <thead> <tr> <th>Code</th> <th>Description</th> <th>Qty</th> <th>UOM</th> </tr> </thead> <tbody> <tr> <td>VI1103A0</td> <td>40X12 TBSP SCREW FOR PLASTIC</td> <td>2</td> <td>PZ</td> </tr> <tr> <td>VI1220A1</td> <td>4,2X12 TCB SELF-TAPPIN G SCREW</td> <td>29</td> <td>PZ</td> </tr> <tr> <td>VI1930A1</td> <td>ST. STEEL 5X20 CHIP SCREW</td> <td>16</td> <td>PZ</td> </tr> <tr> <td>VI1996A0</td> <td>M5X35 SCREW</td> <td>13</td> <td>PZ</td> </tr> <tr> <td>VM1059A1</td> <td>HEAT SHRINK FILM H800</td> <td>1</td> <td>M</td> </tr> <tr> <td>VM1182B1</td> <td>E. S. CT BT HANDLE JUNCTION + PIN GUIDE</td> <td>1</td> <td>PZ</td> </tr> <tr> <td>VM1490A0</td> <td>CHEFTOP/BAK ERTOP HANDLE SCREWS COVER</td> <td>2</td> <td>PZ</td> </tr> <tr> <td>VM1630A1</td> <td>INTERNAL GLASS PUSHING CAP</td> <td>5</td> <td>PZ</td> </tr> <tr> <td>VM1631A0</td> <td>PLUS INNER GLASS PUSHING CAP</td> <td>3</td> <td>PZ</td> </tr> <tr> <td>VM1695A0</td> <td>HANDLE POSITION PIN</td> <td>4</td> <td>PZ</td> </tr> <tr> <td>VM2245A0</td> <td>HANDLE SHAFT WITH LATCH</td> <td>1</td> <td>PZ</td> </tr> <tr> <td>VM2247B0</td> <td>HANDLE SHAFT COVER VM2245-2246</td> <td>1</td> <td>PZ</td> </tr> <tr> <td>VM2248B0</td> <td>HANDLE WITH LATCH CLOSING KEY</td> <td>1</td> <td>PZ</td> </tr> <tr> <td>VM2267A0</td> <td>INTERNAL GLASS LOCKING SYSTEM SLIDER</td> <td>2</td> <td>PZ</td> </tr> <tr> <td>VM2268A0</td> <td>DOOR MAGNET COVER</td> <td>2</td> <td>PZ</td> </tr> <tr> <td>VM2269B0</td> <td>INNER GLASS FIXING CAP</td> <td>2</td> <td>PZ</td> </tr> <tr> <td>VM2274A0</td> <td>GROOVED BUSHING</td> <td>1</td> <td>PZ</td> </tr> <tr> <td>VM2275A0</td> <td>SMOOTH BUSHING</td> <td>1</td> <td>PZ</td> </tr> <tr> <td>VM2285B0</td> <td>860 SERIES DRIP PROFILE KIT</td> <td>1</td> <td>PZ</td> </tr> </tbody> </table>	Code	Description	Qty	UOM	VI1103A0	40X12 TBSP SCREW FOR PLASTIC	2	PZ	VI1220A1	4,2X12 TCB SELF-TAPPIN G SCREW	29	PZ	VI1930A1	ST. STEEL 5X20 CHIP SCREW	16	PZ	VI1996A0	M5X35 SCREW	13	PZ	VM1059A1	HEAT SHRINK FILM H800	1	M	VM1182B1	E. S. CT BT HANDLE JUNCTION + PIN GUIDE	1	PZ	VM1490A0	CHEFTOP/BAK ERTOP HANDLE SCREWS COVER	2	PZ	VM1630A1	INTERNAL GLASS PUSHING CAP	5	PZ	VM1631A0	PLUS INNER GLASS PUSHING CAP	3	PZ	VM1695A0	HANDLE POSITION PIN	4	PZ	VM2245A0	HANDLE SHAFT WITH LATCH	1	PZ	VM2247B0	HANDLE SHAFT COVER VM2245-2246	1	PZ	VM2248B0	HANDLE WITH LATCH CLOSING KEY	1	PZ	VM2267A0	INTERNAL GLASS LOCKING SYSTEM SLIDER	2	PZ	VM2268A0	DOOR MAGNET COVER	2	PZ	VM2269B0	INNER GLASS FIXING CAP	2	PZ	VM2274A0	GROOVED BUSHING	1	PZ	VM2275A0	SMOOTH BUSHING	1	PZ	VM2285B0	860 SERIES DRIP PROFILE KIT	1	PZ
Code	Description	Qty	UOM																																																																																		
VI1103A0	40X12 TBSP SCREW FOR PLASTIC	2	PZ																																																																																		
VI1220A1	4,2X12 TCB SELF-TAPPIN G SCREW	29	PZ																																																																																		
VI1930A1	ST. STEEL 5X20 CHIP SCREW	16	PZ																																																																																		
VI1996A0	M5X35 SCREW	13	PZ																																																																																		
VM1059A1	HEAT SHRINK FILM H800	1	M																																																																																		
VM1182B1	E. S. CT BT HANDLE JUNCTION + PIN GUIDE	1	PZ																																																																																		
VM1490A0	CHEFTOP/BAK ERTOP HANDLE SCREWS COVER	2	PZ																																																																																		
VM1630A1	INTERNAL GLASS PUSHING CAP	5	PZ																																																																																		
VM1631A0	PLUS INNER GLASS PUSHING CAP	3	PZ																																																																																		
VM1695A0	HANDLE POSITION PIN	4	PZ																																																																																		
VM2245A0	HANDLE SHAFT WITH LATCH	1	PZ																																																																																		
VM2247B0	HANDLE SHAFT COVER VM2245-2246	1	PZ																																																																																		
VM2248B0	HANDLE WITH LATCH CLOSING KEY	1	PZ																																																																																		
VM2267A0	INTERNAL GLASS LOCKING SYSTEM SLIDER	2	PZ																																																																																		
VM2268A0	DOOR MAGNET COVER	2	PZ																																																																																		
VM2269B0	INNER GLASS FIXING CAP	2	PZ																																																																																		
VM2274A0	GROOVED BUSHING	1	PZ																																																																																		
VM2275A0	SMOOTH BUSHING	1	PZ																																																																																		
VM2285B0	860 SERIES DRIP PROFILE KIT	1	PZ																																																																																		

COMPONENT			SPARE PART																																																																												
Code	Description	Image	Code	Description	Components list																																																																										
VT1292A	XEBC-10EU-E EXTERNAL GLASS		KDR1274B	CHEFTOP 10FS-2/1 -M LEFT EXTERNAL DOOR	<table border="1"> <thead> <tr> <th>Code</th> <th>Description</th> <th>Qty</th> <th>UOM</th> </tr> </thead> <tbody> <tr> <td>VM2295A1</td> <td>MIND.MAPS TOUCH CONTROL STYLUS KIT</td> <td>1</td> <td>PZ</td> </tr> <tr> <td>VM2305A0</td> <td>6 SERIES DOOR CAP FIXING PAWL</td> <td>14</td> <td>PZ</td> </tr> <tr> <td>VM2313A0</td> <td>TUBE DX DISCHARGE DRIP MM</td> <td>1</td> <td>PZ</td> </tr> <tr> <td>VM2314A0</td> <td>6 S. DRIP PROFILE CAP</td> <td>1</td> <td>PZ</td> </tr> <tr> <td>VM2315B0</td> <td>S6 INTERNAL GLASS SUPPORT</td> <td>5</td> <td>PZ</td> </tr> <tr> <td>VM2383B0</td> <td>S6 LEFT OVENS UPPER RIGHT CAP</td> <td>1</td> <td>PZ</td> </tr> <tr> <td>VM2384B0</td> <td></td> <td>1</td> <td>PZ</td> </tr> <tr> <td>VM2385B0</td> <td>S6 LEFT OVENS UPPER LEFT CAP</td> <td>1</td> <td>PZ</td> </tr> <tr> <td>VM2386B0</td> <td>MM -M LEFT DOOR LEFT LOWER CAP KI</td> <td>1</td> <td>PZ</td> </tr> <tr> <td>VM2410A0</td> <td>PLATE TO STOP EXTRUDED LED BAR</td> <td>4</td> <td>PZ</td> </tr> <tr> <td>VM2505B0</td> <td>MM PLUS INTERNAL GLASS SUPPORT</td> <td>3</td> <td>PZ</td> </tr> <tr> <td>VM2518A0</td> <td>BOARD COOLING FAN SUPPORT</td> <td>1</td> <td>PZ</td> </tr> <tr> <td>VN1179A1</td> <td>CONTROL BOARD 40X40X20MM 12V COOLING FAN</td> <td>1</td> <td>PZ</td> </tr> <tr> <td>VP1076A0</td> <td>PLUS ONE ZERO HANDLE PIN</td> <td>1</td> <td>PZ</td> </tr> <tr> <td>VP1080A0</td> <td>UPPER HINGE CAP FOR LOWER INNER GLASS</td> <td>1</td> <td>PZ</td> </tr> <tr> <td>VP1081A0</td> <td>UPPER HINGE CAP FOR UPPER INNER GLASS</td> <td>1</td> <td>PZ</td> </tr> <tr> <td>VT1292A0</td> <td>XEBC-10EU-E EXTERNAL GLASS</td> <td></td> <td></td> <td>1</td> <td>PZ</td> </tr> </tbody> </table>	Code	Description	Qty	UOM	VM2295A1	MIND.MAPS TOUCH CONTROL STYLUS KIT	1	PZ	VM2305A0	6 SERIES DOOR CAP FIXING PAWL	14	PZ	VM2313A0	TUBE DX DISCHARGE DRIP MM	1	PZ	VM2314A0	6 S. DRIP PROFILE CAP	1	PZ	VM2315B0	S6 INTERNAL GLASS SUPPORT	5	PZ	VM2383B0	S6 LEFT OVENS UPPER RIGHT CAP	1	PZ	VM2384B0		1	PZ	VM2385B0	S6 LEFT OVENS UPPER LEFT CAP	1	PZ	VM2386B0	MM -M LEFT DOOR LEFT LOWER CAP KI	1	PZ	VM2410A0	PLATE TO STOP EXTRUDED LED BAR	4	PZ	VM2505B0	MM PLUS INTERNAL GLASS SUPPORT	3	PZ	VM2518A0	BOARD COOLING FAN SUPPORT	1	PZ	VN1179A1	CONTROL BOARD 40X40X20MM 12V COOLING FAN	1	PZ	VP1076A0	PLUS ONE ZERO HANDLE PIN	1	PZ	VP1080A0	UPPER HINGE CAP FOR LOWER INNER GLASS	1	PZ	VP1081A0	UPPER HINGE CAP FOR UPPER INNER GLASS	1	PZ	VT1292A0	XEBC-10EU-E EXTERNAL GLASS			1	PZ
Code	Description	Qty	UOM																																																																												
VM2295A1	MIND.MAPS TOUCH CONTROL STYLUS KIT	1	PZ																																																																												
VM2305A0	6 SERIES DOOR CAP FIXING PAWL	14	PZ																																																																												
VM2313A0	TUBE DX DISCHARGE DRIP MM	1	PZ																																																																												
VM2314A0	6 S. DRIP PROFILE CAP	1	PZ																																																																												
VM2315B0	S6 INTERNAL GLASS SUPPORT	5	PZ																																																																												
VM2383B0	S6 LEFT OVENS UPPER RIGHT CAP	1	PZ																																																																												
VM2384B0		1	PZ																																																																												
VM2385B0	S6 LEFT OVENS UPPER LEFT CAP	1	PZ																																																																												
VM2386B0	MM -M LEFT DOOR LEFT LOWER CAP KI	1	PZ																																																																												
VM2410A0	PLATE TO STOP EXTRUDED LED BAR	4	PZ																																																																												
VM2505B0	MM PLUS INTERNAL GLASS SUPPORT	3	PZ																																																																												
VM2518A0	BOARD COOLING FAN SUPPORT	1	PZ																																																																												
VN1179A1	CONTROL BOARD 40X40X20MM 12V COOLING FAN	1	PZ																																																																												
VP1076A0	PLUS ONE ZERO HANDLE PIN	1	PZ																																																																												
VP1080A0	UPPER HINGE CAP FOR LOWER INNER GLASS	1	PZ																																																																												
VP1081A0	UPPER HINGE CAP FOR UPPER INNER GLASS	1	PZ																																																																												
VT1292A0	XEBC-10EU-E EXTERNAL GLASS			1	PZ																																																																										



COMPONENT			SPARE PART																																																																										
Code	Description	Image	Code	Description	Components list																																																																								
VT1292A	XEBC-10EU-E EXTERNAL GLASS		KDR1274A	CHEFTOP 10FS LEFT EXTERNAL DOOR	<table border="1"> <thead> <tr> <th>Code</th> <th>Description</th> <th>Qty</th> <th>UOM</th> </tr> </thead> <tbody> <tr> <td>0B1126A0</td> <td>DOOR LOWER FRAME SHAPE 860 MM</td> <td>1</td> <td>PZ</td> </tr> <tr> <td>0B1126A1</td> <td></td> <td>1</td> <td>PZ</td> </tr> <tr> <td>0B1173A0</td> <td>EXT. GLASS SUPPORT PROFILE</td> <td>2</td> <td>PZ</td> </tr> <tr> <td>0B1218A0</td> <td>MM DOUBLE GLASS DOOR UPPER BEAM 860</td> <td>1</td> <td>PZ</td> </tr> <tr> <td>0B1218A1</td> <td></td> <td>1</td> <td>PZ</td> </tr> <tr> <td>0B1219A1</td> <td>MM DOUBLE GLASS DOOR INT UPPER BEAM 860</td> <td>1</td> <td>PZ</td> </tr> <tr> <td>0B1221A2</td> <td>XEBC-10E LEFT - RIGHT INT DOOR COLUMN</td> <td>1</td> <td>PZ</td> </tr> <tr> <td>0B1222A0</td> <td>XEBC-10E LEFT - LEFT EXT DOOR COLUMN</td> <td>1</td> <td>PZ</td> </tr> <tr> <td>0B1222B0</td> <td></td> <td>1</td> <td>PZ</td> </tr> <tr> <td>0B1222B1</td> <td></td> <td>1</td> <td>PZ</td> </tr> <tr> <td>0B1223A2</td> <td>XEBC-10E LEFT - LEFT INT DOOR COLUMN</td> <td>1</td> <td>PZ</td> </tr> <tr> <td>0B1224A0</td> <td>XAVC-10F LEFT - RIGHT EXT DOOR COLUMN</td> <td>1</td> <td>PZ</td> </tr> <tr> <td>0H7321A0</td> <td>MM STAINLESS STEEL HANDLE COVE</td> <td>1</td> <td>PZ</td> </tr> <tr> <td>CE1052A1</td> <td>CABLE CONNECTION CONTROL - USB MM 750M</td> <td>1</td> <td>PZ</td> </tr> <tr> <td>CE1053B0</td> <td>MM MICROFIT LED BAR POWER SUPPLY CABL</td> <td>1</td> <td>PZ</td> </tr> <tr> <td>CE1285A0</td> <td>EMI ROUND FERRITE MOD.26438015 02</td> <td>1</td> <td>PZ</td> </tr> <tr> <td>CE1290A0</td> <td>EXTRACTABL E FEMALE TERMINAL CPF 5/4</td> <td>1</td> <td>PZ</td> </tr> </tbody> </table>	Code	Description	Qty	UOM	0B1126A0	DOOR LOWER FRAME SHAPE 860 MM	1	PZ	0B1126A1		1	PZ	0B1173A0	EXT. GLASS SUPPORT PROFILE	2	PZ	0B1218A0	MM DOUBLE GLASS DOOR UPPER BEAM 860	1	PZ	0B1218A1		1	PZ	0B1219A1	MM DOUBLE GLASS DOOR INT UPPER BEAM 860	1	PZ	0B1221A2	XEBC-10E LEFT - RIGHT INT DOOR COLUMN	1	PZ	0B1222A0	XEBC-10E LEFT - LEFT EXT DOOR COLUMN	1	PZ	0B1222B0		1	PZ	0B1222B1		1	PZ	0B1223A2	XEBC-10E LEFT - LEFT INT DOOR COLUMN	1	PZ	0B1224A0	XAVC-10F LEFT - RIGHT EXT DOOR COLUMN	1	PZ	0H7321A0	MM STAINLESS STEEL HANDLE COVE	1	PZ	CE1052A1	CABLE CONNECTION CONTROL - USB MM 750M	1	PZ	CE1053B0	MM MICROFIT LED BAR POWER SUPPLY CABL	1	PZ	CE1285A0	EMI ROUND FERRITE MOD.26438015 02	1	PZ	CE1290A0	EXTRACTABL E FEMALE TERMINAL CPF 5/4	1	PZ
Code	Description	Qty	UOM																																																																										
0B1126A0	DOOR LOWER FRAME SHAPE 860 MM	1	PZ																																																																										
0B1126A1		1	PZ																																																																										
0B1173A0	EXT. GLASS SUPPORT PROFILE	2	PZ																																																																										
0B1218A0	MM DOUBLE GLASS DOOR UPPER BEAM 860	1	PZ																																																																										
0B1218A1		1	PZ																																																																										
0B1219A1	MM DOUBLE GLASS DOOR INT UPPER BEAM 860	1	PZ																																																																										
0B1221A2	XEBC-10E LEFT - RIGHT INT DOOR COLUMN	1	PZ																																																																										
0B1222A0	XEBC-10E LEFT - LEFT EXT DOOR COLUMN	1	PZ																																																																										
0B1222B0		1	PZ																																																																										
0B1222B1		1	PZ																																																																										
0B1223A2	XEBC-10E LEFT - LEFT INT DOOR COLUMN	1	PZ																																																																										
0B1224A0	XAVC-10F LEFT - RIGHT EXT DOOR COLUMN	1	PZ																																																																										
0H7321A0	MM STAINLESS STEEL HANDLE COVE	1	PZ																																																																										
CE1052A1	CABLE CONNECTION CONTROL - USB MM 750M	1	PZ																																																																										
CE1053B0	MM MICROFIT LED BAR POWER SUPPLY CABL	1	PZ																																																																										
CE1285A0	EMI ROUND FERRITE MOD.26438015 02	1	PZ																																																																										
CE1290A0	EXTRACTABL E FEMALE TERMINAL CPF 5/4	1	PZ																																																																										



COMPONENT			SPARE PART																																																																														
Code	Description	Image	Code	Description	Components list																																																																												
VT1292A	XEBC-10EU-E EXTERNAL GLASS		KDR1274A	CHEFTOP 10FS LEFT EXTERNAL DOOR	<table border="1"> <thead> <tr> <th>Code</th> <th>Description</th> <th>Qty</th> <th>UOM</th> </tr> </thead> <tbody> <tr> <td>CE1455A0</td> <td>TIP END FITTING</td> <td>4</td> <td>PZ</td> </tr> <tr> <td>CE1725A0</td> <td>ROBOTICS SILICON PIPE 4X0,5 MMO</td> <td>4</td> <td>M</td> </tr> <tr> <td>CE1735A0</td> <td>MINIFIT FEMALE END FITTING</td> <td>4</td> <td>PZ</td> </tr> <tr> <td>CE1755A0</td> <td>4 WAYS MALE MINIFIT CONNECTOR</td> <td>1</td> <td>PZ</td> </tr> <tr> <td>IP1508A1</td> <td>POLYSTYREN E U SHAPED PROFILE 2000X60X60</td> <td>2</td> <td>M</td> </tr> <tr> <td>LP1022A0</td> <td>6 SERIES L600 LED LIGHT BAR - E903</td> <td>1</td> <td>PZ</td> </tr> <tr> <td>LP1028A0</td> <td>L=903 S6 NO LED LIGHT BAR COVER</td> <td>1</td> <td>PZ</td> </tr> <tr> <td>MG1083A2</td> <td></td> <td>1</td> <td>PZ</td> </tr> <tr> <td>RC1200A0</td> <td>ED=4 WIRE D.=0.5 COMPRESSIO N SPRING</td> <td>4</td> <td>PZ</td> </tr> <tr> <td>SL1170A1</td> <td>S57 BLACK SILICON - 310ML CARTRIDGE</td> <td>14</td> <td>ML</td> </tr> <tr> <td>VE1030A1</td> <td>MAGNET FOR DOOR MICROSWITC H D=22,9MM</td> <td>2</td> <td>PZ</td> </tr> <tr> <td>VI0239A1</td> <td>SELF-TAPPIN G SCREW 4.2X25 TCB+ INOX</td> <td>4</td> <td>PZ</td> </tr> <tr> <td>VI1220A1</td> <td>4,2X12 TCB SELF-TAPPIN G SCREW</td> <td>19</td> <td>PZ</td> </tr> <tr> <td>VI1930A0</td> <td>5X25 ST. STEEL SCREW CHIP</td> <td>16</td> <td>PZ</td> </tr> <tr> <td>VI1960A0</td> <td>SELF-TAPPIN G SCREW 4.2X11 TCBS+ AISI410</td> <td>10</td> <td>PZ</td> </tr> <tr> <td>VI1996A0</td> <td>M5X35 SCREW</td> <td>13</td> <td>PZ</td> </tr> <tr> <td>VM1059A1</td> <td>HEAT SHRINK FILM H800</td> <td>1.500</td> <td>M</td> </tr> <tr> <td>VM1182B1</td> <td>E.S. CT BT HANDLE JUNCTION + PIN GUIDE</td> <td>1</td> <td>PZ</td> </tr> </tbody> </table>	Code	Description	Qty	UOM	CE1455A0	TIP END FITTING	4	PZ	CE1725A0	ROBOTICS SILICON PIPE 4X0,5 MMO	4	M	CE1735A0	MINIFIT FEMALE END FITTING	4	PZ	CE1755A0	4 WAYS MALE MINIFIT CONNECTOR	1	PZ	IP1508A1	POLYSTYREN E U SHAPED PROFILE 2000X60X60	2	M	LP1022A0	6 SERIES L600 LED LIGHT BAR - E903	1	PZ	LP1028A0	L=903 S6 NO LED LIGHT BAR COVER	1	PZ	MG1083A2		1	PZ	RC1200A0	ED=4 WIRE D.=0.5 COMPRESSIO N SPRING	4	PZ	SL1170A1	S57 BLACK SILICON - 310ML CARTRIDGE	14	ML	VE1030A1	MAGNET FOR DOOR MICROSWITC H D=22,9MM	2	PZ	VI0239A1	SELF-TAPPIN G SCREW 4.2X25 TCB+ INOX	4	PZ	VI1220A1	4,2X12 TCB SELF-TAPPIN G SCREW	19	PZ	VI1930A0	5X25 ST. STEEL SCREW CHIP	16	PZ	VI1960A0	SELF-TAPPIN G SCREW 4.2X11 TCBS+ AISI410	10	PZ	VI1996A0	M5X35 SCREW	13	PZ	VM1059A1	HEAT SHRINK FILM H800	1.500	M	VM1182B1	E.S. CT BT HANDLE JUNCTION + PIN GUIDE	1	PZ
Code	Description	Qty	UOM																																																																														
CE1455A0	TIP END FITTING	4	PZ																																																																														
CE1725A0	ROBOTICS SILICON PIPE 4X0,5 MMO	4	M																																																																														
CE1735A0	MINIFIT FEMALE END FITTING	4	PZ																																																																														
CE1755A0	4 WAYS MALE MINIFIT CONNECTOR	1	PZ																																																																														
IP1508A1	POLYSTYREN E U SHAPED PROFILE 2000X60X60	2	M																																																																														
LP1022A0	6 SERIES L600 LED LIGHT BAR - E903	1	PZ																																																																														
LP1028A0	L=903 S6 NO LED LIGHT BAR COVER	1	PZ																																																																														
MG1083A2		1	PZ																																																																														
RC1200A0	ED=4 WIRE D.=0.5 COMPRESSIO N SPRING	4	PZ																																																																														
SL1170A1	S57 BLACK SILICON - 310ML CARTRIDGE	14	ML																																																																														
VE1030A1	MAGNET FOR DOOR MICROSWITC H D=22,9MM	2	PZ																																																																														
VI0239A1	SELF-TAPPIN G SCREW 4.2X25 TCB+ INOX	4	PZ																																																																														
VI1220A1	4,2X12 TCB SELF-TAPPIN G SCREW	19	PZ																																																																														
VI1930A0	5X25 ST. STEEL SCREW CHIP	16	PZ																																																																														
VI1960A0	SELF-TAPPIN G SCREW 4.2X11 TCBS+ AISI410	10	PZ																																																																														
VI1996A0	M5X35 SCREW	13	PZ																																																																														
VM1059A1	HEAT SHRINK FILM H800	1.500	M																																																																														
VM1182B1	E.S. CT BT HANDLE JUNCTION + PIN GUIDE	1	PZ																																																																														

COMPONENT			SPARE PART																																																																										
Code	Description	Image	Code	Description	Components list																																																																								
VT1292A	XEBC-10EU-E EXTERNAL GLASS		KDR1274A	CHEFTOP 10FS LEFT EXTERNAL DOOR	<table border="1"> <thead> <tr> <th>Code</th> <th>Description</th> <th>Qty</th> <th>UOM</th> </tr> </thead> <tbody> <tr> <td>VM1183B0</td> <td>CHEFTOP/BAK ERTOP HANDLE PIN</td> <td>1</td> <td>PZ</td> </tr> <tr> <td>VM1183B1</td> <td>CT BT HANDLE PIN</td> <td>1</td> <td>PZ</td> </tr> <tr> <td>VM1183C0</td> <td>CT BT HANDLE T-SHAPED PIN KIT</td> <td>1</td> <td>PZ</td> </tr> <tr> <td>VM1183C1</td> <td>CT BT HANDLE T-SHAPED PIN KIT</td> <td>1</td> <td>PZ</td> </tr> <tr> <td>VM1490A0</td> <td>CHEFTOP/BAK ERTOP HANDLE SCREWS COVER</td> <td>2</td> <td>PZ</td> </tr> <tr> <td>VM1630A0</td> <td>INTERNAL GLASS PUSHING CAP</td> <td>5</td> <td>PZ</td> </tr> <tr> <td>VM1630A1</td> <td>INTERNAL GLASS PUSHING CAP</td> <td>5</td> <td>PZ</td> </tr> <tr> <td>VM1631A0</td> <td>PLUS INNER GLASS PUSHING CAP</td> <td>3</td> <td>PZ</td> </tr> <tr> <td>VM1695A0</td> <td>HANDLE POSITION PIN</td> <td>4</td> <td>PZ</td> </tr> <tr> <td>VM2245A0</td> <td>HANDLE SHAFT WITH LATCH</td> <td>1</td> <td>PZ</td> </tr> <tr> <td>VM2247A0</td> <td>HANDLE SHAFT COVER VM2245-2246</td> <td>1</td> <td>PZ</td> </tr> <tr> <td>VM2247B0</td> <td>HANDLE SHAFT COVER VM2245-2246</td> <td>1</td> <td>PZ</td> </tr> <tr> <td>VM2248B0</td> <td>HANDLE WITH LATCH CLOSING KEY</td> <td>1</td> <td>PZ</td> </tr> <tr> <td>VM2267A0</td> <td>INTERNAL GLASS LOCKING SYSTEM SLIDER</td> <td>2</td> <td>PZ</td> </tr> <tr> <td>VM2268A0</td> <td>DOOR MAGNET COVER</td> <td>2</td> <td>PZ</td> </tr> <tr> <td>VM2269A0</td> <td>INTERNAL GLASS LOCKING SYSTEM CAP</td> <td>2</td> <td>PZ</td> </tr> <tr> <td>VM2274A0</td> <td>GROOVED BUSHING</td> <td>1</td> <td>PZ</td> </tr> </tbody> </table>	Code	Description	Qty	UOM	VM1183B0	CHEFTOP/BAK ERTOP HANDLE PIN	1	PZ	VM1183B1	CT BT HANDLE PIN	1	PZ	VM1183C0	CT BT HANDLE T-SHAPED PIN KIT	1	PZ	VM1183C1	CT BT HANDLE T-SHAPED PIN KIT	1	PZ	VM1490A0	CHEFTOP/BAK ERTOP HANDLE SCREWS COVER	2	PZ	VM1630A0	INTERNAL GLASS PUSHING CAP	5	PZ	VM1630A1	INTERNAL GLASS PUSHING CAP	5	PZ	VM1631A0	PLUS INNER GLASS PUSHING CAP	3	PZ	VM1695A0	HANDLE POSITION PIN	4	PZ	VM2245A0	HANDLE SHAFT WITH LATCH	1	PZ	VM2247A0	HANDLE SHAFT COVER VM2245-2246	1	PZ	VM2247B0	HANDLE SHAFT COVER VM2245-2246	1	PZ	VM2248B0	HANDLE WITH LATCH CLOSING KEY	1	PZ	VM2267A0	INTERNAL GLASS LOCKING SYSTEM SLIDER	2	PZ	VM2268A0	DOOR MAGNET COVER	2	PZ	VM2269A0	INTERNAL GLASS LOCKING SYSTEM CAP	2	PZ	VM2274A0	GROOVED BUSHING	1	PZ
Code	Description	Qty	UOM																																																																										
VM1183B0	CHEFTOP/BAK ERTOP HANDLE PIN	1	PZ																																																																										
VM1183B1	CT BT HANDLE PIN	1	PZ																																																																										
VM1183C0	CT BT HANDLE T-SHAPED PIN KIT	1	PZ																																																																										
VM1183C1	CT BT HANDLE T-SHAPED PIN KIT	1	PZ																																																																										
VM1490A0	CHEFTOP/BAK ERTOP HANDLE SCREWS COVER	2	PZ																																																																										
VM1630A0	INTERNAL GLASS PUSHING CAP	5	PZ																																																																										
VM1630A1	INTERNAL GLASS PUSHING CAP	5	PZ																																																																										
VM1631A0	PLUS INNER GLASS PUSHING CAP	3	PZ																																																																										
VM1695A0	HANDLE POSITION PIN	4	PZ																																																																										
VM2245A0	HANDLE SHAFT WITH LATCH	1	PZ																																																																										
VM2247A0	HANDLE SHAFT COVER VM2245-2246	1	PZ																																																																										
VM2247B0	HANDLE SHAFT COVER VM2245-2246	1	PZ																																																																										
VM2248B0	HANDLE WITH LATCH CLOSING KEY	1	PZ																																																																										
VM2267A0	INTERNAL GLASS LOCKING SYSTEM SLIDER	2	PZ																																																																										
VM2268A0	DOOR MAGNET COVER	2	PZ																																																																										
VM2269A0	INTERNAL GLASS LOCKING SYSTEM CAP	2	PZ																																																																										
VM2274A0	GROOVED BUSHING	1	PZ																																																																										





COMPONENT			SPARE PART																																																																														
Code	Description	Image	Code	Description	Components list																																																																												
VT1292A	XEBC-10EU-E EXTERNAL GLASS		KDR1274A	CHEFTOP 10FS LEFT EXTERNAL DOOR	<table border="1"> <thead> <tr> <th>Code</th> <th>Description</th> <th>Qty</th> <th>UOM</th> </tr> </thead> <tbody> <tr> <td>VM2275A0</td> <td>SMOOTH BUSHING</td> <td>1</td> <td>PZ</td> </tr> <tr> <td>VM2285A0</td> <td>860 SERIES DRIP PROFILE</td> <td>1</td> <td>PZ</td> </tr> <tr> <td>VM2295A0</td> <td>STYLUS PEN FOR MM</td> <td>1</td> <td>PZ</td> </tr> <tr> <td>VM2305A0</td> <td>6 SERIES DOOR CAP FIXING PAWL</td> <td>14</td> <td>PZ</td> </tr> <tr> <td>VM2312A0</td> <td>6 S. DRIP PROFILE DRAIN LEFT PIPE</td> <td>1</td> <td>PZ</td> </tr> <tr> <td>VM2313A0</td> <td>TUBE DX DISCHARGE DRIP MM</td> <td>1</td> <td>PZ</td> </tr> <tr> <td>VM2314A0</td> <td>6 S. DRIP PROFILE CAP</td> <td>2</td> <td>PZ</td> </tr> <tr> <td>VM2315A0</td> <td>MIND.MAPS INTERNAL GLASS CAP SUPPORT</td> <td>5</td> <td>PZ</td> </tr> <tr> <td>VM2371A0</td> <td>DOUBLE GLASS DOOR PUSHING BRACKET</td> <td>3</td> <td>PZ</td> </tr> <tr> <td>VM2371A0</td> <td>DOUBLE GLASS DOOR PUSHING BRACKET</td> <td>3</td> <td>PZ</td> </tr> <tr> <td>VM2383A0</td> <td>MM LEFT DOOR RIGHT UPPER CAP</td> <td>1</td> <td>PZ</td> </tr> <tr> <td>VM2383A0</td> <td>MM LEFT DOOR RIGHT UPPER CAP</td> <td>1</td> <td>PZ</td> </tr> <tr> <td>VM2384A0</td> <td>MM LEFT DOOR RIGHT LOWER CAP</td> <td>1</td> <td>PZ</td> </tr> <tr> <td>VM2384A0</td> <td>MM LEFT DOOR RIGHT LOWER CAP</td> <td>1</td> <td>PZ</td> </tr> <tr> <td>VM2385A1</td> <td>LEFT MM DOOR UPPER LEFT CAP</td> <td>1</td> <td>PZ</td> </tr> <tr> <td>VM2385A1</td> <td>LEFT MM DOOR UPPER LEFT CAP</td> <td>1</td> <td>PZ</td> </tr> <tr> <td>VM2386A1</td> <td>LEFT MM DOOR LOWER LEFT CAP</td> <td>1</td> <td>PZ</td> </tr> <tr> <td>VM2386A1</td> <td>LEFT MM DOOR LOWER LEFT CAP</td> <td>1</td> <td>PZ</td> </tr> </tbody> </table>	Code	Description	Qty	UOM	VM2275A0	SMOOTH BUSHING	1	PZ	VM2285A0	860 SERIES DRIP PROFILE	1	PZ	VM2295A0	STYLUS PEN FOR MM	1	PZ	VM2305A0	6 SERIES DOOR CAP FIXING PAWL	14	PZ	VM2312A0	6 S. DRIP PROFILE DRAIN LEFT PIPE	1	PZ	VM2313A0	TUBE DX DISCHARGE DRIP MM	1	PZ	VM2314A0	6 S. DRIP PROFILE CAP	2	PZ	VM2315A0	MIND.MAPS INTERNAL GLASS CAP SUPPORT	5	PZ	VM2371A0	DOUBLE GLASS DOOR PUSHING BRACKET	3	PZ	VM2371A0	DOUBLE GLASS DOOR PUSHING BRACKET	3	PZ	VM2383A0	MM LEFT DOOR RIGHT UPPER CAP	1	PZ	VM2383A0	MM LEFT DOOR RIGHT UPPER CAP	1	PZ	VM2384A0	MM LEFT DOOR RIGHT LOWER CAP	1	PZ	VM2384A0	MM LEFT DOOR RIGHT LOWER CAP	1	PZ	VM2385A1	LEFT MM DOOR UPPER LEFT CAP	1	PZ	VM2385A1	LEFT MM DOOR UPPER LEFT CAP	1	PZ	VM2386A1	LEFT MM DOOR LOWER LEFT CAP	1	PZ	VM2386A1	LEFT MM DOOR LOWER LEFT CAP	1	PZ
Code	Description	Qty	UOM																																																																														
VM2275A0	SMOOTH BUSHING	1	PZ																																																																														
VM2285A0	860 SERIES DRIP PROFILE	1	PZ																																																																														
VM2295A0	STYLUS PEN FOR MM	1	PZ																																																																														
VM2305A0	6 SERIES DOOR CAP FIXING PAWL	14	PZ																																																																														
VM2312A0	6 S. DRIP PROFILE DRAIN LEFT PIPE	1	PZ																																																																														
VM2313A0	TUBE DX DISCHARGE DRIP MM	1	PZ																																																																														
VM2314A0	6 S. DRIP PROFILE CAP	2	PZ																																																																														
VM2315A0	MIND.MAPS INTERNAL GLASS CAP SUPPORT	5	PZ																																																																														
VM2371A0	DOUBLE GLASS DOOR PUSHING BRACKET	3	PZ																																																																														
VM2371A0	DOUBLE GLASS DOOR PUSHING BRACKET	3	PZ																																																																														
VM2383A0	MM LEFT DOOR RIGHT UPPER CAP	1	PZ																																																																														
VM2383A0	MM LEFT DOOR RIGHT UPPER CAP	1	PZ																																																																														
VM2384A0	MM LEFT DOOR RIGHT LOWER CAP	1	PZ																																																																														
VM2384A0	MM LEFT DOOR RIGHT LOWER CAP	1	PZ																																																																														
VM2385A1	LEFT MM DOOR UPPER LEFT CAP	1	PZ																																																																														
VM2385A1	LEFT MM DOOR UPPER LEFT CAP	1	PZ																																																																														
VM2386A1	LEFT MM DOOR LOWER LEFT CAP	1	PZ																																																																														
VM2386A1	LEFT MM DOOR LOWER LEFT CAP	1	PZ																																																																														





COMPONENT			SPARE PART																																														
Code	Description	Image	Code	Description	Components list																																												
VT1292A	XEBC-10EU-E EXTERNAL GLASS		KDR1274A	CHEFTOP 10FS LEFT EXTERNAL DOOR	<table border="1"> <thead> <tr> <th>Code</th> <th>Description</th> <th>Qty</th> <th>UOM</th> </tr> </thead> <tbody> <tr> <td>VM2410A0</td> <td>PLATE TO STOP EXTRUDED LED BAR</td> <td>4</td> <td>PZ</td> </tr> <tr> <td>VM2410A0</td> <td>PLATE TO STOP EXTRUDED LED BAR</td> <td>4</td> <td>PZ</td> </tr> <tr> <td>VM2505A0</td> <td>MM PLUS INTERNAL GLASS SUPPORT</td> <td>3</td> <td>PZ</td> </tr> <tr> <td>VM2518A0</td> <td>BOARD COOLING FAN SUPPORT</td> <td>1</td> <td>PZ</td> </tr> <tr> <td>VM2518A0</td> <td>BOARD COOLING FAN SUPPORT</td> <td>1</td> <td>PZ</td> </tr> <tr> <td>VN1179A0</td> <td>CONTROL BOARD 40X40X20MM 12V COOLING FAN</td> <td>1</td> <td>PZ</td> </tr> <tr> <td>VN1179A0</td> <td>CONTROL BOARD 40X40X20MM 12V COOLING FAN</td> <td>1</td> <td>PZ</td> </tr> <tr> <td>VN1179A1</td> <td>CONTROL BOARD 40X40X20MM 12V COOLING FAN</td> <td>1</td> <td>PZ</td> </tr> <tr> <td>VT1292A0</td> <td>XEBC-10EU-E EXTERNAL GLASS</td> <td>1</td> <td>PZ</td> </tr> <tr> <td>VT1292A0</td> <td>XEBC-10EU-E EXTERNAL GLASS</td> <td>1</td> <td>PZ</td> </tr> </tbody> </table>	Code	Description	Qty	UOM	VM2410A0	PLATE TO STOP EXTRUDED LED BAR	4	PZ	VM2410A0	PLATE TO STOP EXTRUDED LED BAR	4	PZ	VM2505A0	MM PLUS INTERNAL GLASS SUPPORT	3	PZ	VM2518A0	BOARD COOLING FAN SUPPORT	1	PZ	VM2518A0	BOARD COOLING FAN SUPPORT	1	PZ	VN1179A0	CONTROL BOARD 40X40X20MM 12V COOLING FAN	1	PZ	VN1179A0	CONTROL BOARD 40X40X20MM 12V COOLING FAN	1	PZ	VN1179A1	CONTROL BOARD 40X40X20MM 12V COOLING FAN	1	PZ	VT1292A0	XEBC-10EU-E EXTERNAL GLASS	1	PZ	VT1292A0	XEBC-10EU-E EXTERNAL GLASS	1	PZ
			Code	Description	Qty	UOM																																											
VM2410A0	PLATE TO STOP EXTRUDED LED BAR	4	PZ																																														
VM2410A0	PLATE TO STOP EXTRUDED LED BAR	4	PZ																																														
VM2505A0	MM PLUS INTERNAL GLASS SUPPORT	3	PZ																																														
VM2518A0	BOARD COOLING FAN SUPPORT	1	PZ																																														
VM2518A0	BOARD COOLING FAN SUPPORT	1	PZ																																														
VN1179A0	CONTROL BOARD 40X40X20MM 12V COOLING FAN	1	PZ																																														
VN1179A0	CONTROL BOARD 40X40X20MM 12V COOLING FAN	1	PZ																																														
VN1179A1	CONTROL BOARD 40X40X20MM 12V COOLING FAN	1	PZ																																														
VT1292A0	XEBC-10EU-E EXTERNAL GLASS	1	PZ																																														
VT1292A0	XEBC-10EU-E EXTERNAL GLASS	1	PZ																																														
KDR1271B	CHEFTOP 10FS-2/1 -M RIGHT EXTERNAL DOOR	<table border="1"> <thead> <tr> <th>Code</th> <th>Description</th> <th>Qty</th> <th>UOM</th> </tr> </thead> <tbody> <tr> <td>0B1126B0</td> <td></td> <td>1</td> <td>PZ</td> </tr> <tr> <td>0B1170A2</td> <td>XEBC-10EU-E LEFT INT DOOR COLUM</td> <td>1</td> <td>PZ</td> </tr> <tr> <td>0B1171B0</td> <td></td> <td>1</td> <td>PZ</td> </tr> <tr> <td>0B1171B1</td> <td></td> <td>1</td> <td>PZ</td> </tr> <tr> <td>0B1172A2</td> <td>XEBC-10EU-E RIGHT INT DOOR COLUM</td> <td>1</td> <td>PZ</td> </tr> <tr> <td>0B1173A0</td> <td>EXT. GLASS SUPPORT PROFILE</td> <td>2</td> <td>PZ</td> </tr> </tbody> </table>	Code	Description	Qty	UOM	0B1126B0		1	PZ	0B1170A2	XEBC-10EU-E LEFT INT DOOR COLUM	1	PZ	0B1171B0		1	PZ	0B1171B1		1	PZ	0B1172A2	XEBC-10EU-E RIGHT INT DOOR COLUM	1	PZ	0B1173A0	EXT. GLASS SUPPORT PROFILE	2	PZ																			
Code	Description	Qty	UOM																																														
0B1126B0		1	PZ																																														
0B1170A2	XEBC-10EU-E LEFT INT DOOR COLUM	1	PZ																																														
0B1171B0		1	PZ																																														
0B1171B1		1	PZ																																														
0B1172A2	XEBC-10EU-E RIGHT INT DOOR COLUM	1	PZ																																														
0B1173A0	EXT. GLASS SUPPORT PROFILE	2	PZ																																														

COMPONENT			SPARE PART																																																																						
Code	Description	Image	Code	Description	Components list																																																																				
VT1292A	XEBC-10EU-E EXTERNAL GLASS		KDR1271B	CHEFTOP 10FS-2/1 -M RIGHT EXTERNAL DOOR	<table border="1"> <thead> <tr> <th>Code</th> <th>Description</th> <th>Qty</th> <th>UOM</th> </tr> </thead> <tbody> <tr> <td>0B1176A0</td> <td>XAVC-10FS-E LEFT EXT DOOR COLUM</td> <td>1</td> <td>PZ</td> </tr> <tr> <td>0B1218B0</td> <td></td> <td>1</td> <td>PZ</td> </tr> <tr> <td>0B1219A1</td> <td>MM DOUBLE GLASS DOOR INT UPPER BEAM 860</td> <td>1</td> <td>PZ</td> </tr> <tr> <td>0H7321A0</td> <td>MM STAINLESS STEEL HANDLE COVE</td> <td>1</td> <td>PZ</td> </tr> <tr> <td>CE1052A1</td> <td>CABLE CONNECTION CONTROL - USB MM 750M</td> <td>1</td> <td>PZ</td> </tr> <tr> <td>CE1053B0</td> <td>MM MICROFIT LED BAR POWER SUPPLY CABL</td> <td>1</td> <td>PZ</td> </tr> <tr> <td>CE1097A0</td> <td>4M SIHF 4 POLES MICROFIT CANBUS</td> <td>1</td> <td>PZ</td> </tr> <tr> <td>CE1285A0</td> <td>EMI ROUND FERRITE MOD.26438015 02</td> <td>1</td> <td>PZ</td> </tr> <tr> <td>IP1508A1</td> <td>POLYSTYREN E U SHAPED PROFILE 2000X60X60</td> <td>2</td> <td>M</td> </tr> <tr> <td>LP1022A0</td> <td>6 SERIES L600 LED LIGHT BAR - E903</td> <td>1</td> <td>PZ</td> </tr> <tr> <td>LP1028A0</td> <td>L=903 S6 NO LED LIGHT BAR COVER</td> <td>1</td> <td>PZ</td> </tr> <tr> <td>MG1099A1</td> <td></td> <td>1</td> <td>PZ</td> </tr> <tr> <td>RC1200A0</td> <td>ED=4 WIRE D.=0.5 COMPRESSIO N SPRING</td> <td>8</td> <td>PZ</td> </tr> <tr> <td>SL1155A1</td> <td>LOCTITE BICOMPONEN T SILICON</td> <td>100</td> <td>ML</td> </tr> <tr> <td>SL1170A1</td> <td>S57 BLACK SILICON - 310ML CARTRIDGE</td> <td>52</td> <td>ML</td> </tr> <tr> <td>VE1030A1</td> <td>MAGNET FOR DOOR MICROSWITC H D=22,9MM</td> <td>2</td> <td>PZ</td> </tr> </tbody> </table>	Code	Description	Qty	UOM	0B1176A0	XAVC-10FS-E LEFT EXT DOOR COLUM	1	PZ	0B1218B0		1	PZ	0B1219A1	MM DOUBLE GLASS DOOR INT UPPER BEAM 860	1	PZ	0H7321A0	MM STAINLESS STEEL HANDLE COVE	1	PZ	CE1052A1	CABLE CONNECTION CONTROL - USB MM 750M	1	PZ	CE1053B0	MM MICROFIT LED BAR POWER SUPPLY CABL	1	PZ	CE1097A0	4M SIHF 4 POLES MICROFIT CANBUS	1	PZ	CE1285A0	EMI ROUND FERRITE MOD.26438015 02	1	PZ	IP1508A1	POLYSTYREN E U SHAPED PROFILE 2000X60X60	2	M	LP1022A0	6 SERIES L600 LED LIGHT BAR - E903	1	PZ	LP1028A0	L=903 S6 NO LED LIGHT BAR COVER	1	PZ	MG1099A1		1	PZ	RC1200A0	ED=4 WIRE D.=0.5 COMPRESSIO N SPRING	8	PZ	SL1155A1	LOCTITE BICOMPONEN T SILICON	100	ML	SL1170A1	S57 BLACK SILICON - 310ML CARTRIDGE	52	ML	VE1030A1	MAGNET FOR DOOR MICROSWITC H D=22,9MM	2	PZ
Code	Description	Qty	UOM																																																																						
0B1176A0	XAVC-10FS-E LEFT EXT DOOR COLUM	1	PZ																																																																						
0B1218B0		1	PZ																																																																						
0B1219A1	MM DOUBLE GLASS DOOR INT UPPER BEAM 860	1	PZ																																																																						
0H7321A0	MM STAINLESS STEEL HANDLE COVE	1	PZ																																																																						
CE1052A1	CABLE CONNECTION CONTROL - USB MM 750M	1	PZ																																																																						
CE1053B0	MM MICROFIT LED BAR POWER SUPPLY CABL	1	PZ																																																																						
CE1097A0	4M SIHF 4 POLES MICROFIT CANBUS	1	PZ																																																																						
CE1285A0	EMI ROUND FERRITE MOD.26438015 02	1	PZ																																																																						
IP1508A1	POLYSTYREN E U SHAPED PROFILE 2000X60X60	2	M																																																																						
LP1022A0	6 SERIES L600 LED LIGHT BAR - E903	1	PZ																																																																						
LP1028A0	L=903 S6 NO LED LIGHT BAR COVER	1	PZ																																																																						
MG1099A1		1	PZ																																																																						
RC1200A0	ED=4 WIRE D.=0.5 COMPRESSIO N SPRING	8	PZ																																																																						
SL1155A1	LOCTITE BICOMPONEN T SILICON	100	ML																																																																						
SL1170A1	S57 BLACK SILICON - 310ML CARTRIDGE	52	ML																																																																						
VE1030A1	MAGNET FOR DOOR MICROSWITC H D=22,9MM	2	PZ																																																																						

COMPONENT			SPARE PART																																																																																						
Code	Description	Image	Code	Description	Components list																																																																																				
VT1292A	XEBC-10EU-E EXTERNAL GLASS		KDR1271B	CHEFTOP 10FS-2/1 -M RIGHT EXTERNAL DOOR	<table border="1"> <thead> <tr> <th>Code</th> <th>Description</th> <th>Qty</th> <th>UOM</th> </tr> </thead> <tbody> <tr> <td>VI0239A1</td> <td>SELF-TAPPIN G SCREW 4.2X25 TCB+ INOX</td> <td>4</td> <td>PZ</td> </tr> <tr> <td>VI1103A0</td> <td>40X12 TBSP SCREW FOR PLASTIC</td> <td>2</td> <td>PZ</td> </tr> <tr> <td>VI1220A1</td> <td>4,2X12 TCB SELF-TAPPIN G SCREW</td> <td>29</td> <td>PZ</td> </tr> <tr> <td>VI1930A1</td> <td>ST. STEEL 5X20 CHIP SCREW</td> <td>16</td> <td>PZ</td> </tr> <tr> <td>VI1996A0</td> <td>M5X35 SCREW</td> <td>13</td> <td>PZ</td> </tr> <tr> <td>VM1059A1</td> <td>HEAT SHRINK FILM H800</td> <td>1</td> <td>M</td> </tr> <tr> <td>VM1182B1</td> <td>E. S. CT BT HANDLE JUNCTION + PIN GUIDE</td> <td>1</td> <td>PZ</td> </tr> <tr> <td>VM1490A0</td> <td>CHEFTOP/BAK ERTOP HANDLE SCREWS COVER</td> <td>2</td> <td>PZ</td> </tr> <tr> <td>VM1630A1</td> <td>INTERNAL GLASS PUSHING CAP</td> <td>5</td> <td>PZ</td> </tr> <tr> <td>VM1631A0</td> <td>PLUS INNER GLASS PUSHING CAP</td> <td>3</td> <td>PZ</td> </tr> <tr> <td>VM1695A0</td> <td>HANDLE POSITION PIN</td> <td>4</td> <td>PZ</td> </tr> <tr> <td>VM2245A0</td> <td>HANDLE SHAFT WITH LATCH</td> <td>1</td> <td>PZ</td> </tr> <tr> <td>VM2247B0</td> <td>HANDLE SHAFT COVER VM2245-2246</td> <td>1</td> <td>PZ</td> </tr> <tr> <td>VM2248B0</td> <td>HANDLE WITH LATCH CLOSING KEY</td> <td>1</td> <td>PZ</td> </tr> <tr> <td>VM2259B0</td> <td></td> <td>1</td> <td>PZ</td> </tr> <tr> <td>VM2260B0</td> <td>S6 LEFT UPPER CAP</td> <td>1</td> <td>PZ</td> </tr> <tr> <td>VM2261B0</td> <td></td> <td>1</td> <td>PZ</td> </tr> <tr> <td>VM2262B0</td> <td></td> <td>1</td> <td>PZ</td> </tr> <tr> <td>VM2267A0</td> <td>INTERNAL GLASS LOCKING SYSTEM SLIDER</td> <td>2</td> <td>PZ</td> </tr> <tr> <td>VM2268A0</td> <td>DOOR MAGNET COVER</td> <td>2</td> <td>PZ</td> </tr> </tbody> </table>	Code	Description	Qty	UOM	VI0239A1	SELF-TAPPIN G SCREW 4.2X25 TCB+ INOX	4	PZ	VI1103A0	40X12 TBSP SCREW FOR PLASTIC	2	PZ	VI1220A1	4,2X12 TCB SELF-TAPPIN G SCREW	29	PZ	VI1930A1	ST. STEEL 5X20 CHIP SCREW	16	PZ	VI1996A0	M5X35 SCREW	13	PZ	VM1059A1	HEAT SHRINK FILM H800	1	M	VM1182B1	E. S. CT BT HANDLE JUNCTION + PIN GUIDE	1	PZ	VM1490A0	CHEFTOP/BAK ERTOP HANDLE SCREWS COVER	2	PZ	VM1630A1	INTERNAL GLASS PUSHING CAP	5	PZ	VM1631A0	PLUS INNER GLASS PUSHING CAP	3	PZ	VM1695A0	HANDLE POSITION PIN	4	PZ	VM2245A0	HANDLE SHAFT WITH LATCH	1	PZ	VM2247B0	HANDLE SHAFT COVER VM2245-2246	1	PZ	VM2248B0	HANDLE WITH LATCH CLOSING KEY	1	PZ	VM2259B0		1	PZ	VM2260B0	S6 LEFT UPPER CAP	1	PZ	VM2261B0		1	PZ	VM2262B0		1	PZ	VM2267A0	INTERNAL GLASS LOCKING SYSTEM SLIDER	2	PZ	VM2268A0	DOOR MAGNET COVER	2	PZ
Code	Description	Qty	UOM																																																																																						
VI0239A1	SELF-TAPPIN G SCREW 4.2X25 TCB+ INOX	4	PZ																																																																																						
VI1103A0	40X12 TBSP SCREW FOR PLASTIC	2	PZ																																																																																						
VI1220A1	4,2X12 TCB SELF-TAPPIN G SCREW	29	PZ																																																																																						
VI1930A1	ST. STEEL 5X20 CHIP SCREW	16	PZ																																																																																						
VI1996A0	M5X35 SCREW	13	PZ																																																																																						
VM1059A1	HEAT SHRINK FILM H800	1	M																																																																																						
VM1182B1	E. S. CT BT HANDLE JUNCTION + PIN GUIDE	1	PZ																																																																																						
VM1490A0	CHEFTOP/BAK ERTOP HANDLE SCREWS COVER	2	PZ																																																																																						
VM1630A1	INTERNAL GLASS PUSHING CAP	5	PZ																																																																																						
VM1631A0	PLUS INNER GLASS PUSHING CAP	3	PZ																																																																																						
VM1695A0	HANDLE POSITION PIN	4	PZ																																																																																						
VM2245A0	HANDLE SHAFT WITH LATCH	1	PZ																																																																																						
VM2247B0	HANDLE SHAFT COVER VM2245-2246	1	PZ																																																																																						
VM2248B0	HANDLE WITH LATCH CLOSING KEY	1	PZ																																																																																						
VM2259B0		1	PZ																																																																																						
VM2260B0	S6 LEFT UPPER CAP	1	PZ																																																																																						
VM2261B0		1	PZ																																																																																						
VM2262B0		1	PZ																																																																																						
VM2267A0	INTERNAL GLASS LOCKING SYSTEM SLIDER	2	PZ																																																																																						
VM2268A0	DOOR MAGNET COVER	2	PZ																																																																																						

COMPONENT			SPARE PART																																																																												
Code	Description	Image	Code	Description	Components list																																																																										
VT1292A	XEBC-10EU-E EXTERNAL GLASS		KDR1271B	CHEFTOP 10FS-2/1 -M RIGHT EXTERNAL DOOR	<table border="1"> <thead> <tr> <th>Code</th> <th>Description</th> <th>Qty</th> <th>UOM</th> </tr> </thead> <tbody> <tr> <td>VM2269B0</td> <td>INNER GLASS FIXING CAP</td> <td>2</td> <td>PZ</td> </tr> <tr> <td>VM2274A0</td> <td>GROOVED BUSHING</td> <td>1</td> <td>PZ</td> </tr> <tr> <td>VM2275A0</td> <td>SMOOTH BUSHING</td> <td>1</td> <td>PZ</td> </tr> <tr> <td>VM2285B0</td> <td>860 SERIES DRIP PROFILE KIT</td> <td>1</td> <td>PZ</td> </tr> <tr> <td>VM2295A1</td> <td>MIND.MAPS TOUCH CONTROL STYLUS KIT</td> <td>1</td> <td>PZ</td> </tr> <tr> <td>VM2305A0</td> <td>6 SERIES DOOR CAP FIXING PAWL</td> <td>14</td> <td>PZ</td> </tr> <tr> <td>VM2312A0</td> <td>6 S. DRIP PROFILE DRAIN LEFT PIPE</td> <td>1</td> <td>PZ</td> </tr> <tr> <td>VM2314A0</td> <td>6 S. DRIP PROFILE CAP</td> <td>1</td> <td>PZ</td> </tr> <tr> <td>VM2315A0</td> <td>MIND.MAPS INTERNAL GLASS CAP SUPPORT</td> <td>5</td> <td>PZ</td> </tr> <tr> <td>VM2410A0</td> <td>PLATE TO STOP EXTRUDED LED BAR</td> <td>4</td> <td>PZ</td> </tr> <tr> <td>VM2505A0</td> <td>MM PLUS INTERNAL GLASS SUPPORT</td> <td>3</td> <td>PZ</td> </tr> <tr> <td>VM2518A0</td> <td>BOARD COOLING FAN SUPPORT</td> <td>1</td> <td>PZ</td> </tr> <tr> <td>VN1179A1</td> <td>CONTROL BOARD 40X40X20MM 12V COOLING FAN</td> <td>1</td> <td>PZ</td> </tr> <tr> <td>VP1076A0</td> <td>PLUS ONE ZERO HANDLE PIN</td> <td>1</td> <td>PZ</td> </tr> <tr> <td>VP1080A0</td> <td>UPPER HINGE CAP FOR LOWER INNER GLASS</td> <td>1</td> <td>PZ</td> </tr> <tr> <td>VP1081A0</td> <td>UPPER HINGE CAP FOR UPPER INNER GLASS</td> <td>1</td> <td>PZ</td> </tr> <tr> <td>VT1292A0</td> <td>XEBC-10EU-E EXTERNAL GLASS</td> <td></td> <td></td> <td></td> <td>1 PZ</td> </tr> </tbody> </table>	Code	Description	Qty	UOM	VM2269B0	INNER GLASS FIXING CAP	2	PZ	VM2274A0	GROOVED BUSHING	1	PZ	VM2275A0	SMOOTH BUSHING	1	PZ	VM2285B0	860 SERIES DRIP PROFILE KIT	1	PZ	VM2295A1	MIND.MAPS TOUCH CONTROL STYLUS KIT	1	PZ	VM2305A0	6 SERIES DOOR CAP FIXING PAWL	14	PZ	VM2312A0	6 S. DRIP PROFILE DRAIN LEFT PIPE	1	PZ	VM2314A0	6 S. DRIP PROFILE CAP	1	PZ	VM2315A0	MIND.MAPS INTERNAL GLASS CAP SUPPORT	5	PZ	VM2410A0	PLATE TO STOP EXTRUDED LED BAR	4	PZ	VM2505A0	MM PLUS INTERNAL GLASS SUPPORT	3	PZ	VM2518A0	BOARD COOLING FAN SUPPORT	1	PZ	VN1179A1	CONTROL BOARD 40X40X20MM 12V COOLING FAN	1	PZ	VP1076A0	PLUS ONE ZERO HANDLE PIN	1	PZ	VP1080A0	UPPER HINGE CAP FOR LOWER INNER GLASS	1	PZ	VP1081A0	UPPER HINGE CAP FOR UPPER INNER GLASS	1	PZ	VT1292A0	XEBC-10EU-E EXTERNAL GLASS				1 PZ
Code	Description	Qty	UOM																																																																												
VM2269B0	INNER GLASS FIXING CAP	2	PZ																																																																												
VM2274A0	GROOVED BUSHING	1	PZ																																																																												
VM2275A0	SMOOTH BUSHING	1	PZ																																																																												
VM2285B0	860 SERIES DRIP PROFILE KIT	1	PZ																																																																												
VM2295A1	MIND.MAPS TOUCH CONTROL STYLUS KIT	1	PZ																																																																												
VM2305A0	6 SERIES DOOR CAP FIXING PAWL	14	PZ																																																																												
VM2312A0	6 S. DRIP PROFILE DRAIN LEFT PIPE	1	PZ																																																																												
VM2314A0	6 S. DRIP PROFILE CAP	1	PZ																																																																												
VM2315A0	MIND.MAPS INTERNAL GLASS CAP SUPPORT	5	PZ																																																																												
VM2410A0	PLATE TO STOP EXTRUDED LED BAR	4	PZ																																																																												
VM2505A0	MM PLUS INTERNAL GLASS SUPPORT	3	PZ																																																																												
VM2518A0	BOARD COOLING FAN SUPPORT	1	PZ																																																																												
VN1179A1	CONTROL BOARD 40X40X20MM 12V COOLING FAN	1	PZ																																																																												
VP1076A0	PLUS ONE ZERO HANDLE PIN	1	PZ																																																																												
VP1080A0	UPPER HINGE CAP FOR LOWER INNER GLASS	1	PZ																																																																												
VP1081A0	UPPER HINGE CAP FOR UPPER INNER GLASS	1	PZ																																																																												
VT1292A0	XEBC-10EU-E EXTERNAL GLASS				1 PZ																																																																										

COMPONENT			SPARE PART																																																																																		
Code	Description	Image	Code	Description	Components list																																																																																
VT1292A	XEBC-10EU-E EXTERNAL GLASS		KDR1271A	CHEFTOP 10FS RIGHT EXTERNAL DOOR	<table border="1"> <thead> <tr> <th>Code</th> <th>Description</th> <th>Qty</th> <th>UOM</th> </tr> </thead> <tbody> <tr> <td>0B1126A0</td> <td>DOOR LOWER FRAME SHAPE 860 MM</td> <td>1</td> <td>PZ</td> </tr> <tr> <td>0B1126A1</td> <td></td> <td>1</td> <td>PZ</td> </tr> <tr> <td>0B1170A2</td> <td>XEBC-10EU-E LEFT INT DOOR COLUM</td> <td>1</td> <td>PZ</td> </tr> <tr> <td>0B1171A0</td> <td>XEBC-10EU-E RIGHT EXT DOOR COLUM</td> <td>1</td> <td>PZ</td> </tr> <tr> <td>0B1171B0</td> <td></td> <td>1</td> <td>PZ</td> </tr> <tr> <td>0B1171B1</td> <td></td> <td>1</td> <td>PZ</td> </tr> <tr> <td>0B1172A2</td> <td>XEBC-10EU-E RIGHT INT DOOR COLUM</td> <td>1</td> <td>PZ</td> </tr> <tr> <td>0B1173A0</td> <td>EXT. GLASS SUPPORT PROFILE</td> <td>2</td> <td>PZ</td> </tr> <tr> <td>0B1176A0</td> <td>XAVC-10FS-E LEFT EXT DOOR COLUM</td> <td>1</td> <td>PZ</td> </tr> <tr> <td>0B1218A0</td> <td>MM DOUBLE GLASS DOOR UPPER BEAM 860</td> <td>1</td> <td>PZ</td> </tr> <tr> <td>0B1218A1</td> <td></td> <td>1</td> <td>PZ</td> </tr> <tr> <td>0B1219A1</td> <td>MM DOUBLE GLASS DOOR INT UPPER BEAM 860</td> <td>1</td> <td>PZ</td> </tr> <tr> <td>0H7321A0</td> <td>MM STAINLESS STEEL HANDLE COVE</td> <td>1</td> <td>PZ</td> </tr> <tr> <td>CE1052A1</td> <td>CABLE CONNECTION CONTROL - USB MM 750M</td> <td>1</td> <td>PZ</td> </tr> <tr> <td>CE1053B0</td> <td>MM MICROFIT LED BAR POWER SUPPLY CABL</td> <td>1</td> <td>PZ</td> </tr> <tr> <td>CE1285A0</td> <td>EMI ROUND FERRITE MOD.26438015 02</td> <td>1</td> <td>PZ</td> </tr> <tr> <td>CE1290A0</td> <td>EXTRACTABL E FEMALE TERMINAL CPF 5/4</td> <td>1</td> <td>PZ</td> </tr> <tr> <td>CE1455A0</td> <td>TIP END FITTING</td> <td>4</td> <td>PZ</td> </tr> <tr> <td>CE1725A0</td> <td>ROBOTICS SILICON PIPE 4X0,5 MMO</td> <td>4</td> <td>M</td> </tr> </tbody> </table>	Code	Description	Qty	UOM	0B1126A0	DOOR LOWER FRAME SHAPE 860 MM	1	PZ	0B1126A1		1	PZ	0B1170A2	XEBC-10EU-E LEFT INT DOOR COLUM	1	PZ	0B1171A0	XEBC-10EU-E RIGHT EXT DOOR COLUM	1	PZ	0B1171B0		1	PZ	0B1171B1		1	PZ	0B1172A2	XEBC-10EU-E RIGHT INT DOOR COLUM	1	PZ	0B1173A0	EXT. GLASS SUPPORT PROFILE	2	PZ	0B1176A0	XAVC-10FS-E LEFT EXT DOOR COLUM	1	PZ	0B1218A0	MM DOUBLE GLASS DOOR UPPER BEAM 860	1	PZ	0B1218A1		1	PZ	0B1219A1	MM DOUBLE GLASS DOOR INT UPPER BEAM 860	1	PZ	0H7321A0	MM STAINLESS STEEL HANDLE COVE	1	PZ	CE1052A1	CABLE CONNECTION CONTROL - USB MM 750M	1	PZ	CE1053B0	MM MICROFIT LED BAR POWER SUPPLY CABL	1	PZ	CE1285A0	EMI ROUND FERRITE MOD.26438015 02	1	PZ	CE1290A0	EXTRACTABL E FEMALE TERMINAL CPF 5/4	1	PZ	CE1455A0	TIP END FITTING	4	PZ	CE1725A0	ROBOTICS SILICON PIPE 4X0,5 MMO	4	M
Code	Description	Qty	UOM																																																																																		
0B1126A0	DOOR LOWER FRAME SHAPE 860 MM	1	PZ																																																																																		
0B1126A1		1	PZ																																																																																		
0B1170A2	XEBC-10EU-E LEFT INT DOOR COLUM	1	PZ																																																																																		
0B1171A0	XEBC-10EU-E RIGHT EXT DOOR COLUM	1	PZ																																																																																		
0B1171B0		1	PZ																																																																																		
0B1171B1		1	PZ																																																																																		
0B1172A2	XEBC-10EU-E RIGHT INT DOOR COLUM	1	PZ																																																																																		
0B1173A0	EXT. GLASS SUPPORT PROFILE	2	PZ																																																																																		
0B1176A0	XAVC-10FS-E LEFT EXT DOOR COLUM	1	PZ																																																																																		
0B1218A0	MM DOUBLE GLASS DOOR UPPER BEAM 860	1	PZ																																																																																		
0B1218A1		1	PZ																																																																																		
0B1219A1	MM DOUBLE GLASS DOOR INT UPPER BEAM 860	1	PZ																																																																																		
0H7321A0	MM STAINLESS STEEL HANDLE COVE	1	PZ																																																																																		
CE1052A1	CABLE CONNECTION CONTROL - USB MM 750M	1	PZ																																																																																		
CE1053B0	MM MICROFIT LED BAR POWER SUPPLY CABL	1	PZ																																																																																		
CE1285A0	EMI ROUND FERRITE MOD.26438015 02	1	PZ																																																																																		
CE1290A0	EXTRACTABL E FEMALE TERMINAL CPF 5/4	1	PZ																																																																																		
CE1455A0	TIP END FITTING	4	PZ																																																																																		
CE1725A0	ROBOTICS SILICON PIPE 4X0,5 MMO	4	M																																																																																		



COMPONENT			SPARE PART																																																																														
Code	Description	Image	Code	Description	Components list																																																																												
VT1292A	XEBC-10EU-E EXTERNAL GLASS		KDR1271A	CHEFTOP 10FS RIGHT EXTERNAL DOOR	<table border="1"> <thead> <tr> <th>Code</th> <th>Description</th> <th>Qty</th> <th>UOM</th> </tr> </thead> <tbody> <tr> <td>CE1735A0</td> <td>MINIFIT FEMALE END FITTING</td> <td>4</td> <td>PZ</td> </tr> <tr> <td>CE1755A0</td> <td>4 WAYS MALE MINIFIT CONNECTOR</td> <td>1</td> <td>PZ</td> </tr> <tr> <td>IP1508A1</td> <td>POLYSTYREN E U SHAPED PROFILE 2000X60X60</td> <td>2</td> <td>M</td> </tr> <tr> <td>LP1022A0</td> <td>6 SERIES L600 LED LIGHT BAR - E903</td> <td>1</td> <td>PZ</td> </tr> <tr> <td>LP1028A0</td> <td>L=903 S6 NO LED LIGHT BAR COVER</td> <td>1</td> <td>PZ</td> </tr> <tr> <td>MG1083A2</td> <td></td> <td>1</td> <td>PZ</td> </tr> <tr> <td>RC1200A0</td> <td>ED=4 WIRE D.=0.5 COMPRESSIO N SPRING</td> <td>4</td> <td>PZ</td> </tr> <tr> <td>SL1170A1</td> <td>S57 BLACK SILICON - 310ML CARTRIDGE</td> <td>51</td> <td>ML</td> </tr> <tr> <td>VE1030A1</td> <td>MAGNET FOR DOOR MICROSWITC H D=22.9MM</td> <td>2</td> <td>PZ</td> </tr> <tr> <td>VI0239A1</td> <td>SELF-TAPPIN G SCREW 4.2X25 TCB+ INOX</td> <td>4</td> <td>PZ</td> </tr> <tr> <td>VI1220A1</td> <td>4,2X12 TCB SELF-TAPPIN G SCREW</td> <td>19</td> <td>PZ</td> </tr> <tr> <td>VI1930A0</td> <td>5X25 ST. STEEL SCREW CHIP</td> <td>16</td> <td>PZ</td> </tr> <tr> <td>VI1960A0</td> <td>SELF-TAPPIN G SCREW 4.2X11 TCBS+ AISI410</td> <td>10</td> <td>PZ</td> </tr> <tr> <td>VI1996A0</td> <td>M5X35 SCREW</td> <td>13</td> <td>PZ</td> </tr> <tr> <td>VM1059A1</td> <td>HEAT SHRINK FILM H800</td> <td>1.500</td> <td>M</td> </tr> <tr> <td>VM1182B1</td> <td>E.S. CT BT HANDLE JUNCTION + PIN GUIDE</td> <td>1</td> <td>PZ</td> </tr> <tr> <td>VM1183B0</td> <td>CHEFTOP/BAK ERTOP HANDLE PIN</td> <td>1</td> <td>PZ</td> </tr> <tr> <td>VM1183B1</td> <td>CT BT HANDLE PIN</td> <td>1</td> <td>PZ</td> </tr> </tbody> </table>	Code	Description	Qty	UOM	CE1735A0	MINIFIT FEMALE END FITTING	4	PZ	CE1755A0	4 WAYS MALE MINIFIT CONNECTOR	1	PZ	IP1508A1	POLYSTYREN E U SHAPED PROFILE 2000X60X60	2	M	LP1022A0	6 SERIES L600 LED LIGHT BAR - E903	1	PZ	LP1028A0	L=903 S6 NO LED LIGHT BAR COVER	1	PZ	MG1083A2		1	PZ	RC1200A0	ED=4 WIRE D.=0.5 COMPRESSIO N SPRING	4	PZ	SL1170A1	S57 BLACK SILICON - 310ML CARTRIDGE	51	ML	VE1030A1	MAGNET FOR DOOR MICROSWITC H D=22.9MM	2	PZ	VI0239A1	SELF-TAPPIN G SCREW 4.2X25 TCB+ INOX	4	PZ	VI1220A1	4,2X12 TCB SELF-TAPPIN G SCREW	19	PZ	VI1930A0	5X25 ST. STEEL SCREW CHIP	16	PZ	VI1960A0	SELF-TAPPIN G SCREW 4.2X11 TCBS+ AISI410	10	PZ	VI1996A0	M5X35 SCREW	13	PZ	VM1059A1	HEAT SHRINK FILM H800	1.500	M	VM1182B1	E.S. CT BT HANDLE JUNCTION + PIN GUIDE	1	PZ	VM1183B0	CHEFTOP/BAK ERTOP HANDLE PIN	1	PZ	VM1183B1	CT BT HANDLE PIN	1	PZ
Code	Description	Qty	UOM																																																																														
CE1735A0	MINIFIT FEMALE END FITTING	4	PZ																																																																														
CE1755A0	4 WAYS MALE MINIFIT CONNECTOR	1	PZ																																																																														
IP1508A1	POLYSTYREN E U SHAPED PROFILE 2000X60X60	2	M																																																																														
LP1022A0	6 SERIES L600 LED LIGHT BAR - E903	1	PZ																																																																														
LP1028A0	L=903 S6 NO LED LIGHT BAR COVER	1	PZ																																																																														
MG1083A2		1	PZ																																																																														
RC1200A0	ED=4 WIRE D.=0.5 COMPRESSIO N SPRING	4	PZ																																																																														
SL1170A1	S57 BLACK SILICON - 310ML CARTRIDGE	51	ML																																																																														
VE1030A1	MAGNET FOR DOOR MICROSWITC H D=22.9MM	2	PZ																																																																														
VI0239A1	SELF-TAPPIN G SCREW 4.2X25 TCB+ INOX	4	PZ																																																																														
VI1220A1	4,2X12 TCB SELF-TAPPIN G SCREW	19	PZ																																																																														
VI1930A0	5X25 ST. STEEL SCREW CHIP	16	PZ																																																																														
VI1960A0	SELF-TAPPIN G SCREW 4.2X11 TCBS+ AISI410	10	PZ																																																																														
VI1996A0	M5X35 SCREW	13	PZ																																																																														
VM1059A1	HEAT SHRINK FILM H800	1.500	M																																																																														
VM1182B1	E.S. CT BT HANDLE JUNCTION + PIN GUIDE	1	PZ																																																																														
VM1183B0	CHEFTOP/BAK ERTOP HANDLE PIN	1	PZ																																																																														
VM1183B1	CT BT HANDLE PIN	1	PZ																																																																														









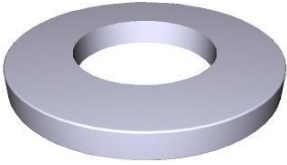

COMPONENT			SPARE PART																																																																						
Code	Description	Image	Code	Description	Components list																																																																				
VT1292A	XEBC-10EU-E EXTERNAL GLASS		KDR1271A	CHEFTOP 10FS RIGHT EXTERNAL DOOR	<table border="1"> <thead> <tr> <th>Code</th> <th>Description</th> <th>Qty</th> <th>UOM</th> </tr> </thead> <tbody> <tr> <td>VM1183C0</td> <td>CT BT HANDLE T-SHAPED PIN KIT</td> <td>1</td> <td>PZ</td> </tr> <tr> <td>VM1183C1</td> <td>CT BT HANDLE T-SHAPED PIN KIT</td> <td>1</td> <td>PZ</td> </tr> <tr> <td>VM1490A0</td> <td>CHEFTOP/BAK ERTOP HANDLE SCREWS COVER</td> <td>2</td> <td>PZ</td> </tr> <tr> <td>VM1630A0</td> <td>INTERNAL GLASS PUSHING CAP</td> <td>5</td> <td>PZ</td> </tr> <tr> <td>VM1630A1</td> <td>INTERNAL GLASS PUSHING CAP</td> <td>5</td> <td>PZ</td> </tr> <tr> <td>VM1631A0</td> <td>PLUS INNER GLASS PUSHING CAP</td> <td>3</td> <td>PZ</td> </tr> <tr> <td>VM1695A0</td> <td>HANDLE POSITION PIN</td> <td>4</td> <td>PZ</td> </tr> <tr> <td>VM2245A0</td> <td>HANDLE SHAFT WITH LATCH</td> <td>1</td> <td>PZ</td> </tr> <tr> <td>VM2247A0</td> <td>HANDLE SHAFT COVER VM2245-2246</td> <td>1</td> <td>PZ</td> </tr> <tr> <td>VM2247B0</td> <td>HANDLE SHAFT COVER VM2245-2246</td> <td>1</td> <td>PZ</td> </tr> <tr> <td>VM2248B0</td> <td>HANDLE WITH LATCH CLOSING KEY</td> <td>1</td> <td>PZ</td> </tr> <tr> <td>VM2259A1</td> <td>6 SERIES DOOR LOWER LEFT CAP</td> <td>1</td> <td>PZ</td> </tr> <tr> <td>VM2260A1</td> <td>6 SERIES DOOR UPPER LEFT CAP</td> <td>1</td> <td>PZ</td> </tr> <tr> <td>VM2261A1</td> <td>6 SERIES DOOR LOWER RIGHT CAP</td> <td>1</td> <td>PZ</td> </tr> <tr> <td>VM2262A1</td> <td>6 SERIES DOOR UPPER RIGHT CAP</td> <td>1</td> <td>PZ</td> </tr> <tr> <td>VM2267A0</td> <td>INTERNAL GLASS LOCKING SYSTEM SLIDER</td> <td>2</td> <td>PZ</td> </tr> </tbody> </table>	Code	Description	Qty	UOM	VM1183C0	CT BT HANDLE T-SHAPED PIN KIT	1	PZ	VM1183C1	CT BT HANDLE T-SHAPED PIN KIT	1	PZ	VM1490A0	CHEFTOP/BAK ERTOP HANDLE SCREWS COVER	2	PZ	VM1630A0	INTERNAL GLASS PUSHING CAP	5	PZ	VM1630A1	INTERNAL GLASS PUSHING CAP	5	PZ	VM1631A0	PLUS INNER GLASS PUSHING CAP	3	PZ	VM1695A0	HANDLE POSITION PIN	4	PZ	VM2245A0	HANDLE SHAFT WITH LATCH	1	PZ	VM2247A0	HANDLE SHAFT COVER VM2245-2246	1	PZ	VM2247B0	HANDLE SHAFT COVER VM2245-2246	1	PZ	VM2248B0	HANDLE WITH LATCH CLOSING KEY	1	PZ	VM2259A1	6 SERIES DOOR LOWER LEFT CAP	1	PZ	VM2260A1	6 SERIES DOOR UPPER LEFT CAP	1	PZ	VM2261A1	6 SERIES DOOR LOWER RIGHT CAP	1	PZ	VM2262A1	6 SERIES DOOR UPPER RIGHT CAP	1	PZ	VM2267A0	INTERNAL GLASS LOCKING SYSTEM SLIDER	2	PZ
Code	Description	Qty	UOM																																																																						
VM1183C0	CT BT HANDLE T-SHAPED PIN KIT	1	PZ																																																																						
VM1183C1	CT BT HANDLE T-SHAPED PIN KIT	1	PZ																																																																						
VM1490A0	CHEFTOP/BAK ERTOP HANDLE SCREWS COVER	2	PZ																																																																						
VM1630A0	INTERNAL GLASS PUSHING CAP	5	PZ																																																																						
VM1630A1	INTERNAL GLASS PUSHING CAP	5	PZ																																																																						
VM1631A0	PLUS INNER GLASS PUSHING CAP	3	PZ																																																																						
VM1695A0	HANDLE POSITION PIN	4	PZ																																																																						
VM2245A0	HANDLE SHAFT WITH LATCH	1	PZ																																																																						
VM2247A0	HANDLE SHAFT COVER VM2245-2246	1	PZ																																																																						
VM2247B0	HANDLE SHAFT COVER VM2245-2246	1	PZ																																																																						
VM2248B0	HANDLE WITH LATCH CLOSING KEY	1	PZ																																																																						
VM2259A1	6 SERIES DOOR LOWER LEFT CAP	1	PZ																																																																						
VM2260A1	6 SERIES DOOR UPPER LEFT CAP	1	PZ																																																																						
VM2261A1	6 SERIES DOOR LOWER RIGHT CAP	1	PZ																																																																						
VM2262A1	6 SERIES DOOR UPPER RIGHT CAP	1	PZ																																																																						
VM2267A0	INTERNAL GLASS LOCKING SYSTEM SLIDER	2	PZ																																																																						



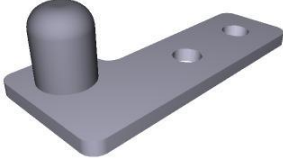

COMPONENT			SPARE PART																																																																										
Code	Description	Image	Code	Description	Components list																																																																								
VT1292A	XEBC-10EU-E EXTERNAL GLASS		KDR1271A	CHEFTOP 10FS RIGHT EXTERNAL DOOR	<table border="1"> <thead> <tr> <th>Code</th> <th>Description</th> <th>Qty</th> <th>UOM</th> </tr> </thead> <tbody> <tr> <td>VM2268A0</td> <td>DOOR MAGNET COVER</td> <td>2</td> <td>PZ</td> </tr> <tr> <td>VM2269A0</td> <td>INTERNAL GLASS LOCKING SYSTEM CAP</td> <td>2</td> <td>PZ</td> </tr> <tr> <td>VM2274A0</td> <td>GROOVED BUSHING</td> <td>1</td> <td>PZ</td> </tr> <tr> <td>VM2275A0</td> <td>SMOOTH BUSHING</td> <td>1</td> <td>PZ</td> </tr> <tr> <td>VM2285A0</td> <td>860 SERIES DRIP PROFILE</td> <td>1</td> <td>PZ</td> </tr> <tr> <td>VM2295A0</td> <td>STYLUS PEN FOR MM</td> <td>1</td> <td>PZ</td> </tr> <tr> <td>VM2305A0</td> <td>6 SERIES DOOR CAP FIXING PAWL</td> <td>14</td> <td>PZ</td> </tr> <tr> <td>VM2312A0</td> <td>6 S. DRIP PROFILE DRAIN LEFT PIPE</td> <td>1</td> <td>PZ</td> </tr> <tr> <td>VM2313A0</td> <td>TUBE DX DISCHARGE DRIP MM</td> <td>1</td> <td>PZ</td> </tr> <tr> <td>VM2314A0</td> <td>6 S. DRIP PROFILE CAP</td> <td>1</td> <td>PZ</td> </tr> <tr> <td>VM2315A0</td> <td>MIND.MAPS INTERNAL GLASS CAP SUPPORT</td> <td>5</td> <td>PZ</td> </tr> <tr> <td>VM2371A0</td> <td>DOUBLE GLASS DOOR PUSHING BRACKET</td> <td>3</td> <td>PZ</td> </tr> <tr> <td>VM2371A0</td> <td>DOUBLE GLASS DOOR PUSHING BRACKET</td> <td>3</td> <td>PZ</td> </tr> <tr> <td>VM2410A0</td> <td>PLATE TO STOP EXTRUDED LED BAR</td> <td>4</td> <td>PZ</td> </tr> <tr> <td>VM2410A0</td> <td>PLATE TO STOP EXTRUDED LED BAR</td> <td>4</td> <td>PZ</td> </tr> <tr> <td>VM2505A0</td> <td>MM PLUS INTERNAL GLASS SUPPORT</td> <td>3</td> <td>PZ</td> </tr> <tr> <td>VM2518A0</td> <td>BOARD COOLING FAN SUPPORT</td> <td>1</td> <td>PZ</td> </tr> </tbody> </table>	Code	Description	Qty	UOM	VM2268A0	DOOR MAGNET COVER	2	PZ	VM2269A0	INTERNAL GLASS LOCKING SYSTEM CAP	2	PZ	VM2274A0	GROOVED BUSHING	1	PZ	VM2275A0	SMOOTH BUSHING	1	PZ	VM2285A0	860 SERIES DRIP PROFILE	1	PZ	VM2295A0	STYLUS PEN FOR MM	1	PZ	VM2305A0	6 SERIES DOOR CAP FIXING PAWL	14	PZ	VM2312A0	6 S. DRIP PROFILE DRAIN LEFT PIPE	1	PZ	VM2313A0	TUBE DX DISCHARGE DRIP MM	1	PZ	VM2314A0	6 S. DRIP PROFILE CAP	1	PZ	VM2315A0	MIND.MAPS INTERNAL GLASS CAP SUPPORT	5	PZ	VM2371A0	DOUBLE GLASS DOOR PUSHING BRACKET	3	PZ	VM2371A0	DOUBLE GLASS DOOR PUSHING BRACKET	3	PZ	VM2410A0	PLATE TO STOP EXTRUDED LED BAR	4	PZ	VM2410A0	PLATE TO STOP EXTRUDED LED BAR	4	PZ	VM2505A0	MM PLUS INTERNAL GLASS SUPPORT	3	PZ	VM2518A0	BOARD COOLING FAN SUPPORT	1	PZ
Code	Description	Qty	UOM																																																																										
VM2268A0	DOOR MAGNET COVER	2	PZ																																																																										
VM2269A0	INTERNAL GLASS LOCKING SYSTEM CAP	2	PZ																																																																										
VM2274A0	GROOVED BUSHING	1	PZ																																																																										
VM2275A0	SMOOTH BUSHING	1	PZ																																																																										
VM2285A0	860 SERIES DRIP PROFILE	1	PZ																																																																										
VM2295A0	STYLUS PEN FOR MM	1	PZ																																																																										
VM2305A0	6 SERIES DOOR CAP FIXING PAWL	14	PZ																																																																										
VM2312A0	6 S. DRIP PROFILE DRAIN LEFT PIPE	1	PZ																																																																										
VM2313A0	TUBE DX DISCHARGE DRIP MM	1	PZ																																																																										
VM2314A0	6 S. DRIP PROFILE CAP	1	PZ																																																																										
VM2315A0	MIND.MAPS INTERNAL GLASS CAP SUPPORT	5	PZ																																																																										
VM2371A0	DOUBLE GLASS DOOR PUSHING BRACKET	3	PZ																																																																										
VM2371A0	DOUBLE GLASS DOOR PUSHING BRACKET	3	PZ																																																																										
VM2410A0	PLATE TO STOP EXTRUDED LED BAR	4	PZ																																																																										
VM2410A0	PLATE TO STOP EXTRUDED LED BAR	4	PZ																																																																										
VM2505A0	MM PLUS INTERNAL GLASS SUPPORT	3	PZ																																																																										
VM2518A0	BOARD COOLING FAN SUPPORT	1	PZ																																																																										

COMPONENT			SPARE PART																														
Code	Description	Image	Code	Description	Components list																												
VT1292A	XEBC-10EU-E EXTERNAL GLASS		KDR1271A	CHEFTOP 10FS RIGHT EXTERNAL DOOR	<table border="1"> <thead> <tr> <th>Code</th> <th>Description</th> <th>Qty</th> <th>UOM</th> </tr> </thead> <tbody> <tr> <td>VM2518A0</td> <td>BOARD COOLING FAN SUPPORT</td> <td>1</td> <td>PZ</td> </tr> <tr> <td>VN1179A0</td> <td>CONTROL BOARD 40X40X20MM 12V COOLING FAN</td> <td>1</td> <td>PZ</td> </tr> <tr> <td>VN1179A0</td> <td>CONTROL BOARD 40X40X20MM 12V COOLING FAN</td> <td>1</td> <td>PZ</td> </tr> <tr> <td>VN1179A1</td> <td>CONTROL BOARD 40X40X20MM 12V COOLING FAN</td> <td>1</td> <td>PZ</td> </tr> <tr> <td>VT1292A0</td> <td>XEBC-10EU-E EXTERNAL GLASS</td> <td>1</td> <td>PZ</td> </tr> <tr> <td>VT1292A0</td> <td>XEBC-10EU-E EXTERNAL GLASS</td> <td>1</td> <td>PZ</td> </tr> </tbody> </table>	Code	Description	Qty	UOM	VM2518A0	BOARD COOLING FAN SUPPORT	1	PZ	VN1179A0	CONTROL BOARD 40X40X20MM 12V COOLING FAN	1	PZ	VN1179A0	CONTROL BOARD 40X40X20MM 12V COOLING FAN	1	PZ	VN1179A1	CONTROL BOARD 40X40X20MM 12V COOLING FAN	1	PZ	VT1292A0	XEBC-10EU-E EXTERNAL GLASS	1	PZ	VT1292A0	XEBC-10EU-E EXTERNAL GLASS	1	PZ
					Code	Description	Qty	UOM																									
					VM2518A0	BOARD COOLING FAN SUPPORT	1	PZ																									
					VN1179A0	CONTROL BOARD 40X40X20MM 12V COOLING FAN	1	PZ																									
					VN1179A0	CONTROL BOARD 40X40X20MM 12V COOLING FAN	1	PZ																									
					VN1179A1	CONTROL BOARD 40X40X20MM 12V COOLING FAN	1	PZ																									
					VT1292A0	XEBC-10EU-E EXTERNAL GLASS	1	PZ																									
VT1292A0	XEBC-10EU-E EXTERNAL GLASS	1	PZ																														
LP1022A	6 SERIES L600 LED LIGHT BAR - E903		KLP1022A	L600 E903 LED LIGHT BAR KIT	<table border="1"> <thead> <tr> <th>Code</th> <th>Description</th> <th>Qty</th> <th>UOM</th> </tr> </thead> <tbody> <tr> <td>IP1385A1</td> <td>CORNER POLYSTYREN E PACKING 110X80X2000</td> <td>1.940</td> <td>M</td> </tr> <tr> <td>LP1022A0</td> <td>6 SERIES L600 LED LIGHT BAR - E903</td> <td>1</td> <td>PZ</td> </tr> <tr> <td>VM1059A1</td> <td>HEAT SHRINK FILM H800</td> <td>1.940</td> <td>M</td> </tr> </tbody> </table>	Code	Description	Qty	UOM	IP1385A1	CORNER POLYSTYREN E PACKING 110X80X2000	1.940	M	LP1022A0	6 SERIES L600 LED LIGHT BAR - E903	1	PZ	VM1059A1	HEAT SHRINK FILM H800	1.940	M												
					Code	Description	Qty	UOM																									
					IP1385A1	CORNER POLYSTYREN E PACKING 110X80X2000	1.940	M																									
LP1022A0	6 SERIES L600 LED LIGHT BAR - E903	1	PZ																														
VM1059A1	HEAT SHRINK FILM H800	1.940	M																														
LP1028A	L=903 S6 NO LED LIGHT BAR COVER		KLP1028A	L903 MM NO LED LIGHT HOLDER KIT	<table border="1"> <thead> <tr> <th>Code</th> <th>Description</th> <th>Qty</th> <th>UOM</th> </tr> </thead> <tbody> <tr> <td>IP1385A1</td> <td>CORNER POLYSTYREN E PACKING 110X80X2000</td> <td>1.940</td> <td>M</td> </tr> <tr> <td>LP1028A0</td> <td>L=903 S6 NO LED LIGHT BAR COVER</td> <td>1</td> <td>PZ</td> </tr> <tr> <td>VM1059A1</td> <td>HEAT SHRINK FILM H800</td> <td>1.940</td> <td>M</td> </tr> </tbody> </table>	Code	Description	Qty	UOM	IP1385A1	CORNER POLYSTYREN E PACKING 110X80X2000	1.940	M	LP1028A0	L=903 S6 NO LED LIGHT BAR COVER	1	PZ	VM1059A1	HEAT SHRINK FILM H800	1.940	M												
					Code	Description	Qty	UOM																									
					IP1385A1	CORNER POLYSTYREN E PACKING 110X80X2000	1.940	M																									
LP1028A0	L=903 S6 NO LED LIGHT BAR COVER	1	PZ																														
VM1059A1	HEAT SHRINK FILM H800	1.940	M																														



COMPONENT			SPARE PART																						
Code	Description	Image	Code	Description	Components list																				
VI1034A	STAINLESS STEEL WASHER 8.4X16X1		VI1034A0	STAINLESS STEEL WASHER 8.4X16X1																					
CE1052A	CABLE CONNECTION CONTROL - USB MM 750MM		KCE1052A	CONTROL BOARD-USB 650 CONN. CABLE KIT	<table border="1"> <thead> <tr> <th>Code</th> <th>Description</th> <th>Qty</th> <th>UOM</th> </tr> </thead> <tbody> <tr> <td>CE1052A1</td> <td>CABLE CONNECTION CONTROL - USB MM 750M</td> <td>1</td> <td>PZ</td> </tr> <tr> <td>VM1224A0</td> <td>65MY 220MM 2 COLOURS SHRINK TUBE</td> <td>0.350</td> <td>M</td> </tr> </tbody> </table>	Code	Description	Qty	UOM	CE1052A1	CABLE CONNECTION CONTROL - USB MM 750M	1	PZ	VM1224A0	65MY 220MM 2 COLOURS SHRINK TUBE	0.350	M								
Code	Description	Qty	UOM																						
CE1052A1	CABLE CONNECTION CONTROL - USB MM 750M	1	PZ																						
VM1224A0	65MY 220MM 2 COLOURS SHRINK TUBE	0.350	M																						
VM2410A	PLATE TO STOP EXTRUDED LED BAR		KVM2410A	PLATE TO STOP EXTRUDED LED BAR 2P KIT	<table border="1"> <thead> <tr> <th>Code</th> <th>Description</th> <th>Qty</th> <th>UOM</th> </tr> </thead> <tbody> <tr> <td>0B1190A0</td> <td>PLATE TO STOP EXTRUDED LED BAR</td> <td>2</td> <td>PZ</td> </tr> <tr> <td>VM1224A0</td> <td>65MY 220MM 2 COLOURS SHRINK TUBE</td> <td>0.200</td> <td>M</td> </tr> <tr> <td>VM2410A0</td> <td>PLATE TO STOP EXTRUDED LED BAR</td> <td>2</td> <td>PZ</td> </tr> <tr> <td>VM2410A0</td> <td>PLATE TO STOP EXTRUDED LED BAR</td> <td>2</td> <td>PZ</td> </tr> </tbody> </table>	Code	Description	Qty	UOM	0B1190A0	PLATE TO STOP EXTRUDED LED BAR	2	PZ	VM1224A0	65MY 220MM 2 COLOURS SHRINK TUBE	0.200	M	VM2410A0	PLATE TO STOP EXTRUDED LED BAR	2	PZ	VM2410A0	PLATE TO STOP EXTRUDED LED BAR	2	PZ
Code	Description	Qty	UOM																						
0B1190A0	PLATE TO STOP EXTRUDED LED BAR	2	PZ																						
VM1224A0	65MY 220MM 2 COLOURS SHRINK TUBE	0.200	M																						
VM2410A0	PLATE TO STOP EXTRUDED LED BAR	2	PZ																						
VM2410A0	PLATE TO STOP EXTRUDED LED BAR	2	PZ																						
0B1219A	MM DOUBLE GLASS DOOR INT UPPER BEAM 860		0B1219A1	MM DOUBLE GLASS DOOR INT UPPER BEAM 860																					

COMPONENT			SPARE PART																						
Code	Description	Image	Code	Description	Components list																				
0B1169A	XEBC-10EU-E LEFT EXT DOOR COLUMN		0B1169A0	XEBC-10EU-E LEFT EXT DOOR COLUMN																					
0B1173A	EXT. GLASS SUPPORT PROFILE		0B1173A0	EXT. GLASS SUPPORT PROFILE																					
CR1105A	HINGES INTERNAL GLASS DOUBLE		KCR1105A	MIND.MAPS PLUS INTERNAL GLASS HINGES KIT	<table border="1"> <thead> <tr> <th>Code</th> <th>Description</th> <th>Qty</th> <th>UOM</th> </tr> </thead> <tbody> <tr> <td>CR1105A0</td> <td>HINGES INTERNAL GLASS DOUBL</td> <td>1</td> <td>PZ</td> </tr> <tr> <td>CR1106A0</td> <td>HINGES INTERNAL GLASS DOUBL</td> <td>1</td> <td>PZ</td> </tr> <tr> <td>VI1220A1</td> <td>4,2X12 TCB SELF-TAPPIN G SCREW</td> <td>4</td> <td>PZ</td> </tr> <tr> <td>VM1224A0</td> <td>65MY 220MM 2 COLOURS SHRINK TUBE</td> <td>0.200</td> <td>M</td> </tr> </tbody> </table>	Code	Description	Qty	UOM	CR1105A0	HINGES INTERNAL GLASS DOUBL	1	PZ	CR1106A0	HINGES INTERNAL GLASS DOUBL	1	PZ	VI1220A1	4,2X12 TCB SELF-TAPPIN G SCREW	4	PZ	VM1224A0	65MY 220MM 2 COLOURS SHRINK TUBE	0.200	M
Code	Description	Qty	UOM																						
CR1105A0	HINGES INTERNAL GLASS DOUBL	1	PZ																						
CR1106A0	HINGES INTERNAL GLASS DOUBL	1	PZ																						
VI1220A1	4,2X12 TCB SELF-TAPPIN G SCREW	4	PZ																						
VM1224A0	65MY 220MM 2 COLOURS SHRINK TUBE	0.200	M																						
CR1106A	HINGES INTERNAL GLASS DOUBLE		KCR1105A	MIND.MAPS PLUS INTERNAL GLASS HINGES KIT	<table border="1"> <thead> <tr> <th>Code</th> <th>Description</th> <th>Qty</th> <th>UOM</th> </tr> </thead> <tbody> <tr> <td>CR1105A0</td> <td>HINGES INTERNAL GLASS DOUBL</td> <td>1</td> <td>PZ</td> </tr> <tr> <td>CR1106A0</td> <td>HINGES INTERNAL GLASS DOUBL</td> <td>1</td> <td>PZ</td> </tr> <tr> <td>VI1220A1</td> <td>4,2X12 TCB SELF-TAPPIN G SCREW</td> <td>4</td> <td>PZ</td> </tr> <tr> <td>VM1224A0</td> <td>65MY 220MM 2 COLOURS SHRINK TUBE</td> <td>0.200</td> <td>M</td> </tr> </tbody> </table>	Code	Description	Qty	UOM	CR1105A0	HINGES INTERNAL GLASS DOUBL	1	PZ	CR1106A0	HINGES INTERNAL GLASS DOUBL	1	PZ	VI1220A1	4,2X12 TCB SELF-TAPPIN G SCREW	4	PZ	VM1224A0	65MY 220MM 2 COLOURS SHRINK TUBE	0.200	M
Code	Description	Qty	UOM																						
CR1105A0	HINGES INTERNAL GLASS DOUBL	1	PZ																						
CR1106A0	HINGES INTERNAL GLASS DOUBL	1	PZ																						
VI1220A1	4,2X12 TCB SELF-TAPPIN G SCREW	4	PZ																						
VM1224A0	65MY 220MM 2 COLOURS SHRINK TUBE	0.200	M																						

COMPONENT			SPARE PART																																																						
Code	Description	Image	Code	Description	Components list																																																				
VT1298B	10EU 749X942X4 INNER DOUBLE GLASS		KVT1298B	10EU INNER DOUBLE GLASS KIT	<table border="1"> <thead> <tr> <th>Code</th> <th>Description</th> <th>Qty</th> <th>UOM</th> </tr> </thead> <tbody> <tr> <td>0B1185A0</td> <td>BT INT DOUBLE GLASS INF-SUP BEAM</td> <td>2</td> <td>PZ</td> </tr> <tr> <td>0B1188A0</td> <td>10EU DOUBLE GLASS RIGHT-LEFT PROFILE</td> <td>2</td> <td>PZ</td> </tr> <tr> <td>0B1211A0</td> <td>BT DOUBLE GLASS EXT SUP-INF PROFILE</td> <td>2</td> <td>PZ</td> </tr> <tr> <td>0B1211A1</td> <td></td> <td>2</td> <td>PZ</td> </tr> <tr> <td>0B1215A3</td> <td></td> <td>2</td> <td>PZ</td> </tr> <tr> <td>CR1105A0</td> <td>HINGES INTERNAL GLASS DOUBL</td> <td>1</td> <td>PZ</td> </tr> <tr> <td>CR1106A0</td> <td>HINGES INTERNAL GLASS DOUBL</td> <td>1</td> <td>PZ</td> </tr> <tr> <td>IP1508A1</td> <td>POLYSTYREN E U SHAPED PROFILE 2000X60X60</td> <td>2</td> <td>M</td> </tr> <tr> <td>VI1220A1</td> <td>4,2X12 TCB SELF-TAPPIN G SCREW</td> <td>4</td> <td>PZ</td> </tr> <tr> <td>VI1225A0</td> <td>STAINLESS STEEL STRUCTURE RIVET 4X10.1</td> <td>20</td> <td>PZ</td> </tr> <tr> <td>VM1059A1</td> <td>HEAT SHRINK FILM H800</td> <td>1.500</td> <td>M</td> </tr> <tr> <td>VT1298B0</td> <td>10EU 749X942X4 INNER DOUBLE GLAS</td> <td>2</td> <td>PZ</td> </tr> </tbody> </table>	Code	Description	Qty	UOM	0B1185A0	BT INT DOUBLE GLASS INF-SUP BEAM	2	PZ	0B1188A0	10EU DOUBLE GLASS RIGHT-LEFT PROFILE	2	PZ	0B1211A0	BT DOUBLE GLASS EXT SUP-INF PROFILE	2	PZ	0B1211A1		2	PZ	0B1215A3		2	PZ	CR1105A0	HINGES INTERNAL GLASS DOUBL	1	PZ	CR1106A0	HINGES INTERNAL GLASS DOUBL	1	PZ	IP1508A1	POLYSTYREN E U SHAPED PROFILE 2000X60X60	2	M	VI1220A1	4,2X12 TCB SELF-TAPPIN G SCREW	4	PZ	VI1225A0	STAINLESS STEEL STRUCTURE RIVET 4X10.1	20	PZ	VM1059A1	HEAT SHRINK FILM H800	1.500	M	VT1298B0	10EU 749X942X4 INNER DOUBLE GLAS	2	PZ
					Code	Description	Qty	UOM																																																	
					0B1185A0	BT INT DOUBLE GLASS INF-SUP BEAM	2	PZ																																																	
					0B1188A0	10EU DOUBLE GLASS RIGHT-LEFT PROFILE	2	PZ																																																	
					0B1211A0	BT DOUBLE GLASS EXT SUP-INF PROFILE	2	PZ																																																	
					0B1211A1		2	PZ																																																	
					0B1215A3		2	PZ																																																	
					CR1105A0	HINGES INTERNAL GLASS DOUBL	1	PZ																																																	
					CR1106A0	HINGES INTERNAL GLASS DOUBL	1	PZ																																																	
					IP1508A1	POLYSTYREN E U SHAPED PROFILE 2000X60X60	2	M																																																	
					VI1220A1	4,2X12 TCB SELF-TAPPIN G SCREW	4	PZ																																																	
					VI1225A0	STAINLESS STEEL STRUCTURE RIVET 4X10.1	20	PZ																																																	
					VM1059A1	HEAT SHRINK FILM H800	1.500	M																																																	
VT1298B0	10EU 749X942X4 INNER DOUBLE GLAS	2	PZ																																																						
PE1059A	MM USB-RESET SUPPORT		KPE1059A	MM USB-RESET SUPPORT KIT	<table border="1"> <thead> <tr> <th>Code</th> <th>Description</th> <th>Qty</th> <th>UOM</th> </tr> </thead> <tbody> <tr> <td>PE1059A0</td> <td>MM USB-RESET SUPPORT</td> <td>1</td> <td>PZ</td> </tr> <tr> <td>VI1220A1</td> <td>4,2X12 TCB SELF-TAPPIN G SCREW</td> <td>2</td> <td>PZ</td> </tr> <tr> <td>VM2147A0</td> <td>410X343X15 MM PINK SMOOTH ESD SPONGE</td> <td>0.250</td> <td>PZ</td> </tr> </tbody> </table>	Code	Description	Qty	UOM	PE1059A0	MM USB-RESET SUPPORT	1	PZ	VI1220A1	4,2X12 TCB SELF-TAPPIN G SCREW	2	PZ	VM2147A0	410X343X15 MM PINK SMOOTH ESD SPONGE	0.250	PZ																																				
					Code	Description	Qty	UOM																																																	
					PE1059A0	MM USB-RESET SUPPORT	1	PZ																																																	
VI1220A1	4,2X12 TCB SELF-TAPPIN G SCREW	2	PZ																																																						
VM2147A0	410X343X15 MM PINK SMOOTH ESD SPONGE	0.250	PZ																																																						





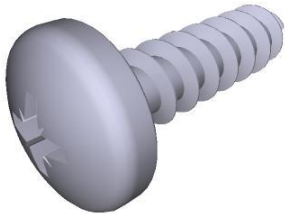

COMPONENT			SPARE PART																																		
Code	Description	Image	Code	Description	Components list																																
VM2305A	6 SERIES DOOR CAP FIXING PAWL		KVM2305A	MM FIXING DOOR THUB SCREWS 10 PCS KIT	<table border="1"> <thead> <tr> <th>Code</th> <th>Description</th> <th>Qty</th> <th>UOM</th> </tr> </thead> <tbody> <tr> <td>VM1224A0</td> <td>65MY 220MM 2 COLOURS SHRINK TUBE</td> <td>0.200</td> <td>M</td> </tr> <tr> <td>VM2305A0</td> <td>6 SERIES DOOR CAP FIXING PAWL</td> <td>10</td> <td>PZ</td> </tr> </tbody> </table>	Code	Description	Qty	UOM	VM1224A0	65MY 220MM 2 COLOURS SHRINK TUBE	0.200	M	VM2305A0	6 SERIES DOOR CAP FIXING PAWL	10	PZ																				
Code	Description	Qty	UOM																																		
VM1224A0	65MY 220MM 2 COLOURS SHRINK TUBE	0.200	M																																		
VM2305A0	6 SERIES DOOR CAP FIXING PAWL	10	PZ																																		
VM2275A	SMOOTH BUSHING		KVM2275A	SMOOTH PIN BUSHING KIT	<table border="1"> <thead> <tr> <th>Code</th> <th>Description</th> <th>Qty</th> <th>UOM</th> </tr> </thead> <tbody> <tr> <td>VM1224A0</td> <td>65MY 220MM 2 COLOURS SHRINK TUBE</td> <td>0.150</td> <td>M</td> </tr> <tr> <td>VM2275A0</td> <td>SMOOTH BUSHING</td> <td>1</td> <td>PZ</td> </tr> </tbody> </table>	Code	Description	Qty	UOM	VM1224A0	65MY 220MM 2 COLOURS SHRINK TUBE	0.150	M	VM2275A0	SMOOTH BUSHING	1	PZ																				
Code	Description	Qty	UOM																																		
VM1224A0	65MY 220MM 2 COLOURS SHRINK TUBE	0.150	M																																		
VM2275A0	SMOOTH BUSHING	1	PZ																																		
VI1996A	M5X35 SCREW		VI1996A0	M5X35 SCREW																																	
VI1074A	4X16 SCREW FOR PLASTIC		VI1074A0	4X16 SCREW FOR PLASTIC																																	
VP1081A	UPPER HINGE CAP FOR UPPER INNER GLASS		KVM2384B	MM- M LEFT DOOR RIGHT LOWER CAP KIT	<table border="1"> <thead> <tr> <th>Code</th> <th>Description</th> <th>Qty</th> <th>UOM</th> </tr> </thead> <tbody> <tr> <td>VI1074A0</td> <td>4X16 SCREW FOR PLASTIC</td> <td>1</td> <td>PZ</td> </tr> <tr> <td>VI1930A1</td> <td>ST. STEEL 5X20 CHIP SCREW</td> <td>4</td> <td>PZ</td> </tr> <tr> <td>VI1996A0</td> <td>M5X35 SCREW</td> <td>2</td> <td>PZ</td> </tr> <tr> <td>VM2274A0</td> <td>GROOVED BUSHING</td> <td>1</td> <td>PZ</td> </tr> <tr> <td>VM2305A0</td> <td>6 SERIES DOOR CAP FIXING PAWL</td> <td>3</td> <td>PZ</td> </tr> <tr> <td>VM2384B0</td> <td></td> <td>1</td> <td>PZ</td> </tr> <tr> <td>VP1081A0</td> <td>UPPER HINGE CAP FOR UPPER INNER GLASS</td> <td>1</td> <td>PZ</td> </tr> </tbody> </table>	Code	Description	Qty	UOM	VI1074A0	4X16 SCREW FOR PLASTIC	1	PZ	VI1930A1	ST. STEEL 5X20 CHIP SCREW	4	PZ	VI1996A0	M5X35 SCREW	2	PZ	VM2274A0	GROOVED BUSHING	1	PZ	VM2305A0	6 SERIES DOOR CAP FIXING PAWL	3	PZ	VM2384B0		1	PZ	VP1081A0	UPPER HINGE CAP FOR UPPER INNER GLASS	1	PZ
Code	Description	Qty	UOM																																		
VI1074A0	4X16 SCREW FOR PLASTIC	1	PZ																																		
VI1930A1	ST. STEEL 5X20 CHIP SCREW	4	PZ																																		
VI1996A0	M5X35 SCREW	2	PZ																																		
VM2274A0	GROOVED BUSHING	1	PZ																																		
VM2305A0	6 SERIES DOOR CAP FIXING PAWL	3	PZ																																		
VM2384B0		1	PZ																																		
VP1081A0	UPPER HINGE CAP FOR UPPER INNER GLASS	1	PZ																																		



COMPONENT			SPARE PART																																						
Code	Description	Image	Code	Description	Components list																																				
VP1081A	UPPER HINGE CAP FOR UPPER INNER GLASS		KVM2260B	MM M RIGHT DOOR -LEFT UPPER CAP KI	<table border="1"> <thead> <tr> <th>Code</th> <th>Description</th> <th>Qty</th> <th>UOM</th> </tr> </thead> <tbody> <tr> <td>VI1103A0</td> <td>40X12 TBSP SCREW FOR PLASTIC</td> <td>1</td> <td>PZ</td> </tr> <tr> <td>VI1930A1</td> <td>ST. STEEL 5X20 CHIP SCREW</td> <td>4</td> <td>PZ</td> </tr> <tr> <td>VI1996A0</td> <td>M5X35 SCREW</td> <td>2</td> <td>PZ</td> </tr> <tr> <td>VM1224A0</td> <td>65MY 220MM 2 COLOURS SHRINK TUBE</td> <td>0.300</td> <td>M</td> </tr> <tr> <td>VM2260B0</td> <td>S6 LEFT UPPER CAP</td> <td>1</td> <td>PZ</td> </tr> <tr> <td>VM2275A0</td> <td>SMOOTH BUSHING</td> <td>1</td> <td>PZ</td> </tr> <tr> <td>VM2305A0</td> <td>6 SERIES DOOR CAP FIXING PAWL</td> <td>3</td> <td>PZ</td> </tr> <tr> <td>VP1081A0</td> <td>UPPER HINGE CAP FOR UPPER INNER GLASS</td> <td>1</td> <td>PZ</td> </tr> </tbody> </table>	Code	Description	Qty	UOM	VI1103A0	40X12 TBSP SCREW FOR PLASTIC	1	PZ	VI1930A1	ST. STEEL 5X20 CHIP SCREW	4	PZ	VI1996A0	M5X35 SCREW	2	PZ	VM1224A0	65MY 220MM 2 COLOURS SHRINK TUBE	0.300	M	VM2260B0	S6 LEFT UPPER CAP	1	PZ	VM2275A0	SMOOTH BUSHING	1	PZ	VM2305A0	6 SERIES DOOR CAP FIXING PAWL	3	PZ	VP1081A0	UPPER HINGE CAP FOR UPPER INNER GLASS	1	PZ
Code	Description	Qty	UOM																																						
VI1103A0	40X12 TBSP SCREW FOR PLASTIC	1	PZ																																						
VI1930A1	ST. STEEL 5X20 CHIP SCREW	4	PZ																																						
VI1996A0	M5X35 SCREW	2	PZ																																						
VM1224A0	65MY 220MM 2 COLOURS SHRINK TUBE	0.300	M																																						
VM2260B0	S6 LEFT UPPER CAP	1	PZ																																						
VM2275A0	SMOOTH BUSHING	1	PZ																																						
VM2305A0	6 SERIES DOOR CAP FIXING PAWL	3	PZ																																						
VP1081A0	UPPER HINGE CAP FOR UPPER INNER GLASS	1	PZ																																						
VM2260B	S6 LEFT UPPER CAP		KVM2260B	MM M RIGHT DOOR -LEFT UPPER CAP KI	<table border="1"> <thead> <tr> <th>Code</th> <th>Description</th> <th>Qty</th> <th>UOM</th> </tr> </thead> <tbody> <tr> <td>VI1103A0</td> <td>40X12 TBSP SCREW FOR PLASTIC</td> <td>1</td> <td>PZ</td> </tr> <tr> <td>VI1930A1</td> <td>ST. STEEL 5X20 CHIP SCREW</td> <td>4</td> <td>PZ</td> </tr> <tr> <td>VI1996A0</td> <td>M5X35 SCREW</td> <td>2</td> <td>PZ</td> </tr> <tr> <td>VM1224A0</td> <td>65MY 220MM 2 COLOURS SHRINK TUBE</td> <td>0.300</td> <td>M</td> </tr> <tr> <td>VM2260B0</td> <td>S6 LEFT UPPER CAP</td> <td>1</td> <td>PZ</td> </tr> <tr> <td>VM2275A0</td> <td>SMOOTH BUSHING</td> <td>1</td> <td>PZ</td> </tr> <tr> <td>VM2305A0</td> <td>6 SERIES DOOR CAP FIXING PAWL</td> <td>3</td> <td>PZ</td> </tr> <tr> <td>VP1081A0</td> <td>UPPER HINGE CAP FOR UPPER INNER GLASS</td> <td>1</td> <td>PZ</td> </tr> </tbody> </table>	Code	Description	Qty	UOM	VI1103A0	40X12 TBSP SCREW FOR PLASTIC	1	PZ	VI1930A1	ST. STEEL 5X20 CHIP SCREW	4	PZ	VI1996A0	M5X35 SCREW	2	PZ	VM1224A0	65MY 220MM 2 COLOURS SHRINK TUBE	0.300	M	VM2260B0	S6 LEFT UPPER CAP	1	PZ	VM2275A0	SMOOTH BUSHING	1	PZ	VM2305A0	6 SERIES DOOR CAP FIXING PAWL	3	PZ	VP1081A0	UPPER HINGE CAP FOR UPPER INNER GLASS	1	PZ
Code	Description	Qty	UOM																																						
VI1103A0	40X12 TBSP SCREW FOR PLASTIC	1	PZ																																						
VI1930A1	ST. STEEL 5X20 CHIP SCREW	4	PZ																																						
VI1996A0	M5X35 SCREW	2	PZ																																						
VM1224A0	65MY 220MM 2 COLOURS SHRINK TUBE	0.300	M																																						
VM2260B0	S6 LEFT UPPER CAP	1	PZ																																						
VM2275A0	SMOOTH BUSHING	1	PZ																																						
VM2305A0	6 SERIES DOOR CAP FIXING PAWL	3	PZ																																						
VP1081A0	UPPER HINGE CAP FOR UPPER INNER GLASS	1	PZ																																						
VI1930A	ST. STEEL 5X20 CHIP SCREW		VI1930A1	ST. STEEL 5X20 CHIP SCREW																																					

COMPONENT			SPARE PART																																																							
Code	Description	Image	Code	Description	Components list																																																					
VM2274A	GROOVED BUSHING		KVM2274A	GROOVED PIN BUSHING KIT	<table border="1"> <thead> <tr> <th>Code</th> <th>Description</th> <th>Qty</th> <th>UOM</th> </tr> </thead> <tbody> <tr> <td>VM1224A0</td> <td>65MY 220MM 2 COLOURS SHRINK TUBE</td> <td>0.150</td> <td>M</td> </tr> <tr> <td>VM2274A0</td> <td>GROOVED BUSHING</td> <td>1</td> <td>PZ</td> </tr> </tbody> </table>	Code	Description	Qty	UOM	VM1224A0	65MY 220MM 2 COLOURS SHRINK TUBE	0.150	M	VM2274A0	GROOVED BUSHING	1	PZ																																									
			Code	Description	Qty	UOM																																																				
VM1224A0	65MY 220MM 2 COLOURS SHRINK TUBE	0.150	M																																																							
VM2274A0	GROOVED BUSHING	1	PZ																																																							
K0B1126AR	BAKERTOP MM RIGHT DOOR LOWER BEAM KIT	<table border="1"> <thead> <tr> <th>Code</th> <th>Description</th> <th>Qty</th> <th>UOM</th> </tr> </thead> <tbody> <tr> <td>0B1126A0</td> <td>DOOR LOWER FRAME SHAPE 860 MM</td> <td>1</td> <td>PZ</td> </tr> <tr> <td>0B1126A1</td> <td></td> <td>1</td> <td>PZ</td> </tr> <tr> <td>RC1200A0</td> <td>ED=4 WIRE D.=0.5 COMPRESSIO N SPRING</td> <td>2</td> <td>PZ</td> </tr> <tr> <td>VI1220A1</td> <td>4,2X12 TCB SELF-TAPPIN G SCREW</td> <td>1</td> <td>PZ</td> </tr> <tr> <td>VI1996A0</td> <td>M5X35 SCREW</td> <td>7</td> <td>PZ</td> </tr> <tr> <td>VM1794A0</td> <td>250X4.8 PA66 BLACK CLAMP</td> <td>2</td> <td>PZ</td> </tr> <tr> <td>VM2103A0</td> <td>CLAMP LOCK</td> <td>2</td> <td>PZ</td> </tr> <tr> <td>VM2259A1</td> <td>6 SERIES DOOR LOWER LEFT CAP</td> <td>1</td> <td>PZ</td> </tr> <tr> <td>VM2261A1</td> <td>6 SERIES DOOR LOWER RIGHT CAP</td> <td>1</td> <td>PZ</td> </tr> <tr> <td>VM2267A0</td> <td>INTERNAL GLASS LOCKING SYSTEM SLIDER</td> <td>1</td> <td>PZ</td> </tr> <tr> <td>VM2269A0</td> <td>INTERNAL GLASS LOCKING SYSTEM CAP</td> <td>1</td> <td>PZ</td> </tr> <tr> <td>VM2274A0</td> <td>GROOVED BUSHING</td> <td>1</td> <td>PZ</td> </tr> <tr> <td>VM2305A0</td> <td>6 SERIES DOOR CAP FIXING PAWL</td> <td>7</td> <td>PZ</td> </tr> </tbody> </table>	Code	Description	Qty	UOM	0B1126A0	DOOR LOWER FRAME SHAPE 860 MM	1	PZ	0B1126A1		1	PZ	RC1200A0	ED=4 WIRE D.=0.5 COMPRESSIO N SPRING	2	PZ	VI1220A1	4,2X12 TCB SELF-TAPPIN G SCREW	1	PZ	VI1996A0	M5X35 SCREW	7	PZ	VM1794A0	250X4.8 PA66 BLACK CLAMP	2	PZ	VM2103A0	CLAMP LOCK	2	PZ	VM2259A1	6 SERIES DOOR LOWER LEFT CAP	1	PZ	VM2261A1	6 SERIES DOOR LOWER RIGHT CAP	1	PZ	VM2267A0	INTERNAL GLASS LOCKING SYSTEM SLIDER	1	PZ	VM2269A0	INTERNAL GLASS LOCKING SYSTEM CAP	1	PZ	VM2274A0	GROOVED BUSHING	1	PZ	VM2305A0	6 SERIES DOOR CAP FIXING PAWL	7	PZ
Code	Description	Qty	UOM																																																							
0B1126A0	DOOR LOWER FRAME SHAPE 860 MM	1	PZ																																																							
0B1126A1		1	PZ																																																							
RC1200A0	ED=4 WIRE D.=0.5 COMPRESSIO N SPRING	2	PZ																																																							
VI1220A1	4,2X12 TCB SELF-TAPPIN G SCREW	1	PZ																																																							
VI1996A0	M5X35 SCREW	7	PZ																																																							
VM1794A0	250X4.8 PA66 BLACK CLAMP	2	PZ																																																							
VM2103A0	CLAMP LOCK	2	PZ																																																							
VM2259A1	6 SERIES DOOR LOWER LEFT CAP	1	PZ																																																							
VM2261A1	6 SERIES DOOR LOWER RIGHT CAP	1	PZ																																																							
VM2267A0	INTERNAL GLASS LOCKING SYSTEM SLIDER	1	PZ																																																							
VM2269A0	INTERNAL GLASS LOCKING SYSTEM CAP	1	PZ																																																							
VM2274A0	GROOVED BUSHING	1	PZ																																																							
VM2305A0	6 SERIES DOOR CAP FIXING PAWL	7	PZ																																																							
K0B1126AL	EU AND 2/1 MM LEFT DOOR LOWER BEAM KIT	<table border="1"> <thead> <tr> <th>Code</th> <th>Description</th> <th>Qty</th> <th>UOM</th> </tr> </thead> <tbody> <tr> <td>0B1126A0</td> <td>DOOR LOWER FRAME SHAPE 860 MM</td> <td>1</td> <td>PZ</td> </tr> <tr> <td>0B1126A1</td> <td></td> <td>1</td> <td>PZ</td> </tr> <tr> <td>RC1200A0</td> <td>ED=4 WIRE D.=0.5 COMPRESSIO N SPRING</td> <td>2</td> <td>PZ</td> </tr> <tr> <td>VI1220A1</td> <td>4,2X12 TCB SELF-TAPPIN G SCREW</td> <td>1</td> <td>PZ</td> </tr> <tr> <td>VI1996A0</td> <td>M5X35 SCREW</td> <td>7</td> <td>PZ</td> </tr> </tbody> </table>	Code	Description	Qty	UOM	0B1126A0	DOOR LOWER FRAME SHAPE 860 MM	1	PZ	0B1126A1		1	PZ	RC1200A0	ED=4 WIRE D.=0.5 COMPRESSIO N SPRING	2	PZ	VI1220A1	4,2X12 TCB SELF-TAPPIN G SCREW	1	PZ	VI1996A0	M5X35 SCREW	7	PZ																																
Code	Description	Qty	UOM																																																							
0B1126A0	DOOR LOWER FRAME SHAPE 860 MM	1	PZ																																																							
0B1126A1		1	PZ																																																							
RC1200A0	ED=4 WIRE D.=0.5 COMPRESSIO N SPRING	2	PZ																																																							
VI1220A1	4,2X12 TCB SELF-TAPPIN G SCREW	1	PZ																																																							
VI1996A0	M5X35 SCREW	7	PZ																																																							

COMPONENT			SPARE PART																																														
Code	Description	Image	Code	Description	Components list																																												
VM2274A	GROOVED BUSHING		K0B1126AL	EU AND 2/1 MM LEFT DOOR LOWER BEAM KIT	<table border="1"> <thead> <tr> <th>Code</th> <th>Description</th> <th>Qty</th> <th>UOM</th> </tr> </thead> <tbody> <tr> <td>VM1794A0</td> <td>250X4.8 PA66 BLACK CLAMP</td> <td>2</td> <td>PZ</td> </tr> <tr> <td>VM2103A0</td> <td>CLAMP LOCK</td> <td>2</td> <td>PZ</td> </tr> <tr> <td>VM2267A0</td> <td>INTERNAL GLASS LOCKING SYSTEM SLIDER</td> <td>1</td> <td>PZ</td> </tr> <tr> <td>VM2269A0</td> <td>INTERNAL GLASS LOCKING SYSTEM CAP</td> <td>1</td> <td>PZ</td> </tr> <tr> <td>VM2274A0</td> <td>GROOVED BUSHING</td> <td>1</td> <td>PZ</td> </tr> <tr> <td>VM2305A0</td> <td>6 SERIES DOOR CAP FIXING PAWL</td> <td>7</td> <td>PZ</td> </tr> <tr> <td>VM2384A0</td> <td>MM LEFT DOOR RIGHT LOWER CAP</td> <td>1</td> <td>PZ</td> </tr> <tr> <td>VM2384A0</td> <td>MM LEFT DOOR RIGHT LOWER CAP</td> <td>1</td> <td>PZ</td> </tr> <tr> <td>VM2386A1</td> <td>LEFT MM DOOR LOWER LEFT CAP</td> <td>1</td> <td>PZ</td> </tr> <tr> <td>VM2386A1</td> <td>LEFT MM DOOR LOWER LEFT CAP</td> <td>1</td> <td>PZ</td> </tr> </tbody> </table>	Code	Description	Qty	UOM	VM1794A0	250X4.8 PA66 BLACK CLAMP	2	PZ	VM2103A0	CLAMP LOCK	2	PZ	VM2267A0	INTERNAL GLASS LOCKING SYSTEM SLIDER	1	PZ	VM2269A0	INTERNAL GLASS LOCKING SYSTEM CAP	1	PZ	VM2274A0	GROOVED BUSHING	1	PZ	VM2305A0	6 SERIES DOOR CAP FIXING PAWL	7	PZ	VM2384A0	MM LEFT DOOR RIGHT LOWER CAP	1	PZ	VM2384A0	MM LEFT DOOR RIGHT LOWER CAP	1	PZ	VM2386A1	LEFT MM DOOR LOWER LEFT CAP	1	PZ	VM2386A1	LEFT MM DOOR LOWER LEFT CAP	1	PZ
			Code	Description	Qty	UOM																																											
VM1794A0	250X4.8 PA66 BLACK CLAMP	2	PZ																																														
VM2103A0	CLAMP LOCK	2	PZ																																														
VM2267A0	INTERNAL GLASS LOCKING SYSTEM SLIDER	1	PZ																																														
VM2269A0	INTERNAL GLASS LOCKING SYSTEM CAP	1	PZ																																														
VM2274A0	GROOVED BUSHING	1	PZ																																														
VM2305A0	6 SERIES DOOR CAP FIXING PAWL	7	PZ																																														
VM2384A0	MM LEFT DOOR RIGHT LOWER CAP	1	PZ																																														
VM2384A0	MM LEFT DOOR RIGHT LOWER CAP	1	PZ																																														
VM2386A1	LEFT MM DOOR LOWER LEFT CAP	1	PZ																																														
VM2386A1	LEFT MM DOOR LOWER LEFT CAP	1	PZ																																														
K0B1122AR	CHEFTOP MM RIGHT DOOR LOWER BEAM KIT	<table border="1"> <thead> <tr> <th>Code</th> <th>Description</th> <th>Qty</th> <th>UOM</th> </tr> </thead> <tbody> <tr> <td>0B1122A0</td> <td>750MM DOOR LOWER FRAME SHAPE</td> <td>1</td> <td>PZ</td> </tr> <tr> <td>0B1122A1</td> <td>750MM DOOR LOWER FRAME SHAPE</td> <td>1</td> <td>PZ</td> </tr> <tr> <td>RC1200A0</td> <td>ED=4 WIRE D.=0.5 COMPRESSIO N SPRING</td> <td>2</td> <td>PZ</td> </tr> <tr> <td>VI1220A1</td> <td>4,2X12 TCB SELF-TAPPIN G SCREW</td> <td>1</td> <td>PZ</td> </tr> <tr> <td>VI1996A0</td> <td>M5X35 SCREW</td> <td>7</td> <td>PZ</td> </tr> <tr> <td>VM1794A0</td> <td>250X4.8 PA66 BLACK CLAMP</td> <td>2</td> <td>PZ</td> </tr> <tr> <td>VM2103A0</td> <td>CLAMP LOCK</td> <td>2</td> <td>PZ</td> </tr> <tr> <td>VM2259A1</td> <td>6 SERIES DOOR LOWER LEFT CAP</td> <td>1</td> <td>PZ</td> </tr> <tr> <td>VM2261A1</td> <td>6 SERIES DOOR LOWER RIGHT CAP</td> <td>1</td> <td>PZ</td> </tr> </tbody> </table>	Code	Description	Qty	UOM	0B1122A0	750MM DOOR LOWER FRAME SHAPE	1	PZ	0B1122A1	750MM DOOR LOWER FRAME SHAPE	1	PZ	RC1200A0	ED=4 WIRE D.=0.5 COMPRESSIO N SPRING	2	PZ	VI1220A1	4,2X12 TCB SELF-TAPPIN G SCREW	1	PZ	VI1996A0	M5X35 SCREW	7	PZ	VM1794A0	250X4.8 PA66 BLACK CLAMP	2	PZ	VM2103A0	CLAMP LOCK	2	PZ	VM2259A1	6 SERIES DOOR LOWER LEFT CAP	1	PZ	VM2261A1	6 SERIES DOOR LOWER RIGHT CAP	1	PZ							
Code	Description	Qty	UOM																																														
0B1122A0	750MM DOOR LOWER FRAME SHAPE	1	PZ																																														
0B1122A1	750MM DOOR LOWER FRAME SHAPE	1	PZ																																														
RC1200A0	ED=4 WIRE D.=0.5 COMPRESSIO N SPRING	2	PZ																																														
VI1220A1	4,2X12 TCB SELF-TAPPIN G SCREW	1	PZ																																														
VI1996A0	M5X35 SCREW	7	PZ																																														
VM1794A0	250X4.8 PA66 BLACK CLAMP	2	PZ																																														
VM2103A0	CLAMP LOCK	2	PZ																																														
VM2259A1	6 SERIES DOOR LOWER LEFT CAP	1	PZ																																														
VM2261A1	6 SERIES DOOR LOWER RIGHT CAP	1	PZ																																														



COMPONENT			SPARE PART																																																															
Code	Description	Image	Code	Description	Components list																																																													
VM2274A	GROOVED BUSHING		K0B1122AR	CHEFTOP MM RIGHT DOOR LOWER BEAM KIT	<table border="1"> <thead> <tr> <th>Code</th> <th>Description</th> <th>Qty</th> <th>UOM</th> </tr> </thead> <tbody> <tr> <td>VM2267A0</td> <td>INTERNAL GLASS LOCKING SYSTEM SLIDER</td> <td>1</td> <td>PZ</td> </tr> <tr> <td>VM2269A0</td> <td>INTERNAL GLASS LOCKING SYSTEM CAP</td> <td>1</td> <td>PZ</td> </tr> <tr> <td>VM2274A0</td> <td>GROOVED BUSHING</td> <td>1</td> <td>PZ</td> </tr> <tr> <td>VM2305A0</td> <td>6 SERIES DOOR CAP FIXING PAWL</td> <td>7</td> <td>PZ</td> </tr> </tbody> </table>	Code	Description	Qty	UOM	VM2267A0	INTERNAL GLASS LOCKING SYSTEM SLIDER	1	PZ	VM2269A0	INTERNAL GLASS LOCKING SYSTEM CAP	1	PZ	VM2274A0	GROOVED BUSHING	1	PZ	VM2305A0	6 SERIES DOOR CAP FIXING PAWL	7	PZ																																									
			Code	Description	Qty	UOM																																																												
VM2267A0	INTERNAL GLASS LOCKING SYSTEM SLIDER	1	PZ																																																															
VM2269A0	INTERNAL GLASS LOCKING SYSTEM CAP	1	PZ																																																															
VM2274A0	GROOVED BUSHING	1	PZ																																																															
VM2305A0	6 SERIES DOOR CAP FIXING PAWL	7	PZ																																																															
K0B1122AL	CHEFTOP MM LEFT DOOR LOWER BEAM KIT	<table border="1"> <thead> <tr> <th>Code</th> <th>Description</th> <th>Qty</th> <th>UOM</th> </tr> </thead> <tbody> <tr> <td>0B1122A0</td> <td>750MM DOOR LOWER FRAME SHAPE</td> <td>1</td> <td>PZ</td> </tr> <tr> <td>0B1122A1</td> <td>750MM DOOR LOWER FRAME SHAPE</td> <td>1</td> <td>PZ</td> </tr> <tr> <td>RC1200A0</td> <td>ED=4 WIRE D.=0.5 COMPRESSION N SPRING</td> <td>2</td> <td>PZ</td> </tr> <tr> <td>VI1220A1</td> <td>4,2X12 TCB SELF-TAPPING G SCREW</td> <td>1</td> <td>PZ</td> </tr> <tr> <td>VI1996A0</td> <td>M5X35 SCREW</td> <td>7</td> <td>PZ</td> </tr> <tr> <td>VM1794A0</td> <td>250X4.8 PA66 BLACK CLAMP</td> <td>2</td> <td>PZ</td> </tr> <tr> <td>VM2103A0</td> <td>CLAMP LOCK</td> <td>2</td> <td>PZ</td> </tr> <tr> <td>VM2267A0</td> <td>INTERNAL GLASS LOCKING SYSTEM SLIDER</td> <td>1</td> <td>PZ</td> </tr> <tr> <td>VM2269A0</td> <td>INTERNAL GLASS LOCKING SYSTEM CAP</td> <td>1</td> <td>PZ</td> </tr> <tr> <td>VM2274A0</td> <td>GROOVED BUSHING</td> <td>1</td> <td>PZ</td> </tr> <tr> <td>VM2305A0</td> <td>6 SERIES DOOR CAP FIXING PAWL</td> <td>7</td> <td>PZ</td> </tr> <tr> <td>VM2384A0</td> <td>MM LEFT DOOR RIGHT LOWER CAP</td> <td>1</td> <td>PZ</td> </tr> <tr> <td>VM2384A0</td> <td>MM LEFT DOOR RIGHT LOWER CAP</td> <td>1</td> <td>PZ</td> </tr> <tr> <td>VM2386A1</td> <td>LEFT MM DOOR LOWER LEFT CAP</td> <td>1</td> <td>PZ</td> </tr> <tr> <td>VM2386A1</td> <td>LEFT MM DOOR LOWER LEFT CAP</td> <td>1</td> <td>PZ</td> </tr> </tbody> </table>	Code	Description	Qty	UOM	0B1122A0	750MM DOOR LOWER FRAME SHAPE	1	PZ	0B1122A1	750MM DOOR LOWER FRAME SHAPE	1	PZ	RC1200A0	ED=4 WIRE D.=0.5 COMPRESSION N SPRING	2	PZ	VI1220A1	4,2X12 TCB SELF-TAPPING G SCREW	1	PZ	VI1996A0	M5X35 SCREW	7	PZ	VM1794A0	250X4.8 PA66 BLACK CLAMP	2	PZ	VM2103A0	CLAMP LOCK	2	PZ	VM2267A0	INTERNAL GLASS LOCKING SYSTEM SLIDER	1	PZ	VM2269A0	INTERNAL GLASS LOCKING SYSTEM CAP	1	PZ	VM2274A0	GROOVED BUSHING	1	PZ	VM2305A0	6 SERIES DOOR CAP FIXING PAWL	7	PZ	VM2384A0	MM LEFT DOOR RIGHT LOWER CAP	1	PZ	VM2384A0	MM LEFT DOOR RIGHT LOWER CAP	1	PZ	VM2386A1	LEFT MM DOOR LOWER LEFT CAP	1	PZ	VM2386A1	LEFT MM DOOR LOWER LEFT CAP	1	PZ
Code	Description	Qty	UOM																																																															
0B1122A0	750MM DOOR LOWER FRAME SHAPE	1	PZ																																																															
0B1122A1	750MM DOOR LOWER FRAME SHAPE	1	PZ																																																															
RC1200A0	ED=4 WIRE D.=0.5 COMPRESSION N SPRING	2	PZ																																																															
VI1220A1	4,2X12 TCB SELF-TAPPING G SCREW	1	PZ																																																															
VI1996A0	M5X35 SCREW	7	PZ																																																															
VM1794A0	250X4.8 PA66 BLACK CLAMP	2	PZ																																																															
VM2103A0	CLAMP LOCK	2	PZ																																																															
VM2267A0	INTERNAL GLASS LOCKING SYSTEM SLIDER	1	PZ																																																															
VM2269A0	INTERNAL GLASS LOCKING SYSTEM CAP	1	PZ																																																															
VM2274A0	GROOVED BUSHING	1	PZ																																																															
VM2305A0	6 SERIES DOOR CAP FIXING PAWL	7	PZ																																																															
VM2384A0	MM LEFT DOOR RIGHT LOWER CAP	1	PZ																																																															
VM2384A0	MM LEFT DOOR RIGHT LOWER CAP	1	PZ																																																															
VM2386A1	LEFT MM DOOR LOWER LEFT CAP	1	PZ																																																															
VM2386A1	LEFT MM DOOR LOWER LEFT CAP	1	PZ																																																															

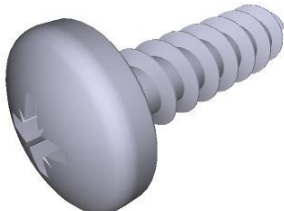

COMPONENT			SPARE PART																																		
Code	Description	Image	Code	Description	Components list																																
VM2305A	6 SERIES DOOR CAP FIXING PAWL		KVM2305A	MM FIXING DOOR THUB SCREWS 10 PCS KIT	<table border="1"> <thead> <tr> <th>Code</th> <th>Description</th> <th>Qty</th> <th>UOM</th> </tr> </thead> <tbody> <tr> <td>VM1224A0</td> <td>65MY 220MM 2 COLOURS SHRINK TUBE</td> <td>0.200</td> <td>M</td> </tr> <tr> <td>VM2305A0</td> <td>6 SERIES DOOR CAP FIXING PAWL</td> <td>10</td> <td>PZ</td> </tr> </tbody> </table>	Code	Description	Qty	UOM	VM1224A0	65MY 220MM 2 COLOURS SHRINK TUBE	0.200	M	VM2305A0	6 SERIES DOOR CAP FIXING PAWL	10	PZ																				
Code	Description	Qty	UOM																																		
VM1224A0	65MY 220MM 2 COLOURS SHRINK TUBE	0.200	M																																		
VM2305A0	6 SERIES DOOR CAP FIXING PAWL	10	PZ																																		
VI1996A	M5X35 SCREW		VI1996A0	M5X35 SCREW																																	
VI1074A	4X16 SCREW FOR PLASTIC		VI1074A0	4X16 SCREW FOR PLASTIC																																	
VP1080A	UPPER HINGE CAP FOR LOWER INNER GLASS		KVM2383B	MM -M LEFT DOOR RIGHT UPPER CAP KIT	<table border="1"> <thead> <tr> <th>Code</th> <th>Description</th> <th>Qty</th> <th>UOM</th> </tr> </thead> <tbody> <tr> <td>VI1074A0</td> <td>4X16 SCREW FOR PLASTIC</td> <td>1</td> <td>PZ</td> </tr> <tr> <td>VI1930A1</td> <td>ST. STEEL 5X20 CHIP SCREW</td> <td>4</td> <td>PZ</td> </tr> <tr> <td>VI1996A0</td> <td>M5X35 SCREW</td> <td>3</td> <td>PZ</td> </tr> <tr> <td>VM2275A0</td> <td>SMOOTH BUSHING</td> <td>1</td> <td>PZ</td> </tr> <tr> <td>VM2305A0</td> <td>6 SERIES DOOR CAP FIXING PAWL</td> <td>3</td> <td>PZ</td> </tr> <tr> <td>VM2383B0</td> <td>S6 LEFT OVENS UPPER RIGHT CAP</td> <td>1</td> <td>PZ</td> </tr> <tr> <td>VP1080A0</td> <td>UPPER HINGE CAP FOR LOWER INNER GLASS</td> <td>1</td> <td>PZ</td> </tr> </tbody> </table>	Code	Description	Qty	UOM	VI1074A0	4X16 SCREW FOR PLASTIC	1	PZ	VI1930A1	ST. STEEL 5X20 CHIP SCREW	4	PZ	VI1996A0	M5X35 SCREW	3	PZ	VM2275A0	SMOOTH BUSHING	1	PZ	VM2305A0	6 SERIES DOOR CAP FIXING PAWL	3	PZ	VM2383B0	S6 LEFT OVENS UPPER RIGHT CAP	1	PZ	VP1080A0	UPPER HINGE CAP FOR LOWER INNER GLASS	1	PZ
Code	Description	Qty	UOM																																		
VI1074A0	4X16 SCREW FOR PLASTIC	1	PZ																																		
VI1930A1	ST. STEEL 5X20 CHIP SCREW	4	PZ																																		
VI1996A0	M5X35 SCREW	3	PZ																																		
VM2275A0	SMOOTH BUSHING	1	PZ																																		
VM2305A0	6 SERIES DOOR CAP FIXING PAWL	3	PZ																																		
VM2383B0	S6 LEFT OVENS UPPER RIGHT CAP	1	PZ																																		
VP1080A0	UPPER HINGE CAP FOR LOWER INNER GLASS	1	PZ																																		
			KVM2259B	MM -M RIGHT DOOR LEFT LOWER CAP KI	<table border="1"> <thead> <tr> <th>Code</th> <th>Description</th> <th>Qty</th> <th>UOM</th> </tr> </thead> <tbody> <tr> <td>VI1103A0</td> <td>40X12 TBSP SCREW FOR PLASTIC</td> <td>1</td> <td>PZ</td> </tr> </tbody> </table>	Code	Description	Qty	UOM	VI1103A0	40X12 TBSP SCREW FOR PLASTIC	1	PZ																								
Code	Description	Qty	UOM																																		
VI1103A0	40X12 TBSP SCREW FOR PLASTIC	1	PZ																																		

COMPONENT			SPARE PART																																						
Code	Description	Image	Code	Description	Components list																																				
VP1080A	UPPER HINGE CAP FOR LOWER INNER GLASS		KVM2259B	MM -M RIGHT DOOR LEFT LOWER CAP KI	<table border="1"> <thead> <tr> <th>Code</th> <th>Description</th> <th>Qty</th> <th>UOM</th> </tr> </thead> <tbody> <tr> <td>VI1930A1</td> <td>ST. STEEL 5X20 CHIP SCREW</td> <td>4</td> <td>PZ</td> </tr> <tr> <td>VI1996A0</td> <td>M5X35 SCREW</td> <td>3</td> <td>PZ</td> </tr> <tr> <td>VM1224A0</td> <td>65MY 220MM 2 COLOURS SHRINK TUBE</td> <td>0.300</td> <td>M</td> </tr> <tr> <td>VM2259B0</td> <td></td> <td>1</td> <td>PZ</td> </tr> <tr> <td>VM2274A0</td> <td>GROOVED BUSHING</td> <td>1</td> <td>PZ</td> </tr> <tr> <td>VM2305A0</td> <td>6 SERIES DOOR CAP FIXING PAWL</td> <td>3</td> <td>PZ</td> </tr> <tr> <td>VP1080A0</td> <td>UPPER HINGE CAP FOR LOWER INNER GLASS</td> <td>1</td> <td>PZ</td> </tr> </tbody> </table>	Code	Description	Qty	UOM	VI1930A1	ST. STEEL 5X20 CHIP SCREW	4	PZ	VI1996A0	M5X35 SCREW	3	PZ	VM1224A0	65MY 220MM 2 COLOURS SHRINK TUBE	0.300	M	VM2259B0		1	PZ	VM2274A0	GROOVED BUSHING	1	PZ	VM2305A0	6 SERIES DOOR CAP FIXING PAWL	3	PZ	VP1080A0	UPPER HINGE CAP FOR LOWER INNER GLASS	1	PZ				
Code	Description	Qty	UOM																																						
VI1930A1	ST. STEEL 5X20 CHIP SCREW	4	PZ																																						
VI1996A0	M5X35 SCREW	3	PZ																																						
VM1224A0	65MY 220MM 2 COLOURS SHRINK TUBE	0.300	M																																						
VM2259B0		1	PZ																																						
VM2274A0	GROOVED BUSHING	1	PZ																																						
VM2305A0	6 SERIES DOOR CAP FIXING PAWL	3	PZ																																						
VP1080A0	UPPER HINGE CAP FOR LOWER INNER GLASS	1	PZ																																						
VM2259B			KVM2259B	MM -M RIGHT DOOR LEFT LOWER CAP KI	<table border="1"> <thead> <tr> <th>Code</th> <th>Description</th> <th>Qty</th> <th>UOM</th> </tr> </thead> <tbody> <tr> <td>VI1103A0</td> <td>40X12 TBSP SCREW FOR PLASTIC</td> <td>1</td> <td>PZ</td> </tr> <tr> <td>VI1930A1</td> <td>ST. STEEL 5X20 CHIP SCREW</td> <td>4</td> <td>PZ</td> </tr> <tr> <td>VI1996A0</td> <td>M5X35 SCREW</td> <td>3</td> <td>PZ</td> </tr> <tr> <td>VM1224A0</td> <td>65MY 220MM 2 COLOURS SHRINK TUBE</td> <td>0.300</td> <td>M</td> </tr> <tr> <td>VM2259B0</td> <td></td> <td>1</td> <td>PZ</td> </tr> <tr> <td>VM2274A0</td> <td>GROOVED BUSHING</td> <td>1</td> <td>PZ</td> </tr> <tr> <td>VM2305A0</td> <td>6 SERIES DOOR CAP FIXING PAWL</td> <td>3</td> <td>PZ</td> </tr> <tr> <td>VP1080A0</td> <td>UPPER HINGE CAP FOR LOWER INNER GLASS</td> <td>1</td> <td>PZ</td> </tr> </tbody> </table>	Code	Description	Qty	UOM	VI1103A0	40X12 TBSP SCREW FOR PLASTIC	1	PZ	VI1930A1	ST. STEEL 5X20 CHIP SCREW	4	PZ	VI1996A0	M5X35 SCREW	3	PZ	VM1224A0	65MY 220MM 2 COLOURS SHRINK TUBE	0.300	M	VM2259B0		1	PZ	VM2274A0	GROOVED BUSHING	1	PZ	VM2305A0	6 SERIES DOOR CAP FIXING PAWL	3	PZ	VP1080A0	UPPER HINGE CAP FOR LOWER INNER GLASS	1	PZ
Code	Description	Qty	UOM																																						
VI1103A0	40X12 TBSP SCREW FOR PLASTIC	1	PZ																																						
VI1930A1	ST. STEEL 5X20 CHIP SCREW	4	PZ																																						
VI1996A0	M5X35 SCREW	3	PZ																																						
VM1224A0	65MY 220MM 2 COLOURS SHRINK TUBE	0.300	M																																						
VM2259B0		1	PZ																																						
VM2274A0	GROOVED BUSHING	1	PZ																																						
VM2305A0	6 SERIES DOOR CAP FIXING PAWL	3	PZ																																						
VP1080A0	UPPER HINGE CAP FOR LOWER INNER GLASS	1	PZ																																						
VI1930A	ST. STEEL 5X20 CHIP SCREW		VI1930A1	ST. STEEL 5X20 CHIP SCREW																																					







COMPONENT			SPARE PART																																																																																									
Code	Description	Image	Code	Description	Components list																																																																																							
0B1126B			K0B1126BR	BAKERTOP MM -M RIGHT DOOR LOWER BEAM KIT	<table border="1"> <thead> <tr> <th>Code</th> <th>Description</th> <th>Qty</th> <th>UOM</th> </tr> </thead> <tbody> <tr> <td>0B1126B0</td> <td></td> <td>1</td> <td>PZ</td> </tr> <tr> <td>RC1200A0</td> <td>ED=4 WIRE D.=0.5 COMPRESSIO N SPRING</td> <td>2</td> <td>PZ</td> </tr> <tr> <td>VE1030A1</td> <td>MAGNET FOR DOOR MICROSWITC H D=22,9MM</td> <td>1</td> <td>PZ</td> </tr> <tr> <td>VI1103A0</td> <td>40X12 TBSP SCREW FOR PLASTIC</td> <td>1</td> <td>PZ</td> </tr> <tr> <td>VI1220A1</td> <td>4,2X12 TCB SELF-TAPPIN G SCREW</td> <td>1</td> <td>PZ</td> </tr> <tr> <td>VI1930A1</td> <td>ST. STEEL 5X20 CHIP SCREW</td> <td>8</td> <td>PZ</td> </tr> <tr> <td>VI1996A0</td> <td>M5X35 SCREW</td> <td>6</td> <td>PZ</td> </tr> <tr> <td>VM1794A0</td> <td>250X4.8 PA66 BLACK CLAMP</td> <td>2</td> <td>PZ</td> </tr> <tr> <td>VM2103A0</td> <td>CLAMP LOCK</td> <td>2</td> <td>PZ</td> </tr> <tr> <td>VM2267A0</td> <td>INTERNAL GLASS LOCKING SYSTEM SLIDER</td> <td>1</td> <td>PZ</td> </tr> <tr> <td>VM2268A0</td> <td>DOOR MAGNET COVER</td> <td>1</td> <td>PZ</td> </tr> <tr> <td>VM2269B0</td> <td>INNER GLASS FIXING CAP</td> <td>1</td> <td>PZ</td> </tr> <tr> <td>VM2274A0</td> <td>GROOVED BUSHING</td> <td>1</td> <td>PZ</td> </tr> <tr> <td>VM2305A0</td> <td>6 SERIES DOOR CAP FIXING PAWL</td> <td>7</td> <td>PZ</td> </tr> <tr> <td>VM2384B0</td> <td></td> <td>1</td> <td>PZ</td> </tr> <tr> <td>VM2386B0</td> <td>MM -M LEFT DOOR LEFT LOWER CAP KI</td> <td>1</td> <td>PZ</td> </tr> <tr> <td>VP1081A0</td> <td>UPPER HINGE CAP FOR UPPER INNER GLASS</td> <td>1</td> <td>PZ</td> </tr> </tbody> </table>	Code	Description	Qty	UOM	0B1126B0		1	PZ	RC1200A0	ED=4 WIRE D.=0.5 COMPRESSIO N SPRING	2	PZ	VE1030A1	MAGNET FOR DOOR MICROSWITC H D=22,9MM	1	PZ	VI1103A0	40X12 TBSP SCREW FOR PLASTIC	1	PZ	VI1220A1	4,2X12 TCB SELF-TAPPIN G SCREW	1	PZ	VI1930A1	ST. STEEL 5X20 CHIP SCREW	8	PZ	VI1996A0	M5X35 SCREW	6	PZ	VM1794A0	250X4.8 PA66 BLACK CLAMP	2	PZ	VM2103A0	CLAMP LOCK	2	PZ	VM2267A0	INTERNAL GLASS LOCKING SYSTEM SLIDER	1	PZ	VM2268A0	DOOR MAGNET COVER	1	PZ	VM2269B0	INNER GLASS FIXING CAP	1	PZ	VM2274A0	GROOVED BUSHING	1	PZ	VM2305A0	6 SERIES DOOR CAP FIXING PAWL	7	PZ	VM2384B0		1	PZ	VM2386B0	MM -M LEFT DOOR LEFT LOWER CAP KI	1	PZ	VP1081A0	UPPER HINGE CAP FOR UPPER INNER GLASS	1	PZ	K0B1126BL	EU+2/1 MM -MLEFT DOOR LOWER BEAM KIT	<table border="1"> <thead> <tr> <th>Code</th> <th>Description</th> <th>Qty</th> <th>UOM</th> </tr> </thead> <tbody> <tr> <td>0B1126B0</td> <td></td> <td>1</td> <td>PZ</td> </tr> <tr> <td>RC1200A0</td> <td>ED=4 WIRE D.=0.5 COMPRESSIO N SPRING</td> <td>2</td> <td>PZ</td> </tr> </tbody> </table>	Code	Description	Qty	UOM	0B1126B0		1	PZ	RC1200A0	ED=4 WIRE D.=0.5 COMPRESSIO N SPRING	2	PZ
			Code	Description	Qty	UOM																																																																																						
0B1126B0		1	PZ																																																																																									
RC1200A0	ED=4 WIRE D.=0.5 COMPRESSIO N SPRING	2	PZ																																																																																									
VE1030A1	MAGNET FOR DOOR MICROSWITC H D=22,9MM	1	PZ																																																																																									
VI1103A0	40X12 TBSP SCREW FOR PLASTIC	1	PZ																																																																																									
VI1220A1	4,2X12 TCB SELF-TAPPIN G SCREW	1	PZ																																																																																									
VI1930A1	ST. STEEL 5X20 CHIP SCREW	8	PZ																																																																																									
VI1996A0	M5X35 SCREW	6	PZ																																																																																									
VM1794A0	250X4.8 PA66 BLACK CLAMP	2	PZ																																																																																									
VM2103A0	CLAMP LOCK	2	PZ																																																																																									
VM2267A0	INTERNAL GLASS LOCKING SYSTEM SLIDER	1	PZ																																																																																									
VM2268A0	DOOR MAGNET COVER	1	PZ																																																																																									
VM2269B0	INNER GLASS FIXING CAP	1	PZ																																																																																									
VM2274A0	GROOVED BUSHING	1	PZ																																																																																									
VM2305A0	6 SERIES DOOR CAP FIXING PAWL	7	PZ																																																																																									
VM2384B0		1	PZ																																																																																									
VM2386B0	MM -M LEFT DOOR LEFT LOWER CAP KI	1	PZ																																																																																									
VP1081A0	UPPER HINGE CAP FOR UPPER INNER GLASS	1	PZ																																																																																									
Code	Description	Qty	UOM																																																																																									
0B1126B0		1	PZ																																																																																									
RC1200A0	ED=4 WIRE D.=0.5 COMPRESSIO N SPRING	2	PZ																																																																																									





COMPONENT			SPARE PART																																																																		
Code	Description	Image	Code	Description	Components list																																																																
0B1126B			K0B1126BL	EU+2/1 MM -MLEFT DOOR LOWER BEAM KIT	<table border="1"> <thead> <tr> <th>Code</th> <th>Description</th> <th>Qty</th> <th>UOM</th> </tr> </thead> <tbody> <tr> <td>VE1030A1</td> <td>MAGNET FOR DOOR MICROSWITC H D=22.9MM</td> <td>1</td> <td>PZ</td> </tr> <tr> <td>V11103A0</td> <td>40X12 TBSP SCREW FOR PLASTIC</td> <td>1</td> <td>PZ</td> </tr> <tr> <td>V11220A1</td> <td>4,2X12 TCB SELF-TAPPIN G SCREW</td> <td>1</td> <td>PZ</td> </tr> <tr> <td>V11930A1</td> <td>ST. STEEL 5X20 CHIP SCREW</td> <td>8</td> <td>PZ</td> </tr> <tr> <td>VI1996A0</td> <td>M5X35 SCREW</td> <td>6</td> <td>PZ</td> </tr> <tr> <td>VM1794A0</td> <td>250X4.8 PA66 BLACK CLAMP</td> <td>2</td> <td>PZ</td> </tr> <tr> <td>VM2103A0</td> <td>CLAMP LOCK</td> <td>2</td> <td>PZ</td> </tr> <tr> <td>VM2267A0</td> <td>INTERNAL GLASS LOCKING SYSTEM SLIDER</td> <td>1</td> <td>PZ</td> </tr> <tr> <td>VM2268A0</td> <td>DOOR MAGNET COVER</td> <td>1</td> <td>PZ</td> </tr> <tr> <td>VM2269B0</td> <td>INNER GLASS FIXING CAP</td> <td>1</td> <td>PZ</td> </tr> <tr> <td>VM2274A0</td> <td>GROOVED BUSHING</td> <td>1</td> <td>PZ</td> </tr> <tr> <td>VM2305A0</td> <td>6 SERIES DOOR CAP FIXING PAWL</td> <td>7</td> <td>PZ</td> </tr> <tr> <td>VM2384B0</td> <td></td> <td>1</td> <td>PZ</td> </tr> <tr> <td>VM2386B0</td> <td>MM -M LEFT DOOR LEFT LOWER CAP KI</td> <td>1</td> <td>PZ</td> </tr> <tr> <td>VP1081A0</td> <td>UPPER HINGE CAP FOR UPPER INNER GLASS</td> <td>1</td> <td>PZ</td> </tr> </tbody> </table>	Code	Description	Qty	UOM	VE1030A1	MAGNET FOR DOOR MICROSWITC H D=22.9MM	1	PZ	V11103A0	40X12 TBSP SCREW FOR PLASTIC	1	PZ	V11220A1	4,2X12 TCB SELF-TAPPIN G SCREW	1	PZ	V11930A1	ST. STEEL 5X20 CHIP SCREW	8	PZ	VI1996A0	M5X35 SCREW	6	PZ	VM1794A0	250X4.8 PA66 BLACK CLAMP	2	PZ	VM2103A0	CLAMP LOCK	2	PZ	VM2267A0	INTERNAL GLASS LOCKING SYSTEM SLIDER	1	PZ	VM2268A0	DOOR MAGNET COVER	1	PZ	VM2269B0	INNER GLASS FIXING CAP	1	PZ	VM2274A0	GROOVED BUSHING	1	PZ	VM2305A0	6 SERIES DOOR CAP FIXING PAWL	7	PZ	VM2384B0		1	PZ	VM2386B0	MM -M LEFT DOOR LEFT LOWER CAP KI	1	PZ	VP1081A0	UPPER HINGE CAP FOR UPPER INNER GLASS	1	PZ
Code	Description	Qty	UOM																																																																		
VE1030A1	MAGNET FOR DOOR MICROSWITC H D=22.9MM	1	PZ																																																																		
V11103A0	40X12 TBSP SCREW FOR PLASTIC	1	PZ																																																																		
V11220A1	4,2X12 TCB SELF-TAPPIN G SCREW	1	PZ																																																																		
V11930A1	ST. STEEL 5X20 CHIP SCREW	8	PZ																																																																		
VI1996A0	M5X35 SCREW	6	PZ																																																																		
VM1794A0	250X4.8 PA66 BLACK CLAMP	2	PZ																																																																		
VM2103A0	CLAMP LOCK	2	PZ																																																																		
VM2267A0	INTERNAL GLASS LOCKING SYSTEM SLIDER	1	PZ																																																																		
VM2268A0	DOOR MAGNET COVER	1	PZ																																																																		
VM2269B0	INNER GLASS FIXING CAP	1	PZ																																																																		
VM2274A0	GROOVED BUSHING	1	PZ																																																																		
VM2305A0	6 SERIES DOOR CAP FIXING PAWL	7	PZ																																																																		
VM2384B0		1	PZ																																																																		
VM2386B0	MM -M LEFT DOOR LEFT LOWER CAP KI	1	PZ																																																																		
VP1081A0	UPPER HINGE CAP FOR UPPER INNER GLASS	1	PZ																																																																		
0B1218B			0B1218B0																																																																		

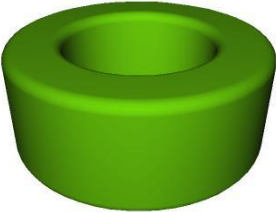



COMPONENT			SPARE PART																						
Code	Description	Image	Code	Description	Components list																				
VM2312A	6 S. DRIP PROFILE DRAIN LEFT PIPE		KVM2312A	M.M. DRIP TRAY LEFT DRAIN PIPE KI	<table border="1"> <thead> <tr> <th>Code</th> <th>Description</th> <th>Qty</th> <th>UOM</th> </tr> </thead> <tbody> <tr> <td>VM1224A0</td> <td>65MY 220MM 2 COLOURS SHRINK TUBE</td> <td>0.150</td> <td>M</td> </tr> <tr> <td>VM2312A0</td> <td>6 S. DRIP PROFILE DRAIN LEFT PIPE</td> <td>1</td> <td>PZ</td> </tr> </tbody> </table>	Code	Description	Qty	UOM	VM1224A0	65MY 220MM 2 COLOURS SHRINK TUBE	0.150	M	VM2312A0	6 S. DRIP PROFILE DRAIN LEFT PIPE	1	PZ								
Code	Description	Qty	UOM																						
VM1224A0	65MY 220MM 2 COLOURS SHRINK TUBE	0.150	M																						
VM2312A0	6 S. DRIP PROFILE DRAIN LEFT PIPE	1	PZ																						
VM2314A	6 S. DRIP PROFILE CAP		KVM2314A	MIND.MAPS DRIP TRAY CAP	<table border="1"> <thead> <tr> <th>Code</th> <th>Description</th> <th>Qty</th> <th>UOM</th> </tr> </thead> <tbody> <tr> <td>VM1224A0</td> <td>65MY 220MM 2 COLOURS SHRINK TUBE</td> <td>0.200</td> <td>M</td> </tr> <tr> <td>VM2314A0</td> <td>6 S. DRIP PROFILE CAP</td> <td>1</td> <td>PZ</td> </tr> </tbody> </table>	Code	Description	Qty	UOM	VM1224A0	65MY 220MM 2 COLOURS SHRINK TUBE	0.200	M	VM2314A0	6 S. DRIP PROFILE CAP	1	PZ								
Code	Description	Qty	UOM																						
VM1224A0	65MY 220MM 2 COLOURS SHRINK TUBE	0.200	M																						
VM2314A0	6 S. DRIP PROFILE CAP	1	PZ																						
VM2285B	860 SERIES DRIP PROFILE KIT		KVM2285B	860 -M SERIES DRIP PROFILE KIT	<table border="1"> <thead> <tr> <th>Code</th> <th>Description</th> <th>Qty</th> <th>UOM</th> </tr> </thead> <tbody> <tr> <td>VM2285B0</td> <td>860 SERIES DRIP PROFILE KIT</td> <td>1</td> <td>PZ</td> </tr> </tbody> </table>	Code	Description	Qty	UOM	VM2285B0	860 SERIES DRIP PROFILE KIT	1	PZ												
Code	Description	Qty	UOM																						
VM2285B0	860 SERIES DRIP PROFILE KIT	1	PZ																						
VM1631A	PLUS INNER GLASS PUSHING CAP		KVM1631A	CAP FOR INTERNAL GLASS 10 PCS KIT	<table border="1"> <thead> <tr> <th>Code</th> <th>Description</th> <th>Qty</th> <th>UOM</th> </tr> </thead> <tbody> <tr> <td>VM1224A0</td> <td>65MY 220MM 2 COLOURS SHRINK TUBE</td> <td>0.200</td> <td>M</td> </tr> <tr> <td>VM1631A0</td> <td>PLUS INNER GLASS PUSHING CAP</td> <td>10</td> <td>PZ</td> </tr> </tbody> </table>	Code	Description	Qty	UOM	VM1224A0	65MY 220MM 2 COLOURS SHRINK TUBE	0.200	M	VM1631A0	PLUS INNER GLASS PUSHING CAP	10	PZ								
Code	Description	Qty	UOM																						
VM1224A0	65MY 220MM 2 COLOURS SHRINK TUBE	0.200	M																						
VM1631A0	PLUS INNER GLASS PUSHING CAP	10	PZ																						
VM2505B	MM PLUS INTERNAL GLASS SUPPORT		KVM2505B	CAP FOR INTERNAL DOUBLE GLASS 3PCS KIT	<table border="1"> <thead> <tr> <th>Code</th> <th>Description</th> <th>Qty</th> <th>UOM</th> </tr> </thead> <tbody> <tr> <td>VI1220A1</td> <td>4,2X12 TCB SELF-TAPPIN G SCREW</td> <td>3</td> <td>PZ</td> </tr> <tr> <td>VM1224A0</td> <td>65MY 220MM 2 COLOURS SHRINK TUBE</td> <td>0.250</td> <td>M</td> </tr> <tr> <td>VM1631A0</td> <td>PLUS INNER GLASS PUSHING CAP</td> <td>3</td> <td>PZ</td> </tr> <tr> <td>VM2505B0</td> <td>MM PLUS INTERNAL GLASS SUPPORT</td> <td>3</td> <td>PZ</td> </tr> </tbody> </table>	Code	Description	Qty	UOM	VI1220A1	4,2X12 TCB SELF-TAPPIN G SCREW	3	PZ	VM1224A0	65MY 220MM 2 COLOURS SHRINK TUBE	0.250	M	VM1631A0	PLUS INNER GLASS PUSHING CAP	3	PZ	VM2505B0	MM PLUS INTERNAL GLASS SUPPORT	3	PZ
Code	Description	Qty	UOM																						
VI1220A1	4,2X12 TCB SELF-TAPPIN G SCREW	3	PZ																						
VM1224A0	65MY 220MM 2 COLOURS SHRINK TUBE	0.250	M																						
VM1631A0	PLUS INNER GLASS PUSHING CAP	3	PZ																						
VM2505B0	MM PLUS INTERNAL GLASS SUPPORT	3	PZ																						







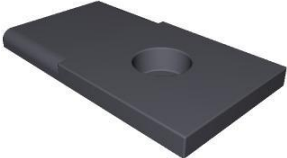

COMPONENT			SPARE PART																																																										
Code	Description	Image	Code	Description	Components list																																																								
VI1074A	4X16 SCREW FOR PLASTIC		VI1074A0	4X16 SCREW FOR PLASTIC																																																									
MG1099A	MIND.MAPS -M COMPLETE HANDLE		KMG1099A	MIND.MAPS SERIES HANDLE KIT -M	<table border="1"> <thead> <tr> <th>Code</th> <th>Description</th> <th>Qty</th> <th>UOM</th> </tr> </thead> <tbody> <tr> <td>0H7321A0</td> <td>MM STAINLESS STEEL HANDLE COVE</td> <td>1</td> <td>PZ</td> </tr> <tr> <td>MG1099A1</td> <td></td> <td>1</td> <td>PZ</td> </tr> <tr> <td>RC1200A0</td> <td>ED=4 WIRE D.=0.5 COMPRESSIO N SPRING</td> <td>4</td> <td>PZ</td> </tr> <tr> <td>VI0239A1</td> <td>SELF-TAPPIN G SCREW 4.2X25 TCB+ INOX</td> <td>8</td> <td>PZ</td> </tr> <tr> <td>VI1220A1</td> <td>4,2X12 TCB SELF-TAPPIN G SCREW</td> <td>2</td> <td>PZ</td> </tr> <tr> <td>VM1182B1</td> <td>E.S. CT BT HANDLE JUNCTION + PIN GUIDE</td> <td>1</td> <td>PZ</td> </tr> <tr> <td>VM1490A0</td> <td>CHEFTOP/BAK ERTOP HANDLE SCREWS COVER</td> <td>4</td> <td>PZ</td> </tr> <tr> <td>VM1695A0</td> <td>HANDLE POSITION PIN</td> <td>4</td> <td>PZ</td> </tr> <tr> <td>VM2245A0</td> <td>HANDLE SHAFT WITH LATCH</td> <td>1</td> <td>PZ</td> </tr> <tr> <td>VM2247B0</td> <td>HANDLE SHAFT COVER VM2245-2246</td> <td>1</td> <td>PZ</td> </tr> <tr> <td>VM2248B0</td> <td>HANDLE WITH LATCH CLOSING KEY</td> <td>1</td> <td>PZ</td> </tr> <tr> <td>VM2295A1</td> <td>MIND.MAPS TOUCH CONTROL STYLUS KIT</td> <td>1</td> <td>PZ</td> </tr> <tr> <td>VP1076A0</td> <td>PLUS ONE ZERO HANDLE PIN</td> <td>1</td> <td>PZ</td> </tr> </tbody> </table>	Code	Description	Qty	UOM	0H7321A0	MM STAINLESS STEEL HANDLE COVE	1	PZ	MG1099A1		1	PZ	RC1200A0	ED=4 WIRE D.=0.5 COMPRESSIO N SPRING	4	PZ	VI0239A1	SELF-TAPPIN G SCREW 4.2X25 TCB+ INOX	8	PZ	VI1220A1	4,2X12 TCB SELF-TAPPIN G SCREW	2	PZ	VM1182B1	E.S. CT BT HANDLE JUNCTION + PIN GUIDE	1	PZ	VM1490A0	CHEFTOP/BAK ERTOP HANDLE SCREWS COVER	4	PZ	VM1695A0	HANDLE POSITION PIN	4	PZ	VM2245A0	HANDLE SHAFT WITH LATCH	1	PZ	VM2247B0	HANDLE SHAFT COVER VM2245-2246	1	PZ	VM2248B0	HANDLE WITH LATCH CLOSING KEY	1	PZ	VM2295A1	MIND.MAPS TOUCH CONTROL STYLUS KIT	1	PZ	VP1076A0	PLUS ONE ZERO HANDLE PIN	1	PZ
Code	Description	Qty	UOM																																																										
0H7321A0	MM STAINLESS STEEL HANDLE COVE	1	PZ																																																										
MG1099A1		1	PZ																																																										
RC1200A0	ED=4 WIRE D.=0.5 COMPRESSIO N SPRING	4	PZ																																																										
VI0239A1	SELF-TAPPIN G SCREW 4.2X25 TCB+ INOX	8	PZ																																																										
VI1220A1	4,2X12 TCB SELF-TAPPIN G SCREW	2	PZ																																																										
VM1182B1	E.S. CT BT HANDLE JUNCTION + PIN GUIDE	1	PZ																																																										
VM1490A0	CHEFTOP/BAK ERTOP HANDLE SCREWS COVER	4	PZ																																																										
VM1695A0	HANDLE POSITION PIN	4	PZ																																																										
VM2245A0	HANDLE SHAFT WITH LATCH	1	PZ																																																										
VM2247B0	HANDLE SHAFT COVER VM2245-2246	1	PZ																																																										
VM2248B0	HANDLE WITH LATCH CLOSING KEY	1	PZ																																																										
VM2295A1	MIND.MAPS TOUCH CONTROL STYLUS KIT	1	PZ																																																										
VP1076A0	PLUS ONE ZERO HANDLE PIN	1	PZ																																																										

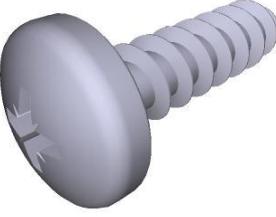

COMPONENT			SPARE PART																						
Code	Description	Image	Code	Description	Components list																				
OB1170A	XEBC-10EU-E LEFT INT DOOR COLUMN		OUTOFPRODUCTIO	ITEM OUT OF PRODUCTION																					
CE1285A	EMI ROUND FERRITE MOD.2643801502		CE1285A0	EMI ROUND FERRITE MOD.2643801502																					
CE1097A	4M SIHF 4 POLES MICROFIT CANBUS		KCE1097A	4 POLES MICROFIT 4 METRES BUS CABLE KIT	<table border="1"> <thead> <tr> <th>Code</th> <th>Description</th> <th>Qty</th> <th>UOM</th> </tr> </thead> <tbody> <tr> <td>CE1097A0</td> <td>4M SIHF 4 POLES MICROFIT CANBUS</td> <td>1</td> <td>PZ</td> </tr> <tr> <td>CE1285A0</td> <td>EMI ROUND FERRITE MOD.26438015 02</td> <td>1</td> <td>PZ</td> </tr> <tr> <td>VM1224A0</td> <td>65MY 220MM 2 COLOURS SHRINK TUBE</td> <td>0.300</td> <td>M</td> </tr> </tbody> </table>	Code	Description	Qty	UOM	CE1097A0	4M SIHF 4 POLES MICROFIT CANBUS	1	PZ	CE1285A0	EMI ROUND FERRITE MOD.26438015 02	1	PZ	VM1224A0	65MY 220MM 2 COLOURS SHRINK TUBE	0.300	M				
Code	Description	Qty	UOM																						
CE1097A0	4M SIHF 4 POLES MICROFIT CANBUS	1	PZ																						
CE1285A0	EMI ROUND FERRITE MOD.26438015 02	1	PZ																						
VM1224A0	65MY 220MM 2 COLOURS SHRINK TUBE	0.300	M																						
VN1179A	CONTROL BOARD 40X40X20MM 12V COOLING FAN		KVN1179A	CONTROL BOARD COOLING FAN KIT	<table border="1"> <thead> <tr> <th>Code</th> <th>Description</th> <th>Qty</th> <th>UOM</th> </tr> </thead> <tbody> <tr> <td>VM1224A0</td> <td>65MY 220MM 2 COLOURS SHRINK TUBE</td> <td>0.150</td> <td>M</td> </tr> <tr> <td>VN1179A0</td> <td>CONTROL BOARD 40X40X20MM 12V COOLING FAN</td> <td>1</td> <td>PZ</td> </tr> <tr> <td>VN1179A0</td> <td>CONTROL BOARD 40X40X20MM 12V COOLING FAN</td> <td>1</td> <td>PZ</td> </tr> <tr> <td>VN1179A1</td> <td>CONTROL BOARD 40X40X20MM 12V COOLING FAN</td> <td>1</td> <td>PZ</td> </tr> </tbody> </table>	Code	Description	Qty	UOM	VM1224A0	65MY 220MM 2 COLOURS SHRINK TUBE	0.150	M	VN1179A0	CONTROL BOARD 40X40X20MM 12V COOLING FAN	1	PZ	VN1179A0	CONTROL BOARD 40X40X20MM 12V COOLING FAN	1	PZ	VN1179A1	CONTROL BOARD 40X40X20MM 12V COOLING FAN	1	PZ
Code	Description	Qty	UOM																						
VM1224A0	65MY 220MM 2 COLOURS SHRINK TUBE	0.150	M																						
VN1179A0	CONTROL BOARD 40X40X20MM 12V COOLING FAN	1	PZ																						
VN1179A0	CONTROL BOARD 40X40X20MM 12V COOLING FAN	1	PZ																						
VN1179A1	CONTROL BOARD 40X40X20MM 12V COOLING FAN	1	PZ																						

COMPONENT			SPARE PART																																		
Code	Description	Image	Code	Description	Components list																																
VM2518A	BOARD COOLING FAN SUPPORT		KVM2518A	PANEL COOLING FAN SUPPORT KIT	<table border="1"> <thead> <tr> <th>Code</th> <th>Description</th> <th>Qty</th> <th>UOM</th> </tr> </thead> <tbody> <tr> <td>VM1224A0</td> <td>65MY 220MM 2 COLOURS SHRINK TUBE</td> <td>0.150</td> <td>M</td> </tr> <tr> <td>VM2518A0</td> <td>BOARD COOLING FAN SUPPORT</td> <td>1</td> <td>PZ</td> </tr> <tr> <td>VM2518A0</td> <td>BOARD COOLING FAN SUPPORT</td> <td>1</td> <td>PZ</td> </tr> </tbody> </table>	Code	Description	Qty	UOM	VM1224A0	65MY 220MM 2 COLOURS SHRINK TUBE	0.150	M	VM2518A0	BOARD COOLING FAN SUPPORT	1	PZ	VM2518A0	BOARD COOLING FAN SUPPORT	1	PZ																
Code	Description	Qty	UOM																																		
VM1224A0	65MY 220MM 2 COLOURS SHRINK TUBE	0.150	M																																		
VM2518A0	BOARD COOLING FAN SUPPORT	1	PZ																																		
VM2518A0	BOARD COOLING FAN SUPPORT	1	PZ																																		
PE1057A	MM PLUS CAPACITIVE CONTROL PANEL		KPE1057A	MM PLUS CAPACITIVE CONTROL BOARD KIT	<table border="1"> <thead> <tr> <th>Code</th> <th>Description</th> <th>Qty</th> <th>UOM</th> </tr> </thead> <tbody> <tr> <td>CE2007A0</td> <td></td> <td>1</td> <td>PZ</td> </tr> <tr> <td>PE1057A0</td> <td>MM PLUS CAPACITIVE CONTROL PANEL</td> <td>1</td> <td>PZ</td> </tr> <tr> <td>VI1074A0</td> <td>4X16 SCREW FOR PLASTIC</td> <td>2</td> <td>PZ</td> </tr> <tr> <td>VM2147A0</td> <td>410X343X15 MM PINK SMOOTH ESD SPONGE</td> <td>1</td> <td>PZ</td> </tr> <tr> <td>VM2295A1</td> <td>MIND.MAPS TOUCH CONTROL STYLUS KIT</td> <td>1</td> <td>PZ</td> </tr> <tr> <td>VP1067A0</td> <td>CONTROL BOARD PARTITION RETROFIT MM</td> <td>1</td> <td>PZ</td> </tr> <tr> <td>VP1078A0</td> <td>MM CONTROL BOARD PARTITION FRAME</td> <td>1</td> <td>PZ</td> </tr> </tbody> </table>	Code	Description	Qty	UOM	CE2007A0		1	PZ	PE1057A0	MM PLUS CAPACITIVE CONTROL PANEL	1	PZ	VI1074A0	4X16 SCREW FOR PLASTIC	2	PZ	VM2147A0	410X343X15 MM PINK SMOOTH ESD SPONGE	1	PZ	VM2295A1	MIND.MAPS TOUCH CONTROL STYLUS KIT	1	PZ	VP1067A0	CONTROL BOARD PARTITION RETROFIT MM	1	PZ	VP1078A0	MM CONTROL BOARD PARTITION FRAME	1	PZ
Code	Description	Qty	UOM																																		
CE2007A0		1	PZ																																		
PE1057A0	MM PLUS CAPACITIVE CONTROL PANEL	1	PZ																																		
VI1074A0	4X16 SCREW FOR PLASTIC	2	PZ																																		
VM2147A0	410X343X15 MM PINK SMOOTH ESD SPONGE	1	PZ																																		
VM2295A1	MIND.MAPS TOUCH CONTROL STYLUS KIT	1	PZ																																		
VP1067A0	CONTROL BOARD PARTITION RETROFIT MM	1	PZ																																		
VP1078A0	MM CONTROL BOARD PARTITION FRAME	1	PZ																																		
VM2305A	6 SERIES DOOR CAP FIXING PAWL		KVM2305A	MM FIXING DOOR THUB SCREWS 10 PCS KIT	<table border="1"> <thead> <tr> <th>Code</th> <th>Description</th> <th>Qty</th> <th>UOM</th> </tr> </thead> <tbody> <tr> <td>VM1224A0</td> <td>65MY 220MM 2 COLOURS SHRINK TUBE</td> <td>0.200</td> <td>M</td> </tr> <tr> <td>VM2305A0</td> <td>6 SERIES DOOR CAP FIXING PAWL</td> <td>10</td> <td>PZ</td> </tr> </tbody> </table>	Code	Description	Qty	UOM	VM1224A0	65MY 220MM 2 COLOURS SHRINK TUBE	0.200	M	VM2305A0	6 SERIES DOOR CAP FIXING PAWL	10	PZ																				
Code	Description	Qty	UOM																																		
VM1224A0	65MY 220MM 2 COLOURS SHRINK TUBE	0.200	M																																		
VM2305A0	6 SERIES DOOR CAP FIXING PAWL	10	PZ																																		
VE1030A	MAGNET FOR DOOR MICROSWITCH D=22,9MM		KVE1030A	2 PCS MAGNET KIT FOR DOOR SWITCH	<table border="1"> <thead> <tr> <th>Code</th> <th>Description</th> <th>Qty</th> <th>UOM</th> </tr> </thead> <tbody> <tr> <td>VE1030A1</td> <td>MAGNET FOR DOOR MICROSWITCH H D=22,9MM</td> <td>2</td> <td>PZ</td> </tr> <tr> <td>VM1224A0</td> <td>65MY 220MM 2 COLOURS SHRINK TUBE</td> <td>0.150</td> <td>M</td> </tr> </tbody> </table>	Code	Description	Qty	UOM	VE1030A1	MAGNET FOR DOOR MICROSWITCH H D=22,9MM	2	PZ	VM1224A0	65MY 220MM 2 COLOURS SHRINK TUBE	0.150	M																				
Code	Description	Qty	UOM																																		
VE1030A1	MAGNET FOR DOOR MICROSWITCH H D=22,9MM	2	PZ																																		
VM1224A0	65MY 220MM 2 COLOURS SHRINK TUBE	0.150	M																																		

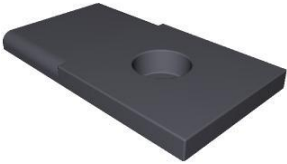

COMPONENT			SPARE PART																		
Code	Description	Image	Code	Description	Components list																
VE1030A	MAGNET FOR DOOR MICROSWITCH D=22,9MM		KVE1020A	MICROSWITCH KIT	<table border="1"> <thead> <tr> <th>Code</th> <th>Description</th> <th>Qty</th> <th>UOM</th> </tr> </thead> <tbody> <tr> <td>VE1020A2</td> <td>MAGNETIC DOOR MICROSWITC</td> <td>1</td> <td>PZ</td> </tr> <tr> <td>VE1030A1</td> <td>MAGNET FOR DOOR MICROSWITC H D=22,9MM</td> <td>4</td> <td>PZ</td> </tr> <tr> <td>VM1224A0</td> <td>65MY 220MM 2 COLOURS SHRINK TUBE</td> <td>0.250</td> <td>M</td> </tr> </tbody> </table>	Code	Description	Qty	UOM	VE1020A2	MAGNETIC DOOR MICROSWITC	1	PZ	VE1030A1	MAGNET FOR DOOR MICROSWITC H D=22,9MM	4	PZ	VM1224A0	65MY 220MM 2 COLOURS SHRINK TUBE	0.250	M
					Code	Description	Qty	UOM													
					VE1020A2	MAGNETIC DOOR MICROSWITC	1	PZ													
					VE1030A1	MAGNET FOR DOOR MICROSWITC H D=22,9MM	4	PZ													
VM1224A0	65MY 220MM 2 COLOURS SHRINK TUBE	0.250	M																		
<table border="1"> <thead> <tr> <th>Code</th> <th>Description</th> <th>Qty</th> <th>UOM</th> </tr> </thead> <tbody> <tr> <td>VM1224A0</td> <td>65MY 220MM 2 COLOURS SHRINK TUBE</td> <td>0.200</td> <td>M</td> </tr> <tr> <td>VM2268A0</td> <td>DOOR MAGNET COVER</td> <td>1</td> <td>PZ</td> </tr> </tbody> </table>	Code	Description	Qty	UOM	VM1224A0	65MY 220MM 2 COLOURS SHRINK TUBE	0.200	M	VM2268A0	DOOR MAGNET COVER	1	PZ									
Code	Description	Qty	UOM																		
VM1224A0	65MY 220MM 2 COLOURS SHRINK TUBE	0.200	M																		
VM2268A0	DOOR MAGNET COVER	1	PZ																		
VM2268A	DOOR MAGNET COVER		KVM2268A	DOOR MAGNET COVER KIT																	
VI1996A	M5X35 SCREW		VI1996A0	M5X35 SCREW																	
VM2267A	INTERNAL GLASS LOCKING SYSTEM SLIDER		VM2267A0	INTERNAL GLASS LOCKING SYSTEM SLIDER																	
VM2269B	INNER GLASS FIXING CAP		KVM2269B	INNER GLASS FIXING CAP KIT -M	<table border="1"> <thead> <tr> <th>Code</th> <th>Description</th> <th>Qty</th> <th>UOM</th> </tr> </thead> <tbody> <tr> <td>VM2269B0</td> <td>INNER GLASS FIXING CAP</td> <td>2</td> <td>PZ</td> </tr> </tbody> </table>	Code	Description	Qty	UOM	VM2269B0	INNER GLASS FIXING CAP	2	PZ								
Code	Description	Qty	UOM																		
VM2269B0	INNER GLASS FIXING CAP	2	PZ																		

COMPONENT			SPARE PART																																																		
Code	Description	Image	Code	Description	Components list																																																
VM2262B			KVM2262B	MIND.MAPS -M DOOR RIGHT UPPER CAP KIT	<table border="1"> <thead> <tr> <th>Code</th> <th>Description</th> <th>Qty</th> <th>UOM</th> </tr> </thead> <tbody> <tr> <td>RC1200A0</td> <td>ED=4 WIRE D.=0.5 COMPRESSIO N SPRING</td> <td>2</td> <td>PZ</td> </tr> <tr> <td>VE1030A1</td> <td>MAGNET FOR DOOR MICROSWITC H D=22.9MM</td> <td>1</td> <td>PZ</td> </tr> <tr> <td>VI1220A1</td> <td>4,2X12 TCB SELF-TAPPIN G SCREW</td> <td>1</td> <td>PZ</td> </tr> <tr> <td>VI1930A1</td> <td>ST. STEEL 5X20 CHIP SCREW</td> <td>4</td> <td>PZ</td> </tr> <tr> <td>VI1996A0</td> <td>M5X35 SCREW</td> <td>4</td> <td>PZ</td> </tr> <tr> <td>VM1224A0</td> <td>65MY 220MM 2 COLOURS SHRINK TUBE</td> <td>0.300</td> <td>M</td> </tr> <tr> <td>VM2262B0</td> <td></td> <td>1</td> <td>PZ</td> </tr> <tr> <td>VM2267A0</td> <td>INTERNAL GLASS LOCKING SYSTEM SLIDER</td> <td>1</td> <td>PZ</td> </tr> <tr> <td>VM2268A0</td> <td>DOOR MAGNET COVER</td> <td>1</td> <td>PZ</td> </tr> <tr> <td>VM2269B0</td> <td>INNER GLASS FIXING CAP</td> <td>1</td> <td>PZ</td> </tr> <tr> <td>VM2305A0</td> <td>6 SERIES DOOR CAP FIXING PAWL</td> <td>4</td> <td>PZ</td> </tr> </tbody> </table>	Code	Description	Qty	UOM	RC1200A0	ED=4 WIRE D.=0.5 COMPRESSIO N SPRING	2	PZ	VE1030A1	MAGNET FOR DOOR MICROSWITC H D=22.9MM	1	PZ	VI1220A1	4,2X12 TCB SELF-TAPPIN G SCREW	1	PZ	VI1930A1	ST. STEEL 5X20 CHIP SCREW	4	PZ	VI1996A0	M5X35 SCREW	4	PZ	VM1224A0	65MY 220MM 2 COLOURS SHRINK TUBE	0.300	M	VM2262B0		1	PZ	VM2267A0	INTERNAL GLASS LOCKING SYSTEM SLIDER	1	PZ	VM2268A0	DOOR MAGNET COVER	1	PZ	VM2269B0	INNER GLASS FIXING CAP	1	PZ	VM2305A0	6 SERIES DOOR CAP FIXING PAWL	4	PZ
Code	Description	Qty	UOM																																																		
RC1200A0	ED=4 WIRE D.=0.5 COMPRESSIO N SPRING	2	PZ																																																		
VE1030A1	MAGNET FOR DOOR MICROSWITC H D=22.9MM	1	PZ																																																		
VI1220A1	4,2X12 TCB SELF-TAPPIN G SCREW	1	PZ																																																		
VI1930A1	ST. STEEL 5X20 CHIP SCREW	4	PZ																																																		
VI1996A0	M5X35 SCREW	4	PZ																																																		
VM1224A0	65MY 220MM 2 COLOURS SHRINK TUBE	0.300	M																																																		
VM2262B0		1	PZ																																																		
VM2267A0	INTERNAL GLASS LOCKING SYSTEM SLIDER	1	PZ																																																		
VM2268A0	DOOR MAGNET COVER	1	PZ																																																		
VM2269B0	INNER GLASS FIXING CAP	1	PZ																																																		
VM2305A0	6 SERIES DOOR CAP FIXING PAWL	4	PZ																																																		
VI1930A	ST. STEEL 5X20 CHIP SCREW		VI1930A1	ST. STEEL 5X20 CHIP SCREW																																																	
VM2305A	6 SERIES DOOR CAP FIXING PAWL		KVM2305A	MM FIXING DOOR THUB SCREWS 10 PCS KIT	<table border="1"> <thead> <tr> <th>Code</th> <th>Description</th> <th>Qty</th> <th>UOM</th> </tr> </thead> <tbody> <tr> <td>VM1224A0</td> <td>65MY 220MM 2 COLOURS SHRINK TUBE</td> <td>0.200</td> <td>M</td> </tr> <tr> <td>VM2305A0</td> <td>6 SERIES DOOR CAP FIXING PAWL</td> <td>10</td> <td>PZ</td> </tr> </tbody> </table>	Code	Description	Qty	UOM	VM1224A0	65MY 220MM 2 COLOURS SHRINK TUBE	0.200	M	VM2305A0	6 SERIES DOOR CAP FIXING PAWL	10	PZ																																				
Code	Description	Qty	UOM																																																		
VM1224A0	65MY 220MM 2 COLOURS SHRINK TUBE	0.200	M																																																		
VM2305A0	6 SERIES DOOR CAP FIXING PAWL	10	PZ																																																		

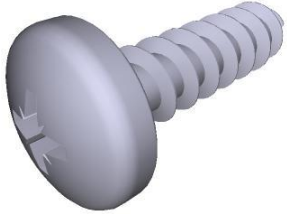
COMPONENT			SPARE PART															
Code	Description	Image	Code	Description	Components list													
VE1030A	MAGNET FOR DOOR MICROSWITCH D=22,9MM		KVE1030A	2 PCS MAGNET KIT FOR DOOR SWITCH	<table border="1"> <thead> <tr> <th>Code</th> <th>Description</th> <th>Qty</th> <th>UOM</th> </tr> </thead> <tbody> <tr> <td>VE1030A1</td> <td>MAGNET FOR DOOR MICROSWITC H D=22,9MM</td> <td>2</td> <td>PZ</td> </tr> <tr> <td>VM1224A0</td> <td>65MY 220MM 2 COLOURS SHRINK TUBE</td> <td>0.150</td> <td>M</td> </tr> </tbody> </table>	Code	Description	Qty	UOM	VE1030A1	MAGNET FOR DOOR MICROSWITC H D=22,9MM	2	PZ	VM1224A0	65MY 220MM 2 COLOURS SHRINK TUBE	0.150	M	
			Code	Description	Qty	UOM												
VE1030A1	MAGNET FOR DOOR MICROSWITC H D=22,9MM	2	PZ															
VM1224A0	65MY 220MM 2 COLOURS SHRINK TUBE	0.150	M															
KVE1020A	MICROSWITCH KIT	<table border="1"> <thead> <tr> <th>Code</th> <th>Description</th> <th>Qty</th> <th>UOM</th> </tr> </thead> <tbody> <tr> <td>VE1020A2</td> <td>MAGNETIC DOOR MICROSWITC</td> <td>1</td> <td>PZ</td> </tr> <tr> <td>VE1030A1</td> <td>MAGNET FOR DOOR MICROSWITC H D=22,9MM</td> <td>4</td> <td>PZ</td> </tr> <tr> <td>VM1224A0</td> <td>65MY 220MM 2 COLOURS SHRINK TUBE</td> <td>0.250</td> <td>M</td> </tr> </tbody> </table>	Code	Description	Qty	UOM	VE1020A2	MAGNETIC DOOR MICROSWITC	1	PZ	VE1030A1	MAGNET FOR DOOR MICROSWITC H D=22,9MM	4	PZ	VM1224A0	65MY 220MM 2 COLOURS SHRINK TUBE	0.250	M
Code	Description	Qty	UOM															
VE1020A2	MAGNETIC DOOR MICROSWITC	1	PZ															
VE1030A1	MAGNET FOR DOOR MICROSWITC H D=22,9MM	4	PZ															
VM1224A0	65MY 220MM 2 COLOURS SHRINK TUBE	0.250	M															
VM2268A	DOOR MAGNET COVER		KVM2268A	DOOR MAGNET COVER KIT	<table border="1"> <thead> <tr> <th>Code</th> <th>Description</th> <th>Qty</th> <th>UOM</th> </tr> </thead> <tbody> <tr> <td>VM1224A0</td> <td>65MY 220MM 2 COLOURS SHRINK TUBE</td> <td>0.200</td> <td>M</td> </tr> <tr> <td>VM2268A0</td> <td>DOOR MAGNET COVER</td> <td>1</td> <td>PZ</td> </tr> </tbody> </table>	Code	Description	Qty	UOM	VM1224A0	65MY 220MM 2 COLOURS SHRINK TUBE	0.200	M	VM2268A0	DOOR MAGNET COVER	1	PZ	
Code	Description	Qty	UOM															
VM1224A0	65MY 220MM 2 COLOURS SHRINK TUBE	0.200	M															
VM2268A0	DOOR MAGNET COVER	1	PZ															
VI1996A	M5X35 SCREW		VI1996A0	M5X35 SCREW														
VM2267A	INTERNAL GLASS LOCKING SYSTEM SLIDER		VM2267A0	INTERNAL GLASS LOCKING SYSTEM SLIDER														

COMPONENT			SPARE PART																																																		
Code	Description	Image	Code	Description	Components list																																																
VM2269B	INNER GLASS FIXING CAP		KVM2269B	INNER GLASS FIXING CAP KIT -M	<table border="1"> <thead> <tr> <th>Code</th> <th>Description</th> <th>Qty</th> <th>UOM</th> </tr> </thead> <tbody> <tr> <td>VM2269B0</td> <td>INNER GLASS FIXING CAP</td> <td>2</td> <td>PZ</td> </tr> </tbody> </table>	Code	Description	Qty	UOM	VM2269B0	INNER GLASS FIXING CAP	2	PZ																																								
Code	Description	Qty	UOM																																																		
VM2269B0	INNER GLASS FIXING CAP	2	PZ																																																		
VM2261B			KVM2261B	MIND.MAPS -M DOOR RIGHT LOWER CAP KIT	<table border="1"> <thead> <tr> <th>Code</th> <th>Description</th> <th>Qty</th> <th>UOM</th> </tr> </thead> <tbody> <tr> <td>RC1200A0</td> <td>ED=4 WIRE D.=0.5 COMPRESSIO N SPRING</td> <td>2</td> <td>PZ</td> </tr> <tr> <td>VE1030A1</td> <td>MAGNET FOR DOOR MICROSWITC H D=22.9MM</td> <td>1</td> <td>PZ</td> </tr> <tr> <td>VI1220A1</td> <td>4,2X12 TCB SELF-TAPPIN G SCREW</td> <td>1</td> <td>PZ</td> </tr> <tr> <td>VI1930A1</td> <td>ST. STEEL 5X20 CHIP SCREW</td> <td>4</td> <td>PZ</td> </tr> <tr> <td>VI1996A0</td> <td>M5X35 SCREW</td> <td>4</td> <td>PZ</td> </tr> <tr> <td>VM1224A0</td> <td>65MY 220MM 2 COLOURS SHRINK TUBE</td> <td>0.300</td> <td>M</td> </tr> <tr> <td>VM2261B0</td> <td></td> <td>1</td> <td>PZ</td> </tr> <tr> <td>VM2267A0</td> <td>INTERNAL GLASS LOCKING SYSTEM SLIDER</td> <td>1</td> <td>PZ</td> </tr> <tr> <td>VM2268A0</td> <td>DOOR MAGNET COVER</td> <td>1</td> <td>PZ</td> </tr> <tr> <td>VM2269B0</td> <td>INNER GLASS FIXING CAP</td> <td>1</td> <td>PZ</td> </tr> <tr> <td>VM2305A0</td> <td>6 SERIES DOOR CAP FIXING PAWL</td> <td>4</td> <td>PZ</td> </tr> </tbody> </table>	Code	Description	Qty	UOM	RC1200A0	ED=4 WIRE D.=0.5 COMPRESSIO N SPRING	2	PZ	VE1030A1	MAGNET FOR DOOR MICROSWITC H D=22.9MM	1	PZ	VI1220A1	4,2X12 TCB SELF-TAPPIN G SCREW	1	PZ	VI1930A1	ST. STEEL 5X20 CHIP SCREW	4	PZ	VI1996A0	M5X35 SCREW	4	PZ	VM1224A0	65MY 220MM 2 COLOURS SHRINK TUBE	0.300	M	VM2261B0		1	PZ	VM2267A0	INTERNAL GLASS LOCKING SYSTEM SLIDER	1	PZ	VM2268A0	DOOR MAGNET COVER	1	PZ	VM2269B0	INNER GLASS FIXING CAP	1	PZ	VM2305A0	6 SERIES DOOR CAP FIXING PAWL	4	PZ
Code	Description	Qty	UOM																																																		
RC1200A0	ED=4 WIRE D.=0.5 COMPRESSIO N SPRING	2	PZ																																																		
VE1030A1	MAGNET FOR DOOR MICROSWITC H D=22.9MM	1	PZ																																																		
VI1220A1	4,2X12 TCB SELF-TAPPIN G SCREW	1	PZ																																																		
VI1930A1	ST. STEEL 5X20 CHIP SCREW	4	PZ																																																		
VI1996A0	M5X35 SCREW	4	PZ																																																		
VM1224A0	65MY 220MM 2 COLOURS SHRINK TUBE	0.300	M																																																		
VM2261B0		1	PZ																																																		
VM2267A0	INTERNAL GLASS LOCKING SYSTEM SLIDER	1	PZ																																																		
VM2268A0	DOOR MAGNET COVER	1	PZ																																																		
VM2269B0	INNER GLASS FIXING CAP	1	PZ																																																		
VM2305A0	6 SERIES DOOR CAP FIXING PAWL	4	PZ																																																		
VI1930A	ST. STEEL 5X20 CHIP SCREW		VI1930A1	ST. STEEL 5X20 CHIP SCREW																																																	



COMPONENT			SPARE PART		
Code	Description	Image	Code	Description	Components list
0B1171B			0B1171B1		
0B1172A	XEBC-10EU-E RIGHT INT DOOR COLUMN		OUTOFPRODUCTIO	ITEM OUT OF PRODUCTION	

ASM3069A/0.D05 - Electrical system

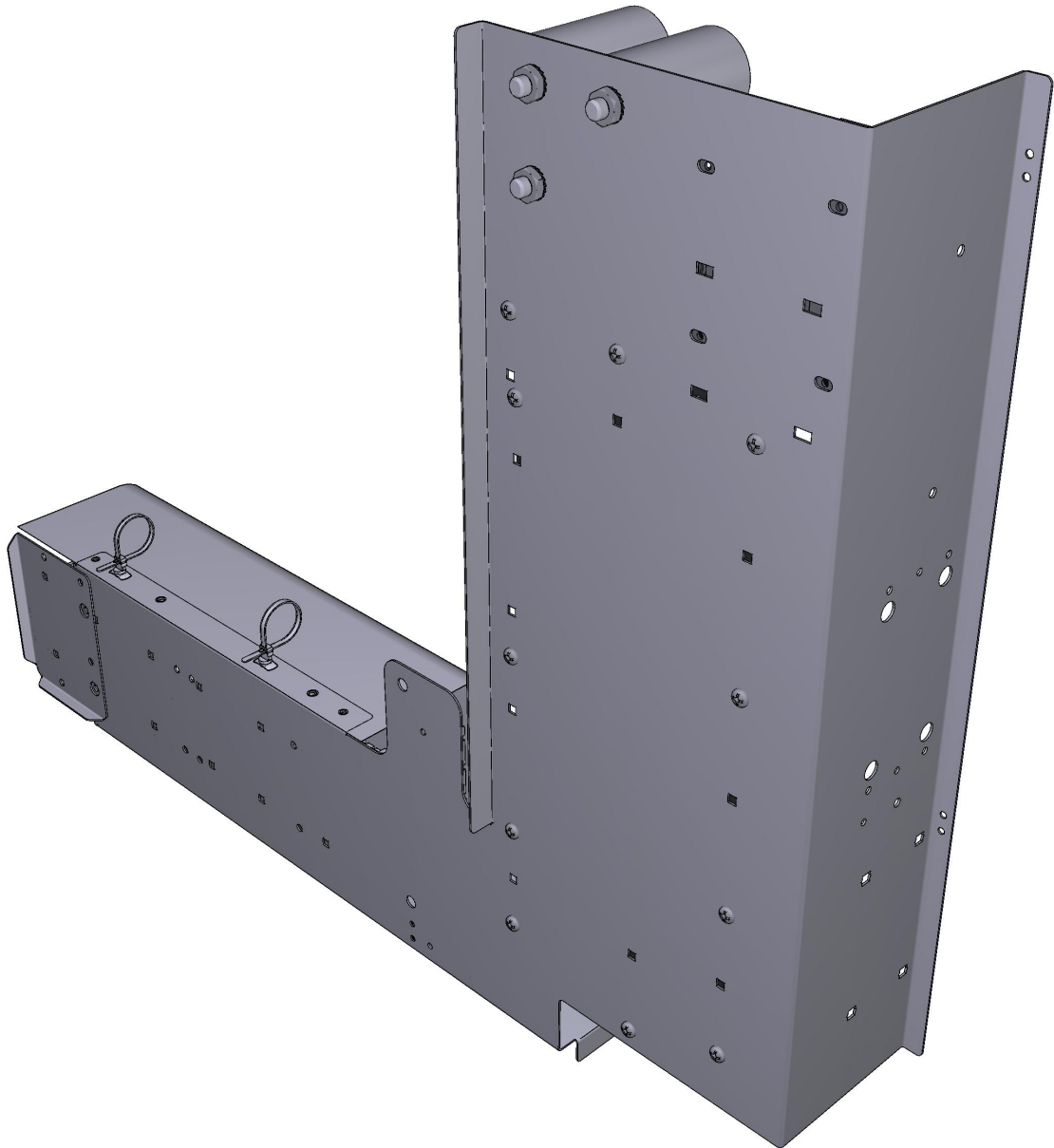

FRONT



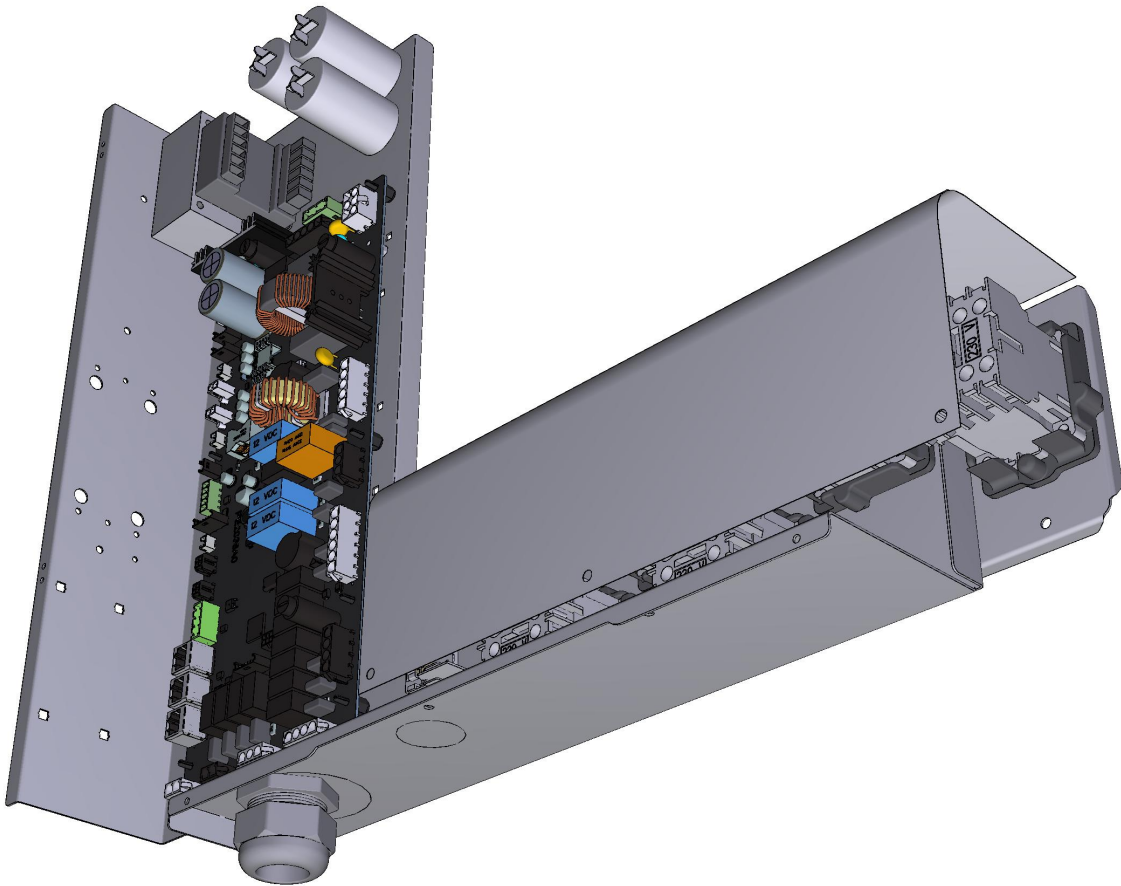

ASM3069A/0.D05 - Electrical system

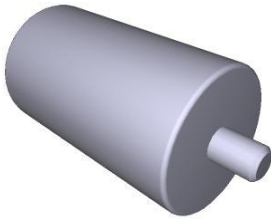
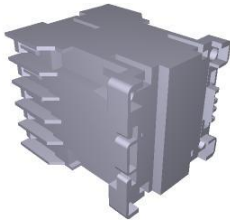
REAR

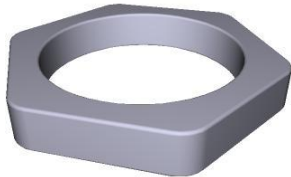

COMPONENT			SPARE PART																						
Code	Description	Image	Code	Description	Components list																				
CN1003A	6,3 UF MOTOR CAPACITOR		KCN1003A	6,3 UF MOTOR CAPACITOR KIT	<table border="1"> <thead> <tr> <th>Code</th> <th>Description</th> <th>Qty</th> <th>UOM</th> </tr> </thead> <tbody> <tr> <td>CN1003A0</td> <td>6,3 UF MOTOR CAPACITOR</td> <td>1</td> <td>PZ</td> </tr> <tr> <td>VI1931A0</td> <td>M8 NUT+INDENTE D WASHER D=8 X COND.</td> <td>1</td> <td>PZ</td> </tr> <tr> <td>VI1932A0</td> <td>M8 NUT+INDENTE D WASHER D=8 X COND.</td> <td>1</td> <td>PZ</td> </tr> <tr> <td>VM1224A0</td> <td>65MY 220MM 2 COLOURS SHRINK TUBE</td> <td>0.200</td> <td>M</td> </tr> </tbody> </table>	Code	Description	Qty	UOM	CN1003A0	6,3 UF MOTOR CAPACITOR	1	PZ	VI1931A0	M8 NUT+INDENTE D WASHER D=8 X COND.	1	PZ	VI1932A0	M8 NUT+INDENTE D WASHER D=8 X COND.	1	PZ	VM1224A0	65MY 220MM 2 COLOURS SHRINK TUBE	0.200	M
Code	Description	Qty	UOM																						
CN1003A0	6,3 UF MOTOR CAPACITOR	1	PZ																						
VI1931A0	M8 NUT+INDENTE D WASHER D=8 X COND.	1	PZ																						
VI1932A0	M8 NUT+INDENTE D WASHER D=8 X COND.	1	PZ																						
VM1224A0	65MY 220MM 2 COLOURS SHRINK TUBE	0.200	M																						
VE1115A	20 A 230V 4 POLES MINICONTACTOR		KVE1115A	20A 230V 4 POLES MINICONTACTOR KI	<table border="1"> <thead> <tr> <th>Code</th> <th>Description</th> <th>Qty</th> <th>UOM</th> </tr> </thead> <tbody> <tr> <td>VE1115A0</td> <td>20 A 230V 4 POLES MINICONTACT OR</td> <td>1</td> <td>PZ</td> </tr> <tr> <td>VM1075A1</td> <td>PLASTIC CLIP TO FIX CONTACTORS</td> <td>4</td> <td>PZ</td> </tr> <tr> <td>VM1224A0</td> <td>65MY 220MM 2 COLOURS SHRINK TUBE</td> <td>0.250</td> <td>M</td> </tr> </tbody> </table>	Code	Description	Qty	UOM	VE1115A0	20 A 230V 4 POLES MINICONTACT OR	1	PZ	VM1075A1	PLASTIC CLIP TO FIX CONTACTORS	4	PZ	VM1224A0	65MY 220MM 2 COLOURS SHRINK TUBE	0.250	M				
Code	Description	Qty	UOM																						
VE1115A0	20 A 230V 4 POLES MINICONTACT OR	1	PZ																						
VM1075A1	PLASTIC CLIP TO FIX CONTACTORS	4	PZ																						
VM1224A0	65MY 220MM 2 COLOURS SHRINK TUBE	0.250	M																						
VM1056A	SMALL CONTACTOR BRACKET VE1115A		VM1056A0	SMALL CONTACTOR BRACKET VE1115A																					
MR1004A	41A 450V 7 POLES TERMINAL		KMR1004A	7FTW 1+2+3/4+5+6 TERMINAL BLOCK KIT	<table border="1"> <thead> <tr> <th>Code</th> <th>Description</th> <th>Qty</th> <th>UOM</th> </tr> </thead> <tbody> <tr> <td>MR1004A1</td> <td>41A 450V 7 POLES TERMINAL</td> <td>1</td> <td>PZ</td> </tr> <tr> <td>VM1224A0</td> <td>65MY 220MM 2 COLOURS SHRINK TUBE</td> <td>0.300</td> <td>M</td> </tr> </tbody> </table>	Code	Description	Qty	UOM	MR1004A1	41A 450V 7 POLES TERMINAL	1	PZ	VM1224A0	65MY 220MM 2 COLOURS SHRINK TUBE	0.300	M								
Code	Description	Qty	UOM																						
MR1004A1	41A 450V 7 POLES TERMINAL	1	PZ																						
VM1224A0	65MY 220MM 2 COLOURS SHRINK TUBE	0.300	M																						

COMPONENT			SPARE PART																		
Code	Description	Image	Code	Description	Components list																
VE1026A	230-21-12VAC 80VA TRANSFORMER		KVE1026A	230-21-12VAC 90VA TRANSFORMER KIT	<table border="1"> <thead> <tr> <th>Code</th> <th>Description</th> <th>Qty</th> <th>UOM</th> </tr> </thead> <tbody> <tr> <td>MOV0012A0</td> <td>HOOD RING GASKET GN1110A2</td> <td>0.100</td> <td>PZ</td> </tr> <tr> <td>VE1026A0</td> <td>230-21-12VAC 80VA TRANSFORMER</td> <td>1</td> <td>PZ</td> </tr> <tr> <td>VI1950A0</td> <td>ST. STEEL 4,2X13 TCB SELF-DRILLIN G SCREW</td> <td>4</td> <td>PZ</td> </tr> </tbody> </table>	Code	Description	Qty	UOM	MOV0012A0	HOOD RING GASKET GN1110A2	0.100	PZ	VE1026A0	230-21-12VAC 80VA TRANSFORMER	1	PZ	VI1950A0	ST. STEEL 4,2X13 TCB SELF-DRILLIN G SCREW	4	PZ
					Code	Description	Qty	UOM													
MOV0012A0	HOOD RING GASKET GN1110A2	0.100	PZ																		
VE1026A0	230-21-12VAC 80VA TRANSFORMER	1	PZ																		
VI1950A0	ST. STEEL 4,2X13 TCB SELF-DRILLIN G SCREW	4	PZ																		
<table border="1"> <thead> <tr> <th>Code</th> <th>Description</th> <th>Qty</th> <th>UOM</th> </tr> </thead> <tbody> <tr> <td>VE1644A0</td> <td>PG 29 STRAIN RELIEF NUT</td> <td>1</td> <td>PZ</td> </tr> <tr> <td>VE1645A1</td> <td>REDUCED PG 29 STRAIN RELIEF</td> <td>1</td> <td>PZ</td> </tr> <tr> <td>VM1224A0</td> <td>65MY 220MM 2 COLOURS SHRINK TUBE</td> <td>0.300</td> <td>M</td> </tr> </tbody> </table>	Code	Description	Qty	UOM	VE1644A0	PG 29 STRAIN RELIEF NUT	1	PZ	VE1645A1	REDUCED PG 29 STRAIN RELIEF	1	PZ	VM1224A0	65MY 220MM 2 COLOURS SHRINK TUBE	0.300	M					
Code	Description	Qty	UOM																		
VE1644A0	PG 29 STRAIN RELIEF NUT	1	PZ																		
VE1645A1	REDUCED PG 29 STRAIN RELIEF	1	PZ																		
VM1224A0	65MY 220MM 2 COLOURS SHRINK TUBE	0.300	M																		
VE1644A	PG 29 STRAIN RELIEF NUT		KVE1645A	REDUCED PG 29 STRAIN RELIEF + NUT KIT	<table border="1"> <thead> <tr> <th>Code</th> <th>Description</th> <th>Qty</th> <th>UOM</th> </tr> </thead> <tbody> <tr> <td>VE1644A0</td> <td>PG 29 STRAIN RELIEF NUT</td> <td>1</td> <td>PZ</td> </tr> <tr> <td>VE1645A1</td> <td>REDUCED PG 29 STRAIN RELIEF</td> <td>1</td> <td>PZ</td> </tr> <tr> <td>VM1224A0</td> <td>65MY 220MM 2 COLOURS SHRINK TUBE</td> <td>0.300</td> <td>M</td> </tr> </tbody> </table>	Code	Description	Qty	UOM	VE1644A0	PG 29 STRAIN RELIEF NUT	1	PZ	VE1645A1	REDUCED PG 29 STRAIN RELIEF	1	PZ	VM1224A0	65MY 220MM 2 COLOURS SHRINK TUBE	0.300	M
					Code	Description	Qty	UOM													
VE1644A0	PG 29 STRAIN RELIEF NUT	1	PZ																		
VE1645A1	REDUCED PG 29 STRAIN RELIEF	1	PZ																		
VM1224A0	65MY 220MM 2 COLOURS SHRINK TUBE	0.300	M																		
<table border="1"> <thead> <tr> <th>Code</th> <th>Description</th> <th>Qty</th> <th>UOM</th> </tr> </thead> <tbody> <tr> <td>VE1644A0</td> <td>PG 29 STRAIN RELIEF NUT</td> <td>1</td> <td>PZ</td> </tr> <tr> <td>VE1645A1</td> <td>REDUCED PG 29 STRAIN RELIEF</td> <td>1</td> <td>PZ</td> </tr> <tr> <td>VM1224A0</td> <td>65MY 220MM 2 COLOURS SHRINK TUBE</td> <td>0.300</td> <td>M</td> </tr> </tbody> </table>	Code	Description	Qty	UOM	VE1644A0	PG 29 STRAIN RELIEF NUT	1	PZ	VE1645A1	REDUCED PG 29 STRAIN RELIEF	1	PZ	VM1224A0	65MY 220MM 2 COLOURS SHRINK TUBE	0.300	M					
Code	Description	Qty	UOM																		
VE1644A0	PG 29 STRAIN RELIEF NUT	1	PZ																		
VE1645A1	REDUCED PG 29 STRAIN RELIEF	1	PZ																		
VM1224A0	65MY 220MM 2 COLOURS SHRINK TUBE	0.300	M																		
VE1645A	REDUCED PG 29 STRAIN RELIEF		KVE1645A	REDUCED PG 29 STRAIN RELIEF + NUT KIT	<table border="1"> <thead> <tr> <th>Code</th> <th>Description</th> <th>Qty</th> <th>UOM</th> </tr> </thead> <tbody> <tr> <td>VE1644A0</td> <td>PG 29 STRAIN RELIEF NUT</td> <td>1</td> <td>PZ</td> </tr> <tr> <td>VE1645A1</td> <td>REDUCED PG 29 STRAIN RELIEF</td> <td>1</td> <td>PZ</td> </tr> <tr> <td>VM1224A0</td> <td>65MY 220MM 2 COLOURS SHRINK TUBE</td> <td>0.300</td> <td>M</td> </tr> </tbody> </table>	Code	Description	Qty	UOM	VE1644A0	PG 29 STRAIN RELIEF NUT	1	PZ	VE1645A1	REDUCED PG 29 STRAIN RELIEF	1	PZ	VM1224A0	65MY 220MM 2 COLOURS SHRINK TUBE	0.300	M
					Code	Description	Qty	UOM													
VE1644A0	PG 29 STRAIN RELIEF NUT	1	PZ																		
VE1645A1	REDUCED PG 29 STRAIN RELIEF	1	PZ																		
VM1224A0	65MY 220MM 2 COLOURS SHRINK TUBE	0.300	M																		
<table border="1"> <thead> <tr> <th>Code</th> <th>Description</th> <th>Qty</th> <th>UOM</th> </tr> </thead> <tbody> <tr> <td>VE1115A0</td> <td>20 A 230V 4 POLES MINICONTACT OR</td> <td>1</td> <td>PZ</td> </tr> <tr> <td>VM1075A1</td> <td>PLASTIC CLIP TO FIX CONTACTORS</td> <td>4</td> <td>PZ</td> </tr> <tr> <td>VM1224A0</td> <td>65MY 220MM 2 COLOURS SHRINK TUBE</td> <td>0.250</td> <td>M</td> </tr> </tbody> </table>	Code	Description	Qty	UOM	VE1115A0	20 A 230V 4 POLES MINICONTACT OR	1	PZ	VM1075A1	PLASTIC CLIP TO FIX CONTACTORS	4	PZ	VM1224A0	65MY 220MM 2 COLOURS SHRINK TUBE	0.250	M					
Code	Description	Qty	UOM																		
VE1115A0	20 A 230V 4 POLES MINICONTACT OR	1	PZ																		
VM1075A1	PLASTIC CLIP TO FIX CONTACTORS	4	PZ																		
VM1224A0	65MY 220MM 2 COLOURS SHRINK TUBE	0.250	M																		
VE1115A	20 A 230V 4 POLES MINICONTACTOR		KVE1115A	20A 230V 4 POLES MINICONTACTOR KI	<table border="1"> <thead> <tr> <th>Code</th> <th>Description</th> <th>Qty</th> <th>UOM</th> </tr> </thead> <tbody> <tr> <td>VE1115A0</td> <td>20 A 230V 4 POLES MINICONTACT OR</td> <td>1</td> <td>PZ</td> </tr> <tr> <td>VM1075A1</td> <td>PLASTIC CLIP TO FIX CONTACTORS</td> <td>4</td> <td>PZ</td> </tr> <tr> <td>VM1224A0</td> <td>65MY 220MM 2 COLOURS SHRINK TUBE</td> <td>0.250</td> <td>M</td> </tr> </tbody> </table>	Code	Description	Qty	UOM	VE1115A0	20 A 230V 4 POLES MINICONTACT OR	1	PZ	VM1075A1	PLASTIC CLIP TO FIX CONTACTORS	4	PZ	VM1224A0	65MY 220MM 2 COLOURS SHRINK TUBE	0.250	M
					Code	Description	Qty	UOM													
VE1115A0	20 A 230V 4 POLES MINICONTACT OR	1	PZ																		
VM1075A1	PLASTIC CLIP TO FIX CONTACTORS	4	PZ																		
VM1224A0	65MY 220MM 2 COLOURS SHRINK TUBE	0.250	M																		
<table border="1"> <thead> <tr> <th>Code</th> <th>Description</th> <th>Qty</th> <th>UOM</th> </tr> </thead> <tbody> <tr> <td>VM1056A0</td> <td>SMALL CONTACTOR BRACKET VE1115A</td> <td></td> <td></td> </tr> </tbody> </table>	Code	Description	Qty	UOM	VM1056A0	SMALL CONTACTOR BRACKET VE1115A															
Code	Description	Qty	UOM																		
VM1056A0	SMALL CONTACTOR BRACKET VE1115A																				
VM1056A	SMALL CONTACTOR BRACKET VE1115A		VM1056A0	SMALL CONTACTOR BRACKET VE1115A																	



COMPONENT			SPARE PART																										
Code	Description	Image	Code	Description	Components list																								
0H7339A	FIFTH CONTACTOR PLATE		0H7339A0	FIFTH CONTACTOR PLATE																									
VM1745A	CARD SUPPORT		KVM1745A	BOARD SUPPORT 10 PCS KIT	<table border="1"> <thead> <tr> <th>Code</th> <th>Description</th> <th>Qty</th> <th>UOM</th> </tr> </thead> <tbody> <tr> <td>VM1224A0</td> <td>65MY 220MM 2 COLOURS SHRINK TUBE</td> <td>0.200</td> <td>M</td> </tr> <tr> <td>VM1745A0</td> <td>CARD SUPPORT</td> <td>10</td> <td>PZ</td> </tr> </tbody> </table>	Code	Description	Qty	UOM	VM1224A0	65MY 220MM 2 COLOURS SHRINK TUBE	0.200	M	VM1745A0	CARD SUPPORT	10	PZ												
Code	Description	Qty	UOM																										
VM1224A0	65MY 220MM 2 COLOURS SHRINK TUBE	0.200	M																										
VM1745A0	CARD SUPPORT	10	PZ																										
PE2038A	MIND.MAPS PLUS POWER BOARD		KPE2038A	MIND.MAPS PLUS POWER BOARD KIT	<table border="1"> <thead> <tr> <th>Code</th> <th>Description</th> <th>Qty</th> <th>UOM</th> </tr> </thead> <tbody> <tr> <td>MOV0003A0</td> <td>HOOD RING GASKET GN1110A2</td> <td>0.100</td> <td>PZ</td> </tr> <tr> <td>PE2038A0</td> <td>MIND.MAPS PLUS POWER BOARD</td> <td>1</td> <td>PZ</td> </tr> <tr> <td>VI1850A0</td> <td>M4X6 NICKEL PLATED FIXING SCRE</td> <td>12</td> <td>PZ</td> </tr> <tr> <td>VM1745A0</td> <td>CARD SUPPORT</td> <td>12</td> <td>PZ</td> </tr> <tr> <td>VM2147A0</td> <td>410X343X15 MM PINK SMOOTH ESD SPONGE</td> <td>1</td> <td>PZ</td> </tr> </tbody> </table>	Code	Description	Qty	UOM	MOV0003A0	HOOD RING GASKET GN1110A2	0.100	PZ	PE2038A0	MIND.MAPS PLUS POWER BOARD	1	PZ	VI1850A0	M4X6 NICKEL PLATED FIXING SCRE	12	PZ	VM1745A0	CARD SUPPORT	12	PZ	VM2147A0	410X343X15 MM PINK SMOOTH ESD SPONGE	1	PZ
Code	Description	Qty	UOM																										
MOV0003A0	HOOD RING GASKET GN1110A2	0.100	PZ																										
PE2038A0	MIND.MAPS PLUS POWER BOARD	1	PZ																										
VI1850A0	M4X6 NICKEL PLATED FIXING SCRE	12	PZ																										
VM1745A0	CARD SUPPORT	12	PZ																										
VM2147A0	410X343X15 MM PINK SMOOTH ESD SPONGE	1	PZ																										
VM2398A	XEBC REMOTE CONTROL SWITCH PROTECTION		VM2398A0	XEBC REMOTE CONTROL SWITCH PROTECTION																									



COMPONENT			SPARE PART		
<i>Code</i>	<i>Description</i>	<i>Image</i>	<i>Code</i>	<i>Description</i>	<i>Components list</i>
0H7371A	XEBC MM COMPONENTS HOLDING PLATE		0H7371A0	XEBC MM COMPONENTS HOLDING PLATE	







ASM1746B/0.D05 - Cooking chamber



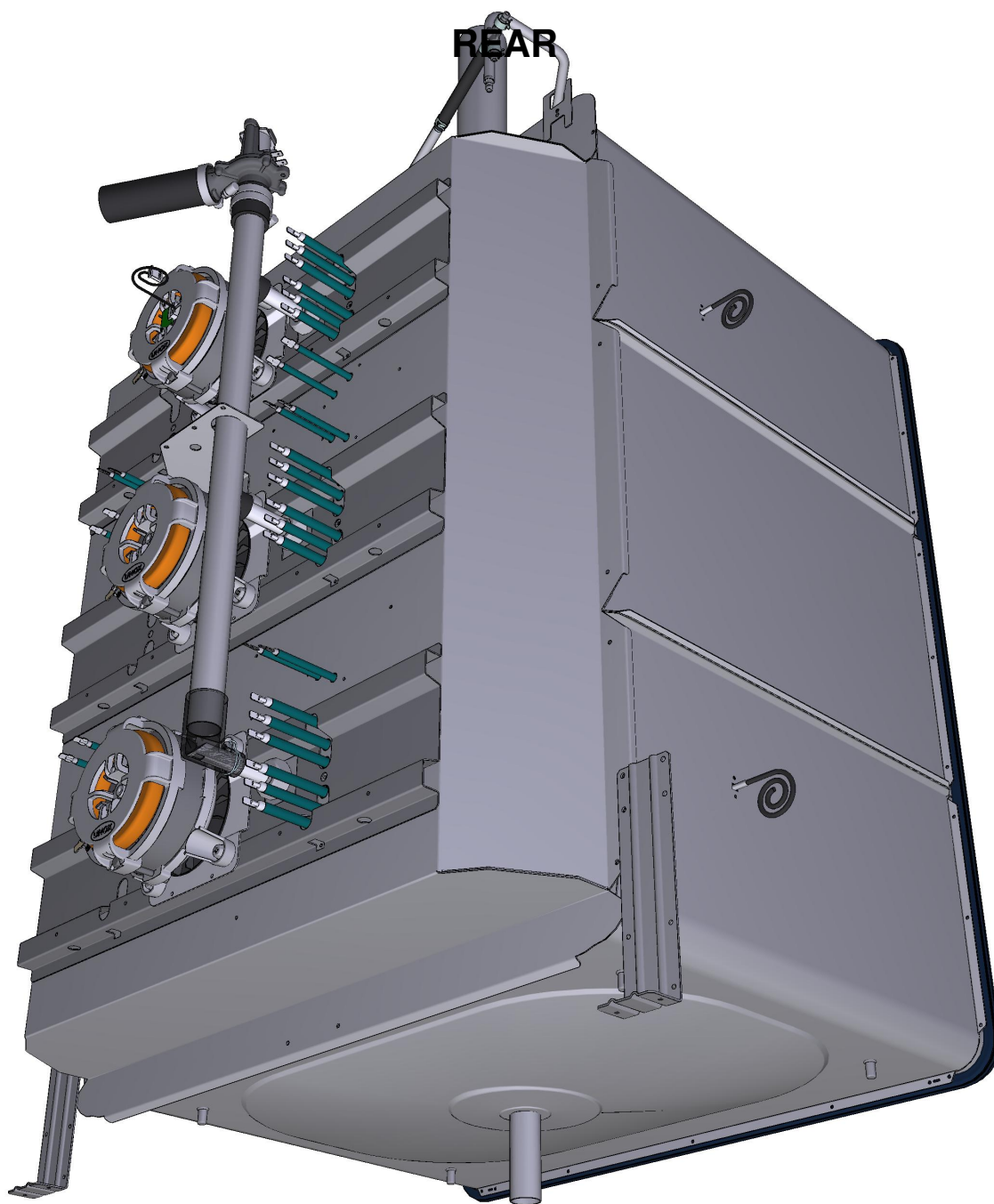



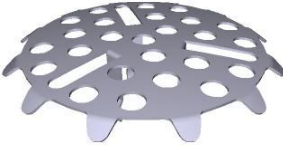

ASM1746B/0.D05 - Cooking chamber





COMPONENT			SPARE PART																																																		
Code	Description	Image	Code	Description	Components list																																																
VL1037A	WASHING SYSTEM ROTOR		KVL1037A	WASHING SYSTEM ROTOR KIT	<table border="1"> <thead> <tr> <th>Code</th> <th>Description</th> <th>Qty</th> <th>UOM</th> </tr> </thead> <tbody> <tr> <td>GN1416B0</td> <td>WASHING SYSTEM ROTOR BEARING</td> <td>1</td> <td>PZ</td> </tr> <tr> <td>MOV0015A0</td> <td>HOOD RING GASKET GN1110A2</td> <td>0.100</td> <td>PZ</td> </tr> <tr> <td>TF1065B0</td> <td>WASHING SYSTEM ROTOR PIVOT</td> <td>1</td> <td>PZ</td> </tr> <tr> <td>TF1066A1</td> <td>WASHING SYSTEM ROTOR BUSH</td> <td>1</td> <td>PZ</td> </tr> <tr> <td>UG1005B1</td> <td>LONG RAY ROTOR WATER NOZZL</td> <td>1</td> <td>PZ</td> </tr> <tr> <td>UG1006B3</td> <td>LONG RAY ROTOR WATER NOZZL</td> <td>1</td> <td>PZ</td> </tr> <tr> <td>VI1220A1</td> <td>4,2X12 TCB SELF-TAPPIN G SCREW</td> <td>8</td> <td>PZ</td> </tr> <tr> <td>VM1224A0</td> <td>65MY 220MM 2 COLOURS SHRINK TUBE</td> <td>0.250</td> <td>M</td> </tr> <tr> <td>VM1955C0</td> <td>WASHING SYSTEM ROTOR</td> <td>1</td> <td>PZ</td> </tr> <tr> <td>VM1985C1</td> <td>WASHING SYSTEM ROTOR COVE</td> <td>1</td> <td>PZ</td> </tr> <tr> <td>VM1986A0</td> <td>NOZZLE COVE</td> <td>2</td> <td>PZ</td> </tr> </tbody> </table>	Code	Description	Qty	UOM	GN1416B0	WASHING SYSTEM ROTOR BEARING	1	PZ	MOV0015A0	HOOD RING GASKET GN1110A2	0.100	PZ	TF1065B0	WASHING SYSTEM ROTOR PIVOT	1	PZ	TF1066A1	WASHING SYSTEM ROTOR BUSH	1	PZ	UG1005B1	LONG RAY ROTOR WATER NOZZL	1	PZ	UG1006B3	LONG RAY ROTOR WATER NOZZL	1	PZ	VI1220A1	4,2X12 TCB SELF-TAPPIN G SCREW	8	PZ	VM1224A0	65MY 220MM 2 COLOURS SHRINK TUBE	0.250	M	VM1955C0	WASHING SYSTEM ROTOR	1	PZ	VM1985C1	WASHING SYSTEM ROTOR COVE	1	PZ	VM1986A0	NOZZLE COVE	2	PZ
					Code	Description	Qty	UOM																																													
					GN1416B0	WASHING SYSTEM ROTOR BEARING	1	PZ																																													
					MOV0015A0	HOOD RING GASKET GN1110A2	0.100	PZ																																													
					TF1065B0	WASHING SYSTEM ROTOR PIVOT	1	PZ																																													
					TF1066A1	WASHING SYSTEM ROTOR BUSH	1	PZ																																													
					UG1005B1	LONG RAY ROTOR WATER NOZZL	1	PZ																																													
					UG1006B3	LONG RAY ROTOR WATER NOZZL	1	PZ																																													
					VI1220A1	4,2X12 TCB SELF-TAPPIN G SCREW	8	PZ																																													
					VM1224A0	65MY 220MM 2 COLOURS SHRINK TUBE	0.250	M																																													
					VM1955C0	WASHING SYSTEM ROTOR	1	PZ																																													
VM1985C1	WASHING SYSTEM ROTOR COVE	1	PZ																																																		
VM1986A0	NOZZLE COVE	2	PZ																																																		
0H2551A	XBC/XVC ST.STEEL DRAIN COVER		K0H2551A	DRAIN COVER KIT	<table border="1"> <thead> <tr> <th>Code</th> <th>Description</th> <th>Qty</th> <th>UOM</th> </tr> </thead> <tbody> <tr> <td>0H2551A0</td> <td>XBC/XVC ST.STEEL DRAIN COVER</td> <td>1</td> <td>PZ</td> </tr> <tr> <td>VM1224A0</td> <td>65MY 220MM 2 COLOURS SHRINK TUBE</td> <td>0.200</td> <td>M</td> </tr> </tbody> </table>	Code	Description	Qty	UOM	0H2551A0	XBC/XVC ST.STEEL DRAIN COVER	1	PZ	VM1224A0	65MY 220MM 2 COLOURS SHRINK TUBE	0.200	M																																				
					Code	Description	Qty	UOM																																													
0H2551A0	XBC/XVC ST.STEEL DRAIN COVER	1	PZ																																																		
VM1224A0	65MY 220MM 2 COLOURS SHRINK TUBE	0.200	M																																																		
VM1820A	LATERAL SUPPORTS M6 FIXING BOLT		KVM1820A	THUMB SCREW 10PCS KIT	<table border="1"> <thead> <tr> <th>Code</th> <th>Description</th> <th>Qty</th> <th>UOM</th> </tr> </thead> <tbody> <tr> <td>VM1224A0</td> <td>65MY 220MM 2 COLOURS SHRINK TUBE</td> <td>0.200</td> <td>M</td> </tr> <tr> <td>VM1820A0</td> <td>LATERAL SUPPORTS M6 FIXING BOLT</td> <td>10</td> <td>PZ</td> </tr> </tbody> </table>	Code	Description	Qty	UOM	VM1224A0	65MY 220MM 2 COLOURS SHRINK TUBE	0.200	M	VM1820A0	LATERAL SUPPORTS M6 FIXING BOLT	10	PZ																																				
					Code	Description	Qty	UOM																																													
VM1224A0	65MY 220MM 2 COLOURS SHRINK TUBE	0.200	M																																																		
VM1820A0	LATERAL SUPPORTS M6 FIXING BOLT	10	PZ																																																		



COMPONENT			SPARE PART																										
Code	Description	Image	Code	Description	Components list																								
VM2331A	FAN GUARD-TRAYS HOLDER PIN		KVM2331A	KIT FAN GUARD-TRAYS HOLDER PIN	<table border="1"> <thead> <tr> <th>Code</th> <th>Description</th> <th>Qty</th> <th>UOM</th> </tr> </thead> <tbody> <tr> <td>VM1224A0</td> <td>65MY 220MM 2 COLOURS SHRINK TUBE</td> <td>0.200</td> <td>M</td> </tr> <tr> <td>VM2331A0</td> <td>FAN GUARD-TRAY S HOLDER PIN</td> <td>4</td> <td>PZ</td> </tr> </tbody> </table>	Code	Description	Qty	UOM	VM1224A0	65MY 220MM 2 COLOURS SHRINK TUBE	0.200	M	VM2331A0	FAN GUARD-TRAY S HOLDER PIN	4	PZ												
Code	Description	Qty	UOM																										
VM1224A0	65MY 220MM 2 COLOURS SHRINK TUBE	0.200	M																										
VM2331A0	FAN GUARD-TRAY S HOLDER PIN	4	PZ																										
TB3033A	XEBC-10 CHAMBER CHIMNEY PIPE D50		TB3033A0	XEBC-10 CHAMBER CHIMNEY PIPE D50																									
0H2730A	ZINC PLATED MUFFLE SUPPORT BRACKET		0H2730A1	ZINC PLATED MUFFLE SUPPORT BRACKET																									
ASM1844B	Venturi		ASM1844B0	Venturi																									
RC1378A	HOSE CLAMP		KVE1135A	SERIES 5/5E VENTURI KIT	<table border="1"> <thead> <tr> <th>Code</th> <th>Description</th> <th>Qty</th> <th>UOM</th> </tr> </thead> <tbody> <tr> <td>GN1556A0</td> <td>MM VENTURI SEAL</td> <td>1</td> <td>PZ</td> </tr> <tr> <td>RC1378A0</td> <td>HOSE CLAMP</td> <td>2</td> <td>PZ</td> </tr> <tr> <td>TB1520A0</td> <td>INT. Ø=38 TH=4 DRAIN BLACK RUBBER PIPE</td> <td>0.050</td> <td>M</td> </tr> <tr> <td>VE1135A0</td> <td>220 V 50/60 HZ VENTURI ACTUATOR</td> <td>1</td> <td>PZ</td> </tr> <tr> <td>VI1032A0</td> <td>SCREW M4X16 TCB+ INOX</td> <td>1</td> <td>PZ</td> </tr> </tbody> </table>	Code	Description	Qty	UOM	GN1556A0	MM VENTURI SEAL	1	PZ	RC1378A0	HOSE CLAMP	2	PZ	TB1520A0	INT. Ø=38 TH=4 DRAIN BLACK RUBBER PIPE	0.050	M	VE1135A0	220 V 50/60 HZ VENTURI ACTUATOR	1	PZ	VI1032A0	SCREW M4X16 TCB+ INOX	1	PZ
Code	Description	Qty	UOM																										
GN1556A0	MM VENTURI SEAL	1	PZ																										
RC1378A0	HOSE CLAMP	2	PZ																										
TB1520A0	INT. Ø=38 TH=4 DRAIN BLACK RUBBER PIPE	0.050	M																										
VE1135A0	220 V 50/60 HZ VENTURI ACTUATOR	1	PZ																										
VI1032A0	SCREW M4X16 TCB+ INOX	1	PZ																										



COMPONENT			SPARE PART																																										
Code	Description	Image	Code	Description	Components list																																								
RC1378A	HOSE CLAMP		KVE1135A	SERIES 5/5E VENTURI KIT	<table border="1"> <thead> <tr> <th>Code</th> <th>Description</th> <th>Qty</th> <th>UOM</th> </tr> </thead> <tbody> <tr> <td>VI1511A0</td> <td>STAINLESS STEEL WASHER 4.2X12X1</td> <td>2</td> <td>PZ</td> </tr> <tr> <td>VI1850A0</td> <td>M4X6 NICKEL PLATED FIXING SCREW</td> <td>2</td> <td>PZ</td> </tr> <tr> <td>VI1865A0</td> <td>5X10 TCB+ SELF-THREADI NG SCREW</td> <td>3</td> <td>PZ</td> </tr> <tr> <td>VI1965A0</td> <td>M4X6 CROSS-HEAD ST. STEEL SCREW</td> <td>2</td> <td>PZ</td> </tr> <tr> <td>VM1224A0</td> <td>65MY 220MM 2 COLOURS SHRINK TUBE</td> <td>0.250</td> <td>M</td> </tr> <tr> <td>VM1565B0</td> <td>VENTURI LOWER COIL SUPPORT</td> <td>1</td> <td>PZ</td> </tr> <tr> <td>VM1566A0</td> <td>VENTURI UPPER COIL SUPPORT</td> <td>1</td> <td>PZ</td> </tr> <tr> <td>VM1567A0</td> <td>VENTURI LOWER BUSHING</td> <td>1</td> <td>PZ</td> </tr> <tr> <td>VM1568A0</td> <td>VENTURI PLATE SPACE</td> <td>1</td> <td>PZ</td> </tr> </tbody> </table>	Code	Description	Qty	UOM	VI1511A0	STAINLESS STEEL WASHER 4.2X12X1	2	PZ	VI1850A0	M4X6 NICKEL PLATED FIXING SCREW	2	PZ	VI1865A0	5X10 TCB+ SELF-THREADI NG SCREW	3	PZ	VI1965A0	M4X6 CROSS-HEAD ST. STEEL SCREW	2	PZ	VM1224A0	65MY 220MM 2 COLOURS SHRINK TUBE	0.250	M	VM1565B0	VENTURI LOWER COIL SUPPORT	1	PZ	VM1566A0	VENTURI UPPER COIL SUPPORT	1	PZ	VM1567A0	VENTURI LOWER BUSHING	1	PZ	VM1568A0	VENTURI PLATE SPACE	1	PZ
					Code	Description	Qty	UOM																																					
					VI1511A0	STAINLESS STEEL WASHER 4.2X12X1	2	PZ																																					
					VI1850A0	M4X6 NICKEL PLATED FIXING SCREW	2	PZ																																					
					VI1865A0	5X10 TCB+ SELF-THREADI NG SCREW	3	PZ																																					
					VI1965A0	M4X6 CROSS-HEAD ST. STEEL SCREW	2	PZ																																					
					VM1224A0	65MY 220MM 2 COLOURS SHRINK TUBE	0.250	M																																					
					VM1565B0	VENTURI LOWER COIL SUPPORT	1	PZ																																					
					VM1566A0	VENTURI UPPER COIL SUPPORT	1	PZ																																					
					VM1567A0	VENTURI LOWER BUSHING	1	PZ																																					
VM1568A0	VENTURI PLATE SPACE	1	PZ																																										
GN1544A	AIR INLET GASKET		KTB3128A	XECC-1013-E VENTURI COLLECTOR PIPE KI	<table border="1"> <thead> <tr> <th>Code</th> <th>Description</th> <th>Qty</th> <th>UOM</th> </tr> </thead> <tbody> <tr> <td>GN1544A0</td> <td>AIR INLET GASKET</td> <td>1</td> <td>PZ</td> </tr> <tr> <td>GN1584A0</td> <td>CORNER FITTING D30-D16</td> <td>1</td> <td>PZ</td> </tr> <tr> <td>TB3128A0</td> <td>XECC-10 VENTURI AIR EXIT PIPE</td> <td>1</td> <td>PZ</td> </tr> </tbody> </table>	Code	Description	Qty	UOM	GN1544A0	AIR INLET GASKET	1	PZ	GN1584A0	CORNER FITTING D30-D16	1	PZ	TB3128A0	XECC-10 VENTURI AIR EXIT PIPE	1	PZ																								
					Code	Description	Qty	UOM																																					
					GN1544A0	AIR INLET GASKET	1	PZ																																					
					GN1584A0	CORNER FITTING D30-D16	1	PZ																																					
					TB3128A0	XECC-10 VENTURI AIR EXIT PIPE	1	PZ																																					
			KTB3074B	XEVC-0711-G VENTURI COLLECTOR PIPE KI	<table border="1"> <thead> <tr> <th>Code</th> <th>Description</th> <th>Qty</th> <th>UOM</th> </tr> </thead> <tbody> <tr> <td>GN1544A0</td> <td>AIR INLET GASKET</td> <td>1</td> <td>PZ</td> </tr> <tr> <td>GN1584A0</td> <td>CORNER FITTING D30-D16</td> <td>1</td> <td>PZ</td> </tr> <tr> <td>RC1042A0</td> <td>DOUBLE WIRE SPRING CLAMP D21.5-22.6</td> <td>1</td> <td>PZ</td> </tr> <tr> <td>TB3074B0</td> <td>XEVC-07EU-G VENTURI COLLECTOR PIPE D30</td> <td>1</td> <td>PZ</td> </tr> </tbody> </table>	Code	Description	Qty	UOM	GN1544A0	AIR INLET GASKET	1	PZ	GN1584A0	CORNER FITTING D30-D16	1	PZ	RC1042A0	DOUBLE WIRE SPRING CLAMP D21.5-22.6	1	PZ	TB3074B0	XEVC-07EU-G VENTURI COLLECTOR PIPE D30	1	PZ																				
					Code	Description	Qty	UOM																																					
					GN1544A0	AIR INLET GASKET	1	PZ																																					
					GN1584A0	CORNER FITTING D30-D16	1	PZ																																					
					RC1042A0	DOUBLE WIRE SPRING CLAMP D21.5-22.6	1	PZ																																					
TB3074B0	XEVC-07EU-G VENTURI COLLECTOR PIPE D30	1	PZ																																										
VM1794A0	250X4.8 PA66 BLACK CLAMP	1	PZ																																										



COMPONENT			SPARE PART																										
Code	Description	Image	Code	Description	Components list																								
GN1544A	AIR INLET GASKET		KTB3068B	10FS/EU/2-G VENTURI COLLECTOR PIPE KI	<table border="1"> <thead> <tr> <th>Code</th> <th>Description</th> <th>Qty</th> <th>UOM</th> </tr> </thead> <tbody> <tr> <td>GN1544A0</td> <td>AIR INLET GASKET</td> <td>2</td> <td>PZ</td> </tr> <tr> <td>GN1584A0</td> <td>CORNER FITTING D30-D16</td> <td>1</td> <td>PZ</td> </tr> <tr> <td>RC1042A0</td> <td>DOUBLE WIRE SPRING CLAMP D21.5-22.6</td> <td>1</td> <td>PZ</td> </tr> <tr> <td>TB3068B0</td> <td>XEBC-10 VENTURI AIR COLLECTOR PIPE D30</td> <td>1</td> <td>PZ</td> </tr> <tr> <td>VM1794A0</td> <td>250X4.8 PA66 BLACK CLAMP</td> <td>1</td> <td>PZ</td> </tr> </tbody> </table>	Code	Description	Qty	UOM	GN1544A0	AIR INLET GASKET	2	PZ	GN1584A0	CORNER FITTING D30-D16	1	PZ	RC1042A0	DOUBLE WIRE SPRING CLAMP D21.5-22.6	1	PZ	TB3068B0	XEBC-10 VENTURI AIR COLLECTOR PIPE D30	1	PZ	VM1794A0	250X4.8 PA66 BLACK CLAMP	1	PZ
					Code	Description	Qty	UOM																					
					GN1544A0	AIR INLET GASKET	2	PZ																					
					GN1584A0	CORNER FITTING D30-D16	1	PZ																					
			RC1042A0	DOUBLE WIRE SPRING CLAMP D21.5-22.6	1	PZ																							
			TB3068B0	XEBC-10 VENTURI AIR COLLECTOR PIPE D30	1	PZ																							
			VM1794A0	250X4.8 PA66 BLACK CLAMP	1	PZ																							
			KTB3019A	20XX/16XX UPPER VENTURI COLLECT PIPE KIT	<table border="1"> <thead> <tr> <th>Code</th> <th>Description</th> <th>Qty</th> <th>UOM</th> </tr> </thead> <tbody> <tr> <td>GN1544A0</td> <td>AIR INLET GASKET</td> <td>1</td> <td>PZ</td> </tr> <tr> <td>GN1584A0</td> <td>CORNER FITTING D30-D16</td> <td>1</td> <td>PZ</td> </tr> <tr> <td>RC1042A0</td> <td>DOUBLE WIRE SPRING CLAMP D21.5-22.6</td> <td>1</td> <td>PZ</td> </tr> <tr> <td>TB3019A1</td> <td>XEVC-2011 UPPER AIR INLET PIPE D3</td> <td>1</td> <td>PZ</td> </tr> <tr> <td>VM1794A0</td> <td>250X4.8 PA66 BLACK CLAMP</td> <td>1</td> <td>PZ</td> </tr> </tbody> </table>	Code	Description	Qty	UOM	GN1544A0	AIR INLET GASKET	1	PZ	GN1584A0	CORNER FITTING D30-D16	1	PZ	RC1042A0	DOUBLE WIRE SPRING CLAMP D21.5-22.6	1	PZ	TB3019A1	XEVC-2011 UPPER AIR INLET PIPE D3	1	PZ	VM1794A0	250X4.8 PA66 BLACK CLAMP	1	PZ
					Code	Description	Qty	UOM																					
					GN1544A0	AIR INLET GASKET	1	PZ																					
					GN1584A0	CORNER FITTING D30-D16	1	PZ																					
			RC1042A0	DOUBLE WIRE SPRING CLAMP D21.5-22.6	1	PZ																							
TB3019A1	XEVC-2011 UPPER AIR INLET PIPE D3	1	PZ																										
VM1794A0	250X4.8 PA66 BLACK CLAMP	1	PZ																										
KTB2979C	XEBC-10XX-E VENTURI COLLECTOR PIPE KI	<table border="1"> <thead> <tr> <th>Code</th> <th>Description</th> <th>Qty</th> <th>UOM</th> </tr> </thead> <tbody> <tr> <td>GN1544A0</td> <td>AIR INLET GASKET</td> <td>2</td> <td>PZ</td> </tr> <tr> <td>GN1584A0</td> <td>CORNER FITTING D30-D16</td> <td>1</td> <td>PZ</td> </tr> <tr> <td>RC1042A0</td> <td>DOUBLE WIRE SPRING CLAMP D21.5-22.6</td> <td>1</td> <td>PZ</td> </tr> <tr> <td>TB2979C0</td> <td>XEBC-10 VENTURI AIR COLLECTOR PIPE D30</td> <td>1</td> <td>PZ</td> </tr> <tr> <td>VM1794A0</td> <td>250X4.8 PA66 BLACK CLAMP</td> <td>1</td> <td>PZ</td> </tr> </tbody> </table>	Code	Description	Qty	UOM	GN1544A0	AIR INLET GASKET	2	PZ	GN1584A0	CORNER FITTING D30-D16	1	PZ	RC1042A0	DOUBLE WIRE SPRING CLAMP D21.5-22.6	1	PZ	TB2979C0	XEBC-10 VENTURI AIR COLLECTOR PIPE D30	1	PZ	VM1794A0	250X4.8 PA66 BLACK CLAMP	1	PZ			
		Code	Description	Qty	UOM																								
		GN1544A0	AIR INLET GASKET	2	PZ																								
		GN1584A0	CORNER FITTING D30-D16	1	PZ																								
RC1042A0	DOUBLE WIRE SPRING CLAMP D21.5-22.6	1	PZ																										
TB2979C0	XEBC-10 VENTURI AIR COLLECTOR PIPE D30	1	PZ																										
VM1794A0	250X4.8 PA66 BLACK CLAMP	1	PZ																										
KTB2978B	XEBC-06 VENTURI COLLECTOR PIPE KI	<table border="1"> <thead> <tr> <th>Code</th> <th>Description</th> <th>Qty</th> <th>UOM</th> </tr> </thead> <tbody> <tr> <td>GN1544A0</td> <td>AIR INLET GASKET</td> <td>1</td> <td>PZ</td> </tr> </tbody> </table>	Code	Description	Qty	UOM	GN1544A0	AIR INLET GASKET	1	PZ																			
Code	Description	Qty	UOM																										
GN1544A0	AIR INLET GASKET	1	PZ																										



COMPONENT			SPARE PART																							
Code	Description	Image	Code	Description	Components list																					
GN1544A	AIR INLET GASKET		KTB2978B	XEBC-06 VENTURI COLLECTOR PIPE KI	<table border="1"> <thead> <tr> <th>Code</th> <th>Description</th> <th>Qty</th> <th>UOM</th> </tr> </thead> <tbody> <tr> <td>GN1584A0</td> <td>CORNER FITTING D30-D16</td> <td>1</td> <td>PZ</td> </tr> <tr> <td>RC1042A0</td> <td>DOUBLE WIRE SPRING CLAMP D21.5-22.6</td> <td>1</td> <td>PZ</td> </tr> <tr> <td>TB2978B0</td> <td>XEBC-06 VENTURI AIR COLLECTOR PIPE D30</td> <td>1</td> <td>PZ</td> </tr> <tr> <td>VM1794A0</td> <td>250X4.8 PA66 BLACK CLAMP</td> <td>1</td> <td>PZ</td> </tr> </tbody> </table>	Code	Description	Qty	UOM	GN1584A0	CORNER FITTING D30-D16	1	PZ	RC1042A0	DOUBLE WIRE SPRING CLAMP D21.5-22.6	1	PZ	TB2978B0	XEBC-06 VENTURI AIR COLLECTOR PIPE D30	1	PZ	VM1794A0	250X4.8 PA66 BLACK CLAMP	1	PZ	
			Code	Description	Qty	UOM																				
			GN1584A0	CORNER FITTING D30-D16	1	PZ																				
			RC1042A0	DOUBLE WIRE SPRING CLAMP D21.5-22.6	1	PZ																				
TB2978B0	XEBC-06 VENTURI AIR COLLECTOR PIPE D30	1	PZ																							
VM1794A0	250X4.8 PA66 BLACK CLAMP	1	PZ																							
KTB2959B	XEVC-1011-E VENTURI COLLECTOR PIPE KI	<table border="1"> <thead> <tr> <th>Code</th> <th>Description</th> <th>Qty</th> <th>UOM</th> </tr> </thead> <tbody> <tr> <td>GN1544A0</td> <td>AIR INLET GASKET</td> <td>2</td> <td>PZ</td> </tr> <tr> <td>GN1584A0</td> <td>CORNER FITTING D30-D16</td> <td>1</td> <td>PZ</td> </tr> <tr> <td>RC1042A0</td> <td>DOUBLE WIRE SPRING CLAMP D21.5-22.6</td> <td>1</td> <td>PZ</td> </tr> <tr> <td>TB2959B0</td> <td>XEVC-1011-E VENTURI PIPE</td> <td>1</td> <td>PZ</td> </tr> <tr> <td>VM1794A0</td> <td>250X4.8 PA66 BLACK CLAMP</td> <td>1</td> <td>PZ</td> </tr> </tbody> </table>	Code	Description	Qty	UOM	GN1544A0	AIR INLET GASKET	2	PZ	GN1584A0	CORNER FITTING D30-D16	1	PZ	RC1042A0	DOUBLE WIRE SPRING CLAMP D21.5-22.6	1	PZ	TB2959B0	XEVC-1011-E VENTURI PIPE	1	PZ	VM1794A0	250X4.8 PA66 BLACK CLAMP	1	PZ
Code	Description	Qty	UOM																							
GN1544A0	AIR INLET GASKET	2	PZ																							
GN1584A0	CORNER FITTING D30-D16	1	PZ																							
RC1042A0	DOUBLE WIRE SPRING CLAMP D21.5-22.6	1	PZ																							
TB2959B0	XEVC-1011-E VENTURI PIPE	1	PZ																							
VM1794A0	250X4.8 PA66 BLACK CLAMP	1	PZ																							
KTB2958B	XEVC-0711-E VENTURI COLLECTOR PIPE KI	<table border="1"> <thead> <tr> <th>Code</th> <th>Description</th> <th>Qty</th> <th>UOM</th> </tr> </thead> <tbody> <tr> <td>GN1544A0</td> <td>AIR INLET GASKET</td> <td>1</td> <td>PZ</td> </tr> <tr> <td>GN1584A0</td> <td>CORNER FITTING D30-D16</td> <td>1</td> <td>PZ</td> </tr> <tr> <td>RC1042A0</td> <td>DOUBLE WIRE SPRING CLAMP D21.5-22.6</td> <td>1</td> <td>PZ</td> </tr> <tr> <td>TB2958B0</td> <td>XEVC-0711-E VENTURI PIPE</td> <td>1</td> <td>PZ</td> </tr> <tr> <td>VM1794A0</td> <td>250X4.8 PA66 BLACK CLAMP</td> <td>1</td> <td>PZ</td> </tr> </tbody> </table>	Code	Description	Qty	UOM	GN1544A0	AIR INLET GASKET	1	PZ	GN1584A0	CORNER FITTING D30-D16	1	PZ	RC1042A0	DOUBLE WIRE SPRING CLAMP D21.5-22.6	1	PZ	TB2958B0	XEVC-0711-E VENTURI PIPE	1	PZ	VM1794A0	250X4.8 PA66 BLACK CLAMP	1	PZ
Code	Description	Qty	UOM																							
GN1544A0	AIR INLET GASKET	1	PZ																							
GN1584A0	CORNER FITTING D30-D16	1	PZ																							
RC1042A0	DOUBLE WIRE SPRING CLAMP D21.5-22.6	1	PZ																							
TB2958B0	XEVC-0711-E VENTURI PIPE	1	PZ																							
VM1794A0	250X4.8 PA66 BLACK CLAMP	1	PZ																							
KTB2957B	0511/04EU-E VENTURI COLLECTOR PIPE KI	<table border="1"> <thead> <tr> <th>Code</th> <th>Description</th> <th>Qty</th> <th>UOM</th> </tr> </thead> <tbody> <tr> <td>GN1544A0</td> <td>AIR INLET GASKET</td> <td>1</td> <td>PZ</td> </tr> <tr> <td>GN1584A0</td> <td>CORNER FITTING D30-D16</td> <td>1</td> <td>PZ</td> </tr> <tr> <td>RC1042A0</td> <td>DOUBLE WIRE SPRING CLAMP D21.5-22.6</td> <td>1</td> <td>PZ</td> </tr> </tbody> </table>	Code	Description	Qty	UOM	GN1544A0	AIR INLET GASKET	1	PZ	GN1584A0	CORNER FITTING D30-D16	1	PZ	RC1042A0	DOUBLE WIRE SPRING CLAMP D21.5-22.6	1	PZ								
Code	Description	Qty	UOM																							
GN1544A0	AIR INLET GASKET	1	PZ																							
GN1584A0	CORNER FITTING D30-D16	1	PZ																							
RC1042A0	DOUBLE WIRE SPRING CLAMP D21.5-22.6	1	PZ																							



COMPONENT			SPARE PART																										
Code	Description	Image	Code	Description	Components list																								
GN1544A	AIR INLET GASKET		KTB2957B	0511/04EU-E VENTURI COLLECTOR PIPE KI	<table border="1"> <thead> <tr> <th>Code</th> <th>Description</th> <th>Qty</th> <th>UOM</th> </tr> </thead> <tbody> <tr> <td>TB2957B0</td> <td>XEVC-0511-E VENTURI PIPE</td> <td>1</td> <td>PZ</td> </tr> <tr> <td>VM1794A0</td> <td>250X4.8 PA66 BLACK CLAMP</td> <td>1</td> <td>PZ</td> </tr> </tbody> </table>	Code	Description	Qty	UOM	TB2957B0	XEVC-0511-E VENTURI PIPE	1	PZ	VM1794A0	250X4.8 PA66 BLACK CLAMP	1	PZ												
			Code	Description	Qty	UOM																							
			TB2957B0	XEVC-0511-E VENTURI PIPE	1	PZ																							
			VM1794A0	250X4.8 PA66 BLACK CLAMP	1	PZ																							
			KTB2956A	XEVC-0311-E VENTURI COLLECTOR PIPE KI	<table border="1"> <thead> <tr> <th>Code</th> <th>Description</th> <th>Qty</th> <th>UOM</th> </tr> </thead> <tbody> <tr> <td>GN1544A0</td> <td>AIR INLET GASKET</td> <td>1</td> <td>PZ</td> </tr> <tr> <td>RC1042A0</td> <td>DOUBLE WIRE SPRING CLAMP D21.5-22.6</td> <td>1</td> <td>PZ</td> </tr> <tr> <td>TB2956A0</td> <td>XEVC-0311-E VENTURI PIPE</td> <td>1</td> <td>PZ</td> </tr> </tbody> </table>	Code	Description	Qty	UOM	GN1544A0	AIR INLET GASKET	1	PZ	RC1042A0	DOUBLE WIRE SPRING CLAMP D21.5-22.6	1	PZ	TB2956A0	XEVC-0311-E VENTURI PIPE	1	PZ								
			Code	Description	Qty	UOM																							
			GN1544A0	AIR INLET GASKET	1	PZ																							
			RC1042A0	DOUBLE WIRE SPRING CLAMP D21.5-22.6	1	PZ																							
			TB2956A0	XEVC-0311-E VENTURI PIPE	1	PZ																							
			KTB2944A	20XX/16XX LOWER VENTURI COLLECT PIPE KIT	<table border="1"> <thead> <tr> <th>Code</th> <th>Description</th> <th>Qty</th> <th>UOM</th> </tr> </thead> <tbody> <tr> <td>GN1544A0</td> <td>AIR INLET GASKET</td> <td>2</td> <td>PZ</td> </tr> <tr> <td>GN1584A0</td> <td>CORNER FITTING D30-D16</td> <td>1</td> <td>PZ</td> </tr> <tr> <td>RC1042A0</td> <td>DOUBLE WIRE SPRING CLAMP D21.5-22.6</td> <td>1</td> <td>PZ</td> </tr> <tr> <td>TB2944A1</td> <td>XEVC-2011 AIR INLET PIPE D3</td> <td>1</td> <td>PZ</td> </tr> <tr> <td>VM1794A0</td> <td>250X4.8 PA66 BLACK CLAMP</td> <td>1</td> <td>PZ</td> </tr> </tbody> </table>	Code	Description	Qty	UOM	GN1544A0	AIR INLET GASKET	2	PZ	GN1584A0	CORNER FITTING D30-D16	1	PZ	RC1042A0	DOUBLE WIRE SPRING CLAMP D21.5-22.6	1	PZ	TB2944A1	XEVC-2011 AIR INLET PIPE D3	1	PZ	VM1794A0	250X4.8 PA66 BLACK CLAMP	1	PZ
			Code	Description	Qty	UOM																							
			GN1544A0	AIR INLET GASKET	2	PZ																							
GN1584A0	CORNER FITTING D30-D16	1	PZ																										
RC1042A0	DOUBLE WIRE SPRING CLAMP D21.5-22.6	1	PZ																										
TB2944A1	XEVC-2011 AIR INLET PIPE D3	1	PZ																										
VM1794A0	250X4.8 PA66 BLACK CLAMP	1	PZ																										
KTB1323A	XECC-05XX-E VENTURI COLLECTOR PIPE KI	<table border="1"> <thead> <tr> <th>Code</th> <th>Description</th> <th>Qty</th> <th>UOM</th> </tr> </thead> <tbody> <tr> <td>GN1544A0</td> <td>AIR INLET GASKET</td> <td>1</td> <td>PZ</td> </tr> <tr> <td>GN1584A0</td> <td>CORNER FITTING D30-D16</td> <td>1</td> <td>PZ</td> </tr> <tr> <td>RC1042A0</td> <td>DOUBLE WIRE SPRING CLAMP D21.5-22.6</td> <td>1</td> <td>PZ</td> </tr> <tr> <td>TB1323A1</td> <td>XECC-05XX VENTURI AIR EXIT PIPE</td> <td>1</td> <td>PZ</td> </tr> </tbody> </table>	Code	Description	Qty	UOM	GN1544A0	AIR INLET GASKET	1	PZ	GN1584A0	CORNER FITTING D30-D16	1	PZ	RC1042A0	DOUBLE WIRE SPRING CLAMP D21.5-22.6	1	PZ	TB1323A1	XECC-05XX VENTURI AIR EXIT PIPE	1	PZ							
Code	Description	Qty	UOM																										
GN1544A0	AIR INLET GASKET	1	PZ																										
GN1584A0	CORNER FITTING D30-D16	1	PZ																										
RC1042A0	DOUBLE WIRE SPRING CLAMP D21.5-22.6	1	PZ																										
TB1323A1	XECC-05XX VENTURI AIR EXIT PIPE	1	PZ																										
KG1544A	5 PCS AIR INLET GASKET KIT	<table border="1"> <thead> <tr> <th>Code</th> <th>Description</th> <th>Qty</th> <th>UOM</th> </tr> </thead> <tbody> <tr> <td>GN1544A0</td> <td>AIR INLET GASKET</td> <td>5</td> <td>PZ</td> </tr> <tr> <td>VM1224A0</td> <td>65MY 220MM 2 COLOURS SHRINK TUBE</td> <td>0.200</td> <td>M</td> </tr> </tbody> </table>	Code	Description	Qty	UOM	GN1544A0	AIR INLET GASKET	5	PZ	VM1224A0	65MY 220MM 2 COLOURS SHRINK TUBE	0.200	M															
Code	Description	Qty	UOM																										
GN1544A0	AIR INLET GASKET	5	PZ																										
VM1224A0	65MY 220MM 2 COLOURS SHRINK TUBE	0.200	M																										

COMPONENT			SPARE PART																
Code	Description	Image	Code	Description	Components list														
GN1584A	CORNER FITTING D30-D16		KGN1584A	D30-D16 CORNER FITTING KIT	<table border="1"> <thead> <tr> <th>Code</th> <th>Description</th> <th>Qty</th> <th>UOM</th> </tr> </thead> <tbody> <tr> <td>GN1584A0</td> <td>CORNER FITTING D30-D16</td> <td>1</td> <td>PZ</td> </tr> <tr> <td>VM1224A0</td> <td>65MY 220MM 2 COLOURS SHRINK TUBE</td> <td>0.150</td> <td>M</td> </tr> </tbody> </table>	Code	Description	Qty	UOM	GN1584A0	CORNER FITTING D30-D16	1	PZ	VM1224A0	65MY 220MM 2 COLOURS SHRINK TUBE	0.150	M		
					Code	Description	Qty	UOM											
GN1584A0	CORNER FITTING D30-D16	1	PZ																
VM1224A0	65MY 220MM 2 COLOURS SHRINK TUBE	0.150	M																
<table border="1"> <thead> <tr> <th>Code</th> <th>Description</th> <th>Qty</th> <th>UOM</th> </tr> </thead> <tbody> <tr> <td>TB1520A0</td> <td>INT. Ø=38 TH=4 DRAIN BLACK RUBBER PIPE</td> <td>0.120</td> <td>M</td> </tr> <tr> <td>VM1224A0</td> <td>65MY 220MM 2 COLOURS SHRINK TUBE</td> <td>0.200</td> <td>M</td> </tr> </tbody> </table>	Code	Description	Qty	UOM	TB1520A0	INT. Ø=38 TH=4 DRAIN BLACK RUBBER PIPE	0.120	M	VM1224A0	65MY 220MM 2 COLOURS SHRINK TUBE	0.200	M							
Code	Description	Qty	UOM																
TB1520A0	INT. Ø=38 TH=4 DRAIN BLACK RUBBER PIPE	0.120	M																
VM1224A0	65MY 220MM 2 COLOURS SHRINK TUBE	0.200	M																
TB2603A	TB1520A0- VENTURI FAN 0,12M		KTB2603A	VENTURI-COOLING FAN CONNECT. KIT TB1520A	<table border="1"> <thead> <tr> <th>Code</th> <th>Description</th> <th>Qty</th> <th>UOM</th> </tr> </thead> <tbody> <tr> <td>TB1520A0</td> <td>INT. Ø=38 TH=4 DRAIN BLACK RUBBER PIPE</td> <td>0.120</td> <td>M</td> </tr> <tr> <td>VM1224A0</td> <td>65MY 220MM 2 COLOURS SHRINK TUBE</td> <td>0.200</td> <td>M</td> </tr> </tbody> </table>	Code	Description	Qty	UOM	TB1520A0	INT. Ø=38 TH=4 DRAIN BLACK RUBBER PIPE	0.120	M	VM1224A0	65MY 220MM 2 COLOURS SHRINK TUBE	0.200	M		
					Code	Description	Qty	UOM											
TB1520A0	INT. Ø=38 TH=4 DRAIN BLACK RUBBER PIPE	0.120	M																
VM1224A0	65MY 220MM 2 COLOURS SHRINK TUBE	0.200	M																
<table border="1"> <thead> <tr> <th>Code</th> <th>Description</th> <th>Qty</th> <th>UOM</th> </tr> </thead> <tbody> <tr> <td>IL1206C0</td> <td>968X1053 H126 XBC WOOD PALLE</td> <td>1</td> <td>PZ</td> </tr> <tr> <td>IL1206D0</td> <td></td> <td>1</td> <td>PZ</td> </tr> <tr> <td>TB1520A0</td> <td>INT. Ø=38 TH=4 DRAIN BLACK RUBBER PIPE</td> <td>60</td> <td>M</td> </tr> </tbody> </table>	Code	Description	Qty	UOM	IL1206C0	968X1053 H126 XBC WOOD PALLE	1	PZ	IL1206D0		1	PZ	TB1520A0	INT. Ø=38 TH=4 DRAIN BLACK RUBBER PIPE	60	M			
Code	Description	Qty	UOM																
IL1206C0	968X1053 H126 XBC WOOD PALLE	1	PZ																
IL1206D0		1	PZ																
TB1520A0	INT. Ø=38 TH=4 DRAIN BLACK RUBBER PIPE	60	M																
TB1956A	TB1520A-GREY SILICONE PIPE L=0,04M		KTB1002A	BLACK TUBE KIT EPDM 60MT TB1520	<table border="1"> <thead> <tr> <th>Code</th> <th>Description</th> <th>Qty</th> <th>UOM</th> </tr> </thead> <tbody> <tr> <td>TB1520A0</td> <td>INT. Ø=38 TH=4 DRAIN BLACK RUBBER PIPE</td> <td>10</td> <td>M</td> </tr> <tr> <td>VM1794A0</td> <td>250X4.8 PA66 BLACK CLAMP</td> <td>3</td> <td>PZ</td> </tr> </tbody> </table>	Code	Description	Qty	UOM	TB1520A0	INT. Ø=38 TH=4 DRAIN BLACK RUBBER PIPE	10	M	VM1794A0	250X4.8 PA66 BLACK CLAMP	3	PZ		
					Code	Description	Qty	UOM											
			TB1520A0	INT. Ø=38 TH=4 DRAIN BLACK RUBBER PIPE	10	M													
			VM1794A0	250X4.8 PA66 BLACK CLAMP	3	PZ													
			<table border="1"> <thead> <tr> <th>Code</th> <th>Description</th> <th>Qty</th> <th>UOM</th> </tr> </thead> <tbody> <tr> <td>RC1055A0</td> <td>Ø25-40 H12 STAINLESS STEEL PIPE CLIP</td> <td>2</td> <td>PZ</td> </tr> <tr> <td>TB1520A0</td> <td>INT. Ø=38 TH=4 DRAIN BLACK RUBBER PIPE</td> <td>2</td> <td>M</td> </tr> <tr> <td>VM1059A1</td> <td>HEAT SHRINK FILM H800</td> <td>1.500</td> <td>M</td> </tr> </tbody> </table>	Code	Description	Qty	UOM	RC1055A0	Ø25-40 H12 STAINLESS STEEL PIPE CLIP	2	PZ	TB1520A0	INT. Ø=38 TH=4 DRAIN BLACK RUBBER PIPE	2	M	VM1059A1	HEAT SHRINK FILM H800	1.500	M
			Code	Description	Qty	UOM													
RC1055A0	Ø25-40 H12 STAINLESS STEEL PIPE CLIP	2	PZ																
TB1520A0	INT. Ø=38 TH=4 DRAIN BLACK RUBBER PIPE	2	M																
VM1059A1	HEAT SHRINK FILM H800	1.500	M																
KTB1001A	BLACK TUBE KIT EPDM 10MT TB1520	<table border="1"> <thead> <tr> <th>Code</th> <th>Description</th> <th>Qty</th> <th>UOM</th> </tr> </thead> <tbody> <tr> <td>TB1520A0</td> <td>INT. Ø=38 TH=4 DRAIN BLACK RUBBER PIPE</td> <td>10</td> <td>M</td> </tr> <tr> <td>VM1794A0</td> <td>250X4.8 PA66 BLACK CLAMP</td> <td>3</td> <td>PZ</td> </tr> </tbody> </table>	Code	Description	Qty	UOM	TB1520A0	INT. Ø=38 TH=4 DRAIN BLACK RUBBER PIPE	10	M	VM1794A0	250X4.8 PA66 BLACK CLAMP	3	PZ					
		Code	Description	Qty	UOM														
TB1520A0	INT. Ø=38 TH=4 DRAIN BLACK RUBBER PIPE	10	M																
VM1794A0	250X4.8 PA66 BLACK CLAMP	3	PZ																
<table border="1"> <thead> <tr> <th>Code</th> <th>Description</th> <th>Qty</th> <th>UOM</th> </tr> </thead> <tbody> <tr> <td>RC1055A0</td> <td>Ø25-40 H12 STAINLESS STEEL PIPE CLIP</td> <td>2</td> <td>PZ</td> </tr> <tr> <td>TB1520A0</td> <td>INT. Ø=38 TH=4 DRAIN BLACK RUBBER PIPE</td> <td>2</td> <td>M</td> </tr> <tr> <td>VM1059A1</td> <td>HEAT SHRINK FILM H800</td> <td>1.500</td> <td>M</td> </tr> </tbody> </table>	Code	Description	Qty	UOM	RC1055A0	Ø25-40 H12 STAINLESS STEEL PIPE CLIP	2	PZ	TB1520A0	INT. Ø=38 TH=4 DRAIN BLACK RUBBER PIPE	2	M	VM1059A1	HEAT SHRINK FILM H800	1.500	M			
Code	Description	Qty	UOM																
RC1055A0	Ø25-40 H12 STAINLESS STEEL PIPE CLIP	2	PZ																
TB1520A0	INT. Ø=38 TH=4 DRAIN BLACK RUBBER PIPE	2	M																
VM1059A1	HEAT SHRINK FILM H800	1.500	M																
KTB1000A	EPDM BLACK TUBE TB1520A 2MT KIT	<table border="1"> <thead> <tr> <th>Code</th> <th>Description</th> <th>Qty</th> <th>UOM</th> </tr> </thead> <tbody> <tr> <td>RC1055A0</td> <td>Ø25-40 H12 STAINLESS STEEL PIPE CLIP</td> <td>2</td> <td>PZ</td> </tr> <tr> <td>TB1520A0</td> <td>INT. Ø=38 TH=4 DRAIN BLACK RUBBER PIPE</td> <td>2</td> <td>M</td> </tr> <tr> <td>VM1059A1</td> <td>HEAT SHRINK FILM H800</td> <td>1.500</td> <td>M</td> </tr> </tbody> </table>	Code	Description	Qty	UOM	RC1055A0	Ø25-40 H12 STAINLESS STEEL PIPE CLIP	2	PZ	TB1520A0	INT. Ø=38 TH=4 DRAIN BLACK RUBBER PIPE	2	M	VM1059A1	HEAT SHRINK FILM H800	1.500	M	
		Code	Description	Qty	UOM														
RC1055A0	Ø25-40 H12 STAINLESS STEEL PIPE CLIP	2	PZ																
TB1520A0	INT. Ø=38 TH=4 DRAIN BLACK RUBBER PIPE	2	M																
VM1059A1	HEAT SHRINK FILM H800	1.500	M																
<table border="1"> <thead> <tr> <th>Code</th> <th>Description</th> <th>Qty</th> <th>UOM</th> </tr> </thead> <tbody> <tr> <td>RC1055A0</td> <td>Ø25-40 H12 STAINLESS STEEL PIPE CLIP</td> <td>2</td> <td>PZ</td> </tr> <tr> <td>TB1520A0</td> <td>INT. Ø=38 TH=4 DRAIN BLACK RUBBER PIPE</td> <td>2</td> <td>M</td> </tr> <tr> <td>VM1059A1</td> <td>HEAT SHRINK FILM H800</td> <td>1.500</td> <td>M</td> </tr> </tbody> </table>	Code	Description	Qty	UOM	RC1055A0	Ø25-40 H12 STAINLESS STEEL PIPE CLIP	2	PZ	TB1520A0	INT. Ø=38 TH=4 DRAIN BLACK RUBBER PIPE	2	M	VM1059A1	HEAT SHRINK FILM H800	1.500	M			
Code	Description	Qty	UOM																
RC1055A0	Ø25-40 H12 STAINLESS STEEL PIPE CLIP	2	PZ																
TB1520A0	INT. Ø=38 TH=4 DRAIN BLACK RUBBER PIPE	2	M																
VM1059A1	HEAT SHRINK FILM H800	1.500	M																







COMPONENT			SPARE PART																								
Code	Description	Image	Code	Description	Components list																						
RC1042A	DOUBLE WIRE SPRING CLAMP D21.5-22.6		KTB3074B	XEVC-0711-G VENTURI COLLECTOR PIPE KI	<table border="1"> <thead> <tr> <th>Code</th> <th>Description</th> <th>Qty</th> <th>UOM</th> </tr> </thead> <tbody> <tr> <td>GN1544A0</td> <td>AIR INLET GASKET</td> <td>1</td> <td>PZ</td> </tr> <tr> <td>GN1584A0</td> <td>CORNER FITTING D30-D16</td> <td>1</td> <td>PZ</td> </tr> <tr> <td>RC1042A0</td> <td>DOUBLE WIRE SPRING CLAMP D21.5-22.6</td> <td>1</td> <td>PZ</td> </tr> </tbody> </table>	Code	Description	Qty	UOM	GN1544A0	AIR INLET GASKET	1	PZ	GN1584A0	CORNER FITTING D30-D16	1	PZ	RC1042A0	DOUBLE WIRE SPRING CLAMP D21.5-22.6	1	PZ						
					Code	Description	Qty	UOM																			
					GN1544A0	AIR INLET GASKET	1	PZ																			
					GN1584A0	CORNER FITTING D30-D16	1	PZ																			
			RC1042A0	DOUBLE WIRE SPRING CLAMP D21.5-22.6	1	PZ																					
			<table border="1"> <tbody> <tr> <td>TB3074B0</td> <td>XEVC-07EU-G VENTURI COLLECTOR PIPE D30</td> <td>1</td> <td>PZ</td> </tr> <tr> <td>VM1794A0</td> <td>250X4.8 PA66 BLACK CLAMP</td> <td>1</td> <td>PZ</td> </tr> </tbody> </table>	TB3074B0	XEVC-07EU-G VENTURI COLLECTOR PIPE D30	1	PZ	VM1794A0	250X4.8 PA66 BLACK CLAMP	1	PZ																
			TB3074B0	XEVC-07EU-G VENTURI COLLECTOR PIPE D30	1	PZ																					
			VM1794A0	250X4.8 PA66 BLACK CLAMP	1	PZ																					
			<table border="1"> <thead> <tr> <th>Code</th> <th>Description</th> <th>Qty</th> <th>UOM</th> </tr> </thead> <tbody> <tr> <td>GN1544A0</td> <td>AIR INLET GASKET</td> <td>2</td> <td>PZ</td> </tr> <tr> <td>GN1584A0</td> <td>CORNER FITTING D30-D16</td> <td>1</td> <td>PZ</td> </tr> <tr> <td>RC1042A0</td> <td>DOUBLE WIRE SPRING CLAMP D21.5-22.6</td> <td>1</td> <td>PZ</td> </tr> <tr> <td>TB3068B0</td> <td>XEBC-10 VENTURI AIR COLLECTOR PIPE D30</td> <td>1</td> <td>PZ</td> </tr> <tr> <td>VM1794A0</td> <td>250X4.8 PA66 BLACK CLAMP</td> <td>1</td> <td>PZ</td> </tr> </tbody> </table>	Code	Description	Qty	UOM	GN1544A0	AIR INLET GASKET	2	PZ	GN1584A0	CORNER FITTING D30-D16	1	PZ	RC1042A0	DOUBLE WIRE SPRING CLAMP D21.5-22.6	1	PZ	TB3068B0	XEBC-10 VENTURI AIR COLLECTOR PIPE D30	1	PZ	VM1794A0	250X4.8 PA66 BLACK CLAMP	1	PZ
			Code	Description	Qty	UOM																					
			GN1544A0	AIR INLET GASKET	2	PZ																					
			GN1584A0	CORNER FITTING D30-D16	1	PZ																					
RC1042A0	DOUBLE WIRE SPRING CLAMP D21.5-22.6	1	PZ																								
TB3068B0	XEBC-10 VENTURI AIR COLLECTOR PIPE D30	1	PZ																								
VM1794A0	250X4.8 PA66 BLACK CLAMP	1	PZ																								
<table border="1"> <thead> <tr> <th>Code</th> <th>Description</th> <th>Qty</th> <th>UOM</th> </tr> </thead> <tbody> <tr> <td>GN1544A0</td> <td>AIR INLET GASKET</td> <td>1</td> <td>PZ</td> </tr> <tr> <td>GN1584A0</td> <td>CORNER FITTING D30-D16</td> <td>1</td> <td>PZ</td> </tr> <tr> <td>RC1042A0</td> <td>DOUBLE WIRE SPRING CLAMP D21.5-22.6</td> <td>1</td> <td>PZ</td> </tr> <tr> <td>TB3019A1</td> <td>XEVC-2011 UPPER AIR INLET PIPE D3</td> <td>1</td> <td>PZ</td> </tr> <tr> <td>VM1794A0</td> <td>250X4.8 PA66 BLACK CLAMP</td> <td>1</td> <td>PZ</td> </tr> </tbody> </table>	Code	Description	Qty	UOM	GN1544A0	AIR INLET GASKET	1	PZ	GN1584A0	CORNER FITTING D30-D16	1	PZ	RC1042A0	DOUBLE WIRE SPRING CLAMP D21.5-22.6	1	PZ	TB3019A1	XEVC-2011 UPPER AIR INLET PIPE D3	1	PZ	VM1794A0	250X4.8 PA66 BLACK CLAMP	1	PZ			
Code	Description	Qty	UOM																								
GN1544A0	AIR INLET GASKET	1	PZ																								
GN1584A0	CORNER FITTING D30-D16	1	PZ																								
RC1042A0	DOUBLE WIRE SPRING CLAMP D21.5-22.6	1	PZ																								
TB3019A1	XEVC-2011 UPPER AIR INLET PIPE D3	1	PZ																								
VM1794A0	250X4.8 PA66 BLACK CLAMP	1	PZ																								
<table border="1"> <thead> <tr> <th>Code</th> <th>Description</th> <th>Qty</th> <th>UOM</th> </tr> </thead> <tbody> <tr> <td>GN1544A0</td> <td>AIR INLET GASKET</td> <td>2</td> <td>PZ</td> </tr> </tbody> </table>	Code	Description	Qty	UOM	GN1544A0	AIR INLET GASKET	2	PZ																			
Code	Description	Qty	UOM																								
GN1544A0	AIR INLET GASKET	2	PZ																								
KTB3068B	10FS/EU/2-G VENTURI COLLECTOR PIPE KI																										
KTB3019A	20XX/16XX UPPER VENTURI COLLECT PIPE KIT																										
KTB2979C	XEBC-10XX-E VENTURI COLLECTOR PIPE KI																										





COMPONENT			SPARE PART										
Code	Description	Image	Code	Description	Components list								
RC1042A	DOUBLE WIRE SPRING CLAMP D21.5-22.6		KTB2979C	XEBC-10XX-E VENTURI COLLECTOR PIPE KI	<table border="1"> <thead> <tr> <th>Code</th> <th>Description</th> <th>Qty</th> <th>UOM</th> </tr> </thead> <tbody> <tr> <td>GN1584A0</td> <td>CORNER FITTING D30-D16</td> <td>1</td> <td>PZ</td> </tr> </tbody> </table>	Code	Description	Qty	UOM	GN1584A0	CORNER FITTING D30-D16	1	PZ
					Code	Description	Qty	UOM					
					GN1584A0	CORNER FITTING D30-D16	1	PZ					
					<table border="1"> <thead> <tr> <th>Code</th> <th>Description</th> <th>Qty</th> <th>UOM</th> </tr> </thead> <tbody> <tr> <td>RC1042A0</td> <td>DOUBLE WIRE SPRING CLAMP D21.5-22.6</td> <td>1</td> <td>PZ</td> </tr> </tbody> </table>	Code	Description	Qty	UOM	RC1042A0	DOUBLE WIRE SPRING CLAMP D21.5-22.6	1	PZ
			Code	Description	Qty	UOM							
			RC1042A0	DOUBLE WIRE SPRING CLAMP D21.5-22.6	1	PZ							
			<table border="1"> <thead> <tr> <th>Code</th> <th>Description</th> <th>Qty</th> <th>UOM</th> </tr> </thead> <tbody> <tr> <td>TB2979C0</td> <td>XEBC-10 VENTURI AIR COLLECTOR PIPE D30</td> <td>1</td> <td>PZ</td> </tr> </tbody> </table>	Code	Description	Qty	UOM	TB2979C0	XEBC-10 VENTURI AIR COLLECTOR PIPE D30	1	PZ		
			Code	Description	Qty	UOM							
			TB2979C0	XEBC-10 VENTURI AIR COLLECTOR PIPE D30	1	PZ							
			<table border="1"> <thead> <tr> <th>Code</th> <th>Description</th> <th>Qty</th> <th>UOM</th> </tr> </thead> <tbody> <tr> <td>VM1794A0</td> <td>250X4.8 PA66 BLACK CLAMP</td> <td>1</td> <td>PZ</td> </tr> </tbody> </table>	Code	Description	Qty	UOM	VM1794A0	250X4.8 PA66 BLACK CLAMP	1	PZ		
			Code	Description	Qty	UOM							
			VM1794A0	250X4.8 PA66 BLACK CLAMP	1	PZ							
KTB2978B	XEBC-06 VENTURI COLLECTOR PIPE KI	<table border="1"> <thead> <tr> <th>Code</th> <th>Description</th> <th>Qty</th> <th>UOM</th> </tr> </thead> <tbody> <tr> <td>GN1544A0</td> <td>AIR INLET GASKET</td> <td>1</td> <td>PZ</td> </tr> </tbody> </table>	Code	Description	Qty	UOM	GN1544A0	AIR INLET GASKET	1	PZ			
		Code	Description	Qty	UOM								
		GN1544A0	AIR INLET GASKET	1	PZ								
		<table border="1"> <thead> <tr> <th>Code</th> <th>Description</th> <th>Qty</th> <th>UOM</th> </tr> </thead> <tbody> <tr> <td>GN1584A0</td> <td>CORNER FITTING D30-D16</td> <td>1</td> <td>PZ</td> </tr> </tbody> </table>	Code	Description	Qty	UOM	GN1584A0	CORNER FITTING D30-D16	1	PZ			
Code	Description	Qty	UOM										
GN1584A0	CORNER FITTING D30-D16	1	PZ										
<table border="1"> <thead> <tr> <th>Code</th> <th>Description</th> <th>Qty</th> <th>UOM</th> </tr> </thead> <tbody> <tr> <td>RC1042A0</td> <td>DOUBLE WIRE SPRING CLAMP D21.5-22.6</td> <td>1</td> <td>PZ</td> </tr> </tbody> </table>	Code	Description	Qty	UOM	RC1042A0	DOUBLE WIRE SPRING CLAMP D21.5-22.6	1	PZ					
Code	Description	Qty	UOM										
RC1042A0	DOUBLE WIRE SPRING CLAMP D21.5-22.6	1	PZ										
<table border="1"> <thead> <tr> <th>Code</th> <th>Description</th> <th>Qty</th> <th>UOM</th> </tr> </thead> <tbody> <tr> <td>TB2978B0</td> <td>XEBC-06 VENTURI AIR COLLECTOR PIPE D30</td> <td>1</td> <td>PZ</td> </tr> </tbody> </table>	Code	Description	Qty	UOM	TB2978B0	XEBC-06 VENTURI AIR COLLECTOR PIPE D30	1	PZ					
Code	Description	Qty	UOM										
TB2978B0	XEBC-06 VENTURI AIR COLLECTOR PIPE D30	1	PZ										
KTB2959B	XEVC-1011-E VENTURI COLLECTOR PIPE KI	<table border="1"> <thead> <tr> <th>Code</th> <th>Description</th> <th>Qty</th> <th>UOM</th> </tr> </thead> <tbody> <tr> <td>GN1544A0</td> <td>AIR INLET GASKET</td> <td>2</td> <td>PZ</td> </tr> </tbody> </table>	Code	Description	Qty	UOM	GN1544A0	AIR INLET GASKET	2	PZ			
		Code	Description	Qty	UOM								
		GN1544A0	AIR INLET GASKET	2	PZ								
		<table border="1"> <thead> <tr> <th>Code</th> <th>Description</th> <th>Qty</th> <th>UOM</th> </tr> </thead> <tbody> <tr> <td>GN1584A0</td> <td>CORNER FITTING D30-D16</td> <td>1</td> <td>PZ</td> </tr> </tbody> </table>	Code	Description	Qty	UOM	GN1584A0	CORNER FITTING D30-D16	1	PZ			
Code	Description	Qty	UOM										
GN1584A0	CORNER FITTING D30-D16	1	PZ										
<table border="1"> <thead> <tr> <th>Code</th> <th>Description</th> <th>Qty</th> <th>UOM</th> </tr> </thead> <tbody> <tr> <td>RC1042A0</td> <td>DOUBLE WIRE SPRING CLAMP D21.5-22.6</td> <td>1</td> <td>PZ</td> </tr> </tbody> </table>	Code	Description	Qty	UOM	RC1042A0	DOUBLE WIRE SPRING CLAMP D21.5-22.6	1	PZ					
Code	Description	Qty	UOM										
RC1042A0	DOUBLE WIRE SPRING CLAMP D21.5-22.6	1	PZ										
<table border="1"> <thead> <tr> <th>Code</th> <th>Description</th> <th>Qty</th> <th>UOM</th> </tr> </thead> <tbody> <tr> <td>TB2959B0</td> <td>XEVC-1011-E VENTURI PIPE</td> <td>1</td> <td>PZ</td> </tr> </tbody> </table>	Code	Description	Qty	UOM	TB2959B0	XEVC-1011-E VENTURI PIPE	1	PZ					
Code	Description	Qty	UOM										
TB2959B0	XEVC-1011-E VENTURI PIPE	1	PZ										
KTB2958B	XEVC-0711-E VENTURI COLLECTOR PIPE KI	<table border="1"> <thead> <tr> <th>Code</th> <th>Description</th> <th>Qty</th> <th>UOM</th> </tr> </thead> <tbody> <tr> <td>VM1794A0</td> <td>250X4.8 PA66 BLACK CLAMP</td> <td>1</td> <td>PZ</td> </tr> </tbody> </table>	Code	Description	Qty	UOM	VM1794A0	250X4.8 PA66 BLACK CLAMP	1	PZ			
		Code	Description	Qty	UOM								
VM1794A0	250X4.8 PA66 BLACK CLAMP	1	PZ										
<table border="1"> <thead> <tr> <th>Code</th> <th>Description</th> <th>Qty</th> <th>UOM</th> </tr> </thead> <tbody> <tr> <td>GN1544A0</td> <td>AIR INLET GASKET</td> <td>1</td> <td>PZ</td> </tr> </tbody> </table>	Code	Description	Qty	UOM	GN1544A0	AIR INLET GASKET	1	PZ					
Code	Description	Qty	UOM										
GN1544A0	AIR INLET GASKET	1	PZ										
					<table border="1"> <thead> <tr> <th>Code</th> <th>Description</th> <th>Qty</th> <th>UOM</th> </tr> </thead> <tbody> <tr> <td>GN1584A0</td> <td>CORNER FITTING D30-D16</td> <td>1</td> <td>PZ</td> </tr> </tbody> </table>	Code	Description	Qty	UOM	GN1584A0	CORNER FITTING D30-D16	1	PZ
Code	Description	Qty	UOM										
GN1584A0	CORNER FITTING D30-D16	1	PZ										







COMPONENT			SPARE PART										
Code	Description	Image	Code	Description	Components list								
RC1042A	DOUBLE WIRE SPRING CLAMP D21.5-22.6		KTB2958B	XEVC-0711-E VENTURI COLLECTOR PIPE KI	<table border="1"> <thead> <tr> <th>Code</th> <th>Description</th> <th>Qty</th> <th>UOM</th> </tr> </thead> <tbody> <tr> <td>RC1042A0</td> <td>DOUBLE WIRE SPRING CLAMP D21.5-22.6</td> <td>1</td> <td>PZ</td> </tr> </tbody> </table>	Code	Description	Qty	UOM	RC1042A0	DOUBLE WIRE SPRING CLAMP D21.5-22.6	1	PZ
					Code	Description	Qty	UOM					
					RC1042A0	DOUBLE WIRE SPRING CLAMP D21.5-22.6	1	PZ					
			<table border="1"> <tbody> <tr> <td>TB2958B0</td> <td>XEVC-0711-E VENTURI PIPE</td> <td>1</td> <td>PZ</td> </tr> </tbody> </table>	TB2958B0	XEVC-0711-E VENTURI PIPE	1	PZ						
			TB2958B0	XEVC-0711-E VENTURI PIPE	1	PZ							
			<table border="1"> <tbody> <tr> <td>VM1794A0</td> <td>250X4.8 PA66 BLACK CLAMP</td> <td>1</td> <td>PZ</td> </tr> </tbody> </table>	VM1794A0	250X4.8 PA66 BLACK CLAMP	1	PZ						
			VM1794A0	250X4.8 PA66 BLACK CLAMP	1	PZ							
			KTB2957B	0511/04EU-E VENTURI COLLECTOR PIPE KI	<table border="1"> <thead> <tr> <th>Code</th> <th>Description</th> <th>Qty</th> <th>UOM</th> </tr> </thead> <tbody> <tr> <td>GN1544A0</td> <td>AIR INLET GASKET</td> <td>1</td> <td>PZ</td> </tr> </tbody> </table>	Code	Description	Qty	UOM	GN1544A0	AIR INLET GASKET	1	PZ
					Code	Description	Qty	UOM					
					GN1544A0	AIR INLET GASKET	1	PZ					
					<table border="1"> <tbody> <tr> <td>GN1584A0</td> <td>CORNER FITTING D30-D16</td> <td>1</td> <td>PZ</td> </tr> </tbody> </table>	GN1584A0	CORNER FITTING D30-D16	1	PZ				
					GN1584A0	CORNER FITTING D30-D16	1	PZ					
<table border="1"> <tbody> <tr> <td>RC1042A0</td> <td>DOUBLE WIRE SPRING CLAMP D21.5-22.6</td> <td>1</td> <td>PZ</td> </tr> </tbody> </table>	RC1042A0	DOUBLE WIRE SPRING CLAMP D21.5-22.6			1	PZ							
RC1042A0	DOUBLE WIRE SPRING CLAMP D21.5-22.6	1	PZ										
<table border="1"> <tbody> <tr> <td>TB2957B0</td> <td>XEVC-0511-E VENTURI PIPE</td> <td>1</td> <td>PZ</td> </tr> </tbody> </table>	TB2957B0	XEVC-0511-E VENTURI PIPE	1	PZ									
TB2957B0	XEVC-0511-E VENTURI PIPE	1	PZ										
<table border="1"> <tbody> <tr> <td>VM1794A0</td> <td>250X4.8 PA66 BLACK CLAMP</td> <td>1</td> <td>PZ</td> </tr> </tbody> </table>	VM1794A0	250X4.8 PA66 BLACK CLAMP	1	PZ									
VM1794A0	250X4.8 PA66 BLACK CLAMP	1	PZ										
KTB2956A	XEVC-0311-E VENTURI COLLECTOR PIPE KI	<table border="1"> <thead> <tr> <th>Code</th> <th>Description</th> <th>Qty</th> <th>UOM</th> </tr> </thead> <tbody> <tr> <td>GN1544A0</td> <td>AIR INLET GASKET</td> <td>1</td> <td>PZ</td> </tr> </tbody> </table>	Code	Description	Qty	UOM	GN1544A0	AIR INLET GASKET	1	PZ			
		Code	Description	Qty	UOM								
		GN1544A0	AIR INLET GASKET	1	PZ								
<table border="1"> <tbody> <tr> <td>RC1042A0</td> <td>DOUBLE WIRE SPRING CLAMP D21.5-22.6</td> <td>1</td> <td>PZ</td> </tr> </tbody> </table>	RC1042A0	DOUBLE WIRE SPRING CLAMP D21.5-22.6	1	PZ									
RC1042A0	DOUBLE WIRE SPRING CLAMP D21.5-22.6	1	PZ										
<table border="1"> <tbody> <tr> <td>TB2956A0</td> <td>XEVC-0311-E VENTURI PIPE</td> <td>1</td> <td>PZ</td> </tr> </tbody> </table>	TB2956A0	XEVC-0311-E VENTURI PIPE	1	PZ									
TB2956A0	XEVC-0311-E VENTURI PIPE	1	PZ										
KTB2944A	20XX/16XX LOWER VENTURI COLLECT PIPE KIT	<table border="1"> <thead> <tr> <th>Code</th> <th>Description</th> <th>Qty</th> <th>UOM</th> </tr> </thead> <tbody> <tr> <td>GN1544A0</td> <td>AIR INLET GASKET</td> <td>2</td> <td>PZ</td> </tr> </tbody> </table>	Code	Description	Qty	UOM	GN1544A0	AIR INLET GASKET	2	PZ			
		Code	Description	Qty	UOM								
		GN1544A0	AIR INLET GASKET	2	PZ								
		<table border="1"> <tbody> <tr> <td>GN1584A0</td> <td>CORNER FITTING D30-D16</td> <td>1</td> <td>PZ</td> </tr> </tbody> </table>	GN1584A0	CORNER FITTING D30-D16	1	PZ							
		GN1584A0	CORNER FITTING D30-D16	1	PZ								
		<table border="1"> <tbody> <tr> <td>RC1042A0</td> <td>DOUBLE WIRE SPRING CLAMP D21.5-22.6</td> <td>1</td> <td>PZ</td> </tr> </tbody> </table>	RC1042A0	DOUBLE WIRE SPRING CLAMP D21.5-22.6	1	PZ							
RC1042A0	DOUBLE WIRE SPRING CLAMP D21.5-22.6	1	PZ										
<table border="1"> <tbody> <tr> <td>TB2944A1</td> <td>XEVC-2011 AIR INLET PIPE D3</td> <td>1</td> <td>PZ</td> </tr> </tbody> </table>	TB2944A1	XEVC-2011 AIR INLET PIPE D3	1	PZ									
TB2944A1	XEVC-2011 AIR INLET PIPE D3	1	PZ										
<table border="1"> <tbody> <tr> <td>VM1794A0</td> <td>250X4.8 PA66 BLACK CLAMP</td> <td>1</td> <td>PZ</td> </tr> </tbody> </table>	VM1794A0	250X4.8 PA66 BLACK CLAMP	1	PZ									
VM1794A0	250X4.8 PA66 BLACK CLAMP	1	PZ										
KTB1323A	XECC-05XX-E VENTURI COLLECTOR PIPE KI	<table border="1"> <thead> <tr> <th>Code</th> <th>Description</th> <th>Qty</th> <th>UOM</th> </tr> </thead> <tbody> <tr> <td>GN1544A0</td> <td>AIR INLET GASKET</td> <td>1</td> <td>PZ</td> </tr> </tbody> </table>	Code	Description	Qty	UOM	GN1544A0	AIR INLET GASKET	1	PZ			
		Code	Description	Qty	UOM								
GN1544A0	AIR INLET GASKET	1	PZ										

COMPONENT			SPARE PART																																																		
Code	Description	Image	Code	Description	Components list																																																
RC1042A	DOUBLE WIRE SPRING CLAMP D21.5-22.6		KTB1323A	XECC-05XX-E VENTURI COLLECTOR PIPE KI	<table border="1"> <thead> <tr> <th>Code</th> <th>Description</th> <th>Qty</th> <th>UOM</th> </tr> </thead> <tbody> <tr> <td>GN1584A0</td> <td>CORNER FITTING D30-D16</td> <td>1</td> <td>PZ</td> </tr> <tr> <td>RC1042A0</td> <td>DOUBLE WIRE SPRING CLAMP D21.5-22.6</td> <td>1</td> <td>PZ</td> </tr> <tr> <td>TB1323A1</td> <td>XECC-05XX VENTURI AIR EXIT PIPE</td> <td>1</td> <td>PZ</td> </tr> </tbody> </table>	Code	Description	Qty	UOM	GN1584A0	CORNER FITTING D30-D16	1	PZ	RC1042A0	DOUBLE WIRE SPRING CLAMP D21.5-22.6	1	PZ	TB1323A1	XECC-05XX VENTURI AIR EXIT PIPE	1	PZ																																
					Code	Description	Qty	UOM																																													
					GN1584A0	CORNER FITTING D30-D16	1	PZ																																													
RC1042A0	DOUBLE WIRE SPRING CLAMP D21.5-22.6	1	PZ																																																		
TB1323A1	XECC-05XX VENTURI AIR EXIT PIPE	1	PZ																																																		
TB2979C	XEBC-10 VENTURI AIR COLLECTOR PIPE D30		KTB2979C	XEBC-10XX-E VENTURI COLLECTOR PIPE KI	<table border="1"> <thead> <tr> <th>Code</th> <th>Description</th> <th>Qty</th> <th>UOM</th> </tr> </thead> <tbody> <tr> <td>GN1544A0</td> <td>AIR INLET GASKET</td> <td>2</td> <td>PZ</td> </tr> <tr> <td>GN1584A0</td> <td>CORNER FITTING D30-D16</td> <td>1</td> <td>PZ</td> </tr> <tr> <td>RC1042A0</td> <td>DOUBLE WIRE SPRING CLAMP D21.5-22.6</td> <td>1</td> <td>PZ</td> </tr> <tr> <td>TB2979C0</td> <td>XEBC-10 VENTURI AIR COLLECTOR PIPE D30</td> <td>1</td> <td>PZ</td> </tr> <tr> <td>VM1794A0</td> <td>250X4.8 PA66 BLACK CLAMP</td> <td>1</td> <td>PZ</td> </tr> </tbody> </table>	Code	Description	Qty	UOM	GN1544A0	AIR INLET GASKET	2	PZ	GN1584A0	CORNER FITTING D30-D16	1	PZ	RC1042A0	DOUBLE WIRE SPRING CLAMP D21.5-22.6	1	PZ	TB2979C0	XEBC-10 VENTURI AIR COLLECTOR PIPE D30	1	PZ	VM1794A0	250X4.8 PA66 BLACK CLAMP	1	PZ																								
					Code	Description	Qty	UOM																																													
					GN1544A0	AIR INLET GASKET	2	PZ																																													
					GN1584A0	CORNER FITTING D30-D16	1	PZ																																													
					RC1042A0	DOUBLE WIRE SPRING CLAMP D21.5-22.6	1	PZ																																													
TB2979C0	XEBC-10 VENTURI AIR COLLECTOR PIPE D30	1	PZ																																																		
VM1794A0	250X4.8 PA66 BLACK CLAMP	1	PZ																																																		
VM2377A	220 V 50/60 HZ VENTURI KIT		KVM2377A	MM 220 V VENTURI ACTUATOR SYSTEM KIT	<table border="1"> <thead> <tr> <th>Code</th> <th>Description</th> <th>Qty</th> <th>UOM</th> </tr> </thead> <tbody> <tr> <td>GN1556A0</td> <td>MM VENTURI SEAL</td> <td>1</td> <td>PZ</td> </tr> <tr> <td>MOV0016A0</td> <td>HOOD RING GASKET GN1110A2</td> <td>0.100</td> <td>PZ</td> </tr> <tr> <td>RC1378A0</td> <td>HOSE CLAMP</td> <td>3</td> <td>PZ</td> </tr> <tr> <td>TB1520A0</td> <td>INT. Ø=38 TH=4 DRAIN BLACK RUBBER PIPE</td> <td>0.170</td> <td>M</td> </tr> <tr> <td>VE1135A0</td> <td>220 V 50/60 HZ VENTURI ACTUATOR</td> <td>1</td> <td>PZ</td> </tr> <tr> <td>VI1032A0</td> <td>SCREW M4X16 TCB+ INOX</td> <td>1</td> <td>PZ</td> </tr> <tr> <td>VI1220A1</td> <td>4,2X12 TCB SELF-TAPPIN G SCREW</td> <td>6</td> <td>PZ</td> </tr> <tr> <td>VM2345A0</td> <td>MM VENTURI UPPER BODY</td> <td>1</td> <td>PZ</td> </tr> <tr> <td>VM2345A0</td> <td>MM VENTURI UPPER BODY</td> <td>1</td> <td>PZ</td> </tr> <tr> <td>VM2346A0</td> <td>MM VENTURI LOWER BODY</td> <td>1</td> <td>PZ</td> </tr> <tr> <td>VM2346A0</td> <td>MM VENTURI LOWER BODY</td> <td>1</td> <td>PZ</td> </tr> </tbody> </table>	Code	Description	Qty	UOM	GN1556A0	MM VENTURI SEAL	1	PZ	MOV0016A0	HOOD RING GASKET GN1110A2	0.100	PZ	RC1378A0	HOSE CLAMP	3	PZ	TB1520A0	INT. Ø=38 TH=4 DRAIN BLACK RUBBER PIPE	0.170	M	VE1135A0	220 V 50/60 HZ VENTURI ACTUATOR	1	PZ	VI1032A0	SCREW M4X16 TCB+ INOX	1	PZ	VI1220A1	4,2X12 TCB SELF-TAPPIN G SCREW	6	PZ	VM2345A0	MM VENTURI UPPER BODY	1	PZ	VM2345A0	MM VENTURI UPPER BODY	1	PZ	VM2346A0	MM VENTURI LOWER BODY	1	PZ	VM2346A0	MM VENTURI LOWER BODY	1	PZ
					Code	Description	Qty	UOM																																													
					GN1556A0	MM VENTURI SEAL	1	PZ																																													
					MOV0016A0	HOOD RING GASKET GN1110A2	0.100	PZ																																													
					RC1378A0	HOSE CLAMP	3	PZ																																													
					TB1520A0	INT. Ø=38 TH=4 DRAIN BLACK RUBBER PIPE	0.170	M																																													
					VE1135A0	220 V 50/60 HZ VENTURI ACTUATOR	1	PZ																																													
					VI1032A0	SCREW M4X16 TCB+ INOX	1	PZ																																													
					VI1220A1	4,2X12 TCB SELF-TAPPIN G SCREW	6	PZ																																													
					VM2345A0	MM VENTURI UPPER BODY	1	PZ																																													
					VM2345A0	MM VENTURI UPPER BODY	1	PZ																																													
					VM2346A0	MM VENTURI LOWER BODY	1	PZ																																													
					VM2346A0	MM VENTURI LOWER BODY	1	PZ																																													



COMPONENT			SPARE PART																																		
Code	Description	Image	Code	Description	Components list																																
VM2377A	220 V 50/60 HZ VENTURI KIT		KVM2377A	MM 220 V VENTURI ACTUATOR SYSTEM KIT	<table border="1"> <thead> <tr> <th>Code</th> <th>Description</th> <th>Qty</th> <th>UOM</th> </tr> </thead> <tbody> <tr> <td>VM2346A1</td> <td>S6 VENTURI LOWER HALF</td> <td>1</td> <td>PZ</td> </tr> <tr> <td>VM2347A0</td> <td>VENTURI MIND.MAPS COVER</td> <td>1</td> <td>PZ</td> </tr> <tr> <td>VM2347A0</td> <td>VENTURI MIND.MAPS COVER</td> <td>1</td> <td>PZ</td> </tr> <tr> <td>VM2348A0</td> <td>VENTURI PLATE SPACE</td> <td>1</td> <td>PZ</td> </tr> <tr> <td>VM2348A0</td> <td>VENTURI PLATE SPACE</td> <td>1</td> <td>PZ</td> </tr> <tr> <td>VM2349A0</td> <td>VENTURI LOWER BUSHING</td> <td>1</td> <td>PZ</td> </tr> <tr> <td>VM2349A0</td> <td>VENTURI LOWER BUSHING</td> <td>1</td> <td>PZ</td> </tr> </tbody> </table>	Code	Description	Qty	UOM	VM2346A1	S6 VENTURI LOWER HALF	1	PZ	VM2347A0	VENTURI MIND.MAPS COVER	1	PZ	VM2347A0	VENTURI MIND.MAPS COVER	1	PZ	VM2348A0	VENTURI PLATE SPACE	1	PZ	VM2348A0	VENTURI PLATE SPACE	1	PZ	VM2349A0	VENTURI LOWER BUSHING	1	PZ	VM2349A0	VENTURI LOWER BUSHING	1	PZ
					Code	Description	Qty	UOM																													
					VM2346A1	S6 VENTURI LOWER HALF	1	PZ																													
					VM2347A0	VENTURI MIND.MAPS COVER	1	PZ																													
					VM2347A0	VENTURI MIND.MAPS COVER	1	PZ																													
					VM2348A0	VENTURI PLATE SPACE	1	PZ																													
					VM2348A0	VENTURI PLATE SPACE	1	PZ																													
					VM2349A0	VENTURI LOWER BUSHING	1	PZ																													
					VM2349A0	VENTURI LOWER BUSHING	1	PZ																													
					GN1285A	NTC TEMPERATURE PROBE SEALING		KTR1106B	MIND.MAPS L2000 CHAMBER TEMP. PROBE KIT	<table border="1"> <thead> <tr> <th>Code</th> <th>Description</th> <th>Qty</th> <th>UOM</th> </tr> </thead> <tbody> <tr> <td>GN1285A0</td> <td>NTC TEMPERATUR E PROBE SEALING</td> <td>1</td> <td>PZ</td> </tr> <tr> <td>SL1045A0</td> <td>S57 BLACK SILICONE - 80ML CARTRIDGE</td> <td>1</td> <td>PZ</td> </tr> <tr> <td>TR1106B0</td> <td></td> <td>1</td> <td>PZ</td> </tr> <tr> <td>VI1220A1</td> <td>4,2X12 TCB SELF-TAPPIN G SCREW</td> <td>2</td> <td>PZ</td> </tr> <tr> <td>VM1464A1</td> <td>CT BT TEMPERATUR E PROBE COVER</td> <td>1</td> <td>PZ</td> </tr> <tr> <td>VM1465A0</td> <td>CHEFTOP TEMPERATUR E PROBE COVER</td> <td>1</td> <td>PZ</td> </tr> <tr> <td>VM1465A1</td> <td>CT BT TEMPERATUR E PROBE COVER</td> <td>1</td> <td>PZ</td> </tr> </tbody> </table>	Code	Description	Qty	UOM	GN1285A0	NTC TEMPERATUR E PROBE SEALING	1	PZ	SL1045A0	S57 BLACK SILICONE - 80ML CARTRIDGE	1	PZ	TR1106B0		1	PZ	VI1220A1	4,2X12 TCB SELF-TAPPIN G SCREW	2	PZ	VM1464A1	CT BT TEMPERATUR E PROBE COVER	1	PZ	VM1465A0	CHEFTOP TEMPERATUR E PROBE COVER	1
Code	Description	Qty	UOM																																		
GN1285A0	NTC TEMPERATUR E PROBE SEALING	1	PZ																																		
SL1045A0	S57 BLACK SILICONE - 80ML CARTRIDGE	1	PZ																																		
TR1106B0		1	PZ																																		
VI1220A1	4,2X12 TCB SELF-TAPPIN G SCREW	2	PZ																																		
VM1464A1	CT BT TEMPERATUR E PROBE COVER	1	PZ																																		
VM1465A0	CHEFTOP TEMPERATUR E PROBE COVER	1	PZ																																		
VM1465A1	CT BT TEMPERATUR E PROBE COVER	1	PZ																																		
KTR1106A	5-5E S. L2000 CHAMBER TEMP. PROBE KIT	<table border="1"> <thead> <tr> <th>Code</th> <th>Description</th> <th>Qty</th> <th>UOM</th> </tr> </thead> <tbody> <tr> <td>GN1285A0</td> <td>NTC TEMPERATUR E PROBE SEALING</td> <td>1</td> <td>PZ</td> </tr> <tr> <td>SL1045A0</td> <td>S57 BLACK SILICONE - 80ML CARTRIDGE</td> <td>1</td> <td>PZ</td> </tr> </tbody> </table>	Code	Description						Qty	UOM	GN1285A0	NTC TEMPERATUR E PROBE SEALING	1	PZ	SL1045A0	S57 BLACK SILICONE - 80ML CARTRIDGE	1	PZ																		
		Code	Description	Qty	UOM																																
GN1285A0	NTC TEMPERATUR E PROBE SEALING	1	PZ																																		
SL1045A0	S57 BLACK SILICONE - 80ML CARTRIDGE	1	PZ																																		



COMPONENT			SPARE PART																																											
Code	Description	Image	Code	Description	Components list																																									
GN1285A	NTC TEMPERATURE PROBE SEALING		KTR1106A	5-5E S. L2000 CHAMBER TEMP. PROBE KIT	<table border="1"> <thead> <tr> <th>Code</th> <th>Description</th> <th>Qty</th> <th>UOM</th> </tr> </thead> <tbody> <tr> <td>TR1106A3</td> <td>PT100 L=2000 TEMPERATUR E PROBE</td> <td>1</td> <td>PZ</td> </tr> <tr> <td>VI1220A1</td> <td>4,2X12 TCB SELF-TAPPIN G SCREW</td> <td>2</td> <td>PZ</td> </tr> <tr> <td>VM1465A0</td> <td>CHEFTOP TEMPERATUR E PROBE COVER</td> <td>1</td> <td>PZ</td> </tr> <tr> <td>VM1465A1</td> <td>CT BT TEMPERATUR E PROBE COVER</td> <td>1</td> <td>PZ</td> </tr> </tbody> </table>	Code	Description	Qty	UOM	TR1106A3	PT100 L=2000 TEMPERATUR E PROBE	1	PZ	VI1220A1	4,2X12 TCB SELF-TAPPIN G SCREW	2	PZ	VM1465A0	CHEFTOP TEMPERATUR E PROBE COVER	1	PZ	VM1465A1	CT BT TEMPERATUR E PROBE COVER	1	PZ																					
			Code	Description	Qty	UOM																																								
			TR1106A3	PT100 L=2000 TEMPERATUR E PROBE	1	PZ																																								
VI1220A1	4,2X12 TCB SELF-TAPPIN G SCREW	2	PZ																																											
VM1465A0	CHEFTOP TEMPERATUR E PROBE COVER	1	PZ																																											
VM1465A1	CT BT TEMPERATUR E PROBE COVER	1	PZ																																											
KTR1105A	PT100 L1000 TEMPERATURE PROBE KIT	<table border="1"> <thead> <tr> <th>Code</th> <th>Description</th> <th>Qty</th> <th>UOM</th> </tr> </thead> <tbody> <tr> <td>GN1120A0</td> <td>NTC TEMPERATUR E PROBE SEAL</td> <td>1</td> <td>PZ</td> </tr> <tr> <td>GN1120A1</td> <td>NTC TEMPERATUR E PROBE SEAL</td> <td>1</td> <td>PZ</td> </tr> <tr> <td>GN1285A0</td> <td>NTC TEMPERATUR E PROBE SEALING</td> <td>1</td> <td>PZ</td> </tr> <tr> <td>MOV0010A0</td> <td>HOOD RING GASKET GN1110A2</td> <td>0.100</td> <td>PZ</td> </tr> <tr> <td>SL1045A0</td> <td>S57 BLACK SILICONE - 80ML CARTRIDGE</td> <td>1</td> <td>PZ</td> </tr> <tr> <td>TR1105A4</td> <td>L1000 PT100 TEMPERATUR E PROBE</td> <td>1</td> <td>PZ</td> </tr> <tr> <td>VI1220A1</td> <td>4,2X12 TCB SELF-TAPPIN G SCREW</td> <td>2</td> <td>PZ</td> </tr> <tr> <td>VM1464A1</td> <td>CT BT TEMPERATUR E PROBE COVER</td> <td>1</td> <td>PZ</td> </tr> <tr> <td>VM1465A1</td> <td>CT BT TEMPERATUR E PROBE COVER</td> <td>1</td> <td>PZ</td> </tr> <tr> <td>VM2052A0</td> <td>LM CORE PROBE COVE</td> <td>1</td> <td>PZ</td> </tr> </tbody> </table>	Code	Description	Qty	UOM	GN1120A0	NTC TEMPERATUR E PROBE SEAL	1	PZ	GN1120A1	NTC TEMPERATUR E PROBE SEAL	1	PZ	GN1285A0	NTC TEMPERATUR E PROBE SEALING	1	PZ	MOV0010A0	HOOD RING GASKET GN1110A2	0.100	PZ	SL1045A0	S57 BLACK SILICONE - 80ML CARTRIDGE	1	PZ	TR1105A4	L1000 PT100 TEMPERATUR E PROBE	1	PZ	VI1220A1	4,2X12 TCB SELF-TAPPIN G SCREW	2	PZ	VM1464A1	CT BT TEMPERATUR E PROBE COVER	1	PZ	VM1465A1	CT BT TEMPERATUR E PROBE COVER	1	PZ	VM2052A0	LM CORE PROBE COVE	1	PZ
Code	Description	Qty	UOM																																											
GN1120A0	NTC TEMPERATUR E PROBE SEAL	1	PZ																																											
GN1120A1	NTC TEMPERATUR E PROBE SEAL	1	PZ																																											
GN1285A0	NTC TEMPERATUR E PROBE SEALING	1	PZ																																											
MOV0010A0	HOOD RING GASKET GN1110A2	0.100	PZ																																											
SL1045A0	S57 BLACK SILICONE - 80ML CARTRIDGE	1	PZ																																											
TR1105A4	L1000 PT100 TEMPERATUR E PROBE	1	PZ																																											
VI1220A1	4,2X12 TCB SELF-TAPPIN G SCREW	2	PZ																																											
VM1464A1	CT BT TEMPERATUR E PROBE COVER	1	PZ																																											
VM1465A1	CT BT TEMPERATUR E PROBE COVER	1	PZ																																											
VM2052A0	LM CORE PROBE COVE	1	PZ																																											
KTR1096A	NTC 150 L=1500 TEMPERATURE PROBE KIT	<table border="1"> <thead> <tr> <th>Code</th> <th>Description</th> <th>Qty</th> <th>UOM</th> </tr> </thead> <tbody> <tr> <td>GN1120A0</td> <td>NTC TEMPERATUR E PROBE SEAL</td> <td>1</td> <td>PZ</td> </tr> </tbody> </table>	Code	Description	Qty	UOM	GN1120A0	NTC TEMPERATUR E PROBE SEAL	1	PZ																																				
Code	Description	Qty	UOM																																											
GN1120A0	NTC TEMPERATUR E PROBE SEAL	1	PZ																																											

COMPONENT			SPARE PART																																			
Code	Description	Image	Code	Description	Components list																																	
GN1285A	NTC TEMPERATURE PROBE SEALING		KTR1096A	NTC 150 L=1500 TEMPERATURE PROBE KIT	<table border="1"> <thead> <tr> <th>Code</th> <th>Description</th> <th>Qty</th> <th>UOM</th> </tr> </thead> <tbody> <tr> <td>GN1120A1</td> <td>NTC TEMPERATUR E PROBE SEAL</td> <td>1</td> <td>PZ</td> </tr> <tr> <td>GN1285A0</td> <td>NTC TEMPERATUR E PROBE SEALING</td> <td>2</td> <td>PZ</td> </tr> <tr> <td>SL1045A0</td> <td>S57 BLACK SILICONE - 80ML CARTRIDGE</td> <td>1</td> <td>PZ</td> </tr> <tr> <td>TR1096A0</td> <td>TEMPERATUR E PROBE NTC 150 L=1500</td> <td>1</td> <td>PZ</td> </tr> <tr> <td>VI1220A1</td> <td>4,2X12 TCB SELF-TAPPIN G SCREW</td> <td>2</td> <td>PZ</td> </tr> <tr> <td>VM1465A0</td> <td>CHEFTOP TEMPERATUR E PROBE COVER</td> <td>1</td> <td>PZ</td> </tr> <tr> <td>VM1465A1</td> <td>CT BT TEMPERATUR E PROBE COVER</td> <td>1</td> <td>PZ</td> </tr> </tbody> </table>	Code	Description	Qty	UOM	GN1120A1	NTC TEMPERATUR E PROBE SEAL	1	PZ	GN1285A0	NTC TEMPERATUR E PROBE SEALING	2	PZ	SL1045A0	S57 BLACK SILICONE - 80ML CARTRIDGE	1	PZ	TR1096A0	TEMPERATUR E PROBE NTC 150 L=1500	1	PZ	VI1220A1	4,2X12 TCB SELF-TAPPIN G SCREW	2	PZ	VM1465A0	CHEFTOP TEMPERATUR E PROBE COVER	1	PZ	VM1465A1	CT BT TEMPERATUR E PROBE COVER	1	PZ	
			Code	Description	Qty	UOM																																
GN1120A1	NTC TEMPERATUR E PROBE SEAL	1	PZ																																			
GN1285A0	NTC TEMPERATUR E PROBE SEALING	2	PZ																																			
SL1045A0	S57 BLACK SILICONE - 80ML CARTRIDGE	1	PZ																																			
TR1096A0	TEMPERATUR E PROBE NTC 150 L=1500	1	PZ																																			
VI1220A1	4,2X12 TCB SELF-TAPPIN G SCREW	2	PZ																																			
VM1465A0	CHEFTOP TEMPERATUR E PROBE COVER	1	PZ																																			
VM1465A1	CT BT TEMPERATUR E PROBE COVER	1	PZ																																			
KTR1095A	NTC 150 L=1050 TEMPERATURE PROBE KIT	<table border="1"> <thead> <tr> <th>Code</th> <th>Description</th> <th>Qty</th> <th>UOM</th> </tr> </thead> <tbody> <tr> <td>GN1120A0</td> <td>NTC TEMPERATUR E PROBE SEAL</td> <td>1</td> <td>PZ</td> </tr> <tr> <td>GN1120A1</td> <td>NTC TEMPERATUR E PROBE SEAL</td> <td>1</td> <td>PZ</td> </tr> <tr> <td>GN1285A0</td> <td>NTC TEMPERATUR E PROBE SEALING</td> <td>1</td> <td>PZ</td> </tr> <tr> <td>SL1045A0</td> <td>S57 BLACK SILICONE - 80ML CARTRIDGE</td> <td>1</td> <td>PZ</td> </tr> <tr> <td>TR1095A0</td> <td>TEMPERATUR E PROBE NTC 150 L=1050</td> <td>1</td> <td>PZ</td> </tr> <tr> <td>VI1220A1</td> <td>4,2X12 TCB SELF-TAPPIN G SCREW</td> <td>2</td> <td>PZ</td> </tr> <tr> <td>VM1465A0</td> <td>CHEFTOP TEMPERATUR E PROBE COVER</td> <td>1</td> <td>PZ</td> </tr> <tr> <td>VM1465A1</td> <td>CT BT TEMPERATUR E PROBE COVER</td> <td>1</td> <td>PZ</td> </tr> </tbody> </table>	Code	Description	Qty	UOM	GN1120A0	NTC TEMPERATUR E PROBE SEAL	1	PZ	GN1120A1	NTC TEMPERATUR E PROBE SEAL	1	PZ	GN1285A0	NTC TEMPERATUR E PROBE SEALING	1	PZ	SL1045A0	S57 BLACK SILICONE - 80ML CARTRIDGE	1	PZ	TR1095A0	TEMPERATUR E PROBE NTC 150 L=1050	1	PZ	VI1220A1	4,2X12 TCB SELF-TAPPIN G SCREW	2	PZ	VM1465A0	CHEFTOP TEMPERATUR E PROBE COVER	1	PZ	VM1465A1	CT BT TEMPERATUR E PROBE COVER	1	PZ
Code	Description	Qty	UOM																																			
GN1120A0	NTC TEMPERATUR E PROBE SEAL	1	PZ																																			
GN1120A1	NTC TEMPERATUR E PROBE SEAL	1	PZ																																			
GN1285A0	NTC TEMPERATUR E PROBE SEALING	1	PZ																																			
SL1045A0	S57 BLACK SILICONE - 80ML CARTRIDGE	1	PZ																																			
TR1095A0	TEMPERATUR E PROBE NTC 150 L=1050	1	PZ																																			
VI1220A1	4,2X12 TCB SELF-TAPPIN G SCREW	2	PZ																																			
VM1465A0	CHEFTOP TEMPERATUR E PROBE COVER	1	PZ																																			
VM1465A1	CT BT TEMPERATUR E PROBE COVER	1	PZ																																			



COMPONENT			SPARE PART																																		
Code	Description	Image	Code	Description	Components list																																
GN1285A	NTC TEMPERATURE PROBE SEALING		KTR1002A	PT100 L1000 UL TEMPERATURE PROBE KIT	<table border="1"> <thead> <tr> <th>Code</th> <th>Description</th> <th>Qty</th> <th>UOM</th> </tr> </thead> <tbody> <tr> <td>GN1285A0</td> <td>NTC TEMPERATUR E PROBE SEALING</td> <td>2</td> <td>PZ</td> </tr> <tr> <td>SL1045A0</td> <td>S57 BLACK SILICONE - 80ML CARTRIDGE</td> <td>1</td> <td>PZ</td> </tr> <tr> <td>TR1002A1</td> <td></td> <td>1</td> <td>PZ</td> </tr> <tr> <td>VI1220A1</td> <td>4,2X12 TCB SELF-TAPPIN G SCREW</td> <td>2</td> <td>PZ</td> </tr> <tr> <td>VM1465A0</td> <td>CHEFTOP TEMPERATUR E PROBE COVER</td> <td>1</td> <td>PZ</td> </tr> <tr> <td>VM1465A1</td> <td>CT BT TEMPERATUR E PROBE COVER</td> <td>1</td> <td>PZ</td> </tr> </tbody> </table>	Code	Description	Qty	UOM	GN1285A0	NTC TEMPERATUR E PROBE SEALING	2	PZ	SL1045A0	S57 BLACK SILICONE - 80ML CARTRIDGE	1	PZ	TR1002A1		1	PZ	VI1220A1	4,2X12 TCB SELF-TAPPIN G SCREW	2	PZ	VM1465A0	CHEFTOP TEMPERATUR E PROBE COVER	1	PZ	VM1465A1	CT BT TEMPERATUR E PROBE COVER	1	PZ				
Code	Description	Qty	UOM																																		
GN1285A0	NTC TEMPERATUR E PROBE SEALING	2	PZ																																		
SL1045A0	S57 BLACK SILICONE - 80ML CARTRIDGE	1	PZ																																		
TR1002A1		1	PZ																																		
VI1220A1	4,2X12 TCB SELF-TAPPIN G SCREW	2	PZ																																		
VM1465A0	CHEFTOP TEMPERATUR E PROBE COVER	1	PZ																																		
VM1465A1	CT BT TEMPERATUR E PROBE COVER	1	PZ																																		
VM1464A	CT BT TEMPERATURE PROBE COVER		KVM1464A	CT BT TEMPERATURE PROBE COVER KIT	<table border="1"> <thead> <tr> <th>Code</th> <th>Description</th> <th>Qty</th> <th>UOM</th> </tr> </thead> <tbody> <tr> <td>VM1224A0</td> <td>65MY 220MM 2 COLOURS SHRINK TUBE</td> <td>0.150</td> <td>M</td> </tr> <tr> <td>VM1464A1</td> <td>CT BT TEMPERATUR E PROBE COVER</td> <td>1</td> <td>PZ</td> </tr> </tbody> </table>	Code	Description	Qty	UOM	VM1224A0	65MY 220MM 2 COLOURS SHRINK TUBE	0.150	M	VM1464A1	CT BT TEMPERATUR E PROBE COVER	1	PZ																				
Code	Description	Qty	UOM																																		
VM1224A0	65MY 220MM 2 COLOURS SHRINK TUBE	0.150	M																																		
VM1464A1	CT BT TEMPERATUR E PROBE COVER	1	PZ																																		
TR1106B			KTR1106B	MIND.MAPS L2000 CHAMBER TEMP. PROBE KIT	<table border="1"> <thead> <tr> <th>Code</th> <th>Description</th> <th>Qty</th> <th>UOM</th> </tr> </thead> <tbody> <tr> <td>GN1285A0</td> <td>NTC TEMPERATUR E PROBE SEALING</td> <td>1</td> <td>PZ</td> </tr> <tr> <td>SL1045A0</td> <td>S57 BLACK SILICONE - 80ML CARTRIDGE</td> <td>1</td> <td>PZ</td> </tr> <tr> <td>TR1106B0</td> <td></td> <td>1</td> <td>PZ</td> </tr> <tr> <td>VI1220A1</td> <td>4,2X12 TCB SELF-TAPPIN G SCREW</td> <td>2</td> <td>PZ</td> </tr> <tr> <td>VM1464A1</td> <td>CT BT TEMPERATUR E PROBE COVER</td> <td>1</td> <td>PZ</td> </tr> <tr> <td>VM1465A0</td> <td>CHEFTOP TEMPERATUR E PROBE COVER</td> <td>1</td> <td>PZ</td> </tr> <tr> <td>VM1465A1</td> <td>CT BT TEMPERATUR E PROBE COVER</td> <td>1</td> <td>PZ</td> </tr> </tbody> </table>	Code	Description	Qty	UOM	GN1285A0	NTC TEMPERATUR E PROBE SEALING	1	PZ	SL1045A0	S57 BLACK SILICONE - 80ML CARTRIDGE	1	PZ	TR1106B0		1	PZ	VI1220A1	4,2X12 TCB SELF-TAPPIN G SCREW	2	PZ	VM1464A1	CT BT TEMPERATUR E PROBE COVER	1	PZ	VM1465A0	CHEFTOP TEMPERATUR E PROBE COVER	1	PZ	VM1465A1	CT BT TEMPERATUR E PROBE COVER	1	PZ
Code	Description	Qty	UOM																																		
GN1285A0	NTC TEMPERATUR E PROBE SEALING	1	PZ																																		
SL1045A0	S57 BLACK SILICONE - 80ML CARTRIDGE	1	PZ																																		
TR1106B0		1	PZ																																		
VI1220A1	4,2X12 TCB SELF-TAPPIN G SCREW	2	PZ																																		
VM1464A1	CT BT TEMPERATUR E PROBE COVER	1	PZ																																		
VM1465A0	CHEFTOP TEMPERATUR E PROBE COVER	1	PZ																																		
VM1465A1	CT BT TEMPERATUR E PROBE COVER	1	PZ																																		





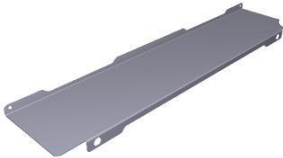
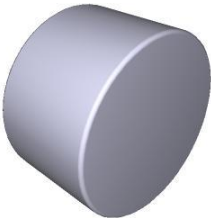

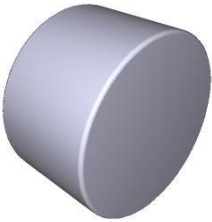
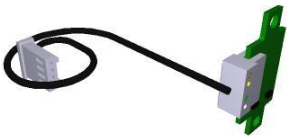

COMPONENT			SPARE PART																																						
Code	Description	Image	Code	Description	Components list																																				
0H7320A	6 S. VENTURI PIPE SUPPORT		0H7320A0	6 S. VENTURI PIPE SUPPORT																																					
SN1002B	L2050 MULTI.POINT CORE PROBE WITHOUT NUT		KSN1020B	US MULTIPOINT L2050 CORE PROBE KIT	<table border="1"> <thead> <tr> <th>Code</th> <th>Description</th> <th>Qty</th> <th>UOM</th> </tr> </thead> <tbody> <tr> <td>0H8035A0</td> <td>MM CORE PROBE ACCESS COVE</td> <td>1</td> <td>PZ</td> </tr> <tr> <td>CE1037A0</td> <td>UL SILICON GLASS FIBER SHEATH</td> <td>0.700</td> <td>M</td> </tr> <tr> <td>CE1685A0</td> <td>MRT8 P3,81 5 POLES FEMALE TERMINAL</td> <td>1</td> <td>PZ</td> </tr> <tr> <td>GN1632A0</td> <td>CORE PROBE INLET HOLDING GASKET</td> <td>1</td> <td>PZ</td> </tr> <tr> <td>RC1130A0</td> <td>130X2,6 CLAM</td> <td>2</td> <td>PZ</td> </tr> <tr> <td>SL1045A0</td> <td>S57 BLACK SILICONE - 80ML CARTRIDGE</td> <td>1</td> <td>PZ</td> </tr> <tr> <td>SN1002B0</td> <td>L2050 MULTI.POINT CORE PROBE WITHOUT NUT</td> <td>1</td> <td>PZ</td> </tr> <tr> <td>VI1220A1</td> <td>4,2X12 TCB SELF-TAPPIN G SCREW</td> <td>3</td> <td>PZ</td> </tr> </tbody> </table>	Code	Description	Qty	UOM	0H8035A0	MM CORE PROBE ACCESS COVE	1	PZ	CE1037A0	UL SILICON GLASS FIBER SHEATH	0.700	M	CE1685A0	MRT8 P3,81 5 POLES FEMALE TERMINAL	1	PZ	GN1632A0	CORE PROBE INLET HOLDING GASKET	1	PZ	RC1130A0	130X2,6 CLAM	2	PZ	SL1045A0	S57 BLACK SILICONE - 80ML CARTRIDGE	1	PZ	SN1002B0	L2050 MULTI.POINT CORE PROBE WITHOUT NUT	1	PZ	VI1220A1	4,2X12 TCB SELF-TAPPIN G SCREW	3	PZ
Code	Description	Qty	UOM																																						
0H8035A0	MM CORE PROBE ACCESS COVE	1	PZ																																						
CE1037A0	UL SILICON GLASS FIBER SHEATH	0.700	M																																						
CE1685A0	MRT8 P3,81 5 POLES FEMALE TERMINAL	1	PZ																																						
GN1632A0	CORE PROBE INLET HOLDING GASKET	1	PZ																																						
RC1130A0	130X2,6 CLAM	2	PZ																																						
SL1045A0	S57 BLACK SILICONE - 80ML CARTRIDGE	1	PZ																																						
SN1002B0	L2050 MULTI.POINT CORE PROBE WITHOUT NUT	1	PZ																																						
VI1220A1	4,2X12 TCB SELF-TAPPIN G SCREW	3	PZ																																						
			KSN1002B	MULTIPOINT CORE PROBE KIT L2050	<table border="1"> <thead> <tr> <th>Code</th> <th>Description</th> <th>Qty</th> <th>UOM</th> </tr> </thead> <tbody> <tr> <td>0H8035A0</td> <td>MM CORE PROBE ACCESS COVE</td> <td>1</td> <td>PZ</td> </tr> <tr> <td>CE1685A0</td> <td>MRT8 P3,81 5 POLES FEMALE TERMINAL</td> <td>1</td> <td>PZ</td> </tr> <tr> <td>GN1632A0</td> <td>CORE PROBE INLET HOLDING GASKET</td> <td>1</td> <td>PZ</td> </tr> <tr> <td>SL1045A0</td> <td>S57 BLACK SILICONE - 80ML CARTRIDGE</td> <td>1</td> <td>PZ</td> </tr> </tbody> </table>	Code	Description	Qty	UOM	0H8035A0	MM CORE PROBE ACCESS COVE	1	PZ	CE1685A0	MRT8 P3,81 5 POLES FEMALE TERMINAL	1	PZ	GN1632A0	CORE PROBE INLET HOLDING GASKET	1	PZ	SL1045A0	S57 BLACK SILICONE - 80ML CARTRIDGE	1	PZ																
Code	Description	Qty	UOM																																						
0H8035A0	MM CORE PROBE ACCESS COVE	1	PZ																																						
CE1685A0	MRT8 P3,81 5 POLES FEMALE TERMINAL	1	PZ																																						
GN1632A0	CORE PROBE INLET HOLDING GASKET	1	PZ																																						
SL1045A0	S57 BLACK SILICONE - 80ML CARTRIDGE	1	PZ																																						

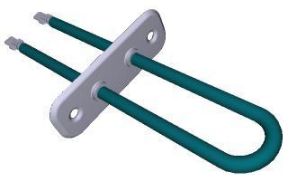

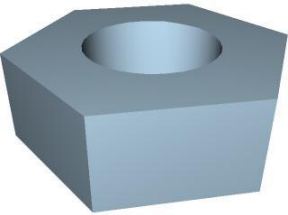

COMPONENT			SPARE PART																																														
Code	Description	Image	Code	Description	Components list																																												
SN1002B	L2050 MULTI.POINT CORE PROBE WITHOUT NUT		KSN1002B	MULTIPOINT CORE PROBE KIT L2050	<table border="1"> <thead> <tr> <th>Code</th> <th>Description</th> <th>Qty</th> <th>UOM</th> </tr> </thead> <tbody> <tr> <td>SN1002B0</td> <td>L2050 MULTI.POINT CORE PROBE WITHOUT NUT</td> <td>1</td> <td>PZ</td> </tr> <tr> <td>V11220A1</td> <td>4,2X12 TCB SELF-TAPPING SCREW</td> <td>3</td> <td>PZ</td> </tr> </tbody> </table>	Code	Description	Qty	UOM	SN1002B0	L2050 MULTI.POINT CORE PROBE WITHOUT NUT	1	PZ	V11220A1	4,2X12 TCB SELF-TAPPING SCREW	3	PZ																																
Code	Description	Qty	UOM																																														
SN1002B0	L2050 MULTI.POINT CORE PROBE WITHOUT NUT	1	PZ																																														
V11220A1	4,2X12 TCB SELF-TAPPING SCREW	3	PZ																																														
ASM3097B	Lateral supports		ASM3097B0	Lateral supports																																													
GRL1428B	XEBC-EPR 10X600X400 RIGHT LAT. SUPPORT		KGRL1428A	MM 10 600X400 LATERAL SUPPORTS KIT	<table border="1"> <thead> <tr> <th>Code</th> <th>Description</th> <th>Qty</th> <th>UOM</th> </tr> </thead> <tbody> <tr> <td>0H4215A0</td> <td>TRAYS GUIDE PROFILE L372.5 BT</td> <td>20</td> <td>PZ</td> </tr> <tr> <td>0H4420A0</td> <td>STAINLESS STEEL CORE TEMPERATUR</td> <td>1</td> <td>PZ</td> </tr> <tr> <td>0H7405A1</td> <td>BT PLUS LEFT 10X600 LAT SUPP BASE PLATE</td> <td>1</td> <td>PZ</td> </tr> <tr> <td>0H7405B0</td> <td>BT PLUS LEFT 10X600 LAT SUPP BASE PLATE</td> <td>1</td> <td>PZ</td> </tr> <tr> <td>0H7405B1</td> <td></td> <td>1</td> <td>PZ</td> </tr> <tr> <td>0H7406A1</td> <td>BT PLUS RIGHT 10X600 LAT SUPP BASE PLATE</td> <td>1</td> <td>PZ</td> </tr> <tr> <td>0H7406B0</td> <td>BT PLUS RIGHT 10X600 LAT SUPP BASE PLATE</td> <td>1</td> <td>PZ</td> </tr> <tr> <td>0H7406B1</td> <td></td> <td>1</td> <td>PZ</td> </tr> <tr> <td>IP1508A1</td> <td>POLYSTYREN E U SHAPED PROFILE 2000X60X60</td> <td>2</td> <td>M</td> </tr> <tr> <td>VM1059A1</td> <td>HEAT SHRINK FILM H800</td> <td>1.500</td> <td>M</td> </tr> </tbody> </table>	Code	Description	Qty	UOM	0H4215A0	TRAYS GUIDE PROFILE L372.5 BT	20	PZ	0H4420A0	STAINLESS STEEL CORE TEMPERATUR	1	PZ	0H7405A1	BT PLUS LEFT 10X600 LAT SUPP BASE PLATE	1	PZ	0H7405B0	BT PLUS LEFT 10X600 LAT SUPP BASE PLATE	1	PZ	0H7405B1		1	PZ	0H7406A1	BT PLUS RIGHT 10X600 LAT SUPP BASE PLATE	1	PZ	0H7406B0	BT PLUS RIGHT 10X600 LAT SUPP BASE PLATE	1	PZ	0H7406B1		1	PZ	IP1508A1	POLYSTYREN E U SHAPED PROFILE 2000X60X60	2	M	VM1059A1	HEAT SHRINK FILM H800	1.500	M
Code	Description	Qty	UOM																																														
0H4215A0	TRAYS GUIDE PROFILE L372.5 BT	20	PZ																																														
0H4420A0	STAINLESS STEEL CORE TEMPERATUR	1	PZ																																														
0H7405A1	BT PLUS LEFT 10X600 LAT SUPP BASE PLATE	1	PZ																																														
0H7405B0	BT PLUS LEFT 10X600 LAT SUPP BASE PLATE	1	PZ																																														
0H7405B1		1	PZ																																														
0H7406A1	BT PLUS RIGHT 10X600 LAT SUPP BASE PLATE	1	PZ																																														
0H7406B0	BT PLUS RIGHT 10X600 LAT SUPP BASE PLATE	1	PZ																																														
0H7406B1		1	PZ																																														
IP1508A1	POLYSTYREN E U SHAPED PROFILE 2000X60X60	2	M																																														
VM1059A1	HEAT SHRINK FILM H800	1.500	M																																														

COMPONENT			SPARE PART																																														
Code	Description	Image	Code	Description	Components list																																												
GRL1427B	XEBC-EPR 10X600X400 LEFT LAT. SUPPORT		KGRL1428A	MM 10 600X400 LATERAL SUPPORTS KIT	<table border="1"> <thead> <tr> <th>Code</th> <th>Description</th> <th>Qty</th> <th>UOM</th> </tr> </thead> <tbody> <tr> <td>0H4215A0</td> <td>TRAYS GUIDE PROFILE L372.5 BT</td> <td>20</td> <td>PZ</td> </tr> <tr> <td>0H4420A0</td> <td>STAINLESS STEEL CORE TEMPERATUR</td> <td>1</td> <td>PZ</td> </tr> <tr> <td>0H7405A1</td> <td>BT PLUS LEFT 10X600 LAT SUPP BASE PLATE</td> <td>1</td> <td>PZ</td> </tr> <tr> <td>0H7405B0</td> <td>BT PLUS LEFT 10X600 LAT SUPP BASE PLATE</td> <td>1</td> <td>PZ</td> </tr> <tr> <td>0H7405B1</td> <td></td> <td>1</td> <td>PZ</td> </tr> <tr> <td>0H7406A1</td> <td>BT PLUS RIGHT 10X600 LAT SUPP BASE PLATE</td> <td>1</td> <td>PZ</td> </tr> <tr> <td>0H7406B0</td> <td>BT PLUS RIGHT 10X600 LAT SUPP BASE PLATE</td> <td>1</td> <td>PZ</td> </tr> <tr> <td>0H7406B1</td> <td></td> <td>1</td> <td>PZ</td> </tr> <tr> <td>IP1508A1</td> <td>POLYSTYREN E U SHAPED PROFILE 2000X60X60</td> <td>2</td> <td>M</td> </tr> <tr> <td>VM1059A1</td> <td>HEAT SHRINK FILM H800</td> <td>1.500</td> <td>M</td> </tr> </tbody> </table>	Code	Description	Qty	UOM	0H4215A0	TRAYS GUIDE PROFILE L372.5 BT	20	PZ	0H4420A0	STAINLESS STEEL CORE TEMPERATUR	1	PZ	0H7405A1	BT PLUS LEFT 10X600 LAT SUPP BASE PLATE	1	PZ	0H7405B0	BT PLUS LEFT 10X600 LAT SUPP BASE PLATE	1	PZ	0H7405B1		1	PZ	0H7406A1	BT PLUS RIGHT 10X600 LAT SUPP BASE PLATE	1	PZ	0H7406B0	BT PLUS RIGHT 10X600 LAT SUPP BASE PLATE	1	PZ	0H7406B1		1	PZ	IP1508A1	POLYSTYREN E U SHAPED PROFILE 2000X60X60	2	M	VM1059A1	HEAT SHRINK FILM H800	1.500	M
Code	Description	Qty	UOM																																														
0H4215A0	TRAYS GUIDE PROFILE L372.5 BT	20	PZ																																														
0H4420A0	STAINLESS STEEL CORE TEMPERATUR	1	PZ																																														
0H7405A1	BT PLUS LEFT 10X600 LAT SUPP BASE PLATE	1	PZ																																														
0H7405B0	BT PLUS LEFT 10X600 LAT SUPP BASE PLATE	1	PZ																																														
0H7405B1		1	PZ																																														
0H7406A1	BT PLUS RIGHT 10X600 LAT SUPP BASE PLATE	1	PZ																																														
0H7406B0	BT PLUS RIGHT 10X600 LAT SUPP BASE PLATE	1	PZ																																														
0H7406B1		1	PZ																																														
IP1508A1	POLYSTYREN E U SHAPED PROFILE 2000X60X60	2	M																																														
VM1059A1	HEAT SHRINK FILM H800	1.500	M																																														
0G1593A			OUTOFPRODUCTIO	ITEM OUT OF PRODUCTION																																													
VE1550A	5X3 MM NEODYMIUM MAGNET		KPE1710B	MOTOR REVOLUTIONS SENSOR KIT	<table border="1"> <thead> <tr> <th>Code</th> <th>Description</th> <th>Qty</th> <th>UOM</th> </tr> </thead> <tbody> <tr> <td>CE1119A0</td> <td>AMPMODU2 4P 4XAWG22 L1500 RAST 4P CABLE</td> <td>1</td> <td>PZ</td> </tr> <tr> <td>PE1040A0</td> <td>RAST MOTOR SENSOR</td> <td>1</td> <td>PZ</td> </tr> <tr> <td>PE1710B0</td> <td>MOTOR REVOLUTION AND DIRECTION SENSOR</td> <td>1</td> <td>PZ</td> </tr> </tbody> </table>	Code	Description	Qty	UOM	CE1119A0	AMPMODU2 4P 4XAWG22 L1500 RAST 4P CABLE	1	PZ	PE1040A0	RAST MOTOR SENSOR	1	PZ	PE1710B0	MOTOR REVOLUTION AND DIRECTION SENSOR	1	PZ																												
Code	Description	Qty	UOM																																														
CE1119A0	AMPMODU2 4P 4XAWG22 L1500 RAST 4P CABLE	1	PZ																																														
PE1040A0	RAST MOTOR SENSOR	1	PZ																																														
PE1710B0	MOTOR REVOLUTION AND DIRECTION SENSOR	1	PZ																																														

COMPONENT			SPARE PART																														
Code	Description	Image	Code	Description	Components list																												
VE1550A	5X3 MM NEODYMIUM MAGNET		KPE1710B	MOTOR REVOLUTIONS SENSOR KIT	<table border="1"> <thead> <tr> <th>Code</th> <th>Description</th> <th>Qty</th> <th>UOM</th> </tr> </thead> <tbody> <tr> <td>VE1550A0</td> <td>5X3 MM NEODYMIUM MAGNET</td> <td>1</td> <td>PZ</td> </tr> <tr> <td>VI1966A0</td> <td>M4X14 FLATHEAD SCREW</td> <td>1</td> <td>PZ</td> </tr> <tr> <td>VM1635A0</td> <td>MAGNET HOLDING DIS</td> <td>1</td> <td>PZ</td> </tr> </tbody> </table>	Code	Description	Qty	UOM	VE1550A0	5X3 MM NEODYMIUM MAGNET	1	PZ	VI1966A0	M4X14 FLATHEAD SCREW	1	PZ	VM1635A0	MAGNET HOLDING DIS	1	PZ												
Code	Description	Qty	UOM																														
VE1550A0	5X3 MM NEODYMIUM MAGNET	1	PZ																														
VI1966A0	M4X14 FLATHEAD SCREW	1	PZ																														
VM1635A0	MAGNET HOLDING DIS	1	PZ																														
PE1710B	MOTOR REVOLUTION AND DIRECTION SENSO		KPE1710B	MOTOR REVOLUTIONS SENSOR KIT	<table border="1"> <thead> <tr> <th>Code</th> <th>Description</th> <th>Qty</th> <th>UOM</th> </tr> </thead> <tbody> <tr> <td>CE1119A0</td> <td>AMPMODU2 4P 4XAWG22 L1500 RAST 4P CABLE</td> <td>1</td> <td>PZ</td> </tr> <tr> <td>PE1040A0</td> <td>RAST MOTOR SENSOR</td> <td>1</td> <td>PZ</td> </tr> <tr> <td>PE1710B0</td> <td>MOTOR REVOLUTION AND DIRECTION SENSOR</td> <td>1</td> <td>PZ</td> </tr> <tr> <td>VE1550A0</td> <td>5X3 MM NEODYMIUM MAGNET</td> <td>1</td> <td>PZ</td> </tr> <tr> <td>VI1966A0</td> <td>M4X14 FLATHEAD SCREW</td> <td>1</td> <td>PZ</td> </tr> <tr> <td>VM1635A0</td> <td>MAGNET HOLDING DIS</td> <td>1</td> <td>PZ</td> </tr> </tbody> </table>	Code	Description	Qty	UOM	CE1119A0	AMPMODU2 4P 4XAWG22 L1500 RAST 4P CABLE	1	PZ	PE1040A0	RAST MOTOR SENSOR	1	PZ	PE1710B0	MOTOR REVOLUTION AND DIRECTION SENSOR	1	PZ	VE1550A0	5X3 MM NEODYMIUM MAGNET	1	PZ	VI1966A0	M4X14 FLATHEAD SCREW	1	PZ	VM1635A0	MAGNET HOLDING DIS	1	PZ
Code	Description	Qty	UOM																														
CE1119A0	AMPMODU2 4P 4XAWG22 L1500 RAST 4P CABLE	1	PZ																														
PE1040A0	RAST MOTOR SENSOR	1	PZ																														
PE1710B0	MOTOR REVOLUTION AND DIRECTION SENSOR	1	PZ																														
VE1550A0	5X3 MM NEODYMIUM MAGNET	1	PZ																														
VI1966A0	M4X14 FLATHEAD SCREW	1	PZ																														
VM1635A0	MAGNET HOLDING DIS	1	PZ																														
GN1531A	THERMOSTAT BULB INLET SEALING		KTR1136A	330°C SAFETY THERMOSTAT KIT	<table border="1"> <thead> <tr> <th>Code</th> <th>Description</th> <th>Qty</th> <th>UOM</th> </tr> </thead> <tbody> <tr> <td>0H7030A0</td> <td>THERMOSTAT BULB INLET COVER</td> <td>1</td> <td>PZ</td> </tr> <tr> <td>GN1531A0</td> <td>THERMOSTAT BULB INLET SEALING</td> <td>1</td> <td>PZ</td> </tr> <tr> <td>MOV0011A0</td> <td>HOOD RING GASKET GN1110A2</td> <td>0.100</td> <td>PZ</td> </tr> <tr> <td>SL1045A0</td> <td>S57 BLACK SILICONE - 80ML CARTRIDGE</td> <td>1</td> <td>PZ</td> </tr> <tr> <td>TR1136A0</td> <td>330°C 1 POLE SAFETY THERMOSTAT</td> <td>1</td> <td>PZ</td> </tr> <tr> <td>VI1220A1</td> <td>4,2X12 TCB SELF-TAPPIN G SCREW</td> <td>3</td> <td>PZ</td> </tr> </tbody> </table>	Code	Description	Qty	UOM	0H7030A0	THERMOSTAT BULB INLET COVER	1	PZ	GN1531A0	THERMOSTAT BULB INLET SEALING	1	PZ	MOV0011A0	HOOD RING GASKET GN1110A2	0.100	PZ	SL1045A0	S57 BLACK SILICONE - 80ML CARTRIDGE	1	PZ	TR1136A0	330°C 1 POLE SAFETY THERMOSTAT	1	PZ	VI1220A1	4,2X12 TCB SELF-TAPPIN G SCREW	3	PZ
Code	Description	Qty	UOM																														
0H7030A0	THERMOSTAT BULB INLET COVER	1	PZ																														
GN1531A0	THERMOSTAT BULB INLET SEALING	1	PZ																														
MOV0011A0	HOOD RING GASKET GN1110A2	0.100	PZ																														
SL1045A0	S57 BLACK SILICONE - 80ML CARTRIDGE	1	PZ																														
TR1136A0	330°C 1 POLE SAFETY THERMOSTAT	1	PZ																														
VI1220A1	4,2X12 TCB SELF-TAPPIN G SCREW	3	PZ																														

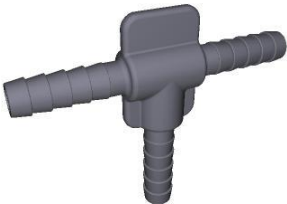



COMPONENT			SPARE PART																										
Code	Description	Image	Code	Description	Components list																								
0H7030A	THERMOSTAT BULB INLET COVER		K0H7030A	THERMOSTAT BULB INLET COVER KIT	<table border="1"> <thead> <tr> <th>Code</th> <th>Description</th> <th>Qty</th> <th>UOM</th> </tr> </thead> <tbody> <tr> <td>0H7030A0</td> <td>THERMOSTAT BULB INLET COVER</td> <td>1</td> <td>PZ</td> </tr> <tr> <td>VM1224A0</td> <td>65MY 220MM 2 COLOURS SHRINK TUBE</td> <td>0.200</td> <td>M</td> </tr> </tbody> </table>	Code	Description	Qty	UOM	0H7030A0	THERMOSTAT BULB INLET COVER	1	PZ	VM1224A0	65MY 220MM 2 COLOURS SHRINK TUBE	0.200	M												
					Code	Description	Qty	UOM																					
0H7030A0	THERMOSTAT BULB INLET COVER	1	PZ																										
VM1224A0	65MY 220MM 2 COLOURS SHRINK TUBE	0.200	M																										
<table border="1"> <thead> <tr> <th>Code</th> <th>Description</th> <th>Qty</th> <th>UOM</th> </tr> </thead> <tbody> <tr> <td>GN1672A1</td> <td>RS1274A ELEMENT GASKET</td> <td>1</td> <td>PZ</td> </tr> <tr> <td>MOV0009A0</td> <td>HOOD RING GASKET</td> <td>0.100</td> <td>PZ</td> </tr> <tr> <td>RS1215B0</td> <td>1 TURN 147W 105V FLAT ELEMENT</td> <td>1</td> <td>PZ</td> </tr> <tr> <td>SL1045A0</td> <td>S57 BLACK SILICONE - 80ML CARTRIDGE</td> <td>1</td> <td>PZ</td> </tr> <tr> <td>VI1220A1</td> <td>4,2X12 TCB SELF-TAPPIN G SCREW</td> <td>2</td> <td>PZ</td> </tr> </tbody> </table>	Code	Description	Qty	UOM	GN1672A1	RS1274A ELEMENT GASKET	1	PZ	MOV0009A0	HOOD RING GASKET	0.100	PZ	RS1215B0	1 TURN 147W 105V FLAT ELEMENT	1	PZ	SL1045A0	S57 BLACK SILICONE - 80ML CARTRIDGE	1	PZ	VI1220A1	4,2X12 TCB SELF-TAPPIN G SCREW	2	PZ					
Code	Description	Qty	UOM																										
GN1672A1	RS1274A ELEMENT GASKET	1	PZ																										
MOV0009A0	HOOD RING GASKET	0.100	PZ																										
RS1215B0	1 TURN 147W 105V FLAT ELEMENT	1	PZ																										
SL1045A0	S57 BLACK SILICONE - 80ML CARTRIDGE	1	PZ																										
VI1220A1	4,2X12 TCB SELF-TAPPIN G SCREW	2	PZ																										
RS1215B	1 TURN 147W 105V FLAT ELEMENT		KRS1215B	147W MOTOR BRAKING ELEMENT KIT	<table border="1"> <thead> <tr> <th>Code</th> <th>Description</th> <th>Qty</th> <th>UOM</th> </tr> </thead> <tbody> <tr> <td>GN1672A1</td> <td>RS1274A ELEMENT GASKET</td> <td>1</td> <td>PZ</td> </tr> <tr> <td>MOV0009A0</td> <td>HOOD RING GASKET</td> <td>0.100</td> <td>PZ</td> </tr> <tr> <td>RS1215B0</td> <td>1 TURN 147W 105V FLAT ELEMENT</td> <td>1</td> <td>PZ</td> </tr> <tr> <td>SL1045A0</td> <td>S57 BLACK SILICONE - 80ML CARTRIDGE</td> <td>1</td> <td>PZ</td> </tr> <tr> <td>VI1220A1</td> <td>4,2X12 TCB SELF-TAPPIN G SCREW</td> <td>2</td> <td>PZ</td> </tr> </tbody> </table>	Code	Description	Qty	UOM	GN1672A1	RS1274A ELEMENT GASKET	1	PZ	MOV0009A0	HOOD RING GASKET	0.100	PZ	RS1215B0	1 TURN 147W 105V FLAT ELEMENT	1	PZ	SL1045A0	S57 BLACK SILICONE - 80ML CARTRIDGE	1	PZ	VI1220A1	4,2X12 TCB SELF-TAPPIN G SCREW	2	PZ
			Code	Description	Qty	UOM																							
GN1672A1	RS1274A ELEMENT GASKET	1	PZ																										
MOV0009A0	HOOD RING GASKET	0.100	PZ																										
RS1215B0	1 TURN 147W 105V FLAT ELEMENT	1	PZ																										
SL1045A0	S57 BLACK SILICONE - 80ML CARTRIDGE	1	PZ																										
VI1220A1	4,2X12 TCB SELF-TAPPIN G SCREW	2	PZ																										
KRS0026A	BIG-L 147W MOTOR BRAKING ELEMENT KIT	<table border="1"> <thead> <tr> <th>Code</th> <th>Description</th> <th>Qty</th> <th>UOM</th> </tr> </thead> <tbody> <tr> <td>GN1672A0</td> <td></td> <td>1</td> <td>PZ</td> </tr> <tr> <td>GN1672A1</td> <td>RS1274A ELEMENT GASKET</td> <td>1</td> <td>PZ</td> </tr> <tr> <td>RS1215A1</td> <td>147W 105V BRAKING ELEMENT</td> <td>1</td> <td>PZ</td> </tr> <tr> <td>SL1045A0</td> <td>S57 BLACK SILICONE - 80ML CARTRIDGE</td> <td>1</td> <td>PZ</td> </tr> <tr> <td>VI1220A1</td> <td>4,2X12 TCB SELF-TAPPIN G SCREW</td> <td>2</td> <td>PZ</td> </tr> </tbody> </table>	Code	Description	Qty	UOM	GN1672A0		1	PZ	GN1672A1	RS1274A ELEMENT GASKET	1	PZ	RS1215A1	147W 105V BRAKING ELEMENT	1	PZ	SL1045A0	S57 BLACK SILICONE - 80ML CARTRIDGE	1	PZ	VI1220A1	4,2X12 TCB SELF-TAPPIN G SCREW	2	PZ			
Code	Description	Qty	UOM																										
GN1672A0		1	PZ																										
GN1672A1	RS1274A ELEMENT GASKET	1	PZ																										
RS1215A1	147W 105V BRAKING ELEMENT	1	PZ																										
SL1045A0	S57 BLACK SILICONE - 80ML CARTRIDGE	1	PZ																										
VI1220A1	4,2X12 TCB SELF-TAPPIN G SCREW	2	PZ																										
GN1672A	RS1274A ELEMENT GASKET		KG1672A	71X19 HEATING ELEMENT GASKET 5 PCS KIT	<table border="1"> <thead> <tr> <th>Code</th> <th>Description</th> <th>Qty</th> <th>UOM</th> </tr> </thead> <tbody> <tr> <td>GN1672A0</td> <td></td> <td>5</td> <td>PZ</td> </tr> <tr> <td>GN1672A1</td> <td>RS1274A ELEMENT GASKET</td> <td>5</td> <td>PZ</td> </tr> <tr> <td>VM1224A0</td> <td>65MY 220MM 2 COLOURS SHRINK TUBE</td> <td>0.250</td> <td>M</td> </tr> </tbody> </table>	Code	Description	Qty	UOM	GN1672A0		5	PZ	GN1672A1	RS1274A ELEMENT GASKET	5	PZ	VM1224A0	65MY 220MM 2 COLOURS SHRINK TUBE	0.250	M								
Code	Description	Qty	UOM																										
GN1672A0		5	PZ																										
GN1672A1	RS1274A ELEMENT GASKET	5	PZ																										
VM1224A0	65MY 220MM 2 COLOURS SHRINK TUBE	0.250	M																										

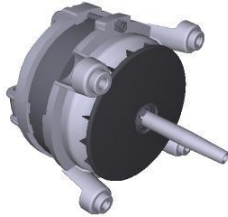



COMPONENT			SPARE PART																										
Code	Description	Image	Code	Description	Components list																								
RS1274B	1 TURN 100W 60V FLAT ELEMENT		KRS1274B	100W MOTOR BRAKING ELEMENT KIT	<table border="1"> <thead> <tr> <th>Code</th> <th>Description</th> <th>Qty</th> <th>UOM</th> </tr> </thead> <tbody> <tr> <td>GN1672A1</td> <td>RS1274A ELEMENT GASKET</td> <td>1</td> <td>PZ</td> </tr> <tr> <td>MOV0009A0</td> <td>HOOD RING GASKET GN1110A2</td> <td>0.100</td> <td>PZ</td> </tr> <tr> <td>RS1274B0</td> <td>1 TURN 100W 60V FLAT ELEMENT</td> <td>1</td> <td>PZ</td> </tr> <tr> <td>SL1045A0</td> <td>S57 BLACK SILICONE - 80ML CARTRIDGE</td> <td>1</td> <td>PZ</td> </tr> <tr> <td>VI1220A1</td> <td>4,2X12 TCB SELF-TAPPIN G SCREW</td> <td>2</td> <td>PZ</td> </tr> </tbody> </table>	Code	Description	Qty	UOM	GN1672A1	RS1274A ELEMENT GASKET	1	PZ	MOV0009A0	HOOD RING GASKET GN1110A2	0.100	PZ	RS1274B0	1 TURN 100W 60V FLAT ELEMENT	1	PZ	SL1045A0	S57 BLACK SILICONE - 80ML CARTRIDGE	1	PZ	VI1220A1	4,2X12 TCB SELF-TAPPIN G SCREW	2	PZ
					Code	Description	Qty	UOM																					
					GN1672A1	RS1274A ELEMENT GASKET	1	PZ																					
					MOV0009A0	HOOD RING GASKET GN1110A2	0.100	PZ																					
					RS1274B0	1 TURN 100W 60V FLAT ELEMENT	1	PZ																					
					SL1045A0	S57 BLACK SILICONE - 80ML CARTRIDGE	1	PZ																					
VI1220A1	4,2X12 TCB SELF-TAPPIN G SCREW	2	PZ																										
GN1672A	RS1274A ELEMENT GASKET		KGN1672A	71X19 HEATING ELEMENT GASKET 5 PCS KIT	<table border="1"> <thead> <tr> <th>Code</th> <th>Description</th> <th>Qty</th> <th>UOM</th> </tr> </thead> <tbody> <tr> <td>GN1672A0</td> <td></td> <td>5</td> <td>PZ</td> </tr> <tr> <td>GN1672A1</td> <td>RS1274A ELEMENT GASKET</td> <td>5</td> <td>PZ</td> </tr> <tr> <td>VM1224A0</td> <td>65MY 220MM 2 COLOURS SHRINK TUBE</td> <td>0.250</td> <td>M</td> </tr> </tbody> </table>	Code	Description	Qty	UOM	GN1672A0		5	PZ	GN1672A1	RS1274A ELEMENT GASKET	5	PZ	VM1224A0	65MY 220MM 2 COLOURS SHRINK TUBE	0.250	M								
					Code	Description	Qty	UOM																					
					GN1672A0		5	PZ																					
GN1672A1	RS1274A ELEMENT GASKET	5	PZ																										
VM1224A0	65MY 220MM 2 COLOURS SHRINK TUBE	0.250	M																										
RC1170A	STAINLESS STEEL NUT M14 H=8 CH=22		KRC1170A	M14 H8 CH22 NUT - 10 PCS. KIT	<table border="1"> <thead> <tr> <th>Code</th> <th>Description</th> <th>Qty</th> <th>UOM</th> </tr> </thead> <tbody> <tr> <td>RC1170A1</td> <td>STAINLESS STEEL NUT M14 H=8 CH=22</td> <td>10</td> <td>PZ</td> </tr> <tr> <td>VM1224A0</td> <td>65MY 220MM 2 COLOURS SHRINK TUBE</td> <td>0.200</td> <td>M</td> </tr> </tbody> </table>	Code	Description	Qty	UOM	RC1170A1	STAINLESS STEEL NUT M14 H=8 CH=22	10	PZ	VM1224A0	65MY 220MM 2 COLOURS SHRINK TUBE	0.200	M												
					Code	Description	Qty	UOM																					
RC1170A1	STAINLESS STEEL NUT M14 H=8 CH=22	10	PZ																										
VM1224A0	65MY 220MM 2 COLOURS SHRINK TUBE	0.200	M																										
TB2937B	XEBC EXTERNAL WATER PIPE D10+CONNECTION		TB2937B0	XEBC EXTERNAL WATER PIPE D10+CONNECTION																									

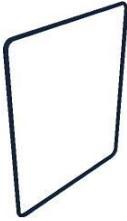



COMPONENT			SPARE PART																						
Code	Description	Image	Code	Description	Components list																				
VL1127A	6MM BARBED T-SHAPED FITTING		KVL1127A	6MM BARBED T-SHAPED FITTING 10 PCS KIT	<table border="1"> <thead> <tr> <th>Code</th> <th>Description</th> <th>Qty</th> <th>UOM</th> </tr> </thead> <tbody> <tr> <td>VL1127A1</td> <td>6MM BARBED T-SHAPED FITTING</td> <td>10</td> <td>PZ</td> </tr> <tr> <td>VM1224A0</td> <td>65MY 220MM 2 COLOURS SHRINK TUBE</td> <td>0.200</td> <td>M</td> </tr> </tbody> </table>	Code	Description	Qty	UOM	VL1127A1	6MM BARBED T-SHAPED FITTING	10	PZ	VM1224A0	65MY 220MM 2 COLOURS SHRINK TUBE	0.200	M								
Code	Description	Qty	UOM																						
VL1127A1	6MM BARBED T-SHAPED FITTING	10	PZ																						
VM1224A0	65MY 220MM 2 COLOURS SHRINK TUBE	0.200	M																						
TB3253A	TB3131A-T SHAPED EXT HUM PIPE CONNECTION		KTB3131A	WHITE-BLACK 6X12 REINFORCED PIPE 3M KIT	<table border="1"> <thead> <tr> <th>Code</th> <th>Description</th> <th>Qty</th> <th>UOM</th> </tr> </thead> <tbody> <tr> <td>TB3131A0</td> <td>WHITE-BLACK EPDM TEXTILE BRAID HOSE 6X12</td> <td>3</td> <td>M</td> </tr> <tr> <td>VM1794A0</td> <td>250X4.8 PA66 BLACK CLAMP</td> <td>1</td> <td>PZ</td> </tr> </tbody> </table>	Code	Description	Qty	UOM	TB3131A0	WHITE-BLACK EPDM TEXTILE BRAID HOSE 6X12	3	M	VM1794A0	250X4.8 PA66 BLACK CLAMP	1	PZ								
Code	Description	Qty	UOM																						
TB3131A0	WHITE-BLACK EPDM TEXTILE BRAID HOSE 6X12	3	M																						
VM1794A0	250X4.8 PA66 BLACK CLAMP	1	PZ																						
0H8035A	MM CORE PROBE ACCESS COVER		0H8035A0	MM CORE PROBE ACCESS COVER																					
GN1632A	CORE PROBE INLET HOLDING GASKET		GN1632A0	CORE PROBE INLET HOLDING GASKET																					
RS1002A	6750W 230V D230 6 TURNS HEATING ELEMENT		KRS1002A	6750W 230V HEATING ELEMENT KIT	<table border="1"> <thead> <tr> <th>Code</th> <th>Description</th> <th>Qty</th> <th>UOM</th> </tr> </thead> <tbody> <tr> <td>GN1086A0</td> <td>ELEMENT SEALING</td> <td>1</td> <td>PZ</td> </tr> <tr> <td>GN1671A0</td> <td>141X22 G8.5 ELEMENT ARMED GASKET</td> <td>1</td> <td>PZ</td> </tr> <tr> <td>MOV0008A0</td> <td>HOOD RING GASKET GN1110A2</td> <td>0.100</td> <td>PZ</td> </tr> <tr> <td>RS1002A1</td> <td>6750W 230V D230 6 TURNS HEATING ELEMENT</td> <td>1</td> <td>PZ</td> </tr> </tbody> </table>	Code	Description	Qty	UOM	GN1086A0	ELEMENT SEALING	1	PZ	GN1671A0	141X22 G8.5 ELEMENT ARMED GASKET	1	PZ	MOV0008A0	HOOD RING GASKET GN1110A2	0.100	PZ	RS1002A1	6750W 230V D230 6 TURNS HEATING ELEMENT	1	PZ
Code	Description	Qty	UOM																						
GN1086A0	ELEMENT SEALING	1	PZ																						
GN1671A0	141X22 G8.5 ELEMENT ARMED GASKET	1	PZ																						
MOV0008A0	HOOD RING GASKET GN1110A2	0.100	PZ																						
RS1002A1	6750W 230V D230 6 TURNS HEATING ELEMENT	1	PZ																						

COMPONENT			SPARE PART																																														
Code	Description	Image	Code	Description	Components list																																												
RS1002A	6750W 230V D230 6 TURNS HEATING ELEMENT		KRS1002A	6750W 230V HEATING ELEMENT KIT	<table border="1"> <thead> <tr> <th>Code</th> <th>Description</th> <th>Qty</th> <th>UOM</th> </tr> </thead> <tbody> <tr> <td>SL1045A0</td> <td>S57 BLACK SILICONE - 80ML CARTRIDGE</td> <td>1</td> <td>PZ</td> </tr> <tr> <td>V11220A1</td> <td>4,2X12 TCB SELF-TAPPIN G SCREW</td> <td>5</td> <td>PZ</td> </tr> <tr> <td>VM1794A0</td> <td>250X4.8 PA66 BLACK CLAMP</td> <td>2</td> <td>PZ</td> </tr> <tr> <td>VM2103A0</td> <td>CLAMP LOCK</td> <td>2</td> <td>PZ</td> </tr> </tbody> </table>	Code	Description	Qty	UOM	SL1045A0	S57 BLACK SILICONE - 80ML CARTRIDGE	1	PZ	V11220A1	4,2X12 TCB SELF-TAPPIN G SCREW	5	PZ	VM1794A0	250X4.8 PA66 BLACK CLAMP	2	PZ	VM2103A0	CLAMP LOCK	2	PZ																								
Code	Description	Qty	UOM																																														
SL1045A0	S57 BLACK SILICONE - 80ML CARTRIDGE	1	PZ																																														
V11220A1	4,2X12 TCB SELF-TAPPIN G SCREW	5	PZ																																														
VM1794A0	250X4.8 PA66 BLACK CLAMP	2	PZ																																														
VM2103A0	CLAMP LOCK	2	PZ																																														
MT1012A	330W 230V MOTOR		KVN1130A	LUX =08.2017/S.5/S.5E 330W MOTOR KIT	<table border="1"> <thead> <tr> <th>Code</th> <th>Description</th> <th>Qty</th> <th>UOM</th> </tr> </thead> <tbody> <tr> <td>0H4305A1</td> <td>ST. STEEL MOTOR SHAFT SEALING DISC</td> <td>1</td> <td>PZ</td> </tr> <tr> <td>GN1140A2</td> <td>MOTOR HOLDER GASKET</td> <td>1</td> <td>PZ</td> </tr> <tr> <td>GN1140A3</td> <td>MOLDED MOTOR HOLDER GASKET</td> <td>1</td> <td>PZ</td> </tr> <tr> <td>V11045A0</td> <td>16X8,4 TH=1,6 ST.STEEL WASHER</td> <td>1</td> <td>PZ</td> </tr> <tr> <td>V11256A0</td> <td>M8 DIN 980M ST. STEEL SELF LOCKING NUT</td> <td>1</td> <td>PZ</td> </tr> <tr> <td>VM1794A0</td> <td>250X4.8 PA66 BLACK CLAMP</td> <td>4</td> <td>PZ</td> </tr> <tr> <td>VM2103A0</td> <td>CLAMP LOCK</td> <td>4</td> <td>PZ</td> </tr> <tr> <td>VM2196A0</td> <td>MOTOR NUT FASTENING BUSHING</td> <td>1</td> <td>PZ</td> </tr> <tr> <td>VN1130A1</td> <td>330W 230V 50/60HZ MOTO</td> <td>1</td> <td>PZ</td> </tr> <tr> <td>VN1130A1</td> <td>330W 230V 50/60HZ MOTO</td> <td>1</td> <td>PZ</td> </tr> </tbody> </table>	Code	Description	Qty	UOM	0H4305A1	ST. STEEL MOTOR SHAFT SEALING DISC	1	PZ	GN1140A2	MOTOR HOLDER GASKET	1	PZ	GN1140A3	MOLDED MOTOR HOLDER GASKET	1	PZ	V11045A0	16X8,4 TH=1,6 ST.STEEL WASHER	1	PZ	V11256A0	M8 DIN 980M ST. STEEL SELF LOCKING NUT	1	PZ	VM1794A0	250X4.8 PA66 BLACK CLAMP	4	PZ	VM2103A0	CLAMP LOCK	4	PZ	VM2196A0	MOTOR NUT FASTENING BUSHING	1	PZ	VN1130A1	330W 230V 50/60HZ MOTO	1	PZ	VN1130A1	330W 230V 50/60HZ MOTO	1	PZ
Code	Description	Qty	UOM																																														
0H4305A1	ST. STEEL MOTOR SHAFT SEALING DISC	1	PZ																																														
GN1140A2	MOTOR HOLDER GASKET	1	PZ																																														
GN1140A3	MOLDED MOTOR HOLDER GASKET	1	PZ																																														
V11045A0	16X8,4 TH=1,6 ST.STEEL WASHER	1	PZ																																														
V11256A0	M8 DIN 980M ST. STEEL SELF LOCKING NUT	1	PZ																																														
VM1794A0	250X4.8 PA66 BLACK CLAMP	4	PZ																																														
VM2103A0	CLAMP LOCK	4	PZ																																														
VM2196A0	MOTOR NUT FASTENING BUSHING	1	PZ																																														
VN1130A1	330W 230V 50/60HZ MOTO	1	PZ																																														
VN1130A1	330W 230V 50/60HZ MOTO	1	PZ																																														
			KMT1012A	MIND.MAPS 330W 230V MOTOR KIT	<table border="1"> <thead> <tr> <th>Code</th> <th>Description</th> <th>Qty</th> <th>UOM</th> </tr> </thead> <tbody> <tr> <td>0H2842A0</td> <td></td> <td>1</td> <td>PZ</td> </tr> <tr> <td>0H4305A1</td> <td>ST. STEEL MOTOR SHAFT SEALING DISC</td> <td>1</td> <td>PZ</td> </tr> <tr> <td>GN1140A2</td> <td>MOTOR HOLDER GASKET</td> <td>1</td> <td>PZ</td> </tr> <tr> <td>GN1140A3</td> <td>MOLDED MOTOR HOLDER GASKET</td> <td>1</td> <td>PZ</td> </tr> </tbody> </table>	Code	Description	Qty	UOM	0H2842A0		1	PZ	0H4305A1	ST. STEEL MOTOR SHAFT SEALING DISC	1	PZ	GN1140A2	MOTOR HOLDER GASKET	1	PZ	GN1140A3	MOLDED MOTOR HOLDER GASKET	1	PZ																								
Code	Description	Qty	UOM																																														
0H2842A0		1	PZ																																														
0H4305A1	ST. STEEL MOTOR SHAFT SEALING DISC	1	PZ																																														
GN1140A2	MOTOR HOLDER GASKET	1	PZ																																														
GN1140A3	MOLDED MOTOR HOLDER GASKET	1	PZ																																														

COMPONENT			SPARE PART																																																		
Code	Description	Image	Code	Description	Components list																																																
MT1012A	330W 230V MOTOR		KMT1012A	MIND.MAPS 330W 230V MOTOR KIT	<table border="1"> <thead> <tr> <th>Code</th> <th>Description</th> <th>Qty</th> <th>UOM</th> </tr> </thead> <tbody> <tr> <td>MOV0007A0</td> <td>HOOD RING</td> <td>0.100</td> <td>PZ</td> </tr> <tr> <td></td> <td>GASKET</td> <td></td> <td></td> </tr> <tr> <td></td> <td>GN1110A2</td> <td></td> <td></td> </tr> <tr> <td>MT1012A0</td> <td>330W 230V MOTOR</td> <td>1</td> <td>PZ</td> </tr> <tr> <td>VE1550A0</td> <td>5X3 MM NEODYMIUM MAGNET</td> <td>1</td> <td>PZ</td> </tr> <tr> <td>VI1077A1</td> <td>SCREW M6X12 TE INOX</td> <td>1</td> <td>PZ</td> </tr> <tr> <td>VI1521A0</td> <td>STAINLESS STEEL WASHER D=6 6592</td> <td>1</td> <td>PZ</td> </tr> <tr> <td>VI1966A0</td> <td>M4X14 FLATHEAD SCREW</td> <td>1</td> <td>PZ</td> </tr> <tr> <td>VM1635A0</td> <td>MAGNET HOLDING DIS</td> <td>1</td> <td>PZ</td> </tr> <tr> <td>VM1794A0</td> <td>250X4.8 PA66 BLACK CLAMP</td> <td>4</td> <td>PZ</td> </tr> <tr> <td>VM2103A0</td> <td>CLAMP LOCK</td> <td>4</td> <td>PZ</td> </tr> </tbody> </table>	Code	Description	Qty	UOM	MOV0007A0	HOOD RING	0.100	PZ		GASKET				GN1110A2			MT1012A0	330W 230V MOTOR	1	PZ	VE1550A0	5X3 MM NEODYMIUM MAGNET	1	PZ	VI1077A1	SCREW M6X12 TE INOX	1	PZ	VI1521A0	STAINLESS STEEL WASHER D=6 6592	1	PZ	VI1966A0	M4X14 FLATHEAD SCREW	1	PZ	VM1635A0	MAGNET HOLDING DIS	1	PZ	VM1794A0	250X4.8 PA66 BLACK CLAMP	4	PZ	VM2103A0	CLAMP LOCK	4	PZ
					Code	Description	Qty	UOM																																													
					MOV0007A0	HOOD RING	0.100	PZ																																													
						GASKET																																															
						GN1110A2																																															
					MT1012A0	330W 230V MOTOR	1	PZ																																													
					VE1550A0	5X3 MM NEODYMIUM MAGNET	1	PZ																																													
					VI1077A1	SCREW M6X12 TE INOX	1	PZ																																													
					VI1521A0	STAINLESS STEEL WASHER D=6 6592	1	PZ																																													
					VI1966A0	M4X14 FLATHEAD SCREW	1	PZ																																													
VM1635A0	MAGNET HOLDING DIS	1	PZ																																																		
VM1794A0	250X4.8 PA66 BLACK CLAMP	4	PZ																																																		
VM2103A0	CLAMP LOCK	4	PZ																																																		
0H4305A	ST. STEEL MOTOR SHAFT SEALING DIS		K0H4305A	SEALING DISC FOR MOTOR SHAFT KIT	<table border="1"> <thead> <tr> <th>Code</th> <th>Description</th> <th>Qty</th> <th>UOM</th> </tr> </thead> <tbody> <tr> <td>0H4305A1</td> <td>ST. STEEL MOTOR SHAFT SEALING DISC</td> <td>1</td> <td>PZ</td> </tr> <tr> <td>GN1140A2</td> <td>MOTOR HOLDER GASKET</td> <td>1</td> <td>PZ</td> </tr> <tr> <td>GN1140A3</td> <td>MOLDED MOTOR HOLDER GASKET</td> <td>1</td> <td>PZ</td> </tr> <tr> <td>SL1045A0</td> <td>S57 BLACK SILICONE - 80ML CARTRIDGE</td> <td>1</td> <td>PZ</td> </tr> <tr> <td>VI1220A1</td> <td>4,2X12 TCB SELF-TAPPING SCREW</td> <td>3</td> <td>PZ</td> </tr> </tbody> </table>	Code	Description	Qty	UOM	0H4305A1	ST. STEEL MOTOR SHAFT SEALING DISC	1	PZ	GN1140A2	MOTOR HOLDER GASKET	1	PZ	GN1140A3	MOLDED MOTOR HOLDER GASKET	1	PZ	SL1045A0	S57 BLACK SILICONE - 80ML CARTRIDGE	1	PZ	VI1220A1	4,2X12 TCB SELF-TAPPING SCREW	3	PZ																								
					Code	Description	Qty	UOM																																													
					0H4305A1	ST. STEEL MOTOR SHAFT SEALING DISC	1	PZ																																													
					GN1140A2	MOTOR HOLDER GASKET	1	PZ																																													
					GN1140A3	MOLDED MOTOR HOLDER GASKET	1	PZ																																													
					SL1045A0	S57 BLACK SILICONE - 80ML CARTRIDGE	1	PZ																																													
VI1220A1	4,2X12 TCB SELF-TAPPING SCREW	3	PZ																																																		
VN1170B	D195 H80 8 BLADES FAN+RING		KVN1170B	D195 H80 8 BLADES FAN + RING KIT	<table border="1"> <thead> <tr> <th>Code</th> <th>Description</th> <th>Qty</th> <th>UOM</th> </tr> </thead> <tbody> <tr> <td>VI1077A1</td> <td>SCREW M6X12 TE INOX</td> <td>1</td> <td>PZ</td> </tr> <tr> <td>VI1521A0</td> <td>STAINLESS STEEL WASHER D=6 6592</td> <td>1</td> <td>PZ</td> </tr> <tr> <td>VN1170B0</td> <td>D195 H80 8 BLADES FAN+RING</td> <td>1</td> <td>PZ</td> </tr> <tr> <td>VN1170B0</td> <td>D195 H80 8 BLADES FAN+RING</td> <td>1</td> <td>PZ</td> </tr> </tbody> </table>	Code	Description	Qty	UOM	VI1077A1	SCREW M6X12 TE INOX	1	PZ	VI1521A0	STAINLESS STEEL WASHER D=6 6592	1	PZ	VN1170B0	D195 H80 8 BLADES FAN+RING	1	PZ	VN1170B0	D195 H80 8 BLADES FAN+RING	1	PZ																												
					Code	Description	Qty	UOM																																													
					VI1077A1	SCREW M6X12 TE INOX	1	PZ																																													
					VI1521A0	STAINLESS STEEL WASHER D=6 6592	1	PZ																																													
VN1170B0	D195 H80 8 BLADES FAN+RING	1	PZ																																																		
VN1170B0	D195 H80 8 BLADES FAN+RING	1	PZ																																																		

COMPONENT			SPARE PART																						
Code	Description	Image	Code	Description	Components list																				
GN1140A	MOLDED MOTOR HOLDER GASKET		KGN1140A	5 PCS. MOTOR HOLDER GASKET KI	<table border="1"> <thead> <tr> <th>Code</th> <th>Description</th> <th>Qty</th> <th>UOM</th> </tr> </thead> <tbody> <tr> <td>GN1140A2</td> <td>MOTOR HOLDER GASKET</td> <td>5</td> <td>PZ</td> </tr> <tr> <td>GN1140A3</td> <td>MOLDED MOTOR HOLDER GASKET</td> <td>5</td> <td>PZ</td> </tr> <tr> <td>VM1224A0</td> <td>65MY 220MM 2 COLOURS SHRINK TUBE</td> <td>0.200</td> <td>M</td> </tr> </tbody> </table>	Code	Description	Qty	UOM	GN1140A2	MOTOR HOLDER GASKET	5	PZ	GN1140A3	MOLDED MOTOR HOLDER GASKET	5	PZ	VM1224A0	65MY 220MM 2 COLOURS SHRINK TUBE	0.200	M				
					Code	Description	Qty	UOM																	
					GN1140A2	MOTOR HOLDER GASKET	5	PZ																	
GN1140A3	MOLDED MOTOR HOLDER GASKET	5	PZ																						
VM1224A0	65MY 220MM 2 COLOURS SHRINK TUBE	0.200	M																						
0H7170A	MM MOTOR GLASS WOOL PLATE		0H7170A0	MM MOTOR GLASS WOOL PLATE																					
GN1660A			KGN1660A	10EU-FS/1021 DOOR GASKET KIT	<table border="1"> <thead> <tr> <th>Code</th> <th>Description</th> <th>Qty</th> <th>UOM</th> </tr> </thead> <tbody> <tr> <td>GN1626A0</td> <td>DOUBLE LIP-TYPE FRONT GASKE</td> <td>3.080</td> <td>M</td> </tr> <tr> <td>SL1025A0</td> <td>CLEAR SILICON DOW CORNING 734</td> <td>0.012</td> <td>PZ</td> </tr> <tr> <td>VM1224A0</td> <td>65MY 220MM 2 COLOURS SHRINK TUBE</td> <td>0.450</td> <td>M</td> </tr> <tr> <td>VM2277A0</td> <td>DOOR SEAL KIT INTERNAL CONNECTION</td> <td>1</td> <td>PZ</td> </tr> </tbody> </table>	Code	Description	Qty	UOM	GN1626A0	DOUBLE LIP-TYPE FRONT GASKE	3.080	M	SL1025A0	CLEAR SILICON DOW CORNING 734	0.012	PZ	VM1224A0	65MY 220MM 2 COLOURS SHRINK TUBE	0.450	M	VM2277A0	DOOR SEAL KIT INTERNAL CONNECTION	1	PZ
					Code	Description	Qty	UOM																	
					GN1626A0	DOUBLE LIP-TYPE FRONT GASKE	3.080	M																	
					SL1025A0	CLEAR SILICON DOW CORNING 734	0.012	PZ																	
VM1224A0	65MY 220MM 2 COLOURS SHRINK TUBE	0.450	M																						
VM2277A0	DOOR SEAL KIT INTERNAL CONNECTION	1	PZ																						
0G1588B	XEBC-10EU-E COMPLETE FAN GUARD		K0G1588B	XEBC-10EU-E COMPLETE FAN GUARD KIT	<table border="1"> <thead> <tr> <th>Code</th> <th>Description</th> <th>Qty</th> <th>UOM</th> </tr> </thead> <tbody> <tr> <td>0G1588B0</td> <td>XEBC-10EU-E COMPLETE FAN GUARD</td> <td>1</td> <td>PZ</td> </tr> <tr> <td>IP1385A1</td> <td>CORNER POLYSTYREN E PACKING 110X80X2000</td> <td>2</td> <td>M</td> </tr> </tbody> </table>	Code	Description	Qty	UOM	0G1588B0	XEBC-10EU-E COMPLETE FAN GUARD	1	PZ	IP1385A1	CORNER POLYSTYREN E PACKING 110X80X2000	2	M								
					Code	Description	Qty	UOM																	
0G1588B0	XEBC-10EU-E COMPLETE FAN GUARD	1	PZ																						
IP1385A1	CORNER POLYSTYREN E PACKING 110X80X2000	2	M																						

COMPONENT			SPARE PART																		
Code	Description	Image	Code	Description	Components list																
TB2989B	10EU/10FS/1021 LOWER WATER PIP		OUTOFPRODUCTIO	ITEM OUT OF PRODUCTION																	
VM2251A	STEAM WATER INLET UPPER DISTRIBUTOR		KVM2251A	STEAM WATER INLET UP+LO DISTRIBUTORS KIT	<table border="1"> <thead> <tr> <th>Code</th> <th>Description</th> <th>Qty</th> <th>UOM</th> </tr> </thead> <tbody> <tr> <td>VM1224A0</td> <td>65MY 220MM 2 COLOURS SHRINK TUBE</td> <td>0.150</td> <td>M</td> </tr> <tr> <td>VM2251A0</td> <td>STEAM WATER INLET UPPER DISTRIBUTOR</td> <td>1</td> <td>PZ</td> </tr> <tr> <td>VM2252A0</td> <td>STEAM WATER INLET LOWER DISTRIBUTOR</td> <td>1</td> <td>PZ</td> </tr> </tbody> </table>	Code	Description	Qty	UOM	VM1224A0	65MY 220MM 2 COLOURS SHRINK TUBE	0.150	M	VM2251A0	STEAM WATER INLET UPPER DISTRIBUTOR	1	PZ	VM2252A0	STEAM WATER INLET LOWER DISTRIBUTOR	1	PZ
Code	Description	Qty	UOM																		
VM1224A0	65MY 220MM 2 COLOURS SHRINK TUBE	0.150	M																		
VM2251A0	STEAM WATER INLET UPPER DISTRIBUTOR	1	PZ																		
VM2252A0	STEAM WATER INLET LOWER DISTRIBUTOR	1	PZ																		
VM2252A	STEAM WATER INLET LOWER DISTRIBUTOR		KVM2251A	STEAM WATER INLET UP+LO DISTRIBUTORS KIT	<table border="1"> <thead> <tr> <th>Code</th> <th>Description</th> <th>Qty</th> <th>UOM</th> </tr> </thead> <tbody> <tr> <td>VM1224A0</td> <td>65MY 220MM 2 COLOURS SHRINK TUBE</td> <td>0.150</td> <td>M</td> </tr> <tr> <td>VM2251A0</td> <td>STEAM WATER INLET UPPER DISTRIBUTOR</td> <td>1</td> <td>PZ</td> </tr> <tr> <td>VM2252A0</td> <td>STEAM WATER INLET LOWER DISTRIBUTOR</td> <td>1</td> <td>PZ</td> </tr> </tbody> </table>	Code	Description	Qty	UOM	VM1224A0	65MY 220MM 2 COLOURS SHRINK TUBE	0.150	M	VM2251A0	STEAM WATER INLET UPPER DISTRIBUTOR	1	PZ	VM2252A0	STEAM WATER INLET LOWER DISTRIBUTOR	1	PZ
Code	Description	Qty	UOM																		
VM1224A0	65MY 220MM 2 COLOURS SHRINK TUBE	0.150	M																		
VM2251A0	STEAM WATER INLET UPPER DISTRIBUTOR	1	PZ																		
VM2252A0	STEAM WATER INLET LOWER DISTRIBUTOR	1	PZ																		
TB2987B	10EU/10FS/1021 3 WAYS WATER PIPE		OUTOFPRODUCTIO	ITEM OUT OF PRODUCTION																	

COMPONENT			SPARE PART																						
Code	Description	Image	Code	Description	Components list																				
VM2332A			KVM2332A	WATER PIPE BUSHING KIT VM2332A0	<table border="1"> <thead> <tr> <th>Code</th> <th>Description</th> <th>Qty</th> <th>UOM</th> </tr> </thead> <tbody> <tr> <td>VM1224A0</td> <td>65MY 220MM 2 COLOURS SHRINK TUBE</td> <td>0.200</td> <td>M</td> </tr> <tr> <td>VM2332A0</td> <td>WATER PIPE BUSHING</td> <td>1</td> <td>PZ</td> </tr> <tr> <td>VM2332A0</td> <td>WATER PIPE BUSHING</td> <td>1</td> <td>PZ</td> </tr> <tr> <td>VM2332A1</td> <td>HUMIDITY PIPES WASHE</td> <td>1</td> <td>PZ</td> </tr> </tbody> </table>	Code	Description	Qty	UOM	VM1224A0	65MY 220MM 2 COLOURS SHRINK TUBE	0.200	M	VM2332A0	WATER PIPE BUSHING	1	PZ	VM2332A0	WATER PIPE BUSHING	1	PZ	VM2332A1	HUMIDITY PIPES WASHE	1	PZ
Code	Description	Qty	UOM																						
VM1224A0	65MY 220MM 2 COLOURS SHRINK TUBE	0.200	M																						
VM2332A0	WATER PIPE BUSHING	1	PZ																						
VM2332A0	WATER PIPE BUSHING	1	PZ																						
VM2332A1	HUMIDITY PIPES WASHE	1	PZ																						
VM2251A	STEAM WATER INLET UPPER DISTRIBUTOR		KVM2251A	STEAM WATER INLET UP+LO DISTRIBUTORS KIT	<table border="1"> <thead> <tr> <th>Code</th> <th>Description</th> <th>Qty</th> <th>UOM</th> </tr> </thead> <tbody> <tr> <td>VM1224A0</td> <td>65MY 220MM 2 COLOURS SHRINK TUBE</td> <td>0.150</td> <td>M</td> </tr> <tr> <td>VM2251A0</td> <td>STEAM WATER INLET UPPER DISTRIBUTOR</td> <td>1</td> <td>PZ</td> </tr> <tr> <td>VM2252A0</td> <td>STEAM WATER INLET LOWER DISTRIBUTOR</td> <td>1</td> <td>PZ</td> </tr> </tbody> </table>	Code	Description	Qty	UOM	VM1224A0	65MY 220MM 2 COLOURS SHRINK TUBE	0.150	M	VM2251A0	STEAM WATER INLET UPPER DISTRIBUTOR	1	PZ	VM2252A0	STEAM WATER INLET LOWER DISTRIBUTOR	1	PZ				
Code	Description	Qty	UOM																						
VM1224A0	65MY 220MM 2 COLOURS SHRINK TUBE	0.150	M																						
VM2251A0	STEAM WATER INLET UPPER DISTRIBUTOR	1	PZ																						
VM2252A0	STEAM WATER INLET LOWER DISTRIBUTOR	1	PZ																						
VM2252A	STEAM WATER INLET LOWER DISTRIBUTOR		KVM2251A	STEAM WATER INLET UP+LO DISTRIBUTORS KIT	<table border="1"> <thead> <tr> <th>Code</th> <th>Description</th> <th>Qty</th> <th>UOM</th> </tr> </thead> <tbody> <tr> <td>VM1224A0</td> <td>65MY 220MM 2 COLOURS SHRINK TUBE</td> <td>0.150</td> <td>M</td> </tr> <tr> <td>VM2251A0</td> <td>STEAM WATER INLET UPPER DISTRIBUTOR</td> <td>1</td> <td>PZ</td> </tr> <tr> <td>VM2252A0</td> <td>STEAM WATER INLET LOWER DISTRIBUTOR</td> <td>1</td> <td>PZ</td> </tr> </tbody> </table>	Code	Description	Qty	UOM	VM1224A0	65MY 220MM 2 COLOURS SHRINK TUBE	0.150	M	VM2251A0	STEAM WATER INLET UPPER DISTRIBUTOR	1	PZ	VM2252A0	STEAM WATER INLET LOWER DISTRIBUTOR	1	PZ				
Code	Description	Qty	UOM																						
VM1224A0	65MY 220MM 2 COLOURS SHRINK TUBE	0.150	M																						
VM2251A0	STEAM WATER INLET UPPER DISTRIBUTOR	1	PZ																						
VM2252A0	STEAM WATER INLET LOWER DISTRIBUTOR	1	PZ																						
TB2985B	10EU/10FS/1021 2 WAYS WATER PIPE		TB2985B0	10EU/10FS/1021 2 WAYS WATER PIPE																					





ASM1772C/0.D01 - External cover

FRONT

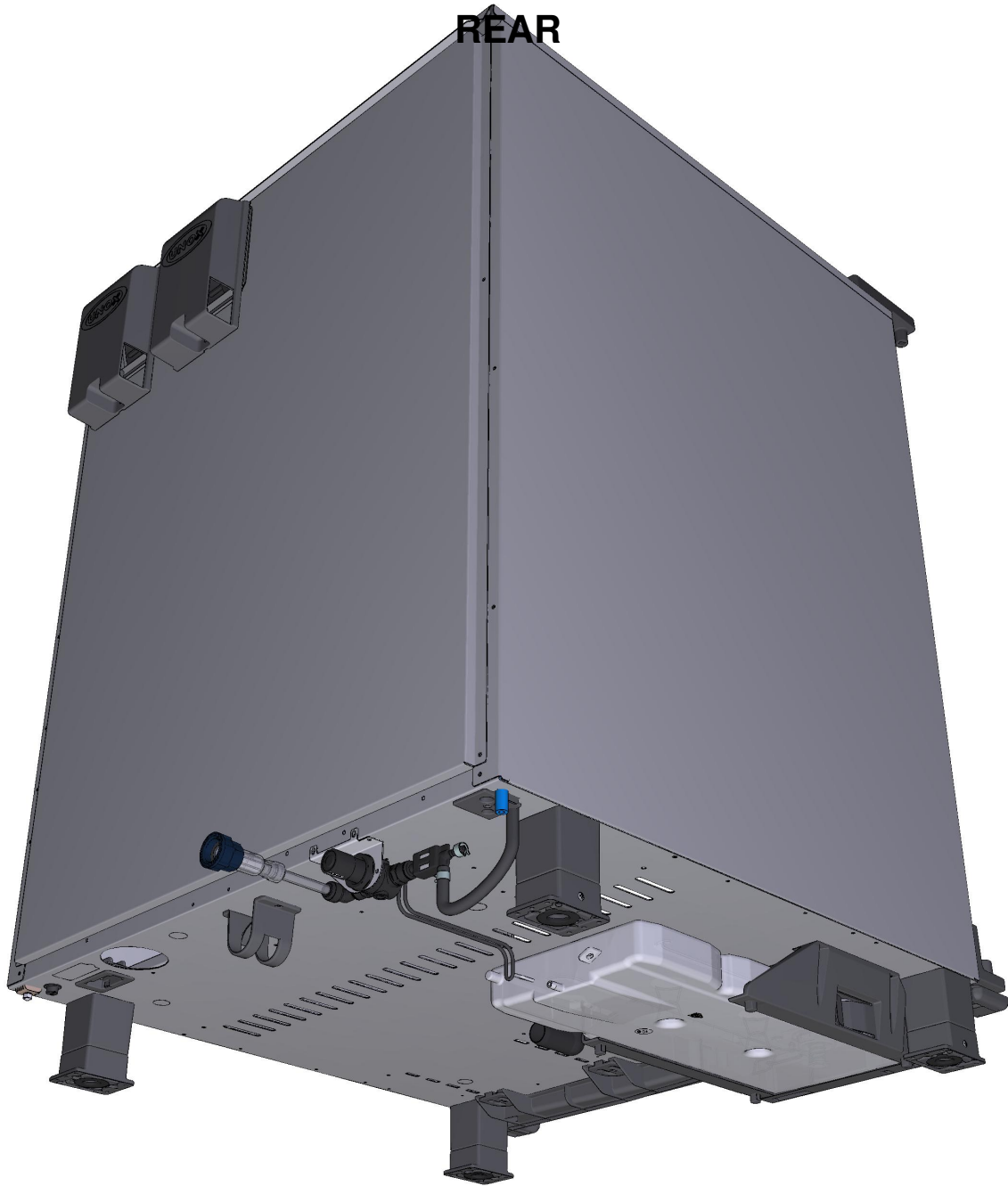

ASM1772C/0.D01 - External cover

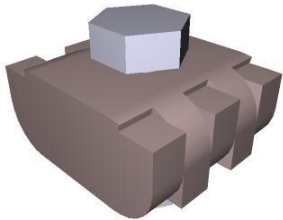



COMPONENT			SPARE PART																						
Code	Description	Image	Code	Description	Components list																				
VM1750A	BRASS COMB CLAM		KVM1750A	COMB TERMINAL BLOCK KIT	<table border="1"> <thead> <tr> <th>Code</th> <th>Description</th> <th>Qty</th> <th>UOM</th> </tr> </thead> <tbody> <tr> <td>VM1224A0</td> <td>65MY 220MM 2 COLOURS SHRINK TUBE</td> <td>0.150</td> <td>M</td> </tr> <tr> <td>VM1750A0</td> <td>BRASS COMB CLAMP</td> <td>1</td> <td>PZ</td> </tr> </tbody> </table>	Code	Description	Qty	UOM	VM1224A0	65MY 220MM 2 COLOURS SHRINK TUBE	0.150	M	VM1750A0	BRASS COMB CLAMP	1	PZ								
Code	Description	Qty	UOM																						
VM1224A0	65MY 220MM 2 COLOURS SHRINK TUBE	0.150	M																						
VM1750A0	BRASS COMB CLAMP	1	PZ																						
VM2074A	DRIP TRAY FIXING CLIP WITH SCREW		KVM1220A	CT/BT DRIP TRAY FIXING CLIPS 4PCS KIT	<table border="1"> <thead> <tr> <th>Code</th> <th>Description</th> <th>Qty</th> <th>UOM</th> </tr> </thead> <tbody> <tr> <td>VI1220A1</td> <td>4,2X12 TCB SELF-TAPPIN G SCREW</td> <td>4</td> <td>PZ</td> </tr> <tr> <td>VM1220A0</td> <td>CLIP TO FIX DRIP TRAY C.T</td> <td>4</td> <td>PZ</td> </tr> <tr> <td>VM1224A0</td> <td>65MY 220MM 2 COLOURS SHRINK TUBE</td> <td>0.250</td> <td>M</td> </tr> <tr> <td>VM2074A0</td> <td>DRIP TRAY FIXING CLIP WITH SCREW</td> <td>4</td> <td>PZ</td> </tr> </tbody> </table>	Code	Description	Qty	UOM	VI1220A1	4,2X12 TCB SELF-TAPPIN G SCREW	4	PZ	VM1220A0	CLIP TO FIX DRIP TRAY C.T	4	PZ	VM1224A0	65MY 220MM 2 COLOURS SHRINK TUBE	0.250	M	VM2074A0	DRIP TRAY FIXING CLIP WITH SCREW	4	PZ
Code	Description	Qty	UOM																						
VI1220A1	4,2X12 TCB SELF-TAPPIN G SCREW	4	PZ																						
VM1220A0	CLIP TO FIX DRIP TRAY C.T	4	PZ																						
VM1224A0	65MY 220MM 2 COLOURS SHRINK TUBE	0.250	M																						
VM2074A0	DRIP TRAY FIXING CLIP WITH SCREW	4	PZ																						
VM2035A	DRAIN PIPE SUPPORT		KVM2035A	DRAIN PIPE SUPPORT 2 PCS. KI	<table border="1"> <thead> <tr> <th>Code</th> <th>Description</th> <th>Qty</th> <th>UOM</th> </tr> </thead> <tbody> <tr> <td>VM1224A0</td> <td>65MY 220MM 2 COLOURS SHRINK TUBE</td> <td>0.250</td> <td>M</td> </tr> <tr> <td>VM2035A0</td> <td>DRAIN PIPE SUPPORT</td> <td>2</td> <td>PZ</td> </tr> </tbody> </table>	Code	Description	Qty	UOM	VM1224A0	65MY 220MM 2 COLOURS SHRINK TUBE	0.250	M	VM2035A0	DRAIN PIPE SUPPORT	2	PZ								
Code	Description	Qty	UOM																						
VM1224A0	65MY 220MM 2 COLOURS SHRINK TUBE	0.250	M																						
VM2035A0	DRAIN PIPE SUPPORT	2	PZ																						
VM2311A	SCREWS COVER		KVM2311A	SCREWS COVER PLATE KIT	<table border="1"> <thead> <tr> <th>Code</th> <th>Description</th> <th>Qty</th> <th>UOM</th> </tr> </thead> <tbody> <tr> <td>VM1224A0</td> <td>65MY 220MM 2 COLOURS SHRINK TUBE</td> <td>0.200</td> <td>M</td> </tr> <tr> <td>VM2311A0</td> <td>SCREWS COVER</td> <td>1</td> <td>PZ</td> </tr> </tbody> </table>	Code	Description	Qty	UOM	VM1224A0	65MY 220MM 2 COLOURS SHRINK TUBE	0.200	M	VM2311A0	SCREWS COVER	1	PZ								
Code	Description	Qty	UOM																						
VM1224A0	65MY 220MM 2 COLOURS SHRINK TUBE	0.200	M																						
VM2311A0	SCREWS COVER	1	PZ																						
GN1558A	EXHAUST SEAL		K0H7291A	GASKET AND SEALING DISC CHIMNEY KIT	<table border="1"> <thead> <tr> <th>Code</th> <th>Description</th> <th>Qty</th> <th>UOM</th> </tr> </thead> <tbody> <tr> <td>0H7291A0</td> <td>CHIMNEY HOLDING DIS</td> <td>1</td> <td>PZ</td> </tr> <tr> <td>GN1558A0</td> <td>EXHAUST SEA</td> <td>1</td> <td>PZ</td> </tr> <tr> <td>VM1224A0</td> <td>65MY 220MM 2 COLOURS SHRINK TUBE</td> <td>0.200</td> <td>M</td> </tr> </tbody> </table>	Code	Description	Qty	UOM	0H7291A0	CHIMNEY HOLDING DIS	1	PZ	GN1558A0	EXHAUST SEA	1	PZ	VM1224A0	65MY 220MM 2 COLOURS SHRINK TUBE	0.200	M				
Code	Description	Qty	UOM																						
0H7291A0	CHIMNEY HOLDING DIS	1	PZ																						
GN1558A0	EXHAUST SEA	1	PZ																						
VM1224A0	65MY 220MM 2 COLOURS SHRINK TUBE	0.200	M																						



COMPONENT			SPARE PART																										
Code	Description	Image	Code	Description	Components list																								
0H7291A	CHIMNEY HOLDING DISC		K0H7291A	GASKET AND SEALING DISC CHIMNEY KIT	<table border="1"> <thead> <tr> <th>Code</th> <th>Description</th> <th>Qty</th> <th>UOM</th> </tr> </thead> <tbody> <tr> <td>0H7291A0</td> <td>CHIMNEY HOLDING DISC</td> <td>1</td> <td>PZ</td> </tr> <tr> <td>GN1558A0</td> <td>EXHAUST SEA</td> <td>1</td> <td>PZ</td> </tr> <tr> <td>VM1224A0</td> <td>65MY 220MM 2 COLOURS SHRINK TUBE</td> <td>0.200</td> <td>M</td> </tr> </tbody> </table>	Code	Description	Qty	UOM	0H7291A0	CHIMNEY HOLDING DISC	1	PZ	GN1558A0	EXHAUST SEA	1	PZ	VM1224A0	65MY 220MM 2 COLOURS SHRINK TUBE	0.200	M								
Code	Description	Qty	UOM																										
0H7291A0	CHIMNEY HOLDING DISC	1	PZ																										
GN1558A0	EXHAUST SEA	1	PZ																										
VM1224A0	65MY 220MM 2 COLOURS SHRINK TUBE	0.200	M																										
VM1992A	E SERIES BAKERTOP DRIP TRAY		KVM1992A	E SERIES BAKERTOP DRIP TRAY	<table border="1"> <thead> <tr> <th>Code</th> <th>Description</th> <th>Qty</th> <th>UOM</th> </tr> </thead> <tbody> <tr> <td>VM1220A0</td> <td>CLIP TO FIX DRIP TRAY C.T</td> <td>4</td> <td>PZ</td> </tr> <tr> <td>VM1794A0</td> <td>250X4.8 PA66 BLACK CLAMP</td> <td>2</td> <td>PZ</td> </tr> <tr> <td>VM1992A0</td> <td>E SERIES BAKERTOP DRIP TRAY</td> <td>1</td> <td>PZ</td> </tr> <tr> <td>VM2074A0</td> <td>DRIP TRAY FIXING CLIP WITH SCREW</td> <td>4</td> <td>PZ</td> </tr> <tr> <td>VM2103A0</td> <td>CLAMP LOCK</td> <td>2</td> <td>PZ</td> </tr> </tbody> </table>	Code	Description	Qty	UOM	VM1220A0	CLIP TO FIX DRIP TRAY C.T	4	PZ	VM1794A0	250X4.8 PA66 BLACK CLAMP	2	PZ	VM1992A0	E SERIES BAKERTOP DRIP TRAY	1	PZ	VM2074A0	DRIP TRAY FIXING CLIP WITH SCREW	4	PZ	VM2103A0	CLAMP LOCK	2	PZ
Code	Description	Qty	UOM																										
VM1220A0	CLIP TO FIX DRIP TRAY C.T	4	PZ																										
VM1794A0	250X4.8 PA66 BLACK CLAMP	2	PZ																										
VM1992A0	E SERIES BAKERTOP DRIP TRAY	1	PZ																										
VM2074A0	DRIP TRAY FIXING CLIP WITH SCREW	4	PZ																										
VM2103A0	CLAMP LOCK	2	PZ																										
0H2561A	6 S. DOOR COUNTERBRACKET		0H2561A0	6 S. DOOR COUNTERBRACKET																									
V11995A	M5X25 ST.STEEL SCREW		V11995A0	M5X25 ST.STEEL SCREW																									
VM2352A	MM LOWER DOOR BRACKET LEFT SCREW COVERI		VM2352A0	MM LOWER DOOR BRACKET LEFT SCREW COVERI																									



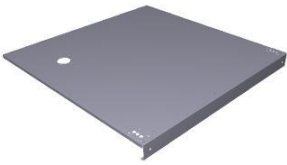

COMPONENT			SPARE PART																																						
Code	Description	Image	Code	Description	Components list																																				
VM2353A	MM LOWER DOOR BRACKET RIGHT SCREW COVERI		VM2353A0	MM LOWER DOOR BRACKET RIGHT SCREW COVERI																																					
VM1240A	NYLON SUPPORT CAP		KVM1240A	4 PCS COUNTER BRACKET SUPPORT CAP KIT	<table border="1"> <thead> <tr> <th>Code</th> <th>Description</th> <th>Qty</th> <th>UOM</th> </tr> </thead> <tbody> <tr> <td>VM1224A0</td> <td>65MY 220MM 2 COLOURS SHRINK TUBE</td> <td>0.200</td> <td>M</td> </tr> <tr> <td>VM1240A0</td> <td>NYLON SUPPORT CAP</td> <td>4</td> <td>PZ</td> </tr> </tbody> </table>	Code	Description	Qty	UOM	VM1224A0	65MY 220MM 2 COLOURS SHRINK TUBE	0.200	M	VM1240A0	NYLON SUPPORT CAP	4	PZ																								
Code	Description	Qty	UOM																																						
VM1224A0	65MY 220MM 2 COLOURS SHRINK TUBE	0.200	M																																						
VM1240A0	NYLON SUPPORT CAP	4	PZ																																						
VM2273A	MM DOOR LEFT LOWER BRACKET		KVM2273A	MIND.MAPS DOOR LOWER LEFT BRACKET KIT	<table border="1"> <thead> <tr> <th>Code</th> <th>Description</th> <th>Qty</th> <th>UOM</th> </tr> </thead> <tbody> <tr> <td>0H7330A0</td> <td>DOOR LOWER BRACKET WASHER</td> <td>2</td> <td>PZ</td> </tr> <tr> <td>VI1995A0</td> <td>M5X25 ST.STEEL SCREW</td> <td>4</td> <td>PZ</td> </tr> <tr> <td>VM1224A0</td> <td>65MY 220MM 2 COLOURS SHRINK TUBE</td> <td>0.300</td> <td>M</td> </tr> <tr> <td>VM2273A1</td> <td>MM DOOR LEFT LOWER BRACKET</td> <td>1</td> <td>PZ</td> </tr> <tr> <td>VM2352A0</td> <td>MM LOWER DOOR BRACKET LEFT SCREW COVERI</td> <td>1</td> <td>PZ</td> </tr> <tr> <td>VM2352A0</td> <td>MM LOWER DOOR BRACKET LEFT SCREW COVERI</td> <td>1</td> <td>PZ</td> </tr> <tr> <td>VM2353A0</td> <td>MM LOWER DOOR BRACKET RIGHT SCREW COVERI</td> <td>1</td> <td>PZ</td> </tr> <tr> <td>VM2353A0</td> <td>MM LOWER DOOR BRACKET RIGHT SCREW COVERI</td> <td>1</td> <td>PZ</td> </tr> </tbody> </table>	Code	Description	Qty	UOM	0H7330A0	DOOR LOWER BRACKET WASHER	2	PZ	VI1995A0	M5X25 ST.STEEL SCREW	4	PZ	VM1224A0	65MY 220MM 2 COLOURS SHRINK TUBE	0.300	M	VM2273A1	MM DOOR LEFT LOWER BRACKET	1	PZ	VM2352A0	MM LOWER DOOR BRACKET LEFT SCREW COVERI	1	PZ	VM2352A0	MM LOWER DOOR BRACKET LEFT SCREW COVERI	1	PZ	VM2353A0	MM LOWER DOOR BRACKET RIGHT SCREW COVERI	1	PZ	VM2353A0	MM LOWER DOOR BRACKET RIGHT SCREW COVERI	1	PZ
Code	Description	Qty	UOM																																						
0H7330A0	DOOR LOWER BRACKET WASHER	2	PZ																																						
VI1995A0	M5X25 ST.STEEL SCREW	4	PZ																																						
VM1224A0	65MY 220MM 2 COLOURS SHRINK TUBE	0.300	M																																						
VM2273A1	MM DOOR LEFT LOWER BRACKET	1	PZ																																						
VM2352A0	MM LOWER DOOR BRACKET LEFT SCREW COVERI	1	PZ																																						
VM2352A0	MM LOWER DOOR BRACKET LEFT SCREW COVERI	1	PZ																																						
VM2353A0	MM LOWER DOOR BRACKET RIGHT SCREW COVERI	1	PZ																																						
VM2353A0	MM LOWER DOOR BRACKET RIGHT SCREW COVERI	1	PZ																																						



COMPONENT			SPARE PART																										
Code	Description	Image	Code	Description	Components list																								
PD1074A	H=100 SQUARE FOO		KPD1074A	MIND.MAPS H100 FOOT KIT	<table border="1"> <thead> <tr> <th>Code</th> <th>Description</th> <th>Qty</th> <th>UOM</th> </tr> </thead> <tbody> <tr> <td>PD1074A0</td> <td>H=100 SQUARE FOO</td> <td>1</td> <td>PZ</td> </tr> <tr> <td>PD1075A0</td> <td>FOOT LOCKING BRACKET</td> <td>1</td> <td>PZ</td> </tr> <tr> <td>PD1075A1</td> <td>PD1074 FOOT LOCKING BRACKET</td> <td>1</td> <td>PZ</td> </tr> <tr> <td>VI1220A1</td> <td>4,2X12 TCB SELF-TAPPIN G SCREW</td> <td>5</td> <td>PZ</td> </tr> <tr> <td>VM1224A0</td> <td>65MY 220MM 2 COLOURS SHRINK TUBE</td> <td>0.300</td> <td>M</td> </tr> </tbody> </table>	Code	Description	Qty	UOM	PD1074A0	H=100 SQUARE FOO	1	PZ	PD1075A0	FOOT LOCKING BRACKET	1	PZ	PD1075A1	PD1074 FOOT LOCKING BRACKET	1	PZ	VI1220A1	4,2X12 TCB SELF-TAPPIN G SCREW	5	PZ	VM1224A0	65MY 220MM 2 COLOURS SHRINK TUBE	0.300	M
Code	Description	Qty	UOM																										
PD1074A0	H=100 SQUARE FOO	1	PZ																										
PD1075A0	FOOT LOCKING BRACKET	1	PZ																										
PD1075A1	PD1074 FOOT LOCKING BRACKET	1	PZ																										
VI1220A1	4,2X12 TCB SELF-TAPPIN G SCREW	5	PZ																										
VM1224A0	65MY 220MM 2 COLOURS SHRINK TUBE	0.300	M																										
PD1075A	PD1074 FOOT LOCKING BRACKET		KPD1075A	OVEN FOOT STOPPING BRACKET KIT	<table border="1"> <thead> <tr> <th>Code</th> <th>Description</th> <th>Qty</th> <th>UOM</th> </tr> </thead> <tbody> <tr> <td>PD1075A0</td> <td>FOOT LOCKING BRACKET</td> <td>4</td> <td>PZ</td> </tr> <tr> <td>PD1075A1</td> <td>PD1074 FOOT LOCKING BRACKET</td> <td>4</td> <td>PZ</td> </tr> <tr> <td>VI1950A0</td> <td>ST. STEEL 4,2X13 TCB SELF-DRILLIN G SCREW</td> <td>8</td> <td>PZ</td> </tr> </tbody> </table>	Code	Description	Qty	UOM	PD1075A0	FOOT LOCKING BRACKET	4	PZ	PD1075A1	PD1074 FOOT LOCKING BRACKET	4	PZ	VI1950A0	ST. STEEL 4,2X13 TCB SELF-DRILLIN G SCREW	8	PZ								
Code	Description	Qty	UOM																										
PD1075A0	FOOT LOCKING BRACKET	4	PZ																										
PD1075A1	PD1074 FOOT LOCKING BRACKET	4	PZ																										
VI1950A0	ST. STEEL 4,2X13 TCB SELF-DRILLIN G SCREW	8	PZ																										
VM2450A	THROUGH-WALL CONNECTION 3 PIPES		KVM2450A	3 PIPES THROUGH-WALL CONNECTION KIT	<table border="1"> <thead> <tr> <th>Code</th> <th>Description</th> <th>Qty</th> <th>UOM</th> </tr> </thead> <tbody> <tr> <td>VM1224A0</td> <td>65MY 220MM 2 COLOURS SHRINK TUBE</td> <td>0.200</td> <td>M</td> </tr> <tr> <td>VM2450A0</td> <td>THROUGH-WAL L CONNECTION 3 PIPES</td> <td>1</td> <td>PZ</td> </tr> <tr> <td>VM2450A0</td> <td>THROUGH-WAL L CONNECTION 3 PIPES</td> <td>1</td> <td>PZ</td> </tr> </tbody> </table>	Code	Description	Qty	UOM	VM1224A0	65MY 220MM 2 COLOURS SHRINK TUBE	0.200	M	VM2450A0	THROUGH-WAL L CONNECTION 3 PIPES	1	PZ	VM2450A0	THROUGH-WAL L CONNECTION 3 PIPES	1	PZ								
Code	Description	Qty	UOM																										
VM1224A0	65MY 220MM 2 COLOURS SHRINK TUBE	0.200	M																										
VM2450A0	THROUGH-WAL L CONNECTION 3 PIPES	1	PZ																										
VM2450A0	THROUGH-WAL L CONNECTION 3 PIPES	1	PZ																										
0D2305B	XEBC-04EU-E EXTERNAL TOP COVER		0D2305B1	XEBC-04EU-E EXTERNAL TOP COVER																									





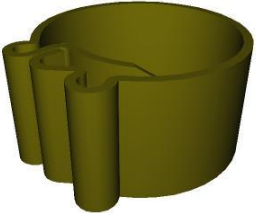



COMPONENT			SPARE PART														
Code	Description	Image	Code	Description	Components list												
0E1351C	XEBC EXTERNAL BOTTOM PANEL		0E1351C0	XEBC EXTERNAL BOTTOM PANEL													
VM2249A	COOKING CHAMBER FRONT CORNER		KVM2249A	CHAMBER FRONT PROFILE CORNER KIT	<table border="1"> <thead> <tr> <th>Code</th> <th>Description</th> <th>Qty</th> <th>UOM</th> </tr> </thead> <tbody> <tr> <td>VM1224A0</td> <td>65MY 220MM 2 COLOURS SHRINK TUBE</td> <td>0.150</td> <td>M</td> </tr> <tr> <td>VM2249A0</td> <td>COOKING CHAMBER FRONT CORNER</td> <td>1</td> <td>PZ</td> </tr> </tbody> </table>	Code	Description	Qty	UOM	VM1224A0	65MY 220MM 2 COLOURS SHRINK TUBE	0.150	M	VM2249A0	COOKING CHAMBER FRONT CORNER	1	PZ
Code	Description	Qty	UOM														
VM1224A0	65MY 220MM 2 COLOURS SHRINK TUBE	0.150	M														
VM2249A0	COOKING CHAMBER FRONT CORNER	1	PZ														
0F1505B	XEBC-10EU-E EXTERNAL BACK PANEL		0F1505B0	XEBC-10EU-E EXTERNAL BACK PANEL													
VM1118A	DET&RINSE PLUS TANK LEFT GUIDE		KVM1118A	DET&RINSE TANK LEFT GUIDE KIT FOR MM	<table border="1"> <thead> <tr> <th>Code</th> <th>Description</th> <th>Qty</th> <th>UOM</th> </tr> </thead> <tbody> <tr> <td>VI1220A1</td> <td>4,2X12 TCB SELF-TAPPIN G SCREW</td> <td>2</td> <td>PZ</td> </tr> <tr> <td>VM1118A0</td> <td>DET&RINSE PLUS TANK LEFT GUIDE</td> <td>1</td> <td>PZ</td> </tr> </tbody> </table>	Code	Description	Qty	UOM	VI1220A1	4,2X12 TCB SELF-TAPPIN G SCREW	2	PZ	VM1118A0	DET&RINSE PLUS TANK LEFT GUIDE	1	PZ
Code	Description	Qty	UOM														
VI1220A1	4,2X12 TCB SELF-TAPPIN G SCREW	2	PZ														
VM1118A0	DET&RINSE PLUS TANK LEFT GUIDE	1	PZ														
VM1119A	DET&RINSE PLUS TANK RIGHT GUIDE		KVM1119A	DET&RINSE TANK RIGHT GUIDE KIT FOR MM	<table border="1"> <thead> <tr> <th>Code</th> <th>Description</th> <th>Qty</th> <th>UOM</th> </tr> </thead> <tbody> <tr> <td>VI1220A1</td> <td>4,2X12 TCB SELF-TAPPIN G SCREW</td> <td>2</td> <td>PZ</td> </tr> <tr> <td>VM1119A0</td> <td>DET&RINSE PLUS TANK RIGHT GUIDE</td> <td>1</td> <td>PZ</td> </tr> </tbody> </table>	Code	Description	Qty	UOM	VI1220A1	4,2X12 TCB SELF-TAPPIN G SCREW	2	PZ	VM1119A0	DET&RINSE PLUS TANK RIGHT GUIDE	1	PZ
Code	Description	Qty	UOM														
VI1220A1	4,2X12 TCB SELF-TAPPIN G SCREW	2	PZ														
VM1119A0	DET&RINSE PLUS TANK RIGHT GUIDE	1	PZ														

COMPONENT			SPARE PART																										
Code	Description	Image	Code	Description	Components list																								
SB1015A	4L DETERGENT TAN		KSB1015A	4L DETERGENT TANK KIT	<table border="1"> <thead> <tr> <th>Code</th> <th>Description</th> <th>Qty</th> <th>UOM</th> </tr> </thead> <tbody> <tr> <td>IP1385A1</td> <td>CORNER POLYSTYREN E PACKING 110X80X2000</td> <td>1.200</td> <td>M</td> </tr> <tr> <td>IP1410A0</td> <td>POLYSTYREN E PACKING TO PROTECT</td> <td>2</td> <td>PZ</td> </tr> <tr> <td>SB1015A2</td> <td>4L DETERGENT TANK</td> <td>1</td> <td>PZ</td> </tr> <tr> <td>VM1059A1</td> <td>HEAT SHRINK FILM H800</td> <td>1.200</td> <td>M</td> </tr> </tbody> </table>	Code	Description	Qty	UOM	IP1385A1	CORNER POLYSTYREN E PACKING 110X80X2000	1.200	M	IP1410A0	POLYSTYREN E PACKING TO PROTECT	2	PZ	SB1015A2	4L DETERGENT TANK	1	PZ	VM1059A1	HEAT SHRINK FILM H800	1.200	M				
					Code	Description	Qty	UOM																					
					IP1385A1	CORNER POLYSTYREN E PACKING 110X80X2000	1.200	M																					
					IP1410A0	POLYSTYREN E PACKING TO PROTECT	2	PZ																					
SB1015A2	4L DETERGENT TANK	1	PZ																										
VM1059A1	HEAT SHRINK FILM H800	1.200	M																										
VL1026A	BEND FOR DRAIN PIPE		KVL1026A	DRAIN PIPE BEND KI	<table border="1"> <thead> <tr> <th>Code</th> <th>Description</th> <th>Qty</th> <th>UOM</th> </tr> </thead> <tbody> <tr> <td>GN1400A0</td> <td>U-TRAP SEAL</td> <td>1</td> <td>PZ</td> </tr> <tr> <td>VL1026A0</td> <td>BEND FOR DRAIN PIPE</td> <td>1</td> <td>PZ</td> </tr> <tr> <td>VM1224A0</td> <td>65MY 220MM COLOURS SHRINK TUBE</td> <td>2 0.300</td> <td>M</td> </tr> <tr> <td>VM2039A0</td> <td>DRAIN BEND FIXING RING</td> <td>1</td> <td>PZ</td> </tr> </tbody> </table>	Code	Description	Qty	UOM	GN1400A0	U-TRAP SEAL	1	PZ	VL1026A0	BEND FOR DRAIN PIPE	1	PZ	VM1224A0	65MY 220MM COLOURS SHRINK TUBE	2 0.300	M	VM2039A0	DRAIN BEND FIXING RING	1	PZ				
					Code	Description	Qty	UOM																					
					GN1400A0	U-TRAP SEAL	1	PZ																					
					VL1026A0	BEND FOR DRAIN PIPE	1	PZ																					
VM1224A0	65MY 220MM COLOURS SHRINK TUBE	2 0.300	M																										
VM2039A0	DRAIN BEND FIXING RING	1	PZ																										
VM2039A	DRAIN BEND FIXING RING		KVL1026A	DRAIN PIPE BEND KI	<table border="1"> <thead> <tr> <th>Code</th> <th>Description</th> <th>Qty</th> <th>UOM</th> </tr> </thead> <tbody> <tr> <td>GN1400A0</td> <td>U-TRAP SEAL</td> <td>1</td> <td>PZ</td> </tr> <tr> <td>VL1026A0</td> <td>BEND FOR DRAIN PIPE</td> <td>1</td> <td>PZ</td> </tr> <tr> <td>VM1224A0</td> <td>65MY 220MM COLOURS SHRINK TUBE</td> <td>2 0.300</td> <td>M</td> </tr> <tr> <td>VM2039A0</td> <td>DRAIN BEND FIXING RING</td> <td>1</td> <td>PZ</td> </tr> </tbody> </table>	Code	Description	Qty	UOM	GN1400A0	U-TRAP SEAL	1	PZ	VL1026A0	BEND FOR DRAIN PIPE	1	PZ	VM1224A0	65MY 220MM COLOURS SHRINK TUBE	2 0.300	M	VM2039A0	DRAIN BEND FIXING RING	1	PZ				
					Code	Description	Qty	UOM																					
					GN1400A0	U-TRAP SEAL	1	PZ																					
					VL1026A0	BEND FOR DRAIN PIPE	1	PZ																					
VM1224A0	65MY 220MM COLOURS SHRINK TUBE	2 0.300	M																										
VM2039A0	DRAIN BEND FIXING RING	1	PZ																										
VN1165A	230VAC 50/60HZ COOLING DOWN FA		KVN1165A	S.5E ADVANCE/MM 230V COOLING FAN KIT	<table border="1"> <thead> <tr> <th>Code</th> <th>Description</th> <th>Qty</th> <th>UOM</th> </tr> </thead> <tbody> <tr> <td>MOV0017A0</td> <td>HOOD RING GASKET GN1110A2</td> <td>0.100</td> <td>PZ</td> </tr> <tr> <td>VI1099A0</td> <td>SELF-DRILLIN G SCREW 4.8X13 TCB+ Z</td> <td>4</td> <td>PZ</td> </tr> <tr> <td>VM1555A2</td> <td>CT BT COOLING FAN SUPPORT</td> <td>1</td> <td>PZ</td> </tr> <tr> <td>VN1165A0</td> <td>230VAC 50/60HZ COOLING DOWN FAN</td> <td>1</td> <td>PZ</td> </tr> <tr> <td>VN1165A0</td> <td>230VAC 50/60HZ COOLING DOWN FAN</td> <td>1</td> <td>PZ</td> </tr> </tbody> </table>	Code	Description	Qty	UOM	MOV0017A0	HOOD RING GASKET GN1110A2	0.100	PZ	VI1099A0	SELF-DRILLIN G SCREW 4.8X13 TCB+ Z	4	PZ	VM1555A2	CT BT COOLING FAN SUPPORT	1	PZ	VN1165A0	230VAC 50/60HZ COOLING DOWN FAN	1	PZ	VN1165A0	230VAC 50/60HZ COOLING DOWN FAN	1	PZ
					Code	Description	Qty	UOM																					
					MOV0017A0	HOOD RING GASKET GN1110A2	0.100	PZ																					
					VI1099A0	SELF-DRILLIN G SCREW 4.8X13 TCB+ Z	4	PZ																					
					VM1555A2	CT BT COOLING FAN SUPPORT	1	PZ																					
VN1165A0	230VAC 50/60HZ COOLING DOWN FAN	1	PZ																										
VN1165A0	230VAC 50/60HZ COOLING DOWN FAN	1	PZ																										

COMPONENT			SPARE PART																										
Code	Description	Image	Code	Description	Components list																								
VM1555A	CT BT COOLING FAN SUPPORT		KVN1165A	S.5E ADVANCE/MM 230V COOLING FAN KIT	<table border="1"> <thead> <tr> <th>Code</th> <th>Description</th> <th>Qty</th> <th>UOM</th> </tr> </thead> <tbody> <tr> <td>MOV0017A0</td> <td>HOOD RING GASKET GN1110A2</td> <td>0.100</td> <td>PZ</td> </tr> <tr> <td>VI1099A0</td> <td>SELF-DRILLIN G SCREW 4.8X13 TCB+ Z</td> <td>4</td> <td>PZ</td> </tr> <tr> <td>VM1555A2</td> <td>CT BT COOLING FAN SUPPORT</td> <td>1</td> <td>PZ</td> </tr> <tr> <td>VN1165A0</td> <td>230VAC 50/60HZ COOLING DOWN FAN</td> <td>1</td> <td>PZ</td> </tr> <tr> <td>VN1165A0</td> <td>230VAC 50/60HZ COOLING DOWN FAN</td> <td>1</td> <td>PZ</td> </tr> </tbody> </table>	Code	Description	Qty	UOM	MOV0017A0	HOOD RING GASKET GN1110A2	0.100	PZ	VI1099A0	SELF-DRILLIN G SCREW 4.8X13 TCB+ Z	4	PZ	VM1555A2	CT BT COOLING FAN SUPPORT	1	PZ	VN1165A0	230VAC 50/60HZ COOLING DOWN FAN	1	PZ	VN1165A0	230VAC 50/60HZ COOLING DOWN FAN	1	PZ
			Code	Description	Qty	UOM																							
MOV0017A0	HOOD RING GASKET GN1110A2	0.100	PZ																										
VI1099A0	SELF-DRILLIN G SCREW 4.8X13 TCB+ Z	4	PZ																										
VM1555A2	CT BT COOLING FAN SUPPORT	1	PZ																										
VN1165A0	230VAC 50/60HZ COOLING DOWN FAN	1	PZ																										
VN1165A0	230VAC 50/60HZ COOLING DOWN FAN	1	PZ																										
KVN1164A	S.5/5E 12VDC COOLING DOWN FAN KIT	<table border="1"> <thead> <tr> <th>Code</th> <th>Description</th> <th>Qty</th> <th>UOM</th> </tr> </thead> <tbody> <tr> <td>VI1099A0</td> <td>SELF-DRILLIN G SCREW 4.8X13 TCB+ Z</td> <td>4</td> <td>PZ</td> </tr> <tr> <td>VM1555A2</td> <td>CT BT COOLING FAN SUPPORT</td> <td>1</td> <td>PZ</td> </tr> <tr> <td>VN1164A0</td> <td>12VDC COOLING DONW FAN</td> <td>1</td> <td>PZ</td> </tr> <tr> <td>VN1164A0</td> <td>12VDC COOLING DONW FAN</td> <td>1</td> <td>PZ</td> </tr> </tbody> </table>	Code	Description	Qty	UOM	VI1099A0	SELF-DRILLIN G SCREW 4.8X13 TCB+ Z	4	PZ	VM1555A2	CT BT COOLING FAN SUPPORT	1	PZ	VN1164A0	12VDC COOLING DONW FAN	1	PZ	VN1164A0	12VDC COOLING DONW FAN	1	PZ							
Code	Description	Qty	UOM																										
VI1099A0	SELF-DRILLIN G SCREW 4.8X13 TCB+ Z	4	PZ																										
VM1555A2	CT BT COOLING FAN SUPPORT	1	PZ																										
VN1164A0	12VDC COOLING DONW FAN	1	PZ																										
VN1164A0	12VDC COOLING DONW FAN	1	PZ																										
VM1556A	XBC-XVC COOLING FAN GUARD		KVM1556A	XBC-XVC COOLING FAN GUARD KIT	<table border="1"> <thead> <tr> <th>Code</th> <th>Description</th> <th>Qty</th> <th>UOM</th> </tr> </thead> <tbody> <tr> <td>VM1556A0</td> <td>XBC-XVC COOLING FAN GUARD</td> <td>1</td> <td>PZ</td> </tr> </tbody> </table>	Code	Description	Qty	UOM	VM1556A0	XBC-XVC COOLING FAN GUARD	1	PZ																
Code	Description	Qty	UOM																										
VM1556A0	XBC-XVC COOLING FAN GUARD	1	PZ																										
RC1414A	D12 HOSE CLAMP		RC1414A0	D12 HOSE CLAMP																									

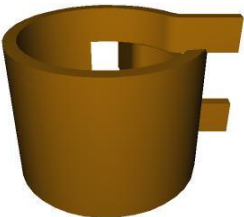
COMPONENT			SPARE PART																																														
Code	Description	Image	Code	Description	Components list																																												
TB3234A			TB3234A0																																														
EL1431B	BARBED 9+38 STEAM SOLENOID VALVE		KEL1431B	9+38 JG D8-D10 STEAM SOLENOID VALVE KIT	<table border="1"> <thead> <tr> <th>Code</th> <th>Description</th> <th>Qty</th> <th>UOM</th> </tr> </thead> <tbody> <tr> <td>EL1431B0</td> <td>BARBED 9+38 STEAM SOLENOID VALVE</td> <td>1</td> <td>PZ</td> </tr> <tr> <td>RC1018A0</td> <td>ZINC PLATED D12 ELASTIC CLAMP</td> <td>2</td> <td>PZ</td> </tr> <tr> <td>VM1224A0</td> <td>65MY 220MM 2 COLOURS SHRINK TUBE</td> <td>0.250</td> <td>M</td> </tr> </tbody> </table>	Code	Description	Qty	UOM	EL1431B0	BARBED 9+38 STEAM SOLENOID VALVE	1	PZ	RC1018A0	ZINC PLATED D12 ELASTIC CLAMP	2	PZ	VM1224A0	65MY 220MM 2 COLOURS SHRINK TUBE	0.250	M																												
Code	Description	Qty	UOM																																														
EL1431B0	BARBED 9+38 STEAM SOLENOID VALVE	1	PZ																																														
RC1018A0	ZINC PLATED D12 ELASTIC CLAMP	2	PZ																																														
VM1224A0	65MY 220MM 2 COLOURS SHRINK TUBE	0.250	M																																														
VL1183A			KVL1101A	EUR 1 ROTOR ARM PLUS CLEANING SYSTEM KIT	<table border="1"> <thead> <tr> <th>Code</th> <th>Description</th> <th>Qty</th> <th>UOM</th> </tr> </thead> <tbody> <tr> <td>0H2143A0</td> <td>LAMIERA BLOCCA VNR VL1128</td> <td>1</td> <td>PZ</td> </tr> <tr> <td>0H7820A0</td> <td>PLUS WASHING SY SUPPORT WITH STEAM VALVE</td> <td>1</td> <td>PZ</td> </tr> <tr> <td>EL1252A1</td> <td>1 WAY WATER VALVE + J.G. CONNECTION</td> <td>1</td> <td>PZ</td> </tr> <tr> <td>EL1424A0</td> <td>D8 CONNECTION WATER SOLENOID VALVE</td> <td>1</td> <td>PZ</td> </tr> <tr> <td>EL1424B0</td> <td>JG D8- D6 PIPE HOLDER WATER SOLENOID</td> <td>1</td> <td>PZ</td> </tr> <tr> <td>EL1436A0</td> <td>H2O SOLENOID JG D8 CHECK VALVE</td> <td>1</td> <td>PZ</td> </tr> <tr> <td>EL1436B0</td> <td>JG D8-BARBED D6 NRV WATER SOLENOID</td> <td>1</td> <td>PZ</td> </tr> <tr> <td>GN1526A0</td> <td>INT. D.=6.9 TH=1.8 O-RIN</td> <td>1</td> <td>PZ</td> </tr> <tr> <td>RC1019A0</td> <td>D=10 ELASTIC CLAMP</td> <td>12</td> <td>PZ</td> </tr> <tr> <td>RC1130A0</td> <td>130X2,6 CLAM</td> <td>1</td> <td>PZ</td> </tr> </tbody> </table>	Code	Description	Qty	UOM	0H2143A0	LAMIERA BLOCCA VNR VL1128	1	PZ	0H7820A0	PLUS WASHING SY SUPPORT WITH STEAM VALVE	1	PZ	EL1252A1	1 WAY WATER VALVE + J.G. CONNECTION	1	PZ	EL1424A0	D8 CONNECTION WATER SOLENOID VALVE	1	PZ	EL1424B0	JG D8- D6 PIPE HOLDER WATER SOLENOID	1	PZ	EL1436A0	H2O SOLENOID JG D8 CHECK VALVE	1	PZ	EL1436B0	JG D8-BARBED D6 NRV WATER SOLENOID	1	PZ	GN1526A0	INT. D.=6.9 TH=1.8 O-RIN	1	PZ	RC1019A0	D=10 ELASTIC CLAMP	12	PZ	RC1130A0	130X2,6 CLAM	1	PZ
Code	Description	Qty	UOM																																														
0H2143A0	LAMIERA BLOCCA VNR VL1128	1	PZ																																														
0H7820A0	PLUS WASHING SY SUPPORT WITH STEAM VALVE	1	PZ																																														
EL1252A1	1 WAY WATER VALVE + J.G. CONNECTION	1	PZ																																														
EL1424A0	D8 CONNECTION WATER SOLENOID VALVE	1	PZ																																														
EL1424B0	JG D8- D6 PIPE HOLDER WATER SOLENOID	1	PZ																																														
EL1436A0	H2O SOLENOID JG D8 CHECK VALVE	1	PZ																																														
EL1436B0	JG D8-BARBED D6 NRV WATER SOLENOID	1	PZ																																														
GN1526A0	INT. D.=6.9 TH=1.8 O-RIN	1	PZ																																														
RC1019A0	D=10 ELASTIC CLAMP	12	PZ																																														
RC1130A0	130X2,6 CLAM	1	PZ																																														

COMPONENT			SPARE PART																																																						
Code	Description	Image	Code	Description	Components list																																																				
VL1183A			KVL1101A	EUR 1 ROTOR ARM PLUS CLEANING SYSTEM KIT	<table border="1"> <thead> <tr> <th>Code</th> <th>Description</th> <th>Qty</th> <th>UOM</th> </tr> </thead> <tbody> <tr> <td>RC1242A0</td> <td>D=10 CLOSED CAP</td> <td>2</td> <td>PZ</td> </tr> <tr> <td>RC1356A0</td> <td>"STRAIGHT THREADED FEMALE END 8X1/4" BS</td> <td>1</td> <td>PZ</td> </tr> <tr> <td>TB2820A0</td> <td>6X10 EPDM PIPE FOR WASHING SYSTEM</td> <td>1.410</td> <td>M</td> </tr> <tr> <td>V11220A1</td> <td>4,2X12 TCB SELF-TAPPING SCREW</td> <td>3</td> <td>PZ</td> </tr> <tr> <td>VL1019A0</td> <td>VIBRATION PUMP</td> <td>1</td> <td>PZ</td> </tr> <tr> <td>VL1064A0</td> <td>WASHING SYSTEM OUTLETS DISTRIBUTOR</td> <td>1</td> <td>PZ</td> </tr> <tr> <td>VL1065A1</td> <td>1/4 MALE N.O. PRESSURE SWITCH</td> <td>1</td> <td>PZ</td> </tr> <tr> <td>VL1067A0</td> <td>WASHING SYSTEM INLETS DISTRIBUTOR</td> <td>1</td> <td>PZ</td> </tr> <tr> <td>VL1102A1</td> <td>DETERGENT LINE FILTER + BARBED VNR 6 MM</td> <td>1</td> <td>PZ</td> </tr> <tr> <td>VL1128A0</td> <td>D6 BARBED CHECK VALVE</td> <td>1</td> <td>PZ</td> </tr> <tr> <td>VL1128A1</td> <td>D6 BARBED CHECK VALVE</td> <td>1</td> <td>PZ</td> </tr> <tr> <td>VM2172A0</td> <td>PUMP-WITH-RCUIT LOCKING PIN</td> <td>1</td> <td>PZ</td> </tr> </tbody> </table>	Code	Description	Qty	UOM	RC1242A0	D=10 CLOSED CAP	2	PZ	RC1356A0	"STRAIGHT THREADED FEMALE END 8X1/4" BS	1	PZ	TB2820A0	6X10 EPDM PIPE FOR WASHING SYSTEM	1.410	M	V11220A1	4,2X12 TCB SELF-TAPPING SCREW	3	PZ	VL1019A0	VIBRATION PUMP	1	PZ	VL1064A0	WASHING SYSTEM OUTLETS DISTRIBUTOR	1	PZ	VL1065A1	1/4 MALE N.O. PRESSURE SWITCH	1	PZ	VL1067A0	WASHING SYSTEM INLETS DISTRIBUTOR	1	PZ	VL1102A1	DETERGENT LINE FILTER + BARBED VNR 6 MM	1	PZ	VL1128A0	D6 BARBED CHECK VALVE	1	PZ	VL1128A1	D6 BARBED CHECK VALVE	1	PZ	VM2172A0	PUMP-WITH-RCUIT LOCKING PIN	1	PZ
Code	Description	Qty	UOM																																																						
RC1242A0	D=10 CLOSED CAP	2	PZ																																																						
RC1356A0	"STRAIGHT THREADED FEMALE END 8X1/4" BS	1	PZ																																																						
TB2820A0	6X10 EPDM PIPE FOR WASHING SYSTEM	1.410	M																																																						
V11220A1	4,2X12 TCB SELF-TAPPING SCREW	3	PZ																																																						
VL1019A0	VIBRATION PUMP	1	PZ																																																						
VL1064A0	WASHING SYSTEM OUTLETS DISTRIBUTOR	1	PZ																																																						
VL1065A1	1/4 MALE N.O. PRESSURE SWITCH	1	PZ																																																						
VL1067A0	WASHING SYSTEM INLETS DISTRIBUTOR	1	PZ																																																						
VL1102A1	DETERGENT LINE FILTER + BARBED VNR 6 MM	1	PZ																																																						
VL1128A0	D6 BARBED CHECK VALVE	1	PZ																																																						
VL1128A1	D6 BARBED CHECK VALVE	1	PZ																																																						
VM2172A0	PUMP-WITH-RCUIT LOCKING PIN	1	PZ																																																						
GN1526A	INT. D.=6.9 TH=1.8 O-RING		KG1526A	O-RING INT D6.9 THICK1.8 10PCS KIT	<table border="1"> <thead> <tr> <th>Code</th> <th>Description</th> <th>Qty</th> <th>UOM</th> </tr> </thead> <tbody> <tr> <td>GN1526A0</td> <td>INT. D.=6.9 TH=1.8 O-RING</td> <td>10</td> <td>PZ</td> </tr> </tbody> </table>	Code	Description	Qty	UOM	GN1526A0	INT. D.=6.9 TH=1.8 O-RING	10	PZ																																												
Code	Description	Qty	UOM																																																						
GN1526A0	INT. D.=6.9 TH=1.8 O-RING	10	PZ																																																						

COMPONENT			SPARE PART																						
Code	Description	Image	Code	Description	Components list																				
RC1019A	D=10 ELASTIC CLAM		KRC1019A	Ø10 ZINC PLATED ELASTIC CLAMP 15 PCS KIT	<table border="1"> <thead> <tr> <th>Code</th> <th>Description</th> <th>Qty</th> <th>UOM</th> </tr> </thead> <tbody> <tr> <td>RC1019A0</td> <td>D=10 ELASTIC CLAMP</td> <td>17</td> <td>PZ</td> </tr> <tr> <td>VM1224A0</td> <td>65MY 220MM 2 COLOURS SHRINK TUBE</td> <td>0.200</td> <td>M</td> </tr> </tbody> </table>	Code	Description	Qty	UOM	RC1019A0	D=10 ELASTIC CLAMP	17	PZ	VM1224A0	65MY 220MM 2 COLOURS SHRINK TUBE	0.200	M								
					Code	Description	Qty	UOM																	
RC1019A0	D=10 ELASTIC CLAMP	17	PZ																						
VM1224A0	65MY 220MM 2 COLOURS SHRINK TUBE	0.200	M																						
<table border="1"> <thead> <tr> <th>Code</th> <th>Description</th> <th>Qty</th> <th>UOM</th> </tr> </thead> <tbody> <tr> <td>RC1019A0</td> <td>D=10 ELASTIC CLAMP</td> <td>5</td> <td>PZ</td> </tr> <tr> <td>TB2820A0</td> <td>6X10 EPDM PIPE FOR WASHING SYSTEM</td> <td>0.710</td> <td>M</td> </tr> <tr> <td>VL1102A1</td> <td>DETERGENT LINE FILTER + BARBED VNR 6 MM</td> <td>1</td> <td>PZ</td> </tr> <tr> <td>VM1224A0</td> <td>65MY 220MM 2 COLOURS SHRINK TUBE</td> <td>0.300</td> <td>M</td> </tr> </tbody> </table>	Code	Description	Qty	UOM	RC1019A0	D=10 ELASTIC CLAMP	5	PZ	TB2820A0	6X10 EPDM PIPE FOR WASHING SYSTEM	0.710	M	VL1102A1	DETERGENT LINE FILTER + BARBED VNR 6 MM	1	PZ	VM1224A0	65MY 220MM 2 COLOURS SHRINK TUBE	0.300	M					
Code	Description	Qty	UOM																						
RC1019A0	D=10 ELASTIC CLAMP	5	PZ																						
TB2820A0	6X10 EPDM PIPE FOR WASHING SYSTEM	0.710	M																						
VL1102A1	DETERGENT LINE FILTER + BARBED VNR 6 MM	1	PZ																						
VM1224A0	65MY 220MM 2 COLOURS SHRINK TUBE	0.300	M																						
VL1102A	DETERGENT LINE FILTER + BARBED VNR 6 MM		KVL1102A	DETERGENT FILTER + NRV KIT	<table border="1"> <thead> <tr> <th>Code</th> <th>Description</th> <th>Qty</th> <th>UOM</th> </tr> </thead> <tbody> <tr> <td>RC1019A0</td> <td>D=10 ELASTIC CLAMP</td> <td>5</td> <td>PZ</td> </tr> <tr> <td>TB2820A0</td> <td>6X10 EPDM PIPE FOR WASHING SYSTEM</td> <td>0.710</td> <td>M</td> </tr> <tr> <td>VL1102A1</td> <td>DETERGENT LINE FILTER + BARBED VNR 6 MM</td> <td>1</td> <td>PZ</td> </tr> <tr> <td>VM1224A0</td> <td>65MY 220MM 2 COLOURS SHRINK TUBE</td> <td>0.300</td> <td>M</td> </tr> </tbody> </table>	Code	Description	Qty	UOM	RC1019A0	D=10 ELASTIC CLAMP	5	PZ	TB2820A0	6X10 EPDM PIPE FOR WASHING SYSTEM	0.710	M	VL1102A1	DETERGENT LINE FILTER + BARBED VNR 6 MM	1	PZ	VM1224A0	65MY 220MM 2 COLOURS SHRINK TUBE	0.300	M
Code	Description	Qty	UOM																						
RC1019A0	D=10 ELASTIC CLAMP	5	PZ																						
TB2820A0	6X10 EPDM PIPE FOR WASHING SYSTEM	0.710	M																						
VL1102A1	DETERGENT LINE FILTER + BARBED VNR 6 MM	1	PZ																						
VM1224A0	65MY 220MM 2 COLOURS SHRINK TUBE	0.300	M																						
TB3004A	TB2820A L=550MM EPDM BLACK PIPE		KTB1343A	TB2820A0 6X10 EPM PIPE 3M KIT	<table border="1"> <thead> <tr> <th>Code</th> <th>Description</th> <th>Qty</th> <th>UOM</th> </tr> </thead> <tbody> <tr> <td>TB2820A0</td> <td>6X10 EPDM PIPE FOR WASHING SYSTEM</td> <td>3</td> <td>M</td> </tr> </tbody> </table>	Code	Description	Qty	UOM	TB2820A0	6X10 EPDM PIPE FOR WASHING SYSTEM	3	M												
Code	Description	Qty	UOM																						
TB2820A0	6X10 EPDM PIPE FOR WASHING SYSTEM	3	M																						
TB3005B	TB3132A L=550MM EPDM WHITE-BLUE PIPE		KTB3132A	WHITE-BLU 6X12 REINFORCED PIPE 3M KIT	<table border="1"> <thead> <tr> <th>Code</th> <th>Description</th> <th>Qty</th> <th>UOM</th> </tr> </thead> <tbody> <tr> <td>TB3132A0</td> <td>WHITE-BLUE EPDM TEXTILE BRAID HOSE 6X12</td> <td>3</td> <td>M</td> </tr> <tr> <td>VM1794A0</td> <td>250X4.8 PA66 BLACK CLAMP</td> <td>1</td> <td>PZ</td> </tr> </tbody> </table>	Code	Description	Qty	UOM	TB3132A0	WHITE-BLUE EPDM TEXTILE BRAID HOSE 6X12	3	M	VM1794A0	250X4.8 PA66 BLACK CLAMP	1	PZ								
Code	Description	Qty	UOM																						
TB3132A0	WHITE-BLUE EPDM TEXTILE BRAID HOSE 6X12	3	M																						
VM1794A0	250X4.8 PA66 BLACK CLAMP	1	PZ																						
TB3225B	TB2820A-TANK-WAS HYNG SYS CONNECTION		KTB1343A	TB2820A0 6X10 EPM PIPE 3M KIT	<table border="1"> <thead> <tr> <th>Code</th> <th>Description</th> <th>Qty</th> <th>UOM</th> </tr> </thead> <tbody> <tr> <td>TB2820A0</td> <td>6X10 EPDM PIPE FOR WASHING SYSTEM</td> <td>3</td> <td>M</td> </tr> </tbody> </table>	Code	Description	Qty	UOM	TB2820A0	6X10 EPDM PIPE FOR WASHING SYSTEM	3	M												
Code	Description	Qty	UOM																						
TB2820A0	6X10 EPDM PIPE FOR WASHING SYSTEM	3	M																						

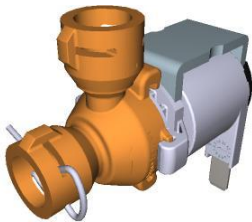
COMPONENT			SPARE PART																																																																						
Code	Description	Image	Code	Description	Components list																																																																				
0H2354A	XEVC-XEVL WASHING CIRCUIT PLATE		0H2354A0	XEVC-XEVL WASHING CIRCUIT PLATE																																																																					
EL1440A	WATER SELF CLEANING VALVE		KVL1187A	3 ROTOR ARMS PLUS EU CLEANING SYSTEM KIT	<table border="1"> <thead> <tr> <th>Code</th> <th>Description</th> <th>Qty</th> <th>UOM</th> </tr> </thead> <tbody> <tr> <td>0H2143A0</td> <td>LAMIERA BLOCCA VNR VL1128</td> <td>3</td> <td>PZ</td> </tr> <tr> <td>0H2168A0</td> <td></td> <td>1</td> <td>PZ</td> </tr> <tr> <td>0H2354A0</td> <td>XEVC-XEVL WASHING CIRCUIT PLAT</td> <td>1</td> <td>PZ</td> </tr> <tr> <td>EL1120A0</td> <td>D8-D6 FEMALE STRAIGHT INTERM. CONNECTION</td> <td>1</td> <td>PZ</td> </tr> <tr> <td>EL1220A0</td> <td>JG STRAIGHT CONNECTION Ø8F-Ø8F</td> <td>2</td> <td>PZ</td> </tr> <tr> <td>EL1440A0</td> <td>WATER SELF CLEANING VALVE</td> <td>4</td> <td>PZ</td> </tr> <tr> <td>GN1526A0</td> <td>INT. D.=6.9 TH=1.8 O-RIN</td> <td>9</td> <td>PZ</td> </tr> <tr> <td>RC1018A0</td> <td>ZINC PLATED D12 ELASTIC CLAMP</td> <td>10</td> <td>PZ</td> </tr> <tr> <td>RC1019A0</td> <td>D=10 ELASTIC CLAMP</td> <td>22</td> <td>PZ</td> </tr> <tr> <td>RC1130A0</td> <td>130X2,6 CLAM</td> <td>4</td> <td>PZ</td> </tr> <tr> <td>RC1131A0</td> <td>200X2.6 BLACK CLAMP</td> <td>3</td> <td>PZ</td> </tr> <tr> <td>RC1242A0</td> <td>D=10 CLOSED CAP</td> <td>2</td> <td>PZ</td> </tr> <tr> <td>RC1310A0</td> <td>140X4 CLAMP WITH CLIP</td> <td>1</td> <td>PZ</td> </tr> <tr> <td>RC1356A0</td> <td>"STRAIGHT THREADED FEMALE END 8X1/4" BS</td> <td>1</td> <td>PZ</td> </tr> <tr> <td>TB2820A0</td> <td>6X10 EPDM PIPE FOR WASHING SYSTEM</td> <td>1.510</td> <td>M</td> </tr> <tr> <td>TB3132A0</td> <td>WHITE-BLUE EPDM TEXTILE BRAID HOSE 6X12</td> <td>1.210</td> <td>M</td> </tr> </tbody> </table>	Code	Description	Qty	UOM	0H2143A0	LAMIERA BLOCCA VNR VL1128	3	PZ	0H2168A0		1	PZ	0H2354A0	XEVC-XEVL WASHING CIRCUIT PLAT	1	PZ	EL1120A0	D8-D6 FEMALE STRAIGHT INTERM. CONNECTION	1	PZ	EL1220A0	JG STRAIGHT CONNECTION Ø8F-Ø8F	2	PZ	EL1440A0	WATER SELF CLEANING VALVE	4	PZ	GN1526A0	INT. D.=6.9 TH=1.8 O-RIN	9	PZ	RC1018A0	ZINC PLATED D12 ELASTIC CLAMP	10	PZ	RC1019A0	D=10 ELASTIC CLAMP	22	PZ	RC1130A0	130X2,6 CLAM	4	PZ	RC1131A0	200X2.6 BLACK CLAMP	3	PZ	RC1242A0	D=10 CLOSED CAP	2	PZ	RC1310A0	140X4 CLAMP WITH CLIP	1	PZ	RC1356A0	"STRAIGHT THREADED FEMALE END 8X1/4" BS	1	PZ	TB2820A0	6X10 EPDM PIPE FOR WASHING SYSTEM	1.510	M	TB3132A0	WHITE-BLUE EPDM TEXTILE BRAID HOSE 6X12	1.210	M
Code	Description	Qty	UOM																																																																						
0H2143A0	LAMIERA BLOCCA VNR VL1128	3	PZ																																																																						
0H2168A0		1	PZ																																																																						
0H2354A0	XEVC-XEVL WASHING CIRCUIT PLAT	1	PZ																																																																						
EL1120A0	D8-D6 FEMALE STRAIGHT INTERM. CONNECTION	1	PZ																																																																						
EL1220A0	JG STRAIGHT CONNECTION Ø8F-Ø8F	2	PZ																																																																						
EL1440A0	WATER SELF CLEANING VALVE	4	PZ																																																																						
GN1526A0	INT. D.=6.9 TH=1.8 O-RIN	9	PZ																																																																						
RC1018A0	ZINC PLATED D12 ELASTIC CLAMP	10	PZ																																																																						
RC1019A0	D=10 ELASTIC CLAMP	22	PZ																																																																						
RC1130A0	130X2,6 CLAM	4	PZ																																																																						
RC1131A0	200X2.6 BLACK CLAMP	3	PZ																																																																						
RC1242A0	D=10 CLOSED CAP	2	PZ																																																																						
RC1310A0	140X4 CLAMP WITH CLIP	1	PZ																																																																						
RC1356A0	"STRAIGHT THREADED FEMALE END 8X1/4" BS	1	PZ																																																																						
TB2820A0	6X10 EPDM PIPE FOR WASHING SYSTEM	1.510	M																																																																						
TB3132A0	WHITE-BLUE EPDM TEXTILE BRAID HOSE 6X12	1.210	M																																																																						

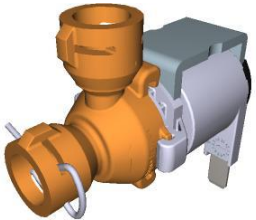
COMPONENT			SPARE PART																																																																																		
Code	Description	Image	Code	Description	Components list																																																																																
EL1440A	WATER SELF CLEANING VALVE		KVL1187A	3 ROTOR ARMS PLUS EU CLEANING SYSTEM KIT	<table border="1"> <thead> <tr> <th>Code</th> <th>Description</th> <th>Qty</th> <th>UOM</th> </tr> </thead> <tbody> <tr> <td>VI1220A1</td> <td>4,2X12 TCB SELF-TAPPIN G SCREW</td> <td>3</td> <td>PZ</td> </tr> <tr> <td>VL1019A0</td> <td>VIBRATION PUMP</td> <td>1</td> <td>PZ</td> </tr> <tr> <td>VL1046A1</td> <td>D6 PIPE HOLDER - D6 J.G. TERMINAL</td> <td>3</td> <td>PZ</td> </tr> <tr> <td>VL1047A1</td> <td>D6 PIPE HOLDER - D8 J.G. TERMINAL</td> <td>1</td> <td>PZ</td> </tr> <tr> <td>VL1064A0</td> <td>WASHING SYSTEM OUTLETS DISTRIBUTOR</td> <td>1</td> <td>PZ</td> </tr> <tr> <td>VL1065A1</td> <td>1/4 MALE N.O. PRESSURE SWITCH</td> <td>1</td> <td>PZ</td> </tr> <tr> <td>VL1067A0</td> <td>WASHING SYSTEM INLETS DISTRIBUTOR</td> <td>1</td> <td>PZ</td> </tr> <tr> <td>VL1092A0</td> <td>WASHING SYSTEM OUTLET DOUBLE DISTRIBUTOR</td> <td>1</td> <td>PZ</td> </tr> <tr> <td>VL1102A1</td> <td>DETERGENT LINE FILTER + BARBED VNR 6 MM</td> <td>1</td> <td>PZ</td> </tr> <tr> <td>VL1127A1</td> <td>6MM BARBED T-SHAPED FITTING</td> <td>2</td> <td>PZ</td> </tr> <tr> <td>VL1128A0</td> <td>D6 BARBED CHECK VALVE</td> <td>3</td> <td>PZ</td> </tr> <tr> <td>VL1128A1</td> <td>D6 BARBED CHECK VALVE</td> <td>3</td> <td>PZ</td> </tr> <tr> <td>VL1165A0</td> <td>BB6-AR6 STRAIGHT FITTING</td> <td>4</td> <td>PZ</td> </tr> <tr> <td>VL1166A0</td> <td>BB6-AR6 L FITTING</td> <td>4</td> <td>PZ</td> </tr> <tr> <td>VL1167A0</td> <td></td> <td>1</td> <td>PZ</td> </tr> <tr> <td>VL1167A1</td> <td></td> <td>1</td> <td>PZ</td> </tr> <tr> <td>VL1167A2</td> <td>GN21 3 ROTOR ARMS B-B FLOW RESTRICTOR</td> <td>1</td> <td>PZ</td> </tr> <tr> <td>VL1174C0</td> <td>D1.2 MM CALIBRATED NOZZLE</td> <td>1</td> <td>PZ</td> </tr> <tr> <td>VL1185A0</td> <td>2 WAYS PLUS WASHING DISTRIBUTOR</td> <td>1</td> <td>PZ</td> </tr> </tbody> </table>	Code	Description	Qty	UOM	VI1220A1	4,2X12 TCB SELF-TAPPIN G SCREW	3	PZ	VL1019A0	VIBRATION PUMP	1	PZ	VL1046A1	D6 PIPE HOLDER - D6 J.G. TERMINAL	3	PZ	VL1047A1	D6 PIPE HOLDER - D8 J.G. TERMINAL	1	PZ	VL1064A0	WASHING SYSTEM OUTLETS DISTRIBUTOR	1	PZ	VL1065A1	1/4 MALE N.O. PRESSURE SWITCH	1	PZ	VL1067A0	WASHING SYSTEM INLETS DISTRIBUTOR	1	PZ	VL1092A0	WASHING SYSTEM OUTLET DOUBLE DISTRIBUTOR	1	PZ	VL1102A1	DETERGENT LINE FILTER + BARBED VNR 6 MM	1	PZ	VL1127A1	6MM BARBED T-SHAPED FITTING	2	PZ	VL1128A0	D6 BARBED CHECK VALVE	3	PZ	VL1128A1	D6 BARBED CHECK VALVE	3	PZ	VL1165A0	BB6-AR6 STRAIGHT FITTING	4	PZ	VL1166A0	BB6-AR6 L FITTING	4	PZ	VL1167A0		1	PZ	VL1167A1		1	PZ	VL1167A2	GN21 3 ROTOR ARMS B-B FLOW RESTRICTOR	1	PZ	VL1174C0	D1.2 MM CALIBRATED NOZZLE	1	PZ	VL1185A0	2 WAYS PLUS WASHING DISTRIBUTOR	1	PZ
Code	Description	Qty	UOM																																																																																		
VI1220A1	4,2X12 TCB SELF-TAPPIN G SCREW	3	PZ																																																																																		
VL1019A0	VIBRATION PUMP	1	PZ																																																																																		
VL1046A1	D6 PIPE HOLDER - D6 J.G. TERMINAL	3	PZ																																																																																		
VL1047A1	D6 PIPE HOLDER - D8 J.G. TERMINAL	1	PZ																																																																																		
VL1064A0	WASHING SYSTEM OUTLETS DISTRIBUTOR	1	PZ																																																																																		
VL1065A1	1/4 MALE N.O. PRESSURE SWITCH	1	PZ																																																																																		
VL1067A0	WASHING SYSTEM INLETS DISTRIBUTOR	1	PZ																																																																																		
VL1092A0	WASHING SYSTEM OUTLET DOUBLE DISTRIBUTOR	1	PZ																																																																																		
VL1102A1	DETERGENT LINE FILTER + BARBED VNR 6 MM	1	PZ																																																																																		
VL1127A1	6MM BARBED T-SHAPED FITTING	2	PZ																																																																																		
VL1128A0	D6 BARBED CHECK VALVE	3	PZ																																																																																		
VL1128A1	D6 BARBED CHECK VALVE	3	PZ																																																																																		
VL1165A0	BB6-AR6 STRAIGHT FITTING	4	PZ																																																																																		
VL1166A0	BB6-AR6 L FITTING	4	PZ																																																																																		
VL1167A0		1	PZ																																																																																		
VL1167A1		1	PZ																																																																																		
VL1167A2	GN21 3 ROTOR ARMS B-B FLOW RESTRICTOR	1	PZ																																																																																		
VL1174C0	D1.2 MM CALIBRATED NOZZLE	1	PZ																																																																																		
VL1185A0	2 WAYS PLUS WASHING DISTRIBUTOR	1	PZ																																																																																		

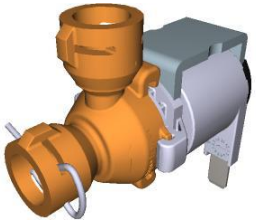
COMPONENT			SPARE PART																																																															
Code	Description	Image	Code	Description	Components list																																																													
EL1440A	WATER SELF CLEANING VALVE		KVL1187A	3 ROTOR ARMS PLUS EU CLEANING SYSTEM KIT	<table border="1"> <thead> <tr> <th>Code</th> <th>Description</th> <th>Qty</th> <th>UOM</th> </tr> </thead> <tbody> <tr> <td>VL1186A0</td> <td>3 WAYS PLUS WASHING DISTRIBUTOR</td> <td>1</td> <td>PZ</td> </tr> <tr> <td>VL1190A0</td> <td>PLUS WASHING SYSTEM INLET DISTRIBUTOR</td> <td>1</td> <td>PZ</td> </tr> <tr> <td>VM1605A0</td> <td>CLIP TWIST LOCK DIAM. 10,2-12,7 MM</td> <td>3</td> <td>PZ</td> </tr> <tr> <td>VM2172A0</td> <td>PUMP-WITH-CI RCUIT LOCKING PIN</td> <td>9</td> <td>PZ</td> </tr> </tbody> </table>	Code	Description	Qty	UOM	VL1186A0	3 WAYS PLUS WASHING DISTRIBUTOR	1	PZ	VL1190A0	PLUS WASHING SYSTEM INLET DISTRIBUTOR	1	PZ	VM1605A0	CLIP TWIST LOCK DIAM. 10,2-12,7 MM	3	PZ	VM2172A0	PUMP-WITH-CI RCUIT LOCKING PIN	9	PZ																																									
			Code	Description	Qty	UOM																																																												
VL1186A0	3 WAYS PLUS WASHING DISTRIBUTOR	1	PZ																																																															
VL1190A0	PLUS WASHING SYSTEM INLET DISTRIBUTOR	1	PZ																																																															
VM1605A0	CLIP TWIST LOCK DIAM. 10,2-12,7 MM	3	PZ																																																															
VM2172A0	PUMP-WITH-CI RCUIT LOCKING PIN	9	PZ																																																															
KVL1184A	2 ROTOR ARMS PLUS EU CLEANING SYSTEM KIT	<table border="1"> <thead> <tr> <th>Code</th> <th>Description</th> <th>Qty</th> <th>UOM</th> </tr> </thead> <tbody> <tr> <td>0H2143A0</td> <td>LAMIERA BLOCCA VNR VL1128</td> <td>2</td> <td>PZ</td> </tr> <tr> <td>0H2168A0</td> <td></td> <td>1</td> <td>PZ</td> </tr> <tr> <td>0H2354A0</td> <td>XEVC-XEVL WASHING CIRCUIT PLAT</td> <td>1</td> <td>PZ</td> </tr> <tr> <td>EL1220A0</td> <td>JG STRAIGHT CONNECTION Ø8F-Ø8F</td> <td>3</td> <td>PZ</td> </tr> <tr> <td>EL1440A0</td> <td>WATER SELF CLEANING VALVE</td> <td>4</td> <td>PZ</td> </tr> <tr> <td>GN1526A0</td> <td>INT. D.=6.9 TH=1.8 O-RIN</td> <td>9</td> <td>PZ</td> </tr> <tr> <td>RC1018A0</td> <td>ZINC PLATED D12 ELASTIC CLAMP</td> <td>2</td> <td>PZ</td> </tr> <tr> <td>RC1019A0</td> <td>D=10 ELASTIC CLAMP</td> <td>21</td> <td>PZ</td> </tr> <tr> <td>RC1130A0</td> <td>130X2,6 CLAM</td> <td>7</td> <td>PZ</td> </tr> <tr> <td>RC1131A0</td> <td>200X2.6 BLACK CLAMP</td> <td>3</td> <td>PZ</td> </tr> <tr> <td>RC1242A0</td> <td>D=10 CLOSED CAP</td> <td>2</td> <td>PZ</td> </tr> <tr> <td>RC1356A0</td> <td>"STRAIGHT THREADED FEMALE END 8X1/4" BS</td> <td>1</td> <td>PZ</td> </tr> <tr> <td>TB2820A0</td> <td>6X10 EPDM PIPE FOR WASHING SYSTEM</td> <td>2.400</td> <td>M</td> </tr> <tr> <td>TB3132A0</td> <td>WHITE-BLUE EPDM TEXTILE BRAID HOSE 6X12</td> <td>1.220</td> <td>M</td> </tr> <tr> <td>VL1019A0</td> <td>VIBRATION PUMP</td> <td>1</td> <td>PZ</td> </tr> </tbody> </table>	Code	Description	Qty	UOM	0H2143A0	LAMIERA BLOCCA VNR VL1128	2	PZ	0H2168A0		1	PZ	0H2354A0	XEVC-XEVL WASHING CIRCUIT PLAT	1	PZ	EL1220A0	JG STRAIGHT CONNECTION Ø8F-Ø8F	3	PZ	EL1440A0	WATER SELF CLEANING VALVE	4	PZ	GN1526A0	INT. D.=6.9 TH=1.8 O-RIN	9	PZ	RC1018A0	ZINC PLATED D12 ELASTIC CLAMP	2	PZ	RC1019A0	D=10 ELASTIC CLAMP	21	PZ	RC1130A0	130X2,6 CLAM	7	PZ	RC1131A0	200X2.6 BLACK CLAMP	3	PZ	RC1242A0	D=10 CLOSED CAP	2	PZ	RC1356A0	"STRAIGHT THREADED FEMALE END 8X1/4" BS	1	PZ	TB2820A0	6X10 EPDM PIPE FOR WASHING SYSTEM	2.400	M	TB3132A0	WHITE-BLUE EPDM TEXTILE BRAID HOSE 6X12	1.220	M	VL1019A0	VIBRATION PUMP	1	PZ
Code	Description	Qty	UOM																																																															
0H2143A0	LAMIERA BLOCCA VNR VL1128	2	PZ																																																															
0H2168A0		1	PZ																																																															
0H2354A0	XEVC-XEVL WASHING CIRCUIT PLAT	1	PZ																																																															
EL1220A0	JG STRAIGHT CONNECTION Ø8F-Ø8F	3	PZ																																																															
EL1440A0	WATER SELF CLEANING VALVE	4	PZ																																																															
GN1526A0	INT. D.=6.9 TH=1.8 O-RIN	9	PZ																																																															
RC1018A0	ZINC PLATED D12 ELASTIC CLAMP	2	PZ																																																															
RC1019A0	D=10 ELASTIC CLAMP	21	PZ																																																															
RC1130A0	130X2,6 CLAM	7	PZ																																																															
RC1131A0	200X2.6 BLACK CLAMP	3	PZ																																																															
RC1242A0	D=10 CLOSED CAP	2	PZ																																																															
RC1356A0	"STRAIGHT THREADED FEMALE END 8X1/4" BS	1	PZ																																																															
TB2820A0	6X10 EPDM PIPE FOR WASHING SYSTEM	2.400	M																																																															
TB3132A0	WHITE-BLUE EPDM TEXTILE BRAID HOSE 6X12	1.220	M																																																															
VL1019A0	VIBRATION PUMP	1	PZ																																																															

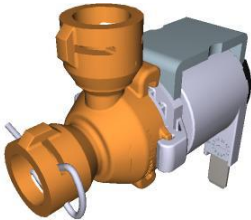
COMPONENT			SPARE PART																																																																						
Code	Description	Image	Code	Description	Components list																																																																				
EL1440A	WATER SELF CLEANING VALVE		KVL1184A	2 ROTOR ARMS PLUS EU CLEANING SYSTEM KIT	<table border="1"> <thead> <tr> <th>Code</th> <th>Description</th> <th>Qty</th> <th>UOM</th> </tr> </thead> <tbody> <tr> <td>VL1046A1</td> <td>D6 PIPE HOLDER - D6 J.G. TERMINAL</td> <td>3</td> <td>PZ</td> </tr> <tr> <td>VL1047A1</td> <td>D6 PIPE HOLDER - D8 J.G. TERMINAL</td> <td>1</td> <td>PZ</td> </tr> <tr> <td>VL1065A1</td> <td>1/4 MALE N.O. PRESSURE SWITCH</td> <td>1</td> <td>PZ</td> </tr> <tr> <td>VL1067A0</td> <td>WASHING SYSTEM INLETS DISTRIBUTOR</td> <td>1</td> <td>PZ</td> </tr> <tr> <td>VL1092A0</td> <td>WASHING SYSTEM OUTLET DOUBLE DISTRIBUTOR</td> <td>1</td> <td>PZ</td> </tr> <tr> <td>VL1102A1</td> <td>DETERGENT LINE FILTER + BARBED VNR 6 MM</td> <td>1</td> <td>PZ</td> </tr> <tr> <td>VL1128A0</td> <td>D6 BARBED CHECK VALVE</td> <td>2</td> <td>PZ</td> </tr> <tr> <td>VL1128A1</td> <td>D6 BARBED CHECK VALVE</td> <td>2</td> <td>PZ</td> </tr> <tr> <td>VL1141A1</td> <td>STRAIGHT CONNECT BB6-BB6</td> <td>1</td> <td>PZ</td> </tr> <tr> <td>VL1165A0</td> <td>BB6-AR6 STRAIGHT FITTING</td> <td>4</td> <td>PZ</td> </tr> <tr> <td>VL1166A0</td> <td>BB6-AR6 L FITTING</td> <td>4</td> <td>PZ</td> </tr> <tr> <td>VL1174C0</td> <td>D1.2 MM CALIBRATED NOZZLE</td> <td>1</td> <td>PZ</td> </tr> <tr> <td>VL1186A0</td> <td>3 WAYS PLUS WASHING DISTRIBUTOR</td> <td>1</td> <td>PZ</td> </tr> <tr> <td>VL1190A0</td> <td>PLUS WASHING SYSTEM INLET DISTRIBUTOR</td> <td>1</td> <td>PZ</td> </tr> <tr> <td>VM1605A0</td> <td>CLIP TWIST LOCK DIAM. 10,2-12,7 MM</td> <td>4</td> <td>PZ</td> </tr> <tr> <td>VM2172A0</td> <td>PUMP-WITH-CI RCUIT LOCKING PIN</td> <td>9</td> <td>PZ</td> </tr> </tbody> </table>	Code	Description	Qty	UOM	VL1046A1	D6 PIPE HOLDER - D6 J.G. TERMINAL	3	PZ	VL1047A1	D6 PIPE HOLDER - D8 J.G. TERMINAL	1	PZ	VL1065A1	1/4 MALE N.O. PRESSURE SWITCH	1	PZ	VL1067A0	WASHING SYSTEM INLETS DISTRIBUTOR	1	PZ	VL1092A0	WASHING SYSTEM OUTLET DOUBLE DISTRIBUTOR	1	PZ	VL1102A1	DETERGENT LINE FILTER + BARBED VNR 6 MM	1	PZ	VL1128A0	D6 BARBED CHECK VALVE	2	PZ	VL1128A1	D6 BARBED CHECK VALVE	2	PZ	VL1141A1	STRAIGHT CONNECT BB6-BB6	1	PZ	VL1165A0	BB6-AR6 STRAIGHT FITTING	4	PZ	VL1166A0	BB6-AR6 L FITTING	4	PZ	VL1174C0	D1.2 MM CALIBRATED NOZZLE	1	PZ	VL1186A0	3 WAYS PLUS WASHING DISTRIBUTOR	1	PZ	VL1190A0	PLUS WASHING SYSTEM INLET DISTRIBUTOR	1	PZ	VM1605A0	CLIP TWIST LOCK DIAM. 10,2-12,7 MM	4	PZ	VM2172A0	PUMP-WITH-CI RCUIT LOCKING PIN	9	PZ
Code	Description	Qty	UOM																																																																						
VL1046A1	D6 PIPE HOLDER - D6 J.G. TERMINAL	3	PZ																																																																						
VL1047A1	D6 PIPE HOLDER - D8 J.G. TERMINAL	1	PZ																																																																						
VL1065A1	1/4 MALE N.O. PRESSURE SWITCH	1	PZ																																																																						
VL1067A0	WASHING SYSTEM INLETS DISTRIBUTOR	1	PZ																																																																						
VL1092A0	WASHING SYSTEM OUTLET DOUBLE DISTRIBUTOR	1	PZ																																																																						
VL1102A1	DETERGENT LINE FILTER + BARBED VNR 6 MM	1	PZ																																																																						
VL1128A0	D6 BARBED CHECK VALVE	2	PZ																																																																						
VL1128A1	D6 BARBED CHECK VALVE	2	PZ																																																																						
VL1141A1	STRAIGHT CONNECT BB6-BB6	1	PZ																																																																						
VL1165A0	BB6-AR6 STRAIGHT FITTING	4	PZ																																																																						
VL1166A0	BB6-AR6 L FITTING	4	PZ																																																																						
VL1174C0	D1.2 MM CALIBRATED NOZZLE	1	PZ																																																																						
VL1186A0	3 WAYS PLUS WASHING DISTRIBUTOR	1	PZ																																																																						
VL1190A0	PLUS WASHING SYSTEM INLET DISTRIBUTOR	1	PZ																																																																						
VM1605A0	CLIP TWIST LOCK DIAM. 10,2-12,7 MM	4	PZ																																																																						
VM2172A0	PUMP-WITH-CI RCUIT LOCKING PIN	9	PZ																																																																						

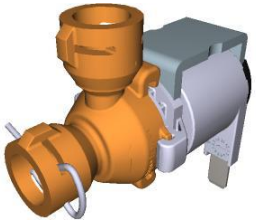
COMPONENT			SPARE PART																																																																																						
Code	Description	Image	Code	Description	Components list																																																																																				
EL1440A	WATER SELF CLEANING VALVE		KVL1183A	1 ROTOR ARM PLUS CLEANING SYSTEM KIT	<table border="1"> <thead> <tr> <th>Code</th> <th>Description</th> <th>Qty</th> <th>UOM</th> </tr> </thead> <tbody> <tr> <td>0H2143A0</td> <td>LAMIERA BLOCCA VNR VL1128</td> <td>2</td> <td>PZ</td> </tr> <tr> <td>0H2168A1</td> <td></td> <td>1</td> <td>PZ</td> </tr> <tr> <td>0H2354A0</td> <td>XEVC-XEVL WASHING CIRCUIT PLAT</td> <td>1</td> <td>PZ</td> </tr> <tr> <td>EL1440A0</td> <td>WATER SELF CLEANING VALVE</td> <td>3</td> <td>PZ</td> </tr> <tr> <td>GN1526A0</td> <td>INT. D.=6.9 TH=1.8 O-RIN</td> <td>7</td> <td>PZ</td> </tr> <tr> <td>RC1018A0</td> <td>ZINC PLATED D12 ELASTIC CLAMP</td> <td>2</td> <td>PZ</td> </tr> <tr> <td>RC1019A0</td> <td>D=10 ELASTIC CLAMP</td> <td>14</td> <td>PZ</td> </tr> <tr> <td>RC1130A0</td> <td>130X2,6 CLAM</td> <td>5</td> <td>PZ</td> </tr> <tr> <td>RC1131A0</td> <td>200X2.6 BLACK CLAMP</td> <td>2</td> <td>PZ</td> </tr> <tr> <td>RC1242A0</td> <td>D=10 CLOSED CAP</td> <td>2</td> <td>PZ</td> </tr> <tr> <td>RC1356A0</td> <td>"STRAIGHT THREADED FEMALE END 8X1/4" BS</td> <td>1</td> <td>PZ</td> </tr> <tr> <td>TB2820A0</td> <td>6X10 EPDM PIPE FOR WASHING SYSTEM</td> <td>1.410</td> <td>M</td> </tr> <tr> <td>TB3132A0</td> <td>WHITE-BLUE EPDM TEXTILE BRAID HOSE 6X12</td> <td>0.770</td> <td>M</td> </tr> <tr> <td>VH1220A1</td> <td>4,2X12 TCB SELF-TAPPIN G SCREW</td> <td>3</td> <td>PZ</td> </tr> <tr> <td>VL1019A0</td> <td>VIBRATION PUMP</td> <td>1</td> <td>PZ</td> </tr> <tr> <td>VL1047A1</td> <td>D6 PIPE HOLDER - D8 J.G. TERMINAL</td> <td>1</td> <td>PZ</td> </tr> <tr> <td>VL1065A1</td> <td>1/4 MALE N.O. PRESSURE SWITCH</td> <td>1</td> <td>PZ</td> </tr> <tr> <td>VL1102A1</td> <td>DETERGENT LINE FILTER + BARBED VNR 6 MM</td> <td>1</td> <td>PZ</td> </tr> <tr> <td>VL1128A0</td> <td>D6 BARBED CHECK VALVE</td> <td>2</td> <td>PZ</td> </tr> <tr> <td>VL1128A1</td> <td>D6 BARBED CHECK VALVE</td> <td>2</td> <td>PZ</td> </tr> </tbody> </table>	Code	Description	Qty	UOM	0H2143A0	LAMIERA BLOCCA VNR VL1128	2	PZ	0H2168A1		1	PZ	0H2354A0	XEVC-XEVL WASHING CIRCUIT PLAT	1	PZ	EL1440A0	WATER SELF CLEANING VALVE	3	PZ	GN1526A0	INT. D.=6.9 TH=1.8 O-RIN	7	PZ	RC1018A0	ZINC PLATED D12 ELASTIC CLAMP	2	PZ	RC1019A0	D=10 ELASTIC CLAMP	14	PZ	RC1130A0	130X2,6 CLAM	5	PZ	RC1131A0	200X2.6 BLACK CLAMP	2	PZ	RC1242A0	D=10 CLOSED CAP	2	PZ	RC1356A0	"STRAIGHT THREADED FEMALE END 8X1/4" BS	1	PZ	TB2820A0	6X10 EPDM PIPE FOR WASHING SYSTEM	1.410	M	TB3132A0	WHITE-BLUE EPDM TEXTILE BRAID HOSE 6X12	0.770	M	VH1220A1	4,2X12 TCB SELF-TAPPIN G SCREW	3	PZ	VL1019A0	VIBRATION PUMP	1	PZ	VL1047A1	D6 PIPE HOLDER - D8 J.G. TERMINAL	1	PZ	VL1065A1	1/4 MALE N.O. PRESSURE SWITCH	1	PZ	VL1102A1	DETERGENT LINE FILTER + BARBED VNR 6 MM	1	PZ	VL1128A0	D6 BARBED CHECK VALVE	2	PZ	VL1128A1	D6 BARBED CHECK VALVE	2	PZ
Code	Description	Qty	UOM																																																																																						
0H2143A0	LAMIERA BLOCCA VNR VL1128	2	PZ																																																																																						
0H2168A1		1	PZ																																																																																						
0H2354A0	XEVC-XEVL WASHING CIRCUIT PLAT	1	PZ																																																																																						
EL1440A0	WATER SELF CLEANING VALVE	3	PZ																																																																																						
GN1526A0	INT. D.=6.9 TH=1.8 O-RIN	7	PZ																																																																																						
RC1018A0	ZINC PLATED D12 ELASTIC CLAMP	2	PZ																																																																																						
RC1019A0	D=10 ELASTIC CLAMP	14	PZ																																																																																						
RC1130A0	130X2,6 CLAM	5	PZ																																																																																						
RC1131A0	200X2.6 BLACK CLAMP	2	PZ																																																																																						
RC1242A0	D=10 CLOSED CAP	2	PZ																																																																																						
RC1356A0	"STRAIGHT THREADED FEMALE END 8X1/4" BS	1	PZ																																																																																						
TB2820A0	6X10 EPDM PIPE FOR WASHING SYSTEM	1.410	M																																																																																						
TB3132A0	WHITE-BLUE EPDM TEXTILE BRAID HOSE 6X12	0.770	M																																																																																						
VH1220A1	4,2X12 TCB SELF-TAPPIN G SCREW	3	PZ																																																																																						
VL1019A0	VIBRATION PUMP	1	PZ																																																																																						
VL1047A1	D6 PIPE HOLDER - D8 J.G. TERMINAL	1	PZ																																																																																						
VL1065A1	1/4 MALE N.O. PRESSURE SWITCH	1	PZ																																																																																						
VL1102A1	DETERGENT LINE FILTER + BARBED VNR 6 MM	1	PZ																																																																																						
VL1128A0	D6 BARBED CHECK VALVE	2	PZ																																																																																						
VL1128A1	D6 BARBED CHECK VALVE	2	PZ																																																																																						

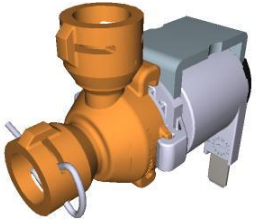
COMPONENT			SPARE PART																																															
Code	Description	Image	Code	Description	Components list																																													
EL1440A	WATER SELF CLEANING VALVE		KVL1183A	1 ROTOR ARM PLUS CLEANING SYSTEM KIT	<table border="1"> <thead> <tr> <th>Code</th> <th>Description</th> <th>Qty</th> <th>UOM</th> </tr> </thead> <tbody> <tr> <td>VL1165A0</td> <td>BB6-AR6 STRAIGHT FITTING</td> <td>1</td> <td>PZ</td> </tr> <tr> <td>VL1166A0</td> <td>BB6-AR6 L FITTING</td> <td>3</td> <td>PZ</td> </tr> <tr> <td>VL1174C0</td> <td>D1.2 MM CALIBRATED NOZZLE</td> <td>1</td> <td>PZ</td> </tr> <tr> <td>VL1185A0</td> <td>2 WAYS PLUS WASHING DISTRIBUTOR</td> <td>1</td> <td>PZ</td> </tr> <tr> <td>VL1190A0</td> <td>PLUS WASHING SYSTEM INLET DISTRIBUTOR</td> <td>1</td> <td>PZ</td> </tr> <tr> <td>VM1605A0</td> <td>CLIP TWIST LOCK DIAM. 10,2-12,7 MM</td> <td>3</td> <td>PZ</td> </tr> <tr> <td>VM2172A0</td> <td>PUMP-WITH-CI RCUIT LOCKING PIN</td> <td>7</td> <td>PZ</td> </tr> </tbody> </table>	Code	Description	Qty	UOM	VL1165A0	BB6-AR6 STRAIGHT FITTING	1	PZ	VL1166A0	BB6-AR6 L FITTING	3	PZ	VL1174C0	D1.2 MM CALIBRATED NOZZLE	1	PZ	VL1185A0	2 WAYS PLUS WASHING DISTRIBUTOR	1	PZ	VL1190A0	PLUS WASHING SYSTEM INLET DISTRIBUTOR	1	PZ	VM1605A0	CLIP TWIST LOCK DIAM. 10,2-12,7 MM	3	PZ	VM2172A0	PUMP-WITH-CI RCUIT LOCKING PIN	7	PZ													
			Code	Description	Qty	UOM																																												
VL1165A0	BB6-AR6 STRAIGHT FITTING	1	PZ																																															
VL1166A0	BB6-AR6 L FITTING	3	PZ																																															
VL1174C0	D1.2 MM CALIBRATED NOZZLE	1	PZ																																															
VL1185A0	2 WAYS PLUS WASHING DISTRIBUTOR	1	PZ																																															
VL1190A0	PLUS WASHING SYSTEM INLET DISTRIBUTOR	1	PZ																																															
VM1605A0	CLIP TWIST LOCK DIAM. 10,2-12,7 MM	3	PZ																																															
VM2172A0	PUMP-WITH-CI RCUIT LOCKING PIN	7	PZ																																															
KVL1182A	ONE CLEANING SYSTEM KIT (0311 EXC.)	<table border="1"> <thead> <tr> <th>Code</th> <th>Description</th> <th>Qty</th> <th>UOM</th> </tr> </thead> <tbody> <tr> <td>0H2143A0</td> <td>LAMIERA BLOCCA VNR VL1128</td> <td>2</td> <td>PZ</td> </tr> <tr> <td>0H2202A1</td> <td>ONE WASHING WITH STEAM VALVE SUPPORT</td> <td>1</td> <td>PZ</td> </tr> <tr> <td>EL1440A0</td> <td>WATER SELF CLEANING VALVE</td> <td>1</td> <td>PZ</td> </tr> <tr> <td>GN1526A0</td> <td>INT. D.=6.9 TH=1.8 O-RIN</td> <td>3</td> <td>PZ</td> </tr> <tr> <td>RC1018A0</td> <td>ZINC PLATED D12 ELASTIC CLAMP</td> <td>1</td> <td>PZ</td> </tr> <tr> <td>RC1019A0</td> <td>D=10 ELASTIC CLAMP</td> <td>14</td> <td>PZ</td> </tr> <tr> <td>RC1130A0</td> <td>130X2,6 CLAM</td> <td>2</td> <td>PZ</td> </tr> <tr> <td>RC1242A0</td> <td>D=10 CLOSED CAP</td> <td>2</td> <td>PZ</td> </tr> <tr> <td>TB2820A0</td> <td>6X10 EPDM PIPE FOR WASHING SYSTEM</td> <td>1.410</td> <td>M</td> </tr> <tr> <td>TB3132A0</td> <td>WHITE-BLUE EPDM TEXTILE BRAID HOSE 6X12</td> <td>0.670</td> <td>M</td> </tr> <tr> <td>VH1220A1</td> <td>4,2X12 TCB SELF-TAPPIN G SCREW</td> <td>1</td> <td>PZ</td> </tr> </tbody> </table>	Code	Description	Qty	UOM	0H2143A0	LAMIERA BLOCCA VNR VL1128	2	PZ	0H2202A1	ONE WASHING WITH STEAM VALVE SUPPORT	1	PZ	EL1440A0	WATER SELF CLEANING VALVE	1	PZ	GN1526A0	INT. D.=6.9 TH=1.8 O-RIN	3	PZ	RC1018A0	ZINC PLATED D12 ELASTIC CLAMP	1	PZ	RC1019A0	D=10 ELASTIC CLAMP	14	PZ	RC1130A0	130X2,6 CLAM	2	PZ	RC1242A0	D=10 CLOSED CAP	2	PZ	TB2820A0	6X10 EPDM PIPE FOR WASHING SYSTEM	1.410	M	TB3132A0	WHITE-BLUE EPDM TEXTILE BRAID HOSE 6X12	0.670	M	VH1220A1	4,2X12 TCB SELF-TAPPIN G SCREW	1	PZ
Code	Description	Qty	UOM																																															
0H2143A0	LAMIERA BLOCCA VNR VL1128	2	PZ																																															
0H2202A1	ONE WASHING WITH STEAM VALVE SUPPORT	1	PZ																																															
EL1440A0	WATER SELF CLEANING VALVE	1	PZ																																															
GN1526A0	INT. D.=6.9 TH=1.8 O-RIN	3	PZ																																															
RC1018A0	ZINC PLATED D12 ELASTIC CLAMP	1	PZ																																															
RC1019A0	D=10 ELASTIC CLAMP	14	PZ																																															
RC1130A0	130X2,6 CLAM	2	PZ																																															
RC1242A0	D=10 CLOSED CAP	2	PZ																																															
TB2820A0	6X10 EPDM PIPE FOR WASHING SYSTEM	1.410	M																																															
TB3132A0	WHITE-BLUE EPDM TEXTILE BRAID HOSE 6X12	0.670	M																																															
VH1220A1	4,2X12 TCB SELF-TAPPIN G SCREW	1	PZ																																															

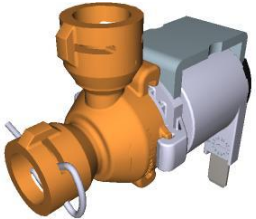

COMPONENT			SPARE PART																																																																													
Code	Description	Image	Code	Description	Components list																																																																											
EL1440A	WATER SELF CLEANING VALVE		KVL1182A	ONE CLEANING SYSTEM KIT (0311 EXC.)	<table border="1"> <thead> <tr> <th>Code</th> <th>Description</th> <th>Qty</th> <th>UOM</th> </tr> </thead> <tbody> <tr> <td>VL1019A0</td> <td>VIBRATION PUMP</td> <td>1</td> <td>PZ</td> </tr> <tr> <td>VL1047A1</td> <td>D6 PIPE HOLDER - D8 J.G. TERMINAL</td> <td>1</td> <td>PZ</td> </tr> <tr> <td>VL1054B0</td> <td>ONE WASHING SYS INLET DISTRIBUTOR</td> <td>1</td> <td>PZ</td> </tr> <tr> <td>VL1102A1</td> <td>DETERGENT LINE FILTER + BARBED VNR 6 MM</td> <td>1</td> <td>PZ</td> </tr> <tr> <td>VL1128A0</td> <td>D6 BARBED CHECK VALVE</td> <td>2</td> <td>PZ</td> </tr> <tr> <td>VL1128A1</td> <td>D6 BARBED CHECK VALVE</td> <td>2</td> <td>PZ</td> </tr> <tr> <td>VL1165A0</td> <td>BB6-AR6 STRAIGHT FITTING</td> <td>1</td> <td>PZ</td> </tr> <tr> <td>VL1166A0</td> <td>BB6-AR6 L FITTING</td> <td>1</td> <td>PZ</td> </tr> <tr> <td>VL1174C0</td> <td>D1.2 MM CALIBRATED NOZZLE</td> <td>1</td> <td>PZ</td> </tr> <tr> <td>VL1191A0</td> <td>ONE WASHING DISTRIBUTOR OUTLETS KIT</td> <td>1</td> <td>PZ</td> </tr> <tr> <td>VM1605A0</td> <td>CLIP TWIST LOCK DIAM. 10,2-12,7 MM</td> <td>3</td> <td>PZ</td> </tr> <tr> <td>VM2172A0</td> <td>PUMP-WITH-CI RCUIT LOCKING PIN</td> <td>2</td> <td>PZ</td> </tr> </tbody> </table>	Code	Description	Qty	UOM	VL1019A0	VIBRATION PUMP	1	PZ	VL1047A1	D6 PIPE HOLDER - D8 J.G. TERMINAL	1	PZ	VL1054B0	ONE WASHING SYS INLET DISTRIBUTOR	1	PZ	VL1102A1	DETERGENT LINE FILTER + BARBED VNR 6 MM	1	PZ	VL1128A0	D6 BARBED CHECK VALVE	2	PZ	VL1128A1	D6 BARBED CHECK VALVE	2	PZ	VL1165A0	BB6-AR6 STRAIGHT FITTING	1	PZ	VL1166A0	BB6-AR6 L FITTING	1	PZ	VL1174C0	D1.2 MM CALIBRATED NOZZLE	1	PZ	VL1191A0	ONE WASHING DISTRIBUTOR OUTLETS KIT	1	PZ	VM1605A0	CLIP TWIST LOCK DIAM. 10,2-12,7 MM	3	PZ	VM2172A0	PUMP-WITH-CI RCUIT LOCKING PIN	2	PZ	KEL1440A	SELF CLEANING WATER VALVE KIT	<table border="1"> <thead> <tr> <th>Code</th> <th>Description</th> <th>Qty</th> <th>UOM</th> </tr> </thead> <tbody> <tr> <td>EL1440A0</td> <td>WATER SELF CLEANING VALVE</td> <td>1</td> <td>PZ</td> </tr> <tr> <td>GN1526A0</td> <td>INT. D.=6.9 TH=1.8 O-RING</td> <td>2</td> <td>PZ</td> </tr> <tr> <td>RC1131A0</td> <td>200X2.6 BLACK CLAMP</td> <td>1</td> <td>PZ</td> </tr> <tr> <td>VM1224A0</td> <td>65MY 220MM 2 COLOURS SHRINK TUBE</td> <td>0.250</td> <td>M</td> </tr> </tbody> </table>	Code	Description	Qty	UOM	EL1440A0	WATER SELF CLEANING VALVE	1	PZ	GN1526A0	INT. D.=6.9 TH=1.8 O-RING	2	PZ	RC1131A0	200X2.6 BLACK CLAMP	1	PZ	VM1224A0	65MY 220MM 2 COLOURS SHRINK TUBE	0.250	M
			Code	Description	Qty	UOM																																																																										
VL1019A0	VIBRATION PUMP	1	PZ																																																																													
VL1047A1	D6 PIPE HOLDER - D8 J.G. TERMINAL	1	PZ																																																																													
VL1054B0	ONE WASHING SYS INLET DISTRIBUTOR	1	PZ																																																																													
VL1102A1	DETERGENT LINE FILTER + BARBED VNR 6 MM	1	PZ																																																																													
VL1128A0	D6 BARBED CHECK VALVE	2	PZ																																																																													
VL1128A1	D6 BARBED CHECK VALVE	2	PZ																																																																													
VL1165A0	BB6-AR6 STRAIGHT FITTING	1	PZ																																																																													
VL1166A0	BB6-AR6 L FITTING	1	PZ																																																																													
VL1174C0	D1.2 MM CALIBRATED NOZZLE	1	PZ																																																																													
VL1191A0	ONE WASHING DISTRIBUTOR OUTLETS KIT	1	PZ																																																																													
VM1605A0	CLIP TWIST LOCK DIAM. 10,2-12,7 MM	3	PZ																																																																													
VM2172A0	PUMP-WITH-CI RCUIT LOCKING PIN	2	PZ																																																																													
Code	Description	Qty	UOM																																																																													
EL1440A0	WATER SELF CLEANING VALVE	1	PZ																																																																													
GN1526A0	INT. D.=6.9 TH=1.8 O-RING	2	PZ																																																																													
RC1131A0	200X2.6 BLACK CLAMP	1	PZ																																																																													
VM1224A0	65MY 220MM 2 COLOURS SHRINK TUBE	0.250	M																																																																													



COMPONENT			SPARE PART																																																																														
Code	Description	Image	Code	Description	Components list																																																																												
VL1166A	BB6-AR6 L FITTING		KVL2618A	2 ROTOR ARMS ONE CLEANING SYSTEM KIT	<table border="1"> <thead> <tr> <th>Code</th> <th>Description</th> <th>Qty</th> <th>UOM</th> </tr> </thead> <tbody> <tr> <td>0H2202A1</td> <td>ONE WASHING WITH STEAM VALVE SUPPORT</td> <td>2</td> <td>PZ</td> </tr> <tr> <td>CE1030A0</td> <td>FEMALE FASTON COVER 6.3X0.8 0,5-1MMQ</td> <td>4</td> <td>PZ</td> </tr> <tr> <td>CE1395A0</td> <td>6,3 X 0,8 IMALE FASTO</td> <td>2</td> <td>PZ</td> </tr> <tr> <td>CE1545A0</td> <td>BLUE UNIP AWG18 ST.3135 WIRE</td> <td>1</td> <td>M</td> </tr> <tr> <td>CE1570A0</td> <td>WHITE UNIP AWG18 ST.3135 WIRE</td> <td>1</td> <td>M</td> </tr> <tr> <td>CE1660A0</td> <td>6,3X0,8 FEMALE FASTON COVE</td> <td>4</td> <td>PZ</td> </tr> <tr> <td>CE1661A0</td> <td>MALE FASTON COVER 6,3X0,</td> <td>2</td> <td>PZ</td> </tr> <tr> <td>EL1020A1</td> <td>D8 INTERMEDIAT E T-SHAPED FITTING</td> <td>1</td> <td>PZ</td> </tr> <tr> <td>EL1440A0</td> <td>WATER SELF CLEANING VALVE</td> <td>2</td> <td>PZ</td> </tr> <tr> <td>GN1526A0</td> <td>INT. D.=6.9 TH=1.8 O-RIN</td> <td>6</td> <td>PZ</td> </tr> <tr> <td>IP1385A1</td> <td>CORNER POLYSTYREN E PACKING 110X80X2000</td> <td>0.500</td> <td>M</td> </tr> <tr> <td>RC1018A0</td> <td>ZINC PLATED D12 ELASTIC CLAMP</td> <td>4</td> <td>PZ</td> </tr> <tr> <td>RC1019A0</td> <td>D=10 ELASTIC CLAMP</td> <td>31</td> <td>PZ</td> </tr> <tr> <td>RC1130A0</td> <td>130X2,6 CLAM</td> <td>4</td> <td>PZ</td> </tr> <tr> <td>RC1242A0</td> <td>D=10 CLOSED CAP</td> <td>4</td> <td>PZ</td> </tr> <tr> <td>TB2820A0</td> <td>6X10 EPDM PIPE FOR WASHING SYSTEM</td> <td>2.920</td> <td>M</td> </tr> <tr> <td>TB3132A0</td> <td>WHITE-BLUE EPDM TEXTILE BRAID HOSE 6X12</td> <td>1.340</td> <td>M</td> </tr> <tr> <td>VI1220A1</td> <td>4,2X12 TCB SELF-TAPPIN G SCREW</td> <td>2</td> <td>PZ</td> </tr> </tbody> </table>	Code	Description	Qty	UOM	0H2202A1	ONE WASHING WITH STEAM VALVE SUPPORT	2	PZ	CE1030A0	FEMALE FASTON COVER 6.3X0.8 0,5-1MMQ	4	PZ	CE1395A0	6,3 X 0,8 IMALE FASTO	2	PZ	CE1545A0	BLUE UNIP AWG18 ST.3135 WIRE	1	M	CE1570A0	WHITE UNIP AWG18 ST.3135 WIRE	1	M	CE1660A0	6,3X0,8 FEMALE FASTON COVE	4	PZ	CE1661A0	MALE FASTON COVER 6,3X0,	2	PZ	EL1020A1	D8 INTERMEDIAT E T-SHAPED FITTING	1	PZ	EL1440A0	WATER SELF CLEANING VALVE	2	PZ	GN1526A0	INT. D.=6.9 TH=1.8 O-RIN	6	PZ	IP1385A1	CORNER POLYSTYREN E PACKING 110X80X2000	0.500	M	RC1018A0	ZINC PLATED D12 ELASTIC CLAMP	4	PZ	RC1019A0	D=10 ELASTIC CLAMP	31	PZ	RC1130A0	130X2,6 CLAM	4	PZ	RC1242A0	D=10 CLOSED CAP	4	PZ	TB2820A0	6X10 EPDM PIPE FOR WASHING SYSTEM	2.920	M	TB3132A0	WHITE-BLUE EPDM TEXTILE BRAID HOSE 6X12	1.340	M	VI1220A1	4,2X12 TCB SELF-TAPPIN G SCREW	2	PZ
Code	Description	Qty	UOM																																																																														
0H2202A1	ONE WASHING WITH STEAM VALVE SUPPORT	2	PZ																																																																														
CE1030A0	FEMALE FASTON COVER 6.3X0.8 0,5-1MMQ	4	PZ																																																																														
CE1395A0	6,3 X 0,8 IMALE FASTO	2	PZ																																																																														
CE1545A0	BLUE UNIP AWG18 ST.3135 WIRE	1	M																																																																														
CE1570A0	WHITE UNIP AWG18 ST.3135 WIRE	1	M																																																																														
CE1660A0	6,3X0,8 FEMALE FASTON COVE	4	PZ																																																																														
CE1661A0	MALE FASTON COVER 6,3X0,	2	PZ																																																																														
EL1020A1	D8 INTERMEDIAT E T-SHAPED FITTING	1	PZ																																																																														
EL1440A0	WATER SELF CLEANING VALVE	2	PZ																																																																														
GN1526A0	INT. D.=6.9 TH=1.8 O-RIN	6	PZ																																																																														
IP1385A1	CORNER POLYSTYREN E PACKING 110X80X2000	0.500	M																																																																														
RC1018A0	ZINC PLATED D12 ELASTIC CLAMP	4	PZ																																																																														
RC1019A0	D=10 ELASTIC CLAMP	31	PZ																																																																														
RC1130A0	130X2,6 CLAM	4	PZ																																																																														
RC1242A0	D=10 CLOSED CAP	4	PZ																																																																														
TB2820A0	6X10 EPDM PIPE FOR WASHING SYSTEM	2.920	M																																																																														
TB3132A0	WHITE-BLUE EPDM TEXTILE BRAID HOSE 6X12	1.340	M																																																																														
VI1220A1	4,2X12 TCB SELF-TAPPIN G SCREW	2	PZ																																																																														

COMPONENT			SPARE PART																																																		
Code	Description	Image	Code	Description	Components list																																																
VL1166A	BB6-AR6 L FITTING		KVL2618A	2 ROTOR ARMS ONE CLEANING SYSTEM KIT	<table border="1"> <thead> <tr> <th>Code</th> <th>Description</th> <th>Qty</th> <th>UOM</th> </tr> </thead> <tbody> <tr> <td>VL1019A0</td> <td>VIBRATION PUMP</td> <td>2</td> <td>PZ</td> </tr> <tr> <td>VL1047A1</td> <td>D6 PIPE HOLDER - D8 J.G. TERMINAL</td> <td>2</td> <td>PZ</td> </tr> <tr> <td>VL1054B0</td> <td>ONE WASHING SYS INLET DISTRIBUTOR</td> <td>2</td> <td>PZ</td> </tr> <tr> <td>VL1102A1</td> <td>DETERGENT LINE FILTER + BARBED VNR 6 MM</td> <td>2</td> <td>PZ</td> </tr> <tr> <td>VL1127A1</td> <td>6MM BARBED T-SHAPED FITTING</td> <td>1</td> <td>PZ</td> </tr> <tr> <td>VL1128A1</td> <td>D6 BARBED CHECK VALVE</td> <td>4</td> <td>PZ</td> </tr> <tr> <td>VL1165A0</td> <td>BB6-AR6 STRAIGHT FITTING</td> <td>2</td> <td>PZ</td> </tr> <tr> <td>VL1166A0</td> <td>BB6-AR6 L FITTING</td> <td>2</td> <td>PZ</td> </tr> <tr> <td>VL1174C0</td> <td>D1.2 MM CALIBRATED NOZZLE</td> <td>2</td> <td>PZ</td> </tr> <tr> <td>VL1191A0</td> <td>ONE WASHING DISTRIBUTOR OUTLETS KIT</td> <td>2</td> <td>PZ</td> </tr> <tr> <td>VM2172A0</td> <td>PUMP-WITH-CI RCUIT LOCKING PIN</td> <td>4</td> <td>PZ</td> </tr> </tbody> </table>	Code	Description	Qty	UOM	VL1019A0	VIBRATION PUMP	2	PZ	VL1047A1	D6 PIPE HOLDER - D8 J.G. TERMINAL	2	PZ	VL1054B0	ONE WASHING SYS INLET DISTRIBUTOR	2	PZ	VL1102A1	DETERGENT LINE FILTER + BARBED VNR 6 MM	2	PZ	VL1127A1	6MM BARBED T-SHAPED FITTING	1	PZ	VL1128A1	D6 BARBED CHECK VALVE	4	PZ	VL1165A0	BB6-AR6 STRAIGHT FITTING	2	PZ	VL1166A0	BB6-AR6 L FITTING	2	PZ	VL1174C0	D1.2 MM CALIBRATED NOZZLE	2	PZ	VL1191A0	ONE WASHING DISTRIBUTOR OUTLETS KIT	2	PZ	VM2172A0	PUMP-WITH-CI RCUIT LOCKING PIN	4	PZ
Code	Description	Qty	UOM																																																		
VL1019A0	VIBRATION PUMP	2	PZ																																																		
VL1047A1	D6 PIPE HOLDER - D8 J.G. TERMINAL	2	PZ																																																		
VL1054B0	ONE WASHING SYS INLET DISTRIBUTOR	2	PZ																																																		
VL1102A1	DETERGENT LINE FILTER + BARBED VNR 6 MM	2	PZ																																																		
VL1127A1	6MM BARBED T-SHAPED FITTING	1	PZ																																																		
VL1128A1	D6 BARBED CHECK VALVE	4	PZ																																																		
VL1165A0	BB6-AR6 STRAIGHT FITTING	2	PZ																																																		
VL1166A0	BB6-AR6 L FITTING	2	PZ																																																		
VL1174C0	D1.2 MM CALIBRATED NOZZLE	2	PZ																																																		
VL1191A0	ONE WASHING DISTRIBUTOR OUTLETS KIT	2	PZ																																																		
VM2172A0	PUMP-WITH-CI RCUIT LOCKING PIN	4	PZ																																																		
			KVL1225A	US HOOD WASHING SYSTEM KIT	<table border="1"> <thead> <tr> <th>Code</th> <th>Description</th> <th>Qty</th> <th>UOM</th> </tr> </thead> <tbody> <tr> <td>0H2213A1</td> <td></td> <td>1</td> <td>PZ</td> </tr> <tr> <td>EL1450A0</td> <td>US SELF-CLEANING WATER SOLENOID</td> <td>2</td> <td>PZ</td> </tr> <tr> <td>GN1526A0</td> <td>INT. D.=6.9 TH=1.8 O-RING</td> <td>5</td> <td>PZ</td> </tr> <tr> <td>RC1018A0</td> <td>ZINC PLATED D12 ELASTIC CLAMP</td> <td>5</td> <td>PZ</td> </tr> <tr> <td>RC1019A0</td> <td>D=10 ELASTIC CLAMP</td> <td>16</td> <td>PZ</td> </tr> <tr> <td>RC1131A0</td> <td>200X2.6 BLACK CLAMP</td> <td>1</td> <td>PZ</td> </tr> <tr> <td>RC1242A0</td> <td>D=10 CLOSED CAP</td> <td>2</td> <td>PZ</td> </tr> <tr> <td>TB2820A0</td> <td>6X10 EPDM PIPE FOR WASHING SYSTEM</td> <td>2.240</td> <td>M</td> </tr> </tbody> </table>	Code	Description	Qty	UOM	0H2213A1		1	PZ	EL1450A0	US SELF-CLEANING WATER SOLENOID	2	PZ	GN1526A0	INT. D.=6.9 TH=1.8 O-RING	5	PZ	RC1018A0	ZINC PLATED D12 ELASTIC CLAMP	5	PZ	RC1019A0	D=10 ELASTIC CLAMP	16	PZ	RC1131A0	200X2.6 BLACK CLAMP	1	PZ	RC1242A0	D=10 CLOSED CAP	2	PZ	TB2820A0	6X10 EPDM PIPE FOR WASHING SYSTEM	2.240	M												
Code	Description	Qty	UOM																																																		
0H2213A1		1	PZ																																																		
EL1450A0	US SELF-CLEANING WATER SOLENOID	2	PZ																																																		
GN1526A0	INT. D.=6.9 TH=1.8 O-RING	5	PZ																																																		
RC1018A0	ZINC PLATED D12 ELASTIC CLAMP	5	PZ																																																		
RC1019A0	D=10 ELASTIC CLAMP	16	PZ																																																		
RC1131A0	200X2.6 BLACK CLAMP	1	PZ																																																		
RC1242A0	D=10 CLOSED CAP	2	PZ																																																		
TB2820A0	6X10 EPDM PIPE FOR WASHING SYSTEM	2.240	M																																																		



COMPONENT			SPARE PART																																																														
Code	Description	Image	Code	Description	Components list																																																												
VL1166A	BB6-AR6 L FITTING		KVL1225A	US HOOD WASHING SYSTEM KIT	<table border="1"> <thead> <tr> <th>Code</th> <th>Description</th> <th>Qty</th> <th>UOM</th> </tr> </thead> <tbody> <tr> <td>TB3132A0</td> <td>WHITE-BLUE EPDM TEXTILE BRAID HOSE 6X12</td> <td>0.440</td> <td>M</td> </tr> <tr> <td>VI1220A1</td> <td>4,2X12 TCB SELF-TAPPING SCREW</td> <td>3</td> <td>PZ</td> </tr> <tr> <td>VL1019A0</td> <td>VIBRATION PUMP</td> <td>1</td> <td>PZ</td> </tr> <tr> <td>VL1047A1</td> <td>D6 PIPE HOLDER - D8 J.G. TERMINAL</td> <td>1</td> <td>PZ</td> </tr> <tr> <td>VL1054B0</td> <td>ONE WASHING SYS INLET DISTRIBUTOR</td> <td>1</td> <td>PZ</td> </tr> <tr> <td>VL1102A1</td> <td>DETERGENT LINE FILTER + BARBED VNR 6 MM</td> <td>1</td> <td>PZ</td> </tr> <tr> <td>VL1127A1</td> <td>6MM BARBED T-SHAPED FITTING</td> <td>1</td> <td>PZ</td> </tr> <tr> <td>VL1128A1</td> <td>D6 BARBED CHECK VALVE</td> <td>2</td> <td>PZ</td> </tr> <tr> <td>VL1165A0</td> <td>BB6-AR6 STRAIGHT FITTING</td> <td>2</td> <td>PZ</td> </tr> <tr> <td>VL1166A0</td> <td>BB6-AR6 L FITTING</td> <td>2</td> <td>PZ</td> </tr> <tr> <td>VL1174C0</td> <td>D1.2 MM CALIBRATED NOZZLE</td> <td>1</td> <td>PZ</td> </tr> <tr> <td>VL1191A0</td> <td>ONE WASHING DISTRIBUTOR OUTLETS KIT</td> <td>1</td> <td>PZ</td> </tr> <tr> <td>VM1605A0</td> <td>CLIP TWIST LOCK DIAM. 10,2-12,7 MM</td> <td>2</td> <td>PZ</td> </tr> <tr> <td>VM2172A0</td> <td>PUMP-WITH-CIRCUIT LOCKING PIN</td> <td>5</td> <td>PZ</td> </tr> </tbody> </table>	Code	Description	Qty	UOM	TB3132A0	WHITE-BLUE EPDM TEXTILE BRAID HOSE 6X12	0.440	M	VI1220A1	4,2X12 TCB SELF-TAPPING SCREW	3	PZ	VL1019A0	VIBRATION PUMP	1	PZ	VL1047A1	D6 PIPE HOLDER - D8 J.G. TERMINAL	1	PZ	VL1054B0	ONE WASHING SYS INLET DISTRIBUTOR	1	PZ	VL1102A1	DETERGENT LINE FILTER + BARBED VNR 6 MM	1	PZ	VL1127A1	6MM BARBED T-SHAPED FITTING	1	PZ	VL1128A1	D6 BARBED CHECK VALVE	2	PZ	VL1165A0	BB6-AR6 STRAIGHT FITTING	2	PZ	VL1166A0	BB6-AR6 L FITTING	2	PZ	VL1174C0	D1.2 MM CALIBRATED NOZZLE	1	PZ	VL1191A0	ONE WASHING DISTRIBUTOR OUTLETS KIT	1	PZ	VM1605A0	CLIP TWIST LOCK DIAM. 10,2-12,7 MM	2	PZ	VM2172A0	PUMP-WITH-CIRCUIT LOCKING PIN	5	PZ
Code	Description	Qty	UOM																																																														
TB3132A0	WHITE-BLUE EPDM TEXTILE BRAID HOSE 6X12	0.440	M																																																														
VI1220A1	4,2X12 TCB SELF-TAPPING SCREW	3	PZ																																																														
VL1019A0	VIBRATION PUMP	1	PZ																																																														
VL1047A1	D6 PIPE HOLDER - D8 J.G. TERMINAL	1	PZ																																																														
VL1054B0	ONE WASHING SYS INLET DISTRIBUTOR	1	PZ																																																														
VL1102A1	DETERGENT LINE FILTER + BARBED VNR 6 MM	1	PZ																																																														
VL1127A1	6MM BARBED T-SHAPED FITTING	1	PZ																																																														
VL1128A1	D6 BARBED CHECK VALVE	2	PZ																																																														
VL1165A0	BB6-AR6 STRAIGHT FITTING	2	PZ																																																														
VL1166A0	BB6-AR6 L FITTING	2	PZ																																																														
VL1174C0	D1.2 MM CALIBRATED NOZZLE	1	PZ																																																														
VL1191A0	ONE WASHING DISTRIBUTOR OUTLETS KIT	1	PZ																																																														
VM1605A0	CLIP TWIST LOCK DIAM. 10,2-12,7 MM	2	PZ																																																														
VM2172A0	PUMP-WITH-CIRCUIT LOCKING PIN	5	PZ																																																														
			KVL1222A	EUR 0311 ONE PLUS CLEANING SYSTEM KIT	<table border="1"> <thead> <tr> <th>Code</th> <th>Description</th> <th>Qty</th> <th>UOM</th> </tr> </thead> <tbody> <tr> <td>0H2486A0</td> <td></td> <td>1</td> <td>PZ</td> </tr> <tr> <td>EL1440A0</td> <td>WATER SELF CLEANING VALVE</td> <td>1</td> <td>PZ</td> </tr> <tr> <td>GN1526A0</td> <td>INT. D.=6.9 TH=1.8 O-RING</td> <td>3</td> <td>PZ</td> </tr> <tr> <td>RC1018A0</td> <td>ZINC PLATED D12 ELASTIC CLAMP</td> <td>2</td> <td>PZ</td> </tr> </tbody> </table>	Code	Description	Qty	UOM	0H2486A0		1	PZ	EL1440A0	WATER SELF CLEANING VALVE	1	PZ	GN1526A0	INT. D.=6.9 TH=1.8 O-RING	3	PZ	RC1018A0	ZINC PLATED D12 ELASTIC CLAMP	2	PZ																																								
Code	Description	Qty	UOM																																																														
0H2486A0		1	PZ																																																														
EL1440A0	WATER SELF CLEANING VALVE	1	PZ																																																														
GN1526A0	INT. D.=6.9 TH=1.8 O-RING	3	PZ																																																														
RC1018A0	ZINC PLATED D12 ELASTIC CLAMP	2	PZ																																																														

COMPONENT			SPARE PART																																																																																	
Code	Description	Image	Code	Description	Components list																																																																															
VL1166A	BB6-AR6 L FITTING		KVL1222A	EUR 0311 ONE PLUS CLEANING SYSTEM KIT	<table border="1"> <thead> <tr> <th>Code</th> <th>Description</th> <th>Qty</th> <th>UOM</th> </tr> </thead> <tbody> <tr> <td>RC1019A0</td> <td>D=10 ELASTIC CLAMP</td> <td>14</td> <td>PZ</td> </tr> <tr> <td>RC1242A0</td> <td>D=10 CLOSED CAP</td> <td>2</td> <td>PZ</td> </tr> <tr> <td>TB2820A0</td> <td>6X10 EPDM PIPE FOR WASHING SYSTEM</td> <td>1.460</td> <td>M</td> </tr> <tr> <td>TB3132A0</td> <td>WHITE-BLUE EPDM TEXTILE BRAID HOSE 6X12</td> <td>0.670</td> <td>M</td> </tr> <tr> <td>VI1220A1</td> <td>4,2X12 TCB SELF-TAPPIN G SCREW</td> <td>4</td> <td>PZ</td> </tr> <tr> <td>VL1019A0</td> <td>VIBRATION PUMP</td> <td>1</td> <td>PZ</td> </tr> <tr> <td>VL1047A1</td> <td>D6 PIPE HOLDER - D8 J.G. TERMINAL</td> <td>1</td> <td>PZ</td> </tr> <tr> <td>VL1054B0</td> <td>ONE WASHING SYS INLET DISTRIBUTOR</td> <td>1</td> <td>PZ</td> </tr> <tr> <td>VL1102A1</td> <td>DETERGENT LINE FILTER + BARBED VNR 6 MM</td> <td>1</td> <td>PZ</td> </tr> <tr> <td>VL1128A1</td> <td>D6 BARBED CHECK VALVE</td> <td>2</td> <td>PZ</td> </tr> <tr> <td>VL1165A0</td> <td>BB6-AR6 STRAIGHT FITTING</td> <td>1</td> <td>PZ</td> </tr> <tr> <td>VL1166A0</td> <td>BB6-AR6 L FITTING</td> <td>1</td> <td>PZ</td> </tr> <tr> <td>VL1174C0</td> <td>D1.2 MM CALIBRATED NOZZLE</td> <td>1</td> <td>PZ</td> </tr> <tr> <td>VL1191A0</td> <td>ONE WASHING DISTRIBUTOR OUTLETS KIT</td> <td>1</td> <td>PZ</td> </tr> <tr> <td>VM2172A0</td> <td>PUMP-WITH-CI RCUIT LOCKING PIN</td> <td>3</td> <td>PZ</td> </tr> </tbody> </table>	Code	Description	Qty	UOM	RC1019A0	D=10 ELASTIC CLAMP	14	PZ	RC1242A0	D=10 CLOSED CAP	2	PZ	TB2820A0	6X10 EPDM PIPE FOR WASHING SYSTEM	1.460	M	TB3132A0	WHITE-BLUE EPDM TEXTILE BRAID HOSE 6X12	0.670	M	VI1220A1	4,2X12 TCB SELF-TAPPIN G SCREW	4	PZ	VL1019A0	VIBRATION PUMP	1	PZ	VL1047A1	D6 PIPE HOLDER - D8 J.G. TERMINAL	1	PZ	VL1054B0	ONE WASHING SYS INLET DISTRIBUTOR	1	PZ	VL1102A1	DETERGENT LINE FILTER + BARBED VNR 6 MM	1	PZ	VL1128A1	D6 BARBED CHECK VALVE	2	PZ	VL1165A0	BB6-AR6 STRAIGHT FITTING	1	PZ	VL1166A0	BB6-AR6 L FITTING	1	PZ	VL1174C0	D1.2 MM CALIBRATED NOZZLE	1	PZ	VL1191A0	ONE WASHING DISTRIBUTOR OUTLETS KIT	1	PZ	VM2172A0	PUMP-WITH-CI RCUIT LOCKING PIN	3	PZ	KVL1213A	US PLUS COMPACT WASHING SYSTEM KIT	<table border="1"> <thead> <tr> <th>Code</th> <th>Description</th> <th>Qty</th> <th>UOM</th> </tr> </thead> <tbody> <tr> <td>0H2428A0</td> <td>US</td> <td>1</td> <td>PZ</td> </tr> <tr> <td>EL1450A0</td> <td>SELF-CLEANIN G WATER SOLENOID</td> <td>3</td> <td>PZ</td> </tr> </tbody> </table>	Code	Description	Qty	UOM	0H2428A0	US	1	PZ	EL1450A0	SELF-CLEANIN G WATER SOLENOID	3	PZ
			Code	Description	Qty	UOM																																																																														
RC1019A0	D=10 ELASTIC CLAMP	14	PZ																																																																																	
RC1242A0	D=10 CLOSED CAP	2	PZ																																																																																	
TB2820A0	6X10 EPDM PIPE FOR WASHING SYSTEM	1.460	M																																																																																	
TB3132A0	WHITE-BLUE EPDM TEXTILE BRAID HOSE 6X12	0.670	M																																																																																	
VI1220A1	4,2X12 TCB SELF-TAPPIN G SCREW	4	PZ																																																																																	
VL1019A0	VIBRATION PUMP	1	PZ																																																																																	
VL1047A1	D6 PIPE HOLDER - D8 J.G. TERMINAL	1	PZ																																																																																	
VL1054B0	ONE WASHING SYS INLET DISTRIBUTOR	1	PZ																																																																																	
VL1102A1	DETERGENT LINE FILTER + BARBED VNR 6 MM	1	PZ																																																																																	
VL1128A1	D6 BARBED CHECK VALVE	2	PZ																																																																																	
VL1165A0	BB6-AR6 STRAIGHT FITTING	1	PZ																																																																																	
VL1166A0	BB6-AR6 L FITTING	1	PZ																																																																																	
VL1174C0	D1.2 MM CALIBRATED NOZZLE	1	PZ																																																																																	
VL1191A0	ONE WASHING DISTRIBUTOR OUTLETS KIT	1	PZ																																																																																	
VM2172A0	PUMP-WITH-CI RCUIT LOCKING PIN	3	PZ																																																																																	
Code	Description	Qty	UOM																																																																																	
0H2428A0	US	1	PZ																																																																																	
EL1450A0	SELF-CLEANIN G WATER SOLENOID	3	PZ																																																																																	



COMPONENT			SPARE PART																																																																																		
Code	Description	Image	Code	Description	Components list																																																																																
VL1166A	BB6-AR6 L FITTING		KVL1213A	US PLUS COMPACT WASHING SYSTEM KIT	<table border="1"> <thead> <tr> <th>Code</th> <th>Description</th> <th>Qty</th> <th>UOM</th> </tr> </thead> <tbody> <tr> <td>GN1312A0</td> <td>RUBBER CABLE-PASSI NG DE=26 DI=15 SP=10</td> <td>1</td> <td>PZ</td> </tr> <tr> <td>GN1526A0</td> <td>INT. D.=6.9 TH=1.8 O-RIN</td> <td>7</td> <td>PZ</td> </tr> <tr> <td>RC1018A0</td> <td>ZINC PLATED D12 ELASTIC CLAMP</td> <td>3</td> <td>PZ</td> </tr> <tr> <td>RC1019A0</td> <td>D=10 ELASTIC CLAMP</td> <td>14</td> <td>PZ</td> </tr> <tr> <td>RC1130A0</td> <td>130X2,6 CLAM</td> <td>1</td> <td>PZ</td> </tr> <tr> <td>RC1131A0</td> <td>200X2.6 BLACK CLAMP</td> <td>1</td> <td>PZ</td> </tr> <tr> <td>RC1242A0</td> <td>D=10 CLOSED CAP</td> <td>2</td> <td>PZ</td> </tr> <tr> <td>RC1356A0</td> <td>"STRAIGHT THREADED FEMALE END 8X1/4" BS</td> <td>1</td> <td>PZ</td> </tr> <tr> <td>TB2820A0</td> <td>6X10 EPDM PIPE FOR WASHING SYSTEM</td> <td>0.790</td> <td>M</td> </tr> <tr> <td>TB3132A0</td> <td>WHITE-BLUE EPDM TEXTILE BRAID HOSE 6X12</td> <td>1.400</td> <td>M</td> </tr> <tr> <td>VI1220A1</td> <td>4,2X12 TCB SELF-TAPPIN G SCREW</td> <td>3</td> <td>PZ</td> </tr> <tr> <td>VL1019A0</td> <td>VIBRATION PUMP</td> <td>1</td> <td>PZ</td> </tr> <tr> <td>VL1047A1</td> <td>D6 PIPE HOLDER - D8 J.G. TERMINAL</td> <td>1</td> <td>PZ</td> </tr> <tr> <td>VL1054B0</td> <td>ONE WASHING SYS INLET DISTRIBUTOR</td> <td>1</td> <td>PZ</td> </tr> <tr> <td>VL1065A1</td> <td>1/4 MALE N.O. PRESSURE SWITCH</td> <td>1</td> <td>PZ</td> </tr> <tr> <td>VL1102A1</td> <td>DETERGENT LINE FILTER + BARBED VNR 6 MM</td> <td>1</td> <td>PZ</td> </tr> <tr> <td>VL1128A1</td> <td>D6 BARBED CHECK VALVE</td> <td>2</td> <td>PZ</td> </tr> <tr> <td>VL1165A0</td> <td>BB6-AR6 STRAIGHT FITTING</td> <td>1</td> <td>PZ</td> </tr> <tr> <td>VL1166A0</td> <td>BB6-AR6 L FITTING</td> <td>3</td> <td>PZ</td> </tr> </tbody> </table>	Code	Description	Qty	UOM	GN1312A0	RUBBER CABLE-PASSI NG DE=26 DI=15 SP=10	1	PZ	GN1526A0	INT. D.=6.9 TH=1.8 O-RIN	7	PZ	RC1018A0	ZINC PLATED D12 ELASTIC CLAMP	3	PZ	RC1019A0	D=10 ELASTIC CLAMP	14	PZ	RC1130A0	130X2,6 CLAM	1	PZ	RC1131A0	200X2.6 BLACK CLAMP	1	PZ	RC1242A0	D=10 CLOSED CAP	2	PZ	RC1356A0	"STRAIGHT THREADED FEMALE END 8X1/4" BS	1	PZ	TB2820A0	6X10 EPDM PIPE FOR WASHING SYSTEM	0.790	M	TB3132A0	WHITE-BLUE EPDM TEXTILE BRAID HOSE 6X12	1.400	M	VI1220A1	4,2X12 TCB SELF-TAPPIN G SCREW	3	PZ	VL1019A0	VIBRATION PUMP	1	PZ	VL1047A1	D6 PIPE HOLDER - D8 J.G. TERMINAL	1	PZ	VL1054B0	ONE WASHING SYS INLET DISTRIBUTOR	1	PZ	VL1065A1	1/4 MALE N.O. PRESSURE SWITCH	1	PZ	VL1102A1	DETERGENT LINE FILTER + BARBED VNR 6 MM	1	PZ	VL1128A1	D6 BARBED CHECK VALVE	2	PZ	VL1165A0	BB6-AR6 STRAIGHT FITTING	1	PZ	VL1166A0	BB6-AR6 L FITTING	3	PZ
Code	Description	Qty	UOM																																																																																		
GN1312A0	RUBBER CABLE-PASSI NG DE=26 DI=15 SP=10	1	PZ																																																																																		
GN1526A0	INT. D.=6.9 TH=1.8 O-RIN	7	PZ																																																																																		
RC1018A0	ZINC PLATED D12 ELASTIC CLAMP	3	PZ																																																																																		
RC1019A0	D=10 ELASTIC CLAMP	14	PZ																																																																																		
RC1130A0	130X2,6 CLAM	1	PZ																																																																																		
RC1131A0	200X2.6 BLACK CLAMP	1	PZ																																																																																		
RC1242A0	D=10 CLOSED CAP	2	PZ																																																																																		
RC1356A0	"STRAIGHT THREADED FEMALE END 8X1/4" BS	1	PZ																																																																																		
TB2820A0	6X10 EPDM PIPE FOR WASHING SYSTEM	0.790	M																																																																																		
TB3132A0	WHITE-BLUE EPDM TEXTILE BRAID HOSE 6X12	1.400	M																																																																																		
VI1220A1	4,2X12 TCB SELF-TAPPIN G SCREW	3	PZ																																																																																		
VL1019A0	VIBRATION PUMP	1	PZ																																																																																		
VL1047A1	D6 PIPE HOLDER - D8 J.G. TERMINAL	1	PZ																																																																																		
VL1054B0	ONE WASHING SYS INLET DISTRIBUTOR	1	PZ																																																																																		
VL1065A1	1/4 MALE N.O. PRESSURE SWITCH	1	PZ																																																																																		
VL1102A1	DETERGENT LINE FILTER + BARBED VNR 6 MM	1	PZ																																																																																		
VL1128A1	D6 BARBED CHECK VALVE	2	PZ																																																																																		
VL1165A0	BB6-AR6 STRAIGHT FITTING	1	PZ																																																																																		
VL1166A0	BB6-AR6 L FITTING	3	PZ																																																																																		



COMPONENT			SPARE PART																																																																						
Code	Description	Image	Code	Description	Components list																																																																				
VL1166A	BB6-AR6 L FITTING		KVL1213A	US PLUS COMPACT WASHING SYSTEM KIT	<table border="1"> <thead> <tr> <th>Code</th> <th>Description</th> <th>Qty</th> <th>UOM</th> </tr> </thead> <tbody> <tr> <td>VL1174C0</td> <td>D1.2 MM CALIBRATED NOZZLE</td> <td>1</td> <td>PZ</td> </tr> <tr> <td>VL1185A0</td> <td>2 WAYS PLUS WASHING DISTRIBUTOR</td> <td>1</td> <td>PZ</td> </tr> <tr> <td>VM2172A0</td> <td>PUMP-WITH-CI RCUIT LOCKING PIN</td> <td>6</td> <td>PZ</td> </tr> </tbody> </table>	Code	Description	Qty	UOM	VL1174C0	D1.2 MM CALIBRATED NOZZLE	1	PZ	VL1185A0	2 WAYS PLUS WASHING DISTRIBUTOR	1	PZ	VM2172A0	PUMP-WITH-CI RCUIT LOCKING PIN	6	PZ																																																				
Code	Description	Qty	UOM																																																																						
VL1174C0	D1.2 MM CALIBRATED NOZZLE	1	PZ																																																																						
VL1185A0	2 WAYS PLUS WASHING DISTRIBUTOR	1	PZ																																																																						
VM2172A0	PUMP-WITH-CI RCUIT LOCKING PIN	6	PZ																																																																						
			KVL1212A	EUR COMPACT PLUS CLEANING SYSTEM KIT	<table border="1"> <thead> <tr> <th>Code</th> <th>Description</th> <th>Qty</th> <th>UOM</th> </tr> </thead> <tbody> <tr> <td>0H2428A0</td> <td></td> <td>1</td> <td>PZ</td> </tr> <tr> <td>EL1440A0</td> <td>WATER SELF CLEANING VALVE</td> <td>3</td> <td>PZ</td> </tr> <tr> <td>GN1312A0</td> <td>RUBBER CABLE-PASSI NG DE=26 DI=15 SP=10</td> <td>1</td> <td>PZ</td> </tr> <tr> <td>GN1526A0</td> <td>INT. D.=6.9 TH=1.8 O-RIN</td> <td>7</td> <td>PZ</td> </tr> <tr> <td>RC1018A0</td> <td>ZINC PLATED D12 ELASTIC CLAMP</td> <td>3</td> <td>PZ</td> </tr> <tr> <td>RC1019A0</td> <td>D=10 ELASTIC CLAMP</td> <td>14</td> <td>PZ</td> </tr> <tr> <td>RC1130A0</td> <td>130X2,6 CLAM</td> <td>1</td> <td>PZ</td> </tr> <tr> <td>RC1131A0</td> <td>200X2,6 BLACK CLAMP</td> <td>1</td> <td>PZ</td> </tr> <tr> <td>RC1242A0</td> <td>D=10 CLOSED CAP</td> <td>2</td> <td>PZ</td> </tr> <tr> <td>RC1356A0</td> <td>"STRAIGHT THREADED FEMALE END 8X1/4" BS</td> <td>1</td> <td>PZ</td> </tr> <tr> <td>TB2820A0</td> <td>6X10 EPDM PIPE FOR WASHING SYSTEM</td> <td>1.340</td> <td>M</td> </tr> <tr> <td>TB3132A0</td> <td>WHITE-BLUE EPDM TEXTILE BRAID HOSE 6X12</td> <td>1.400</td> <td>M</td> </tr> <tr> <td>VI1220A1</td> <td>4,2X12 TCB SELF-TAPPIN G SCREW</td> <td>3</td> <td>PZ</td> </tr> <tr> <td>VL1019A0</td> <td>VIBRATION PUMP</td> <td>1</td> <td>PZ</td> </tr> <tr> <td>VL1047A1</td> <td>D6 PIPE HOLDER - D8 J.G. TERMINAL</td> <td>1</td> <td>PZ</td> </tr> <tr> <td>VL1054B0</td> <td>ONE WASHING SYS INLET DISTRIBUTOR</td> <td>1</td> <td>PZ</td> </tr> </tbody> </table>	Code	Description	Qty	UOM	0H2428A0		1	PZ	EL1440A0	WATER SELF CLEANING VALVE	3	PZ	GN1312A0	RUBBER CABLE-PASSI NG DE=26 DI=15 SP=10	1	PZ	GN1526A0	INT. D.=6.9 TH=1.8 O-RIN	7	PZ	RC1018A0	ZINC PLATED D12 ELASTIC CLAMP	3	PZ	RC1019A0	D=10 ELASTIC CLAMP	14	PZ	RC1130A0	130X2,6 CLAM	1	PZ	RC1131A0	200X2,6 BLACK CLAMP	1	PZ	RC1242A0	D=10 CLOSED CAP	2	PZ	RC1356A0	"STRAIGHT THREADED FEMALE END 8X1/4" BS	1	PZ	TB2820A0	6X10 EPDM PIPE FOR WASHING SYSTEM	1.340	M	TB3132A0	WHITE-BLUE EPDM TEXTILE BRAID HOSE 6X12	1.400	M	VI1220A1	4,2X12 TCB SELF-TAPPIN G SCREW	3	PZ	VL1019A0	VIBRATION PUMP	1	PZ	VL1047A1	D6 PIPE HOLDER - D8 J.G. TERMINAL	1	PZ	VL1054B0	ONE WASHING SYS INLET DISTRIBUTOR	1	PZ
Code	Description	Qty	UOM																																																																						
0H2428A0		1	PZ																																																																						
EL1440A0	WATER SELF CLEANING VALVE	3	PZ																																																																						
GN1312A0	RUBBER CABLE-PASSI NG DE=26 DI=15 SP=10	1	PZ																																																																						
GN1526A0	INT. D.=6.9 TH=1.8 O-RIN	7	PZ																																																																						
RC1018A0	ZINC PLATED D12 ELASTIC CLAMP	3	PZ																																																																						
RC1019A0	D=10 ELASTIC CLAMP	14	PZ																																																																						
RC1130A0	130X2,6 CLAM	1	PZ																																																																						
RC1131A0	200X2,6 BLACK CLAMP	1	PZ																																																																						
RC1242A0	D=10 CLOSED CAP	2	PZ																																																																						
RC1356A0	"STRAIGHT THREADED FEMALE END 8X1/4" BS	1	PZ																																																																						
TB2820A0	6X10 EPDM PIPE FOR WASHING SYSTEM	1.340	M																																																																						
TB3132A0	WHITE-BLUE EPDM TEXTILE BRAID HOSE 6X12	1.400	M																																																																						
VI1220A1	4,2X12 TCB SELF-TAPPIN G SCREW	3	PZ																																																																						
VL1019A0	VIBRATION PUMP	1	PZ																																																																						
VL1047A1	D6 PIPE HOLDER - D8 J.G. TERMINAL	1	PZ																																																																						
VL1054B0	ONE WASHING SYS INLET DISTRIBUTOR	1	PZ																																																																						

COMPONENT			SPARE PART																																																						
Code	Description	Image	Code	Description	Components list																																																				
VL1166A	BB6-AR6 L FITTING		KVL1212A	EUR COMPACT PLUS CLEANING SYSTEM KIT	<table border="1"> <thead> <tr> <th>Code</th> <th>Description</th> <th>Qty</th> <th>UOM</th> </tr> </thead> <tbody> <tr> <td>VL1065A1</td> <td>1/4 MALE N.O. PRESSURE SWITCH</td> <td>1</td> <td>PZ</td> </tr> <tr> <td>VL1102A1</td> <td>DETERGENT LINE FILTER + BARBED VNR 6 MM</td> <td>1</td> <td>PZ</td> </tr> <tr> <td>VL1128A1</td> <td>D6 BARBED CHECK VALVE</td> <td>2</td> <td>PZ</td> </tr> <tr> <td>VL1165A0</td> <td>BB6-AR6 STRAIGHT FITTING</td> <td>1</td> <td>PZ</td> </tr> <tr> <td>VL1166A0</td> <td>BB6-AR6 L FITTING</td> <td>3</td> <td>PZ</td> </tr> <tr> <td>VL1174C0</td> <td>D1.2 MM CALIBRATED NOZZLE</td> <td>1</td> <td>PZ</td> </tr> <tr> <td>VL1185A0</td> <td>2 WAYS PLUS WASHING DISTRIBUTOR</td> <td>1</td> <td>PZ</td> </tr> <tr> <td>VM2172A0</td> <td>PUMP-WITH-CI RCUIT LOCKING PIN</td> <td>6</td> <td>PZ</td> </tr> </tbody> </table>	Code	Description	Qty	UOM	VL1065A1	1/4 MALE N.O. PRESSURE SWITCH	1	PZ	VL1102A1	DETERGENT LINE FILTER + BARBED VNR 6 MM	1	PZ	VL1128A1	D6 BARBED CHECK VALVE	2	PZ	VL1165A0	BB6-AR6 STRAIGHT FITTING	1	PZ	VL1166A0	BB6-AR6 L FITTING	3	PZ	VL1174C0	D1.2 MM CALIBRATED NOZZLE	1	PZ	VL1185A0	2 WAYS PLUS WASHING DISTRIBUTOR	1	PZ	VM2172A0	PUMP-WITH-CI RCUIT LOCKING PIN	6	PZ																
Code	Description	Qty	UOM																																																						
VL1065A1	1/4 MALE N.O. PRESSURE SWITCH	1	PZ																																																						
VL1102A1	DETERGENT LINE FILTER + BARBED VNR 6 MM	1	PZ																																																						
VL1128A1	D6 BARBED CHECK VALVE	2	PZ																																																						
VL1165A0	BB6-AR6 STRAIGHT FITTING	1	PZ																																																						
VL1166A0	BB6-AR6 L FITTING	3	PZ																																																						
VL1174C0	D1.2 MM CALIBRATED NOZZLE	1	PZ																																																						
VL1185A0	2 WAYS PLUS WASHING DISTRIBUTOR	1	PZ																																																						
VM2172A0	PUMP-WITH-CI RCUIT LOCKING PIN	6	PZ																																																						
			KVL1211A	ONE COMPACT AND 0523-EP WASH. SYSTEM KIT	<table border="1"> <thead> <tr> <th>Code</th> <th>Description</th> <th>Qty</th> <th>UOM</th> </tr> </thead> <tbody> <tr> <td>0H2427A0</td> <td></td> <td>1</td> <td>PZ</td> </tr> <tr> <td>EL1440A0</td> <td>WATER SELF CLEANING VALVE</td> <td>1</td> <td>PZ</td> </tr> <tr> <td>GN1526A0</td> <td>INT. D.=6.9 TH=1.8 O-RIN</td> <td>3</td> <td>PZ</td> </tr> <tr> <td>RC1018A0</td> <td>ZINC PLATED D12 ELASTIC CLAMP</td> <td>2</td> <td>PZ</td> </tr> <tr> <td>RC1019A0</td> <td>D=10 ELASTIC CLAMP</td> <td>14</td> <td>PZ</td> </tr> <tr> <td>RC1130A0</td> <td>130X2,6 CLAM</td> <td>1</td> <td>PZ</td> </tr> <tr> <td>RC1242A0</td> <td>D=10 CLOSED CAP</td> <td>2</td> <td>PZ</td> </tr> <tr> <td>TB2820A0</td> <td>6X10 EPDM PIPE FOR WASHING SYSTEM</td> <td>1.290</td> <td>M</td> </tr> <tr> <td>TB3132A0</td> <td>WHITE-BLUE EPDM TEXTILE BRAID HOSE 6X12</td> <td>0.670</td> <td>M</td> </tr> <tr> <td>VI1220A1</td> <td>4,2X12 TCB SELF-TAPPIN G SCREW</td> <td>4</td> <td>PZ</td> </tr> <tr> <td>VL1019A0</td> <td>VIBRATION PUMP</td> <td>1</td> <td>PZ</td> </tr> <tr> <td>VL1047A1</td> <td>D6 PIPE HOLDER - D8 J.G. TERMINAL</td> <td>1</td> <td>PZ</td> </tr> </tbody> </table>	Code	Description	Qty	UOM	0H2427A0		1	PZ	EL1440A0	WATER SELF CLEANING VALVE	1	PZ	GN1526A0	INT. D.=6.9 TH=1.8 O-RIN	3	PZ	RC1018A0	ZINC PLATED D12 ELASTIC CLAMP	2	PZ	RC1019A0	D=10 ELASTIC CLAMP	14	PZ	RC1130A0	130X2,6 CLAM	1	PZ	RC1242A0	D=10 CLOSED CAP	2	PZ	TB2820A0	6X10 EPDM PIPE FOR WASHING SYSTEM	1.290	M	TB3132A0	WHITE-BLUE EPDM TEXTILE BRAID HOSE 6X12	0.670	M	VI1220A1	4,2X12 TCB SELF-TAPPIN G SCREW	4	PZ	VL1019A0	VIBRATION PUMP	1	PZ	VL1047A1	D6 PIPE HOLDER - D8 J.G. TERMINAL	1	PZ
Code	Description	Qty	UOM																																																						
0H2427A0		1	PZ																																																						
EL1440A0	WATER SELF CLEANING VALVE	1	PZ																																																						
GN1526A0	INT. D.=6.9 TH=1.8 O-RIN	3	PZ																																																						
RC1018A0	ZINC PLATED D12 ELASTIC CLAMP	2	PZ																																																						
RC1019A0	D=10 ELASTIC CLAMP	14	PZ																																																						
RC1130A0	130X2,6 CLAM	1	PZ																																																						
RC1242A0	D=10 CLOSED CAP	2	PZ																																																						
TB2820A0	6X10 EPDM PIPE FOR WASHING SYSTEM	1.290	M																																																						
TB3132A0	WHITE-BLUE EPDM TEXTILE BRAID HOSE 6X12	0.670	M																																																						
VI1220A1	4,2X12 TCB SELF-TAPPIN G SCREW	4	PZ																																																						
VL1019A0	VIBRATION PUMP	1	PZ																																																						
VL1047A1	D6 PIPE HOLDER - D8 J.G. TERMINAL	1	PZ																																																						



COMPONENT			SPARE PART																																																		
Code	Description	Image	Code	Description	Components list																																																
VL1166A	BB6-AR6 L FITTING		KVL1211A	ONE COMPACT AND 0523-EP WASH. SYSTEM KIT	<table border="1"> <thead> <tr> <th>Code</th> <th>Description</th> <th>Qty</th> <th>UOM</th> </tr> </thead> <tbody> <tr> <td>VL1054B0</td> <td>ONE WASHING SYS INLET DISTRIBUTOR</td> <td>1</td> <td>PZ</td> </tr> <tr> <td>VL1102A1</td> <td>DETERGENT LINE FILTER + BARBED VNR 6 MM</td> <td>1</td> <td>PZ</td> </tr> <tr> <td>VL1128A1</td> <td>D6 BARBED CHECK VALVE</td> <td>2</td> <td>PZ</td> </tr> <tr> <td>VL1165A0</td> <td>BB6-AR6 STRAIGHT FITTING</td> <td>1</td> <td>PZ</td> </tr> <tr> <td>VL1166A0</td> <td>BB6-AR6 L FITTING</td> <td>1</td> <td>PZ</td> </tr> <tr> <td>VL1174C0</td> <td>D1.2 MM CALIBRATED NOZZLE</td> <td>1</td> <td>PZ</td> </tr> <tr> <td>VL1191A0</td> <td>ONE WASHING DISTRIBUTOR OUTLETS KIT</td> <td>1</td> <td>PZ</td> </tr> <tr> <td>VM2172A0</td> <td>PUMP-WITH-CI RCUIT LOCKING PIN</td> <td>3</td> <td>PZ</td> </tr> </tbody> </table>	Code	Description	Qty	UOM	VL1054B0	ONE WASHING SYS INLET DISTRIBUTOR	1	PZ	VL1102A1	DETERGENT LINE FILTER + BARBED VNR 6 MM	1	PZ	VL1128A1	D6 BARBED CHECK VALVE	2	PZ	VL1165A0	BB6-AR6 STRAIGHT FITTING	1	PZ	VL1166A0	BB6-AR6 L FITTING	1	PZ	VL1174C0	D1.2 MM CALIBRATED NOZZLE	1	PZ	VL1191A0	ONE WASHING DISTRIBUTOR OUTLETS KIT	1	PZ	VM2172A0	PUMP-WITH-CI RCUIT LOCKING PIN	3	PZ												
Code	Description	Qty	UOM																																																		
VL1054B0	ONE WASHING SYS INLET DISTRIBUTOR	1	PZ																																																		
VL1102A1	DETERGENT LINE FILTER + BARBED VNR 6 MM	1	PZ																																																		
VL1128A1	D6 BARBED CHECK VALVE	2	PZ																																																		
VL1165A0	BB6-AR6 STRAIGHT FITTING	1	PZ																																																		
VL1166A0	BB6-AR6 L FITTING	1	PZ																																																		
VL1174C0	D1.2 MM CALIBRATED NOZZLE	1	PZ																																																		
VL1191A0	ONE WASHING DISTRIBUTOR OUTLETS KIT	1	PZ																																																		
VM2172A0	PUMP-WITH-CI RCUIT LOCKING PIN	3	PZ																																																		
			KVL1209A	US PLUS 3 ROTOR ARMS WASHING SYSTEM KIT	<table border="1"> <thead> <tr> <th>Code</th> <th>Description</th> <th>Qty</th> <th>UOM</th> </tr> </thead> <tbody> <tr> <td>0H2354A0</td> <td>XEVC-XEVL WASHING CIRCUIT PLAT</td> <td>1</td> <td>PZ</td> </tr> <tr> <td>0H2411A0</td> <td></td> <td>1</td> <td>PZ</td> </tr> <tr> <td>EL1450A0</td> <td>US SELF-CLEANIN G WATER SOLENOID</td> <td>4</td> <td>PZ</td> </tr> <tr> <td>GN1526A0</td> <td>INT. D.=6.9 TH=1.8 O-RIN</td> <td>9</td> <td>PZ</td> </tr> <tr> <td>RC1018A0</td> <td>ZINC PLATED D12 ELASTIC CLAMP</td> <td>13</td> <td>PZ</td> </tr> <tr> <td>RC1019A0</td> <td>D=10 ELASTIC CLAMP</td> <td>15</td> <td>PZ</td> </tr> <tr> <td>RC1130A0</td> <td>130X2.6 CLAM</td> <td>1</td> <td>PZ</td> </tr> <tr> <td>RC1131A0</td> <td>200X2.6 BLACK CLAMP</td> <td>3</td> <td>PZ</td> </tr> <tr> <td>RC1242A0</td> <td>D=10 CLOSED CAP</td> <td>2</td> <td>PZ</td> </tr> <tr> <td>RC1356A0</td> <td>"STRAIGHT THREADED FEMALE END 8X1/4" BS</td> <td>1</td> <td>PZ</td> </tr> <tr> <td>TB2820A0</td> <td>6X10 EPDM PIPE FOR WASHING SYSTEM</td> <td>2.750</td> <td>M</td> </tr> </tbody> </table>	Code	Description	Qty	UOM	0H2354A0	XEVC-XEVL WASHING CIRCUIT PLAT	1	PZ	0H2411A0		1	PZ	EL1450A0	US SELF-CLEANIN G WATER SOLENOID	4	PZ	GN1526A0	INT. D.=6.9 TH=1.8 O-RIN	9	PZ	RC1018A0	ZINC PLATED D12 ELASTIC CLAMP	13	PZ	RC1019A0	D=10 ELASTIC CLAMP	15	PZ	RC1130A0	130X2.6 CLAM	1	PZ	RC1131A0	200X2.6 BLACK CLAMP	3	PZ	RC1242A0	D=10 CLOSED CAP	2	PZ	RC1356A0	"STRAIGHT THREADED FEMALE END 8X1/4" BS	1	PZ	TB2820A0	6X10 EPDM PIPE FOR WASHING SYSTEM	2.750	M
Code	Description	Qty	UOM																																																		
0H2354A0	XEVC-XEVL WASHING CIRCUIT PLAT	1	PZ																																																		
0H2411A0		1	PZ																																																		
EL1450A0	US SELF-CLEANIN G WATER SOLENOID	4	PZ																																																		
GN1526A0	INT. D.=6.9 TH=1.8 O-RIN	9	PZ																																																		
RC1018A0	ZINC PLATED D12 ELASTIC CLAMP	13	PZ																																																		
RC1019A0	D=10 ELASTIC CLAMP	15	PZ																																																		
RC1130A0	130X2.6 CLAM	1	PZ																																																		
RC1131A0	200X2.6 BLACK CLAMP	3	PZ																																																		
RC1242A0	D=10 CLOSED CAP	2	PZ																																																		
RC1356A0	"STRAIGHT THREADED FEMALE END 8X1/4" BS	1	PZ																																																		
TB2820A0	6X10 EPDM PIPE FOR WASHING SYSTEM	2.750	M																																																		





COMPONENT			SPARE PART																																																																														
Code	Description	Image	Code	Description	Components list																																																																												
VL1166A	BB6-AR6 L FITTING		KVL1209A	US PLUS 3 ROTOR ARMS WASHING SYSTEM KIT	<table border="1"> <thead> <tr> <th>Code</th> <th>Description</th> <th>Qty</th> <th>UOM</th> </tr> </thead> <tbody> <tr> <td>TB3132A0</td> <td>WHITE-BLUE EPDM TEXTILE BRAID HOSE 6X12</td> <td>1.980</td> <td>M</td> </tr> <tr> <td>VI1220A1</td> <td>4,2X12 TCB SELF-TAPPING SCREW</td> <td>3</td> <td>PZ</td> </tr> <tr> <td>VL1019A0</td> <td>VIBRATION PUMP</td> <td>1</td> <td>PZ</td> </tr> <tr> <td>VL1065A1</td> <td>1/4 MALE N.O. PRESSURE SWITCH</td> <td>1</td> <td>PZ</td> </tr> <tr> <td>VL1102A1</td> <td>DETERGENT LINE FILTER + BARBED VNR 6 MM</td> <td>1</td> <td>PZ</td> </tr> <tr> <td>VL1127A1</td> <td>6MM BARBED T-SHAPED FITTING</td> <td>2</td> <td>PZ</td> </tr> <tr> <td>VL1128A1</td> <td>D6 BARBED CHECK VALVE</td> <td>3</td> <td>PZ</td> </tr> <tr> <td>VL1165A0</td> <td>BB6-AR6 STRAIGHT FITTING</td> <td>1</td> <td>PZ</td> </tr> <tr> <td>VL1166A0</td> <td>BB6-AR6 L FITTING</td> <td>4</td> <td>PZ</td> </tr> <tr> <td>VL1167A0</td> <td></td> <td>1</td> <td>PZ</td> </tr> <tr> <td>VL1167A1</td> <td></td> <td>1</td> <td>PZ</td> </tr> <tr> <td>VL1167A2</td> <td>GN21 3 ROTOR ARMS B-B FLOW RESTRICTOR</td> <td>1</td> <td>PZ</td> </tr> <tr> <td>VL1174C0</td> <td>D1.2 MM CALIBRATED NOZZLE</td> <td>1</td> <td>PZ</td> </tr> <tr> <td>VL1185A0</td> <td>2 WAYS PLUS WASHING DISTRIBUTOR</td> <td>1</td> <td>PZ</td> </tr> <tr> <td>VL1186A0</td> <td>3 WAYS PLUS WASHING DISTRIBUTOR</td> <td>1</td> <td>PZ</td> </tr> <tr> <td>VL1190A0</td> <td>PLUS WASHING SYSTEM INLET DISTRIBUTOR</td> <td>1</td> <td>PZ</td> </tr> <tr> <td>VM1605A0</td> <td>CLIP TWIST LOCK DIAM. 10,2-12,7 MM</td> <td>6</td> <td>PZ</td> </tr> <tr> <td>VM2172A0</td> <td>PUMP-WITH-RCUIT LOCKING PIN</td> <td>9</td> <td>PZ</td> </tr> </tbody> </table>	Code	Description	Qty	UOM	TB3132A0	WHITE-BLUE EPDM TEXTILE BRAID HOSE 6X12	1.980	M	VI1220A1	4,2X12 TCB SELF-TAPPING SCREW	3	PZ	VL1019A0	VIBRATION PUMP	1	PZ	VL1065A1	1/4 MALE N.O. PRESSURE SWITCH	1	PZ	VL1102A1	DETERGENT LINE FILTER + BARBED VNR 6 MM	1	PZ	VL1127A1	6MM BARBED T-SHAPED FITTING	2	PZ	VL1128A1	D6 BARBED CHECK VALVE	3	PZ	VL1165A0	BB6-AR6 STRAIGHT FITTING	1	PZ	VL1166A0	BB6-AR6 L FITTING	4	PZ	VL1167A0		1	PZ	VL1167A1		1	PZ	VL1167A2	GN21 3 ROTOR ARMS B-B FLOW RESTRICTOR	1	PZ	VL1174C0	D1.2 MM CALIBRATED NOZZLE	1	PZ	VL1185A0	2 WAYS PLUS WASHING DISTRIBUTOR	1	PZ	VL1186A0	3 WAYS PLUS WASHING DISTRIBUTOR	1	PZ	VL1190A0	PLUS WASHING SYSTEM INLET DISTRIBUTOR	1	PZ	VM1605A0	CLIP TWIST LOCK DIAM. 10,2-12,7 MM	6	PZ	VM2172A0	PUMP-WITH-RCUIT LOCKING PIN	9	PZ
Code	Description	Qty	UOM																																																																														
TB3132A0	WHITE-BLUE EPDM TEXTILE BRAID HOSE 6X12	1.980	M																																																																														
VI1220A1	4,2X12 TCB SELF-TAPPING SCREW	3	PZ																																																																														
VL1019A0	VIBRATION PUMP	1	PZ																																																																														
VL1065A1	1/4 MALE N.O. PRESSURE SWITCH	1	PZ																																																																														
VL1102A1	DETERGENT LINE FILTER + BARBED VNR 6 MM	1	PZ																																																																														
VL1127A1	6MM BARBED T-SHAPED FITTING	2	PZ																																																																														
VL1128A1	D6 BARBED CHECK VALVE	3	PZ																																																																														
VL1165A0	BB6-AR6 STRAIGHT FITTING	1	PZ																																																																														
VL1166A0	BB6-AR6 L FITTING	4	PZ																																																																														
VL1167A0		1	PZ																																																																														
VL1167A1		1	PZ																																																																														
VL1167A2	GN21 3 ROTOR ARMS B-B FLOW RESTRICTOR	1	PZ																																																																														
VL1174C0	D1.2 MM CALIBRATED NOZZLE	1	PZ																																																																														
VL1185A0	2 WAYS PLUS WASHING DISTRIBUTOR	1	PZ																																																																														
VL1186A0	3 WAYS PLUS WASHING DISTRIBUTOR	1	PZ																																																																														
VL1190A0	PLUS WASHING SYSTEM INLET DISTRIBUTOR	1	PZ																																																																														
VM1605A0	CLIP TWIST LOCK DIAM. 10,2-12,7 MM	6	PZ																																																																														
VM2172A0	PUMP-WITH-RCUIT LOCKING PIN	9	PZ																																																																														

COMPONENT			SPARE PART																																																																																						
Code	Description	Image	Code	Description	Components list																																																																																				
VL1166A	BB6-AR6 L FITTING		KVL1208A	US PLUS 2 ROTOR ARMS WASHING SYSTEM KIT	<table border="1"> <thead> <tr> <th>Code</th> <th>Description</th> <th>Qty</th> <th>UOM</th> </tr> </thead> <tbody> <tr> <td>0H2354A0</td> <td>XEVC-XEVL WASHING CIRCUIT PLAT</td> <td>1</td> <td>PZ</td> </tr> <tr> <td>0H2411A0</td> <td></td> <td>1</td> <td>PZ</td> </tr> <tr> <td>EL1450A0</td> <td>US SELF-CLEANIN G WATER SOLENOID</td> <td>4</td> <td>PZ</td> </tr> <tr> <td>GN1526A0</td> <td>INT. D.=6.9 TH=1.8 O-RIN</td> <td>9</td> <td>PZ</td> </tr> <tr> <td>RC1018A0</td> <td>ZINC PLATED D12 ELASTIC CLAMP</td> <td>4</td> <td>PZ</td> </tr> <tr> <td>RC1019A0</td> <td>D=10 ELASTIC CLAMP</td> <td>16</td> <td>PZ</td> </tr> <tr> <td>RC1130A0</td> <td>130X2,6 CLAM</td> <td>1</td> <td>PZ</td> </tr> <tr> <td>RC1131A0</td> <td>200X2.6 BLACK CLAMP</td> <td>3</td> <td>PZ</td> </tr> <tr> <td>RC1242A0</td> <td>D=10 CLOSED CAP</td> <td>2</td> <td>PZ</td> </tr> <tr> <td>RC1356A0</td> <td>*STRAIGHT THREADED FEMALE END 8X1/4" BS</td> <td>1</td> <td>PZ</td> </tr> <tr> <td>TB2820A0</td> <td>6X10 EPDM PIPE FOR WASHING SYSTEM</td> <td>2.890</td> <td>M</td> </tr> <tr> <td>TB3132A0</td> <td>WHITE-BLUE EPDM TEXTILE BRAID HOSE 6X12</td> <td>1.600</td> <td>M</td> </tr> <tr> <td>VI1220A1</td> <td>4,2X12 TCB SELF-TAPPIN G SCREW</td> <td>3</td> <td>PZ</td> </tr> <tr> <td>VL1019A0</td> <td>VIBRATION PUMP</td> <td>1</td> <td>PZ</td> </tr> <tr> <td>VL1047A1</td> <td>D6 PIPE HOLDER - D8 J.G. TERMINAL</td> <td>1</td> <td>PZ</td> </tr> <tr> <td>VL1065A1</td> <td>1/4 MALE N.O. PRESSURE SWITCH</td> <td>1</td> <td>PZ</td> </tr> <tr> <td>VL1102A1</td> <td>DETERGENT LINE FILTER + BARBED VNR 6 MM</td> <td>1</td> <td>PZ</td> </tr> <tr> <td>VL1128A1</td> <td>D6 BARBED CHECK VALVE</td> <td>2</td> <td>PZ</td> </tr> <tr> <td>VL1141A1</td> <td>STRAIGHT CONNECT BB6-BB6</td> <td>1</td> <td>PZ</td> </tr> <tr> <td>VL1165A0</td> <td>BB6-AR6 STRAIGHT FITTING</td> <td>1</td> <td>PZ</td> </tr> </tbody> </table>	Code	Description	Qty	UOM	0H2354A0	XEVC-XEVL WASHING CIRCUIT PLAT	1	PZ	0H2411A0		1	PZ	EL1450A0	US SELF-CLEANIN G WATER SOLENOID	4	PZ	GN1526A0	INT. D.=6.9 TH=1.8 O-RIN	9	PZ	RC1018A0	ZINC PLATED D12 ELASTIC CLAMP	4	PZ	RC1019A0	D=10 ELASTIC CLAMP	16	PZ	RC1130A0	130X2,6 CLAM	1	PZ	RC1131A0	200X2.6 BLACK CLAMP	3	PZ	RC1242A0	D=10 CLOSED CAP	2	PZ	RC1356A0	*STRAIGHT THREADED FEMALE END 8X1/4" BS	1	PZ	TB2820A0	6X10 EPDM PIPE FOR WASHING SYSTEM	2.890	M	TB3132A0	WHITE-BLUE EPDM TEXTILE BRAID HOSE 6X12	1.600	M	VI1220A1	4,2X12 TCB SELF-TAPPIN G SCREW	3	PZ	VL1019A0	VIBRATION PUMP	1	PZ	VL1047A1	D6 PIPE HOLDER - D8 J.G. TERMINAL	1	PZ	VL1065A1	1/4 MALE N.O. PRESSURE SWITCH	1	PZ	VL1102A1	DETERGENT LINE FILTER + BARBED VNR 6 MM	1	PZ	VL1128A1	D6 BARBED CHECK VALVE	2	PZ	VL1141A1	STRAIGHT CONNECT BB6-BB6	1	PZ	VL1165A0	BB6-AR6 STRAIGHT FITTING	1	PZ
Code	Description	Qty	UOM																																																																																						
0H2354A0	XEVC-XEVL WASHING CIRCUIT PLAT	1	PZ																																																																																						
0H2411A0		1	PZ																																																																																						
EL1450A0	US SELF-CLEANIN G WATER SOLENOID	4	PZ																																																																																						
GN1526A0	INT. D.=6.9 TH=1.8 O-RIN	9	PZ																																																																																						
RC1018A0	ZINC PLATED D12 ELASTIC CLAMP	4	PZ																																																																																						
RC1019A0	D=10 ELASTIC CLAMP	16	PZ																																																																																						
RC1130A0	130X2,6 CLAM	1	PZ																																																																																						
RC1131A0	200X2.6 BLACK CLAMP	3	PZ																																																																																						
RC1242A0	D=10 CLOSED CAP	2	PZ																																																																																						
RC1356A0	*STRAIGHT THREADED FEMALE END 8X1/4" BS	1	PZ																																																																																						
TB2820A0	6X10 EPDM PIPE FOR WASHING SYSTEM	2.890	M																																																																																						
TB3132A0	WHITE-BLUE EPDM TEXTILE BRAID HOSE 6X12	1.600	M																																																																																						
VI1220A1	4,2X12 TCB SELF-TAPPIN G SCREW	3	PZ																																																																																						
VL1019A0	VIBRATION PUMP	1	PZ																																																																																						
VL1047A1	D6 PIPE HOLDER - D8 J.G. TERMINAL	1	PZ																																																																																						
VL1065A1	1/4 MALE N.O. PRESSURE SWITCH	1	PZ																																																																																						
VL1102A1	DETERGENT LINE FILTER + BARBED VNR 6 MM	1	PZ																																																																																						
VL1128A1	D6 BARBED CHECK VALVE	2	PZ																																																																																						
VL1141A1	STRAIGHT CONNECT BB6-BB6	1	PZ																																																																																						
VL1165A0	BB6-AR6 STRAIGHT FITTING	1	PZ																																																																																						



COMPONENT			SPARE PART																																																							
Code	Description	Image	Code	Description	Components list																																																					
VL1166A	BB6-AR6 L FITTING		KVL1208A	US PLUS 2 ROTOR ARMS WASHING SYSTEM KIT	<table border="1"> <thead> <tr> <th>Code</th> <th>Description</th> <th>Qty</th> <th>UOM</th> </tr> </thead> <tbody> <tr> <td>VL1166A0</td> <td>BB6-AR6 L FITTING</td> <td>4</td> <td>PZ</td> </tr> <tr> <td>VL1174C0</td> <td>D1.2 MM CALIBRATED NOZZLE</td> <td>1</td> <td>PZ</td> </tr> <tr> <td>VL1186A0</td> <td>3 WAYS PLUS WASHING DISTRIBUTOR</td> <td>1</td> <td>PZ</td> </tr> <tr> <td>VL1190A0</td> <td>PLUS WASHING SYSTEM INLET DISTRIBUTOR</td> <td>1</td> <td>PZ</td> </tr> <tr> <td>VM1605A0</td> <td>CLIP TWIST LOCK DIAM. 10,2-12,7 MM</td> <td>6</td> <td>PZ</td> </tr> <tr> <td>VM2172A0</td> <td>PUMP-WITH-CI RCUIT LOCKING PIN</td> <td>9</td> <td>PZ</td> </tr> </tbody> </table>	Code	Description	Qty	UOM	VL1166A0	BB6-AR6 L FITTING	4	PZ	VL1174C0	D1.2 MM CALIBRATED NOZZLE	1	PZ	VL1186A0	3 WAYS PLUS WASHING DISTRIBUTOR	1	PZ	VL1190A0	PLUS WASHING SYSTEM INLET DISTRIBUTOR	1	PZ	VM1605A0	CLIP TWIST LOCK DIAM. 10,2-12,7 MM	6	PZ	VM2172A0	PUMP-WITH-CI RCUIT LOCKING PIN	9	PZ																									
			Code	Description	Qty	UOM																																																				
VL1166A0	BB6-AR6 L FITTING	4	PZ																																																							
VL1174C0	D1.2 MM CALIBRATED NOZZLE	1	PZ																																																							
VL1186A0	3 WAYS PLUS WASHING DISTRIBUTOR	1	PZ																																																							
VL1190A0	PLUS WASHING SYSTEM INLET DISTRIBUTOR	1	PZ																																																							
VM1605A0	CLIP TWIST LOCK DIAM. 10,2-12,7 MM	6	PZ																																																							
VM2172A0	PUMP-WITH-CI RCUIT LOCKING PIN	9	PZ																																																							
KVL1207A	US PLUS 1 ROTOR ARM WASHING SYSTEM KIT	<table border="1"> <thead> <tr> <th>Code</th> <th>Description</th> <th>Qty</th> <th>UOM</th> </tr> </thead> <tbody> <tr> <td>0H2354A0</td> <td>XEVC-XEVL WASHING CIRCUIT PLAT</td> <td>1</td> <td>PZ</td> </tr> <tr> <td>0H2411A0</td> <td></td> <td>1</td> <td>PZ</td> </tr> <tr> <td>EL1450A0</td> <td>US SELF-CLEANIN G WATER SOLENOID</td> <td>3</td> <td>PZ</td> </tr> <tr> <td>GN1526A0</td> <td>INT. D.=6.9 TH=1.8 O-RIN</td> <td>7</td> <td>PZ</td> </tr> <tr> <td>RC1018A0</td> <td>ZINC PLATED D12 ELASTIC CLAMP</td> <td>3</td> <td>PZ</td> </tr> <tr> <td>RC1019A0</td> <td>D=10 ELASTIC CLAMP</td> <td>14</td> <td>PZ</td> </tr> <tr> <td>RC1130A0</td> <td>130X2,6 CLAM</td> <td>1</td> <td>PZ</td> </tr> <tr> <td>RC1131A0</td> <td>200X2.6 BLACK CLAMP</td> <td>2</td> <td>PZ</td> </tr> <tr> <td>RC1242A0</td> <td>D=10 CLOSED CAP</td> <td>2</td> <td>PZ</td> </tr> <tr> <td>RC1356A0</td> <td>"STRAIGHT THREADED FEMALE END 8X1/4" BS</td> <td>1</td> <td>PZ</td> </tr> <tr> <td>TB2820A0</td> <td>6X10 EPDM PIPE FOR WASHING SYSTEM</td> <td>1.460</td> <td>M</td> </tr> <tr> <td>TB3132A0</td> <td>WHITE-BLUE EPDM TEXTILE BRAID HOSE 6X12</td> <td>0.770</td> <td>M</td> </tr> <tr> <td>VI1220A1</td> <td>4,2X12 TCB SELF-TAPPIN G SCREW</td> <td>3</td> <td>PZ</td> </tr> </tbody> </table>	Code	Description	Qty	UOM	0H2354A0	XEVC-XEVL WASHING CIRCUIT PLAT	1	PZ	0H2411A0		1	PZ	EL1450A0	US SELF-CLEANIN G WATER SOLENOID	3	PZ	GN1526A0	INT. D.=6.9 TH=1.8 O-RIN	7	PZ	RC1018A0	ZINC PLATED D12 ELASTIC CLAMP	3	PZ	RC1019A0	D=10 ELASTIC CLAMP	14	PZ	RC1130A0	130X2,6 CLAM	1	PZ	RC1131A0	200X2.6 BLACK CLAMP	2	PZ	RC1242A0	D=10 CLOSED CAP	2	PZ	RC1356A0	"STRAIGHT THREADED FEMALE END 8X1/4" BS	1	PZ	TB2820A0	6X10 EPDM PIPE FOR WASHING SYSTEM	1.460	M	TB3132A0	WHITE-BLUE EPDM TEXTILE BRAID HOSE 6X12	0.770	M	VI1220A1	4,2X12 TCB SELF-TAPPIN G SCREW	3	PZ
Code	Description	Qty	UOM																																																							
0H2354A0	XEVC-XEVL WASHING CIRCUIT PLAT	1	PZ																																																							
0H2411A0		1	PZ																																																							
EL1450A0	US SELF-CLEANIN G WATER SOLENOID	3	PZ																																																							
GN1526A0	INT. D.=6.9 TH=1.8 O-RIN	7	PZ																																																							
RC1018A0	ZINC PLATED D12 ELASTIC CLAMP	3	PZ																																																							
RC1019A0	D=10 ELASTIC CLAMP	14	PZ																																																							
RC1130A0	130X2,6 CLAM	1	PZ																																																							
RC1131A0	200X2.6 BLACK CLAMP	2	PZ																																																							
RC1242A0	D=10 CLOSED CAP	2	PZ																																																							
RC1356A0	"STRAIGHT THREADED FEMALE END 8X1/4" BS	1	PZ																																																							
TB2820A0	6X10 EPDM PIPE FOR WASHING SYSTEM	1.460	M																																																							
TB3132A0	WHITE-BLUE EPDM TEXTILE BRAID HOSE 6X12	0.770	M																																																							
VI1220A1	4,2X12 TCB SELF-TAPPIN G SCREW	3	PZ																																																							

COMPONENT			SPARE PART																																																																																									
Code	Description	Image	Code	Description	Components list																																																																																							
VL1166A	BB6-AR6 L FITTING		KVL1207A	US PLUS 1 ROTOR ARM WASHING SYSTEM KIT	<table border="1"> <thead> <tr> <th>Code</th> <th>Description</th> <th>Qty</th> <th>UOM</th> </tr> </thead> <tbody> <tr> <td>VL1019A0</td> <td>VIBRATION PUMP</td> <td>1</td> <td>PZ</td> </tr> <tr> <td>VL1047A1</td> <td>D6 PIPE HOLDER - D8 J.G. TERMINAL</td> <td>1</td> <td>PZ</td> </tr> <tr> <td>VL1065A1</td> <td>1/4 MALE N.O. PRESSURE SWITCH</td> <td>1</td> <td>PZ</td> </tr> <tr> <td>VL1102A1</td> <td>DETERGENT LINE FILTER + BARBED VNR 6 MM</td> <td>1</td> <td>PZ</td> </tr> <tr> <td>VL1128A1</td> <td>D6 BARBED CHECK VALVE</td> <td>2</td> <td>PZ</td> </tr> <tr> <td>VL1165A0</td> <td>BB6-AR6 STRAIGHT FITTING</td> <td>1</td> <td>PZ</td> </tr> <tr> <td>VL1166A0</td> <td>BB6-AR6 L FITTING</td> <td>3</td> <td>PZ</td> </tr> <tr> <td>VL1174C0</td> <td>D1.2 MM CALIBRATED NOZZLE</td> <td>1</td> <td>PZ</td> </tr> <tr> <td>VL1185A0</td> <td>2 WAYS PLUS WASHING DISTRIBUTOR</td> <td>1</td> <td>PZ</td> </tr> <tr> <td>VL1190A0</td> <td>PLUS WASHING SYSTEM INLET DISTRIBUTOR</td> <td>1</td> <td>PZ</td> </tr> <tr> <td>VM1605A0</td> <td>CLIP TWIST LOCK DIAM. 10.2-12.7 MM</td> <td>6</td> <td>PZ</td> </tr> <tr> <td>VM2172A0</td> <td>PUMP-WITH-CI RCUIT LOCKING PIN</td> <td>6</td> <td>PZ</td> </tr> </tbody> </table>	Code	Description	Qty	UOM	VL1019A0	VIBRATION PUMP	1	PZ	VL1047A1	D6 PIPE HOLDER - D8 J.G. TERMINAL	1	PZ	VL1065A1	1/4 MALE N.O. PRESSURE SWITCH	1	PZ	VL1102A1	DETERGENT LINE FILTER + BARBED VNR 6 MM	1	PZ	VL1128A1	D6 BARBED CHECK VALVE	2	PZ	VL1165A0	BB6-AR6 STRAIGHT FITTING	1	PZ	VL1166A0	BB6-AR6 L FITTING	3	PZ	VL1174C0	D1.2 MM CALIBRATED NOZZLE	1	PZ	VL1185A0	2 WAYS PLUS WASHING DISTRIBUTOR	1	PZ	VL1190A0	PLUS WASHING SYSTEM INLET DISTRIBUTOR	1	PZ	VM1605A0	CLIP TWIST LOCK DIAM. 10.2-12.7 MM	6	PZ	VM2172A0	PUMP-WITH-CI RCUIT LOCKING PIN	6	PZ	KVL1198A	MM EU HOOD CLEANING SYSTEM KIT	<table border="1"> <thead> <tr> <th>Code</th> <th>Description</th> <th>Qty</th> <th>UOM</th> </tr> </thead> <tbody> <tr> <td>0H2213A1</td> <td></td> <td>1</td> <td>PZ</td> </tr> <tr> <td>EL1440A0</td> <td>WATER SELF CLEANING VALVE</td> <td>2</td> <td>PZ</td> </tr> <tr> <td>GN1526A0</td> <td>INT. D.=6.9 TH=1.8 O-RIN</td> <td>5</td> <td>PZ</td> </tr> <tr> <td>RC1018A0</td> <td>ZINC PLATED D12 ELASTIC CLAMP</td> <td>6</td> <td>PZ</td> </tr> <tr> <td>RC1019A0</td> <td>D=10 ELASTIC CLAMP</td> <td>16</td> <td>PZ</td> </tr> <tr> <td>RC1131A0</td> <td>200X2.6 BLACK CLAMP</td> <td>1</td> <td>PZ</td> </tr> <tr> <td>RC1242A0</td> <td>D=10 CLOSED CAP</td> <td>2</td> <td>PZ</td> </tr> </tbody> </table>	Code	Description	Qty	UOM	0H2213A1		1	PZ	EL1440A0	WATER SELF CLEANING VALVE	2	PZ	GN1526A0	INT. D.=6.9 TH=1.8 O-RIN	5	PZ	RC1018A0	ZINC PLATED D12 ELASTIC CLAMP	6	PZ	RC1019A0	D=10 ELASTIC CLAMP	16	PZ	RC1131A0	200X2.6 BLACK CLAMP	1	PZ	RC1242A0	D=10 CLOSED CAP	2	PZ
			Code	Description	Qty	UOM																																																																																						
VL1019A0	VIBRATION PUMP	1	PZ																																																																																									
VL1047A1	D6 PIPE HOLDER - D8 J.G. TERMINAL	1	PZ																																																																																									
VL1065A1	1/4 MALE N.O. PRESSURE SWITCH	1	PZ																																																																																									
VL1102A1	DETERGENT LINE FILTER + BARBED VNR 6 MM	1	PZ																																																																																									
VL1128A1	D6 BARBED CHECK VALVE	2	PZ																																																																																									
VL1165A0	BB6-AR6 STRAIGHT FITTING	1	PZ																																																																																									
VL1166A0	BB6-AR6 L FITTING	3	PZ																																																																																									
VL1174C0	D1.2 MM CALIBRATED NOZZLE	1	PZ																																																																																									
VL1185A0	2 WAYS PLUS WASHING DISTRIBUTOR	1	PZ																																																																																									
VL1190A0	PLUS WASHING SYSTEM INLET DISTRIBUTOR	1	PZ																																																																																									
VM1605A0	CLIP TWIST LOCK DIAM. 10.2-12.7 MM	6	PZ																																																																																									
VM2172A0	PUMP-WITH-CI RCUIT LOCKING PIN	6	PZ																																																																																									
Code	Description	Qty	UOM																																																																																									
0H2213A1		1	PZ																																																																																									
EL1440A0	WATER SELF CLEANING VALVE	2	PZ																																																																																									
GN1526A0	INT. D.=6.9 TH=1.8 O-RIN	5	PZ																																																																																									
RC1018A0	ZINC PLATED D12 ELASTIC CLAMP	6	PZ																																																																																									
RC1019A0	D=10 ELASTIC CLAMP	16	PZ																																																																																									
RC1131A0	200X2.6 BLACK CLAMP	1	PZ																																																																																									
RC1242A0	D=10 CLOSED CAP	2	PZ																																																																																									

COMPONENT			SPARE PART																																																																		
Code	Description	Image	Code	Description	Components list																																																																
VL1166A	BB6-AR6 L FITTING		KVL1198A	MM EU HOOD CLEANING SYSTEM KIT	<table border="1"> <thead> <tr> <th>Code</th> <th>Description</th> <th>Qty</th> <th>UOM</th> </tr> </thead> <tbody> <tr> <td>TB2820A0</td> <td>6X10 EPDM PIPE FOR WASHING SYSTEM</td> <td>2.240</td> <td>M</td> </tr> <tr> <td>TB3132A0</td> <td>WHITE-BLUE EPDM TEXTILE BRAID HOSE 6X12</td> <td>0.440</td> <td>M</td> </tr> <tr> <td>VI1220A1</td> <td>4,2X12 TCB SELF-TAPPIN G SCREW</td> <td>3</td> <td>PZ</td> </tr> <tr> <td>VL1019A0</td> <td>VIBRATION PUMP</td> <td>1</td> <td>PZ</td> </tr> <tr> <td>VL1047A1</td> <td>D6 PIPE HOLDER - D8 J.G. TERMINAL</td> <td>2</td> <td>PZ</td> </tr> <tr> <td>VL1054B0</td> <td>ONE WASHING SYS INLET DISTRIBUTOR</td> <td>1</td> <td>PZ</td> </tr> <tr> <td>VL1102A1</td> <td>DETERGENT LINE FILTER + BARBED VNR 6 MM</td> <td>1</td> <td>PZ</td> </tr> <tr> <td>VL1127A1</td> <td>6MM BARBED T-SHAPED FITTING</td> <td>1</td> <td>PZ</td> </tr> <tr> <td>VL1128A1</td> <td>D6 BARBED CHECK VALVE</td> <td>2</td> <td>PZ</td> </tr> <tr> <td>VL1165A0</td> <td>BB6-AR6 STRAIGHT FITTING</td> <td>2</td> <td>PZ</td> </tr> <tr> <td>VL1166A0</td> <td>BB6-AR6 L FITTING</td> <td>2</td> <td>PZ</td> </tr> <tr> <td>VL1174C0</td> <td>D1.2 MM CALIBRATED NOZZLE</td> <td>1</td> <td>PZ</td> </tr> <tr> <td>VL1191A0</td> <td>ONE WASHING DISTRIBUTOR OUTLETS KIT</td> <td>1</td> <td>PZ</td> </tr> <tr> <td>VM1605A0</td> <td>CLIP TWIST LOCK DIAM. 10,2-12,7 MM</td> <td>4</td> <td>PZ</td> </tr> <tr> <td>VM2172A0</td> <td>PUMP-WITH-CI RCUIT LOCKING PIN</td> <td>5</td> <td>PZ</td> </tr> </tbody> </table>	Code	Description	Qty	UOM	TB2820A0	6X10 EPDM PIPE FOR WASHING SYSTEM	2.240	M	TB3132A0	WHITE-BLUE EPDM TEXTILE BRAID HOSE 6X12	0.440	M	VI1220A1	4,2X12 TCB SELF-TAPPIN G SCREW	3	PZ	VL1019A0	VIBRATION PUMP	1	PZ	VL1047A1	D6 PIPE HOLDER - D8 J.G. TERMINAL	2	PZ	VL1054B0	ONE WASHING SYS INLET DISTRIBUTOR	1	PZ	VL1102A1	DETERGENT LINE FILTER + BARBED VNR 6 MM	1	PZ	VL1127A1	6MM BARBED T-SHAPED FITTING	1	PZ	VL1128A1	D6 BARBED CHECK VALVE	2	PZ	VL1165A0	BB6-AR6 STRAIGHT FITTING	2	PZ	VL1166A0	BB6-AR6 L FITTING	2	PZ	VL1174C0	D1.2 MM CALIBRATED NOZZLE	1	PZ	VL1191A0	ONE WASHING DISTRIBUTOR OUTLETS KIT	1	PZ	VM1605A0	CLIP TWIST LOCK DIAM. 10,2-12,7 MM	4	PZ	VM2172A0	PUMP-WITH-CI RCUIT LOCKING PIN	5	PZ
Code	Description	Qty	UOM																																																																		
TB2820A0	6X10 EPDM PIPE FOR WASHING SYSTEM	2.240	M																																																																		
TB3132A0	WHITE-BLUE EPDM TEXTILE BRAID HOSE 6X12	0.440	M																																																																		
VI1220A1	4,2X12 TCB SELF-TAPPIN G SCREW	3	PZ																																																																		
VL1019A0	VIBRATION PUMP	1	PZ																																																																		
VL1047A1	D6 PIPE HOLDER - D8 J.G. TERMINAL	2	PZ																																																																		
VL1054B0	ONE WASHING SYS INLET DISTRIBUTOR	1	PZ																																																																		
VL1102A1	DETERGENT LINE FILTER + BARBED VNR 6 MM	1	PZ																																																																		
VL1127A1	6MM BARBED T-SHAPED FITTING	1	PZ																																																																		
VL1128A1	D6 BARBED CHECK VALVE	2	PZ																																																																		
VL1165A0	BB6-AR6 STRAIGHT FITTING	2	PZ																																																																		
VL1166A0	BB6-AR6 L FITTING	2	PZ																																																																		
VL1174C0	D1.2 MM CALIBRATED NOZZLE	1	PZ																																																																		
VL1191A0	ONE WASHING DISTRIBUTOR OUTLETS KIT	1	PZ																																																																		
VM1605A0	CLIP TWIST LOCK DIAM. 10,2-12,7 MM	4	PZ																																																																		
VM2172A0	PUMP-WITH-CI RCUIT LOCKING PIN	5	PZ																																																																		
			KVL1187A	3 ROTOR ARMS PLUS EU CLEANING SYSTEM KIT	<table border="1"> <thead> <tr> <th>Code</th> <th>Description</th> <th>Qty</th> <th>UOM</th> </tr> </thead> <tbody> <tr> <td>0H2143A0</td> <td>LAMIERA BLOCCA VNR VL1128</td> <td>3</td> <td>PZ</td> </tr> <tr> <td>0H2168A0</td> <td></td> <td>1</td> <td>PZ</td> </tr> </tbody> </table>	Code	Description	Qty	UOM	0H2143A0	LAMIERA BLOCCA VNR VL1128	3	PZ	0H2168A0		1	PZ																																																				
Code	Description	Qty	UOM																																																																		
0H2143A0	LAMIERA BLOCCA VNR VL1128	3	PZ																																																																		
0H2168A0		1	PZ																																																																		

COMPONENT			SPARE PART																																																																																		
Code	Description	Image	Code	Description	Components list																																																																																
VL1166A	BB6-AR6 L FITTING		KVL1187A	3 ROTOR ARMS PLUS EU CLEANING SYSTEM KIT	<table border="1"> <thead> <tr> <th>Code</th> <th>Description</th> <th>Qty</th> <th>UOM</th> </tr> </thead> <tbody> <tr> <td>0H2354A0</td> <td>XEVC-XEVL WASHING CIRCUIT PLAT</td> <td>1</td> <td>PZ</td> </tr> <tr> <td>EL1120A0</td> <td>D8-D6 FEMALE STRAIGHT INTERM. CONNECTION</td> <td>1</td> <td>PZ</td> </tr> <tr> <td>EL1220A0</td> <td>JG STRAIGHT CONNECTION Ø8F-Ø8F</td> <td>2</td> <td>PZ</td> </tr> <tr> <td>EL1440A0</td> <td>WATER SELF CLEANING VALVE</td> <td>4</td> <td>PZ</td> </tr> <tr> <td>GN1526A0</td> <td>INT. D.=6.9 TH=1.8 O-RIN</td> <td>9</td> <td>PZ</td> </tr> <tr> <td>RC1018A0</td> <td>ZINC PLATED D12 ELASTIC CLAMP</td> <td>10</td> <td>PZ</td> </tr> <tr> <td>RC1019A0</td> <td>D=10 ELASTIC CLAMP</td> <td>22</td> <td>PZ</td> </tr> <tr> <td>RC1130A0</td> <td>130X2,6 CLAM</td> <td>4</td> <td>PZ</td> </tr> <tr> <td>RC1131A0</td> <td>200X2.6 BLACK CLAMP</td> <td>3</td> <td>PZ</td> </tr> <tr> <td>RC1242A0</td> <td>D=10 CLOSED CAP</td> <td>2</td> <td>PZ</td> </tr> <tr> <td>RC1310A0</td> <td>140X4 CLAMP WITH CLIP</td> <td>1</td> <td>PZ</td> </tr> <tr> <td>RC1356A0</td> <td>"STRAIGHT THREADED FEMALE END 8X1/4" BS</td> <td>1</td> <td>PZ</td> </tr> <tr> <td>TB2820A0</td> <td>6X10 EPDM PIPE FOR WASHING SYSTEM</td> <td>1.510</td> <td>M</td> </tr> <tr> <td>TB3132A0</td> <td>WHITE-BLUE EPDM TEXTILE BRAID HOSE 6X12</td> <td>1.210</td> <td>M</td> </tr> <tr> <td>VI1220A1</td> <td>4,2X12 TCB SELF-TAPPIN G SCREW</td> <td>3</td> <td>PZ</td> </tr> <tr> <td>VL1019A0</td> <td>VIBRATION PUMP</td> <td>1</td> <td>PZ</td> </tr> <tr> <td>VL1046A1</td> <td>D6 PIPE HOLDER - D6 J.G. TERMINAL</td> <td>3</td> <td>PZ</td> </tr> <tr> <td>VL1047A1</td> <td>D6 PIPE HOLDER - D8 J.G. TERMINAL</td> <td>1</td> <td>PZ</td> </tr> <tr> <td>VL1064A0</td> <td>WASHING SYSTEM OUTLETS DISTRIBUTOR</td> <td>1</td> <td>PZ</td> </tr> </tbody> </table>	Code	Description	Qty	UOM	0H2354A0	XEVC-XEVL WASHING CIRCUIT PLAT	1	PZ	EL1120A0	D8-D6 FEMALE STRAIGHT INTERM. CONNECTION	1	PZ	EL1220A0	JG STRAIGHT CONNECTION Ø8F-Ø8F	2	PZ	EL1440A0	WATER SELF CLEANING VALVE	4	PZ	GN1526A0	INT. D.=6.9 TH=1.8 O-RIN	9	PZ	RC1018A0	ZINC PLATED D12 ELASTIC CLAMP	10	PZ	RC1019A0	D=10 ELASTIC CLAMP	22	PZ	RC1130A0	130X2,6 CLAM	4	PZ	RC1131A0	200X2.6 BLACK CLAMP	3	PZ	RC1242A0	D=10 CLOSED CAP	2	PZ	RC1310A0	140X4 CLAMP WITH CLIP	1	PZ	RC1356A0	"STRAIGHT THREADED FEMALE END 8X1/4" BS	1	PZ	TB2820A0	6X10 EPDM PIPE FOR WASHING SYSTEM	1.510	M	TB3132A0	WHITE-BLUE EPDM TEXTILE BRAID HOSE 6X12	1.210	M	VI1220A1	4,2X12 TCB SELF-TAPPIN G SCREW	3	PZ	VL1019A0	VIBRATION PUMP	1	PZ	VL1046A1	D6 PIPE HOLDER - D6 J.G. TERMINAL	3	PZ	VL1047A1	D6 PIPE HOLDER - D8 J.G. TERMINAL	1	PZ	VL1064A0	WASHING SYSTEM OUTLETS DISTRIBUTOR	1	PZ
Code	Description	Qty	UOM																																																																																		
0H2354A0	XEVC-XEVL WASHING CIRCUIT PLAT	1	PZ																																																																																		
EL1120A0	D8-D6 FEMALE STRAIGHT INTERM. CONNECTION	1	PZ																																																																																		
EL1220A0	JG STRAIGHT CONNECTION Ø8F-Ø8F	2	PZ																																																																																		
EL1440A0	WATER SELF CLEANING VALVE	4	PZ																																																																																		
GN1526A0	INT. D.=6.9 TH=1.8 O-RIN	9	PZ																																																																																		
RC1018A0	ZINC PLATED D12 ELASTIC CLAMP	10	PZ																																																																																		
RC1019A0	D=10 ELASTIC CLAMP	22	PZ																																																																																		
RC1130A0	130X2,6 CLAM	4	PZ																																																																																		
RC1131A0	200X2.6 BLACK CLAMP	3	PZ																																																																																		
RC1242A0	D=10 CLOSED CAP	2	PZ																																																																																		
RC1310A0	140X4 CLAMP WITH CLIP	1	PZ																																																																																		
RC1356A0	"STRAIGHT THREADED FEMALE END 8X1/4" BS	1	PZ																																																																																		
TB2820A0	6X10 EPDM PIPE FOR WASHING SYSTEM	1.510	M																																																																																		
TB3132A0	WHITE-BLUE EPDM TEXTILE BRAID HOSE 6X12	1.210	M																																																																																		
VI1220A1	4,2X12 TCB SELF-TAPPIN G SCREW	3	PZ																																																																																		
VL1019A0	VIBRATION PUMP	1	PZ																																																																																		
VL1046A1	D6 PIPE HOLDER - D6 J.G. TERMINAL	3	PZ																																																																																		
VL1047A1	D6 PIPE HOLDER - D8 J.G. TERMINAL	1	PZ																																																																																		
VL1064A0	WASHING SYSTEM OUTLETS DISTRIBUTOR	1	PZ																																																																																		





COMPONENT			SPARE PART																																																																														
Code	Description	Image	Code	Description	Components list																																																																												
VL1166A	BB6-AR6 L FITTING		KVL1187A	3 ROTOR ARMS PLUS EU CLEANING SYSTEM KIT	<table border="1"> <thead> <tr> <th>Code</th> <th>Description</th> <th>Qty</th> <th>UOM</th> </tr> </thead> <tbody> <tr> <td>VL1065A1</td> <td>1/4 MALE N.O. PRESSURE SWITCH</td> <td>1</td> <td>PZ</td> </tr> <tr> <td>VL1067A0</td> <td>WASHING SYSTEM INLETS DISTRIBUTOR</td> <td>1</td> <td>PZ</td> </tr> <tr> <td>VL1092A0</td> <td>WASHING SYSTEM OUTLET DOUBLE DISTRIBUTOR</td> <td>1</td> <td>PZ</td> </tr> <tr> <td>VL1102A1</td> <td>DETERGENT LINE FILTER + BARBED VNR 6 MM</td> <td>1</td> <td>PZ</td> </tr> <tr> <td>VL1127A1</td> <td>6MM BARBED T-SHAPED FITTING</td> <td>2</td> <td>PZ</td> </tr> <tr> <td>VL1128A0</td> <td>D6 BARBED CHECK VALVE</td> <td>3</td> <td>PZ</td> </tr> <tr> <td>VL1128A1</td> <td>D6 BARBED CHECK VALVE</td> <td>3</td> <td>PZ</td> </tr> <tr> <td>VL1165A0</td> <td>BB6-AR6 STRAIGHT FITTING</td> <td>4</td> <td>PZ</td> </tr> <tr> <td>VL1166A0</td> <td>BB6-AR6 L FITTING</td> <td>4</td> <td>PZ</td> </tr> <tr> <td>VL1167A0</td> <td></td> <td>1</td> <td>PZ</td> </tr> <tr> <td>VL1167A1</td> <td></td> <td>1</td> <td>PZ</td> </tr> <tr> <td>VL1167A2</td> <td>GN21 3 ROTOR ARMS B-B FLOW RESTRICTOR</td> <td>1</td> <td>PZ</td> </tr> <tr> <td>VL1174C0</td> <td>D1.2 MM CALIBRATED NOZZLE</td> <td>1</td> <td>PZ</td> </tr> <tr> <td>VL1185A0</td> <td>2 WAYS PLUS WASHING DISTRIBUTOR</td> <td>1</td> <td>PZ</td> </tr> <tr> <td>VL1186A0</td> <td>3 WAYS PLUS WASHING DISTRIBUTOR</td> <td>1</td> <td>PZ</td> </tr> <tr> <td>VL1190A0</td> <td>PLUS WASHING SYSTEM INLET DISTRIBUTOR</td> <td>1</td> <td>PZ</td> </tr> <tr> <td>VM1605A0</td> <td>CLIP TWIST LOCK DIAM. 10,2-12,7 MM</td> <td>3</td> <td>PZ</td> </tr> <tr> <td>VM2172A0</td> <td>PUMP-WITH-CI RCUIT LOCKING PIN</td> <td>9</td> <td>PZ</td> </tr> </tbody> </table>	Code	Description	Qty	UOM	VL1065A1	1/4 MALE N.O. PRESSURE SWITCH	1	PZ	VL1067A0	WASHING SYSTEM INLETS DISTRIBUTOR	1	PZ	VL1092A0	WASHING SYSTEM OUTLET DOUBLE DISTRIBUTOR	1	PZ	VL1102A1	DETERGENT LINE FILTER + BARBED VNR 6 MM	1	PZ	VL1127A1	6MM BARBED T-SHAPED FITTING	2	PZ	VL1128A0	D6 BARBED CHECK VALVE	3	PZ	VL1128A1	D6 BARBED CHECK VALVE	3	PZ	VL1165A0	BB6-AR6 STRAIGHT FITTING	4	PZ	VL1166A0	BB6-AR6 L FITTING	4	PZ	VL1167A0		1	PZ	VL1167A1		1	PZ	VL1167A2	GN21 3 ROTOR ARMS B-B FLOW RESTRICTOR	1	PZ	VL1174C0	D1.2 MM CALIBRATED NOZZLE	1	PZ	VL1185A0	2 WAYS PLUS WASHING DISTRIBUTOR	1	PZ	VL1186A0	3 WAYS PLUS WASHING DISTRIBUTOR	1	PZ	VL1190A0	PLUS WASHING SYSTEM INLET DISTRIBUTOR	1	PZ	VM1605A0	CLIP TWIST LOCK DIAM. 10,2-12,7 MM	3	PZ	VM2172A0	PUMP-WITH-CI RCUIT LOCKING PIN	9	PZ
Code	Description	Qty	UOM																																																																														
VL1065A1	1/4 MALE N.O. PRESSURE SWITCH	1	PZ																																																																														
VL1067A0	WASHING SYSTEM INLETS DISTRIBUTOR	1	PZ																																																																														
VL1092A0	WASHING SYSTEM OUTLET DOUBLE DISTRIBUTOR	1	PZ																																																																														
VL1102A1	DETERGENT LINE FILTER + BARBED VNR 6 MM	1	PZ																																																																														
VL1127A1	6MM BARBED T-SHAPED FITTING	2	PZ																																																																														
VL1128A0	D6 BARBED CHECK VALVE	3	PZ																																																																														
VL1128A1	D6 BARBED CHECK VALVE	3	PZ																																																																														
VL1165A0	BB6-AR6 STRAIGHT FITTING	4	PZ																																																																														
VL1166A0	BB6-AR6 L FITTING	4	PZ																																																																														
VL1167A0		1	PZ																																																																														
VL1167A1		1	PZ																																																																														
VL1167A2	GN21 3 ROTOR ARMS B-B FLOW RESTRICTOR	1	PZ																																																																														
VL1174C0	D1.2 MM CALIBRATED NOZZLE	1	PZ																																																																														
VL1185A0	2 WAYS PLUS WASHING DISTRIBUTOR	1	PZ																																																																														
VL1186A0	3 WAYS PLUS WASHING DISTRIBUTOR	1	PZ																																																																														
VL1190A0	PLUS WASHING SYSTEM INLET DISTRIBUTOR	1	PZ																																																																														
VM1605A0	CLIP TWIST LOCK DIAM. 10,2-12,7 MM	3	PZ																																																																														
VM2172A0	PUMP-WITH-CI RCUIT LOCKING PIN	9	PZ																																																																														



COMPONENT			SPARE PART																																																																																		
Code	Description	Image	Code	Description	Components list																																																																																
VL1166A	BB6-AR6 L FITTING		KVL1184A	2 ROTOR ARMS PLUS EU CLEANING SYSTEM KIT	<table border="1"> <thead> <tr> <th>Code</th> <th>Description</th> <th>Qty</th> <th>UOM</th> </tr> </thead> <tbody> <tr> <td>0H2143A0</td> <td>LAMIERA BLOCCA VNR VL1128</td> <td>2</td> <td>PZ</td> </tr> <tr> <td>0H2168A0</td> <td></td> <td>1</td> <td>PZ</td> </tr> <tr> <td>0H2354A0</td> <td>XEVC-XEVL WASHING CIRCUIT PLAT</td> <td>1</td> <td>PZ</td> </tr> <tr> <td>EL1220A0</td> <td>JG STRAIGHT CONNECTION Ø8F-Ø8F</td> <td>3</td> <td>PZ</td> </tr> <tr> <td>EL1440A0</td> <td>WATER SELF CLEANING VALVE</td> <td>4</td> <td>PZ</td> </tr> <tr> <td>GN1526A0</td> <td>INT. D.=6.9 TH=1.8 O-RIN</td> <td>9</td> <td>PZ</td> </tr> <tr> <td>RC1018A0</td> <td>ZINC PLATED D12 ELASTIC CLAMP</td> <td>2</td> <td>PZ</td> </tr> <tr> <td>RC1019A0</td> <td>D=10 ELASTIC CLAMP</td> <td>21</td> <td>PZ</td> </tr> <tr> <td>RC1130A0</td> <td>130X2,6 CLAM</td> <td>7</td> <td>PZ</td> </tr> <tr> <td>RC1131A0</td> <td>200X2.6 BLACK CLAMP</td> <td>3</td> <td>PZ</td> </tr> <tr> <td>RC1242A0</td> <td>D=10 CLOSED CAP</td> <td>2</td> <td>PZ</td> </tr> <tr> <td>RC1356A0</td> <td>"STRAIGHT THREADED FEMALE END 8X1/4" BS</td> <td>1</td> <td>PZ</td> </tr> <tr> <td>TB2820A0</td> <td>6X10 EPDM PIPE FOR WASHING SYSTEM</td> <td>2.400</td> <td>M</td> </tr> <tr> <td>TB3132A0</td> <td>WHITE-BLUE EPDM TEXTILE BRAID HOSE 6X12</td> <td>1.220</td> <td>M</td> </tr> <tr> <td>VL1019A0</td> <td>VIBRATION PUMP</td> <td>1</td> <td>PZ</td> </tr> <tr> <td>VL1046A1</td> <td>D6 PIPE HOLDER - D6 J.G. TERMINAL</td> <td>3</td> <td>PZ</td> </tr> <tr> <td>VL1047A1</td> <td>D6 PIPE HOLDER - D8 J.G. TERMINAL</td> <td>1</td> <td>PZ</td> </tr> <tr> <td>VL1065A1</td> <td>1/4 MALE N.O. PRESSURE SWITCH</td> <td>1</td> <td>PZ</td> </tr> <tr> <td>VL1067A0</td> <td>WASHING SYSTEM INLETS DISTRIBUTOR</td> <td>1</td> <td>PZ</td> </tr> </tbody> </table>	Code	Description	Qty	UOM	0H2143A0	LAMIERA BLOCCA VNR VL1128	2	PZ	0H2168A0		1	PZ	0H2354A0	XEVC-XEVL WASHING CIRCUIT PLAT	1	PZ	EL1220A0	JG STRAIGHT CONNECTION Ø8F-Ø8F	3	PZ	EL1440A0	WATER SELF CLEANING VALVE	4	PZ	GN1526A0	INT. D.=6.9 TH=1.8 O-RIN	9	PZ	RC1018A0	ZINC PLATED D12 ELASTIC CLAMP	2	PZ	RC1019A0	D=10 ELASTIC CLAMP	21	PZ	RC1130A0	130X2,6 CLAM	7	PZ	RC1131A0	200X2.6 BLACK CLAMP	3	PZ	RC1242A0	D=10 CLOSED CAP	2	PZ	RC1356A0	"STRAIGHT THREADED FEMALE END 8X1/4" BS	1	PZ	TB2820A0	6X10 EPDM PIPE FOR WASHING SYSTEM	2.400	M	TB3132A0	WHITE-BLUE EPDM TEXTILE BRAID HOSE 6X12	1.220	M	VL1019A0	VIBRATION PUMP	1	PZ	VL1046A1	D6 PIPE HOLDER - D6 J.G. TERMINAL	3	PZ	VL1047A1	D6 PIPE HOLDER - D8 J.G. TERMINAL	1	PZ	VL1065A1	1/4 MALE N.O. PRESSURE SWITCH	1	PZ	VL1067A0	WASHING SYSTEM INLETS DISTRIBUTOR	1	PZ
Code	Description	Qty	UOM																																																																																		
0H2143A0	LAMIERA BLOCCA VNR VL1128	2	PZ																																																																																		
0H2168A0		1	PZ																																																																																		
0H2354A0	XEVC-XEVL WASHING CIRCUIT PLAT	1	PZ																																																																																		
EL1220A0	JG STRAIGHT CONNECTION Ø8F-Ø8F	3	PZ																																																																																		
EL1440A0	WATER SELF CLEANING VALVE	4	PZ																																																																																		
GN1526A0	INT. D.=6.9 TH=1.8 O-RIN	9	PZ																																																																																		
RC1018A0	ZINC PLATED D12 ELASTIC CLAMP	2	PZ																																																																																		
RC1019A0	D=10 ELASTIC CLAMP	21	PZ																																																																																		
RC1130A0	130X2,6 CLAM	7	PZ																																																																																		
RC1131A0	200X2.6 BLACK CLAMP	3	PZ																																																																																		
RC1242A0	D=10 CLOSED CAP	2	PZ																																																																																		
RC1356A0	"STRAIGHT THREADED FEMALE END 8X1/4" BS	1	PZ																																																																																		
TB2820A0	6X10 EPDM PIPE FOR WASHING SYSTEM	2.400	M																																																																																		
TB3132A0	WHITE-BLUE EPDM TEXTILE BRAID HOSE 6X12	1.220	M																																																																																		
VL1019A0	VIBRATION PUMP	1	PZ																																																																																		
VL1046A1	D6 PIPE HOLDER - D6 J.G. TERMINAL	3	PZ																																																																																		
VL1047A1	D6 PIPE HOLDER - D8 J.G. TERMINAL	1	PZ																																																																																		
VL1065A1	1/4 MALE N.O. PRESSURE SWITCH	1	PZ																																																																																		
VL1067A0	WASHING SYSTEM INLETS DISTRIBUTOR	1	PZ																																																																																		



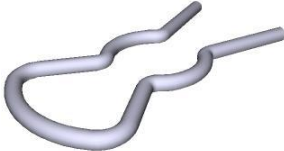

COMPONENT			SPARE PART																																																						
Code	Description	Image	Code	Description	Components list																																																				
VL1166A	BB6-AR6 L FITTING		KVL1184A	2 ROTOR ARMS PLUS EU CLEANING SYSTEM KIT	<table border="1"> <thead> <tr> <th>Code</th> <th>Description</th> <th>Qty</th> <th>UOM</th> </tr> </thead> <tbody> <tr> <td>VL1092A0</td> <td>WASHING SYSTEM OUTLET DOUBLE DISTRIBUTOR</td> <td>1</td> <td>PZ</td> </tr> <tr> <td>VL1102A1</td> <td>DETERGENT LINE FILTER + BARBED VNR 6 MM</td> <td>1</td> <td>PZ</td> </tr> <tr> <td>VL1128A0</td> <td>D6 BARBED CHECK VALVE</td> <td>2</td> <td>PZ</td> </tr> <tr> <td>VL1128A1</td> <td>D6 BARBED CHECK VALVE</td> <td>2</td> <td>PZ</td> </tr> <tr> <td>VL1141A1</td> <td>STRAIGHT CONNECT BB6-BB6</td> <td>1</td> <td>PZ</td> </tr> <tr> <td>VL1165A0</td> <td>BB6-AR6 STRAIGHT FITTING</td> <td>4</td> <td>PZ</td> </tr> <tr> <td>VL1166A0</td> <td>BB6-AR6 L FITTING</td> <td>4</td> <td>PZ</td> </tr> <tr> <td>VL1174C0</td> <td>D1.2 MM CALIBRATED NOZZLE</td> <td>1</td> <td>PZ</td> </tr> <tr> <td>VL1186A0</td> <td>3 WAYS PLUS WASHING DISTRIBUTOR</td> <td>1</td> <td>PZ</td> </tr> <tr> <td>VL1190A0</td> <td>PLUS WASHING SYSTEM INLET DISTRIBUTOR</td> <td>1</td> <td>PZ</td> </tr> <tr> <td>VM1605A0</td> <td>CLIP TWIST LOCK DIAM. 10,2-12,7 MM</td> <td>4</td> <td>PZ</td> </tr> <tr> <td>VM2172A0</td> <td>PUMP-WITH-CI RCUIT LOCKING PIN</td> <td>9</td> <td>PZ</td> </tr> </tbody> </table>	Code	Description	Qty	UOM	VL1092A0	WASHING SYSTEM OUTLET DOUBLE DISTRIBUTOR	1	PZ	VL1102A1	DETERGENT LINE FILTER + BARBED VNR 6 MM	1	PZ	VL1128A0	D6 BARBED CHECK VALVE	2	PZ	VL1128A1	D6 BARBED CHECK VALVE	2	PZ	VL1141A1	STRAIGHT CONNECT BB6-BB6	1	PZ	VL1165A0	BB6-AR6 STRAIGHT FITTING	4	PZ	VL1166A0	BB6-AR6 L FITTING	4	PZ	VL1174C0	D1.2 MM CALIBRATED NOZZLE	1	PZ	VL1186A0	3 WAYS PLUS WASHING DISTRIBUTOR	1	PZ	VL1190A0	PLUS WASHING SYSTEM INLET DISTRIBUTOR	1	PZ	VM1605A0	CLIP TWIST LOCK DIAM. 10,2-12,7 MM	4	PZ	VM2172A0	PUMP-WITH-CI RCUIT LOCKING PIN	9	PZ
Code	Description	Qty	UOM																																																						
VL1092A0	WASHING SYSTEM OUTLET DOUBLE DISTRIBUTOR	1	PZ																																																						
VL1102A1	DETERGENT LINE FILTER + BARBED VNR 6 MM	1	PZ																																																						
VL1128A0	D6 BARBED CHECK VALVE	2	PZ																																																						
VL1128A1	D6 BARBED CHECK VALVE	2	PZ																																																						
VL1141A1	STRAIGHT CONNECT BB6-BB6	1	PZ																																																						
VL1165A0	BB6-AR6 STRAIGHT FITTING	4	PZ																																																						
VL1166A0	BB6-AR6 L FITTING	4	PZ																																																						
VL1174C0	D1.2 MM CALIBRATED NOZZLE	1	PZ																																																						
VL1186A0	3 WAYS PLUS WASHING DISTRIBUTOR	1	PZ																																																						
VL1190A0	PLUS WASHING SYSTEM INLET DISTRIBUTOR	1	PZ																																																						
VM1605A0	CLIP TWIST LOCK DIAM. 10,2-12,7 MM	4	PZ																																																						
VM2172A0	PUMP-WITH-CI RCUIT LOCKING PIN	9	PZ																																																						
			KVL1183A	1 ROTOR ARM PLUS CLEANING SYSTEM KIT	<table border="1"> <thead> <tr> <th>Code</th> <th>Description</th> <th>Qty</th> <th>UOM</th> </tr> </thead> <tbody> <tr> <td>0H2143A0</td> <td>LAMIERA BLOCCA VNR VL1128</td> <td>2</td> <td>PZ</td> </tr> <tr> <td>0H2168A1</td> <td></td> <td>1</td> <td>PZ</td> </tr> <tr> <td>0H2354A0</td> <td>XEVC-XEVL WASHING CIRCUIT PLAT</td> <td>1</td> <td>PZ</td> </tr> <tr> <td>EL1440A0</td> <td>WATER SELF CLEANING VALVE</td> <td>3</td> <td>PZ</td> </tr> <tr> <td>GN1526A0</td> <td>INT. D.=6.9 TH=1.8 O-RIN</td> <td>7</td> <td>PZ</td> </tr> <tr> <td>RC1018A0</td> <td>ZINC PLATED D12 ELASTIC CLAMP</td> <td>2</td> <td>PZ</td> </tr> </tbody> </table>	Code	Description	Qty	UOM	0H2143A0	LAMIERA BLOCCA VNR VL1128	2	PZ	0H2168A1		1	PZ	0H2354A0	XEVC-XEVL WASHING CIRCUIT PLAT	1	PZ	EL1440A0	WATER SELF CLEANING VALVE	3	PZ	GN1526A0	INT. D.=6.9 TH=1.8 O-RIN	7	PZ	RC1018A0	ZINC PLATED D12 ELASTIC CLAMP	2	PZ																								
Code	Description	Qty	UOM																																																						
0H2143A0	LAMIERA BLOCCA VNR VL1128	2	PZ																																																						
0H2168A1		1	PZ																																																						
0H2354A0	XEVC-XEVL WASHING CIRCUIT PLAT	1	PZ																																																						
EL1440A0	WATER SELF CLEANING VALVE	3	PZ																																																						
GN1526A0	INT. D.=6.9 TH=1.8 O-RIN	7	PZ																																																						
RC1018A0	ZINC PLATED D12 ELASTIC CLAMP	2	PZ																																																						

COMPONENT			SPARE PART																																																																																		
Code	Description	Image	Code	Description	Components list																																																																																
VL1166A	BB6-AR6 L FITTING		KVL1183A	1 ROTOR ARM PLUS CLEANING SYSTEM KIT	<table border="1"> <thead> <tr> <th>Code</th> <th>Description</th> <th>Qty</th> <th>UOM</th> </tr> </thead> <tbody> <tr> <td>RC1019A0</td> <td>D=10 ELASTIC CLAMP</td> <td>14</td> <td>PZ</td> </tr> <tr> <td>RC1130A0</td> <td>130X2,6 CLAM</td> <td>5</td> <td>PZ</td> </tr> <tr> <td>RC1131A0</td> <td>200X2.6 BLACK CLAMP</td> <td>2</td> <td>PZ</td> </tr> <tr> <td>RC1242A0</td> <td>D=10 CLOSED CAP</td> <td>2</td> <td>PZ</td> </tr> <tr> <td>RC1356A0</td> <td>"STRAIGHT THREADED FEMALE END 8X1/4" BS</td> <td>1</td> <td>PZ</td> </tr> <tr> <td>TB2820A0</td> <td>6X10 EPDM PIPE FOR WASHING SYSTEM</td> <td>1.410</td> <td>M</td> </tr> <tr> <td>TB3132A0</td> <td>WHITE-BLUE EPDM TEXTILE BRAID HOSE 6X12</td> <td>0.770</td> <td>M</td> </tr> <tr> <td>VI1220A1</td> <td>4,2X12 TCB SELF-TAPPIN G SCREW</td> <td>3</td> <td>PZ</td> </tr> <tr> <td>VL1019A0</td> <td>VIBRATION PUMP</td> <td>1</td> <td>PZ</td> </tr> <tr> <td>VL1047A1</td> <td>D6 PIPE HOLDER - D8 J.G. TERMINAL</td> <td>1</td> <td>PZ</td> </tr> <tr> <td>VL1065A1</td> <td>1/4 MALE N.O. PRESSURE SWITCH</td> <td>1</td> <td>PZ</td> </tr> <tr> <td>VL1102A1</td> <td>DETERGENT LINE FILTER + BARBED VNR 6 MM</td> <td>1</td> <td>PZ</td> </tr> <tr> <td>VL1128A0</td> <td>D6 BARBED CHECK VALVE</td> <td>2</td> <td>PZ</td> </tr> <tr> <td>VL1128A1</td> <td>D6 BARBED CHECK VALVE</td> <td>2</td> <td>PZ</td> </tr> <tr> <td>VL1165A0</td> <td>BB6-AR6 STRAIGHT FITTING</td> <td>1</td> <td>PZ</td> </tr> <tr> <td>VL1166A0</td> <td>BB6-AR6 L FITTING</td> <td>3</td> <td>PZ</td> </tr> <tr> <td>VL1174C0</td> <td>D1.2 MM CALIBRATED NOZZLE</td> <td>1</td> <td>PZ</td> </tr> <tr> <td>VL1185A0</td> <td>2 WAYS PLUS WASHING DISTRIBUTOR</td> <td>1</td> <td>PZ</td> </tr> <tr> <td>VL1190A0</td> <td>PLUS WASHING SYSTEM INLET DISTRIBUTOR</td> <td>1</td> <td>PZ</td> </tr> </tbody> </table>	Code	Description	Qty	UOM	RC1019A0	D=10 ELASTIC CLAMP	14	PZ	RC1130A0	130X2,6 CLAM	5	PZ	RC1131A0	200X2.6 BLACK CLAMP	2	PZ	RC1242A0	D=10 CLOSED CAP	2	PZ	RC1356A0	"STRAIGHT THREADED FEMALE END 8X1/4" BS	1	PZ	TB2820A0	6X10 EPDM PIPE FOR WASHING SYSTEM	1.410	M	TB3132A0	WHITE-BLUE EPDM TEXTILE BRAID HOSE 6X12	0.770	M	VI1220A1	4,2X12 TCB SELF-TAPPIN G SCREW	3	PZ	VL1019A0	VIBRATION PUMP	1	PZ	VL1047A1	D6 PIPE HOLDER - D8 J.G. TERMINAL	1	PZ	VL1065A1	1/4 MALE N.O. PRESSURE SWITCH	1	PZ	VL1102A1	DETERGENT LINE FILTER + BARBED VNR 6 MM	1	PZ	VL1128A0	D6 BARBED CHECK VALVE	2	PZ	VL1128A1	D6 BARBED CHECK VALVE	2	PZ	VL1165A0	BB6-AR6 STRAIGHT FITTING	1	PZ	VL1166A0	BB6-AR6 L FITTING	3	PZ	VL1174C0	D1.2 MM CALIBRATED NOZZLE	1	PZ	VL1185A0	2 WAYS PLUS WASHING DISTRIBUTOR	1	PZ	VL1190A0	PLUS WASHING SYSTEM INLET DISTRIBUTOR	1	PZ
Code	Description	Qty	UOM																																																																																		
RC1019A0	D=10 ELASTIC CLAMP	14	PZ																																																																																		
RC1130A0	130X2,6 CLAM	5	PZ																																																																																		
RC1131A0	200X2.6 BLACK CLAMP	2	PZ																																																																																		
RC1242A0	D=10 CLOSED CAP	2	PZ																																																																																		
RC1356A0	"STRAIGHT THREADED FEMALE END 8X1/4" BS	1	PZ																																																																																		
TB2820A0	6X10 EPDM PIPE FOR WASHING SYSTEM	1.410	M																																																																																		
TB3132A0	WHITE-BLUE EPDM TEXTILE BRAID HOSE 6X12	0.770	M																																																																																		
VI1220A1	4,2X12 TCB SELF-TAPPIN G SCREW	3	PZ																																																																																		
VL1019A0	VIBRATION PUMP	1	PZ																																																																																		
VL1047A1	D6 PIPE HOLDER - D8 J.G. TERMINAL	1	PZ																																																																																		
VL1065A1	1/4 MALE N.O. PRESSURE SWITCH	1	PZ																																																																																		
VL1102A1	DETERGENT LINE FILTER + BARBED VNR 6 MM	1	PZ																																																																																		
VL1128A0	D6 BARBED CHECK VALVE	2	PZ																																																																																		
VL1128A1	D6 BARBED CHECK VALVE	2	PZ																																																																																		
VL1165A0	BB6-AR6 STRAIGHT FITTING	1	PZ																																																																																		
VL1166A0	BB6-AR6 L FITTING	3	PZ																																																																																		
VL1174C0	D1.2 MM CALIBRATED NOZZLE	1	PZ																																																																																		
VL1185A0	2 WAYS PLUS WASHING DISTRIBUTOR	1	PZ																																																																																		
VL1190A0	PLUS WASHING SYSTEM INLET DISTRIBUTOR	1	PZ																																																																																		

COMPONENT			SPARE PART																																																																			
Code	Description	Image	Code	Description	Components list																																																																	
VL1166A	BB6-AR6 L FITTING		KVL1183A	1 ROTOR ARM PLUS CLEANING SYSTEM KIT	<table border="1"> <thead> <tr> <th>Code</th> <th>Description</th> <th>Qty</th> <th>UOM</th> </tr> </thead> <tbody> <tr> <td>VM1605A0</td> <td>CLIP TWIST LOCK DIAM. 10,2-12,7 MM</td> <td>3</td> <td>PZ</td> </tr> <tr> <td>VM2172A0</td> <td>PUMP-WITH-CI RCUIT LOCKING PIN</td> <td>7</td> <td>PZ</td> </tr> </tbody> </table>	Code	Description	Qty	UOM	VM1605A0	CLIP TWIST LOCK DIAM. 10,2-12,7 MM	3	PZ	VM2172A0	PUMP-WITH-CI RCUIT LOCKING PIN	7	PZ																																																					
			Code	Description	Qty	UOM																																																																
VM1605A0	CLIP TWIST LOCK DIAM. 10,2-12,7 MM	3	PZ																																																																			
VM2172A0	PUMP-WITH-CI RCUIT LOCKING PIN	7	PZ																																																																			
KVL1182A	ONE CLEANING SYSTEM KIT (0311 EXC.)	<table border="1"> <thead> <tr> <th>Code</th> <th>Description</th> <th>Qty</th> <th>UOM</th> </tr> </thead> <tbody> <tr> <td>0H2143A0</td> <td>LAMIERA BLOCCA VNR VL1128</td> <td>2</td> <td>PZ</td> </tr> <tr> <td>0H2202A1</td> <td>ONE WASHING WITH STEAM VALVE SUPPORT</td> <td>1</td> <td>PZ</td> </tr> <tr> <td>EL1440A0</td> <td>WATER SELF CLEANING VALVE</td> <td>1</td> <td>PZ</td> </tr> <tr> <td>GN1526A0</td> <td>INT. D.=6.9 TH=1.8 O-RIN</td> <td>3</td> <td>PZ</td> </tr> <tr> <td>RC1018A0</td> <td>ZINC PLATED D12 ELASTIC CLAMP</td> <td>1</td> <td>PZ</td> </tr> <tr> <td>RC1019A0</td> <td>D=10 ELASTIC CLAMP</td> <td>14</td> <td>PZ</td> </tr> <tr> <td>RC1130A0</td> <td>130X2,6 CLAM</td> <td>2</td> <td>PZ</td> </tr> <tr> <td>RC1242A0</td> <td>D=10 CLOSED CAP</td> <td>2</td> <td>PZ</td> </tr> <tr> <td>TB2820A0</td> <td>6X10 EPDM PIPE FOR WASHING SYSTEM</td> <td>1.410</td> <td>M</td> </tr> <tr> <td>TB3132A0</td> <td>WHITE-BLUE EPDM TEXTILE BRAID HOSE 6X12</td> <td>0.670</td> <td>M</td> </tr> <tr> <td>VI1220A1</td> <td>4,2X12 TCB SELF-TAPPIN G SCREW</td> <td>1</td> <td>PZ</td> </tr> <tr> <td>VL1019A0</td> <td>VIBRATION PUMP</td> <td>1</td> <td>PZ</td> </tr> <tr> <td>VL1047A1</td> <td>D6 PIPE HOLDER - D8 J.G. TERMINAL</td> <td>1</td> <td>PZ</td> </tr> <tr> <td>VL1054B0</td> <td>ONE WASHING SYS INLET DISTRIBUTOR</td> <td>1</td> <td>PZ</td> </tr> <tr> <td>VL1102A1</td> <td>DETERGENT LINE FILTER + BARBED VNR 6 MM</td> <td>1</td> <td>PZ</td> </tr> <tr> <td>VL1128A0</td> <td>D6 BARBED CHECK VALVE</td> <td>2</td> <td>PZ</td> </tr> </tbody> </table>	Code	Description	Qty	UOM	0H2143A0	LAMIERA BLOCCA VNR VL1128	2	PZ	0H2202A1	ONE WASHING WITH STEAM VALVE SUPPORT	1	PZ	EL1440A0	WATER SELF CLEANING VALVE	1	PZ	GN1526A0	INT. D.=6.9 TH=1.8 O-RIN	3	PZ	RC1018A0	ZINC PLATED D12 ELASTIC CLAMP	1	PZ	RC1019A0	D=10 ELASTIC CLAMP	14	PZ	RC1130A0	130X2,6 CLAM	2	PZ	RC1242A0	D=10 CLOSED CAP	2	PZ	TB2820A0	6X10 EPDM PIPE FOR WASHING SYSTEM	1.410	M	TB3132A0	WHITE-BLUE EPDM TEXTILE BRAID HOSE 6X12	0.670	M	VI1220A1	4,2X12 TCB SELF-TAPPIN G SCREW	1	PZ	VL1019A0	VIBRATION PUMP	1	PZ	VL1047A1	D6 PIPE HOLDER - D8 J.G. TERMINAL	1	PZ	VL1054B0	ONE WASHING SYS INLET DISTRIBUTOR	1	PZ	VL1102A1	DETERGENT LINE FILTER + BARBED VNR 6 MM	1	PZ	VL1128A0	D6 BARBED CHECK VALVE	2	PZ
Code	Description	Qty	UOM																																																																			
0H2143A0	LAMIERA BLOCCA VNR VL1128	2	PZ																																																																			
0H2202A1	ONE WASHING WITH STEAM VALVE SUPPORT	1	PZ																																																																			
EL1440A0	WATER SELF CLEANING VALVE	1	PZ																																																																			
GN1526A0	INT. D.=6.9 TH=1.8 O-RIN	3	PZ																																																																			
RC1018A0	ZINC PLATED D12 ELASTIC CLAMP	1	PZ																																																																			
RC1019A0	D=10 ELASTIC CLAMP	14	PZ																																																																			
RC1130A0	130X2,6 CLAM	2	PZ																																																																			
RC1242A0	D=10 CLOSED CAP	2	PZ																																																																			
TB2820A0	6X10 EPDM PIPE FOR WASHING SYSTEM	1.410	M																																																																			
TB3132A0	WHITE-BLUE EPDM TEXTILE BRAID HOSE 6X12	0.670	M																																																																			
VI1220A1	4,2X12 TCB SELF-TAPPIN G SCREW	1	PZ																																																																			
VL1019A0	VIBRATION PUMP	1	PZ																																																																			
VL1047A1	D6 PIPE HOLDER - D8 J.G. TERMINAL	1	PZ																																																																			
VL1054B0	ONE WASHING SYS INLET DISTRIBUTOR	1	PZ																																																																			
VL1102A1	DETERGENT LINE FILTER + BARBED VNR 6 MM	1	PZ																																																																			
VL1128A0	D6 BARBED CHECK VALVE	2	PZ																																																																			

COMPONENT			SPARE PART																																		
Code	Description	Image	Code	Description	Components list																																
VL1166A	BB6-AR6 L FITTING		KVL1182A	ONE CLEANING SYSTEM KIT (0311 EXC.)	<table border="1"> <thead> <tr> <th>Code</th> <th>Description</th> <th>Qty</th> <th>UOM</th> </tr> </thead> <tbody> <tr> <td>VL1128A1</td> <td>D6 BARBED CHECK VALVE</td> <td>2</td> <td>PZ</td> </tr> <tr> <td>VL1165A0</td> <td>BB6-AR6 STRAIGHT FITTING</td> <td>1</td> <td>PZ</td> </tr> <tr> <td>VL1166A0</td> <td>BB6-AR6 L FITTING</td> <td>1</td> <td>PZ</td> </tr> <tr> <td>VL1174C0</td> <td>D1.2 MM CALIBRATED NOZZLE</td> <td>1</td> <td>PZ</td> </tr> <tr> <td>VL1191A0</td> <td>ONE WASHING DISTRIBUTOR OUTLETS KIT</td> <td>1</td> <td>PZ</td> </tr> <tr> <td>VM1605A0</td> <td>CLIP TWIST LOCK DIAM. 10,2-12,7 MM</td> <td>3</td> <td>PZ</td> </tr> <tr> <td>VM2172A0</td> <td>PUMP-WITH-CIRCUIT RCUIT LOCKING PIN</td> <td>2</td> <td>PZ</td> </tr> </tbody> </table>	Code	Description	Qty	UOM	VL1128A1	D6 BARBED CHECK VALVE	2	PZ	VL1165A0	BB6-AR6 STRAIGHT FITTING	1	PZ	VL1166A0	BB6-AR6 L FITTING	1	PZ	VL1174C0	D1.2 MM CALIBRATED NOZZLE	1	PZ	VL1191A0	ONE WASHING DISTRIBUTOR OUTLETS KIT	1	PZ	VM1605A0	CLIP TWIST LOCK DIAM. 10,2-12,7 MM	3	PZ	VM2172A0	PUMP-WITH-CIRCUIT RCUIT LOCKING PIN	2	PZ
Code	Description	Qty	UOM																																		
VL1128A1	D6 BARBED CHECK VALVE	2	PZ																																		
VL1165A0	BB6-AR6 STRAIGHT FITTING	1	PZ																																		
VL1166A0	BB6-AR6 L FITTING	1	PZ																																		
VL1174C0	D1.2 MM CALIBRATED NOZZLE	1	PZ																																		
VL1191A0	ONE WASHING DISTRIBUTOR OUTLETS KIT	1	PZ																																		
VM1605A0	CLIP TWIST LOCK DIAM. 10,2-12,7 MM	3	PZ																																		
VM2172A0	PUMP-WITH-CIRCUIT RCUIT LOCKING PIN	2	PZ																																		
VM2172A	PUMP-WITH-CIRCUIT LOCKING PIN		VM2172A0	PUMP-WITH-CIRCUIT LOCKING PIN																																	
VL1019A	VIBRATION PUMP		KVL2618A	2 ROTOR ARMS ONE CLEANING SYSTEM KIT	<table border="1"> <thead> <tr> <th>Code</th> <th>Description</th> <th>Qty</th> <th>UOM</th> </tr> </thead> <tbody> <tr> <td>0H2202A1</td> <td>ONE WASHING WITH STEAM VALVE SUPPORT</td> <td>2</td> <td>PZ</td> </tr> <tr> <td>CE1030A0</td> <td>FEMALE FASTON COVER 6,3X0,8 0,5-1MMQ</td> <td>4</td> <td>PZ</td> </tr> <tr> <td>CE1395A0</td> <td>6,3 X 0,8 FEMALE FASTON</td> <td>2</td> <td>PZ</td> </tr> <tr> <td>CE1545A0</td> <td>BLUE UNIP AWG18 ST.3135 WIRE</td> <td>1</td> <td>M</td> </tr> <tr> <td>CE1570A0</td> <td>WHITE UNIP AWG18 ST.3135 WIRE</td> <td>1</td> <td>M</td> </tr> <tr> <td>CE1660A0</td> <td>6,3X0,8 FEMALE FASTON COVER</td> <td>4</td> <td>PZ</td> </tr> <tr> <td>CE1661A0</td> <td>MALE FASTON COVER 6,3X0,</td> <td>2</td> <td>PZ</td> </tr> </tbody> </table>	Code	Description	Qty	UOM	0H2202A1	ONE WASHING WITH STEAM VALVE SUPPORT	2	PZ	CE1030A0	FEMALE FASTON COVER 6,3X0,8 0,5-1MMQ	4	PZ	CE1395A0	6,3 X 0,8 FEMALE FASTON	2	PZ	CE1545A0	BLUE UNIP AWG18 ST.3135 WIRE	1	M	CE1570A0	WHITE UNIP AWG18 ST.3135 WIRE	1	M	CE1660A0	6,3X0,8 FEMALE FASTON COVER	4	PZ	CE1661A0	MALE FASTON COVER 6,3X0,	2	PZ
Code	Description	Qty	UOM																																		
0H2202A1	ONE WASHING WITH STEAM VALVE SUPPORT	2	PZ																																		
CE1030A0	FEMALE FASTON COVER 6,3X0,8 0,5-1MMQ	4	PZ																																		
CE1395A0	6,3 X 0,8 FEMALE FASTON	2	PZ																																		
CE1545A0	BLUE UNIP AWG18 ST.3135 WIRE	1	M																																		
CE1570A0	WHITE UNIP AWG18 ST.3135 WIRE	1	M																																		
CE1660A0	6,3X0,8 FEMALE FASTON COVER	4	PZ																																		
CE1661A0	MALE FASTON COVER 6,3X0,	2	PZ																																		

COMPONENT			SPARE PART																																																																																		
Code	Description	Image	Code	Description	Components list																																																																																
VL1019A	VIBRATION PUMP		KVL2618A	2 ROTOR ARMS ONE CLEANING SYSTEM KIT	<table border="1"> <thead> <tr> <th>Code</th> <th>Description</th> <th>Qty</th> <th>UOM</th> </tr> </thead> <tbody> <tr> <td>EL1020A1</td> <td>D8 INTERMEDIAT E T-SHAPED FITTING</td> <td>1</td> <td>PZ</td> </tr> <tr> <td>EL1440A0</td> <td>WATER SELF CLEANING VALVE</td> <td>2</td> <td>PZ</td> </tr> <tr> <td>GN1526A0</td> <td>INT. D.=6.9 TH=1.8 O-RIN</td> <td>6</td> <td>PZ</td> </tr> <tr> <td>IP1385A1</td> <td>CORNER POLYSTYREN E PACKING 110X80X2000</td> <td>0.500</td> <td>M</td> </tr> <tr> <td>RC1018A0</td> <td>ZINC PLATED D12 ELASTIC CLAMP</td> <td>4</td> <td>PZ</td> </tr> <tr> <td>RC1019A0</td> <td>D=10 ELASTIC CLAMP</td> <td>31</td> <td>PZ</td> </tr> <tr> <td>RC1130A0</td> <td>130X2,6 CLAM</td> <td>4</td> <td>PZ</td> </tr> <tr> <td>RC1242A0</td> <td>D=10 CLOSED CAP</td> <td>4</td> <td>PZ</td> </tr> <tr> <td>TB2820A0</td> <td>6X10 EPDM PIPE FOR WASHING SYSTEM</td> <td>2.920</td> <td>M</td> </tr> <tr> <td>TB3132A0</td> <td>WHITE-BLUE EPDM TEXTILE BRAID HOSE 6X12</td> <td>1.340</td> <td>M</td> </tr> <tr> <td>VI1220A1</td> <td>4,2X12 TCB SELF-TAPPIN G SCREW</td> <td>2</td> <td>PZ</td> </tr> <tr> <td>VL1019A0</td> <td>VIBRATION PUMP</td> <td>2</td> <td>PZ</td> </tr> <tr> <td>VL1047A1</td> <td>D6 PIPE HOLDER - D8 J.G. TERMINAL</td> <td>2</td> <td>PZ</td> </tr> <tr> <td>VL1054B0</td> <td>ONE WASHING SYS INLET DISTRIBUTOR</td> <td>2</td> <td>PZ</td> </tr> <tr> <td>VL1102A1</td> <td>DETERGENT LINE FILTER + BARBED VNR 6 MM</td> <td>2</td> <td>PZ</td> </tr> <tr> <td>VL1127A1</td> <td>6MM BARBED T-SHAPED FITTING</td> <td>1</td> <td>PZ</td> </tr> <tr> <td>VL1128A1</td> <td>D6 BARBED CHECK VALVE</td> <td>4</td> <td>PZ</td> </tr> <tr> <td>VL1165A0</td> <td>BB6-AR6 STRAIGHT FITTING</td> <td>2</td> <td>PZ</td> </tr> <tr> <td>VL1166A0</td> <td>BB6-AR6 L FITTING</td> <td>2</td> <td>PZ</td> </tr> </tbody> </table>	Code	Description	Qty	UOM	EL1020A1	D8 INTERMEDIAT E T-SHAPED FITTING	1	PZ	EL1440A0	WATER SELF CLEANING VALVE	2	PZ	GN1526A0	INT. D.=6.9 TH=1.8 O-RIN	6	PZ	IP1385A1	CORNER POLYSTYREN E PACKING 110X80X2000	0.500	M	RC1018A0	ZINC PLATED D12 ELASTIC CLAMP	4	PZ	RC1019A0	D=10 ELASTIC CLAMP	31	PZ	RC1130A0	130X2,6 CLAM	4	PZ	RC1242A0	D=10 CLOSED CAP	4	PZ	TB2820A0	6X10 EPDM PIPE FOR WASHING SYSTEM	2.920	M	TB3132A0	WHITE-BLUE EPDM TEXTILE BRAID HOSE 6X12	1.340	M	VI1220A1	4,2X12 TCB SELF-TAPPIN G SCREW	2	PZ	VL1019A0	VIBRATION PUMP	2	PZ	VL1047A1	D6 PIPE HOLDER - D8 J.G. TERMINAL	2	PZ	VL1054B0	ONE WASHING SYS INLET DISTRIBUTOR	2	PZ	VL1102A1	DETERGENT LINE FILTER + BARBED VNR 6 MM	2	PZ	VL1127A1	6MM BARBED T-SHAPED FITTING	1	PZ	VL1128A1	D6 BARBED CHECK VALVE	4	PZ	VL1165A0	BB6-AR6 STRAIGHT FITTING	2	PZ	VL1166A0	BB6-AR6 L FITTING	2	PZ
Code	Description	Qty	UOM																																																																																		
EL1020A1	D8 INTERMEDIAT E T-SHAPED FITTING	1	PZ																																																																																		
EL1440A0	WATER SELF CLEANING VALVE	2	PZ																																																																																		
GN1526A0	INT. D.=6.9 TH=1.8 O-RIN	6	PZ																																																																																		
IP1385A1	CORNER POLYSTYREN E PACKING 110X80X2000	0.500	M																																																																																		
RC1018A0	ZINC PLATED D12 ELASTIC CLAMP	4	PZ																																																																																		
RC1019A0	D=10 ELASTIC CLAMP	31	PZ																																																																																		
RC1130A0	130X2,6 CLAM	4	PZ																																																																																		
RC1242A0	D=10 CLOSED CAP	4	PZ																																																																																		
TB2820A0	6X10 EPDM PIPE FOR WASHING SYSTEM	2.920	M																																																																																		
TB3132A0	WHITE-BLUE EPDM TEXTILE BRAID HOSE 6X12	1.340	M																																																																																		
VI1220A1	4,2X12 TCB SELF-TAPPIN G SCREW	2	PZ																																																																																		
VL1019A0	VIBRATION PUMP	2	PZ																																																																																		
VL1047A1	D6 PIPE HOLDER - D8 J.G. TERMINAL	2	PZ																																																																																		
VL1054B0	ONE WASHING SYS INLET DISTRIBUTOR	2	PZ																																																																																		
VL1102A1	DETERGENT LINE FILTER + BARBED VNR 6 MM	2	PZ																																																																																		
VL1127A1	6MM BARBED T-SHAPED FITTING	1	PZ																																																																																		
VL1128A1	D6 BARBED CHECK VALVE	4	PZ																																																																																		
VL1165A0	BB6-AR6 STRAIGHT FITTING	2	PZ																																																																																		
VL1166A0	BB6-AR6 L FITTING	2	PZ																																																																																		

COMPONENT			SPARE PART																																																															
Code	Description	Image	Code	Description	Components list																																																													
VL1019A	VIBRATION PUMP		KVL2618A	2 ROTOR ARMS ONE CLEANING SYSTEM KIT	<table border="1"> <thead> <tr> <th>Code</th> <th>Description</th> <th>Qty</th> <th>UOM</th> </tr> </thead> <tbody> <tr> <td>VL1174C0</td> <td>D1.2 MM CALIBRATED NOZZLE</td> <td>2</td> <td>PZ</td> </tr> <tr> <td>VL1191A0</td> <td>ONE WASHING DISTRIBUTOR OUTLETS KIT</td> <td>2</td> <td>PZ</td> </tr> <tr> <td>VM2172A0</td> <td>PUMP-WITH-CI RCUIT LOCKING PIN</td> <td>4</td> <td>PZ</td> </tr> </tbody> </table>	Code	Description	Qty	UOM	VL1174C0	D1.2 MM CALIBRATED NOZZLE	2	PZ	VL1191A0	ONE WASHING DISTRIBUTOR OUTLETS KIT	2	PZ	VM2172A0	PUMP-WITH-CI RCUIT LOCKING PIN	4	PZ																																													
			Code	Description	Qty	UOM																																																												
VL1174C0	D1.2 MM CALIBRATED NOZZLE	2	PZ																																																															
VL1191A0	ONE WASHING DISTRIBUTOR OUTLETS KIT	2	PZ																																																															
VM2172A0	PUMP-WITH-CI RCUIT LOCKING PIN	4	PZ																																																															
KVL1225A	US HOOD WASHING SYSTEM KIT	<table border="1"> <thead> <tr> <th>Code</th> <th>Description</th> <th>Qty</th> <th>UOM</th> </tr> </thead> <tbody> <tr> <td>0H2213A1</td> <td></td> <td>1</td> <td>PZ</td> </tr> <tr> <td>EL1450A0</td> <td>US SELF-CLEANIN G WATER SOLENOID</td> <td>2</td> <td>PZ</td> </tr> <tr> <td>GN1526A0</td> <td>INT. D.=6.9 TH=1.8 O-RIN</td> <td>5</td> <td>PZ</td> </tr> <tr> <td>RC1018A0</td> <td>ZINC PLATED D12 ELASTIC CLAMP</td> <td>5</td> <td>PZ</td> </tr> <tr> <td>RC1019A0</td> <td>D=10 ELASTIC CLAMP</td> <td>16</td> <td>PZ</td> </tr> <tr> <td>RC1131A0</td> <td>200X2.6 BLACK CLAMP</td> <td>1</td> <td>PZ</td> </tr> <tr> <td>RC1242A0</td> <td>D=10 CLOSED CAP</td> <td>2</td> <td>PZ</td> </tr> <tr> <td>TB2820A0</td> <td>6X10 EPDM PIPE FOR WASHING SYSTEM</td> <td>2.240</td> <td>M</td> </tr> <tr> <td>TB3132A0</td> <td>WHITE-BLUE EPDM TEXTILE BRAID HOSE 6X12</td> <td>0.440</td> <td>M</td> </tr> <tr> <td>VI1220A1</td> <td>4,2X12 TCB SELF-TAPPIN G SCREW</td> <td>3</td> <td>PZ</td> </tr> <tr> <td>VL1019A0</td> <td>VIBRATION PUMP</td> <td>1</td> <td>PZ</td> </tr> <tr> <td>VL1047A1</td> <td>D6 PIPE HOLDER - D8 J.G. TERMINAL</td> <td>1</td> <td>PZ</td> </tr> <tr> <td>VL1054B0</td> <td>ONE WASHING SYS INLET DISTRIBUTOR</td> <td>1</td> <td>PZ</td> </tr> <tr> <td>VL1102A1</td> <td>DETERGENT LINE FILTER + BARBED VNR 6 MM</td> <td>1</td> <td>PZ</td> </tr> <tr> <td>VL1127A1</td> <td>6MM BARBED T-SHAPED FITTING</td> <td>1</td> <td>PZ</td> </tr> </tbody> </table>	Code	Description	Qty	UOM	0H2213A1		1	PZ	EL1450A0	US SELF-CLEANIN G WATER SOLENOID	2	PZ	GN1526A0	INT. D.=6.9 TH=1.8 O-RIN	5	PZ	RC1018A0	ZINC PLATED D12 ELASTIC CLAMP	5	PZ	RC1019A0	D=10 ELASTIC CLAMP	16	PZ	RC1131A0	200X2.6 BLACK CLAMP	1	PZ	RC1242A0	D=10 CLOSED CAP	2	PZ	TB2820A0	6X10 EPDM PIPE FOR WASHING SYSTEM	2.240	M	TB3132A0	WHITE-BLUE EPDM TEXTILE BRAID HOSE 6X12	0.440	M	VI1220A1	4,2X12 TCB SELF-TAPPIN G SCREW	3	PZ	VL1019A0	VIBRATION PUMP	1	PZ	VL1047A1	D6 PIPE HOLDER - D8 J.G. TERMINAL	1	PZ	VL1054B0	ONE WASHING SYS INLET DISTRIBUTOR	1	PZ	VL1102A1	DETERGENT LINE FILTER + BARBED VNR 6 MM	1	PZ	VL1127A1	6MM BARBED T-SHAPED FITTING	1	PZ
Code	Description	Qty	UOM																																																															
0H2213A1		1	PZ																																																															
EL1450A0	US SELF-CLEANIN G WATER SOLENOID	2	PZ																																																															
GN1526A0	INT. D.=6.9 TH=1.8 O-RIN	5	PZ																																																															
RC1018A0	ZINC PLATED D12 ELASTIC CLAMP	5	PZ																																																															
RC1019A0	D=10 ELASTIC CLAMP	16	PZ																																																															
RC1131A0	200X2.6 BLACK CLAMP	1	PZ																																																															
RC1242A0	D=10 CLOSED CAP	2	PZ																																																															
TB2820A0	6X10 EPDM PIPE FOR WASHING SYSTEM	2.240	M																																																															
TB3132A0	WHITE-BLUE EPDM TEXTILE BRAID HOSE 6X12	0.440	M																																																															
VI1220A1	4,2X12 TCB SELF-TAPPIN G SCREW	3	PZ																																																															
VL1019A0	VIBRATION PUMP	1	PZ																																																															
VL1047A1	D6 PIPE HOLDER - D8 J.G. TERMINAL	1	PZ																																																															
VL1054B0	ONE WASHING SYS INLET DISTRIBUTOR	1	PZ																																																															
VL1102A1	DETERGENT LINE FILTER + BARBED VNR 6 MM	1	PZ																																																															
VL1127A1	6MM BARBED T-SHAPED FITTING	1	PZ																																																															

COMPONENT			SPARE PART																																																			
Code	Description	Image	Code	Description	Components list																																																	
VL1019A	VIBRATION PUMP		KVL1225A	US HOOD WASHING SYSTEM KIT	<table border="1"> <thead> <tr> <th>Code</th> <th>Description</th> <th>Qty</th> <th>UOM</th> </tr> </thead> <tbody> <tr> <td>VL1128A1</td> <td>D6 BARBED CHECK VALVE</td> <td>2</td> <td>PZ</td> </tr> <tr> <td>VL1165A0</td> <td>BB6-AR6 STRAIGHT FITTING</td> <td>2</td> <td>PZ</td> </tr> <tr> <td>VL1166A0</td> <td>BB6-AR6 L FITTING</td> <td>2</td> <td>PZ</td> </tr> <tr> <td>VL1174C0</td> <td>D1.2 MM CALIBRATED NOZZLE</td> <td>1</td> <td>PZ</td> </tr> <tr> <td>VL1191A0</td> <td>ONE WASHING DISTRIBUTOR OUTLETS KIT</td> <td>1</td> <td>PZ</td> </tr> <tr> <td>VM1605A0</td> <td>CLIP TWIST LOCK DIAM. 10,2-12,7 MM</td> <td>2</td> <td>PZ</td> </tr> <tr> <td>VM2172A0</td> <td>PUMP-WITH-CI RCUIT LOCKING PIN</td> <td>5</td> <td>PZ</td> </tr> </tbody> </table>	Code	Description	Qty	UOM	VL1128A1	D6 BARBED CHECK VALVE	2	PZ	VL1165A0	BB6-AR6 STRAIGHT FITTING	2	PZ	VL1166A0	BB6-AR6 L FITTING	2	PZ	VL1174C0	D1.2 MM CALIBRATED NOZZLE	1	PZ	VL1191A0	ONE WASHING DISTRIBUTOR OUTLETS KIT	1	PZ	VM1605A0	CLIP TWIST LOCK DIAM. 10,2-12,7 MM	2	PZ	VM2172A0	PUMP-WITH-CI RCUIT LOCKING PIN	5	PZ																	
			Code	Description	Qty	UOM																																																
VL1128A1	D6 BARBED CHECK VALVE	2	PZ																																																			
VL1165A0	BB6-AR6 STRAIGHT FITTING	2	PZ																																																			
VL1166A0	BB6-AR6 L FITTING	2	PZ																																																			
VL1174C0	D1.2 MM CALIBRATED NOZZLE	1	PZ																																																			
VL1191A0	ONE WASHING DISTRIBUTOR OUTLETS KIT	1	PZ																																																			
VM1605A0	CLIP TWIST LOCK DIAM. 10,2-12,7 MM	2	PZ																																																			
VM2172A0	PUMP-WITH-CI RCUIT LOCKING PIN	5	PZ																																																			
KVL1222A	EUR 0311 ONE PLUS CLEANING SYSTEM KIT	<table border="1"> <thead> <tr> <th>Code</th> <th>Description</th> <th>Qty</th> <th>UOM</th> </tr> </thead> <tbody> <tr> <td>0H2486A0</td> <td></td> <td>1</td> <td>PZ</td> </tr> <tr> <td>EL1440A0</td> <td>WATER SELF CLEANING VALVE</td> <td>1</td> <td>PZ</td> </tr> <tr> <td>GN1526A0</td> <td>INT. D.=6.9 TH=1.8 O-RIN</td> <td>3</td> <td>PZ</td> </tr> <tr> <td>RC1018A0</td> <td>ZINC PLATED D12 ELASTIC CLAMP</td> <td>2</td> <td>PZ</td> </tr> <tr> <td>RC1019A0</td> <td>D=10 ELASTIC CLAMP</td> <td>14</td> <td>PZ</td> </tr> <tr> <td>RC1242A0</td> <td>D=10 CLOSED CAP</td> <td>2</td> <td>PZ</td> </tr> <tr> <td>TB2820A0</td> <td>6X10 EPDM PIPE FOR WASHING SYSTEM</td> <td>1.460</td> <td>M</td> </tr> <tr> <td>TB3132A0</td> <td>WHITE-BLUE EPDM TEXTILE BRAID HOSE 6X12</td> <td>0.670</td> <td>M</td> </tr> <tr> <td>VI1220A1</td> <td>4,2X12 TCB SELF-TAPPIN G SCREW</td> <td>4</td> <td>PZ</td> </tr> <tr> <td>VL1019A0</td> <td>VIBRATION PUMP</td> <td>1</td> <td>PZ</td> </tr> <tr> <td>VL1047A1</td> <td>D6 PIPE HOLDER - D8 J.G. TERMINAL</td> <td>1</td> <td>PZ</td> </tr> <tr> <td>VL1054B0</td> <td>ONE WASHING SYS INLET DISTRIBUTOR</td> <td>1</td> <td>PZ</td> </tr> </tbody> </table>	Code	Description	Qty	UOM	0H2486A0		1	PZ	EL1440A0	WATER SELF CLEANING VALVE	1	PZ	GN1526A0	INT. D.=6.9 TH=1.8 O-RIN	3	PZ	RC1018A0	ZINC PLATED D12 ELASTIC CLAMP	2	PZ	RC1019A0	D=10 ELASTIC CLAMP	14	PZ	RC1242A0	D=10 CLOSED CAP	2	PZ	TB2820A0	6X10 EPDM PIPE FOR WASHING SYSTEM	1.460	M	TB3132A0	WHITE-BLUE EPDM TEXTILE BRAID HOSE 6X12	0.670	M	VI1220A1	4,2X12 TCB SELF-TAPPIN G SCREW	4	PZ	VL1019A0	VIBRATION PUMP	1	PZ	VL1047A1	D6 PIPE HOLDER - D8 J.G. TERMINAL	1	PZ	VL1054B0	ONE WASHING SYS INLET DISTRIBUTOR	1	PZ
Code	Description	Qty	UOM																																																			
0H2486A0		1	PZ																																																			
EL1440A0	WATER SELF CLEANING VALVE	1	PZ																																																			
GN1526A0	INT. D.=6.9 TH=1.8 O-RIN	3	PZ																																																			
RC1018A0	ZINC PLATED D12 ELASTIC CLAMP	2	PZ																																																			
RC1019A0	D=10 ELASTIC CLAMP	14	PZ																																																			
RC1242A0	D=10 CLOSED CAP	2	PZ																																																			
TB2820A0	6X10 EPDM PIPE FOR WASHING SYSTEM	1.460	M																																																			
TB3132A0	WHITE-BLUE EPDM TEXTILE BRAID HOSE 6X12	0.670	M																																																			
VI1220A1	4,2X12 TCB SELF-TAPPIN G SCREW	4	PZ																																																			
VL1019A0	VIBRATION PUMP	1	PZ																																																			
VL1047A1	D6 PIPE HOLDER - D8 J.G. TERMINAL	1	PZ																																																			
VL1054B0	ONE WASHING SYS INLET DISTRIBUTOR	1	PZ																																																			

COMPONENT			SPARE PART																																																			
Code	Description	Image	Code	Description	Components list																																																	
VL1019A	VIBRATION PUMP		KVL1222A	EUR 0311 ONE PLUS CLEANING SYSTEM KIT	<table border="1"> <thead> <tr> <th>Code</th> <th>Description</th> <th>Qty</th> <th>UOM</th> </tr> </thead> <tbody> <tr> <td>VL1102A1</td> <td>DETERGENT LINE FILTER + BARBED VNR 6 MM</td> <td>1</td> <td>PZ</td> </tr> <tr> <td>VL1128A1</td> <td>D6 BARBED CHECK VALVE</td> <td>2</td> <td>PZ</td> </tr> <tr> <td>VL1165A0</td> <td>BB6-AR6 STRAIGHT FITTING</td> <td>1</td> <td>PZ</td> </tr> <tr> <td>VL1166A0</td> <td>BB6-AR6 L FITTING</td> <td>1</td> <td>PZ</td> </tr> <tr> <td>VL1174C0</td> <td>D1.2 MM CALIBRATED NOZZLE</td> <td>1</td> <td>PZ</td> </tr> <tr> <td>VL1191A0</td> <td>ONE WASHING DISTRIBUTOR OUTLETS KIT</td> <td>1</td> <td>PZ</td> </tr> <tr> <td>VM2172A0</td> <td>PUMP-WITH-CI RCUIT LOCKING PIN</td> <td>3</td> <td>PZ</td> </tr> </tbody> </table>	Code	Description	Qty	UOM	VL1102A1	DETERGENT LINE FILTER + BARBED VNR 6 MM	1	PZ	VL1128A1	D6 BARBED CHECK VALVE	2	PZ	VL1165A0	BB6-AR6 STRAIGHT FITTING	1	PZ	VL1166A0	BB6-AR6 L FITTING	1	PZ	VL1174C0	D1.2 MM CALIBRATED NOZZLE	1	PZ	VL1191A0	ONE WASHING DISTRIBUTOR OUTLETS KIT	1	PZ	VM2172A0	PUMP-WITH-CI RCUIT LOCKING PIN	3	PZ																	
			Code	Description	Qty	UOM																																																
VL1102A1	DETERGENT LINE FILTER + BARBED VNR 6 MM	1	PZ																																																			
VL1128A1	D6 BARBED CHECK VALVE	2	PZ																																																			
VL1165A0	BB6-AR6 STRAIGHT FITTING	1	PZ																																																			
VL1166A0	BB6-AR6 L FITTING	1	PZ																																																			
VL1174C0	D1.2 MM CALIBRATED NOZZLE	1	PZ																																																			
VL1191A0	ONE WASHING DISTRIBUTOR OUTLETS KIT	1	PZ																																																			
VM2172A0	PUMP-WITH-CI RCUIT LOCKING PIN	3	PZ																																																			
KVL1213A	US PLUS COMPACT WASHING SYSTEM KIT	<table border="1"> <thead> <tr> <th>Code</th> <th>Description</th> <th>Qty</th> <th>UOM</th> </tr> </thead> <tbody> <tr> <td>0H2428A0</td> <td></td> <td>1</td> <td>PZ</td> </tr> <tr> <td>EL1450A0</td> <td>US SELF-CLEANING WATER SOLENOID</td> <td>3</td> <td>PZ</td> </tr> <tr> <td>GN1312A0</td> <td>RUBBER CABLE-PASSING DE=26 DI=15 SP=10</td> <td>1</td> <td>PZ</td> </tr> <tr> <td>GN1526A0</td> <td>INT. D.=6.9 TH=1.8 O-RING</td> <td>7</td> <td>PZ</td> </tr> <tr> <td>RC1018A0</td> <td>ZINC PLATED D12 ELASTIC CLAMP</td> <td>3</td> <td>PZ</td> </tr> <tr> <td>RC1019A0</td> <td>D=10 ELASTIC CLAMP</td> <td>14</td> <td>PZ</td> </tr> <tr> <td>RC1130A0</td> <td>130X2.6 CLAMP</td> <td>1</td> <td>PZ</td> </tr> <tr> <td>RC1131A0</td> <td>200X2.6 BLACK CLAMP</td> <td>1</td> <td>PZ</td> </tr> <tr> <td>RC1242A0</td> <td>D=10 CLOSED CAP</td> <td>2</td> <td>PZ</td> </tr> <tr> <td>RC1356A0</td> <td>"STRAIGHT THREADED FEMALE END 8X1/4" BS</td> <td>1</td> <td>PZ</td> </tr> <tr> <td>TB2820A0</td> <td>6X10 EPDM PIPE FOR WASHING SYSTEM</td> <td>0.790</td> <td>M</td> </tr> <tr> <td>TB3132A0</td> <td>WHITE-BLUE EPDM TEXTILE BRAID HOSE 6X12</td> <td>1.400</td> <td>M</td> </tr> </tbody> </table>	Code	Description	Qty	UOM	0H2428A0		1	PZ	EL1450A0	US SELF-CLEANING WATER SOLENOID	3	PZ	GN1312A0	RUBBER CABLE-PASSING DE=26 DI=15 SP=10	1	PZ	GN1526A0	INT. D.=6.9 TH=1.8 O-RING	7	PZ	RC1018A0	ZINC PLATED D12 ELASTIC CLAMP	3	PZ	RC1019A0	D=10 ELASTIC CLAMP	14	PZ	RC1130A0	130X2.6 CLAMP	1	PZ	RC1131A0	200X2.6 BLACK CLAMP	1	PZ	RC1242A0	D=10 CLOSED CAP	2	PZ	RC1356A0	"STRAIGHT THREADED FEMALE END 8X1/4" BS	1	PZ	TB2820A0	6X10 EPDM PIPE FOR WASHING SYSTEM	0.790	M	TB3132A0	WHITE-BLUE EPDM TEXTILE BRAID HOSE 6X12	1.400	M
Code	Description	Qty	UOM																																																			
0H2428A0		1	PZ																																																			
EL1450A0	US SELF-CLEANING WATER SOLENOID	3	PZ																																																			
GN1312A0	RUBBER CABLE-PASSING DE=26 DI=15 SP=10	1	PZ																																																			
GN1526A0	INT. D.=6.9 TH=1.8 O-RING	7	PZ																																																			
RC1018A0	ZINC PLATED D12 ELASTIC CLAMP	3	PZ																																																			
RC1019A0	D=10 ELASTIC CLAMP	14	PZ																																																			
RC1130A0	130X2.6 CLAMP	1	PZ																																																			
RC1131A0	200X2.6 BLACK CLAMP	1	PZ																																																			
RC1242A0	D=10 CLOSED CAP	2	PZ																																																			
RC1356A0	"STRAIGHT THREADED FEMALE END 8X1/4" BS	1	PZ																																																			
TB2820A0	6X10 EPDM PIPE FOR WASHING SYSTEM	0.790	M																																																			
TB3132A0	WHITE-BLUE EPDM TEXTILE BRAID HOSE 6X12	1.400	M																																																			

COMPONENT			SPARE PART																																																						
Code	Description	Image	Code	Description	Components list																																																				
VL1019A	VIBRATION PUMP		KVL1213A	US PLUS COMPACT WASHING SYSTEM KIT	<table border="1"> <thead> <tr> <th>Code</th> <th>Description</th> <th>Qty</th> <th>UOM</th> </tr> </thead> <tbody> <tr> <td>VI1220A1</td> <td>4,2X12 TCB SELF-TAPPIN G SCREW</td> <td>3</td> <td>PZ</td> </tr> <tr> <td>VL1019A0</td> <td>VIBRATION PUMP</td> <td>1</td> <td>PZ</td> </tr> <tr> <td>VL1047A1</td> <td>D6 PIPE HOLDER - D8 J.G. TERMINAL</td> <td>1</td> <td>PZ</td> </tr> <tr> <td>VL1054B0</td> <td>ONE WASHING SYS INLET DISTRIBUTOR</td> <td>1</td> <td>PZ</td> </tr> <tr> <td>VL1065A1</td> <td>1/4 MALE N.O. PRESSURE SWITCH</td> <td>1</td> <td>PZ</td> </tr> <tr> <td>VL1102A1</td> <td>DETERGENT LINE FILTER + BARBED VNR 6 MM</td> <td>1</td> <td>PZ</td> </tr> <tr> <td>VL1128A1</td> <td>D6 BARBED CHECK VALVE</td> <td>2</td> <td>PZ</td> </tr> <tr> <td>VL1165A0</td> <td>BB6-AR6 STRAIGHT FITTING</td> <td>1</td> <td>PZ</td> </tr> <tr> <td>VL1166A0</td> <td>BB6-AR6 L FITTING</td> <td>3</td> <td>PZ</td> </tr> <tr> <td>VL1174C0</td> <td>D1.2 MM CALIBRATED NOZZLE</td> <td>1</td> <td>PZ</td> </tr> <tr> <td>VL1185A0</td> <td>2 WAYS PLUS WASHING DISTRIBUTOR</td> <td>1</td> <td>PZ</td> </tr> <tr> <td>VM2172A0</td> <td>PUMP-WITH-CI RCUIT LOCKING PIN</td> <td>6</td> <td>PZ</td> </tr> </tbody> </table>	Code	Description	Qty	UOM	VI1220A1	4,2X12 TCB SELF-TAPPIN G SCREW	3	PZ	VL1019A0	VIBRATION PUMP	1	PZ	VL1047A1	D6 PIPE HOLDER - D8 J.G. TERMINAL	1	PZ	VL1054B0	ONE WASHING SYS INLET DISTRIBUTOR	1	PZ	VL1065A1	1/4 MALE N.O. PRESSURE SWITCH	1	PZ	VL1102A1	DETERGENT LINE FILTER + BARBED VNR 6 MM	1	PZ	VL1128A1	D6 BARBED CHECK VALVE	2	PZ	VL1165A0	BB6-AR6 STRAIGHT FITTING	1	PZ	VL1166A0	BB6-AR6 L FITTING	3	PZ	VL1174C0	D1.2 MM CALIBRATED NOZZLE	1	PZ	VL1185A0	2 WAYS PLUS WASHING DISTRIBUTOR	1	PZ	VM2172A0	PUMP-WITH-CI RCUIT LOCKING PIN	6	PZ
			Code	Description	Qty	UOM																																																			
VI1220A1	4,2X12 TCB SELF-TAPPIN G SCREW	3	PZ																																																						
VL1019A0	VIBRATION PUMP	1	PZ																																																						
VL1047A1	D6 PIPE HOLDER - D8 J.G. TERMINAL	1	PZ																																																						
VL1054B0	ONE WASHING SYS INLET DISTRIBUTOR	1	PZ																																																						
VL1065A1	1/4 MALE N.O. PRESSURE SWITCH	1	PZ																																																						
VL1102A1	DETERGENT LINE FILTER + BARBED VNR 6 MM	1	PZ																																																						
VL1128A1	D6 BARBED CHECK VALVE	2	PZ																																																						
VL1165A0	BB6-AR6 STRAIGHT FITTING	1	PZ																																																						
VL1166A0	BB6-AR6 L FITTING	3	PZ																																																						
VL1174C0	D1.2 MM CALIBRATED NOZZLE	1	PZ																																																						
VL1185A0	2 WAYS PLUS WASHING DISTRIBUTOR	1	PZ																																																						
VM2172A0	PUMP-WITH-CI RCUIT LOCKING PIN	6	PZ																																																						
KVL1212A	EUR COMPACT PLUS CLEANING SYSTEM KIT	<table border="1"> <thead> <tr> <th>Code</th> <th>Description</th> <th>Qty</th> <th>UOM</th> </tr> </thead> <tbody> <tr> <td>0H2428A0</td> <td></td> <td>1</td> <td>PZ</td> </tr> <tr> <td>EL1440A0</td> <td>WATER SELF CLEANING VALVE</td> <td>3</td> <td>PZ</td> </tr> <tr> <td>GN1312A0</td> <td>RUBBER CABLE-PASSI NG DE=26 DI=15 SP=10</td> <td>1</td> <td>PZ</td> </tr> <tr> <td>GN1526A0</td> <td>INT. D.=6.9 TH=1.8 O-RING</td> <td>7</td> <td>PZ</td> </tr> <tr> <td>RC1018A0</td> <td>ZINC PLATED D12 ELASTIC CLAMP</td> <td>3</td> <td>PZ</td> </tr> <tr> <td>RC1019A0</td> <td>D=10 ELASTIC CLAMP</td> <td>14</td> <td>PZ</td> </tr> <tr> <td>RC1130A0</td> <td>130X2,6 CLAM</td> <td>1</td> <td>PZ</td> </tr> <tr> <td>RC1131A0</td> <td>200X2,6 BLACK CLAMP</td> <td>1</td> <td>PZ</td> </tr> </tbody> </table>	Code	Description	Qty	UOM	0H2428A0		1	PZ	EL1440A0	WATER SELF CLEANING VALVE	3	PZ	GN1312A0	RUBBER CABLE-PASSI NG DE=26 DI=15 SP=10	1	PZ	GN1526A0	INT. D.=6.9 TH=1.8 O-RING	7	PZ	RC1018A0	ZINC PLATED D12 ELASTIC CLAMP	3	PZ	RC1019A0	D=10 ELASTIC CLAMP	14	PZ	RC1130A0	130X2,6 CLAM	1	PZ	RC1131A0	200X2,6 BLACK CLAMP	1	PZ																			
Code	Description	Qty	UOM																																																						
0H2428A0		1	PZ																																																						
EL1440A0	WATER SELF CLEANING VALVE	3	PZ																																																						
GN1312A0	RUBBER CABLE-PASSI NG DE=26 DI=15 SP=10	1	PZ																																																						
GN1526A0	INT. D.=6.9 TH=1.8 O-RING	7	PZ																																																						
RC1018A0	ZINC PLATED D12 ELASTIC CLAMP	3	PZ																																																						
RC1019A0	D=10 ELASTIC CLAMP	14	PZ																																																						
RC1130A0	130X2,6 CLAM	1	PZ																																																						
RC1131A0	200X2,6 BLACK CLAMP	1	PZ																																																						

COMPONENT			SPARE PART																																																																																					
Code	Description	Image	Code	Description	Components list																																																																																			
VL1019A	VIBRATION PUMP		KVL1212A	EUR COMPACT PLUS CLEANING SYSTEM KIT	<table border="1"> <thead> <tr> <th>Code</th> <th>Description</th> <th>Qty</th> <th>UOM</th> </tr> </thead> <tbody> <tr> <td>RC1242A0</td> <td>D=10 CLOSED CAP</td> <td>2</td> <td>PZ</td> </tr> <tr> <td>RC1356A0</td> <td>"STRAIGHT THREADED FEMALE END 8X1/4" BS</td> <td>1</td> <td>PZ</td> </tr> <tr> <td>TB2820A0</td> <td>6X10 EPDM PIPE FOR WASHING SYSTEM</td> <td>1.340</td> <td>M</td> </tr> <tr> <td>TB3132A0</td> <td>WHITE-BLUE EPDM TEXTILE BRAID HOSE 6X12</td> <td>1.400</td> <td>M</td> </tr> <tr> <td>VI1220A1</td> <td>4,2X12 TCB SELF-TAPPING SCREW</td> <td>3</td> <td>PZ</td> </tr> <tr> <td>VL1019A0</td> <td>VIBRATION PUMP</td> <td>1</td> <td>PZ</td> </tr> <tr> <td>VL1047A1</td> <td>D6 PIPE HOLDER - D8 J.G. TERMINAL</td> <td>1</td> <td>PZ</td> </tr> <tr> <td>VL1054B0</td> <td>ONE WASHING SYS INLET DISTRIBUTOR</td> <td>1</td> <td>PZ</td> </tr> <tr> <td>VL1065A1</td> <td>1/4 MALE N.O. PRESSURE SWITCH</td> <td>1</td> <td>PZ</td> </tr> <tr> <td>VL1102A1</td> <td>DETERGENT LINE FILTER + BARBED VNR 6 MM</td> <td>1</td> <td>PZ</td> </tr> <tr> <td>VL1128A1</td> <td>D6 BARBED CHECK VALVE</td> <td>2</td> <td>PZ</td> </tr> <tr> <td>VL1165A0</td> <td>BB6-AR6 STRAIGHT FITTING</td> <td>1</td> <td>PZ</td> </tr> <tr> <td>VL1166A0</td> <td>BB6-AR6 L FITTING</td> <td>3</td> <td>PZ</td> </tr> <tr> <td>VL1174C0</td> <td>D1.2 MM CALIBRATED NOZZLE</td> <td>1</td> <td>PZ</td> </tr> <tr> <td>VL1185A0</td> <td>2 WAYS PLUS WASHING DISTRIBUTOR</td> <td>1</td> <td>PZ</td> </tr> <tr> <td>VM2172A0</td> <td>PUMP-WITH-CI RCUIT LOCKING PIN</td> <td>6</td> <td>PZ</td> </tr> </tbody> </table>	Code	Description	Qty	UOM	RC1242A0	D=10 CLOSED CAP	2	PZ	RC1356A0	"STRAIGHT THREADED FEMALE END 8X1/4" BS	1	PZ	TB2820A0	6X10 EPDM PIPE FOR WASHING SYSTEM	1.340	M	TB3132A0	WHITE-BLUE EPDM TEXTILE BRAID HOSE 6X12	1.400	M	VI1220A1	4,2X12 TCB SELF-TAPPING SCREW	3	PZ	VL1019A0	VIBRATION PUMP	1	PZ	VL1047A1	D6 PIPE HOLDER - D8 J.G. TERMINAL	1	PZ	VL1054B0	ONE WASHING SYS INLET DISTRIBUTOR	1	PZ	VL1065A1	1/4 MALE N.O. PRESSURE SWITCH	1	PZ	VL1102A1	DETERGENT LINE FILTER + BARBED VNR 6 MM	1	PZ	VL1128A1	D6 BARBED CHECK VALVE	2	PZ	VL1165A0	BB6-AR6 STRAIGHT FITTING	1	PZ	VL1166A0	BB6-AR6 L FITTING	3	PZ	VL1174C0	D1.2 MM CALIBRATED NOZZLE	1	PZ	VL1185A0	2 WAYS PLUS WASHING DISTRIBUTOR	1	PZ	VM2172A0	PUMP-WITH-CI RCUIT LOCKING PIN	6	PZ	KVL1211A	ONE COMPACT AND 0523-EP WASH. SYSTEM KIT	<table border="1"> <thead> <tr> <th>Code</th> <th>Description</th> <th>Qty</th> <th>UOM</th> </tr> </thead> <tbody> <tr> <td>0H2427A0</td> <td></td> <td>1</td> <td>PZ</td> </tr> <tr> <td>EL1440A0</td> <td>WATER SELF CLEANING VALVE</td> <td>1</td> <td>PZ</td> </tr> </tbody> </table>	Code	Description	Qty	UOM	0H2427A0		1	PZ	EL1440A0	WATER SELF CLEANING VALVE	1	PZ
			Code	Description	Qty	UOM																																																																																		
RC1242A0	D=10 CLOSED CAP	2	PZ																																																																																					
RC1356A0	"STRAIGHT THREADED FEMALE END 8X1/4" BS	1	PZ																																																																																					
TB2820A0	6X10 EPDM PIPE FOR WASHING SYSTEM	1.340	M																																																																																					
TB3132A0	WHITE-BLUE EPDM TEXTILE BRAID HOSE 6X12	1.400	M																																																																																					
VI1220A1	4,2X12 TCB SELF-TAPPING SCREW	3	PZ																																																																																					
VL1019A0	VIBRATION PUMP	1	PZ																																																																																					
VL1047A1	D6 PIPE HOLDER - D8 J.G. TERMINAL	1	PZ																																																																																					
VL1054B0	ONE WASHING SYS INLET DISTRIBUTOR	1	PZ																																																																																					
VL1065A1	1/4 MALE N.O. PRESSURE SWITCH	1	PZ																																																																																					
VL1102A1	DETERGENT LINE FILTER + BARBED VNR 6 MM	1	PZ																																																																																					
VL1128A1	D6 BARBED CHECK VALVE	2	PZ																																																																																					
VL1165A0	BB6-AR6 STRAIGHT FITTING	1	PZ																																																																																					
VL1166A0	BB6-AR6 L FITTING	3	PZ																																																																																					
VL1174C0	D1.2 MM CALIBRATED NOZZLE	1	PZ																																																																																					
VL1185A0	2 WAYS PLUS WASHING DISTRIBUTOR	1	PZ																																																																																					
VM2172A0	PUMP-WITH-CI RCUIT LOCKING PIN	6	PZ																																																																																					
Code	Description	Qty	UOM																																																																																					
0H2427A0		1	PZ																																																																																					
EL1440A0	WATER SELF CLEANING VALVE	1	PZ																																																																																					

COMPONENT			SPARE PART																																																																														
Code	Description	Image	Code	Description	Components list																																																																												
VL1019A	VIBRATION PUMP		KVL1211A	ONE COMPACT AND 0523-EP WASH. SYSTEM KIT	<table border="1"> <thead> <tr> <th>Code</th> <th>Description</th> <th>Qty</th> <th>UOM</th> </tr> </thead> <tbody> <tr> <td>GN1526A0</td> <td>INT. D.=6.9 TH=1.8 O-RIN</td> <td>3</td> <td>PZ</td> </tr> <tr> <td>RC1018A0</td> <td>ZINC PLATED D12 ELASTIC CLAMP</td> <td>2</td> <td>PZ</td> </tr> <tr> <td>RC1019A0</td> <td>D=10 ELASTIC CLAMP</td> <td>14</td> <td>PZ</td> </tr> <tr> <td>RC1130A0</td> <td>130X2,6 CLAM</td> <td>1</td> <td>PZ</td> </tr> <tr> <td>RC1242A0</td> <td>D=10 CLOSED CAP</td> <td>2</td> <td>PZ</td> </tr> <tr> <td>TB2820A0</td> <td>6X10 EPDM PIPE FOR WASHING SYSTEM</td> <td>1.290</td> <td>M</td> </tr> <tr> <td>TB3132A0</td> <td>WHITE-BLUE EPDM TEXTILE BRAID HOSE 6X12</td> <td>0.670</td> <td>M</td> </tr> <tr> <td>VI1220A1</td> <td>4,2X12 TCB SELF-TAPPIN G.SCREW</td> <td>4</td> <td>PZ</td> </tr> <tr> <td>VL1019A0</td> <td>VIBRATION PUMP</td> <td>1</td> <td>PZ</td> </tr> <tr> <td>VL1047A1</td> <td>D6 PIPE HOLDER - D8 J.G. TERMINAL</td> <td>1</td> <td>PZ</td> </tr> <tr> <td>VL1054B0</td> <td>ONE WASHING SYS INLET DISTRIBUTOR</td> <td>1</td> <td>PZ</td> </tr> <tr> <td>VL1102A1</td> <td>DETERGENT LINE FILTER + BARBED VNR 6 MM</td> <td>1</td> <td>PZ</td> </tr> <tr> <td>VL1128A1</td> <td>D6 BARBED CHECK VALVE</td> <td>2</td> <td>PZ</td> </tr> <tr> <td>VL1165A0</td> <td>BB6-AR6 STRAIGHT FITTING</td> <td>1</td> <td>PZ</td> </tr> <tr> <td>VL1166A0</td> <td>BB6-AR6 L FITTING</td> <td>1</td> <td>PZ</td> </tr> <tr> <td>VL1174C0</td> <td>D1.2 MM CALIBRATED NOZZLE</td> <td>1</td> <td>PZ</td> </tr> <tr> <td>VL1191A0</td> <td>ONE WASHING DISTRIBUTOR OUTLETS KIT</td> <td>1</td> <td>PZ</td> </tr> <tr> <td>VM2172A0</td> <td>PUMP-WITH-CI RCUIT LOCKING PIN</td> <td>3</td> <td>PZ</td> </tr> </tbody> </table>	Code	Description	Qty	UOM	GN1526A0	INT. D.=6.9 TH=1.8 O-RIN	3	PZ	RC1018A0	ZINC PLATED D12 ELASTIC CLAMP	2	PZ	RC1019A0	D=10 ELASTIC CLAMP	14	PZ	RC1130A0	130X2,6 CLAM	1	PZ	RC1242A0	D=10 CLOSED CAP	2	PZ	TB2820A0	6X10 EPDM PIPE FOR WASHING SYSTEM	1.290	M	TB3132A0	WHITE-BLUE EPDM TEXTILE BRAID HOSE 6X12	0.670	M	VI1220A1	4,2X12 TCB SELF-TAPPIN G.SCREW	4	PZ	VL1019A0	VIBRATION PUMP	1	PZ	VL1047A1	D6 PIPE HOLDER - D8 J.G. TERMINAL	1	PZ	VL1054B0	ONE WASHING SYS INLET DISTRIBUTOR	1	PZ	VL1102A1	DETERGENT LINE FILTER + BARBED VNR 6 MM	1	PZ	VL1128A1	D6 BARBED CHECK VALVE	2	PZ	VL1165A0	BB6-AR6 STRAIGHT FITTING	1	PZ	VL1166A0	BB6-AR6 L FITTING	1	PZ	VL1174C0	D1.2 MM CALIBRATED NOZZLE	1	PZ	VL1191A0	ONE WASHING DISTRIBUTOR OUTLETS KIT	1	PZ	VM2172A0	PUMP-WITH-CI RCUIT LOCKING PIN	3	PZ
Code	Description	Qty	UOM																																																																														
GN1526A0	INT. D.=6.9 TH=1.8 O-RIN	3	PZ																																																																														
RC1018A0	ZINC PLATED D12 ELASTIC CLAMP	2	PZ																																																																														
RC1019A0	D=10 ELASTIC CLAMP	14	PZ																																																																														
RC1130A0	130X2,6 CLAM	1	PZ																																																																														
RC1242A0	D=10 CLOSED CAP	2	PZ																																																																														
TB2820A0	6X10 EPDM PIPE FOR WASHING SYSTEM	1.290	M																																																																														
TB3132A0	WHITE-BLUE EPDM TEXTILE BRAID HOSE 6X12	0.670	M																																																																														
VI1220A1	4,2X12 TCB SELF-TAPPIN G.SCREW	4	PZ																																																																														
VL1019A0	VIBRATION PUMP	1	PZ																																																																														
VL1047A1	D6 PIPE HOLDER - D8 J.G. TERMINAL	1	PZ																																																																														
VL1054B0	ONE WASHING SYS INLET DISTRIBUTOR	1	PZ																																																																														
VL1102A1	DETERGENT LINE FILTER + BARBED VNR 6 MM	1	PZ																																																																														
VL1128A1	D6 BARBED CHECK VALVE	2	PZ																																																																														
VL1165A0	BB6-AR6 STRAIGHT FITTING	1	PZ																																																																														
VL1166A0	BB6-AR6 L FITTING	1	PZ																																																																														
VL1174C0	D1.2 MM CALIBRATED NOZZLE	1	PZ																																																																														
VL1191A0	ONE WASHING DISTRIBUTOR OUTLETS KIT	1	PZ																																																																														
VM2172A0	PUMP-WITH-CI RCUIT LOCKING PIN	3	PZ																																																																														

COMPONENT			SPARE PART																																																																																						
Code	Description	Image	Code	Description	Components list																																																																																				
VL1019A	VIBRATION PUMP		KVL1208A	US PLUS 2 ROTOR ARMS WASHING SYSTEM KIT	<table border="1"> <thead> <tr> <th>Code</th> <th>Description</th> <th>Qty</th> <th>UOM</th> </tr> </thead> <tbody> <tr> <td>0H2354A0</td> <td>XEVC-XEVL WASHING CIRCUIT PLAT</td> <td>1</td> <td>PZ</td> </tr> <tr> <td>0H2411A0</td> <td></td> <td>1</td> <td>PZ</td> </tr> <tr> <td>EL1450A0</td> <td>US SELF-CLEANIN G WATER SOLENOID</td> <td>4</td> <td>PZ</td> </tr> <tr> <td>GN1526A0</td> <td>INT. D.=6.9 TH=1.8 O-RIN</td> <td>9</td> <td>PZ</td> </tr> <tr> <td>RC1018A0</td> <td>ZINC PLATED D12 ELASTIC CLAMP</td> <td>4</td> <td>PZ</td> </tr> <tr> <td>RC1019A0</td> <td>D=10 ELASTIC CLAMP</td> <td>16</td> <td>PZ</td> </tr> <tr> <td>RC1130A0</td> <td>130X2,6 CLAM</td> <td>1</td> <td>PZ</td> </tr> <tr> <td>RC1131A0</td> <td>200X2.6 BLACK CLAMP</td> <td>3</td> <td>PZ</td> </tr> <tr> <td>RC1242A0</td> <td>D=10 CLOSED CAP</td> <td>2</td> <td>PZ</td> </tr> <tr> <td>RC1356A0</td> <td>*STRAIGHT THREADED FEMALE END 8X1/4" BS</td> <td>1</td> <td>PZ</td> </tr> <tr> <td>TB2820A0</td> <td>6X10 EPDM PIPE FOR WASHING SYSTEM</td> <td>2.890</td> <td>M</td> </tr> <tr> <td>TB3132A0</td> <td>WHITE-BLUE EPDM TEXTILE BRAID HOSE 6X12</td> <td>1.600</td> <td>M</td> </tr> <tr> <td>VI1220A1</td> <td>4,2X12 TCB SELF-TAPPIN G SCREW</td> <td>3</td> <td>PZ</td> </tr> <tr> <td>VL1019A0</td> <td>VIBRATION PUMP</td> <td>1</td> <td>PZ</td> </tr> <tr> <td>VL1047A1</td> <td>D6 PIPE HOLDER - D8 J.G. TERMINAL</td> <td>1</td> <td>PZ</td> </tr> <tr> <td>VL1065A1</td> <td>1/4 MALE N.O. PRESSURE SWITCH</td> <td>1</td> <td>PZ</td> </tr> <tr> <td>VL1102A1</td> <td>DETERGENT LINE FILTER + BARBED VNR 6 MM</td> <td>1</td> <td>PZ</td> </tr> <tr> <td>VL1128A1</td> <td>D6 BARBED CHECK VALVE</td> <td>2</td> <td>PZ</td> </tr> <tr> <td>VL1141A1</td> <td>STRAIGHT CONNECT BB6-BB6</td> <td>1</td> <td>PZ</td> </tr> <tr> <td>VL1165A0</td> <td>BB6-AR6 STRAIGHT FITTING</td> <td>1</td> <td>PZ</td> </tr> </tbody> </table>	Code	Description	Qty	UOM	0H2354A0	XEVC-XEVL WASHING CIRCUIT PLAT	1	PZ	0H2411A0		1	PZ	EL1450A0	US SELF-CLEANIN G WATER SOLENOID	4	PZ	GN1526A0	INT. D.=6.9 TH=1.8 O-RIN	9	PZ	RC1018A0	ZINC PLATED D12 ELASTIC CLAMP	4	PZ	RC1019A0	D=10 ELASTIC CLAMP	16	PZ	RC1130A0	130X2,6 CLAM	1	PZ	RC1131A0	200X2.6 BLACK CLAMP	3	PZ	RC1242A0	D=10 CLOSED CAP	2	PZ	RC1356A0	*STRAIGHT THREADED FEMALE END 8X1/4" BS	1	PZ	TB2820A0	6X10 EPDM PIPE FOR WASHING SYSTEM	2.890	M	TB3132A0	WHITE-BLUE EPDM TEXTILE BRAID HOSE 6X12	1.600	M	VI1220A1	4,2X12 TCB SELF-TAPPIN G SCREW	3	PZ	VL1019A0	VIBRATION PUMP	1	PZ	VL1047A1	D6 PIPE HOLDER - D8 J.G. TERMINAL	1	PZ	VL1065A1	1/4 MALE N.O. PRESSURE SWITCH	1	PZ	VL1102A1	DETERGENT LINE FILTER + BARBED VNR 6 MM	1	PZ	VL1128A1	D6 BARBED CHECK VALVE	2	PZ	VL1141A1	STRAIGHT CONNECT BB6-BB6	1	PZ	VL1165A0	BB6-AR6 STRAIGHT FITTING	1	PZ
Code	Description	Qty	UOM																																																																																						
0H2354A0	XEVC-XEVL WASHING CIRCUIT PLAT	1	PZ																																																																																						
0H2411A0		1	PZ																																																																																						
EL1450A0	US SELF-CLEANIN G WATER SOLENOID	4	PZ																																																																																						
GN1526A0	INT. D.=6.9 TH=1.8 O-RIN	9	PZ																																																																																						
RC1018A0	ZINC PLATED D12 ELASTIC CLAMP	4	PZ																																																																																						
RC1019A0	D=10 ELASTIC CLAMP	16	PZ																																																																																						
RC1130A0	130X2,6 CLAM	1	PZ																																																																																						
RC1131A0	200X2.6 BLACK CLAMP	3	PZ																																																																																						
RC1242A0	D=10 CLOSED CAP	2	PZ																																																																																						
RC1356A0	*STRAIGHT THREADED FEMALE END 8X1/4" BS	1	PZ																																																																																						
TB2820A0	6X10 EPDM PIPE FOR WASHING SYSTEM	2.890	M																																																																																						
TB3132A0	WHITE-BLUE EPDM TEXTILE BRAID HOSE 6X12	1.600	M																																																																																						
VI1220A1	4,2X12 TCB SELF-TAPPIN G SCREW	3	PZ																																																																																						
VL1019A0	VIBRATION PUMP	1	PZ																																																																																						
VL1047A1	D6 PIPE HOLDER - D8 J.G. TERMINAL	1	PZ																																																																																						
VL1065A1	1/4 MALE N.O. PRESSURE SWITCH	1	PZ																																																																																						
VL1102A1	DETERGENT LINE FILTER + BARBED VNR 6 MM	1	PZ																																																																																						
VL1128A1	D6 BARBED CHECK VALVE	2	PZ																																																																																						
VL1141A1	STRAIGHT CONNECT BB6-BB6	1	PZ																																																																																						
VL1165A0	BB6-AR6 STRAIGHT FITTING	1	PZ																																																																																						





COMPONENT			SPARE PART																																																							
Code	Description	Image	Code	Description	Components list																																																					
VL1019A	VIBRATION PUMP		KVL1208A	US PLUS 2 ROTOR ARMS WASHING SYSTEM KIT	<table border="1"> <thead> <tr> <th>Code</th> <th>Description</th> <th>Qty</th> <th>UOM</th> </tr> </thead> <tbody> <tr> <td>VL1166A0</td> <td>BB6-AR6 L FITTING</td> <td>4</td> <td>PZ</td> </tr> <tr> <td>VL1174C0</td> <td>D1.2 MM CALIBRATED NOZZLE</td> <td>1</td> <td>PZ</td> </tr> <tr> <td>VL1186A0</td> <td>3 WAYS PLUS WASHING DISTRIBUTOR</td> <td>1</td> <td>PZ</td> </tr> <tr> <td>VL1190A0</td> <td>PLUS WASHING SYSTEM INLET DISTRIBUTOR</td> <td>1</td> <td>PZ</td> </tr> <tr> <td>VM1605A0</td> <td>CLIP TWIST LOCK DIAM. 10,2-12,7 MM</td> <td>6</td> <td>PZ</td> </tr> <tr> <td>VM2172A0</td> <td>PUMP-WITH-CI RCUIT LOCKING PIN</td> <td>9</td> <td>PZ</td> </tr> </tbody> </table>	Code	Description	Qty	UOM	VL1166A0	BB6-AR6 L FITTING	4	PZ	VL1174C0	D1.2 MM CALIBRATED NOZZLE	1	PZ	VL1186A0	3 WAYS PLUS WASHING DISTRIBUTOR	1	PZ	VL1190A0	PLUS WASHING SYSTEM INLET DISTRIBUTOR	1	PZ	VM1605A0	CLIP TWIST LOCK DIAM. 10,2-12,7 MM	6	PZ	VM2172A0	PUMP-WITH-CI RCUIT LOCKING PIN	9	PZ																									
			Code	Description	Qty	UOM																																																				
VL1166A0	BB6-AR6 L FITTING	4	PZ																																																							
VL1174C0	D1.2 MM CALIBRATED NOZZLE	1	PZ																																																							
VL1186A0	3 WAYS PLUS WASHING DISTRIBUTOR	1	PZ																																																							
VL1190A0	PLUS WASHING SYSTEM INLET DISTRIBUTOR	1	PZ																																																							
VM1605A0	CLIP TWIST LOCK DIAM. 10,2-12,7 MM	6	PZ																																																							
VM2172A0	PUMP-WITH-CI RCUIT LOCKING PIN	9	PZ																																																							
KVL1207A	US PLUS 1 ROTOR ARM WASHING SYSTEM KIT	<table border="1"> <thead> <tr> <th>Code</th> <th>Description</th> <th>Qty</th> <th>UOM</th> </tr> </thead> <tbody> <tr> <td>0H2354A0</td> <td>XEVC-XEVL WASHING CIRCUIT PLAT</td> <td>1</td> <td>PZ</td> </tr> <tr> <td>0H2411A0</td> <td></td> <td>1</td> <td>PZ</td> </tr> <tr> <td>EL1450A0</td> <td>US SELF-CLEANIN G WATER SOLENOID</td> <td>3</td> <td>PZ</td> </tr> <tr> <td>GN1526A0</td> <td>INT. D.=6.9 TH=1.8 O-RIN</td> <td>7</td> <td>PZ</td> </tr> <tr> <td>RC1018A0</td> <td>ZINC PLATED D12 ELASTIC CLAMP</td> <td>3</td> <td>PZ</td> </tr> <tr> <td>RC1019A0</td> <td>D=10 ELASTIC CLAMP</td> <td>14</td> <td>PZ</td> </tr> <tr> <td>RC1130A0</td> <td>130X2,6 CLAM</td> <td>1</td> <td>PZ</td> </tr> <tr> <td>RC1131A0</td> <td>200X2.6 BLACK CLAMP</td> <td>2</td> <td>PZ</td> </tr> <tr> <td>RC1242A0</td> <td>D=10 CLOSED CAP</td> <td>2</td> <td>PZ</td> </tr> <tr> <td>RC1356A0</td> <td>"STRAIGHT THREADED FEMALE END 8X1/4" BS</td> <td>1</td> <td>PZ</td> </tr> <tr> <td>TB2820A0</td> <td>6X10 EPDM PIPE FOR WASHING SYSTEM</td> <td>1.460</td> <td>M</td> </tr> <tr> <td>TB3132A0</td> <td>WHITE-BLUE EPDM TEXTILE BRAID HOSE 6X12</td> <td>0.770</td> <td>M</td> </tr> <tr> <td>VI1220A1</td> <td>4,2X12 TCB SELF-TAPPIN G SCREW</td> <td>3</td> <td>PZ</td> </tr> </tbody> </table>	Code	Description	Qty	UOM	0H2354A0	XEVC-XEVL WASHING CIRCUIT PLAT	1	PZ	0H2411A0		1	PZ	EL1450A0	US SELF-CLEANIN G WATER SOLENOID	3	PZ	GN1526A0	INT. D.=6.9 TH=1.8 O-RIN	7	PZ	RC1018A0	ZINC PLATED D12 ELASTIC CLAMP	3	PZ	RC1019A0	D=10 ELASTIC CLAMP	14	PZ	RC1130A0	130X2,6 CLAM	1	PZ	RC1131A0	200X2.6 BLACK CLAMP	2	PZ	RC1242A0	D=10 CLOSED CAP	2	PZ	RC1356A0	"STRAIGHT THREADED FEMALE END 8X1/4" BS	1	PZ	TB2820A0	6X10 EPDM PIPE FOR WASHING SYSTEM	1.460	M	TB3132A0	WHITE-BLUE EPDM TEXTILE BRAID HOSE 6X12	0.770	M	VI1220A1	4,2X12 TCB SELF-TAPPIN G SCREW	3	PZ
Code	Description	Qty	UOM																																																							
0H2354A0	XEVC-XEVL WASHING CIRCUIT PLAT	1	PZ																																																							
0H2411A0		1	PZ																																																							
EL1450A0	US SELF-CLEANIN G WATER SOLENOID	3	PZ																																																							
GN1526A0	INT. D.=6.9 TH=1.8 O-RIN	7	PZ																																																							
RC1018A0	ZINC PLATED D12 ELASTIC CLAMP	3	PZ																																																							
RC1019A0	D=10 ELASTIC CLAMP	14	PZ																																																							
RC1130A0	130X2,6 CLAM	1	PZ																																																							
RC1131A0	200X2.6 BLACK CLAMP	2	PZ																																																							
RC1242A0	D=10 CLOSED CAP	2	PZ																																																							
RC1356A0	"STRAIGHT THREADED FEMALE END 8X1/4" BS	1	PZ																																																							
TB2820A0	6X10 EPDM PIPE FOR WASHING SYSTEM	1.460	M																																																							
TB3132A0	WHITE-BLUE EPDM TEXTILE BRAID HOSE 6X12	0.770	M																																																							
VI1220A1	4,2X12 TCB SELF-TAPPIN G SCREW	3	PZ																																																							

COMPONENT			SPARE PART																																																																																									
Code	Description	Image	Code	Description	Components list																																																																																							
VL1019A	VIBRATION PUMP		KVL1207A	US PLUS 1 ROTOR ARM WASHING SYSTEM KIT	<table border="1"> <thead> <tr> <th>Code</th> <th>Description</th> <th>Qty</th> <th>UOM</th> </tr> </thead> <tbody> <tr> <td>VL1019A0</td> <td>VIBRATION PUMP</td> <td>1</td> <td>PZ</td> </tr> <tr> <td>VL1047A1</td> <td>D6 PIPE HOLDER - D8 J.G. TERMINAL</td> <td>1</td> <td>PZ</td> </tr> <tr> <td>VL1065A1</td> <td>1/4 MALE N.O. PRESSURE SWITCH</td> <td>1</td> <td>PZ</td> </tr> <tr> <td>VL1102A1</td> <td>DETERGENT LINE FILTER + BARBED VNR 6 MM</td> <td>1</td> <td>PZ</td> </tr> <tr> <td>VL1128A1</td> <td>D6 BARBED CHECK VALVE</td> <td>2</td> <td>PZ</td> </tr> <tr> <td>VL1165A0</td> <td>BB6-AR6 STRAIGHT FITTING</td> <td>1</td> <td>PZ</td> </tr> <tr> <td>VL1166A0</td> <td>BB6-AR6 L FITTING</td> <td>3</td> <td>PZ</td> </tr> <tr> <td>VL1174C0</td> <td>D1.2 MM CALIBRATED NOZZLE</td> <td>1</td> <td>PZ</td> </tr> <tr> <td>VL1185A0</td> <td>2 WAYS PLUS WASHING DISTRIBUTOR</td> <td>1</td> <td>PZ</td> </tr> <tr> <td>VL1190A0</td> <td>PLUS WASHING SYSTEM INLET DISTRIBUTOR</td> <td>1</td> <td>PZ</td> </tr> <tr> <td>VM1605A0</td> <td>CLIP TWIST LOCK DIAM. 10.2-12.7 MM</td> <td>6</td> <td>PZ</td> </tr> <tr> <td>VM2172A0</td> <td>PUMP-WITH-CI RCUIT LOCKING PIN</td> <td>6</td> <td>PZ</td> </tr> </tbody> </table>	Code	Description	Qty	UOM	VL1019A0	VIBRATION PUMP	1	PZ	VL1047A1	D6 PIPE HOLDER - D8 J.G. TERMINAL	1	PZ	VL1065A1	1/4 MALE N.O. PRESSURE SWITCH	1	PZ	VL1102A1	DETERGENT LINE FILTER + BARBED VNR 6 MM	1	PZ	VL1128A1	D6 BARBED CHECK VALVE	2	PZ	VL1165A0	BB6-AR6 STRAIGHT FITTING	1	PZ	VL1166A0	BB6-AR6 L FITTING	3	PZ	VL1174C0	D1.2 MM CALIBRATED NOZZLE	1	PZ	VL1185A0	2 WAYS PLUS WASHING DISTRIBUTOR	1	PZ	VL1190A0	PLUS WASHING SYSTEM INLET DISTRIBUTOR	1	PZ	VM1605A0	CLIP TWIST LOCK DIAM. 10.2-12.7 MM	6	PZ	VM2172A0	PUMP-WITH-CI RCUIT LOCKING PIN	6	PZ	KVL1198A	MM EU HOOD CLEANING SYSTEM KIT	<table border="1"> <thead> <tr> <th>Code</th> <th>Description</th> <th>Qty</th> <th>UOM</th> </tr> </thead> <tbody> <tr> <td>0H2213A1</td> <td></td> <td>1</td> <td>PZ</td> </tr> <tr> <td>EL1440A0</td> <td>WATER SELF CLEANING VALVE</td> <td>2</td> <td>PZ</td> </tr> <tr> <td>GN1526A0</td> <td>INT. D.=6.9 TH=1.8 O-RIN</td> <td>5</td> <td>PZ</td> </tr> <tr> <td>RC1018A0</td> <td>ZINC PLATED D12 ELASTIC CLAMP</td> <td>6</td> <td>PZ</td> </tr> <tr> <td>RC1019A0</td> <td>D=10 ELASTIC CLAMP</td> <td>16</td> <td>PZ</td> </tr> <tr> <td>RC1131A0</td> <td>200X2.6 BLACK CLAMP</td> <td>1</td> <td>PZ</td> </tr> <tr> <td>RC1242A0</td> <td>D=10 CLOSED CAP</td> <td>2</td> <td>PZ</td> </tr> </tbody> </table>	Code	Description	Qty	UOM	0H2213A1		1	PZ	EL1440A0	WATER SELF CLEANING VALVE	2	PZ	GN1526A0	INT. D.=6.9 TH=1.8 O-RIN	5	PZ	RC1018A0	ZINC PLATED D12 ELASTIC CLAMP	6	PZ	RC1019A0	D=10 ELASTIC CLAMP	16	PZ	RC1131A0	200X2.6 BLACK CLAMP	1	PZ	RC1242A0	D=10 CLOSED CAP	2	PZ
					Code	Description	Qty	UOM																																																																																				
VL1019A0	VIBRATION PUMP	1			PZ																																																																																							
VL1047A1	D6 PIPE HOLDER - D8 J.G. TERMINAL	1			PZ																																																																																							
VL1065A1	1/4 MALE N.O. PRESSURE SWITCH	1			PZ																																																																																							
VL1102A1	DETERGENT LINE FILTER + BARBED VNR 6 MM	1			PZ																																																																																							
VL1128A1	D6 BARBED CHECK VALVE	2			PZ																																																																																							
VL1165A0	BB6-AR6 STRAIGHT FITTING	1			PZ																																																																																							
VL1166A0	BB6-AR6 L FITTING	3			PZ																																																																																							
VL1174C0	D1.2 MM CALIBRATED NOZZLE	1			PZ																																																																																							
VL1185A0	2 WAYS PLUS WASHING DISTRIBUTOR	1			PZ																																																																																							
VL1190A0	PLUS WASHING SYSTEM INLET DISTRIBUTOR	1			PZ																																																																																							
VM1605A0	CLIP TWIST LOCK DIAM. 10.2-12.7 MM	6			PZ																																																																																							
VM2172A0	PUMP-WITH-CI RCUIT LOCKING PIN	6			PZ																																																																																							
KVL1198A	MM EU HOOD CLEANING SYSTEM KIT	<table border="1"> <thead> <tr> <th>Code</th> <th>Description</th> <th>Qty</th> <th>UOM</th> </tr> </thead> <tbody> <tr> <td>0H2213A1</td> <td></td> <td>1</td> <td>PZ</td> </tr> <tr> <td>EL1440A0</td> <td>WATER SELF CLEANING VALVE</td> <td>2</td> <td>PZ</td> </tr> <tr> <td>GN1526A0</td> <td>INT. D.=6.9 TH=1.8 O-RIN</td> <td>5</td> <td>PZ</td> </tr> <tr> <td>RC1018A0</td> <td>ZINC PLATED D12 ELASTIC CLAMP</td> <td>6</td> <td>PZ</td> </tr> <tr> <td>RC1019A0</td> <td>D=10 ELASTIC CLAMP</td> <td>16</td> <td>PZ</td> </tr> <tr> <td>RC1131A0</td> <td>200X2.6 BLACK CLAMP</td> <td>1</td> <td>PZ</td> </tr> <tr> <td>RC1242A0</td> <td>D=10 CLOSED CAP</td> <td>2</td> <td>PZ</td> </tr> </tbody> </table>			Code	Description	Qty	UOM	0H2213A1		1	PZ	EL1440A0	WATER SELF CLEANING VALVE	2	PZ	GN1526A0	INT. D.=6.9 TH=1.8 O-RIN	5	PZ	RC1018A0	ZINC PLATED D12 ELASTIC CLAMP	6	PZ	RC1019A0	D=10 ELASTIC CLAMP	16	PZ	RC1131A0	200X2.6 BLACK CLAMP	1	PZ	RC1242A0	D=10 CLOSED CAP	2	PZ																																																								
		Code			Description	Qty	UOM																																																																																					
		0H2213A1				1	PZ																																																																																					
		EL1440A0	WATER SELF CLEANING VALVE	2	PZ																																																																																							
		GN1526A0	INT. D.=6.9 TH=1.8 O-RIN	5	PZ																																																																																							
		RC1018A0	ZINC PLATED D12 ELASTIC CLAMP	6	PZ																																																																																							
		RC1019A0	D=10 ELASTIC CLAMP	16	PZ																																																																																							
		RC1131A0	200X2.6 BLACK CLAMP	1	PZ																																																																																							
		RC1242A0	D=10 CLOSED CAP	2	PZ																																																																																							

COMPONENT			SPARE PART																																																																																	
Code	Description	Image	Code	Description	Components list																																																																															
VL1019A	VIBRATION PUMP		KVL1198A	MM EU HOOD CLEANING SYSTEM KIT	<table border="1"> <thead> <tr> <th>Code</th> <th>Description</th> <th>Qty</th> <th>UOM</th> </tr> </thead> <tbody> <tr> <td>TB2820A0</td> <td>6X10 EPDM PIPE FOR WASHING SYSTEM</td> <td>2.240</td> <td>M</td> </tr> <tr> <td>TB3132A0</td> <td>WHITE-BLUE EPDM TEXTILE BRAID HOSE 6X12</td> <td>0.440</td> <td>M</td> </tr> <tr> <td>VI1220A1</td> <td>4,2X12 TCB SELF-TAPPIN G SCREW</td> <td>3</td> <td>PZ</td> </tr> <tr> <td>VL1019A0</td> <td>VIBRATION PUMP</td> <td>1</td> <td>PZ</td> </tr> <tr> <td>VL1047A1</td> <td>D6 PIPE HOLDER - D8 J.G. TERMINAL</td> <td>2</td> <td>PZ</td> </tr> <tr> <td>VL1054B0</td> <td>ONE WASHING SYS INLET DISTRIBUTOR</td> <td>1</td> <td>PZ</td> </tr> <tr> <td>VL1102A1</td> <td>DETERGENT LINE FILTER + BARBED VNR 6 MM</td> <td>1</td> <td>PZ</td> </tr> <tr> <td>VL1127A1</td> <td>6MM BARBED T-SHAPED FITTING</td> <td>1</td> <td>PZ</td> </tr> <tr> <td>VL1128A1</td> <td>D6 BARBED CHECK VALVE</td> <td>2</td> <td>PZ</td> </tr> <tr> <td>VL1165A0</td> <td>BB6-AR6 STRAIGHT FITTING</td> <td>2</td> <td>PZ</td> </tr> <tr> <td>VL1166A0</td> <td>BB6-AR6 L FITTING</td> <td>2</td> <td>PZ</td> </tr> <tr> <td>VL1174C0</td> <td>D1.2 MM CALIBRATED NOZZLE</td> <td>1</td> <td>PZ</td> </tr> <tr> <td>VL1191A0</td> <td>ONE WASHING DISTRIBUTOR OUTLETS KIT</td> <td>1</td> <td>PZ</td> </tr> <tr> <td>VM1605A0</td> <td>CLIP TWIST LOCK DIAM. 10,2-12,7 MM</td> <td>4</td> <td>PZ</td> </tr> <tr> <td>VM2172A0</td> <td>PUMP-WITH-CI RCUIT LOCKING PIN</td> <td>5</td> <td>PZ</td> </tr> </tbody> </table>	Code	Description	Qty	UOM	TB2820A0	6X10 EPDM PIPE FOR WASHING SYSTEM	2.240	M	TB3132A0	WHITE-BLUE EPDM TEXTILE BRAID HOSE 6X12	0.440	M	VI1220A1	4,2X12 TCB SELF-TAPPIN G SCREW	3	PZ	VL1019A0	VIBRATION PUMP	1	PZ	VL1047A1	D6 PIPE HOLDER - D8 J.G. TERMINAL	2	PZ	VL1054B0	ONE WASHING SYS INLET DISTRIBUTOR	1	PZ	VL1102A1	DETERGENT LINE FILTER + BARBED VNR 6 MM	1	PZ	VL1127A1	6MM BARBED T-SHAPED FITTING	1	PZ	VL1128A1	D6 BARBED CHECK VALVE	2	PZ	VL1165A0	BB6-AR6 STRAIGHT FITTING	2	PZ	VL1166A0	BB6-AR6 L FITTING	2	PZ	VL1174C0	D1.2 MM CALIBRATED NOZZLE	1	PZ	VL1191A0	ONE WASHING DISTRIBUTOR OUTLETS KIT	1	PZ	VM1605A0	CLIP TWIST LOCK DIAM. 10,2-12,7 MM	4	PZ	VM2172A0	PUMP-WITH-CI RCUIT LOCKING PIN	5	PZ	KVL1187A	3 ROTOR ARMS PLUS EU CLEANING SYSTEM KIT	<table border="1"> <thead> <tr> <th>Code</th> <th>Description</th> <th>Qty</th> <th>UOM</th> </tr> </thead> <tbody> <tr> <td>0H2143A0</td> <td>LAMIERA BLOCCA VNR VL1128</td> <td>3</td> <td>PZ</td> </tr> <tr> <td>0H2168A0</td> <td></td> <td>1</td> <td>PZ</td> </tr> </tbody> </table>	Code	Description	Qty	UOM	0H2143A0	LAMIERA BLOCCA VNR VL1128	3	PZ	0H2168A0		1	PZ
			Code	Description	Qty	UOM																																																																														
TB2820A0	6X10 EPDM PIPE FOR WASHING SYSTEM	2.240	M																																																																																	
TB3132A0	WHITE-BLUE EPDM TEXTILE BRAID HOSE 6X12	0.440	M																																																																																	
VI1220A1	4,2X12 TCB SELF-TAPPIN G SCREW	3	PZ																																																																																	
VL1019A0	VIBRATION PUMP	1	PZ																																																																																	
VL1047A1	D6 PIPE HOLDER - D8 J.G. TERMINAL	2	PZ																																																																																	
VL1054B0	ONE WASHING SYS INLET DISTRIBUTOR	1	PZ																																																																																	
VL1102A1	DETERGENT LINE FILTER + BARBED VNR 6 MM	1	PZ																																																																																	
VL1127A1	6MM BARBED T-SHAPED FITTING	1	PZ																																																																																	
VL1128A1	D6 BARBED CHECK VALVE	2	PZ																																																																																	
VL1165A0	BB6-AR6 STRAIGHT FITTING	2	PZ																																																																																	
VL1166A0	BB6-AR6 L FITTING	2	PZ																																																																																	
VL1174C0	D1.2 MM CALIBRATED NOZZLE	1	PZ																																																																																	
VL1191A0	ONE WASHING DISTRIBUTOR OUTLETS KIT	1	PZ																																																																																	
VM1605A0	CLIP TWIST LOCK DIAM. 10,2-12,7 MM	4	PZ																																																																																	
VM2172A0	PUMP-WITH-CI RCUIT LOCKING PIN	5	PZ																																																																																	
Code	Description	Qty	UOM																																																																																	
0H2143A0	LAMIERA BLOCCA VNR VL1128	3	PZ																																																																																	
0H2168A0		1	PZ																																																																																	

COMPONENT			SPARE PART																																																																																		
Code	Description	Image	Code	Description	Components list																																																																																
VL1019A	VIBRATION PUMP		KVL1187A	3 ROTOR ARMS PLUS EU CLEANING SYSTEM KIT	<table border="1"> <thead> <tr> <th>Code</th> <th>Description</th> <th>Qty</th> <th>UOM</th> </tr> </thead> <tbody> <tr> <td>0H2354A0</td> <td>XEVC-XEVL WASHING CIRCUIT PLAT</td> <td>1</td> <td>PZ</td> </tr> <tr> <td>EL1120A0</td> <td>D8-D6 FEMALE STRAIGHT INTERM. CONNECTION</td> <td>1</td> <td>PZ</td> </tr> <tr> <td>EL1220A0</td> <td>JG STRAIGHT CONNECTION Ø8F-Ø8F</td> <td>2</td> <td>PZ</td> </tr> <tr> <td>EL1440A0</td> <td>WATER SELF CLEANING VALVE</td> <td>4</td> <td>PZ</td> </tr> <tr> <td>GN1526A0</td> <td>INT. D.=6.9 TH=1.8 O-RIN</td> <td>9</td> <td>PZ</td> </tr> <tr> <td>RC1018A0</td> <td>ZINC PLATED D12 ELASTIC CLAMP</td> <td>10</td> <td>PZ</td> </tr> <tr> <td>RC1019A0</td> <td>D=10 ELASTIC CLAMP</td> <td>22</td> <td>PZ</td> </tr> <tr> <td>RC1130A0</td> <td>130X2,6 CLAM</td> <td>4</td> <td>PZ</td> </tr> <tr> <td>RC1131A0</td> <td>200X2.6 BLACK CLAMP</td> <td>3</td> <td>PZ</td> </tr> <tr> <td>RC1242A0</td> <td>D=10 CLOSED CAP</td> <td>2</td> <td>PZ</td> </tr> <tr> <td>RC1310A0</td> <td>140X4 CLAMP WITH CLIP</td> <td>1</td> <td>PZ</td> </tr> <tr> <td>RC1356A0</td> <td>"STRAIGHT THREADED FEMALE END 8X1/4" BS</td> <td>1</td> <td>PZ</td> </tr> <tr> <td>TB2820A0</td> <td>6X10 EPDM PIPE FOR WASHING SYSTEM</td> <td>1.510</td> <td>M</td> </tr> <tr> <td>TB3132A0</td> <td>WHITE-BLUE EPDM TEXTILE BRAID HOSE 6X12</td> <td>1.210</td> <td>M</td> </tr> <tr> <td>VI1220A1</td> <td>4,2X12 TCB SELF-TAPPIN G SCREW</td> <td>3</td> <td>PZ</td> </tr> <tr> <td>VL1019A0</td> <td>VIBRATION PUMP</td> <td>1</td> <td>PZ</td> </tr> <tr> <td>VL1046A1</td> <td>D6 PIPE HOLDER - D6 J.G. TERMINAL</td> <td>3</td> <td>PZ</td> </tr> <tr> <td>VL1047A1</td> <td>D6 PIPE HOLDER - D8 J.G. TERMINAL</td> <td>1</td> <td>PZ</td> </tr> <tr> <td>VL1064A0</td> <td>WASHING SYSTEM OUTLETS DISTRIBUTOR</td> <td>1</td> <td>PZ</td> </tr> </tbody> </table>	Code	Description	Qty	UOM	0H2354A0	XEVC-XEVL WASHING CIRCUIT PLAT	1	PZ	EL1120A0	D8-D6 FEMALE STRAIGHT INTERM. CONNECTION	1	PZ	EL1220A0	JG STRAIGHT CONNECTION Ø8F-Ø8F	2	PZ	EL1440A0	WATER SELF CLEANING VALVE	4	PZ	GN1526A0	INT. D.=6.9 TH=1.8 O-RIN	9	PZ	RC1018A0	ZINC PLATED D12 ELASTIC CLAMP	10	PZ	RC1019A0	D=10 ELASTIC CLAMP	22	PZ	RC1130A0	130X2,6 CLAM	4	PZ	RC1131A0	200X2.6 BLACK CLAMP	3	PZ	RC1242A0	D=10 CLOSED CAP	2	PZ	RC1310A0	140X4 CLAMP WITH CLIP	1	PZ	RC1356A0	"STRAIGHT THREADED FEMALE END 8X1/4" BS	1	PZ	TB2820A0	6X10 EPDM PIPE FOR WASHING SYSTEM	1.510	M	TB3132A0	WHITE-BLUE EPDM TEXTILE BRAID HOSE 6X12	1.210	M	VI1220A1	4,2X12 TCB SELF-TAPPIN G SCREW	3	PZ	VL1019A0	VIBRATION PUMP	1	PZ	VL1046A1	D6 PIPE HOLDER - D6 J.G. TERMINAL	3	PZ	VL1047A1	D6 PIPE HOLDER - D8 J.G. TERMINAL	1	PZ	VL1064A0	WASHING SYSTEM OUTLETS DISTRIBUTOR	1	PZ
Code	Description	Qty	UOM																																																																																		
0H2354A0	XEVC-XEVL WASHING CIRCUIT PLAT	1	PZ																																																																																		
EL1120A0	D8-D6 FEMALE STRAIGHT INTERM. CONNECTION	1	PZ																																																																																		
EL1220A0	JG STRAIGHT CONNECTION Ø8F-Ø8F	2	PZ																																																																																		
EL1440A0	WATER SELF CLEANING VALVE	4	PZ																																																																																		
GN1526A0	INT. D.=6.9 TH=1.8 O-RIN	9	PZ																																																																																		
RC1018A0	ZINC PLATED D12 ELASTIC CLAMP	10	PZ																																																																																		
RC1019A0	D=10 ELASTIC CLAMP	22	PZ																																																																																		
RC1130A0	130X2,6 CLAM	4	PZ																																																																																		
RC1131A0	200X2.6 BLACK CLAMP	3	PZ																																																																																		
RC1242A0	D=10 CLOSED CAP	2	PZ																																																																																		
RC1310A0	140X4 CLAMP WITH CLIP	1	PZ																																																																																		
RC1356A0	"STRAIGHT THREADED FEMALE END 8X1/4" BS	1	PZ																																																																																		
TB2820A0	6X10 EPDM PIPE FOR WASHING SYSTEM	1.510	M																																																																																		
TB3132A0	WHITE-BLUE EPDM TEXTILE BRAID HOSE 6X12	1.210	M																																																																																		
VI1220A1	4,2X12 TCB SELF-TAPPIN G SCREW	3	PZ																																																																																		
VL1019A0	VIBRATION PUMP	1	PZ																																																																																		
VL1046A1	D6 PIPE HOLDER - D6 J.G. TERMINAL	3	PZ																																																																																		
VL1047A1	D6 PIPE HOLDER - D8 J.G. TERMINAL	1	PZ																																																																																		
VL1064A0	WASHING SYSTEM OUTLETS DISTRIBUTOR	1	PZ																																																																																		

COMPONENT			SPARE PART																																																																														
Code	Description	Image	Code	Description	Components list																																																																												
VL1019A	VIBRATION PUMP		KVL1187A	3 ROTOR ARMS PLUS EU CLEANING SYSTEM KIT	<table border="1"> <thead> <tr> <th>Code</th> <th>Description</th> <th>Qty</th> <th>UOM</th> </tr> </thead> <tbody> <tr> <td>VL1065A1</td> <td>1/4 MALE N.O. PRESSURE SWITCH</td> <td>1</td> <td>PZ</td> </tr> <tr> <td>VL1067A0</td> <td>WASHING SYSTEM INLETS DISTRIBUTOR</td> <td>1</td> <td>PZ</td> </tr> <tr> <td>VL1092A0</td> <td>WASHING SYSTEM OUTLET DOUBLE DISTRIBUTOR</td> <td>1</td> <td>PZ</td> </tr> <tr> <td>VL1102A1</td> <td>DETERGENT LINE FILTER + BARBED VNR 6 MM</td> <td>1</td> <td>PZ</td> </tr> <tr> <td>VL1127A1</td> <td>6MM BARBED T-SHAPED FITTING</td> <td>2</td> <td>PZ</td> </tr> <tr> <td>VL1128A0</td> <td>D6 BARBED CHECK VALVE</td> <td>3</td> <td>PZ</td> </tr> <tr> <td>VL1128A1</td> <td>D6 BARBED CHECK VALVE</td> <td>3</td> <td>PZ</td> </tr> <tr> <td>VL1165A0</td> <td>BB6-AR6 STRAIGHT FITTING</td> <td>4</td> <td>PZ</td> </tr> <tr> <td>VL1166A0</td> <td>BB6-AR6 L FITTING</td> <td>4</td> <td>PZ</td> </tr> <tr> <td>VL1167A0</td> <td></td> <td>1</td> <td>PZ</td> </tr> <tr> <td>VL1167A1</td> <td></td> <td>1</td> <td>PZ</td> </tr> <tr> <td>VL1167A2</td> <td>GN21 3 ROTOR ARMS B-B FLOW RESTRICTOR</td> <td>1</td> <td>PZ</td> </tr> <tr> <td>VL1174C0</td> <td>D1.2 MM CALIBRATED NOZZLE</td> <td>1</td> <td>PZ</td> </tr> <tr> <td>VL1185A0</td> <td>2 WAYS PLUS WASHING DISTRIBUTOR</td> <td>1</td> <td>PZ</td> </tr> <tr> <td>VL1186A0</td> <td>3 WAYS PLUS WASHING DISTRIBUTOR</td> <td>1</td> <td>PZ</td> </tr> <tr> <td>VL1190A0</td> <td>PLUS WASHING SYSTEM INLET DISTRIBUTOR</td> <td>1</td> <td>PZ</td> </tr> <tr> <td>VM1605A0</td> <td>CLIP TWIST LOCK DIAM. 10,2-12,7 MM</td> <td>3</td> <td>PZ</td> </tr> <tr> <td>VM2172A0</td> <td>PUMP-WITH-CI RCUIT LOCKING PIN</td> <td>9</td> <td>PZ</td> </tr> </tbody> </table>	Code	Description	Qty	UOM	VL1065A1	1/4 MALE N.O. PRESSURE SWITCH	1	PZ	VL1067A0	WASHING SYSTEM INLETS DISTRIBUTOR	1	PZ	VL1092A0	WASHING SYSTEM OUTLET DOUBLE DISTRIBUTOR	1	PZ	VL1102A1	DETERGENT LINE FILTER + BARBED VNR 6 MM	1	PZ	VL1127A1	6MM BARBED T-SHAPED FITTING	2	PZ	VL1128A0	D6 BARBED CHECK VALVE	3	PZ	VL1128A1	D6 BARBED CHECK VALVE	3	PZ	VL1165A0	BB6-AR6 STRAIGHT FITTING	4	PZ	VL1166A0	BB6-AR6 L FITTING	4	PZ	VL1167A0		1	PZ	VL1167A1		1	PZ	VL1167A2	GN21 3 ROTOR ARMS B-B FLOW RESTRICTOR	1	PZ	VL1174C0	D1.2 MM CALIBRATED NOZZLE	1	PZ	VL1185A0	2 WAYS PLUS WASHING DISTRIBUTOR	1	PZ	VL1186A0	3 WAYS PLUS WASHING DISTRIBUTOR	1	PZ	VL1190A0	PLUS WASHING SYSTEM INLET DISTRIBUTOR	1	PZ	VM1605A0	CLIP TWIST LOCK DIAM. 10,2-12,7 MM	3	PZ	VM2172A0	PUMP-WITH-CI RCUIT LOCKING PIN	9	PZ
Code	Description	Qty	UOM																																																																														
VL1065A1	1/4 MALE N.O. PRESSURE SWITCH	1	PZ																																																																														
VL1067A0	WASHING SYSTEM INLETS DISTRIBUTOR	1	PZ																																																																														
VL1092A0	WASHING SYSTEM OUTLET DOUBLE DISTRIBUTOR	1	PZ																																																																														
VL1102A1	DETERGENT LINE FILTER + BARBED VNR 6 MM	1	PZ																																																																														
VL1127A1	6MM BARBED T-SHAPED FITTING	2	PZ																																																																														
VL1128A0	D6 BARBED CHECK VALVE	3	PZ																																																																														
VL1128A1	D6 BARBED CHECK VALVE	3	PZ																																																																														
VL1165A0	BB6-AR6 STRAIGHT FITTING	4	PZ																																																																														
VL1166A0	BB6-AR6 L FITTING	4	PZ																																																																														
VL1167A0		1	PZ																																																																														
VL1167A1		1	PZ																																																																														
VL1167A2	GN21 3 ROTOR ARMS B-B FLOW RESTRICTOR	1	PZ																																																																														
VL1174C0	D1.2 MM CALIBRATED NOZZLE	1	PZ																																																																														
VL1185A0	2 WAYS PLUS WASHING DISTRIBUTOR	1	PZ																																																																														
VL1186A0	3 WAYS PLUS WASHING DISTRIBUTOR	1	PZ																																																																														
VL1190A0	PLUS WASHING SYSTEM INLET DISTRIBUTOR	1	PZ																																																																														
VM1605A0	CLIP TWIST LOCK DIAM. 10,2-12,7 MM	3	PZ																																																																														
VM2172A0	PUMP-WITH-CI RCUIT LOCKING PIN	9	PZ																																																																														

COMPONENT			SPARE PART																																																																																		
Code	Description	Image	Code	Description	Components list																																																																																
VL1019A	VIBRATION PUMP		KVL1184A	2 ROTOR ARMS PLUS EU CLEANING SYSTEM KIT	<table border="1"> <thead> <tr> <th>Code</th> <th>Description</th> <th>Qty</th> <th>UOM</th> </tr> </thead> <tbody> <tr> <td>0H2143A0</td> <td>LAMIERA BLOCCA VNR VL1128</td> <td>2</td> <td>PZ</td> </tr> <tr> <td>0H2168A0</td> <td></td> <td>1</td> <td>PZ</td> </tr> <tr> <td>0H2354A0</td> <td>XEVC-XEVL WASHING CIRCUIT PLAT</td> <td>1</td> <td>PZ</td> </tr> <tr> <td>EL1220A0</td> <td>JG STRAIGHT CONNECTION Ø8F-Ø8F</td> <td>3</td> <td>PZ</td> </tr> <tr> <td>EL1440A0</td> <td>WATER SELF CLEANING VALVE</td> <td>4</td> <td>PZ</td> </tr> <tr> <td>GN1526A0</td> <td>INT. D.=6.9 TH=1.8 O-RIN</td> <td>9</td> <td>PZ</td> </tr> <tr> <td>RC1018A0</td> <td>ZINC PLATED D12 ELASTIC CLAMP</td> <td>2</td> <td>PZ</td> </tr> <tr> <td>RC1019A0</td> <td>D=10 ELASTIC CLAMP</td> <td>21</td> <td>PZ</td> </tr> <tr> <td>RC1130A0</td> <td>130X2,6 CLAM</td> <td>7</td> <td>PZ</td> </tr> <tr> <td>RC1131A0</td> <td>200X2.6 BLACK CLAMP</td> <td>3</td> <td>PZ</td> </tr> <tr> <td>RC1242A0</td> <td>D=10 CLOSED CAP</td> <td>2</td> <td>PZ</td> </tr> <tr> <td>RC1356A0</td> <td>"STRAIGHT THREADED FEMALE END 8X1/4" BS</td> <td>1</td> <td>PZ</td> </tr> <tr> <td>TB2820A0</td> <td>6X10 EPDM PIPE FOR WASHING SYSTEM</td> <td>2.400</td> <td>M</td> </tr> <tr> <td>TB3132A0</td> <td>WHITE-BLUE EPDM TEXTILE BRAID HOSE 6X12</td> <td>1.220</td> <td>M</td> </tr> <tr> <td>VL1019A0</td> <td>VIBRATION PUMP</td> <td>1</td> <td>PZ</td> </tr> <tr> <td>VL1046A1</td> <td>D6 PIPE HOLDER - D6 J.G. TERMINAL</td> <td>3</td> <td>PZ</td> </tr> <tr> <td>VL1047A1</td> <td>D6 PIPE HOLDER - D8 J.G. TERMINAL</td> <td>1</td> <td>PZ</td> </tr> <tr> <td>VL1065A1</td> <td>1/4 MALE N.O. PRESSURE SWITCH</td> <td>1</td> <td>PZ</td> </tr> <tr> <td>VL1067A0</td> <td>WASHING SYSTEM INLETS DISTRIBUTOR</td> <td>1</td> <td>PZ</td> </tr> </tbody> </table>	Code	Description	Qty	UOM	0H2143A0	LAMIERA BLOCCA VNR VL1128	2	PZ	0H2168A0		1	PZ	0H2354A0	XEVC-XEVL WASHING CIRCUIT PLAT	1	PZ	EL1220A0	JG STRAIGHT CONNECTION Ø8F-Ø8F	3	PZ	EL1440A0	WATER SELF CLEANING VALVE	4	PZ	GN1526A0	INT. D.=6.9 TH=1.8 O-RIN	9	PZ	RC1018A0	ZINC PLATED D12 ELASTIC CLAMP	2	PZ	RC1019A0	D=10 ELASTIC CLAMP	21	PZ	RC1130A0	130X2,6 CLAM	7	PZ	RC1131A0	200X2.6 BLACK CLAMP	3	PZ	RC1242A0	D=10 CLOSED CAP	2	PZ	RC1356A0	"STRAIGHT THREADED FEMALE END 8X1/4" BS	1	PZ	TB2820A0	6X10 EPDM PIPE FOR WASHING SYSTEM	2.400	M	TB3132A0	WHITE-BLUE EPDM TEXTILE BRAID HOSE 6X12	1.220	M	VL1019A0	VIBRATION PUMP	1	PZ	VL1046A1	D6 PIPE HOLDER - D6 J.G. TERMINAL	3	PZ	VL1047A1	D6 PIPE HOLDER - D8 J.G. TERMINAL	1	PZ	VL1065A1	1/4 MALE N.O. PRESSURE SWITCH	1	PZ	VL1067A0	WASHING SYSTEM INLETS DISTRIBUTOR	1	PZ
Code	Description	Qty	UOM																																																																																		
0H2143A0	LAMIERA BLOCCA VNR VL1128	2	PZ																																																																																		
0H2168A0		1	PZ																																																																																		
0H2354A0	XEVC-XEVL WASHING CIRCUIT PLAT	1	PZ																																																																																		
EL1220A0	JG STRAIGHT CONNECTION Ø8F-Ø8F	3	PZ																																																																																		
EL1440A0	WATER SELF CLEANING VALVE	4	PZ																																																																																		
GN1526A0	INT. D.=6.9 TH=1.8 O-RIN	9	PZ																																																																																		
RC1018A0	ZINC PLATED D12 ELASTIC CLAMP	2	PZ																																																																																		
RC1019A0	D=10 ELASTIC CLAMP	21	PZ																																																																																		
RC1130A0	130X2,6 CLAM	7	PZ																																																																																		
RC1131A0	200X2.6 BLACK CLAMP	3	PZ																																																																																		
RC1242A0	D=10 CLOSED CAP	2	PZ																																																																																		
RC1356A0	"STRAIGHT THREADED FEMALE END 8X1/4" BS	1	PZ																																																																																		
TB2820A0	6X10 EPDM PIPE FOR WASHING SYSTEM	2.400	M																																																																																		
TB3132A0	WHITE-BLUE EPDM TEXTILE BRAID HOSE 6X12	1.220	M																																																																																		
VL1019A0	VIBRATION PUMP	1	PZ																																																																																		
VL1046A1	D6 PIPE HOLDER - D6 J.G. TERMINAL	3	PZ																																																																																		
VL1047A1	D6 PIPE HOLDER - D8 J.G. TERMINAL	1	PZ																																																																																		
VL1065A1	1/4 MALE N.O. PRESSURE SWITCH	1	PZ																																																																																		
VL1067A0	WASHING SYSTEM INLETS DISTRIBUTOR	1	PZ																																																																																		

COMPONENT			SPARE PART																																																						
Code	Description	Image	Code	Description	Components list																																																				
VL1019A	VIBRATION PUMP		KVL1184A	2 ROTOR ARMS PLUS EU CLEANING SYSTEM KIT	<table border="1"> <thead> <tr> <th>Code</th> <th>Description</th> <th>Qty</th> <th>UOM</th> </tr> </thead> <tbody> <tr> <td>VL1092A0</td> <td>WASHING SYSTEM OUTLET DOUBLE DISTRIBUTOR</td> <td>1</td> <td>PZ</td> </tr> <tr> <td>VL1102A1</td> <td>DETERGENT LINE FILTER + BARBED VNR 6 MM</td> <td>1</td> <td>PZ</td> </tr> <tr> <td>VL1128A0</td> <td>D6 BARBED CHECK VALVE</td> <td>2</td> <td>PZ</td> </tr> <tr> <td>VL1128A1</td> <td>D6 BARBED CHECK VALVE</td> <td>2</td> <td>PZ</td> </tr> <tr> <td>VL1141A1</td> <td>STRAIGHT CONNECT BB6-BB6</td> <td>1</td> <td>PZ</td> </tr> <tr> <td>VL1165A0</td> <td>BB6-AR6 STRAIGHT FITTING</td> <td>4</td> <td>PZ</td> </tr> <tr> <td>VL1166A0</td> <td>BB6-AR6 L FITTING</td> <td>4</td> <td>PZ</td> </tr> <tr> <td>VL1174C0</td> <td>D1.2 MM CALIBRATED NOZZLE</td> <td>1</td> <td>PZ</td> </tr> <tr> <td>VL1186A0</td> <td>3 WAYS PLUS WASHING DISTRIBUTOR</td> <td>1</td> <td>PZ</td> </tr> <tr> <td>VL1190A0</td> <td>PLUS WASHING SYSTEM INLET DISTRIBUTOR</td> <td>1</td> <td>PZ</td> </tr> <tr> <td>VM1605A0</td> <td>CLIP TWIST LOCK DIAM. 10,2-12,7 MM</td> <td>4</td> <td>PZ</td> </tr> <tr> <td>VM2172A0</td> <td>PUMP-WITH-CI RCUIT LOCKING PIN</td> <td>9</td> <td>PZ</td> </tr> </tbody> </table>	Code	Description	Qty	UOM	VL1092A0	WASHING SYSTEM OUTLET DOUBLE DISTRIBUTOR	1	PZ	VL1102A1	DETERGENT LINE FILTER + BARBED VNR 6 MM	1	PZ	VL1128A0	D6 BARBED CHECK VALVE	2	PZ	VL1128A1	D6 BARBED CHECK VALVE	2	PZ	VL1141A1	STRAIGHT CONNECT BB6-BB6	1	PZ	VL1165A0	BB6-AR6 STRAIGHT FITTING	4	PZ	VL1166A0	BB6-AR6 L FITTING	4	PZ	VL1174C0	D1.2 MM CALIBRATED NOZZLE	1	PZ	VL1186A0	3 WAYS PLUS WASHING DISTRIBUTOR	1	PZ	VL1190A0	PLUS WASHING SYSTEM INLET DISTRIBUTOR	1	PZ	VM1605A0	CLIP TWIST LOCK DIAM. 10,2-12,7 MM	4	PZ	VM2172A0	PUMP-WITH-CI RCUIT LOCKING PIN	9	PZ
Code	Description	Qty	UOM																																																						
VL1092A0	WASHING SYSTEM OUTLET DOUBLE DISTRIBUTOR	1	PZ																																																						
VL1102A1	DETERGENT LINE FILTER + BARBED VNR 6 MM	1	PZ																																																						
VL1128A0	D6 BARBED CHECK VALVE	2	PZ																																																						
VL1128A1	D6 BARBED CHECK VALVE	2	PZ																																																						
VL1141A1	STRAIGHT CONNECT BB6-BB6	1	PZ																																																						
VL1165A0	BB6-AR6 STRAIGHT FITTING	4	PZ																																																						
VL1166A0	BB6-AR6 L FITTING	4	PZ																																																						
VL1174C0	D1.2 MM CALIBRATED NOZZLE	1	PZ																																																						
VL1186A0	3 WAYS PLUS WASHING DISTRIBUTOR	1	PZ																																																						
VL1190A0	PLUS WASHING SYSTEM INLET DISTRIBUTOR	1	PZ																																																						
VM1605A0	CLIP TWIST LOCK DIAM. 10,2-12,7 MM	4	PZ																																																						
VM2172A0	PUMP-WITH-CI RCUIT LOCKING PIN	9	PZ																																																						
			KVL1183A	1 ROTOR ARM PLUS CLEANING SYSTEM KIT	<table border="1"> <thead> <tr> <th>Code</th> <th>Description</th> <th>Qty</th> <th>UOM</th> </tr> </thead> <tbody> <tr> <td>0H2143A0</td> <td>LAMIERA BLOCCA VNR VL1128</td> <td>2</td> <td>PZ</td> </tr> <tr> <td>0H2168A1</td> <td></td> <td>1</td> <td>PZ</td> </tr> <tr> <td>0H2354A0</td> <td>XEVC-XEVL WASHING CIRCUIT PLAT</td> <td>1</td> <td>PZ</td> </tr> <tr> <td>EL1440A0</td> <td>WATER SELF CLEANING VALVE</td> <td>3</td> <td>PZ</td> </tr> <tr> <td>GN1526A0</td> <td>INT. D.=6.9 TH=1.8 O-RIN</td> <td>7</td> <td>PZ</td> </tr> <tr> <td>RC1018A0</td> <td>ZINC PLATED D12 ELASTIC CLAMP</td> <td>2</td> <td>PZ</td> </tr> </tbody> </table>	Code	Description	Qty	UOM	0H2143A0	LAMIERA BLOCCA VNR VL1128	2	PZ	0H2168A1		1	PZ	0H2354A0	XEVC-XEVL WASHING CIRCUIT PLAT	1	PZ	EL1440A0	WATER SELF CLEANING VALVE	3	PZ	GN1526A0	INT. D.=6.9 TH=1.8 O-RIN	7	PZ	RC1018A0	ZINC PLATED D12 ELASTIC CLAMP	2	PZ																								
Code	Description	Qty	UOM																																																						
0H2143A0	LAMIERA BLOCCA VNR VL1128	2	PZ																																																						
0H2168A1		1	PZ																																																						
0H2354A0	XEVC-XEVL WASHING CIRCUIT PLAT	1	PZ																																																						
EL1440A0	WATER SELF CLEANING VALVE	3	PZ																																																						
GN1526A0	INT. D.=6.9 TH=1.8 O-RIN	7	PZ																																																						
RC1018A0	ZINC PLATED D12 ELASTIC CLAMP	2	PZ																																																						

COMPONENT			SPARE PART																																																																																		
Code	Description	Image	Code	Description	Components list																																																																																
VL1019A	VIBRATION PUMP		KVL1183A	1 ROTOR ARM PLUS CLEANING SYSTEM KIT	<table border="1"> <thead> <tr> <th>Code</th> <th>Description</th> <th>Qty</th> <th>UOM</th> </tr> </thead> <tbody> <tr> <td>RC1019A0</td> <td>D=10 ELASTIC CLAMP</td> <td>14</td> <td>PZ</td> </tr> <tr> <td>RC1130A0</td> <td>130X2,6 CLAM</td> <td>5</td> <td>PZ</td> </tr> <tr> <td>RC1131A0</td> <td>200X2.6 BLACK CLAMP</td> <td>2</td> <td>PZ</td> </tr> <tr> <td>RC1242A0</td> <td>D=10 CLOSED CAP</td> <td>2</td> <td>PZ</td> </tr> <tr> <td>RC1356A0</td> <td>"STRAIGHT THREADED FEMALE END 8X1/4" BS</td> <td>1</td> <td>PZ</td> </tr> <tr> <td>TB2820A0</td> <td>6X10 EPDM PIPE FOR WASHING SYSTEM</td> <td>1.410</td> <td>M</td> </tr> <tr> <td>TB3132A0</td> <td>WHITE-BLUE EPDM TEXTILE BRAID HOSE 6X12</td> <td>0.770</td> <td>M</td> </tr> <tr> <td>VI1220A1</td> <td>4,2X12 TCB SELF-TAPPING SCREW</td> <td>3</td> <td>PZ</td> </tr> <tr> <td>VL1019A0</td> <td>VIBRATION PUMP</td> <td>1</td> <td>PZ</td> </tr> <tr> <td>VL1047A1</td> <td>D6 PIPE HOLDER - D8 J.G. TERMINAL</td> <td>1</td> <td>PZ</td> </tr> <tr> <td>VL1065A1</td> <td>1/4 MALE N.O. PRESSURE SWITCH</td> <td>1</td> <td>PZ</td> </tr> <tr> <td>VL1102A1</td> <td>DETERGENT LINE FILTER + BARBED VNR 6 MM</td> <td>1</td> <td>PZ</td> </tr> <tr> <td>VL1128A0</td> <td>D6 BARBED CHECK VALVE</td> <td>2</td> <td>PZ</td> </tr> <tr> <td>VL1128A1</td> <td>D6 BARBED CHECK VALVE</td> <td>2</td> <td>PZ</td> </tr> <tr> <td>VL1165A0</td> <td>BB6-AR6 STRAIGHT FITTING</td> <td>1</td> <td>PZ</td> </tr> <tr> <td>VL1166A0</td> <td>BB6-AR6 L FITTING</td> <td>3</td> <td>PZ</td> </tr> <tr> <td>VL1174C0</td> <td>D1.2 MM CALIBRATED NOZZLE</td> <td>1</td> <td>PZ</td> </tr> <tr> <td>VL1185A0</td> <td>2 WAYS PLUS WASHING DISTRIBUTOR</td> <td>1</td> <td>PZ</td> </tr> <tr> <td>VL1190A0</td> <td>PLUS WASHING SYSTEM INLET DISTRIBUTOR</td> <td>1</td> <td>PZ</td> </tr> </tbody> </table>	Code	Description	Qty	UOM	RC1019A0	D=10 ELASTIC CLAMP	14	PZ	RC1130A0	130X2,6 CLAM	5	PZ	RC1131A0	200X2.6 BLACK CLAMP	2	PZ	RC1242A0	D=10 CLOSED CAP	2	PZ	RC1356A0	"STRAIGHT THREADED FEMALE END 8X1/4" BS	1	PZ	TB2820A0	6X10 EPDM PIPE FOR WASHING SYSTEM	1.410	M	TB3132A0	WHITE-BLUE EPDM TEXTILE BRAID HOSE 6X12	0.770	M	VI1220A1	4,2X12 TCB SELF-TAPPING SCREW	3	PZ	VL1019A0	VIBRATION PUMP	1	PZ	VL1047A1	D6 PIPE HOLDER - D8 J.G. TERMINAL	1	PZ	VL1065A1	1/4 MALE N.O. PRESSURE SWITCH	1	PZ	VL1102A1	DETERGENT LINE FILTER + BARBED VNR 6 MM	1	PZ	VL1128A0	D6 BARBED CHECK VALVE	2	PZ	VL1128A1	D6 BARBED CHECK VALVE	2	PZ	VL1165A0	BB6-AR6 STRAIGHT FITTING	1	PZ	VL1166A0	BB6-AR6 L FITTING	3	PZ	VL1174C0	D1.2 MM CALIBRATED NOZZLE	1	PZ	VL1185A0	2 WAYS PLUS WASHING DISTRIBUTOR	1	PZ	VL1190A0	PLUS WASHING SYSTEM INLET DISTRIBUTOR	1	PZ
Code	Description	Qty	UOM																																																																																		
RC1019A0	D=10 ELASTIC CLAMP	14	PZ																																																																																		
RC1130A0	130X2,6 CLAM	5	PZ																																																																																		
RC1131A0	200X2.6 BLACK CLAMP	2	PZ																																																																																		
RC1242A0	D=10 CLOSED CAP	2	PZ																																																																																		
RC1356A0	"STRAIGHT THREADED FEMALE END 8X1/4" BS	1	PZ																																																																																		
TB2820A0	6X10 EPDM PIPE FOR WASHING SYSTEM	1.410	M																																																																																		
TB3132A0	WHITE-BLUE EPDM TEXTILE BRAID HOSE 6X12	0.770	M																																																																																		
VI1220A1	4,2X12 TCB SELF-TAPPING SCREW	3	PZ																																																																																		
VL1019A0	VIBRATION PUMP	1	PZ																																																																																		
VL1047A1	D6 PIPE HOLDER - D8 J.G. TERMINAL	1	PZ																																																																																		
VL1065A1	1/4 MALE N.O. PRESSURE SWITCH	1	PZ																																																																																		
VL1102A1	DETERGENT LINE FILTER + BARBED VNR 6 MM	1	PZ																																																																																		
VL1128A0	D6 BARBED CHECK VALVE	2	PZ																																																																																		
VL1128A1	D6 BARBED CHECK VALVE	2	PZ																																																																																		
VL1165A0	BB6-AR6 STRAIGHT FITTING	1	PZ																																																																																		
VL1166A0	BB6-AR6 L FITTING	3	PZ																																																																																		
VL1174C0	D1.2 MM CALIBRATED NOZZLE	1	PZ																																																																																		
VL1185A0	2 WAYS PLUS WASHING DISTRIBUTOR	1	PZ																																																																																		
VL1190A0	PLUS WASHING SYSTEM INLET DISTRIBUTOR	1	PZ																																																																																		

COMPONENT			SPARE PART																																																																			
Code	Description	Image	Code	Description	Components list																																																																	
VL1019A	VIBRATION PUMP		KVL1183A	1 ROTOR ARM PLUS CLEANING SYSTEM KIT	<table border="1"> <thead> <tr> <th>Code</th> <th>Description</th> <th>Qty</th> <th>UOM</th> </tr> </thead> <tbody> <tr> <td>VM1605A0</td> <td>CLIP TWIST LOCK DIAM. 10,2-12,7 MM</td> <td>3</td> <td>PZ</td> </tr> <tr> <td>VM2172A0</td> <td>PUMP-WITH-CI RCUIT LOCKING PIN</td> <td>7</td> <td>PZ</td> </tr> </tbody> </table>	Code	Description	Qty	UOM	VM1605A0	CLIP TWIST LOCK DIAM. 10,2-12,7 MM	3	PZ	VM2172A0	PUMP-WITH-CI RCUIT LOCKING PIN	7	PZ																																																					
			Code	Description	Qty	UOM																																																																
VM1605A0	CLIP TWIST LOCK DIAM. 10,2-12,7 MM	3	PZ																																																																			
VM2172A0	PUMP-WITH-CI RCUIT LOCKING PIN	7	PZ																																																																			
KVL1182A	ONE CLEANING SYSTEM KIT (0311 EXC.)	<table border="1"> <thead> <tr> <th>Code</th> <th>Description</th> <th>Qty</th> <th>UOM</th> </tr> </thead> <tbody> <tr> <td>0H2143A0</td> <td>LAMIERA BLOCCA VNR VL1128</td> <td>2</td> <td>PZ</td> </tr> <tr> <td>0H2202A1</td> <td>ONE WASHING WITH STEAM VALVE SUPPORT</td> <td>1</td> <td>PZ</td> </tr> <tr> <td>EL1440A0</td> <td>WATER SELF CLEANING VALVE</td> <td>1</td> <td>PZ</td> </tr> <tr> <td>GN1526A0</td> <td>INT. D.=6.9 TH=1.8 O-RIN</td> <td>3</td> <td>PZ</td> </tr> <tr> <td>RC1018A0</td> <td>ZINC PLATED D12 ELASTIC CLAMP</td> <td>1</td> <td>PZ</td> </tr> <tr> <td>RC1019A0</td> <td>D=10 ELASTIC CLAMP</td> <td>14</td> <td>PZ</td> </tr> <tr> <td>RC1130A0</td> <td>130X2,6 CLAM</td> <td>2</td> <td>PZ</td> </tr> <tr> <td>RC1242A0</td> <td>D=10 CLOSED CAP</td> <td>2</td> <td>PZ</td> </tr> <tr> <td>TB2820A0</td> <td>6X10 EPDM PIPE FOR WASHING SYSTEM</td> <td>1.410</td> <td>M</td> </tr> <tr> <td>TB3132A0</td> <td>WHITE-BLUE EPDM TEXTILE BRAID HOSE 6X12</td> <td>0.670</td> <td>M</td> </tr> <tr> <td>VI1220A1</td> <td>4,2X12 TCB SELF-TAPPIN G SCREW</td> <td>1</td> <td>PZ</td> </tr> <tr> <td>VL1019A0</td> <td>VIBRATION PUMP</td> <td>1</td> <td>PZ</td> </tr> <tr> <td>VL1047A1</td> <td>D6 PIPE HOLDER - D8 J.G. TERMINAL</td> <td>1</td> <td>PZ</td> </tr> <tr> <td>VL1054B0</td> <td>ONE WASHING SYS INLET DISTRIBUTOR</td> <td>1</td> <td>PZ</td> </tr> <tr> <td>VL1102A1</td> <td>DETERGENT LINE FILTER + BARBED VNR 6 MM</td> <td>1</td> <td>PZ</td> </tr> <tr> <td>VL1128A0</td> <td>D6 BARBED CHECK VALVE</td> <td>2</td> <td>PZ</td> </tr> </tbody> </table>	Code	Description	Qty	UOM	0H2143A0	LAMIERA BLOCCA VNR VL1128	2	PZ	0H2202A1	ONE WASHING WITH STEAM VALVE SUPPORT	1	PZ	EL1440A0	WATER SELF CLEANING VALVE	1	PZ	GN1526A0	INT. D.=6.9 TH=1.8 O-RIN	3	PZ	RC1018A0	ZINC PLATED D12 ELASTIC CLAMP	1	PZ	RC1019A0	D=10 ELASTIC CLAMP	14	PZ	RC1130A0	130X2,6 CLAM	2	PZ	RC1242A0	D=10 CLOSED CAP	2	PZ	TB2820A0	6X10 EPDM PIPE FOR WASHING SYSTEM	1.410	M	TB3132A0	WHITE-BLUE EPDM TEXTILE BRAID HOSE 6X12	0.670	M	VI1220A1	4,2X12 TCB SELF-TAPPIN G SCREW	1	PZ	VL1019A0	VIBRATION PUMP	1	PZ	VL1047A1	D6 PIPE HOLDER - D8 J.G. TERMINAL	1	PZ	VL1054B0	ONE WASHING SYS INLET DISTRIBUTOR	1	PZ	VL1102A1	DETERGENT LINE FILTER + BARBED VNR 6 MM	1	PZ	VL1128A0	D6 BARBED CHECK VALVE	2	PZ
Code	Description	Qty	UOM																																																																			
0H2143A0	LAMIERA BLOCCA VNR VL1128	2	PZ																																																																			
0H2202A1	ONE WASHING WITH STEAM VALVE SUPPORT	1	PZ																																																																			
EL1440A0	WATER SELF CLEANING VALVE	1	PZ																																																																			
GN1526A0	INT. D.=6.9 TH=1.8 O-RIN	3	PZ																																																																			
RC1018A0	ZINC PLATED D12 ELASTIC CLAMP	1	PZ																																																																			
RC1019A0	D=10 ELASTIC CLAMP	14	PZ																																																																			
RC1130A0	130X2,6 CLAM	2	PZ																																																																			
RC1242A0	D=10 CLOSED CAP	2	PZ																																																																			
TB2820A0	6X10 EPDM PIPE FOR WASHING SYSTEM	1.410	M																																																																			
TB3132A0	WHITE-BLUE EPDM TEXTILE BRAID HOSE 6X12	0.670	M																																																																			
VI1220A1	4,2X12 TCB SELF-TAPPIN G SCREW	1	PZ																																																																			
VL1019A0	VIBRATION PUMP	1	PZ																																																																			
VL1047A1	D6 PIPE HOLDER - D8 J.G. TERMINAL	1	PZ																																																																			
VL1054B0	ONE WASHING SYS INLET DISTRIBUTOR	1	PZ																																																																			
VL1102A1	DETERGENT LINE FILTER + BARBED VNR 6 MM	1	PZ																																																																			
VL1128A0	D6 BARBED CHECK VALVE	2	PZ																																																																			

COMPONENT			SPARE PART																																																			
Code	Description	Image	Code	Description	Components list																																																	
VL1019A	VIBRATION PUMP		KVL1182A	ONE CLEANING SYSTEM KIT (0311 EXC.)	<table border="1"> <thead> <tr> <th>Code</th> <th>Description</th> <th>Qty</th> <th>UOM</th> </tr> </thead> <tbody> <tr> <td>VL1128A1</td> <td>D6 BARBED CHECK VALVE</td> <td>2</td> <td>PZ</td> </tr> <tr> <td>VL1165A0</td> <td>BB6-AR6 STRAIGHT FITTING</td> <td>1</td> <td>PZ</td> </tr> <tr> <td>VL1166A0</td> <td>BB6-AR6 L FITTING</td> <td>1</td> <td>PZ</td> </tr> <tr> <td>VL1174C0</td> <td>D1.2 MM CALIBRATED NOZZLE</td> <td>1</td> <td>PZ</td> </tr> <tr> <td>VL1191A0</td> <td>ONE WASHING DISTRIBUTOR OUTLETS KIT</td> <td>1</td> <td>PZ</td> </tr> <tr> <td>VM1605A0</td> <td>CLIP TWIST LOCK DIAM. 10,2-12,7 MM</td> <td>3</td> <td>PZ</td> </tr> <tr> <td>VM2172A0</td> <td>PUMP-WITH-CI RCUIT LOCKING PIN</td> <td>2</td> <td>PZ</td> </tr> </tbody> </table>	Code	Description	Qty	UOM	VL1128A1	D6 BARBED CHECK VALVE	2	PZ	VL1165A0	BB6-AR6 STRAIGHT FITTING	1	PZ	VL1166A0	BB6-AR6 L FITTING	1	PZ	VL1174C0	D1.2 MM CALIBRATED NOZZLE	1	PZ	VL1191A0	ONE WASHING DISTRIBUTOR OUTLETS KIT	1	PZ	VM1605A0	CLIP TWIST LOCK DIAM. 10,2-12,7 MM	3	PZ	VM2172A0	PUMP-WITH-CI RCUIT LOCKING PIN	2	PZ																	
			Code	Description	Qty	UOM																																																
VL1128A1	D6 BARBED CHECK VALVE	2	PZ																																																			
VL1165A0	BB6-AR6 STRAIGHT FITTING	1	PZ																																																			
VL1166A0	BB6-AR6 L FITTING	1	PZ																																																			
VL1174C0	D1.2 MM CALIBRATED NOZZLE	1	PZ																																																			
VL1191A0	ONE WASHING DISTRIBUTOR OUTLETS KIT	1	PZ																																																			
VM1605A0	CLIP TWIST LOCK DIAM. 10,2-12,7 MM	3	PZ																																																			
VM2172A0	PUMP-WITH-CI RCUIT LOCKING PIN	2	PZ																																																			
KVL0684A	2-3 ROTOR ARM PLUS WASH PUMP+NOZZLE KIT	<table border="1"> <thead> <tr> <th>Code</th> <th>Description</th> <th>Qty</th> <th>UOM</th> </tr> </thead> <tbody> <tr> <td>GN1526A0</td> <td>INT. D.=6.9 TH=1.8 O-RING</td> <td>4</td> <td>PZ</td> </tr> <tr> <td>RC1019A0</td> <td>D=10 ELASTIC CLAMP</td> <td>4</td> <td>PZ</td> </tr> <tr> <td>RC1130A0</td> <td>130X2,6 CLAMP</td> <td>1</td> <td>PZ</td> </tr> <tr> <td>RC1131A0</td> <td>200X2,6 BLACK CLAMP</td> <td>3</td> <td>PZ</td> </tr> <tr> <td>RC1242A0</td> <td>D=10 CLOSED CAP</td> <td>2</td> <td>PZ</td> </tr> <tr> <td>TB2820A0</td> <td>6X10 EPDM PIPE FOR WASHING SYSTEM</td> <td>0.120</td> <td>M</td> </tr> <tr> <td>VL1019A0</td> <td>VIBRATION PUMP</td> <td>1</td> <td>PZ</td> </tr> <tr> <td>VL1128A1</td> <td>D6 BARBED CHECK VALVE</td> <td>1</td> <td>PZ</td> </tr> <tr> <td>VL1174C0</td> <td>D1.2 MM CALIBRATED NOZZLE</td> <td>1</td> <td>PZ</td> </tr> <tr> <td>VL1186A0</td> <td>3 WAYS PLUS WASHING DISTRIBUTOR</td> <td>1</td> <td>PZ</td> </tr> <tr> <td>VL1190A0</td> <td>PLUS WASHING SYSTEM INLET DISTRIBUTOR</td> <td>1</td> <td>PZ</td> </tr> <tr> <td>VM2172A0</td> <td>PUMP-WITH-CI RCUIT LOCKING PIN</td> <td>1</td> <td>PZ</td> </tr> </tbody> </table>	Code	Description	Qty	UOM	GN1526A0	INT. D.=6.9 TH=1.8 O-RING	4	PZ	RC1019A0	D=10 ELASTIC CLAMP	4	PZ	RC1130A0	130X2,6 CLAMP	1	PZ	RC1131A0	200X2,6 BLACK CLAMP	3	PZ	RC1242A0	D=10 CLOSED CAP	2	PZ	TB2820A0	6X10 EPDM PIPE FOR WASHING SYSTEM	0.120	M	VL1019A0	VIBRATION PUMP	1	PZ	VL1128A1	D6 BARBED CHECK VALVE	1	PZ	VL1174C0	D1.2 MM CALIBRATED NOZZLE	1	PZ	VL1186A0	3 WAYS PLUS WASHING DISTRIBUTOR	1	PZ	VL1190A0	PLUS WASHING SYSTEM INLET DISTRIBUTOR	1	PZ	VM2172A0	PUMP-WITH-CI RCUIT LOCKING PIN	1	PZ
Code	Description	Qty	UOM																																																			
GN1526A0	INT. D.=6.9 TH=1.8 O-RING	4	PZ																																																			
RC1019A0	D=10 ELASTIC CLAMP	4	PZ																																																			
RC1130A0	130X2,6 CLAMP	1	PZ																																																			
RC1131A0	200X2,6 BLACK CLAMP	3	PZ																																																			
RC1242A0	D=10 CLOSED CAP	2	PZ																																																			
TB2820A0	6X10 EPDM PIPE FOR WASHING SYSTEM	0.120	M																																																			
VL1019A0	VIBRATION PUMP	1	PZ																																																			
VL1128A1	D6 BARBED CHECK VALVE	1	PZ																																																			
VL1174C0	D1.2 MM CALIBRATED NOZZLE	1	PZ																																																			
VL1186A0	3 WAYS PLUS WASHING DISTRIBUTOR	1	PZ																																																			
VL1190A0	PLUS WASHING SYSTEM INLET DISTRIBUTOR	1	PZ																																																			
VM2172A0	PUMP-WITH-CI RCUIT LOCKING PIN	1	PZ																																																			

COMPONENT			SPARE PART																																																																																													
Code	Description	Image	Code	Description	Components list																																																																																											
VL1019A	VIBRATION PUMP		KVL0683A	1 ROTOR ARM PLUS WASH PUMP+NOZZLE KIT	<table border="1"> <thead> <tr> <th>Code</th> <th>Description</th> <th>Qty</th> <th>UOM</th> </tr> </thead> <tbody> <tr> <td>GN1526A0</td> <td>INT. D.=6.9 TH=1.8 O-RIN</td> <td>3</td> <td>PZ</td> </tr> <tr> <td>RC1019A0</td> <td>D=10 ELASTIC CLAMP</td> <td>4</td> <td>PZ</td> </tr> <tr> <td>RC1130A0</td> <td>130X2,6 CLAM</td> <td>1</td> <td>PZ</td> </tr> <tr> <td>RC1131A0</td> <td>200X2.6 BLACK CLAMP</td> <td>2</td> <td>PZ</td> </tr> <tr> <td>RC1242A0</td> <td>D=10 CLOSED CAP</td> <td>2</td> <td>PZ</td> </tr> <tr> <td>TB2820A0</td> <td>6X10 EPDM PIPE FOR WASHING SYSTEM</td> <td>0.120</td> <td>M</td> </tr> <tr> <td>VL1019A0</td> <td>VIBRATION PUMP</td> <td>1</td> <td>PZ</td> </tr> <tr> <td>VL1128A1</td> <td>D6 BARBED CHECK VALVE</td> <td>1</td> <td>PZ</td> </tr> <tr> <td>VL1174C0</td> <td>D1.2 MM CALIBRATED NOZZLE</td> <td>1</td> <td>PZ</td> </tr> <tr> <td>VL1185A0</td> <td>2 WAYS PLUS WASHING DISTRIBUTOR</td> <td>1</td> <td>PZ</td> </tr> <tr> <td>VL1190A0</td> <td>PLUS WASHING SYSTEM INLET DISTRIBUTOR</td> <td>1</td> <td>PZ</td> </tr> <tr> <td>VM2172A0</td> <td>PUMP-WITH-CI RCUIT LOCKING PIN</td> <td>1</td> <td>PZ</td> </tr> </tbody> </table>	Code	Description	Qty	UOM	GN1526A0	INT. D.=6.9 TH=1.8 O-RIN	3	PZ	RC1019A0	D=10 ELASTIC CLAMP	4	PZ	RC1130A0	130X2,6 CLAM	1	PZ	RC1131A0	200X2.6 BLACK CLAMP	2	PZ	RC1242A0	D=10 CLOSED CAP	2	PZ	TB2820A0	6X10 EPDM PIPE FOR WASHING SYSTEM	0.120	M	VL1019A0	VIBRATION PUMP	1	PZ	VL1128A1	D6 BARBED CHECK VALVE	1	PZ	VL1174C0	D1.2 MM CALIBRATED NOZZLE	1	PZ	VL1185A0	2 WAYS PLUS WASHING DISTRIBUTOR	1	PZ	VL1190A0	PLUS WASHING SYSTEM INLET DISTRIBUTOR	1	PZ	VM2172A0	PUMP-WITH-CI RCUIT LOCKING PIN	1	PZ	KVL0682A	ONE+HOODS WASHING SYSTEM PUMP+NOZZLE KIT	<table border="1"> <thead> <tr> <th>Code</th> <th>Description</th> <th>Qty</th> <th>UOM</th> </tr> </thead> <tbody> <tr> <td>GN1526A0</td> <td>INT. D.=6.9 TH=1.8 O-RIN</td> <td>1</td> <td>PZ</td> </tr> <tr> <td>RC1019A0</td> <td>D=10 ELASTIC CLAMP</td> <td>3</td> <td>PZ</td> </tr> <tr> <td>RC1242A0</td> <td>D=10 CLOSED CAP</td> <td>2</td> <td>PZ</td> </tr> <tr> <td>TB2820A0</td> <td>6X10 EPDM PIPE FOR WASHING SYSTEM</td> <td>0.120</td> <td>M</td> </tr> <tr> <td>VL1019A0</td> <td>VIBRATION PUMP</td> <td>1</td> <td>PZ</td> </tr> <tr> <td>VL1054B0</td> <td>ONE WASHING SYS INLET DISTRIBUTOR</td> <td>1</td> <td>PZ</td> </tr> <tr> <td>VL1128A1</td> <td>D6 BARBED CHECK VALVE</td> <td>2</td> <td>PZ</td> </tr> <tr> <td>VL1174C0</td> <td>D1.2 MM CALIBRATED NOZZLE</td> <td>1</td> <td>PZ</td> </tr> </tbody> </table>	Code	Description	Qty	UOM	GN1526A0	INT. D.=6.9 TH=1.8 O-RIN	1	PZ	RC1019A0	D=10 ELASTIC CLAMP	3	PZ	RC1242A0	D=10 CLOSED CAP	2	PZ	TB2820A0	6X10 EPDM PIPE FOR WASHING SYSTEM	0.120	M	VL1019A0	VIBRATION PUMP	1	PZ	VL1054B0	ONE WASHING SYS INLET DISTRIBUTOR	1	PZ	VL1128A1	D6 BARBED CHECK VALVE	2	PZ	VL1174C0	D1.2 MM CALIBRATED NOZZLE	1	PZ
			Code	Description	Qty	UOM																																																																																										
GN1526A0	INT. D.=6.9 TH=1.8 O-RIN	3	PZ																																																																																													
RC1019A0	D=10 ELASTIC CLAMP	4	PZ																																																																																													
RC1130A0	130X2,6 CLAM	1	PZ																																																																																													
RC1131A0	200X2.6 BLACK CLAMP	2	PZ																																																																																													
RC1242A0	D=10 CLOSED CAP	2	PZ																																																																																													
TB2820A0	6X10 EPDM PIPE FOR WASHING SYSTEM	0.120	M																																																																																													
VL1019A0	VIBRATION PUMP	1	PZ																																																																																													
VL1128A1	D6 BARBED CHECK VALVE	1	PZ																																																																																													
VL1174C0	D1.2 MM CALIBRATED NOZZLE	1	PZ																																																																																													
VL1185A0	2 WAYS PLUS WASHING DISTRIBUTOR	1	PZ																																																																																													
VL1190A0	PLUS WASHING SYSTEM INLET DISTRIBUTOR	1	PZ																																																																																													
VM2172A0	PUMP-WITH-CI RCUIT LOCKING PIN	1	PZ																																																																																													
Code	Description	Qty	UOM																																																																																													
GN1526A0	INT. D.=6.9 TH=1.8 O-RIN	1	PZ																																																																																													
RC1019A0	D=10 ELASTIC CLAMP	3	PZ																																																																																													
RC1242A0	D=10 CLOSED CAP	2	PZ																																																																																													
TB2820A0	6X10 EPDM PIPE FOR WASHING SYSTEM	0.120	M																																																																																													
VL1019A0	VIBRATION PUMP	1	PZ																																																																																													
VL1054B0	ONE WASHING SYS INLET DISTRIBUTOR	1	PZ																																																																																													
VL1128A1	D6 BARBED CHECK VALVE	2	PZ																																																																																													
VL1174C0	D1.2 MM CALIBRATED NOZZLE	1	PZ																																																																																													

COMPONENT			SPARE PART																																																															
Code	Description	Image	Code	Description	Components list																																																													
VL1019A	VIBRATION PUMP		KVL0682A	ONE+HOODS WASHING SYSTEM PUMP+NOZZLE KIT	<table border="1"> <thead> <tr> <th>Code</th> <th>Description</th> <th>Qty</th> <th>UOM</th> </tr> </thead> <tbody> <tr> <td>VL1191A0</td> <td>ONE WASHING DISTRIBUTOR OUTLETS KIT</td> <td>1</td> <td>PZ</td> </tr> <tr> <td>VM2172A0</td> <td>PUMP-WITH-CI RCUIT LOCKING PIN</td> <td>1</td> <td>PZ</td> </tr> </tbody> </table>	Code	Description	Qty	UOM	VL1191A0	ONE WASHING DISTRIBUTOR OUTLETS KIT	1	PZ	VM2172A0	PUMP-WITH-CI RCUIT LOCKING PIN	1	PZ																																																	
			Code	Description	Qty	UOM																																																												
VL1191A0	ONE WASHING DISTRIBUTOR OUTLETS KIT	1	PZ																																																															
VM2172A0	PUMP-WITH-CI RCUIT LOCKING PIN	1	PZ																																																															
KVL0001A	LM TOP CLEANING SYSTEM KIT	<table border="1"> <thead> <tr> <th>Code</th> <th>Description</th> <th>Qty</th> <th>UOM</th> </tr> </thead> <tbody> <tr> <td>0H1226B0</td> <td>LINEMISSTOP WASHING SYTEM CIRCUIT COVE</td> <td>1</td> <td>PZ</td> </tr> <tr> <td>0H2143A0</td> <td>LAMIERA BLOCCA VNR VL1128</td> <td>2</td> <td>PZ</td> </tr> <tr> <td>EL1436B0</td> <td>JG D8-BARBED D6 NRV WATER SOLENOID</td> <td>1</td> <td>PZ</td> </tr> <tr> <td>GN1312A0</td> <td>RUBBER CABLE-PASSI NG DE=26 DI=15 SP=10</td> <td>1</td> <td>PZ</td> </tr> <tr> <td>GN1526A0</td> <td>INT. D.=6.9 TH=1.8 O-RIN</td> <td>1</td> <td>PZ</td> </tr> <tr> <td>RC1019A0</td> <td>D=10 ELASTIC CLAMP</td> <td>5</td> <td>PZ</td> </tr> <tr> <td>RC1242A0</td> <td>D=10 CLOSED CAP</td> <td>2</td> <td>PZ</td> </tr> <tr> <td>RC1381A0</td> <td>BIFILAR PIPE CLIP D10,7</td> <td>3</td> <td>PZ</td> </tr> <tr> <td>TB2343A0</td> <td>9X6 PVC TRANSPAREN T PIPE</td> <td>1.650</td> <td>M</td> </tr> <tr> <td>TB2820A0</td> <td>6X10 EPDM PIPE FOR WASHING SYSTEM</td> <td>0.990</td> <td>M</td> </tr> <tr> <td>VI1220A1</td> <td>4,2X12 TCB SELF-TAPPIN G SCREW</td> <td>1</td> <td>PZ</td> </tr> <tr> <td>VL1019A0</td> <td>VIBRATION PUMP</td> <td>1</td> <td>PZ</td> </tr> <tr> <td>VL1041C0</td> <td>DETERGENT CAP WITH Ø12 HOLE</td> <td>1</td> <td>PZ</td> </tr> <tr> <td>VL1047A1</td> <td>D6 PIPE HOLDER - D8 J.G. TERMINAL</td> <td>1</td> <td>PZ</td> </tr> <tr> <td>VL1053B0</td> <td>ONE WASHING SYS EXT DISTRIBUTOR</td> <td>1</td> <td>PZ</td> </tr> </tbody> </table>	Code	Description	Qty	UOM	0H1226B0	LINEMISSTOP WASHING SYTEM CIRCUIT COVE	1	PZ	0H2143A0	LAMIERA BLOCCA VNR VL1128	2	PZ	EL1436B0	JG D8-BARBED D6 NRV WATER SOLENOID	1	PZ	GN1312A0	RUBBER CABLE-PASSI NG DE=26 DI=15 SP=10	1	PZ	GN1526A0	INT. D.=6.9 TH=1.8 O-RIN	1	PZ	RC1019A0	D=10 ELASTIC CLAMP	5	PZ	RC1242A0	D=10 CLOSED CAP	2	PZ	RC1381A0	BIFILAR PIPE CLIP D10,7	3	PZ	TB2343A0	9X6 PVC TRANSPAREN T PIPE	1.650	M	TB2820A0	6X10 EPDM PIPE FOR WASHING SYSTEM	0.990	M	VI1220A1	4,2X12 TCB SELF-TAPPIN G SCREW	1	PZ	VL1019A0	VIBRATION PUMP	1	PZ	VL1041C0	DETERGENT CAP WITH Ø12 HOLE	1	PZ	VL1047A1	D6 PIPE HOLDER - D8 J.G. TERMINAL	1	PZ	VL1053B0	ONE WASHING SYS EXT DISTRIBUTOR	1	PZ
Code	Description	Qty	UOM																																																															
0H1226B0	LINEMISSTOP WASHING SYTEM CIRCUIT COVE	1	PZ																																																															
0H2143A0	LAMIERA BLOCCA VNR VL1128	2	PZ																																																															
EL1436B0	JG D8-BARBED D6 NRV WATER SOLENOID	1	PZ																																																															
GN1312A0	RUBBER CABLE-PASSI NG DE=26 DI=15 SP=10	1	PZ																																																															
GN1526A0	INT. D.=6.9 TH=1.8 O-RIN	1	PZ																																																															
RC1019A0	D=10 ELASTIC CLAMP	5	PZ																																																															
RC1242A0	D=10 CLOSED CAP	2	PZ																																																															
RC1381A0	BIFILAR PIPE CLIP D10,7	3	PZ																																																															
TB2343A0	9X6 PVC TRANSPAREN T PIPE	1.650	M																																																															
TB2820A0	6X10 EPDM PIPE FOR WASHING SYSTEM	0.990	M																																																															
VI1220A1	4,2X12 TCB SELF-TAPPIN G SCREW	1	PZ																																																															
VL1019A0	VIBRATION PUMP	1	PZ																																																															
VL1041C0	DETERGENT CAP WITH Ø12 HOLE	1	PZ																																																															
VL1047A1	D6 PIPE HOLDER - D8 J.G. TERMINAL	1	PZ																																																															
VL1053B0	ONE WASHING SYS EXT DISTRIBUTOR	1	PZ																																																															

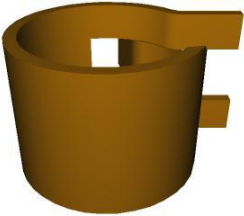
COMPONENT			SPARE PART																																						
Code	Description	Image	Code	Description	Components list																																				
VL1019A	VIBRATION PUMP		KVL0001A	LM TOP CLEANING SYSTEM KIT	<table border="1"> <thead> <tr> <th>Code</th> <th>Description</th> <th>Qty</th> <th>UOM</th> </tr> </thead> <tbody> <tr> <td>VL1054B0</td> <td>ONE WASHING SYS INLET DISTRIBUTOR</td> <td>1</td> <td>PZ</td> </tr> <tr> <td>VL1061A0</td> <td>HOLD DOWN WEIGHT+NET FILTER+NON-RET. V.</td> <td>1</td> <td>PZ</td> </tr> <tr> <td>VL1128A0</td> <td>D6 BARBED CHECK VALVE</td> <td>2</td> <td>PZ</td> </tr> <tr> <td>VL1128A1</td> <td>D6 BARBED CHECK VALVE</td> <td>2</td> <td>PZ</td> </tr> <tr> <td>VM1066A0</td> <td>SADDLE CLIP FOR CABLES PASSING</td> <td>3</td> <td>PZ</td> </tr> <tr> <td>VM1088A0</td> <td>NYLON CLICK CLAMP D7.9-D9.2</td> <td>1</td> <td>PZ</td> </tr> <tr> <td>VM1605A0</td> <td>CLIP TWIST LOCK DIAM. 10.2-12.7 MM</td> <td>1</td> <td>PZ</td> </tr> <tr> <td>VM2172A0</td> <td>PUMP-WITH-RCUIT LOCKING PIN</td> <td>1</td> <td>PZ</td> </tr> </tbody> </table>	Code	Description	Qty	UOM	VL1054B0	ONE WASHING SYS INLET DISTRIBUTOR	1	PZ	VL1061A0	HOLD DOWN WEIGHT+NET FILTER+NON-RET. V.	1	PZ	VL1128A0	D6 BARBED CHECK VALVE	2	PZ	VL1128A1	D6 BARBED CHECK VALVE	2	PZ	VM1066A0	SADDLE CLIP FOR CABLES PASSING	3	PZ	VM1088A0	NYLON CLICK CLAMP D7.9-D9.2	1	PZ	VM1605A0	CLIP TWIST LOCK DIAM. 10.2-12.7 MM	1	PZ	VM2172A0	PUMP-WITH-RCUIT LOCKING PIN	1	PZ
					Code	Description	Qty	UOM																																	
					VL1054B0	ONE WASHING SYS INLET DISTRIBUTOR	1	PZ																																	
					VL1061A0	HOLD DOWN WEIGHT+NET FILTER+NON-RET. V.	1	PZ																																	
					VL1128A0	D6 BARBED CHECK VALVE	2	PZ																																	
					VL1128A1	D6 BARBED CHECK VALVE	2	PZ																																	
					VM1066A0	SADDLE CLIP FOR CABLES PASSING	3	PZ																																	
					VM1088A0	NYLON CLICK CLAMP D7.9-D9.2	1	PZ																																	
					VM1605A0	CLIP TWIST LOCK DIAM. 10.2-12.7 MM	1	PZ																																	
					VM2172A0	PUMP-WITH-RCUIT LOCKING PIN	1	PZ																																	
GN1526A	INT. D.=6.9 TH=1.8 O-RING		KGN1526A	O-RING INT D6.9 THICK1.8 10PCS KIT	<table border="1"> <thead> <tr> <th>Code</th> <th>Description</th> <th>Qty</th> <th>UOM</th> </tr> </thead> <tbody> <tr> <td>GN1526A0</td> <td>INT. D.=6.9 TH=1.8 O-RIN</td> <td>10</td> <td>PZ</td> </tr> </tbody> </table>	Code	Description	Qty	UOM	GN1526A0	INT. D.=6.9 TH=1.8 O-RIN	10	PZ																												
					Code	Description	Qty	UOM																																	
					GN1526A0	INT. D.=6.9 TH=1.8 O-RIN	10	PZ																																	
					RC1019A	D=10 ELASTIC CLAMP		KRC1019A	Ø10 ZINC PLATED ELASTIC CLAMP 15 PCS KIT	<table border="1"> <thead> <tr> <th>Code</th> <th>Description</th> <th>Qty</th> <th>UOM</th> </tr> </thead> <tbody> <tr> <td>RC1019A0</td> <td>D=10 ELASTIC CLAMP</td> <td>17</td> <td>PZ</td> </tr> <tr> <td>VM1224A0</td> <td>65MY 220MM COLOURS SHRINK TUBE</td> <td>2 0.200</td> <td>M</td> </tr> </tbody> </table>	Code	Description	Qty	UOM	RC1019A0	D=10 ELASTIC CLAMP	17	PZ	VM1224A0	65MY 220MM COLOURS SHRINK TUBE	2 0.200	M																			
										Code	Description	Qty	UOM																												
					RC1019A0	D=10 ELASTIC CLAMP	17	PZ																																	
					VM1224A0	65MY 220MM COLOURS SHRINK TUBE	2 0.200	M																																	

COMPONENT			SPARE PART																														
Code	Description	Image	Code	Description	Components list																												
VL1065A	1/4 MALE N.O. PRESSURE SWITCH		KVL1065A	1/4 M N.O. CIL. PRESSURE SWITCH KIT	<table border="1"> <thead> <tr> <th>Code</th> <th>Description</th> <th>Qty</th> <th>UOM</th> </tr> </thead> <tbody> <tr> <td>VL1065A1</td> <td>1/4 MALE N.O. PRESSURE SWITCH</td> <td>1</td> <td>PZ</td> </tr> <tr> <td>VM1224A0</td> <td>65MY 220MM 2 COLOURS SHRINK TUBE</td> <td>0.150</td> <td>M</td> </tr> </tbody> </table>	Code	Description	Qty	UOM	VL1065A1	1/4 MALE N.O. PRESSURE SWITCH	1	PZ	VM1224A0	65MY 220MM 2 COLOURS SHRINK TUBE	0.150	M																
Code	Description	Qty	UOM																														
VL1065A1	1/4 MALE N.O. PRESSURE SWITCH	1	PZ																														
VM1224A0	65MY 220MM 2 COLOURS SHRINK TUBE	0.150	M																														
RC1356A	"STRAIGHT THREADED FEMALE END 8X1/4" BS		KRC1356A	STRAIGHT THREADED FEMALE END 8X1/4 BS	<table border="1"> <thead> <tr> <th>Code</th> <th>Description</th> <th>Qty</th> <th>UOM</th> </tr> </thead> <tbody> <tr> <td>RC1356A0</td> <td>"STRAIGHT THREADED FEMALE END 8X1/4" BS</td> <td>1</td> <td>PZ</td> </tr> <tr> <td>VM1224A0</td> <td>65MY 220MM 2 COLOURS SHRINK TUBE</td> <td>0.150</td> <td>M</td> </tr> </tbody> </table>	Code	Description	Qty	UOM	RC1356A0	"STRAIGHT THREADED FEMALE END 8X1/4" BS	1	PZ	VM1224A0	65MY 220MM 2 COLOURS SHRINK TUBE	0.150	M																
Code	Description	Qty	UOM																														
RC1356A0	"STRAIGHT THREADED FEMALE END 8X1/4" BS	1	PZ																														
VM1224A0	65MY 220MM 2 COLOURS SHRINK TUBE	0.150	M																														
RC1242A	D=10 CLOSED CAP		KRC1242A	Ø10 CLOSED CONNECTION 20PCS KIT	<table border="1"> <thead> <tr> <th>Code</th> <th>Description</th> <th>Qty</th> <th>UOM</th> </tr> </thead> <tbody> <tr> <td>RC1242A0</td> <td>D=10 CLOSED CAP</td> <td>20</td> <td>PZ</td> </tr> <tr> <td>VM1224A0</td> <td>65MY 220MM 2 COLOURS SHRINK TUBE</td> <td>0.200</td> <td>M</td> </tr> </tbody> </table>	Code	Description	Qty	UOM	RC1242A0	D=10 CLOSED CAP	20	PZ	VM1224A0	65MY 220MM 2 COLOURS SHRINK TUBE	0.200	M																
Code	Description	Qty	UOM																														
RC1242A0	D=10 CLOSED CAP	20	PZ																														
VM1224A0	65MY 220MM 2 COLOURS SHRINK TUBE	0.200	M																														
VL1174C	D1.2 MM CALIBRATED NOZZL		VL1174C0	D1.2 MM CALIBRATED NOZZL																													
VL1190A	PLUS WASHING SYSTEM INLET DISTRIBUTOR		KVL1209A	US PLUS 3 ROTOR ARMS WASHING SYSTEM KIT	<table border="1"> <thead> <tr> <th>Code</th> <th>Description</th> <th>Qty</th> <th>UOM</th> </tr> </thead> <tbody> <tr> <td>0H2354A0</td> <td>XEVC-XEVL WASHING CIRCUIT PLAT</td> <td>1</td> <td>PZ</td> </tr> <tr> <td>0H2411A0</td> <td></td> <td>1</td> <td>PZ</td> </tr> <tr> <td>EL1450A0</td> <td>US SELF-CLEANIN G WATER SOLENOID</td> <td>4</td> <td>PZ</td> </tr> <tr> <td>GN1526A0</td> <td>INT. D.=6.9 TH=1.8 O-RIN</td> <td>9</td> <td>PZ</td> </tr> <tr> <td>RC1018A0</td> <td>ZINC PLATED D12 ELASTIC CLAMP</td> <td>13</td> <td>PZ</td> </tr> <tr> <td>RC1019A0</td> <td>D=10 ELASTIC CLAMP</td> <td>15</td> <td>PZ</td> </tr> </tbody> </table>	Code	Description	Qty	UOM	0H2354A0	XEVC-XEVL WASHING CIRCUIT PLAT	1	PZ	0H2411A0		1	PZ	EL1450A0	US SELF-CLEANIN G WATER SOLENOID	4	PZ	GN1526A0	INT. D.=6.9 TH=1.8 O-RIN	9	PZ	RC1018A0	ZINC PLATED D12 ELASTIC CLAMP	13	PZ	RC1019A0	D=10 ELASTIC CLAMP	15	PZ
Code	Description	Qty	UOM																														
0H2354A0	XEVC-XEVL WASHING CIRCUIT PLAT	1	PZ																														
0H2411A0		1	PZ																														
EL1450A0	US SELF-CLEANIN G WATER SOLENOID	4	PZ																														
GN1526A0	INT. D.=6.9 TH=1.8 O-RIN	9	PZ																														
RC1018A0	ZINC PLATED D12 ELASTIC CLAMP	13	PZ																														
RC1019A0	D=10 ELASTIC CLAMP	15	PZ																														

COMPONENT			SPARE PART																																																																																						
Code	Description	Image	Code	Description	Components list																																																																																				
VL1190A	PLUS WASHING SYSTEM INLET DISTRIBUTOR		KVL1209A	US PLUS 3 ROTOR ARMS WASHING SYSTEM KIT	<table border="1"> <thead> <tr> <th>Code</th> <th>Description</th> <th>Qty</th> <th>UOM</th> </tr> </thead> <tbody> <tr> <td>RC1130A0</td> <td>130X2,6 CLAM</td> <td>1</td> <td>PZ</td> </tr> <tr> <td>RC1131A0</td> <td>200X2,6 BLACK CLAMP</td> <td>3</td> <td>PZ</td> </tr> <tr> <td>RC1242A0</td> <td>D=10 CLOSED CAP</td> <td>2</td> <td>PZ</td> </tr> <tr> <td>RC1356A0</td> <td>"STRAIGHT THREADED FEMALE END 8X1/4" BS</td> <td>1</td> <td>PZ</td> </tr> <tr> <td>TB2820A0</td> <td>6X10 EPDM PIPE FOR WASHING SYSTEM</td> <td>2.750</td> <td>M</td> </tr> <tr> <td>TB3132A0</td> <td>WHITE-BLUE EPDM TEXTILE BRAID HOSE 6X12</td> <td>1.980</td> <td>M</td> </tr> <tr> <td>VI1220A1</td> <td>4,2X12 TCB SELF-TAPPIN G SCREW</td> <td>3</td> <td>PZ</td> </tr> <tr> <td>VL1019A0</td> <td>VIBRATION PUMP</td> <td>1</td> <td>PZ</td> </tr> <tr> <td>VL1065A1</td> <td>1/4 MALE N.O. PRESSURE SWITCH</td> <td>1</td> <td>PZ</td> </tr> <tr> <td>VL1102A1</td> <td>DETERGENT LINE FILTER + BARBED VNR 6 MM</td> <td>1</td> <td>PZ</td> </tr> <tr> <td>VL1127A1</td> <td>6MM BARBED T-SHAPED FITTING</td> <td>2</td> <td>PZ</td> </tr> <tr> <td>VL1128A1</td> <td>D6 BARBED CHECK VALVE</td> <td>3</td> <td>PZ</td> </tr> <tr> <td>VL1165A0</td> <td>BB6-AR6 STRAIGHT FITTING</td> <td>1</td> <td>PZ</td> </tr> <tr> <td>VL1166A0</td> <td>BB6-AR6 L FITTING</td> <td>4</td> <td>PZ</td> </tr> <tr> <td>VL1167A0</td> <td></td> <td>1</td> <td>PZ</td> </tr> <tr> <td>VL1167A1</td> <td></td> <td>1</td> <td>PZ</td> </tr> <tr> <td>VL1167A2</td> <td>GN21 3 ROTOR ARMS B-B FLOW RESTRICTOR</td> <td>1</td> <td>PZ</td> </tr> <tr> <td>VL1174C0</td> <td>D1.2 MM CALIBRATED NOZZLE</td> <td>1</td> <td>PZ</td> </tr> <tr> <td>VL1185A0</td> <td>2 WAYS PLUS WASHING DISTRIBUTOR</td> <td>1</td> <td>PZ</td> </tr> <tr> <td>VL1186A0</td> <td>3 WAYS PLUS WASHING DISTRIBUTOR</td> <td>1</td> <td>PZ</td> </tr> </tbody> </table>	Code	Description	Qty	UOM	RC1130A0	130X2,6 CLAM	1	PZ	RC1131A0	200X2,6 BLACK CLAMP	3	PZ	RC1242A0	D=10 CLOSED CAP	2	PZ	RC1356A0	"STRAIGHT THREADED FEMALE END 8X1/4" BS	1	PZ	TB2820A0	6X10 EPDM PIPE FOR WASHING SYSTEM	2.750	M	TB3132A0	WHITE-BLUE EPDM TEXTILE BRAID HOSE 6X12	1.980	M	VI1220A1	4,2X12 TCB SELF-TAPPIN G SCREW	3	PZ	VL1019A0	VIBRATION PUMP	1	PZ	VL1065A1	1/4 MALE N.O. PRESSURE SWITCH	1	PZ	VL1102A1	DETERGENT LINE FILTER + BARBED VNR 6 MM	1	PZ	VL1127A1	6MM BARBED T-SHAPED FITTING	2	PZ	VL1128A1	D6 BARBED CHECK VALVE	3	PZ	VL1165A0	BB6-AR6 STRAIGHT FITTING	1	PZ	VL1166A0	BB6-AR6 L FITTING	4	PZ	VL1167A0		1	PZ	VL1167A1		1	PZ	VL1167A2	GN21 3 ROTOR ARMS B-B FLOW RESTRICTOR	1	PZ	VL1174C0	D1.2 MM CALIBRATED NOZZLE	1	PZ	VL1185A0	2 WAYS PLUS WASHING DISTRIBUTOR	1	PZ	VL1186A0	3 WAYS PLUS WASHING DISTRIBUTOR	1	PZ
					Code	Description	Qty	UOM																																																																																	
					RC1130A0	130X2,6 CLAM	1	PZ																																																																																	
					RC1131A0	200X2,6 BLACK CLAMP	3	PZ																																																																																	
					RC1242A0	D=10 CLOSED CAP	2	PZ																																																																																	
					RC1356A0	"STRAIGHT THREADED FEMALE END 8X1/4" BS	1	PZ																																																																																	
					TB2820A0	6X10 EPDM PIPE FOR WASHING SYSTEM	2.750	M																																																																																	
					TB3132A0	WHITE-BLUE EPDM TEXTILE BRAID HOSE 6X12	1.980	M																																																																																	
					VI1220A1	4,2X12 TCB SELF-TAPPIN G SCREW	3	PZ																																																																																	
					VL1019A0	VIBRATION PUMP	1	PZ																																																																																	
					VL1065A1	1/4 MALE N.O. PRESSURE SWITCH	1	PZ																																																																																	
					VL1102A1	DETERGENT LINE FILTER + BARBED VNR 6 MM	1	PZ																																																																																	
					VL1127A1	6MM BARBED T-SHAPED FITTING	2	PZ																																																																																	
					VL1128A1	D6 BARBED CHECK VALVE	3	PZ																																																																																	
					VL1165A0	BB6-AR6 STRAIGHT FITTING	1	PZ																																																																																	
					VL1166A0	BB6-AR6 L FITTING	4	PZ																																																																																	
					VL1167A0		1	PZ																																																																																	
					VL1167A1		1	PZ																																																																																	
					VL1167A2	GN21 3 ROTOR ARMS B-B FLOW RESTRICTOR	1	PZ																																																																																	
					VL1174C0	D1.2 MM CALIBRATED NOZZLE	1	PZ																																																																																	
VL1185A0	2 WAYS PLUS WASHING DISTRIBUTOR	1	PZ																																																																																						
VL1186A0	3 WAYS PLUS WASHING DISTRIBUTOR	1	PZ																																																																																						

COMPONENT			SPARE PART																																																																			
Code	Description	Image	Code	Description	Components list																																																																	
VL1190A	PLUS WASHING SYSTEM INLET DISTRIBUTOR		KVL1209A	US PLUS 3 ROTOR ARMS WASHING SYSTEM KIT	<table border="1"> <thead> <tr> <th>Code</th> <th>Description</th> <th>Qty</th> <th>UOM</th> </tr> </thead> <tbody> <tr> <td>VL1190A0</td> <td>PLUS WASHING SYSTEM INLET DISTRIBUTOR</td> <td>1</td> <td>PZ</td> </tr> <tr> <td>VM1605A0</td> <td>CLIP TWIST LOCK DIAM. 10,2-12,7 MM</td> <td>6</td> <td>PZ</td> </tr> <tr> <td>VM2172A0</td> <td>PUMP-WITH-CI RCUIT LOCKING PIN</td> <td>9</td> <td>PZ</td> </tr> </tbody> </table>	Code	Description	Qty	UOM	VL1190A0	PLUS WASHING SYSTEM INLET DISTRIBUTOR	1	PZ	VM1605A0	CLIP TWIST LOCK DIAM. 10,2-12,7 MM	6	PZ	VM2172A0	PUMP-WITH-CI RCUIT LOCKING PIN	9	PZ																																																	
			Code	Description	Qty	UOM																																																																
VL1190A0	PLUS WASHING SYSTEM INLET DISTRIBUTOR	1	PZ																																																																			
VM1605A0	CLIP TWIST LOCK DIAM. 10,2-12,7 MM	6	PZ																																																																			
VM2172A0	PUMP-WITH-CI RCUIT LOCKING PIN	9	PZ																																																																			
KVL1208A	US PLUS 2 ROTOR ARMS WASHING SYSTEM KIT	<table border="1"> <thead> <tr> <th>Code</th> <th>Description</th> <th>Qty</th> <th>UOM</th> </tr> </thead> <tbody> <tr> <td>0H2354A0</td> <td>XEVC-XEVL WASHING CIRCUIT PLAT</td> <td>1</td> <td>PZ</td> </tr> <tr> <td>0H2411A0</td> <td></td> <td>1</td> <td>PZ</td> </tr> <tr> <td>EL1450A0</td> <td>US SELF-CLEANIN G WATER SOLENOID</td> <td>4</td> <td>PZ</td> </tr> <tr> <td>GN1526A0</td> <td>INT. D.=6.9 TH=1.8 O-RIN</td> <td>9</td> <td>PZ</td> </tr> <tr> <td>RC1018A0</td> <td>ZINC PLATED D12 ELASTIC CLAMP</td> <td>4</td> <td>PZ</td> </tr> <tr> <td>RC1019A0</td> <td>D=10 ELASTIC CLAMP</td> <td>16</td> <td>PZ</td> </tr> <tr> <td>RC1130A0</td> <td>130X2,6 CLAM</td> <td>1</td> <td>PZ</td> </tr> <tr> <td>RC1131A0</td> <td>200X2,6 BLACK CLAMP</td> <td>3</td> <td>PZ</td> </tr> <tr> <td>RC1242A0</td> <td>D=10 CLOSED CAP</td> <td>2</td> <td>PZ</td> </tr> <tr> <td>RC1356A0</td> <td>*STRAIGHT THREADED FEMALE END 8X1/4" BS</td> <td>1</td> <td>PZ</td> </tr> <tr> <td>TB2820A0</td> <td>6X10 EPDM PIPE FOR WASHING SYSTEM</td> <td>2.890</td> <td>M</td> </tr> <tr> <td>TB3132A0</td> <td>WHITE-BLUE EPDM TEXTILE BRAID HOSE 6X12</td> <td>1.600</td> <td>M</td> </tr> <tr> <td>VI1220A1</td> <td>4,2X12 TCB SELF-TAPPIN G SCREW</td> <td>3</td> <td>PZ</td> </tr> <tr> <td>VL1019A0</td> <td>VIBRATION PUMP</td> <td>1</td> <td>PZ</td> </tr> <tr> <td>VL1047A1</td> <td>D6 PIPE HOLDER - D8 J.G. TERMINAL</td> <td>1</td> <td>PZ</td> </tr> <tr> <td>VL1065A1</td> <td>1/4 MALE N.O. PRESSURE SWITCH</td> <td>1</td> <td>PZ</td> </tr> </tbody> </table>	Code	Description	Qty	UOM	0H2354A0	XEVC-XEVL WASHING CIRCUIT PLAT	1	PZ	0H2411A0		1	PZ	EL1450A0	US SELF-CLEANIN G WATER SOLENOID	4	PZ	GN1526A0	INT. D.=6.9 TH=1.8 O-RIN	9	PZ	RC1018A0	ZINC PLATED D12 ELASTIC CLAMP	4	PZ	RC1019A0	D=10 ELASTIC CLAMP	16	PZ	RC1130A0	130X2,6 CLAM	1	PZ	RC1131A0	200X2,6 BLACK CLAMP	3	PZ	RC1242A0	D=10 CLOSED CAP	2	PZ	RC1356A0	*STRAIGHT THREADED FEMALE END 8X1/4" BS	1	PZ	TB2820A0	6X10 EPDM PIPE FOR WASHING SYSTEM	2.890	M	TB3132A0	WHITE-BLUE EPDM TEXTILE BRAID HOSE 6X12	1.600	M	VI1220A1	4,2X12 TCB SELF-TAPPIN G SCREW	3	PZ	VL1019A0	VIBRATION PUMP	1	PZ	VL1047A1	D6 PIPE HOLDER - D8 J.G. TERMINAL	1	PZ	VL1065A1	1/4 MALE N.O. PRESSURE SWITCH	1	PZ
Code	Description	Qty	UOM																																																																			
0H2354A0	XEVC-XEVL WASHING CIRCUIT PLAT	1	PZ																																																																			
0H2411A0		1	PZ																																																																			
EL1450A0	US SELF-CLEANIN G WATER SOLENOID	4	PZ																																																																			
GN1526A0	INT. D.=6.9 TH=1.8 O-RIN	9	PZ																																																																			
RC1018A0	ZINC PLATED D12 ELASTIC CLAMP	4	PZ																																																																			
RC1019A0	D=10 ELASTIC CLAMP	16	PZ																																																																			
RC1130A0	130X2,6 CLAM	1	PZ																																																																			
RC1131A0	200X2,6 BLACK CLAMP	3	PZ																																																																			
RC1242A0	D=10 CLOSED CAP	2	PZ																																																																			
RC1356A0	*STRAIGHT THREADED FEMALE END 8X1/4" BS	1	PZ																																																																			
TB2820A0	6X10 EPDM PIPE FOR WASHING SYSTEM	2.890	M																																																																			
TB3132A0	WHITE-BLUE EPDM TEXTILE BRAID HOSE 6X12	1.600	M																																																																			
VI1220A1	4,2X12 TCB SELF-TAPPIN G SCREW	3	PZ																																																																			
VL1019A0	VIBRATION PUMP	1	PZ																																																																			
VL1047A1	D6 PIPE HOLDER - D8 J.G. TERMINAL	1	PZ																																																																			
VL1065A1	1/4 MALE N.O. PRESSURE SWITCH	1	PZ																																																																			





COMPONENT			SPARE PART																																														
Code	Description	Image	Code	Description	Components list																																												
VL1190A	PLUS WASHING SYSTEM INLET DISTRIBUTOR		KVL1208A	US PLUS 2 ROTOR ARMS WASHING SYSTEM KIT	<table border="1"> <thead> <tr> <th>Code</th> <th>Description</th> <th>Qty</th> <th>UOM</th> </tr> </thead> <tbody> <tr> <td>VL1102A1</td> <td>DETERGENT LINE FILTER + BARBED VNR 6 MM</td> <td>1</td> <td>PZ</td> </tr> <tr> <td>VL1128A1</td> <td>D6 BARBED CHECK VALVE</td> <td>2</td> <td>PZ</td> </tr> <tr> <td>VL1141A1</td> <td>STRAIGHT CONNECT BB6-BB6</td> <td>1</td> <td>PZ</td> </tr> <tr> <td>VL1165A0</td> <td>BB6-AR6 STRAIGHT FITTING</td> <td>1</td> <td>PZ</td> </tr> <tr> <td>VL1166A0</td> <td>BB6-AR6 L FITTING</td> <td>4</td> <td>PZ</td> </tr> <tr> <td>VL1174C0</td> <td>D1.2 MM CALIBRATED NOZZLE</td> <td>1</td> <td>PZ</td> </tr> <tr> <td>VL1186A0</td> <td>3 WAYS PLUS WASHING DISTRIBUTOR</td> <td>1</td> <td>PZ</td> </tr> <tr> <td>VL1190A0</td> <td>PLUS WASHING SYSTEM INLET DISTRIBUTOR</td> <td>1</td> <td>PZ</td> </tr> <tr> <td>VM1605A0</td> <td>CLIP TWIST LOCK DIAM. 10,2-12,7 MM</td> <td>6</td> <td>PZ</td> </tr> <tr> <td>VM2172A0</td> <td>PUMP-WITH-CIRCUIT LOCKING PIN</td> <td>9</td> <td>PZ</td> </tr> </tbody> </table>	Code	Description	Qty	UOM	VL1102A1	DETERGENT LINE FILTER + BARBED VNR 6 MM	1	PZ	VL1128A1	D6 BARBED CHECK VALVE	2	PZ	VL1141A1	STRAIGHT CONNECT BB6-BB6	1	PZ	VL1165A0	BB6-AR6 STRAIGHT FITTING	1	PZ	VL1166A0	BB6-AR6 L FITTING	4	PZ	VL1174C0	D1.2 MM CALIBRATED NOZZLE	1	PZ	VL1186A0	3 WAYS PLUS WASHING DISTRIBUTOR	1	PZ	VL1190A0	PLUS WASHING SYSTEM INLET DISTRIBUTOR	1	PZ	VM1605A0	CLIP TWIST LOCK DIAM. 10,2-12,7 MM	6	PZ	VM2172A0	PUMP-WITH-CIRCUIT LOCKING PIN	9	PZ
			Code	Description	Qty	UOM																																											
VL1102A1	DETERGENT LINE FILTER + BARBED VNR 6 MM	1	PZ																																														
VL1128A1	D6 BARBED CHECK VALVE	2	PZ																																														
VL1141A1	STRAIGHT CONNECT BB6-BB6	1	PZ																																														
VL1165A0	BB6-AR6 STRAIGHT FITTING	1	PZ																																														
VL1166A0	BB6-AR6 L FITTING	4	PZ																																														
VL1174C0	D1.2 MM CALIBRATED NOZZLE	1	PZ																																														
VL1186A0	3 WAYS PLUS WASHING DISTRIBUTOR	1	PZ																																														
VL1190A0	PLUS WASHING SYSTEM INLET DISTRIBUTOR	1	PZ																																														
VM1605A0	CLIP TWIST LOCK DIAM. 10,2-12,7 MM	6	PZ																																														
VM2172A0	PUMP-WITH-CIRCUIT LOCKING PIN	9	PZ																																														
KVL1207A	US PLUS 1 ROTOR ARM WASHING SYSTEM KIT	<table border="1"> <thead> <tr> <th>Code</th> <th>Description</th> <th>Qty</th> <th>UOM</th> </tr> </thead> <tbody> <tr> <td>0H2354A0</td> <td>XEVC-XEVL WASHING CIRCUIT PLAT</td> <td>1</td> <td>PZ</td> </tr> <tr> <td>0H2411A0</td> <td></td> <td>1</td> <td>PZ</td> </tr> <tr> <td>EL1450A0</td> <td>US SELF-CLEANING WATER SOLENOID</td> <td>3</td> <td>PZ</td> </tr> <tr> <td>GN1526A0</td> <td>INT. D.=6.9 TH=1.8 O-RING</td> <td>7</td> <td>PZ</td> </tr> <tr> <td>RC1018A0</td> <td>ZINC PLATED D12 ELASTIC CLAMP</td> <td>3</td> <td>PZ</td> </tr> <tr> <td>RC1019A0</td> <td>D=10 ELASTIC CLAMP</td> <td>14</td> <td>PZ</td> </tr> <tr> <td>RC1130A0</td> <td>130X2.6 CLAMP</td> <td>1</td> <td>PZ</td> </tr> <tr> <td>RC1131A0</td> <td>200X2.6 BLACK CLAMP</td> <td>2</td> <td>PZ</td> </tr> <tr> <td>RC1242A0</td> <td>D=10 CLOSED CAP</td> <td>2</td> <td>PZ</td> </tr> </tbody> </table>	Code	Description	Qty	UOM	0H2354A0	XEVC-XEVL WASHING CIRCUIT PLAT	1	PZ	0H2411A0		1	PZ	EL1450A0	US SELF-CLEANING WATER SOLENOID	3	PZ	GN1526A0	INT. D.=6.9 TH=1.8 O-RING	7	PZ	RC1018A0	ZINC PLATED D12 ELASTIC CLAMP	3	PZ	RC1019A0	D=10 ELASTIC CLAMP	14	PZ	RC1130A0	130X2.6 CLAMP	1	PZ	RC1131A0	200X2.6 BLACK CLAMP	2	PZ	RC1242A0	D=10 CLOSED CAP	2	PZ							
Code	Description	Qty	UOM																																														
0H2354A0	XEVC-XEVL WASHING CIRCUIT PLAT	1	PZ																																														
0H2411A0		1	PZ																																														
EL1450A0	US SELF-CLEANING WATER SOLENOID	3	PZ																																														
GN1526A0	INT. D.=6.9 TH=1.8 O-RING	7	PZ																																														
RC1018A0	ZINC PLATED D12 ELASTIC CLAMP	3	PZ																																														
RC1019A0	D=10 ELASTIC CLAMP	14	PZ																																														
RC1130A0	130X2.6 CLAMP	1	PZ																																														
RC1131A0	200X2.6 BLACK CLAMP	2	PZ																																														
RC1242A0	D=10 CLOSED CAP	2	PZ																																														



COMPONENT			SPARE PART																																																																						
Code	Description	Image	Code	Description	Components list																																																																				
VL1190A	PLUS WASHING SYSTEM INLET DISTRIBUTOR		KVL1207A	US PLUS 1 ROTOR ARM WASHING SYSTEM KIT	<table border="1"> <thead> <tr> <th>Code</th> <th>Description</th> <th>Qty</th> <th>UOM</th> </tr> </thead> <tbody> <tr> <td>RC1356A0</td> <td>"STRAIGHT THREADED FEMALE END 8X1/4" BS</td> <td>1</td> <td>PZ</td> </tr> <tr> <td>TB2820A0</td> <td>6X10 EPDM PIPE FOR WASHING SYSTEM</td> <td>1.460</td> <td>M</td> </tr> <tr> <td>TB3132A0</td> <td>WHITE-BLUE EPDM TEXTILE BRAID HOSE 6X12</td> <td>0.770</td> <td>M</td> </tr> <tr> <td>VI1220A1</td> <td>4,2X12 TCB SELF-TAPPIN G SCREW</td> <td>3</td> <td>PZ</td> </tr> <tr> <td>VL1019A0</td> <td>VIBRATION PUMP</td> <td>1</td> <td>PZ</td> </tr> <tr> <td>VL1047A1</td> <td>D6 PIPE HOLDER - D8 J.G. TERMINAL</td> <td>1</td> <td>PZ</td> </tr> <tr> <td>VL1065A1</td> <td>1/4 MALE N.O. PRESSURE SWITCH</td> <td>1</td> <td>PZ</td> </tr> <tr> <td>VL1102A1</td> <td>DETERGENT LINE FILTER + BARBED VNR 6 MM</td> <td>1</td> <td>PZ</td> </tr> <tr> <td>VL1128A1</td> <td>D6 BARBED CHECK VALVE</td> <td>2</td> <td>PZ</td> </tr> <tr> <td>VL1165A0</td> <td>BB6-AR6 STRAIGHT FITTING</td> <td>1</td> <td>PZ</td> </tr> <tr> <td>VL1166A0</td> <td>BB6-AR6 L FITTING</td> <td>3</td> <td>PZ</td> </tr> <tr> <td>VL1174C0</td> <td>D1.2 MM CALIBRATED NOZZLE</td> <td>1</td> <td>PZ</td> </tr> <tr> <td>VL1185A0</td> <td>2 WAYS PLUS WASHING DISTRIBUTOR</td> <td>1</td> <td>PZ</td> </tr> <tr> <td>VL1190A0</td> <td>PLUS WASHING SYSTEM INLET DISTRIBUTOR</td> <td>1</td> <td>PZ</td> </tr> <tr> <td>VM1605A0</td> <td>CLIP TWIST LOCK DIAM. 10,2-12,7 MM</td> <td>6</td> <td>PZ</td> </tr> <tr> <td>VM2172A0</td> <td>PUMP-WITH-CI RCUIT LOCKING PIN</td> <td>6</td> <td>PZ</td> </tr> </tbody> </table>	Code	Description	Qty	UOM	RC1356A0	"STRAIGHT THREADED FEMALE END 8X1/4" BS	1	PZ	TB2820A0	6X10 EPDM PIPE FOR WASHING SYSTEM	1.460	M	TB3132A0	WHITE-BLUE EPDM TEXTILE BRAID HOSE 6X12	0.770	M	VI1220A1	4,2X12 TCB SELF-TAPPIN G SCREW	3	PZ	VL1019A0	VIBRATION PUMP	1	PZ	VL1047A1	D6 PIPE HOLDER - D8 J.G. TERMINAL	1	PZ	VL1065A1	1/4 MALE N.O. PRESSURE SWITCH	1	PZ	VL1102A1	DETERGENT LINE FILTER + BARBED VNR 6 MM	1	PZ	VL1128A1	D6 BARBED CHECK VALVE	2	PZ	VL1165A0	BB6-AR6 STRAIGHT FITTING	1	PZ	VL1166A0	BB6-AR6 L FITTING	3	PZ	VL1174C0	D1.2 MM CALIBRATED NOZZLE	1	PZ	VL1185A0	2 WAYS PLUS WASHING DISTRIBUTOR	1	PZ	VL1190A0	PLUS WASHING SYSTEM INLET DISTRIBUTOR	1	PZ	VM1605A0	CLIP TWIST LOCK DIAM. 10,2-12,7 MM	6	PZ	VM2172A0	PUMP-WITH-CI RCUIT LOCKING PIN	6	PZ
Code	Description	Qty	UOM																																																																						
RC1356A0	"STRAIGHT THREADED FEMALE END 8X1/4" BS	1	PZ																																																																						
TB2820A0	6X10 EPDM PIPE FOR WASHING SYSTEM	1.460	M																																																																						
TB3132A0	WHITE-BLUE EPDM TEXTILE BRAID HOSE 6X12	0.770	M																																																																						
VI1220A1	4,2X12 TCB SELF-TAPPIN G SCREW	3	PZ																																																																						
VL1019A0	VIBRATION PUMP	1	PZ																																																																						
VL1047A1	D6 PIPE HOLDER - D8 J.G. TERMINAL	1	PZ																																																																						
VL1065A1	1/4 MALE N.O. PRESSURE SWITCH	1	PZ																																																																						
VL1102A1	DETERGENT LINE FILTER + BARBED VNR 6 MM	1	PZ																																																																						
VL1128A1	D6 BARBED CHECK VALVE	2	PZ																																																																						
VL1165A0	BB6-AR6 STRAIGHT FITTING	1	PZ																																																																						
VL1166A0	BB6-AR6 L FITTING	3	PZ																																																																						
VL1174C0	D1.2 MM CALIBRATED NOZZLE	1	PZ																																																																						
VL1185A0	2 WAYS PLUS WASHING DISTRIBUTOR	1	PZ																																																																						
VL1190A0	PLUS WASHING SYSTEM INLET DISTRIBUTOR	1	PZ																																																																						
VM1605A0	CLIP TWIST LOCK DIAM. 10,2-12,7 MM	6	PZ																																																																						
VM2172A0	PUMP-WITH-CI RCUIT LOCKING PIN	6	PZ																																																																						

COMPONENT			SPARE PART																																																																																						
Code	Description	Image	Code	Description	Components list																																																																																				
VL1190A	PLUS WASHING SYSTEM INLET DISTRIBUTOR		KVL1187A	3 ROTOR ARMS PLUS EU CLEANING SYSTEM KIT	<table border="1"> <thead> <tr> <th>Code</th> <th>Description</th> <th>Qty</th> <th>UOM</th> </tr> </thead> <tbody> <tr> <td>0H2143A0</td> <td>LAMIERA BLOCCA VNR VL1128</td> <td>3</td> <td>PZ</td> </tr> <tr> <td>0H2168A0</td> <td></td> <td>1</td> <td>PZ</td> </tr> <tr> <td>0H2354A0</td> <td>XEVC-XEVL WASHING CIRCUIT PLAT</td> <td>1</td> <td>PZ</td> </tr> <tr> <td>EL1120A0</td> <td>D8-D6 FEMALE STRAIGHT INTERM. CONNECTION</td> <td>1</td> <td>PZ</td> </tr> <tr> <td>EL1220A0</td> <td>JG STRAIGHT CONNECTION Ø8F-Ø8F</td> <td>2</td> <td>PZ</td> </tr> <tr> <td>EL1440A0</td> <td>WATER SELF CLEANING VALVE</td> <td>4</td> <td>PZ</td> </tr> <tr> <td>GN1526A0</td> <td>INT. D.=6.9 TH=1.8 O-RIN</td> <td>9</td> <td>PZ</td> </tr> <tr> <td>RC1018A0</td> <td>ZINC PLATED D12 ELASTIC CLAMP</td> <td>10</td> <td>PZ</td> </tr> <tr> <td>RC1019A0</td> <td>D=10 ELASTIC CLAMP</td> <td>22</td> <td>PZ</td> </tr> <tr> <td>RC1130A0</td> <td>130X2,6 CLAM</td> <td>4</td> <td>PZ</td> </tr> <tr> <td>RC1131A0</td> <td>200X2.6 BLACK CLAMP</td> <td>3</td> <td>PZ</td> </tr> <tr> <td>RC1242A0</td> <td>D=10 CLOSED CAP</td> <td>2</td> <td>PZ</td> </tr> <tr> <td>RC1310A0</td> <td>140X4 CLAMP WITH CLIP</td> <td>1</td> <td>PZ</td> </tr> <tr> <td>RC1356A0</td> <td>"STRAIGHT THREADED FEMALE END 8X1/4" BS</td> <td>1</td> <td>PZ</td> </tr> <tr> <td>TB2820A0</td> <td>6X10 EPDM PIPE FOR WASHING SYSTEM</td> <td>1.510</td> <td>M</td> </tr> <tr> <td>TB3132A0</td> <td>WHITE-BLUE EPDM TEXTILE BRAID HOSE 6X12</td> <td>1.210</td> <td>M</td> </tr> <tr> <td>VI1220A1</td> <td>4,2X12 TCB SELF-TAPPIN G SCREW</td> <td>3</td> <td>PZ</td> </tr> <tr> <td>VL1019A0</td> <td>VIBRATION PUMP</td> <td>1</td> <td>PZ</td> </tr> <tr> <td>VL1046A1</td> <td>D6 PIPE HOLDER - D6 J.G. TERMINAL</td> <td>3</td> <td>PZ</td> </tr> <tr> <td>VL1047A1</td> <td>D6 PIPE HOLDER - D8 J.G. TERMINAL</td> <td>1</td> <td>PZ</td> </tr> </tbody> </table>	Code	Description	Qty	UOM	0H2143A0	LAMIERA BLOCCA VNR VL1128	3	PZ	0H2168A0		1	PZ	0H2354A0	XEVC-XEVL WASHING CIRCUIT PLAT	1	PZ	EL1120A0	D8-D6 FEMALE STRAIGHT INTERM. CONNECTION	1	PZ	EL1220A0	JG STRAIGHT CONNECTION Ø8F-Ø8F	2	PZ	EL1440A0	WATER SELF CLEANING VALVE	4	PZ	GN1526A0	INT. D.=6.9 TH=1.8 O-RIN	9	PZ	RC1018A0	ZINC PLATED D12 ELASTIC CLAMP	10	PZ	RC1019A0	D=10 ELASTIC CLAMP	22	PZ	RC1130A0	130X2,6 CLAM	4	PZ	RC1131A0	200X2.6 BLACK CLAMP	3	PZ	RC1242A0	D=10 CLOSED CAP	2	PZ	RC1310A0	140X4 CLAMP WITH CLIP	1	PZ	RC1356A0	"STRAIGHT THREADED FEMALE END 8X1/4" BS	1	PZ	TB2820A0	6X10 EPDM PIPE FOR WASHING SYSTEM	1.510	M	TB3132A0	WHITE-BLUE EPDM TEXTILE BRAID HOSE 6X12	1.210	M	VI1220A1	4,2X12 TCB SELF-TAPPIN G SCREW	3	PZ	VL1019A0	VIBRATION PUMP	1	PZ	VL1046A1	D6 PIPE HOLDER - D6 J.G. TERMINAL	3	PZ	VL1047A1	D6 PIPE HOLDER - D8 J.G. TERMINAL	1	PZ
Code	Description	Qty	UOM																																																																																						
0H2143A0	LAMIERA BLOCCA VNR VL1128	3	PZ																																																																																						
0H2168A0		1	PZ																																																																																						
0H2354A0	XEVC-XEVL WASHING CIRCUIT PLAT	1	PZ																																																																																						
EL1120A0	D8-D6 FEMALE STRAIGHT INTERM. CONNECTION	1	PZ																																																																																						
EL1220A0	JG STRAIGHT CONNECTION Ø8F-Ø8F	2	PZ																																																																																						
EL1440A0	WATER SELF CLEANING VALVE	4	PZ																																																																																						
GN1526A0	INT. D.=6.9 TH=1.8 O-RIN	9	PZ																																																																																						
RC1018A0	ZINC PLATED D12 ELASTIC CLAMP	10	PZ																																																																																						
RC1019A0	D=10 ELASTIC CLAMP	22	PZ																																																																																						
RC1130A0	130X2,6 CLAM	4	PZ																																																																																						
RC1131A0	200X2.6 BLACK CLAMP	3	PZ																																																																																						
RC1242A0	D=10 CLOSED CAP	2	PZ																																																																																						
RC1310A0	140X4 CLAMP WITH CLIP	1	PZ																																																																																						
RC1356A0	"STRAIGHT THREADED FEMALE END 8X1/4" BS	1	PZ																																																																																						
TB2820A0	6X10 EPDM PIPE FOR WASHING SYSTEM	1.510	M																																																																																						
TB3132A0	WHITE-BLUE EPDM TEXTILE BRAID HOSE 6X12	1.210	M																																																																																						
VI1220A1	4,2X12 TCB SELF-TAPPIN G SCREW	3	PZ																																																																																						
VL1019A0	VIBRATION PUMP	1	PZ																																																																																						
VL1046A1	D6 PIPE HOLDER - D6 J.G. TERMINAL	3	PZ																																																																																						
VL1047A1	D6 PIPE HOLDER - D8 J.G. TERMINAL	1	PZ																																																																																						

COMPONENT			SPARE PART																																																																																		
Code	Description	Image	Code	Description	Components list																																																																																
VL1190A	PLUS WASHING SYSTEM INLET DISTRIBUTOR		KVL1187A	3 ROTOR ARMS PLUS EU CLEANING SYSTEM KIT	<table border="1"> <thead> <tr> <th>Code</th> <th>Description</th> <th>Qty</th> <th>UOM</th> </tr> </thead> <tbody> <tr> <td>VL1064A0</td> <td>WASHING SYSTEM OUTLETS DISTRIBUTOR</td> <td>1</td> <td>PZ</td> </tr> <tr> <td>VL1065A1</td> <td>1/4 MALE N.O. PRESSURE SWITCH</td> <td>1</td> <td>PZ</td> </tr> <tr> <td>VL1067A0</td> <td>WASHING SYSTEM INLETS DISTRIBUTOR</td> <td>1</td> <td>PZ</td> </tr> <tr> <td>VL1092A0</td> <td>WASHING SYSTEM OUTLET DOUBLE DISTRIBUTOR</td> <td>1</td> <td>PZ</td> </tr> <tr> <td>VL1102A1</td> <td>DETERGENT LINE FILTER + BARBED VNR 6 MM</td> <td>1</td> <td>PZ</td> </tr> <tr> <td>VL1127A1</td> <td>6MM BARBED T-SHAPED FITTING</td> <td>2</td> <td>PZ</td> </tr> <tr> <td>VL1128A0</td> <td>D6 BARBED CHECK VALVE</td> <td>3</td> <td>PZ</td> </tr> <tr> <td>VL1128A1</td> <td>D6 BARBED CHECK VALVE</td> <td>3</td> <td>PZ</td> </tr> <tr> <td>VL1165A0</td> <td>BB6-AR6 STRAIGHT FITTING</td> <td>4</td> <td>PZ</td> </tr> <tr> <td>VL1166A0</td> <td>BB6-AR6 L FITTING</td> <td>4</td> <td>PZ</td> </tr> <tr> <td>VL1167A0</td> <td></td> <td>1</td> <td>PZ</td> </tr> <tr> <td>VL1167A1</td> <td></td> <td>1</td> <td>PZ</td> </tr> <tr> <td>VL1167A2</td> <td>GN21 3 ROTOR ARMS B-B FLOW RESTRICTOR</td> <td>1</td> <td>PZ</td> </tr> <tr> <td>VL1174C0</td> <td>D1.2 MM CALIBRATED NOZZLE</td> <td>1</td> <td>PZ</td> </tr> <tr> <td>VL1185A0</td> <td>2 WAYS PLUS WASHING DISTRIBUTOR</td> <td>1</td> <td>PZ</td> </tr> <tr> <td>VL1186A0</td> <td>3 WAYS PLUS WASHING DISTRIBUTOR</td> <td>1</td> <td>PZ</td> </tr> <tr> <td>VL1190A0</td> <td>PLUS WASHING SYSTEM INLET DISTRIBUTOR</td> <td>1</td> <td>PZ</td> </tr> <tr> <td>VM1605A0</td> <td>CLIP TWIST LOCK DIAM. 10.2-12.7 MM</td> <td>3</td> <td>PZ</td> </tr> <tr> <td>VM2172A0</td> <td>PUMP-WITH-CI RCUIT LOCKING PIN</td> <td>9</td> <td>PZ</td> </tr> </tbody> </table>	Code	Description	Qty	UOM	VL1064A0	WASHING SYSTEM OUTLETS DISTRIBUTOR	1	PZ	VL1065A1	1/4 MALE N.O. PRESSURE SWITCH	1	PZ	VL1067A0	WASHING SYSTEM INLETS DISTRIBUTOR	1	PZ	VL1092A0	WASHING SYSTEM OUTLET DOUBLE DISTRIBUTOR	1	PZ	VL1102A1	DETERGENT LINE FILTER + BARBED VNR 6 MM	1	PZ	VL1127A1	6MM BARBED T-SHAPED FITTING	2	PZ	VL1128A0	D6 BARBED CHECK VALVE	3	PZ	VL1128A1	D6 BARBED CHECK VALVE	3	PZ	VL1165A0	BB6-AR6 STRAIGHT FITTING	4	PZ	VL1166A0	BB6-AR6 L FITTING	4	PZ	VL1167A0		1	PZ	VL1167A1		1	PZ	VL1167A2	GN21 3 ROTOR ARMS B-B FLOW RESTRICTOR	1	PZ	VL1174C0	D1.2 MM CALIBRATED NOZZLE	1	PZ	VL1185A0	2 WAYS PLUS WASHING DISTRIBUTOR	1	PZ	VL1186A0	3 WAYS PLUS WASHING DISTRIBUTOR	1	PZ	VL1190A0	PLUS WASHING SYSTEM INLET DISTRIBUTOR	1	PZ	VM1605A0	CLIP TWIST LOCK DIAM. 10.2-12.7 MM	3	PZ	VM2172A0	PUMP-WITH-CI RCUIT LOCKING PIN	9	PZ
Code	Description	Qty	UOM																																																																																		
VL1064A0	WASHING SYSTEM OUTLETS DISTRIBUTOR	1	PZ																																																																																		
VL1065A1	1/4 MALE N.O. PRESSURE SWITCH	1	PZ																																																																																		
VL1067A0	WASHING SYSTEM INLETS DISTRIBUTOR	1	PZ																																																																																		
VL1092A0	WASHING SYSTEM OUTLET DOUBLE DISTRIBUTOR	1	PZ																																																																																		
VL1102A1	DETERGENT LINE FILTER + BARBED VNR 6 MM	1	PZ																																																																																		
VL1127A1	6MM BARBED T-SHAPED FITTING	2	PZ																																																																																		
VL1128A0	D6 BARBED CHECK VALVE	3	PZ																																																																																		
VL1128A1	D6 BARBED CHECK VALVE	3	PZ																																																																																		
VL1165A0	BB6-AR6 STRAIGHT FITTING	4	PZ																																																																																		
VL1166A0	BB6-AR6 L FITTING	4	PZ																																																																																		
VL1167A0		1	PZ																																																																																		
VL1167A1		1	PZ																																																																																		
VL1167A2	GN21 3 ROTOR ARMS B-B FLOW RESTRICTOR	1	PZ																																																																																		
VL1174C0	D1.2 MM CALIBRATED NOZZLE	1	PZ																																																																																		
VL1185A0	2 WAYS PLUS WASHING DISTRIBUTOR	1	PZ																																																																																		
VL1186A0	3 WAYS PLUS WASHING DISTRIBUTOR	1	PZ																																																																																		
VL1190A0	PLUS WASHING SYSTEM INLET DISTRIBUTOR	1	PZ																																																																																		
VM1605A0	CLIP TWIST LOCK DIAM. 10.2-12.7 MM	3	PZ																																																																																		
VM2172A0	PUMP-WITH-CI RCUIT LOCKING PIN	9	PZ																																																																																		

COMPONENT			SPARE PART																																																																																		
Code	Description	Image	Code	Description	Components list																																																																																
VL1190A	PLUS WASHING SYSTEM INLET DISTRIBUTOR		KVL1184A	2 ROTOR ARMS PLUS EU CLEANING SYSTEM KIT	<table border="1"> <thead> <tr> <th>Code</th> <th>Description</th> <th>Qty</th> <th>UOM</th> </tr> </thead> <tbody> <tr> <td>0H2143A0</td> <td>LAMIERA BLOCCA VNR VL1128</td> <td>2</td> <td>PZ</td> </tr> <tr> <td>0H2168A0</td> <td></td> <td>1</td> <td>PZ</td> </tr> <tr> <td>0H2354A0</td> <td>XEVC-XEVL WASHING CIRCUIT PLAT</td> <td>1</td> <td>PZ</td> </tr> <tr> <td>EL1220A0</td> <td>JG STRAIGHT CONNECTION Ø8F-Ø8F</td> <td>3</td> <td>PZ</td> </tr> <tr> <td>EL1440A0</td> <td>WATER SELF CLEANING VALVE</td> <td>4</td> <td>PZ</td> </tr> <tr> <td>GN1526A0</td> <td>INT. D.=6.9 TH=1.8 O-RIN</td> <td>9</td> <td>PZ</td> </tr> <tr> <td>RC1018A0</td> <td>ZINC PLATED D12 ELASTIC CLAMP</td> <td>2</td> <td>PZ</td> </tr> <tr> <td>RC1019A0</td> <td>D=10 ELASTIC CLAMP</td> <td>21</td> <td>PZ</td> </tr> <tr> <td>RC1130A0</td> <td>130X2,6 CLAM</td> <td>7</td> <td>PZ</td> </tr> <tr> <td>RC1131A0</td> <td>200X2.6 BLACK CLAMP</td> <td>3</td> <td>PZ</td> </tr> <tr> <td>RC1242A0</td> <td>D=10 CLOSED CAP</td> <td>2</td> <td>PZ</td> </tr> <tr> <td>RC1356A0</td> <td>"STRAIGHT THREADED FEMALE END 8X1/4" BS</td> <td>1</td> <td>PZ</td> </tr> <tr> <td>TB2820A0</td> <td>6X10 EPDM PIPE FOR WASHING SYSTEM</td> <td>2.400</td> <td>M</td> </tr> <tr> <td>TB3132A0</td> <td>WHITE-BLUE EPDM TEXTILE BRAID HOSE 6X12</td> <td>1.220</td> <td>M</td> </tr> <tr> <td>VL1019A0</td> <td>VIBRATION PUMP</td> <td>1</td> <td>PZ</td> </tr> <tr> <td>VL1046A1</td> <td>D6 PIPE HOLDER - D6 J.G. TERMINAL</td> <td>3</td> <td>PZ</td> </tr> <tr> <td>VL1047A1</td> <td>D6 PIPE HOLDER - D8 J.G. TERMINAL</td> <td>1</td> <td>PZ</td> </tr> <tr> <td>VL1065A1</td> <td>1/4 MALE N.O. PRESSURE SWITCH</td> <td>1</td> <td>PZ</td> </tr> <tr> <td>VL1067A0</td> <td>WASHING SYSTEM INLETS DISTRIBUTOR</td> <td>1</td> <td>PZ</td> </tr> </tbody> </table>	Code	Description	Qty	UOM	0H2143A0	LAMIERA BLOCCA VNR VL1128	2	PZ	0H2168A0		1	PZ	0H2354A0	XEVC-XEVL WASHING CIRCUIT PLAT	1	PZ	EL1220A0	JG STRAIGHT CONNECTION Ø8F-Ø8F	3	PZ	EL1440A0	WATER SELF CLEANING VALVE	4	PZ	GN1526A0	INT. D.=6.9 TH=1.8 O-RIN	9	PZ	RC1018A0	ZINC PLATED D12 ELASTIC CLAMP	2	PZ	RC1019A0	D=10 ELASTIC CLAMP	21	PZ	RC1130A0	130X2,6 CLAM	7	PZ	RC1131A0	200X2.6 BLACK CLAMP	3	PZ	RC1242A0	D=10 CLOSED CAP	2	PZ	RC1356A0	"STRAIGHT THREADED FEMALE END 8X1/4" BS	1	PZ	TB2820A0	6X10 EPDM PIPE FOR WASHING SYSTEM	2.400	M	TB3132A0	WHITE-BLUE EPDM TEXTILE BRAID HOSE 6X12	1.220	M	VL1019A0	VIBRATION PUMP	1	PZ	VL1046A1	D6 PIPE HOLDER - D6 J.G. TERMINAL	3	PZ	VL1047A1	D6 PIPE HOLDER - D8 J.G. TERMINAL	1	PZ	VL1065A1	1/4 MALE N.O. PRESSURE SWITCH	1	PZ	VL1067A0	WASHING SYSTEM INLETS DISTRIBUTOR	1	PZ
Code	Description	Qty	UOM																																																																																		
0H2143A0	LAMIERA BLOCCA VNR VL1128	2	PZ																																																																																		
0H2168A0		1	PZ																																																																																		
0H2354A0	XEVC-XEVL WASHING CIRCUIT PLAT	1	PZ																																																																																		
EL1220A0	JG STRAIGHT CONNECTION Ø8F-Ø8F	3	PZ																																																																																		
EL1440A0	WATER SELF CLEANING VALVE	4	PZ																																																																																		
GN1526A0	INT. D.=6.9 TH=1.8 O-RIN	9	PZ																																																																																		
RC1018A0	ZINC PLATED D12 ELASTIC CLAMP	2	PZ																																																																																		
RC1019A0	D=10 ELASTIC CLAMP	21	PZ																																																																																		
RC1130A0	130X2,6 CLAM	7	PZ																																																																																		
RC1131A0	200X2.6 BLACK CLAMP	3	PZ																																																																																		
RC1242A0	D=10 CLOSED CAP	2	PZ																																																																																		
RC1356A0	"STRAIGHT THREADED FEMALE END 8X1/4" BS	1	PZ																																																																																		
TB2820A0	6X10 EPDM PIPE FOR WASHING SYSTEM	2.400	M																																																																																		
TB3132A0	WHITE-BLUE EPDM TEXTILE BRAID HOSE 6X12	1.220	M																																																																																		
VL1019A0	VIBRATION PUMP	1	PZ																																																																																		
VL1046A1	D6 PIPE HOLDER - D6 J.G. TERMINAL	3	PZ																																																																																		
VL1047A1	D6 PIPE HOLDER - D8 J.G. TERMINAL	1	PZ																																																																																		
VL1065A1	1/4 MALE N.O. PRESSURE SWITCH	1	PZ																																																																																		
VL1067A0	WASHING SYSTEM INLETS DISTRIBUTOR	1	PZ																																																																																		







COMPONENT			SPARE PART																																																																																					
Code	Description	Image	Code	Description	Components list																																																																																			
VL1190A	PLUS WASHING SYSTEM INLET DISTRIBUTOR		KVL1184A	2 ROTOR ARMS PLUS EU CLEANING SYSTEM KIT	<table border="1"> <thead> <tr> <th>Code</th> <th>Description</th> <th>Qty</th> <th>UOM</th> </tr> </thead> <tbody> <tr> <td>VL1092A0</td> <td>WASHING SYSTEM OUTLET DOUBLE DISTRIBUTOR</td> <td>1</td> <td>PZ</td> </tr> <tr> <td>VL1102A1</td> <td>DETERGENT LINE FILTER + BARBED VNR 6 MM</td> <td>1</td> <td>PZ</td> </tr> <tr> <td>VL1128A0</td> <td>D6 BARBED CHECK VALVE</td> <td>2</td> <td>PZ</td> </tr> <tr> <td>VL1128A1</td> <td>D6 BARBED CHECK VALVE</td> <td>2</td> <td>PZ</td> </tr> <tr> <td>VL1141A1</td> <td>STRAIGHT CONNECT BB6-BB6</td> <td>1</td> <td>PZ</td> </tr> <tr> <td>VL1165A0</td> <td>BB6-AR6 STRAIGHT FITTING</td> <td>4</td> <td>PZ</td> </tr> <tr> <td>VL1166A0</td> <td>BB6-AR6 L FITTING</td> <td>4</td> <td>PZ</td> </tr> <tr> <td>VL1174C0</td> <td>D1.2 MM CALIBRATED NOZZLE</td> <td>1</td> <td>PZ</td> </tr> <tr> <td>VL1186A0</td> <td>3 WAYS PLUS WASHING DISTRIBUTOR</td> <td>1</td> <td>PZ</td> </tr> <tr> <td>VL1190A0</td> <td>PLUS WASHING SYSTEM INLET DISTRIBUTOR</td> <td>1</td> <td>PZ</td> </tr> <tr> <td>VM1605A0</td> <td>CLIP TWIST LOCK DIAM. 10,2-12,7 MM</td> <td>4</td> <td>PZ</td> </tr> <tr> <td>VM2172A0</td> <td>PUMP-WITH-CI RCUIT LOCKING PIN</td> <td>9</td> <td>PZ</td> </tr> </tbody> </table>	Code	Description	Qty	UOM	VL1092A0	WASHING SYSTEM OUTLET DOUBLE DISTRIBUTOR	1	PZ	VL1102A1	DETERGENT LINE FILTER + BARBED VNR 6 MM	1	PZ	VL1128A0	D6 BARBED CHECK VALVE	2	PZ	VL1128A1	D6 BARBED CHECK VALVE	2	PZ	VL1141A1	STRAIGHT CONNECT BB6-BB6	1	PZ	VL1165A0	BB6-AR6 STRAIGHT FITTING	4	PZ	VL1166A0	BB6-AR6 L FITTING	4	PZ	VL1174C0	D1.2 MM CALIBRATED NOZZLE	1	PZ	VL1186A0	3 WAYS PLUS WASHING DISTRIBUTOR	1	PZ	VL1190A0	PLUS WASHING SYSTEM INLET DISTRIBUTOR	1	PZ	VM1605A0	CLIP TWIST LOCK DIAM. 10,2-12,7 MM	4	PZ	VM2172A0	PUMP-WITH-CI RCUIT LOCKING PIN	9	PZ	KVL1183A	1 ROTOR ARM PLUS CLEANING SYSTEM KIT	<table border="1"> <thead> <tr> <th>Code</th> <th>Description</th> <th>Qty</th> <th>UOM</th> </tr> </thead> <tbody> <tr> <td>0H2143A0</td> <td>LAMIERA BLOCCA VNR VL1128</td> <td>2</td> <td>PZ</td> </tr> <tr> <td>0H2168A1</td> <td></td> <td>1</td> <td>PZ</td> </tr> <tr> <td>0H2354A0</td> <td>XEVC-XEVL WASHING CIRCUIT PLAT</td> <td>1</td> <td>PZ</td> </tr> <tr> <td>EL1440A0</td> <td>WATER SELF CLEANING VALVE</td> <td>3</td> <td>PZ</td> </tr> <tr> <td>GN1526A0</td> <td>INT. D.=6.9 TH=1.8 O-RIN</td> <td>7</td> <td>PZ</td> </tr> <tr> <td>RC1018A0</td> <td>ZINC PLATED D12 ELASTIC CLAMP</td> <td>2</td> <td>PZ</td> </tr> </tbody> </table>	Code	Description	Qty	UOM	0H2143A0	LAMIERA BLOCCA VNR VL1128	2	PZ	0H2168A1		1	PZ	0H2354A0	XEVC-XEVL WASHING CIRCUIT PLAT	1	PZ	EL1440A0	WATER SELF CLEANING VALVE	3	PZ	GN1526A0	INT. D.=6.9 TH=1.8 O-RIN	7	PZ	RC1018A0	ZINC PLATED D12 ELASTIC CLAMP	2	PZ
			Code	Description	Qty	UOM																																																																																		
VL1092A0	WASHING SYSTEM OUTLET DOUBLE DISTRIBUTOR	1	PZ																																																																																					
VL1102A1	DETERGENT LINE FILTER + BARBED VNR 6 MM	1	PZ																																																																																					
VL1128A0	D6 BARBED CHECK VALVE	2	PZ																																																																																					
VL1128A1	D6 BARBED CHECK VALVE	2	PZ																																																																																					
VL1141A1	STRAIGHT CONNECT BB6-BB6	1	PZ																																																																																					
VL1165A0	BB6-AR6 STRAIGHT FITTING	4	PZ																																																																																					
VL1166A0	BB6-AR6 L FITTING	4	PZ																																																																																					
VL1174C0	D1.2 MM CALIBRATED NOZZLE	1	PZ																																																																																					
VL1186A0	3 WAYS PLUS WASHING DISTRIBUTOR	1	PZ																																																																																					
VL1190A0	PLUS WASHING SYSTEM INLET DISTRIBUTOR	1	PZ																																																																																					
VM1605A0	CLIP TWIST LOCK DIAM. 10,2-12,7 MM	4	PZ																																																																																					
VM2172A0	PUMP-WITH-CI RCUIT LOCKING PIN	9	PZ																																																																																					
Code	Description	Qty	UOM																																																																																					
0H2143A0	LAMIERA BLOCCA VNR VL1128	2	PZ																																																																																					
0H2168A1		1	PZ																																																																																					
0H2354A0	XEVC-XEVL WASHING CIRCUIT PLAT	1	PZ																																																																																					
EL1440A0	WATER SELF CLEANING VALVE	3	PZ																																																																																					
GN1526A0	INT. D.=6.9 TH=1.8 O-RIN	7	PZ																																																																																					
RC1018A0	ZINC PLATED D12 ELASTIC CLAMP	2	PZ																																																																																					

COMPONENT			SPARE PART																																																																																		
Code	Description	Image	Code	Description	Components list																																																																																
VL1190A	PLUS WASHING SYSTEM INLET DISTRIBUTOR		KVL1183A	1 ROTOR ARM PLUS CLEANING SYSTEM KIT	<table border="1"> <thead> <tr> <th>Code</th> <th>Description</th> <th>Qty</th> <th>UOM</th> </tr> </thead> <tbody> <tr> <td>RC1019A0</td> <td>D=10 ELASTIC CLAMP</td> <td>14</td> <td>PZ</td> </tr> <tr> <td>RC1130A0</td> <td>130X2,6 CLAM</td> <td>5</td> <td>PZ</td> </tr> <tr> <td>RC1131A0</td> <td>200X2.6 BLACK CLAMP</td> <td>2</td> <td>PZ</td> </tr> <tr> <td>RC1242A0</td> <td>D=10 CLOSED CAP</td> <td>2</td> <td>PZ</td> </tr> <tr> <td>RC1356A0</td> <td>"STRAIGHT THREADED FEMALE END 8X1/4" BS</td> <td>1</td> <td>PZ</td> </tr> <tr> <td>TB2820A0</td> <td>6X10 EPDM PIPE FOR WASHING SYSTEM</td> <td>1.410</td> <td>M</td> </tr> <tr> <td>TB3132A0</td> <td>WHITE-BLUE EPDM TEXTILE BRAID HOSE 6X12</td> <td>0.770</td> <td>M</td> </tr> <tr> <td>VI1220A1</td> <td>4,2X12 TCB SELF-TAPPING SCREW</td> <td>3</td> <td>PZ</td> </tr> <tr> <td>VL1019A0</td> <td>VIBRATION PUMP</td> <td>1</td> <td>PZ</td> </tr> <tr> <td>VL1047A1</td> <td>D6 PIPE HOLDER - D8 J.G. TERMINAL</td> <td>1</td> <td>PZ</td> </tr> <tr> <td>VL1065A1</td> <td>1/4 MALE N.O. PRESSURE SWITCH</td> <td>1</td> <td>PZ</td> </tr> <tr> <td>VL1102A1</td> <td>DETERGENT LINE FILTER + BARBED VNR 6 MM</td> <td>1</td> <td>PZ</td> </tr> <tr> <td>VL1128A0</td> <td>D6 BARBED CHECK VALVE</td> <td>2</td> <td>PZ</td> </tr> <tr> <td>VL1128A1</td> <td>D6 BARBED CHECK VALVE</td> <td>2</td> <td>PZ</td> </tr> <tr> <td>VL1165A0</td> <td>BB6-AR6 STRAIGHT FITTING</td> <td>1</td> <td>PZ</td> </tr> <tr> <td>VL1166A0</td> <td>BB6-AR6 L FITTING</td> <td>3</td> <td>PZ</td> </tr> <tr> <td>VL1174C0</td> <td>D1.2 MM CALIBRATED NOZZLE</td> <td>1</td> <td>PZ</td> </tr> <tr> <td>VL1185A0</td> <td>2 WAYS PLUS WASHING DISTRIBUTOR</td> <td>1</td> <td>PZ</td> </tr> <tr> <td>VL1190A0</td> <td>PLUS WASHING SYSTEM INLET DISTRIBUTOR</td> <td>1</td> <td>PZ</td> </tr> </tbody> </table>	Code	Description	Qty	UOM	RC1019A0	D=10 ELASTIC CLAMP	14	PZ	RC1130A0	130X2,6 CLAM	5	PZ	RC1131A0	200X2.6 BLACK CLAMP	2	PZ	RC1242A0	D=10 CLOSED CAP	2	PZ	RC1356A0	"STRAIGHT THREADED FEMALE END 8X1/4" BS	1	PZ	TB2820A0	6X10 EPDM PIPE FOR WASHING SYSTEM	1.410	M	TB3132A0	WHITE-BLUE EPDM TEXTILE BRAID HOSE 6X12	0.770	M	VI1220A1	4,2X12 TCB SELF-TAPPING SCREW	3	PZ	VL1019A0	VIBRATION PUMP	1	PZ	VL1047A1	D6 PIPE HOLDER - D8 J.G. TERMINAL	1	PZ	VL1065A1	1/4 MALE N.O. PRESSURE SWITCH	1	PZ	VL1102A1	DETERGENT LINE FILTER + BARBED VNR 6 MM	1	PZ	VL1128A0	D6 BARBED CHECK VALVE	2	PZ	VL1128A1	D6 BARBED CHECK VALVE	2	PZ	VL1165A0	BB6-AR6 STRAIGHT FITTING	1	PZ	VL1166A0	BB6-AR6 L FITTING	3	PZ	VL1174C0	D1.2 MM CALIBRATED NOZZLE	1	PZ	VL1185A0	2 WAYS PLUS WASHING DISTRIBUTOR	1	PZ	VL1190A0	PLUS WASHING SYSTEM INLET DISTRIBUTOR	1	PZ
					Code	Description	Qty	UOM																																																																													
					RC1019A0	D=10 ELASTIC CLAMP	14	PZ																																																																													
					RC1130A0	130X2,6 CLAM	5	PZ																																																																													
					RC1131A0	200X2.6 BLACK CLAMP	2	PZ																																																																													
					RC1242A0	D=10 CLOSED CAP	2	PZ																																																																													
					RC1356A0	"STRAIGHT THREADED FEMALE END 8X1/4" BS	1	PZ																																																																													
					TB2820A0	6X10 EPDM PIPE FOR WASHING SYSTEM	1.410	M																																																																													
					TB3132A0	WHITE-BLUE EPDM TEXTILE BRAID HOSE 6X12	0.770	M																																																																													
					VI1220A1	4,2X12 TCB SELF-TAPPING SCREW	3	PZ																																																																													
					VL1019A0	VIBRATION PUMP	1	PZ																																																																													
					VL1047A1	D6 PIPE HOLDER - D8 J.G. TERMINAL	1	PZ																																																																													
					VL1065A1	1/4 MALE N.O. PRESSURE SWITCH	1	PZ																																																																													
					VL1102A1	DETERGENT LINE FILTER + BARBED VNR 6 MM	1	PZ																																																																													
					VL1128A0	D6 BARBED CHECK VALVE	2	PZ																																																																													
					VL1128A1	D6 BARBED CHECK VALVE	2	PZ																																																																													
					VL1165A0	BB6-AR6 STRAIGHT FITTING	1	PZ																																																																													
					VL1166A0	BB6-AR6 L FITTING	3	PZ																																																																													
					VL1174C0	D1.2 MM CALIBRATED NOZZLE	1	PZ																																																																													
					VL1185A0	2 WAYS PLUS WASHING DISTRIBUTOR	1	PZ																																																																													
VL1190A0	PLUS WASHING SYSTEM INLET DISTRIBUTOR	1	PZ																																																																																		



COMPONENT			SPARE PART																																																			
Code	Description	Image	Code	Description	Components list																																																	
VL1190A	PLUS WASHING SYSTEM INLET DISTRIBUTOR		KVL1183A	1 ROTOR ARM PLUS CLEANING SYSTEM KIT	<table border="1"> <thead> <tr> <th>Code</th> <th>Description</th> <th>Qty</th> <th>UOM</th> </tr> </thead> <tbody> <tr> <td>VM1605A0</td> <td>CLIP TWIST LOCK DIAM. 10,2-12,7 MM</td> <td>3</td> <td>PZ</td> </tr> <tr> <td>VM2172A0</td> <td>PUMP-WITH-RCUIT LOCKING PIN</td> <td>7</td> <td>PZ</td> </tr> </tbody> </table>	Code	Description	Qty	UOM	VM1605A0	CLIP TWIST LOCK DIAM. 10,2-12,7 MM	3	PZ	VM2172A0	PUMP-WITH-RCUIT LOCKING PIN	7	PZ																																					
			Code	Description	Qty	UOM																																																
			VM1605A0	CLIP TWIST LOCK DIAM. 10,2-12,7 MM	3	PZ																																																
VM2172A0	PUMP-WITH-RCUIT LOCKING PIN	7	PZ																																																			
KVL0684A	2-3 ROTOR ARM PLUS WASH PUMP+NOZZLE KIT	<table border="1"> <thead> <tr> <th>Code</th> <th>Description</th> <th>Qty</th> <th>UOM</th> </tr> </thead> <tbody> <tr> <td>GN1526A0</td> <td>INT. D.=6.9 TH=1.8 O-RIN</td> <td>4</td> <td>PZ</td> </tr> <tr> <td>RC1019A0</td> <td>D=10 ELASTIC CLAMP</td> <td>4</td> <td>PZ</td> </tr> <tr> <td>RC1130A0</td> <td>130X2,6 CLAM</td> <td>1</td> <td>PZ</td> </tr> <tr> <td>RC1131A0</td> <td>200X2,6 BLACK CLAMP</td> <td>3</td> <td>PZ</td> </tr> <tr> <td>RC1242A0</td> <td>D=10 CLOSED CAP</td> <td>2</td> <td>PZ</td> </tr> <tr> <td>TB2820A0</td> <td>6X10 EPDM PIPE FOR WASHING SYSTEM</td> <td>0.120</td> <td>M</td> </tr> <tr> <td>VL1019A0</td> <td>VIBRATION PUMP</td> <td>1</td> <td>PZ</td> </tr> <tr> <td>VL1128A1</td> <td>D6 BARBED CHECK VALVE</td> <td>1</td> <td>PZ</td> </tr> <tr> <td>VL1174C0</td> <td>D1.2 MM CALIBRATED NOZZLE</td> <td>1</td> <td>PZ</td> </tr> <tr> <td>VL1186A0</td> <td>3 WAYS PLUS WASHING DISTRIBUTOR</td> <td>1</td> <td>PZ</td> </tr> <tr> <td>VL1190A0</td> <td>PLUS WASHING SYSTEM INLET DISTRIBUTOR</td> <td>1</td> <td>PZ</td> </tr> <tr> <td>VM2172A0</td> <td>PUMP-WITH-RCUIT LOCKING PIN</td> <td>1</td> <td>PZ</td> </tr> </tbody> </table>	Code	Description	Qty	UOM	GN1526A0	INT. D.=6.9 TH=1.8 O-RIN	4	PZ	RC1019A0	D=10 ELASTIC CLAMP	4	PZ	RC1130A0	130X2,6 CLAM	1	PZ	RC1131A0	200X2,6 BLACK CLAMP	3	PZ	RC1242A0	D=10 CLOSED CAP	2	PZ	TB2820A0	6X10 EPDM PIPE FOR WASHING SYSTEM	0.120	M	VL1019A0	VIBRATION PUMP	1	PZ	VL1128A1	D6 BARBED CHECK VALVE	1	PZ	VL1174C0	D1.2 MM CALIBRATED NOZZLE	1	PZ	VL1186A0	3 WAYS PLUS WASHING DISTRIBUTOR	1	PZ	VL1190A0	PLUS WASHING SYSTEM INLET DISTRIBUTOR	1	PZ	VM2172A0	PUMP-WITH-RCUIT LOCKING PIN	1	PZ
Code	Description	Qty	UOM																																																			
GN1526A0	INT. D.=6.9 TH=1.8 O-RIN	4	PZ																																																			
RC1019A0	D=10 ELASTIC CLAMP	4	PZ																																																			
RC1130A0	130X2,6 CLAM	1	PZ																																																			
RC1131A0	200X2,6 BLACK CLAMP	3	PZ																																																			
RC1242A0	D=10 CLOSED CAP	2	PZ																																																			
TB2820A0	6X10 EPDM PIPE FOR WASHING SYSTEM	0.120	M																																																			
VL1019A0	VIBRATION PUMP	1	PZ																																																			
VL1128A1	D6 BARBED CHECK VALVE	1	PZ																																																			
VL1174C0	D1.2 MM CALIBRATED NOZZLE	1	PZ																																																			
VL1186A0	3 WAYS PLUS WASHING DISTRIBUTOR	1	PZ																																																			
VL1190A0	PLUS WASHING SYSTEM INLET DISTRIBUTOR	1	PZ																																																			
VM2172A0	PUMP-WITH-RCUIT LOCKING PIN	1	PZ																																																			
KVL0683A	1 ROTOR ARM PLUS WASH PUMP+NOZZLE KIT	<table border="1"> <thead> <tr> <th>Code</th> <th>Description</th> <th>Qty</th> <th>UOM</th> </tr> </thead> <tbody> <tr> <td>GN1526A0</td> <td>INT. D.=6.9 TH=1.8 O-RIN</td> <td>3</td> <td>PZ</td> </tr> <tr> <td>RC1019A0</td> <td>D=10 ELASTIC CLAMP</td> <td>4</td> <td>PZ</td> </tr> <tr> <td>RC1130A0</td> <td>130X2,6 CLAM</td> <td>1</td> <td>PZ</td> </tr> <tr> <td>RC1131A0</td> <td>200X2,6 BLACK CLAMP</td> <td>2</td> <td>PZ</td> </tr> <tr> <td>RC1242A0</td> <td>D=10 CLOSED CAP</td> <td>2</td> <td>PZ</td> </tr> <tr> <td>TB2820A0</td> <td>6X10 EPDM PIPE FOR WASHING SYSTEM</td> <td>0.120</td> <td>M</td> </tr> <tr> <td>VL1019A0</td> <td>VIBRATION PUMP</td> <td>1</td> <td>PZ</td> </tr> </tbody> </table>	Code	Description	Qty	UOM	GN1526A0	INT. D.=6.9 TH=1.8 O-RIN	3	PZ	RC1019A0	D=10 ELASTIC CLAMP	4	PZ	RC1130A0	130X2,6 CLAM	1	PZ	RC1131A0	200X2,6 BLACK CLAMP	2	PZ	RC1242A0	D=10 CLOSED CAP	2	PZ	TB2820A0	6X10 EPDM PIPE FOR WASHING SYSTEM	0.120	M	VL1019A0	VIBRATION PUMP	1	PZ																				
Code	Description	Qty	UOM																																																			
GN1526A0	INT. D.=6.9 TH=1.8 O-RIN	3	PZ																																																			
RC1019A0	D=10 ELASTIC CLAMP	4	PZ																																																			
RC1130A0	130X2,6 CLAM	1	PZ																																																			
RC1131A0	200X2,6 BLACK CLAMP	2	PZ																																																			
RC1242A0	D=10 CLOSED CAP	2	PZ																																																			
TB2820A0	6X10 EPDM PIPE FOR WASHING SYSTEM	0.120	M																																																			
VL1019A0	VIBRATION PUMP	1	PZ																																																			

COMPONENT			SPARE PART																																		
Code	Description	Image	Code	Description	Components list																																
VL1190A	PLUS WASHING SYSTEM INLET DISTRIBUTOR		KVL0683A	1 ROTOR ARM PLUS WASH PUMP+NOZZLE KIT	<table border="1"> <thead> <tr> <th>Code</th> <th>Description</th> <th>Qty</th> <th>UOM</th> </tr> </thead> <tbody> <tr> <td>VL1128A1</td> <td>D6 BARBED CHECK VALVE</td> <td>1</td> <td>PZ</td> </tr> <tr> <td>VL1174C0</td> <td>D1.2 MM CALIBRATED NOZZLE</td> <td>1</td> <td>PZ</td> </tr> <tr> <td>VL1185A0</td> <td>2 WAYS PLUS WASHING DISTRIBUTOR</td> <td>1</td> <td>PZ</td> </tr> <tr> <td>VL1190A0</td> <td>PLUS WASHING SYSTEM INLET DISTRIBUTOR</td> <td>1</td> <td>PZ</td> </tr> <tr> <td>VM2172A0</td> <td>PUMP-WITH-CI RCUIT LOCKING PIN</td> <td>1</td> <td>PZ</td> </tr> </tbody> </table>	Code	Description	Qty	UOM	VL1128A1	D6 BARBED CHECK VALVE	1	PZ	VL1174C0	D1.2 MM CALIBRATED NOZZLE	1	PZ	VL1185A0	2 WAYS PLUS WASHING DISTRIBUTOR	1	PZ	VL1190A0	PLUS WASHING SYSTEM INLET DISTRIBUTOR	1	PZ	VM2172A0	PUMP-WITH-CI RCUIT LOCKING PIN	1	PZ								
					Code	Description	Qty	UOM																													
					VL1128A1	D6 BARBED CHECK VALVE	1	PZ																													
					VL1174C0	D1.2 MM CALIBRATED NOZZLE	1	PZ																													
					VL1185A0	2 WAYS PLUS WASHING DISTRIBUTOR	1	PZ																													
VL1190A0	PLUS WASHING SYSTEM INLET DISTRIBUTOR	1	PZ																																		
VM2172A0	PUMP-WITH-CI RCUIT LOCKING PIN	1	PZ																																		
VL1128A	D6 BARBED CHECK VALVE		KVL1128A	D6 VNR BARBED VALVE KIT	<table border="1"> <thead> <tr> <th>Code</th> <th>Description</th> <th>Qty</th> <th>UOM</th> </tr> </thead> <tbody> <tr> <td>0H2143A0</td> <td>LAMIERA BLOCCA VNR VL1128</td> <td>1</td> <td>PZ</td> </tr> <tr> <td>RC1019A0</td> <td>D=10 ELASTIC CLAMP</td> <td>4</td> <td>PZ</td> </tr> <tr> <td>RC1130A0</td> <td>130X2,6 CLAM</td> <td>1</td> <td>PZ</td> </tr> <tr> <td>TB2820A0</td> <td>6X10 EPDM PIPE FOR WASHING SYSTEM</td> <td>0.080</td> <td>M</td> </tr> <tr> <td>VL1128A0</td> <td>D6 BARBED CHECK VALVE</td> <td>1</td> <td>PZ</td> </tr> <tr> <td>VL1128A1</td> <td>D6 BARBED CHECK VALVE</td> <td>1</td> <td>PZ</td> </tr> <tr> <td>VM1224A0</td> <td>65MY 220MM 2 COLOURS SHRINK TUBE</td> <td>0.200</td> <td>M</td> </tr> </tbody> </table>	Code	Description	Qty	UOM	0H2143A0	LAMIERA BLOCCA VNR VL1128	1	PZ	RC1019A0	D=10 ELASTIC CLAMP	4	PZ	RC1130A0	130X2,6 CLAM	1	PZ	TB2820A0	6X10 EPDM PIPE FOR WASHING SYSTEM	0.080	M	VL1128A0	D6 BARBED CHECK VALVE	1	PZ	VL1128A1	D6 BARBED CHECK VALVE	1	PZ	VM1224A0	65MY 220MM 2 COLOURS SHRINK TUBE	0.200	M
					Code	Description	Qty	UOM																													
					0H2143A0	LAMIERA BLOCCA VNR VL1128	1	PZ																													
					RC1019A0	D=10 ELASTIC CLAMP	4	PZ																													
					RC1130A0	130X2,6 CLAM	1	PZ																													
					TB2820A0	6X10 EPDM PIPE FOR WASHING SYSTEM	0.080	M																													
					VL1128A0	D6 BARBED CHECK VALVE	1	PZ																													
					VL1128A1	D6 BARBED CHECK VALVE	1	PZ																													
VM1224A0	65MY 220MM 2 COLOURS SHRINK TUBE	0.200	M																																		
VL1185A	2 WAYS PLUS WASHING DISTRIBUTOR		KVL1213A	US PLUS COMPACT WASHING SYSTEM KIT	<table border="1"> <thead> <tr> <th>Code</th> <th>Description</th> <th>Qty</th> <th>UOM</th> </tr> </thead> <tbody> <tr> <td>0H2428A0</td> <td></td> <td>1</td> <td>PZ</td> </tr> <tr> <td>EL1450A0</td> <td>US SELF-CLEANING WATER SOLENOID</td> <td>3</td> <td>PZ</td> </tr> <tr> <td>GN1312A0</td> <td>RUBBER CABLE-PASSING DE=26 DI=15 SP=10</td> <td>1</td> <td>PZ</td> </tr> <tr> <td>GN1526A0</td> <td>INT. D.=6.9 TH=1.8 O-RING</td> <td>7</td> <td>PZ</td> </tr> <tr> <td>RC1018A0</td> <td>ZINC PLATED D12 ELASTIC CLAMP</td> <td>3</td> <td>PZ</td> </tr> <tr> <td>RC1019A0</td> <td>D=10 ELASTIC CLAMP</td> <td>14</td> <td>PZ</td> </tr> <tr> <td>RC1130A0</td> <td>130X2,6 CLAM</td> <td>1</td> <td>PZ</td> </tr> </tbody> </table>	Code	Description	Qty	UOM	0H2428A0		1	PZ	EL1450A0	US SELF-CLEANING WATER SOLENOID	3	PZ	GN1312A0	RUBBER CABLE-PASSING DE=26 DI=15 SP=10	1	PZ	GN1526A0	INT. D.=6.9 TH=1.8 O-RING	7	PZ	RC1018A0	ZINC PLATED D12 ELASTIC CLAMP	3	PZ	RC1019A0	D=10 ELASTIC CLAMP	14	PZ	RC1130A0	130X2,6 CLAM	1	PZ
					Code	Description	Qty	UOM																													
					0H2428A0		1	PZ																													
					EL1450A0	US SELF-CLEANING WATER SOLENOID	3	PZ																													
					GN1312A0	RUBBER CABLE-PASSING DE=26 DI=15 SP=10	1	PZ																													
					GN1526A0	INT. D.=6.9 TH=1.8 O-RING	7	PZ																													
					RC1018A0	ZINC PLATED D12 ELASTIC CLAMP	3	PZ																													
					RC1019A0	D=10 ELASTIC CLAMP	14	PZ																													
					RC1130A0	130X2,6 CLAM	1	PZ																													

COMPONENT			SPARE PART					
Code	Description	Image	Code	Description	Components list			
VL1185A	2 WAYS PLUS WASHING DISTRIBUTOR		KVL1213A	US PLUS COMPACT WASHING SYSTEM KIT	Code	Description	Qty	UOM
					RC1131A0	200X2.6 BLACK CLAMP	1	PZ
					RC1242A0	D=10 CLOSED CAP	2	PZ
					RC1356A0	"STRAIGHT THREADED FEMALE END 8X1/4" BS	1	PZ
					TB2820A0	6X10 EPDM PIPE FOR WASHING SYSTEM	0.790	M
					TB3132A0	WHITE-BLUE EPDM TEXTILE BRAID HOSE 6X12	1.400	M
					VI1220A1	4,2X12 TCB SELF-TAPPING SCREW	3	PZ
					VL1019A0	VIBRATION PUMP	1	PZ
					VL1047A1	D6 PIPE HOLDER - D8 J.G. TERMINAL	1	PZ
					VL1054B0	ONE WASHING SYS INLET DISTRIBUTOR	1	PZ
					VL1065A1	1/4 MALE N.O. PRESSURE SWITCH	1	PZ
					VL1102A1	DETERGENT LINE FILTER + BARBED VNR 6 MM	1	PZ
					VL1128A1	D6 BARBED CHECK VALVE	2	PZ
					VL1165A0	BB6-AR6 STRAIGHT FITTING	1	PZ
					VL1166A0	BB6-AR6 L FITTING	3	PZ
					VL1174C0	D1.2 MM CALIBRATED NOZZLE	1	PZ
					VL1185A0	2 WAYS PLUS WASHING DISTRIBUTOR	1	PZ
VM2172A0	PUMP-WITH-CI RCUIT LOCKING PIN	6	PZ					

COMPONENT			SPARE PART																																																																																		
Code	Description	Image	Code	Description	Components list																																																																																
VL1185A	2 WAYS PLUS WASHING DISTRIBUTOR		KVL1212A	EUR COMPACT PLUS CLEANING SYSTEM KIT	<table border="1"> <thead> <tr> <th>Code</th> <th>Description</th> <th>Qty</th> <th>UOM</th> </tr> </thead> <tbody> <tr> <td>0H2428A0</td> <td></td> <td>1</td> <td>PZ</td> </tr> <tr> <td>EL1440A0</td> <td>WATER SELF CLEANING VALVE</td> <td>3</td> <td>PZ</td> </tr> <tr> <td>GN1312A0</td> <td>RUBBER CABLE-PASSI NG DE=26 DI=15 SP=10</td> <td>1</td> <td>PZ</td> </tr> <tr> <td>GN1526A0</td> <td>INT. D.=6.9 TH=1.8 O-RIN</td> <td>7</td> <td>PZ</td> </tr> <tr> <td>RC1018A0</td> <td>ZINC PLATED D12 ELASTIC CLAMP</td> <td>3</td> <td>PZ</td> </tr> <tr> <td>RC1019A0</td> <td>D=10 ELASTIC CLAMP</td> <td>14</td> <td>PZ</td> </tr> <tr> <td>RC1130A0</td> <td>130X2,6 CLAM</td> <td>1</td> <td>PZ</td> </tr> <tr> <td>RC1131A0</td> <td>200X2.6 BLACK CLAMP</td> <td>1</td> <td>PZ</td> </tr> <tr> <td>RC1242A0</td> <td>D=10 CLOSED CAP</td> <td>2</td> <td>PZ</td> </tr> <tr> <td>RC1356A0</td> <td>"STRAIGHT THREADED FEMALE END 8X1/4" BS</td> <td>1</td> <td>PZ</td> </tr> <tr> <td>TB2820A0</td> <td>6X10 EPDM PIPE FOR WASHING SYSTEM</td> <td>1.340</td> <td>M</td> </tr> <tr> <td>TB3132A0</td> <td>WHITE-BLUE EPDM TEXTILE BRAID HOSE 6X12</td> <td>1.400</td> <td>M</td> </tr> <tr> <td>VI1220A1</td> <td>4,2X12 TCB SELF-TAPPIN G SCREW</td> <td>3</td> <td>PZ</td> </tr> <tr> <td>VL1019A0</td> <td>VIBRATION PUMP</td> <td>1</td> <td>PZ</td> </tr> <tr> <td>VL1047A1</td> <td>D6 PIPE HOLDER - D8 J.G. TERMINAL</td> <td>1</td> <td>PZ</td> </tr> <tr> <td>VL1054B0</td> <td>ONE WASHING SYS INLET DISTRIBUTOR</td> <td>1</td> <td>PZ</td> </tr> <tr> <td>VL1065A1</td> <td>1/4 MALE N.O. PRESSURE SWITCH</td> <td>1</td> <td>PZ</td> </tr> <tr> <td>VL1102A1</td> <td>DETERGENT LINE FILTER + BARBED VNR 6 MM</td> <td>1</td> <td>PZ</td> </tr> <tr> <td>VL1128A1</td> <td>D6 BARBED CHECK VALVE</td> <td>2</td> <td>PZ</td> </tr> </tbody> </table>	Code	Description	Qty	UOM	0H2428A0		1	PZ	EL1440A0	WATER SELF CLEANING VALVE	3	PZ	GN1312A0	RUBBER CABLE-PASSI NG DE=26 DI=15 SP=10	1	PZ	GN1526A0	INT. D.=6.9 TH=1.8 O-RIN	7	PZ	RC1018A0	ZINC PLATED D12 ELASTIC CLAMP	3	PZ	RC1019A0	D=10 ELASTIC CLAMP	14	PZ	RC1130A0	130X2,6 CLAM	1	PZ	RC1131A0	200X2.6 BLACK CLAMP	1	PZ	RC1242A0	D=10 CLOSED CAP	2	PZ	RC1356A0	"STRAIGHT THREADED FEMALE END 8X1/4" BS	1	PZ	TB2820A0	6X10 EPDM PIPE FOR WASHING SYSTEM	1.340	M	TB3132A0	WHITE-BLUE EPDM TEXTILE BRAID HOSE 6X12	1.400	M	VI1220A1	4,2X12 TCB SELF-TAPPIN G SCREW	3	PZ	VL1019A0	VIBRATION PUMP	1	PZ	VL1047A1	D6 PIPE HOLDER - D8 J.G. TERMINAL	1	PZ	VL1054B0	ONE WASHING SYS INLET DISTRIBUTOR	1	PZ	VL1065A1	1/4 MALE N.O. PRESSURE SWITCH	1	PZ	VL1102A1	DETERGENT LINE FILTER + BARBED VNR 6 MM	1	PZ	VL1128A1	D6 BARBED CHECK VALVE	2	PZ
Code	Description	Qty	UOM																																																																																		
0H2428A0		1	PZ																																																																																		
EL1440A0	WATER SELF CLEANING VALVE	3	PZ																																																																																		
GN1312A0	RUBBER CABLE-PASSI NG DE=26 DI=15 SP=10	1	PZ																																																																																		
GN1526A0	INT. D.=6.9 TH=1.8 O-RIN	7	PZ																																																																																		
RC1018A0	ZINC PLATED D12 ELASTIC CLAMP	3	PZ																																																																																		
RC1019A0	D=10 ELASTIC CLAMP	14	PZ																																																																																		
RC1130A0	130X2,6 CLAM	1	PZ																																																																																		
RC1131A0	200X2.6 BLACK CLAMP	1	PZ																																																																																		
RC1242A0	D=10 CLOSED CAP	2	PZ																																																																																		
RC1356A0	"STRAIGHT THREADED FEMALE END 8X1/4" BS	1	PZ																																																																																		
TB2820A0	6X10 EPDM PIPE FOR WASHING SYSTEM	1.340	M																																																																																		
TB3132A0	WHITE-BLUE EPDM TEXTILE BRAID HOSE 6X12	1.400	M																																																																																		
VI1220A1	4,2X12 TCB SELF-TAPPIN G SCREW	3	PZ																																																																																		
VL1019A0	VIBRATION PUMP	1	PZ																																																																																		
VL1047A1	D6 PIPE HOLDER - D8 J.G. TERMINAL	1	PZ																																																																																		
VL1054B0	ONE WASHING SYS INLET DISTRIBUTOR	1	PZ																																																																																		
VL1065A1	1/4 MALE N.O. PRESSURE SWITCH	1	PZ																																																																																		
VL1102A1	DETERGENT LINE FILTER + BARBED VNR 6 MM	1	PZ																																																																																		
VL1128A1	D6 BARBED CHECK VALVE	2	PZ																																																																																		



COMPONENT			SPARE PART																																																															
Code	Description	Image	Code	Description	Components list																																																													
VL1185A	2 WAYS PLUS WASHING DISTRIBUTOR		KVL1212A	EUR COMPACT PLUS CLEANING SYSTEM KIT	<table border="1"> <thead> <tr> <th>Code</th> <th>Description</th> <th>Qty</th> <th>UOM</th> </tr> </thead> <tbody> <tr> <td>VL1165A0</td> <td>BB6-AR6 STRAIGHT FITTING</td> <td>1</td> <td>PZ</td> </tr> <tr> <td>VL1166A0</td> <td>BB6-AR6 L FITTING</td> <td>3</td> <td>PZ</td> </tr> <tr> <td>VL1174C0</td> <td>D1.2 MM CALIBRATED NOZZLE</td> <td>1</td> <td>PZ</td> </tr> <tr> <td>VL1185A0</td> <td>2 WAYS PLUS WASHING DISTRIBUTOR</td> <td>1</td> <td>PZ</td> </tr> <tr> <td>VM2172A0</td> <td>PUMP-WITH-CI RCUIT LOCKING PIN</td> <td>6</td> <td>PZ</td> </tr> </tbody> </table>	Code	Description	Qty	UOM	VL1165A0	BB6-AR6 STRAIGHT FITTING	1	PZ	VL1166A0	BB6-AR6 L FITTING	3	PZ	VL1174C0	D1.2 MM CALIBRATED NOZZLE	1	PZ	VL1185A0	2 WAYS PLUS WASHING DISTRIBUTOR	1	PZ	VM2172A0	PUMP-WITH-CI RCUIT LOCKING PIN	6	PZ																																					
			Code	Description	Qty	UOM																																																												
VL1165A0	BB6-AR6 STRAIGHT FITTING	1	PZ																																																															
VL1166A0	BB6-AR6 L FITTING	3	PZ																																																															
VL1174C0	D1.2 MM CALIBRATED NOZZLE	1	PZ																																																															
VL1185A0	2 WAYS PLUS WASHING DISTRIBUTOR	1	PZ																																																															
VM2172A0	PUMP-WITH-CI RCUIT LOCKING PIN	6	PZ																																																															
KVL1209A	US PLUS 3 ROTOR ARMS WASHING SYSTEM KIT	<table border="1"> <thead> <tr> <th>Code</th> <th>Description</th> <th>Qty</th> <th>UOM</th> </tr> </thead> <tbody> <tr> <td>0H2354A0</td> <td>XEVC-XEVL WASHING CIRCUIT PLAT</td> <td>1</td> <td>PZ</td> </tr> <tr> <td>0H2411A0</td> <td></td> <td>1</td> <td>PZ</td> </tr> <tr> <td>EL1450A0</td> <td>US SELF-CLEANIN G WATER SOLENOID</td> <td>4</td> <td>PZ</td> </tr> <tr> <td>GN1526A0</td> <td>INT. D.=6.9 TH=1.8 O-RIN</td> <td>9</td> <td>PZ</td> </tr> <tr> <td>RC1018A0</td> <td>ZINC PLATED D12 ELASTIC CLAMP</td> <td>13</td> <td>PZ</td> </tr> <tr> <td>RC1019A0</td> <td>D=10 ELASTIC CLAMP</td> <td>15</td> <td>PZ</td> </tr> <tr> <td>RC1130A0</td> <td>130X2,6 CLAM</td> <td>1</td> <td>PZ</td> </tr> <tr> <td>RC1131A0</td> <td>200X2.6 BLACK CLAMP</td> <td>3</td> <td>PZ</td> </tr> <tr> <td>RC1242A0</td> <td>D=10 CLOSED CAP</td> <td>2</td> <td>PZ</td> </tr> <tr> <td>RC1356A0</td> <td>"STRAIGHT THREADED FEMALE END 8X1/4" BS</td> <td>1</td> <td>PZ</td> </tr> <tr> <td>TB2820A0</td> <td>6X10 EPDM PIPE FOR WASHING SYSTEM</td> <td>2.750</td> <td>M</td> </tr> <tr> <td>TB3132A0</td> <td>WHITE-BLUE EPDM TEXTILE BRAID HOSE 6X12</td> <td>1.980</td> <td>M</td> </tr> <tr> <td>VI1220A1</td> <td>4,2X12 TCB SELF-TAPPIN G SCREW</td> <td>3</td> <td>PZ</td> </tr> <tr> <td>VL1019A0</td> <td>VIBRATION PUMP</td> <td>1</td> <td>PZ</td> </tr> <tr> <td>VL1065A1</td> <td>1/4 MALE N.O. PRESSURE SWITCH</td> <td>1</td> <td>PZ</td> </tr> </tbody> </table>	Code	Description	Qty	UOM	0H2354A0	XEVC-XEVL WASHING CIRCUIT PLAT	1	PZ	0H2411A0		1	PZ	EL1450A0	US SELF-CLEANIN G WATER SOLENOID	4	PZ	GN1526A0	INT. D.=6.9 TH=1.8 O-RIN	9	PZ	RC1018A0	ZINC PLATED D12 ELASTIC CLAMP	13	PZ	RC1019A0	D=10 ELASTIC CLAMP	15	PZ	RC1130A0	130X2,6 CLAM	1	PZ	RC1131A0	200X2.6 BLACK CLAMP	3	PZ	RC1242A0	D=10 CLOSED CAP	2	PZ	RC1356A0	"STRAIGHT THREADED FEMALE END 8X1/4" BS	1	PZ	TB2820A0	6X10 EPDM PIPE FOR WASHING SYSTEM	2.750	M	TB3132A0	WHITE-BLUE EPDM TEXTILE BRAID HOSE 6X12	1.980	M	VI1220A1	4,2X12 TCB SELF-TAPPIN G SCREW	3	PZ	VL1019A0	VIBRATION PUMP	1	PZ	VL1065A1	1/4 MALE N.O. PRESSURE SWITCH	1	PZ
Code	Description	Qty	UOM																																																															
0H2354A0	XEVC-XEVL WASHING CIRCUIT PLAT	1	PZ																																																															
0H2411A0		1	PZ																																																															
EL1450A0	US SELF-CLEANIN G WATER SOLENOID	4	PZ																																																															
GN1526A0	INT. D.=6.9 TH=1.8 O-RIN	9	PZ																																																															
RC1018A0	ZINC PLATED D12 ELASTIC CLAMP	13	PZ																																																															
RC1019A0	D=10 ELASTIC CLAMP	15	PZ																																																															
RC1130A0	130X2,6 CLAM	1	PZ																																																															
RC1131A0	200X2.6 BLACK CLAMP	3	PZ																																																															
RC1242A0	D=10 CLOSED CAP	2	PZ																																																															
RC1356A0	"STRAIGHT THREADED FEMALE END 8X1/4" BS	1	PZ																																																															
TB2820A0	6X10 EPDM PIPE FOR WASHING SYSTEM	2.750	M																																																															
TB3132A0	WHITE-BLUE EPDM TEXTILE BRAID HOSE 6X12	1.980	M																																																															
VI1220A1	4,2X12 TCB SELF-TAPPIN G SCREW	3	PZ																																																															
VL1019A0	VIBRATION PUMP	1	PZ																																																															
VL1065A1	1/4 MALE N.O. PRESSURE SWITCH	1	PZ																																																															



COMPONENT			SPARE PART																																																																																									
Code	Description	Image	Code	Description	Components list																																																																																							
VL1185A	2 WAYS PLUS WASHING DISTRIBUTOR		KVL1209A	US PLUS 3 ROTOR ARMS WASHING SYSTEM KIT	<table border="1"> <thead> <tr> <th>Code</th> <th>Description</th> <th>Qty</th> <th>UOM</th> </tr> </thead> <tbody> <tr> <td>VL1102A1</td> <td>DETERGENT LINE FILTER + BARBED VNR 6 MM</td> <td>1</td> <td>PZ</td> </tr> <tr> <td>VL1127A1</td> <td>6MM BARBED T-SHAPED FITTING</td> <td>2</td> <td>PZ</td> </tr> <tr> <td>VL1128A1</td> <td>D6 BARBED CHECK VALVE</td> <td>3</td> <td>PZ</td> </tr> <tr> <td>VL1165A0</td> <td>BB6-AR6 STRAIGHT FITTING</td> <td>1</td> <td>PZ</td> </tr> <tr> <td>VL1166A0</td> <td>BB6-AR6 L FITTING</td> <td>4</td> <td>PZ</td> </tr> <tr> <td>VL1167A0</td> <td></td> <td>1</td> <td>PZ</td> </tr> <tr> <td>VL1167A1</td> <td></td> <td>1</td> <td>PZ</td> </tr> <tr> <td>VL1167A2</td> <td>GN21 3 ROTOR ARMS B-B FLOW RESTRICTOR</td> <td>1</td> <td>PZ</td> </tr> <tr> <td>VL1174C0</td> <td>D1.2 MM CALIBRATED NOZZLE</td> <td>1</td> <td>PZ</td> </tr> <tr> <td>VL1185A0</td> <td>2 WAYS PLUS WASHING DISTRIBUTOR</td> <td>1</td> <td>PZ</td> </tr> <tr> <td>VL1186A0</td> <td>3 WAYS PLUS WASHING DISTRIBUTOR</td> <td>1</td> <td>PZ</td> </tr> <tr> <td>VL1190A0</td> <td>PLUS WASHING SYSTEM INLET DISTRIBUTOR</td> <td>1</td> <td>PZ</td> </tr> <tr> <td>VM1605A0</td> <td>CLIP TWIST LOCK DIAM. 10.2-12.7 MM</td> <td>6</td> <td>PZ</td> </tr> <tr> <td>VM2172A0</td> <td>PUMP-WITH-CIRCUIT LOCKING PIN</td> <td>9</td> <td>PZ</td> </tr> </tbody> </table>	Code	Description	Qty	UOM	VL1102A1	DETERGENT LINE FILTER + BARBED VNR 6 MM	1	PZ	VL1127A1	6MM BARBED T-SHAPED FITTING	2	PZ	VL1128A1	D6 BARBED CHECK VALVE	3	PZ	VL1165A0	BB6-AR6 STRAIGHT FITTING	1	PZ	VL1166A0	BB6-AR6 L FITTING	4	PZ	VL1167A0		1	PZ	VL1167A1		1	PZ	VL1167A2	GN21 3 ROTOR ARMS B-B FLOW RESTRICTOR	1	PZ	VL1174C0	D1.2 MM CALIBRATED NOZZLE	1	PZ	VL1185A0	2 WAYS PLUS WASHING DISTRIBUTOR	1	PZ	VL1186A0	3 WAYS PLUS WASHING DISTRIBUTOR	1	PZ	VL1190A0	PLUS WASHING SYSTEM INLET DISTRIBUTOR	1	PZ	VM1605A0	CLIP TWIST LOCK DIAM. 10.2-12.7 MM	6	PZ	VM2172A0	PUMP-WITH-CIRCUIT LOCKING PIN	9	PZ	KVL1207A	US PLUS 1 ROTOR ARM WASHING SYSTEM KIT	<table border="1"> <thead> <tr> <th>Code</th> <th>Description</th> <th>Qty</th> <th>UOM</th> </tr> </thead> <tbody> <tr> <td>0H2354A0</td> <td>XEVC-XEVL WASHING CIRCUIT PLAT</td> <td>1</td> <td>PZ</td> </tr> <tr> <td>0H2411A0</td> <td></td> <td>1</td> <td>PZ</td> </tr> <tr> <td>EL1450A0</td> <td>US SELF-CLEANING WATER SOLENOID</td> <td>3</td> <td>PZ</td> </tr> <tr> <td>GN1526A0</td> <td>INT. D.=6.9 TH=1.8 O-RING</td> <td>7</td> <td>PZ</td> </tr> <tr> <td>RC1018A0</td> <td>ZINC PLATED D12 ELASTIC CLAMP</td> <td>3</td> <td>PZ</td> </tr> </tbody> </table>	Code	Description	Qty	UOM	0H2354A0	XEVC-XEVL WASHING CIRCUIT PLAT	1	PZ	0H2411A0		1	PZ	EL1450A0	US SELF-CLEANING WATER SOLENOID	3	PZ	GN1526A0	INT. D.=6.9 TH=1.8 O-RING	7	PZ	RC1018A0	ZINC PLATED D12 ELASTIC CLAMP	3	PZ
			Code	Description	Qty	UOM																																																																																						
VL1102A1	DETERGENT LINE FILTER + BARBED VNR 6 MM	1	PZ																																																																																									
VL1127A1	6MM BARBED T-SHAPED FITTING	2	PZ																																																																																									
VL1128A1	D6 BARBED CHECK VALVE	3	PZ																																																																																									
VL1165A0	BB6-AR6 STRAIGHT FITTING	1	PZ																																																																																									
VL1166A0	BB6-AR6 L FITTING	4	PZ																																																																																									
VL1167A0		1	PZ																																																																																									
VL1167A1		1	PZ																																																																																									
VL1167A2	GN21 3 ROTOR ARMS B-B FLOW RESTRICTOR	1	PZ																																																																																									
VL1174C0	D1.2 MM CALIBRATED NOZZLE	1	PZ																																																																																									
VL1185A0	2 WAYS PLUS WASHING DISTRIBUTOR	1	PZ																																																																																									
VL1186A0	3 WAYS PLUS WASHING DISTRIBUTOR	1	PZ																																																																																									
VL1190A0	PLUS WASHING SYSTEM INLET DISTRIBUTOR	1	PZ																																																																																									
VM1605A0	CLIP TWIST LOCK DIAM. 10.2-12.7 MM	6	PZ																																																																																									
VM2172A0	PUMP-WITH-CIRCUIT LOCKING PIN	9	PZ																																																																																									
Code	Description	Qty	UOM																																																																																									
0H2354A0	XEVC-XEVL WASHING CIRCUIT PLAT	1	PZ																																																																																									
0H2411A0		1	PZ																																																																																									
EL1450A0	US SELF-CLEANING WATER SOLENOID	3	PZ																																																																																									
GN1526A0	INT. D.=6.9 TH=1.8 O-RING	7	PZ																																																																																									
RC1018A0	ZINC PLATED D12 ELASTIC CLAMP	3	PZ																																																																																									







COMPONENT			SPARE PART																																																																																						
Code	Description	Image	Code	Description	Components list																																																																																				
VL1185A	2 WAYS PLUS WASHING DISTRIBUTOR		KVL1207A	US PLUS 1 ROTOR ARM WASHING SYSTEM KIT	<table border="1"> <thead> <tr> <th>Code</th> <th>Description</th> <th>Qty</th> <th>UOM</th> </tr> </thead> <tbody> <tr> <td>RC1019A0</td> <td>D=10 ELASTIC CLAMP</td> <td>14</td> <td>PZ</td> </tr> <tr> <td>RC1130A0</td> <td>130X2,6 CLAM</td> <td>1</td> <td>PZ</td> </tr> <tr> <td>RC1131A0</td> <td>200X2.6 BLACK CLAMP</td> <td>2</td> <td>PZ</td> </tr> <tr> <td>RC1242A0</td> <td>D=10 CLOSED CAP</td> <td>2</td> <td>PZ</td> </tr> <tr> <td>RC1356A0</td> <td>"STRAIGHT THREADED FEMALE END 8X1/4" BS</td> <td>1</td> <td>PZ</td> </tr> <tr> <td>TB2820A0</td> <td>6X10 EPDM PIPE FOR WASHING SYSTEM</td> <td>1.460</td> <td>M</td> </tr> <tr> <td>TB3132A0</td> <td>WHITE-BLUE EPDM TEXTILE BRAID HOSE 6X12</td> <td>0.770</td> <td>M</td> </tr> <tr> <td>VI1220A1</td> <td>4,2X12 TCB SELF-TAPPING SCREW</td> <td>3</td> <td>PZ</td> </tr> <tr> <td>VL1019A0</td> <td>VIBRATION PUMP</td> <td>1</td> <td>PZ</td> </tr> <tr> <td>VL1047A1</td> <td>D6 PIPE HOLDER - D8 J.G. TERMINAL</td> <td>1</td> <td>PZ</td> </tr> <tr> <td>VL1065A1</td> <td>1/4 MALE N.O. PRESSURE SWITCH</td> <td>1</td> <td>PZ</td> </tr> <tr> <td>VL1102A1</td> <td>DETERGENT LINE FILTER + BARBED VNR 6 MM</td> <td>1</td> <td>PZ</td> </tr> <tr> <td>VL1128A1</td> <td>D6 BARBED CHECK VALVE</td> <td>2</td> <td>PZ</td> </tr> <tr> <td>VL1165A0</td> <td>BB6-AR6 STRAIGHT FITTING</td> <td>1</td> <td>PZ</td> </tr> <tr> <td>VL1166A0</td> <td>BB6-AR6 L FITTING</td> <td>3</td> <td>PZ</td> </tr> <tr> <td>VL1174C0</td> <td>D1.2 MM CALIBRATED NOZZLE</td> <td>1</td> <td>PZ</td> </tr> <tr> <td>VL1185A0</td> <td>2 WAYS PLUS WASHING DISTRIBUTOR</td> <td>1</td> <td>PZ</td> </tr> <tr> <td>VL1190A0</td> <td>PLUS WASHING SYSTEM INLET DISTRIBUTOR</td> <td>1</td> <td>PZ</td> </tr> <tr> <td>VM1605A0</td> <td>CLIP TWIST LOCK DIAM. 10,2-12,7 MM</td> <td>6</td> <td>PZ</td> </tr> <tr> <td>VM2172A0</td> <td>PUMP-WITH-CLIP RCUIT LOCKING PIN</td> <td>6</td> <td>PZ</td> </tr> </tbody> </table>	Code	Description	Qty	UOM	RC1019A0	D=10 ELASTIC CLAMP	14	PZ	RC1130A0	130X2,6 CLAM	1	PZ	RC1131A0	200X2.6 BLACK CLAMP	2	PZ	RC1242A0	D=10 CLOSED CAP	2	PZ	RC1356A0	"STRAIGHT THREADED FEMALE END 8X1/4" BS	1	PZ	TB2820A0	6X10 EPDM PIPE FOR WASHING SYSTEM	1.460	M	TB3132A0	WHITE-BLUE EPDM TEXTILE BRAID HOSE 6X12	0.770	M	VI1220A1	4,2X12 TCB SELF-TAPPING SCREW	3	PZ	VL1019A0	VIBRATION PUMP	1	PZ	VL1047A1	D6 PIPE HOLDER - D8 J.G. TERMINAL	1	PZ	VL1065A1	1/4 MALE N.O. PRESSURE SWITCH	1	PZ	VL1102A1	DETERGENT LINE FILTER + BARBED VNR 6 MM	1	PZ	VL1128A1	D6 BARBED CHECK VALVE	2	PZ	VL1165A0	BB6-AR6 STRAIGHT FITTING	1	PZ	VL1166A0	BB6-AR6 L FITTING	3	PZ	VL1174C0	D1.2 MM CALIBRATED NOZZLE	1	PZ	VL1185A0	2 WAYS PLUS WASHING DISTRIBUTOR	1	PZ	VL1190A0	PLUS WASHING SYSTEM INLET DISTRIBUTOR	1	PZ	VM1605A0	CLIP TWIST LOCK DIAM. 10,2-12,7 MM	6	PZ	VM2172A0	PUMP-WITH-CLIP RCUIT LOCKING PIN	6	PZ
Code	Description	Qty	UOM																																																																																						
RC1019A0	D=10 ELASTIC CLAMP	14	PZ																																																																																						
RC1130A0	130X2,6 CLAM	1	PZ																																																																																						
RC1131A0	200X2.6 BLACK CLAMP	2	PZ																																																																																						
RC1242A0	D=10 CLOSED CAP	2	PZ																																																																																						
RC1356A0	"STRAIGHT THREADED FEMALE END 8X1/4" BS	1	PZ																																																																																						
TB2820A0	6X10 EPDM PIPE FOR WASHING SYSTEM	1.460	M																																																																																						
TB3132A0	WHITE-BLUE EPDM TEXTILE BRAID HOSE 6X12	0.770	M																																																																																						
VI1220A1	4,2X12 TCB SELF-TAPPING SCREW	3	PZ																																																																																						
VL1019A0	VIBRATION PUMP	1	PZ																																																																																						
VL1047A1	D6 PIPE HOLDER - D8 J.G. TERMINAL	1	PZ																																																																																						
VL1065A1	1/4 MALE N.O. PRESSURE SWITCH	1	PZ																																																																																						
VL1102A1	DETERGENT LINE FILTER + BARBED VNR 6 MM	1	PZ																																																																																						
VL1128A1	D6 BARBED CHECK VALVE	2	PZ																																																																																						
VL1165A0	BB6-AR6 STRAIGHT FITTING	1	PZ																																																																																						
VL1166A0	BB6-AR6 L FITTING	3	PZ																																																																																						
VL1174C0	D1.2 MM CALIBRATED NOZZLE	1	PZ																																																																																						
VL1185A0	2 WAYS PLUS WASHING DISTRIBUTOR	1	PZ																																																																																						
VL1190A0	PLUS WASHING SYSTEM INLET DISTRIBUTOR	1	PZ																																																																																						
VM1605A0	CLIP TWIST LOCK DIAM. 10,2-12,7 MM	6	PZ																																																																																						
VM2172A0	PUMP-WITH-CLIP RCUIT LOCKING PIN	6	PZ																																																																																						



COMPONENT			SPARE PART																																																																																						
Code	Description	Image	Code	Description	Components list																																																																																				
VL1185A	2 WAYS PLUS WASHING DISTRIBUTOR		KVL1183A	1 ROTOR ARM PLUS CLEANING SYSTEM KIT	<table border="1"> <thead> <tr> <th>Code</th> <th>Description</th> <th>Qty</th> <th>UOM</th> </tr> </thead> <tbody> <tr> <td>0H2143A0</td> <td>LAMIERA BLOCCA VNR VL1128</td> <td>2</td> <td>PZ</td> </tr> <tr> <td>0H2168A1</td> <td></td> <td>1</td> <td>PZ</td> </tr> <tr> <td>0H2354A0</td> <td>XEVC-XEVL WASHING CIRCUIT PLAT</td> <td>1</td> <td>PZ</td> </tr> <tr> <td>EL1440A0</td> <td>WATER SELF CLEANING VALVE</td> <td>3</td> <td>PZ</td> </tr> <tr> <td>GN1526A0</td> <td>INT. D.=6.9 TH=1.8 O-RIN</td> <td>7</td> <td>PZ</td> </tr> <tr> <td>RC1018A0</td> <td>ZINC PLATED D12 ELASTIC CLAMP</td> <td>2</td> <td>PZ</td> </tr> <tr> <td>RC1019A0</td> <td>D=10 ELASTIC CLAMP</td> <td>14</td> <td>PZ</td> </tr> <tr> <td>RC1130A0</td> <td>130X2,6 CLAM</td> <td>5</td> <td>PZ</td> </tr> <tr> <td>RC1131A0</td> <td>200X2.6 BLACK CLAMP</td> <td>2</td> <td>PZ</td> </tr> <tr> <td>RC1242A0</td> <td>D=10 CLOSED CAP</td> <td>2</td> <td>PZ</td> </tr> <tr> <td>RC1356A0</td> <td>"STRAIGHT THREADED FEMALE END 8X1/4" BS</td> <td>1</td> <td>PZ</td> </tr> <tr> <td>TB2820A0</td> <td>6X10 EPDM PIPE FOR WASHING SYSTEM</td> <td>1.410</td> <td>M</td> </tr> <tr> <td>TB3132A0</td> <td>WHITE-BLUE EPDM TEXTILE BRAID HOSE 6X12</td> <td>0.770</td> <td>M</td> </tr> <tr> <td>VH1220A1</td> <td>4,2X12 TCB SELF-TAPPIN G SCREW</td> <td>3</td> <td>PZ</td> </tr> <tr> <td>VL1019A0</td> <td>VIBRATION PUMP</td> <td>1</td> <td>PZ</td> </tr> <tr> <td>VL1047A1</td> <td>D6 PIPE HOLDER - D8 J.G. TERMINAL</td> <td>1</td> <td>PZ</td> </tr> <tr> <td>VL1065A1</td> <td>1/4 MALE N.O. PRESSURE SWITCH</td> <td>1</td> <td>PZ</td> </tr> <tr> <td>VL1102A1</td> <td>DETERGENT LINE FILTER + BARBED VNR 6 MM</td> <td>1</td> <td>PZ</td> </tr> <tr> <td>VL1128A0</td> <td>D6 BARBED CHECK VALVE</td> <td>2</td> <td>PZ</td> </tr> <tr> <td>VL1128A1</td> <td>D6 BARBED CHECK VALVE</td> <td>2</td> <td>PZ</td> </tr> </tbody> </table>	Code	Description	Qty	UOM	0H2143A0	LAMIERA BLOCCA VNR VL1128	2	PZ	0H2168A1		1	PZ	0H2354A0	XEVC-XEVL WASHING CIRCUIT PLAT	1	PZ	EL1440A0	WATER SELF CLEANING VALVE	3	PZ	GN1526A0	INT. D.=6.9 TH=1.8 O-RIN	7	PZ	RC1018A0	ZINC PLATED D12 ELASTIC CLAMP	2	PZ	RC1019A0	D=10 ELASTIC CLAMP	14	PZ	RC1130A0	130X2,6 CLAM	5	PZ	RC1131A0	200X2.6 BLACK CLAMP	2	PZ	RC1242A0	D=10 CLOSED CAP	2	PZ	RC1356A0	"STRAIGHT THREADED FEMALE END 8X1/4" BS	1	PZ	TB2820A0	6X10 EPDM PIPE FOR WASHING SYSTEM	1.410	M	TB3132A0	WHITE-BLUE EPDM TEXTILE BRAID HOSE 6X12	0.770	M	VH1220A1	4,2X12 TCB SELF-TAPPIN G SCREW	3	PZ	VL1019A0	VIBRATION PUMP	1	PZ	VL1047A1	D6 PIPE HOLDER - D8 J.G. TERMINAL	1	PZ	VL1065A1	1/4 MALE N.O. PRESSURE SWITCH	1	PZ	VL1102A1	DETERGENT LINE FILTER + BARBED VNR 6 MM	1	PZ	VL1128A0	D6 BARBED CHECK VALVE	2	PZ	VL1128A1	D6 BARBED CHECK VALVE	2	PZ
Code	Description	Qty	UOM																																																																																						
0H2143A0	LAMIERA BLOCCA VNR VL1128	2	PZ																																																																																						
0H2168A1		1	PZ																																																																																						
0H2354A0	XEVC-XEVL WASHING CIRCUIT PLAT	1	PZ																																																																																						
EL1440A0	WATER SELF CLEANING VALVE	3	PZ																																																																																						
GN1526A0	INT. D.=6.9 TH=1.8 O-RIN	7	PZ																																																																																						
RC1018A0	ZINC PLATED D12 ELASTIC CLAMP	2	PZ																																																																																						
RC1019A0	D=10 ELASTIC CLAMP	14	PZ																																																																																						
RC1130A0	130X2,6 CLAM	5	PZ																																																																																						
RC1131A0	200X2.6 BLACK CLAMP	2	PZ																																																																																						
RC1242A0	D=10 CLOSED CAP	2	PZ																																																																																						
RC1356A0	"STRAIGHT THREADED FEMALE END 8X1/4" BS	1	PZ																																																																																						
TB2820A0	6X10 EPDM PIPE FOR WASHING SYSTEM	1.410	M																																																																																						
TB3132A0	WHITE-BLUE EPDM TEXTILE BRAID HOSE 6X12	0.770	M																																																																																						
VH1220A1	4,2X12 TCB SELF-TAPPIN G SCREW	3	PZ																																																																																						
VL1019A0	VIBRATION PUMP	1	PZ																																																																																						
VL1047A1	D6 PIPE HOLDER - D8 J.G. TERMINAL	1	PZ																																																																																						
VL1065A1	1/4 MALE N.O. PRESSURE SWITCH	1	PZ																																																																																						
VL1102A1	DETERGENT LINE FILTER + BARBED VNR 6 MM	1	PZ																																																																																						
VL1128A0	D6 BARBED CHECK VALVE	2	PZ																																																																																						
VL1128A1	D6 BARBED CHECK VALVE	2	PZ																																																																																						

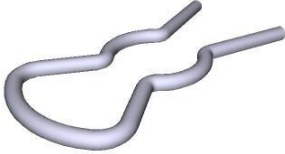



COMPONENT			SPARE PART																																																			
Code	Description	Image	Code	Description	Components list																																																	
VL1185A	2 WAYS PLUS WASHING DISTRIBUTOR		KVL1183A	1 ROTOR ARM PLUS CLEANING SYSTEM KIT	<table border="1"> <thead> <tr> <th>Code</th> <th>Description</th> <th>Qty</th> <th>UOM</th> </tr> </thead> <tbody> <tr> <td>VL1165A0</td> <td>BB6-AR6 STRAIGHT FITTING</td> <td>1</td> <td>PZ</td> </tr> <tr> <td>VL1166A0</td> <td>BB6-AR6 L FITTING</td> <td>3</td> <td>PZ</td> </tr> <tr> <td>VL1174C0</td> <td>D1.2 MM CALIBRATED NOZZLE</td> <td>1</td> <td>PZ</td> </tr> <tr> <td>VL1185A0</td> <td>2 WAYS PLUS WASHING DISTRIBUTOR</td> <td>1</td> <td>PZ</td> </tr> <tr> <td>VL1190A0</td> <td>PLUS WASHING SYSTEM INLET DISTRIBUTOR</td> <td>1</td> <td>PZ</td> </tr> <tr> <td>VM1605A0</td> <td>CLIP TWIST LOCK DIAM. 10,2-12,7 MM</td> <td>3</td> <td>PZ</td> </tr> <tr> <td>VM2172A0</td> <td>PUMP-WITH-CI RCUIT LOCKING PIN</td> <td>7</td> <td>PZ</td> </tr> </tbody> </table>	Code	Description	Qty	UOM	VL1165A0	BB6-AR6 STRAIGHT FITTING	1	PZ	VL1166A0	BB6-AR6 L FITTING	3	PZ	VL1174C0	D1.2 MM CALIBRATED NOZZLE	1	PZ	VL1185A0	2 WAYS PLUS WASHING DISTRIBUTOR	1	PZ	VL1190A0	PLUS WASHING SYSTEM INLET DISTRIBUTOR	1	PZ	VM1605A0	CLIP TWIST LOCK DIAM. 10,2-12,7 MM	3	PZ	VM2172A0	PUMP-WITH-CI RCUIT LOCKING PIN	7	PZ																	
			Code	Description	Qty	UOM																																																
VL1165A0	BB6-AR6 STRAIGHT FITTING	1	PZ																																																			
VL1166A0	BB6-AR6 L FITTING	3	PZ																																																			
VL1174C0	D1.2 MM CALIBRATED NOZZLE	1	PZ																																																			
VL1185A0	2 WAYS PLUS WASHING DISTRIBUTOR	1	PZ																																																			
VL1190A0	PLUS WASHING SYSTEM INLET DISTRIBUTOR	1	PZ																																																			
VM1605A0	CLIP TWIST LOCK DIAM. 10,2-12,7 MM	3	PZ																																																			
VM2172A0	PUMP-WITH-CI RCUIT LOCKING PIN	7	PZ																																																			
KVL0683A	1 ROTOR ARM PLUS WASH PUMP+NOZZLE KIT	<table border="1"> <thead> <tr> <th>Code</th> <th>Description</th> <th>Qty</th> <th>UOM</th> </tr> </thead> <tbody> <tr> <td>GN1526A0</td> <td>INT. D.=6.9 TH=1.8 O-RIN</td> <td>3</td> <td>PZ</td> </tr> <tr> <td>RC1019A0</td> <td>D=10 ELASTIC CLAMP</td> <td>4</td> <td>PZ</td> </tr> <tr> <td>RC1130A0</td> <td>130X2,6 CLAM</td> <td>1</td> <td>PZ</td> </tr> <tr> <td>RC1131A0</td> <td>200X2.6 BLACK CLAMP</td> <td>2</td> <td>PZ</td> </tr> <tr> <td>RC1242A0</td> <td>D=10 CLOSED CAP</td> <td>2</td> <td>PZ</td> </tr> <tr> <td>TB2820A0</td> <td>6X10 EPDM PIPE FOR WASHING SYSTEM</td> <td>0.120</td> <td>M</td> </tr> <tr> <td>VL1019A0</td> <td>VIBRATION PUMP</td> <td>1</td> <td>PZ</td> </tr> <tr> <td>VL1128A1</td> <td>D6 BARBED CHECK VALVE</td> <td>1</td> <td>PZ</td> </tr> <tr> <td>VL1174C0</td> <td>D1.2 MM CALIBRATED NOZZLE</td> <td>1</td> <td>PZ</td> </tr> <tr> <td>VL1185A0</td> <td>2 WAYS PLUS WASHING DISTRIBUTOR</td> <td>1</td> <td>PZ</td> </tr> <tr> <td>VL1190A0</td> <td>PLUS WASHING SYSTEM INLET DISTRIBUTOR</td> <td>1</td> <td>PZ</td> </tr> <tr> <td>VM2172A0</td> <td>PUMP-WITH-CI RCUIT LOCKING PIN</td> <td>1</td> <td>PZ</td> </tr> </tbody> </table>	Code	Description	Qty	UOM	GN1526A0	INT. D.=6.9 TH=1.8 O-RIN	3	PZ	RC1019A0	D=10 ELASTIC CLAMP	4	PZ	RC1130A0	130X2,6 CLAM	1	PZ	RC1131A0	200X2.6 BLACK CLAMP	2	PZ	RC1242A0	D=10 CLOSED CAP	2	PZ	TB2820A0	6X10 EPDM PIPE FOR WASHING SYSTEM	0.120	M	VL1019A0	VIBRATION PUMP	1	PZ	VL1128A1	D6 BARBED CHECK VALVE	1	PZ	VL1174C0	D1.2 MM CALIBRATED NOZZLE	1	PZ	VL1185A0	2 WAYS PLUS WASHING DISTRIBUTOR	1	PZ	VL1190A0	PLUS WASHING SYSTEM INLET DISTRIBUTOR	1	PZ	VM2172A0	PUMP-WITH-CI RCUIT LOCKING PIN	1	PZ
Code	Description	Qty	UOM																																																			
GN1526A0	INT. D.=6.9 TH=1.8 O-RIN	3	PZ																																																			
RC1019A0	D=10 ELASTIC CLAMP	4	PZ																																																			
RC1130A0	130X2,6 CLAM	1	PZ																																																			
RC1131A0	200X2.6 BLACK CLAMP	2	PZ																																																			
RC1242A0	D=10 CLOSED CAP	2	PZ																																																			
TB2820A0	6X10 EPDM PIPE FOR WASHING SYSTEM	0.120	M																																																			
VL1019A0	VIBRATION PUMP	1	PZ																																																			
VL1128A1	D6 BARBED CHECK VALVE	1	PZ																																																			
VL1174C0	D1.2 MM CALIBRATED NOZZLE	1	PZ																																																			
VL1185A0	2 WAYS PLUS WASHING DISTRIBUTOR	1	PZ																																																			
VL1190A0	PLUS WASHING SYSTEM INLET DISTRIBUTOR	1	PZ																																																			
VM2172A0	PUMP-WITH-CI RCUIT LOCKING PIN	1	PZ																																																			

COMPONENT			SPARE PART																						
Code	Description	Image	Code	Description	Components list																				
VM2172A	PUMP-WITH-CIRCUIT LOCKING PIN		VM2172A0	PUMP-WITH-CIRCUIT LOCKING PIN																					
VL1214A			VL1214A0																						
0H2561A	6 S. DOOR COUNTERBRACKET		0H2561A0	6 S. DOOR COUNTERBRACKET																					
VM1240A	NYLON SUPPORT CAP		KVM1240A	4 PCS COUNTER BRACKET SUPPORT CAP KIT	<table border="1"> <thead> <tr> <th>Code</th> <th>Description</th> <th>Qty</th> <th>UOM</th> </tr> </thead> <tbody> <tr> <td>VM1224A0</td> <td>65MY 220MM 2 COLOURS SHRINK TUBE</td> <td>0.200</td> <td>M</td> </tr> <tr> <td>VM1240A0</td> <td>NYLON SUPPORT CAP</td> <td>4</td> <td>PZ</td> </tr> </tbody> </table>	Code	Description	Qty	UOM	VM1224A0	65MY 220MM 2 COLOURS SHRINK TUBE	0.200	M	VM1240A0	NYLON SUPPORT CAP	4	PZ								
Code	Description	Qty	UOM																						
VM1224A0	65MY 220MM 2 COLOURS SHRINK TUBE	0.200	M																						
VM1240A0	NYLON SUPPORT CAP	4	PZ																						
VE1020B	MAGNET DOOR MICROSWITCH		KVE1020B	MICROSWITCH KIT	<table border="1"> <thead> <tr> <th>Code</th> <th>Description</th> <th>Qty</th> <th>UOM</th> </tr> </thead> <tbody> <tr> <td>CE1030A0</td> <td>FEMALE FASTON COVER 6.3X0.8 0.5-1MMQ</td> <td>2</td> <td>PZ</td> </tr> <tr> <td>CE1660A0</td> <td>6,3X0,8 FEMALE FASTON COVER</td> <td>2</td> <td>PZ</td> </tr> <tr> <td>CE1730A0</td> <td>PVC CABLE NP 2 X AWG22 STYLE 2095</td> <td>0.150</td> <td>M</td> </tr> <tr> <td>CE1740A0</td> <td>MINIFIT MALE END FITTING</td> <td>2</td> <td>PZ</td> </tr> </tbody> </table>	Code	Description	Qty	UOM	CE1030A0	FEMALE FASTON COVER 6.3X0.8 0.5-1MMQ	2	PZ	CE1660A0	6,3X0,8 FEMALE FASTON COVER	2	PZ	CE1730A0	PVC CABLE NP 2 X AWG22 STYLE 2095	0.150	M	CE1740A0	MINIFIT MALE END FITTING	2	PZ
Code	Description	Qty	UOM																						
CE1030A0	FEMALE FASTON COVER 6.3X0.8 0.5-1MMQ	2	PZ																						
CE1660A0	6,3X0,8 FEMALE FASTON COVER	2	PZ																						
CE1730A0	PVC CABLE NP 2 X AWG22 STYLE 2095	0.150	M																						
CE1740A0	MINIFIT MALE END FITTING	2	PZ																						

COMPONENT			SPARE PART																						
Code	Description	Image	Code	Description	Components list																				
VE1020B	MAGNET DOOR MICROSWITCH		KVE1020B	MICROSWITCH KIT	<table border="1"> <thead> <tr> <th>Code</th> <th>Description</th> <th>Qty</th> <th>UOM</th> </tr> </thead> <tbody> <tr> <td>CE1745A0</td> <td>2 WAYS FEMALE MINIFIT CONNECTOR</td> <td>1</td> <td>PZ</td> </tr> <tr> <td>VE1020B0</td> <td>MAGNET DOOR MICROSWITC</td> <td>1</td> <td>PZ</td> </tr> <tr> <td>VE1030A1</td> <td>MAGNET FOR DOOR MICROSWITC H D=22,9MM</td> <td>1</td> <td>PZ</td> </tr> <tr> <td>VM1224A0</td> <td>65MY 220MM 2 COLOURS SHRINK TUBE</td> <td>0.250</td> <td>M</td> </tr> </tbody> </table>	Code	Description	Qty	UOM	CE1745A0	2 WAYS FEMALE MINIFIT CONNECTOR	1	PZ	VE1020B0	MAGNET DOOR MICROSWITC	1	PZ	VE1030A1	MAGNET FOR DOOR MICROSWITC H D=22,9MM	1	PZ	VM1224A0	65MY 220MM 2 COLOURS SHRINK TUBE	0.250	M
					Code	Description	Qty	UOM																	
					CE1745A0	2 WAYS FEMALE MINIFIT CONNECTOR	1	PZ																	
					VE1020B0	MAGNET DOOR MICROSWITC	1	PZ																	
VE1030A1	MAGNET FOR DOOR MICROSWITC H D=22,9MM	1	PZ																						
VM1224A0	65MY 220MM 2 COLOURS SHRINK TUBE	0.250	M																						
<table border="1"> <thead> <tr> <th>Code</th> <th>Description</th> <th>Qty</th> <th>UOM</th> </tr> </thead> <tbody> <tr> <td>VM1224A0</td> <td>65MY 220MM 2 COLOURS SHRINK TUBE</td> <td>0.200</td> <td>M</td> </tr> <tr> <td>VP1075A0</td> <td>PLUS/1/ZERO MICROSWITC H SUPPORT COVER</td> <td>1</td> <td>PZ</td> </tr> </tbody> </table>	Code	Description	Qty	UOM	VM1224A0	65MY 220MM 2 COLOURS SHRINK TUBE	0.200	M	VP1075A0	PLUS/1/ZERO MICROSWITC H SUPPORT COVER	1	PZ													
Code	Description	Qty	UOM																						
VM1224A0	65MY 220MM 2 COLOURS SHRINK TUBE	0.200	M																						
VP1075A0	PLUS/1/ZERO MICROSWITC H SUPPORT COVER	1	PZ																						
VP1075A	PLUS/1/ZERO MICROSWITCH SUPPORT COVER		KVP1075A	- M MICROSWITCH SUPPORT PLATE KI	<table border="1"> <thead> <tr> <th>Code</th> <th>Description</th> <th>Qty</th> <th>UOM</th> </tr> </thead> <tbody> <tr> <td>VM1224A0</td> <td>65MY 220MM 2 COLOURS SHRINK TUBE</td> <td>0.200</td> <td>M</td> </tr> <tr> <td>VP1075A0</td> <td>PLUS/1/ZERO MICROSWITC H SUPPORT COVER</td> <td>1</td> <td>PZ</td> </tr> </tbody> </table>	Code	Description	Qty	UOM	VM1224A0	65MY 220MM 2 COLOURS SHRINK TUBE	0.200	M	VP1075A0	PLUS/1/ZERO MICROSWITC H SUPPORT COVER	1	PZ								
					Code	Description	Qty	UOM																	
VM1224A0	65MY 220MM 2 COLOURS SHRINK TUBE	0.200	M																						
VP1075A0	PLUS/1/ZERO MICROSWITC H SUPPORT COVER	1	PZ																						
0H2561A	6 S. DOOR COUNTERBRACKET		0H2561A0	6 S. DOOR COUNTERBRACKET																					
VM1240A	NYLON SUPPORT CAP		KVM1240A	4 PCS COUNTER BRACKET SUPPORT CAP KIT	<table border="1"> <thead> <tr> <th>Code</th> <th>Description</th> <th>Qty</th> <th>UOM</th> </tr> </thead> <tbody> <tr> <td>VM1224A0</td> <td>65MY 220MM 2 COLOURS SHRINK TUBE</td> <td>0.200</td> <td>M</td> </tr> <tr> <td>VM1240A0</td> <td>NYLON SUPPORT CAP</td> <td>4</td> <td>PZ</td> </tr> </tbody> </table>	Code	Description	Qty	UOM	VM1224A0	65MY 220MM 2 COLOURS SHRINK TUBE	0.200	M	VM1240A0	NYLON SUPPORT CAP	4	PZ								
					Code	Description	Qty	UOM																	
VM1224A0	65MY 220MM 2 COLOURS SHRINK TUBE	0.200	M																						
VM1240A0	NYLON SUPPORT CAP	4	PZ																						





COMPONENT			SPARE PART																										
Code	Description	Image	Code	Description	Components list																								
VM2310A	UPPER DOOR BRACKET HOLES COVER		KVM2310A	UPPER BRACKET HOLE COVER KIT	<table border="1"> <thead> <tr> <th>Code</th> <th>Description</th> <th>Qty</th> <th>UOM</th> </tr> </thead> <tbody> <tr> <td>VM1224A0</td> <td>65MY 220MM 2 COLOURS SHRINK TUBE</td> <td>0.300</td> <td>M</td> </tr> <tr> <td>VM2310A0</td> <td>UPPER DOOR BRACKET HOLES COVER</td> <td>1</td> <td>PZ</td> </tr> </tbody> </table>	Code	Description	Qty	UOM	VM1224A0	65MY 220MM 2 COLOURS SHRINK TUBE	0.300	M	VM2310A0	UPPER DOOR BRACKET HOLES COVER	1	PZ												
Code	Description	Qty	UOM																										
VM1224A0	65MY 220MM 2 COLOURS SHRINK TUBE	0.300	M																										
VM2310A0	UPPER DOOR BRACKET HOLES COVER	1	PZ																										
VM2061A	ACCESSORIES CABLES WALL PASSING		KVM1505A	THROUGH-WALL CONNECTION+DIAPHRAGM KIT	<table border="1"> <thead> <tr> <th>Code</th> <th>Description</th> <th>Qty</th> <th>UOM</th> </tr> </thead> <tbody> <tr> <td>VI1220A1</td> <td>4,2X12 TCB SELF-TAPPIN G SCREW</td> <td>1</td> <td>PZ</td> </tr> <tr> <td>VM1224A0</td> <td>65MY 220MM 2 COLOURS SHRINK TUBE</td> <td>0.200</td> <td>M</td> </tr> <tr> <td>VM1505A0</td> <td>WALL PASSING WITH DIAPHRAGM</td> <td>3</td> <td>PZ</td> </tr> <tr> <td>VM2055A0</td> <td>UPPER WALL PASSING ACCESSORY CABLES</td> <td>1</td> <td>PZ</td> </tr> <tr> <td>VM2056A0</td> <td>LOWER WALL PASSING ACCESSORY CABLES</td> <td>1</td> <td>PZ</td> </tr> </tbody> </table>	Code	Description	Qty	UOM	VI1220A1	4,2X12 TCB SELF-TAPPIN G SCREW	1	PZ	VM1224A0	65MY 220MM 2 COLOURS SHRINK TUBE	0.200	M	VM1505A0	WALL PASSING WITH DIAPHRAGM	3	PZ	VM2055A0	UPPER WALL PASSING ACCESSORY CABLES	1	PZ	VM2056A0	LOWER WALL PASSING ACCESSORY CABLES	1	PZ
Code	Description	Qty	UOM																										
VI1220A1	4,2X12 TCB SELF-TAPPIN G SCREW	1	PZ																										
VM1224A0	65MY 220MM 2 COLOURS SHRINK TUBE	0.200	M																										
VM1505A0	WALL PASSING WITH DIAPHRAGM	3	PZ																										
VM2055A0	UPPER WALL PASSING ACCESSORY CABLES	1	PZ																										
VM2056A0	LOWER WALL PASSING ACCESSORY CABLES	1	PZ																										
VP1121A	LEFT-RIGHT WATER SEALING CAP		VP1121A0	LEFT-RIGHT WATER SEALING CAP																									
VM1190A	CT BT RIGHT DOOR SPRING LATCH		KVM1190A	CHEFTOP/BAKERTO P DOOR RIGHT LATCH KIT	<table border="1"> <thead> <tr> <th>Code</th> <th>Description</th> <th>Qty</th> <th>UOM</th> </tr> </thead> <tbody> <tr> <td>VI0239A1</td> <td>SELF-TAPPIN G SCREW 4,2X25 TCB+ INOX</td> <td>2</td> <td>PZ</td> </tr> <tr> <td>VI1220A1</td> <td>4,2X12 TCB SELF-TAPPIN G SCREW</td> <td>2</td> <td>PZ</td> </tr> <tr> <td>VM1190A2</td> <td>CT BT RIGHT DOOR SPRING LATCH</td> <td>1</td> <td>PZ</td> </tr> <tr> <td>VM1192A1</td> <td>CT BT DOOR SPRING LATCH BACK COVER</td> <td>1</td> <td>PZ</td> </tr> </tbody> </table>	Code	Description	Qty	UOM	VI0239A1	SELF-TAPPIN G SCREW 4,2X25 TCB+ INOX	2	PZ	VI1220A1	4,2X12 TCB SELF-TAPPIN G SCREW	2	PZ	VM1190A2	CT BT RIGHT DOOR SPRING LATCH	1	PZ	VM1192A1	CT BT DOOR SPRING LATCH BACK COVER	1	PZ				
Code	Description	Qty	UOM																										
VI0239A1	SELF-TAPPIN G SCREW 4,2X25 TCB+ INOX	2	PZ																										
VI1220A1	4,2X12 TCB SELF-TAPPIN G SCREW	2	PZ																										
VM1190A2	CT BT RIGHT DOOR SPRING LATCH	1	PZ																										
VM1192A1	CT BT DOOR SPRING LATCH BACK COVER	1	PZ																										

COMPONENT			SPARE PART																														
Code	Description	Image	Code	Description	Components list																												
VM1190A	CT BT RIGHT DOOR SPRING LATCH		KVM1190A	CHEFTOP/BAKERTO P DOOR RIGHT LATCH KIT	<table border="1"> <thead> <tr> <th>Code</th> <th>Description</th> <th>Qty</th> <th>UOM</th> </tr> </thead> <tbody> <tr> <td>VM1224A0</td> <td>65MY 220MM 2 COLOURS SHRINK TUBE</td> <td>0.200</td> <td>M</td> </tr> <tr> <td>VM1460A0</td> <td>XBC/XVC RIGHT DOOR LATCH CAP</td> <td>1</td> <td>PZ</td> </tr> </tbody> </table>	Code	Description	Qty	UOM	VM1224A0	65MY 220MM 2 COLOURS SHRINK TUBE	0.200	M	VM1460A0	XBC/XVC RIGHT DOOR LATCH CAP	1	PZ																
Code	Description	Qty	UOM																														
VM1224A0	65MY 220MM 2 COLOURS SHRINK TUBE	0.200	M																														
VM1460A0	XBC/XVC RIGHT DOOR LATCH CAP	1	PZ																														
VM1192A	CT BT DOOR SPRING LATCH BACK COVER		KVM1191A	CHEFTOP/BAKERTO P DOOR LEFT LATCH KIT	<table border="1"> <thead> <tr> <th>Code</th> <th>Description</th> <th>Qty</th> <th>UOM</th> </tr> </thead> <tbody> <tr> <td>VI0239A1</td> <td>SELF-TAPPIN G SCREW 4.2X25 TCB+ INOX</td> <td>2</td> <td>PZ</td> </tr> <tr> <td>VI1220A1</td> <td>4.2X12 TCB SELF-TAPPIN G SCREW</td> <td>2</td> <td>PZ</td> </tr> <tr> <td>VM1191A2</td> <td>CT BT LEFT DOOR SPRING LATCH</td> <td>1</td> <td>PZ</td> </tr> <tr> <td>VM1192A1</td> <td>CT BT DOOR SPRING LATCH BACK COVER</td> <td>1</td> <td>PZ</td> </tr> <tr> <td>VM1224A0</td> <td>65MY 220MM 2 COLOURS SHRINK TUBE</td> <td>0.200</td> <td>M</td> </tr> <tr> <td>VM1460A0</td> <td>XBC/XVC RIGHT DOOR LATCH CAP</td> <td>1</td> <td>PZ</td> </tr> </tbody> </table>	Code	Description	Qty	UOM	VI0239A1	SELF-TAPPIN G SCREW 4.2X25 TCB+ INOX	2	PZ	VI1220A1	4.2X12 TCB SELF-TAPPIN G SCREW	2	PZ	VM1191A2	CT BT LEFT DOOR SPRING LATCH	1	PZ	VM1192A1	CT BT DOOR SPRING LATCH BACK COVER	1	PZ	VM1224A0	65MY 220MM 2 COLOURS SHRINK TUBE	0.200	M	VM1460A0	XBC/XVC RIGHT DOOR LATCH CAP	1	PZ
Code	Description	Qty	UOM																														
VI0239A1	SELF-TAPPIN G SCREW 4.2X25 TCB+ INOX	2	PZ																														
VI1220A1	4.2X12 TCB SELF-TAPPIN G SCREW	2	PZ																														
VM1191A2	CT BT LEFT DOOR SPRING LATCH	1	PZ																														
VM1192A1	CT BT DOOR SPRING LATCH BACK COVER	1	PZ																														
VM1224A0	65MY 220MM 2 COLOURS SHRINK TUBE	0.200	M																														
VM1460A0	XBC/XVC RIGHT DOOR LATCH CAP	1	PZ																														
			KVM1190A	CHEFTOP/BAKERTO P DOOR RIGHT LATCH KIT	<table border="1"> <thead> <tr> <th>Code</th> <th>Description</th> <th>Qty</th> <th>UOM</th> </tr> </thead> <tbody> <tr> <td>VI0239A1</td> <td>SELF-TAPPIN G SCREW 4.2X25 TCB+ INOX</td> <td>2</td> <td>PZ</td> </tr> <tr> <td>VI1220A1</td> <td>4.2X12 TCB SELF-TAPPIN G SCREW</td> <td>2</td> <td>PZ</td> </tr> <tr> <td>VM1190A2</td> <td>CT BT RIGHT DOOR SPRING LATCH</td> <td>1</td> <td>PZ</td> </tr> <tr> <td>VM1192A1</td> <td>CT BT DOOR SPRING LATCH BACK COVER</td> <td>1</td> <td>PZ</td> </tr> <tr> <td>VM1224A0</td> <td>65MY 220MM 2 COLOURS SHRINK TUBE</td> <td>0.200</td> <td>M</td> </tr> <tr> <td>VM1460A0</td> <td>XBC/XVC RIGHT DOOR LATCH CAP</td> <td>1</td> <td>PZ</td> </tr> </tbody> </table>	Code	Description	Qty	UOM	VI0239A1	SELF-TAPPIN G SCREW 4.2X25 TCB+ INOX	2	PZ	VI1220A1	4.2X12 TCB SELF-TAPPIN G SCREW	2	PZ	VM1190A2	CT BT RIGHT DOOR SPRING LATCH	1	PZ	VM1192A1	CT BT DOOR SPRING LATCH BACK COVER	1	PZ	VM1224A0	65MY 220MM 2 COLOURS SHRINK TUBE	0.200	M	VM1460A0	XBC/XVC RIGHT DOOR LATCH CAP	1	PZ
Code	Description	Qty	UOM																														
VI0239A1	SELF-TAPPIN G SCREW 4.2X25 TCB+ INOX	2	PZ																														
VI1220A1	4.2X12 TCB SELF-TAPPIN G SCREW	2	PZ																														
VM1190A2	CT BT RIGHT DOOR SPRING LATCH	1	PZ																														
VM1192A1	CT BT DOOR SPRING LATCH BACK COVER	1	PZ																														
VM1224A0	65MY 220MM 2 COLOURS SHRINK TUBE	0.200	M																														
VM1460A0	XBC/XVC RIGHT DOOR LATCH CAP	1	PZ																														







COMPONENT			SPARE PART																														
Code	Description	Image	Code	Description	Components list																												
VM1630A	INTERNAL GLASS PUSHING CAP		KVM1630A	CAP FOR INTERNAL GLASS 10 PCS KIT	<table border="1"> <thead> <tr> <th>Code</th> <th>Description</th> <th>Qty</th> <th>UOM</th> </tr> </thead> <tbody> <tr> <td>VM1224A0</td> <td>65MY 220MM 2 COLOURS SHRINK TUBE</td> <td>0.200</td> <td>M</td> </tr> <tr> <td>VM1630A0</td> <td>INTERNAL GLASS PUSHING CAP</td> <td>10</td> <td>PZ</td> </tr> <tr> <td>VM1630A1</td> <td>INTERNAL GLASS PUSHING CAP</td> <td>10</td> <td>PZ</td> </tr> </tbody> </table>	Code	Description	Qty	UOM	VM1224A0	65MY 220MM 2 COLOURS SHRINK TUBE	0.200	M	VM1630A0	INTERNAL GLASS PUSHING CAP	10	PZ	VM1630A1	INTERNAL GLASS PUSHING CAP	10	PZ												
Code	Description	Qty	UOM																														
VM1224A0	65MY 220MM 2 COLOURS SHRINK TUBE	0.200	M																														
VM1630A0	INTERNAL GLASS PUSHING CAP	10	PZ																														
VM1630A1	INTERNAL GLASS PUSHING CAP	10	PZ																														
VM2280B	HANDLE LATCH PLATE COVER		KVM2280B	VM2280B -M HANDLE LATCH PLATE COVER KIT	<table border="1"> <thead> <tr> <th>Code</th> <th>Description</th> <th>Qty</th> <th>UOM</th> </tr> </thead> <tbody> <tr> <td>VI1074A0</td> <td>4X16 SCREW FOR PLASTIC</td> <td>2</td> <td>PZ</td> </tr> <tr> <td>VM1224A0</td> <td>65MY 220MM 2 COLOURS SHRINK TUBE</td> <td>0.200</td> <td>M</td> </tr> <tr> <td>VM1630A1</td> <td>INTERNAL GLASS PUSHING CAP</td> <td>2</td> <td>PZ</td> </tr> <tr> <td>VM2280B0</td> <td>HANDLE LATCH PLATE COVER</td> <td>1</td> <td>PZ</td> </tr> </tbody> </table>	Code	Description	Qty	UOM	VI1074A0	4X16 SCREW FOR PLASTIC	2	PZ	VM1224A0	65MY 220MM 2 COLOURS SHRINK TUBE	0.200	M	VM1630A1	INTERNAL GLASS PUSHING CAP	2	PZ	VM2280B0	HANDLE LATCH PLATE COVER	1	PZ								
Code	Description	Qty	UOM																														
VI1074A0	4X16 SCREW FOR PLASTIC	2	PZ																														
VM1224A0	65MY 220MM 2 COLOURS SHRINK TUBE	0.200	M																														
VM1630A1	INTERNAL GLASS PUSHING CAP	2	PZ																														
VM2280B0	HANDLE LATCH PLATE COVER	1	PZ																														
VM2281A	DOOR LATCH HOLES COVER		KVM2281A	HOLE PLATE COVER KIT	<table border="1"> <thead> <tr> <th>Code</th> <th>Description</th> <th>Qty</th> <th>UOM</th> </tr> </thead> <tbody> <tr> <td>VM1224A0</td> <td>65MY 220MM 2 COLOURS SHRINK TUBE</td> <td>0.200</td> <td>M</td> </tr> <tr> <td>VM2281A0</td> <td>DOOR LATCH HOLES COVER</td> <td>1</td> <td>PZ</td> </tr> </tbody> </table>	Code	Description	Qty	UOM	VM1224A0	65MY 220MM 2 COLOURS SHRINK TUBE	0.200	M	VM2281A0	DOOR LATCH HOLES COVER	1	PZ																
Code	Description	Qty	UOM																														
VM1224A0	65MY 220MM 2 COLOURS SHRINK TUBE	0.200	M																														
VM2281A0	DOOR LATCH HOLES COVER	1	PZ																														
VM1192A	CT BT DOOR SPRING LATCH BACK COVER		KVM1191A	CHEFTOP/BAKERTO P DOOR LEFT LATCH KIT	<table border="1"> <thead> <tr> <th>Code</th> <th>Description</th> <th>Qty</th> <th>UOM</th> </tr> </thead> <tbody> <tr> <td>VI0239A1</td> <td>SELF-TAPPIN G SCREW 4.2X25 TCB+ INOX</td> <td>2</td> <td>PZ</td> </tr> <tr> <td>VI1220A1</td> <td>4.2X12 TCB SELF-TAPPIN G SCREW</td> <td>2</td> <td>PZ</td> </tr> <tr> <td>VM1191A2</td> <td>CT BT LEFT DOOR SPRING LATCH</td> <td>1</td> <td>PZ</td> </tr> <tr> <td>VM1192A1</td> <td>CT BT DOOR SPRING LATCH BACK COVER</td> <td>1</td> <td>PZ</td> </tr> <tr> <td>VM1224A0</td> <td>65MY 220MM 2 COLOURS SHRINK TUBE</td> <td>0.200</td> <td>M</td> </tr> <tr> <td>VM1460A0</td> <td>XBC/XVC RIGHT DOOR LATCH CAP</td> <td>1</td> <td>PZ</td> </tr> </tbody> </table>	Code	Description	Qty	UOM	VI0239A1	SELF-TAPPIN G SCREW 4.2X25 TCB+ INOX	2	PZ	VI1220A1	4.2X12 TCB SELF-TAPPIN G SCREW	2	PZ	VM1191A2	CT BT LEFT DOOR SPRING LATCH	1	PZ	VM1192A1	CT BT DOOR SPRING LATCH BACK COVER	1	PZ	VM1224A0	65MY 220MM 2 COLOURS SHRINK TUBE	0.200	M	VM1460A0	XBC/XVC RIGHT DOOR LATCH CAP	1	PZ
Code	Description	Qty	UOM																														
VI0239A1	SELF-TAPPIN G SCREW 4.2X25 TCB+ INOX	2	PZ																														
VI1220A1	4.2X12 TCB SELF-TAPPIN G SCREW	2	PZ																														
VM1191A2	CT BT LEFT DOOR SPRING LATCH	1	PZ																														
VM1192A1	CT BT DOOR SPRING LATCH BACK COVER	1	PZ																														
VM1224A0	65MY 220MM 2 COLOURS SHRINK TUBE	0.200	M																														
VM1460A0	XBC/XVC RIGHT DOOR LATCH CAP	1	PZ																														



COMPONENT			SPARE PART																														
Code	Description	Image	Code	Description	Components list																												
VM1192A	CT BT DOOR SPRING LATCH BACK COVER		KVM1190A	CHEFTOP/BAKERTO P DOOR RIGHT LATCH KIT	<table border="1"> <thead> <tr> <th>Code</th> <th>Description</th> <th>Qty</th> <th>UOM</th> </tr> </thead> <tbody> <tr> <td>VI0239A1</td> <td>SELF-TAPPIN G SCREW 4.2X25 TCB+ INOX</td> <td>2</td> <td>PZ</td> </tr> <tr> <td>VI1220A1</td> <td>4,2X12 TCB SELF-TAPPIN G SCREW</td> <td>2</td> <td>PZ</td> </tr> <tr> <td>VM1190A2</td> <td>CT BT RIGHT DOOR SPRING LATCH</td> <td>1</td> <td>PZ</td> </tr> <tr> <td>VM1192A1</td> <td>CT BT DOOR SPRING LATCH BACK COVER</td> <td>1</td> <td>PZ</td> </tr> <tr> <td>VM1224A0</td> <td>65MY 220MM 2 COLOURS SHRINK TUBE</td> <td>0.200</td> <td>M</td> </tr> <tr> <td>VM1460A0</td> <td>XBC/XVC RIGHT DOOR LATCH CAP</td> <td>1</td> <td>PZ</td> </tr> </tbody> </table>	Code	Description	Qty	UOM	VI0239A1	SELF-TAPPIN G SCREW 4.2X25 TCB+ INOX	2	PZ	VI1220A1	4,2X12 TCB SELF-TAPPIN G SCREW	2	PZ	VM1190A2	CT BT RIGHT DOOR SPRING LATCH	1	PZ	VM1192A1	CT BT DOOR SPRING LATCH BACK COVER	1	PZ	VM1224A0	65MY 220MM 2 COLOURS SHRINK TUBE	0.200	M	VM1460A0	XBC/XVC RIGHT DOOR LATCH CAP	1	PZ
Code	Description	Qty	UOM																														
VI0239A1	SELF-TAPPIN G SCREW 4.2X25 TCB+ INOX	2	PZ																														
VI1220A1	4,2X12 TCB SELF-TAPPIN G SCREW	2	PZ																														
VM1190A2	CT BT RIGHT DOOR SPRING LATCH	1	PZ																														
VM1192A1	CT BT DOOR SPRING LATCH BACK COVER	1	PZ																														
VM1224A0	65MY 220MM 2 COLOURS SHRINK TUBE	0.200	M																														
VM1460A0	XBC/XVC RIGHT DOOR LATCH CAP	1	PZ																														
VM1191A	CT BT LEFT DOOR SPRING LATCH		KVM1191A	CHEFTOP/BAKERTO P DOOR LEFT LATCH KIT	<table border="1"> <thead> <tr> <th>Code</th> <th>Description</th> <th>Qty</th> <th>UOM</th> </tr> </thead> <tbody> <tr> <td>VI0239A1</td> <td>SELF-TAPPIN G SCREW 4.2X25 TCB+ INOX</td> <td>2</td> <td>PZ</td> </tr> <tr> <td>VI1220A1</td> <td>4,2X12 TCB SELF-TAPPIN G SCREW</td> <td>2</td> <td>PZ</td> </tr> <tr> <td>VM1191A2</td> <td>CT BT LEFT DOOR SPRING LATCH</td> <td>1</td> <td>PZ</td> </tr> <tr> <td>VM1192A1</td> <td>CT BT DOOR SPRING LATCH BACK COVER</td> <td>1</td> <td>PZ</td> </tr> <tr> <td>VM1224A0</td> <td>65MY 220MM 2 COLOURS SHRINK TUBE</td> <td>0.200</td> <td>M</td> </tr> <tr> <td>VM1460A0</td> <td>XBC/XVC RIGHT DOOR LATCH CAP</td> <td>1</td> <td>PZ</td> </tr> </tbody> </table>	Code	Description	Qty	UOM	VI0239A1	SELF-TAPPIN G SCREW 4.2X25 TCB+ INOX	2	PZ	VI1220A1	4,2X12 TCB SELF-TAPPIN G SCREW	2	PZ	VM1191A2	CT BT LEFT DOOR SPRING LATCH	1	PZ	VM1192A1	CT BT DOOR SPRING LATCH BACK COVER	1	PZ	VM1224A0	65MY 220MM 2 COLOURS SHRINK TUBE	0.200	M	VM1460A0	XBC/XVC RIGHT DOOR LATCH CAP	1	PZ
Code	Description	Qty	UOM																														
VI0239A1	SELF-TAPPIN G SCREW 4.2X25 TCB+ INOX	2	PZ																														
VI1220A1	4,2X12 TCB SELF-TAPPIN G SCREW	2	PZ																														
VM1191A2	CT BT LEFT DOOR SPRING LATCH	1	PZ																														
VM1192A1	CT BT DOOR SPRING LATCH BACK COVER	1	PZ																														
VM1224A0	65MY 220MM 2 COLOURS SHRINK TUBE	0.200	M																														
VM1460A0	XBC/XVC RIGHT DOOR LATCH CAP	1	PZ																														
0H2561A	6 S. DOOR COUNTERBRACKET		0H2561A0	6 S. DOOR COUNTERBRACKET																													



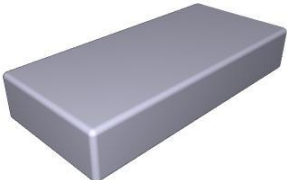





COMPONENT			SPARE PART																														
Code	Description	Image	Code	Description	Components list																												
VI1995A	M5X25 ST.STEEL SCREW		VI1995A0	M5X25 ST.STEEL SCREW																													
VM1240A	NYLON SUPPORT CAP		KVM1240A	4 PCS COUNTER BRACKET SUPPORT CAP KIT	<table border="1"> <thead> <tr> <th>Code</th> <th>Description</th> <th>Qty</th> <th>UOM</th> </tr> </thead> <tbody> <tr> <td>VM1224A0</td> <td>65MY 220MM 2 COLOURS SHRINK TUBE</td> <td>0.200</td> <td>M</td> </tr> <tr> <td>VM1240A0</td> <td>NYLON SUPPORT CAP</td> <td>4</td> <td>PZ</td> </tr> </tbody> </table>	Code	Description	Qty	UOM	VM1224A0	65MY 220MM 2 COLOURS SHRINK TUBE	0.200	M	VM1240A0	NYLON SUPPORT CAP	4	PZ																
Code	Description	Qty	UOM																														
VM1224A0	65MY 220MM 2 COLOURS SHRINK TUBE	0.200	M																														
VM1240A0	NYLON SUPPORT CAP	4	PZ																														
VM2298A	DOOR BRACKET UPPER COVER		KVM2298A	MIND.MAPS DOOR UPPER BRACKET COVER KIT	<table border="1"> <thead> <tr> <th>Code</th> <th>Description</th> <th>Qty</th> <th>UOM</th> </tr> </thead> <tbody> <tr> <td>VI1220A0</td> <td>SELF-TAPPIN G SCREW 4,2X12.TCB</td> <td>2</td> <td>PZ</td> </tr> <tr> <td>VM1224A0</td> <td>65MY 220MM 2 COLOURS SHRINK TUBE</td> <td>0.200</td> <td>M</td> </tr> <tr> <td>VM2298A0</td> <td>DOOR BRACKET UPPER COVER</td> <td>1</td> <td>PZ</td> </tr> </tbody> </table>	Code	Description	Qty	UOM	VI1220A0	SELF-TAPPIN G SCREW 4,2X12.TCB	2	PZ	VM1224A0	65MY 220MM 2 COLOURS SHRINK TUBE	0.200	M	VM2298A0	DOOR BRACKET UPPER COVER	1	PZ												
Code	Description	Qty	UOM																														
VI1220A0	SELF-TAPPIN G SCREW 4,2X12.TCB	2	PZ																														
VM1224A0	65MY 220MM 2 COLOURS SHRINK TUBE	0.200	M																														
VM2298A0	DOOR BRACKET UPPER COVER	1	PZ																														
VM2271A	MM DOOR LEFT UPPER BRACKET		KVM2271A	MIND.MAPS UPPER LEFT DOOR BRACKET KIT	<table border="1"> <thead> <tr> <th>Code</th> <th>Description</th> <th>Qty</th> <th>UOM</th> </tr> </thead> <tbody> <tr> <td>VI1220A1</td> <td>4,2X12.TCB SELF-TAPPIN G SCREW</td> <td>2</td> <td>PZ</td> </tr> <tr> <td>VI1995A0</td> <td>M5X25 ST.STEEL SCREW</td> <td>4</td> <td>PZ</td> </tr> <tr> <td>VI1997A0</td> <td>5X10X1 FLAT WASHER</td> <td>4</td> <td>PZ</td> </tr> <tr> <td>VM1224A0</td> <td>65MY 220MM 2 COLOURS SHRINK TUBE</td> <td>0.300</td> <td>M</td> </tr> <tr> <td>VM2271A0</td> <td>MM DOOR LEFT UPPER BRACKET</td> <td>1</td> <td>PZ</td> </tr> <tr> <td>VM2298A0</td> <td>DOOR BRACKET UPPER COVER</td> <td>1</td> <td>PZ</td> </tr> </tbody> </table>	Code	Description	Qty	UOM	VI1220A1	4,2X12.TCB SELF-TAPPIN G SCREW	2	PZ	VI1995A0	M5X25 ST.STEEL SCREW	4	PZ	VI1997A0	5X10X1 FLAT WASHER	4	PZ	VM1224A0	65MY 220MM 2 COLOURS SHRINK TUBE	0.300	M	VM2271A0	MM DOOR LEFT UPPER BRACKET	1	PZ	VM2298A0	DOOR BRACKET UPPER COVER	1	PZ
Code	Description	Qty	UOM																														
VI1220A1	4,2X12.TCB SELF-TAPPIN G SCREW	2	PZ																														
VI1995A0	M5X25 ST.STEEL SCREW	4	PZ																														
VI1997A0	5X10X1 FLAT WASHER	4	PZ																														
VM1224A0	65MY 220MM 2 COLOURS SHRINK TUBE	0.300	M																														
VM2271A0	MM DOOR LEFT UPPER BRACKET	1	PZ																														
VM2298A0	DOOR BRACKET UPPER COVER	1	PZ																														





COMPONENT			SPARE PART																						
Code	Description	Image	Code	Description	Components list																				
0D2310A	XEBC-10EU-E LEFT SIDE PANEL		0D2310A1	XEBC-10EU-E LEFT SIDE PANEL																					
0D2311A	XEBC-10EU-E EXTERNAL RIGHT SIDE		0D2311A1	XEBC-10EU-E EXTERNAL RIGHT SIDE																					
VL1086A	LIMESCALE REMOVER NEODYMIUM MAGNET		KVL1086A	NEODYMIUM MAGNET ANTI-LIMESCALE KI	<table border="1"> <thead> <tr> <th>Code</th> <th>Description</th> <th>Qty</th> <th>UOM</th> </tr> </thead> <tbody> <tr> <td>VL1086A0</td> <td>LIMESCALE REMOVER NEODYMIUM MAGNET</td> <td>2</td> <td>PZ</td> </tr> <tr> <td>VM1224A0</td> <td>65MY 220MM 2 COLOURS SHRINK TUBE</td> <td>0.200</td> <td>M</td> </tr> </tbody> </table>	Code	Description	Qty	UOM	VL1086A0	LIMESCALE REMOVER NEODYMIUM MAGNET	2	PZ	VM1224A0	65MY 220MM 2 COLOURS SHRINK TUBE	0.200	M								
Code	Description	Qty	UOM																						
VL1086A0	LIMESCALE REMOVER NEODYMIUM MAGNET	2	PZ																						
VM1224A0	65MY 220MM 2 COLOURS SHRINK TUBE	0.200	M																						
VL1096A	2PCS T-SHAPED FIT-D6-D10 HOLD-MAGNET		KVL1096A	T - SHAPED FIT-D6-D10 HOLD-2 MAGNETS KIT	<table border="1"> <thead> <tr> <th>Code</th> <th>Description</th> <th>Qty</th> <th>UOM</th> </tr> </thead> <tbody> <tr> <td>RC1018A0</td> <td>ZINC PLATED D12 ELASTIC CLAMP</td> <td>2</td> <td>PZ</td> </tr> <tr> <td>VL1086A0</td> <td>LIMESCALE REMOVER NEODYMIUM MAGNET</td> <td>2</td> <td>PZ</td> </tr> <tr> <td>VL1096A1</td> <td>2PCS T-SHAPED FIT-D6-D10 HOLD-MAGNE</td> <td>1</td> <td>PZ</td> </tr> <tr> <td>VM1224A0</td> <td>65MY 220MM 2 COLOURS SHRINK TUBE</td> <td>0.200</td> <td>M</td> </tr> </tbody> </table>	Code	Description	Qty	UOM	RC1018A0	ZINC PLATED D12 ELASTIC CLAMP	2	PZ	VL1086A0	LIMESCALE REMOVER NEODYMIUM MAGNET	2	PZ	VL1096A1	2PCS T-SHAPED FIT-D6-D10 HOLD-MAGNE	1	PZ	VM1224A0	65MY 220MM 2 COLOURS SHRINK TUBE	0.200	M
Code	Description	Qty	UOM																						
RC1018A0	ZINC PLATED D12 ELASTIC CLAMP	2	PZ																						
VL1086A0	LIMESCALE REMOVER NEODYMIUM MAGNET	2	PZ																						
VL1096A1	2PCS T-SHAPED FIT-D6-D10 HOLD-MAGNE	1	PZ																						
VM1224A0	65MY 220MM 2 COLOURS SHRINK TUBE	0.200	M																						

COMPONENT			SPARE PART																																											
Code	Description	Image	Code	Description	Components list																																									
VM1054A	H7.8 PRESSURE REDUCER RING NUT		KVM1054A	H7.8 PRESSURE REDUCER DIAL KIT	<table border="1"> <thead> <tr> <th>Code</th> <th>Description</th> <th>Qty</th> <th>UOM</th> </tr> </thead> <tbody> <tr> <td>VM1054A0</td> <td>H7.8 PRESSURE REDUCER RING NUT</td> <td>1</td> <td>PZ</td> </tr> <tr> <td>VM1224A0</td> <td>65MY 220MM 2 COLOURS SHRINK TUBE</td> <td>0.200</td> <td>M</td> </tr> </tbody> </table>	Code	Description	Qty	UOM	VM1054A0	H7.8 PRESSURE REDUCER RING NUT	1	PZ	VM1224A0	65MY 220MM 2 COLOURS SHRINK TUBE	0.200	M																													
			Code	Description	Qty	UOM																																								
VM1054A0	H7.8 PRESSURE REDUCER RING NUT	1	PZ																																											
VM1224A0	65MY 220MM 2 COLOURS SHRINK TUBE	0.200	M																																											
KVL1117A	EUR MM 2016+LMT FILTER+PRESS. RED. KIT	<table border="1"> <thead> <tr> <th>Code</th> <th>Description</th> <th>Qty</th> <th>UOM</th> </tr> </thead> <tbody> <tr> <td>0H7472A1</td> <td>DISTRIBUTOR SUPPORT PLATE</td> <td>1</td> <td>PZ</td> </tr> <tr> <td>RC1004A0</td> <td>Ø10-Ø8-8 Y CONNECTION</td> <td>1</td> <td>PZ</td> </tr> <tr> <td>RC1243A0</td> <td>Ø10F-Ø10M ELBOW CONNECTION + JG END KIT</td> <td>1</td> <td>PZ</td> </tr> <tr> <td>RC1372A0</td> <td>Ø10M-1/4 M CIL. STRAIGHT FITTING</td> <td>2</td> <td>PZ</td> </tr> <tr> <td>VI1220A1</td> <td>4,2X12 TCB SELF-TAPPING SCREW</td> <td>4</td> <td>PZ</td> </tr> <tr> <td>VL1014B1</td> <td>PRESSURE REDUCER WITH DISTRIBUTOR</td> <td>1</td> <td>PZ</td> </tr> <tr> <td>VL1014B2</td> <td>PRESSURE REDUCER WITH DISTRIBUTOR</td> <td>1</td> <td>PZ</td> </tr> <tr> <td>VL1034C0</td> <td>MESH WATER FILTER D10</td> <td>1</td> <td>PZ</td> </tr> <tr> <td>VL1062C0</td> <td>PRESSURE REDUCER-FILTER LOCKING FORK</td> <td>1</td> <td>PZ</td> </tr> <tr> <td>VM1054A0</td> <td>H7.8 PRESSURE REDUCER RING NUT</td> <td>1</td> <td>PZ</td> </tr> </tbody> </table>	Code	Description	Qty	UOM	0H7472A1	DISTRIBUTOR SUPPORT PLATE	1	PZ	RC1004A0	Ø10-Ø8-8 Y CONNECTION	1	PZ	RC1243A0	Ø10F-Ø10M ELBOW CONNECTION + JG END KIT	1	PZ	RC1372A0	Ø10M-1/4 M CIL. STRAIGHT FITTING	2	PZ	VI1220A1	4,2X12 TCB SELF-TAPPING SCREW	4	PZ	VL1014B1	PRESSURE REDUCER WITH DISTRIBUTOR	1	PZ	VL1014B2	PRESSURE REDUCER WITH DISTRIBUTOR	1	PZ	VL1034C0	MESH WATER FILTER D10	1	PZ	VL1062C0	PRESSURE REDUCER-FILTER LOCKING FORK	1	PZ	VM1054A0	H7.8 PRESSURE REDUCER RING NUT	1	PZ
Code	Description	Qty	UOM																																											
0H7472A1	DISTRIBUTOR SUPPORT PLATE	1	PZ																																											
RC1004A0	Ø10-Ø8-8 Y CONNECTION	1	PZ																																											
RC1243A0	Ø10F-Ø10M ELBOW CONNECTION + JG END KIT	1	PZ																																											
RC1372A0	Ø10M-1/4 M CIL. STRAIGHT FITTING	2	PZ																																											
VI1220A1	4,2X12 TCB SELF-TAPPING SCREW	4	PZ																																											
VL1014B1	PRESSURE REDUCER WITH DISTRIBUTOR	1	PZ																																											
VL1014B2	PRESSURE REDUCER WITH DISTRIBUTOR	1	PZ																																											
VL1034C0	MESH WATER FILTER D10	1	PZ																																											
VL1062C0	PRESSURE REDUCER-FILTER LOCKING FORK	1	PZ																																											
VM1054A0	H7.8 PRESSURE REDUCER RING NUT	1	PZ																																											
RC1396A	JG D10-1/4 STRAIGHT END FITTING		KVL0014B	EUR 2017 MIND.MAPS PRESSURE REDUCER KIT	<table border="1"> <thead> <tr> <th>Code</th> <th>Description</th> <th>Qty</th> <th>UOM</th> </tr> </thead> <tbody> <tr> <td>RC1372A0</td> <td>Ø10M-1/4 M CIL. STRAIGHT FITTING</td> <td>1</td> <td>PZ</td> </tr> <tr> <td>RC1396A0</td> <td>JG D10-1/4 STRAIGHT END FITTING</td> <td>1</td> <td>PZ</td> </tr> <tr> <td>VL1014B1</td> <td>PRESSURE REDUCER WITH DISTRIBUTOR</td> <td>1</td> <td>PZ</td> </tr> </tbody> </table>	Code	Description	Qty	UOM	RC1372A0	Ø10M-1/4 M CIL. STRAIGHT FITTING	1	PZ	RC1396A0	JG D10-1/4 STRAIGHT END FITTING	1	PZ	VL1014B1	PRESSURE REDUCER WITH DISTRIBUTOR	1	PZ																									
Code	Description	Qty	UOM																																											
RC1372A0	Ø10M-1/4 M CIL. STRAIGHT FITTING	1	PZ																																											
RC1396A0	JG D10-1/4 STRAIGHT END FITTING	1	PZ																																											
VL1014B1	PRESSURE REDUCER WITH DISTRIBUTOR	1	PZ																																											

COMPONENT			SPARE PART																																																										
Code	Description	Image	Code	Description	Components list																																																								
RC1396A	JG D10-1/4 STRAIGHT END FITTING		KVL0014B	EUR 2017 MIND.MAPS PRESSURE REDUCER KIT	<table border="1"> <thead> <tr> <th>Code</th> <th>Description</th> <th>Qty</th> <th>UOM</th> </tr> </thead> <tbody> <tr> <td>VL1014B2</td> <td>PRESSURE REDUCER WITH DISTRIBUTOR</td> <td>1</td> <td>PZ</td> </tr> <tr> <td>VM1054A0</td> <td>H7.8 PRESSURE REDUCER RING NUT</td> <td>1</td> <td>PZ</td> </tr> </tbody> </table>	Code	Description	Qty	UOM	VL1014B2	PRESSURE REDUCER WITH DISTRIBUTOR	1	PZ	VM1054A0	H7.8 PRESSURE REDUCER RING NUT	1	PZ																																												
Code	Description	Qty	UOM																																																										
VL1014B2	PRESSURE REDUCER WITH DISTRIBUTOR	1	PZ																																																										
VM1054A0	H7.8 PRESSURE REDUCER RING NUT	1	PZ																																																										
VL1014B	PRESSURE REDUCER WITH DISTRIBUTOR		<p>KVL0020A</p> <p>KVL0014B</p> <p>KVL0014A</p>	<p>PRESS. REDUCER 03-05XX=OCT18 / MM=MAR19</p> <p>EUR 2017 MIND.MAPS PRESSURE REDUCER KIT</p> <p>EUR MIND.MAPS PRESSURE REDUCER KIT 2016</p>	<table border="1"> <thead> <tr> <th>Code</th> <th>Description</th> <th>Qty</th> <th>UOM</th> </tr> </thead> <tbody> <tr> <td>RC1396A0</td> <td>JG D10-1/4 STRAIGHT END FITTING</td> <td>2</td> <td>PZ</td> </tr> <tr> <td>VL1014B1</td> <td>PRESSURE REDUCER WITH DISTRIBUTOR</td> <td>1</td> <td>PZ</td> </tr> <tr> <td>VL1014B2</td> <td>PRESSURE REDUCER WITH DISTRIBUTOR</td> <td>1</td> <td>PZ</td> </tr> <tr> <td>VM1054A0</td> <td>H7.8 PRESSURE REDUCER RING NUT</td> <td>1</td> <td>PZ</td> </tr> </tbody> </table> <table border="1"> <thead> <tr> <th>Code</th> <th>Description</th> <th>Qty</th> <th>UOM</th> </tr> </thead> <tbody> <tr> <td>RC1372A0</td> <td>Ø10M-1/4 M CIL. STRAIGHT FITTING</td> <td>1</td> <td>PZ</td> </tr> <tr> <td>RC1396A0</td> <td>JG D10-1/4 STRAIGHT END FITTING</td> <td>1</td> <td>PZ</td> </tr> <tr> <td>VL1014B1</td> <td>PRESSURE REDUCER WITH DISTRIBUTOR</td> <td>1</td> <td>PZ</td> </tr> <tr> <td>VL1014B2</td> <td>PRESSURE REDUCER WITH DISTRIBUTOR</td> <td>1</td> <td>PZ</td> </tr> <tr> <td>VM1054A0</td> <td>H7.8 PRESSURE REDUCER RING NUT</td> <td>1</td> <td>PZ</td> </tr> </tbody> </table> <table border="1"> <thead> <tr> <th>Code</th> <th>Description</th> <th>Qty</th> <th>UOM</th> </tr> </thead> <tbody> <tr> <td>RC1372A0</td> <td>Ø10M-1/4 M CIL. STRAIGHT FITTING</td> <td>2</td> <td>PZ</td> </tr> <tr> <td>VL1014B1</td> <td>PRESSURE REDUCER WITH DISTRIBUTOR</td> <td>1</td> <td>PZ</td> </tr> </tbody> </table>	Code	Description	Qty	UOM	RC1396A0	JG D10-1/4 STRAIGHT END FITTING	2	PZ	VL1014B1	PRESSURE REDUCER WITH DISTRIBUTOR	1	PZ	VL1014B2	PRESSURE REDUCER WITH DISTRIBUTOR	1	PZ	VM1054A0	H7.8 PRESSURE REDUCER RING NUT	1	PZ	Code	Description	Qty	UOM	RC1372A0	Ø10M-1/4 M CIL. STRAIGHT FITTING	1	PZ	RC1396A0	JG D10-1/4 STRAIGHT END FITTING	1	PZ	VL1014B1	PRESSURE REDUCER WITH DISTRIBUTOR	1	PZ	VL1014B2	PRESSURE REDUCER WITH DISTRIBUTOR	1	PZ	VM1054A0	H7.8 PRESSURE REDUCER RING NUT	1	PZ	Code	Description	Qty	UOM	RC1372A0	Ø10M-1/4 M CIL. STRAIGHT FITTING	2	PZ	VL1014B1	PRESSURE REDUCER WITH DISTRIBUTOR	1	PZ
Code	Description	Qty	UOM																																																										
RC1396A0	JG D10-1/4 STRAIGHT END FITTING	2	PZ																																																										
VL1014B1	PRESSURE REDUCER WITH DISTRIBUTOR	1	PZ																																																										
VL1014B2	PRESSURE REDUCER WITH DISTRIBUTOR	1	PZ																																																										
VM1054A0	H7.8 PRESSURE REDUCER RING NUT	1	PZ																																																										
Code	Description	Qty	UOM																																																										
RC1372A0	Ø10M-1/4 M CIL. STRAIGHT FITTING	1	PZ																																																										
RC1396A0	JG D10-1/4 STRAIGHT END FITTING	1	PZ																																																										
VL1014B1	PRESSURE REDUCER WITH DISTRIBUTOR	1	PZ																																																										
VL1014B2	PRESSURE REDUCER WITH DISTRIBUTOR	1	PZ																																																										
VM1054A0	H7.8 PRESSURE REDUCER RING NUT	1	PZ																																																										
Code	Description	Qty	UOM																																																										
RC1372A0	Ø10M-1/4 M CIL. STRAIGHT FITTING	2	PZ																																																										
VL1014B1	PRESSURE REDUCER WITH DISTRIBUTOR	1	PZ																																																										

COMPONENT			SPARE PART																		
Code	Description	Image	Code	Description	Components list																
VL1014B	PRESSURE REDUCER WITH DISTRIBUTOR		KVL0014A	EUR MIND.MAPS PRESSURE REDUCER KIT 2016	<table border="1"> <thead> <tr> <th>Code</th> <th>Description</th> <th>Qty</th> <th>UOM</th> </tr> </thead> <tbody> <tr> <td>VL1014B2</td> <td>PRESSURE REDUCER WITH DISTRIBUTOR</td> <td>1</td> <td>PZ</td> </tr> <tr> <td>VM1054A0</td> <td>H7.8 PRESSURE REDUCER RING NUT</td> <td>1</td> <td>PZ</td> </tr> </tbody> </table>	Code	Description	Qty	UOM	VL1014B2	PRESSURE REDUCER WITH DISTRIBUTOR	1	PZ	VM1054A0	H7.8 PRESSURE REDUCER RING NUT	1	PZ				
			Code	Description	Qty	UOM															
VL1014B2	PRESSURE REDUCER WITH DISTRIBUTOR	1	PZ																		
VM1054A0	H7.8 PRESSURE REDUCER RING NUT	1	PZ																		
KVL0010A	S.4 - 5 WATER PRESSURE REDUCER KIT	<table border="1"> <thead> <tr> <th>Code</th> <th>Description</th> <th>Qty</th> <th>UOM</th> </tr> </thead> <tbody> <tr> <td>EL1210A0</td> <td>D8-BSP1/4 JG STRAIGHT END CONNECTION</td> <td>2</td> <td>PZ</td> </tr> <tr> <td>VL1014B1</td> <td>PRESSURE REDUCER WITH DISTRIBUTOR</td> <td>1</td> <td>PZ</td> </tr> <tr> <td>VL1014B2</td> <td>PRESSURE REDUCER WITH DISTRIBUTOR</td> <td>1</td> <td>PZ</td> </tr> </tbody> </table>	Code	Description	Qty	UOM	EL1210A0	D8-BSP1/4 JG STRAIGHT END CONNECTION	2	PZ	VL1014B1	PRESSURE REDUCER WITH DISTRIBUTOR	1	PZ	VL1014B2	PRESSURE REDUCER WITH DISTRIBUTOR	1	PZ			
Code	Description	Qty	UOM																		
EL1210A0	D8-BSP1/4 JG STRAIGHT END CONNECTION	2	PZ																		
VL1014B1	PRESSURE REDUCER WITH DISTRIBUTOR	1	PZ																		
VL1014B2	PRESSURE REDUCER WITH DISTRIBUTOR	1	PZ																		
TB3251A	TB3131A-H2O STEAM INLET PIPE		KTB3131A	WHITE-BLACK 6X12 REINFORCED PIPE 3M KIT	<table border="1"> <thead> <tr> <th>Code</th> <th>Description</th> <th>Qty</th> <th>UOM</th> </tr> </thead> <tbody> <tr> <td>TB3131A0</td> <td>WHITE-BLACK EPDM TEXTILE BRAID HOSE 6X12</td> <td>3</td> <td>M</td> </tr> <tr> <td>VM1794A0</td> <td>250X4.8 PA66 BLACK CLAMP</td> <td>1</td> <td>PZ</td> </tr> </tbody> </table>	Code	Description	Qty	UOM	TB3131A0	WHITE-BLACK EPDM TEXTILE BRAID HOSE 6X12	3	M	VM1794A0	250X4.8 PA66 BLACK CLAMP	1	PZ				
Code	Description	Qty	UOM																		
TB3131A0	WHITE-BLACK EPDM TEXTILE BRAID HOSE 6X12	3	M																		
VM1794A0	250X4.8 PA66 BLACK CLAMP	1	PZ																		
OH8038A	MM REDUCER SUPPORT PLATE		OH8038A0	MM REDUCER SUPPORT PLATE																	
RC1243A	Ø10F-Ø10M ELBOW CONNECTION + JG END KIT		KVL1117A	EUR MM 2016+LMT FILTER+PRESS. RED. KIT	<table border="1"> <thead> <tr> <th>Code</th> <th>Description</th> <th>Qty</th> <th>UOM</th> </tr> </thead> <tbody> <tr> <td>OH7472A1</td> <td>DISTRIBUTOR SUPPORT PLATE</td> <td>1</td> <td>PZ</td> </tr> <tr> <td>RC1004A0</td> <td>Ø10-Ø8-8 Y CONNECTION</td> <td>1</td> <td>PZ</td> </tr> <tr> <td>RC1243A0</td> <td>Ø10F-Ø10M ELBOW CONNECTION + JG END KIT</td> <td>1</td> <td>PZ</td> </tr> </tbody> </table>	Code	Description	Qty	UOM	OH7472A1	DISTRIBUTOR SUPPORT PLATE	1	PZ	RC1004A0	Ø10-Ø8-8 Y CONNECTION	1	PZ	RC1243A0	Ø10F-Ø10M ELBOW CONNECTION + JG END KIT	1	PZ
Code	Description	Qty	UOM																		
OH7472A1	DISTRIBUTOR SUPPORT PLATE	1	PZ																		
RC1004A0	Ø10-Ø8-8 Y CONNECTION	1	PZ																		
RC1243A0	Ø10F-Ø10M ELBOW CONNECTION + JG END KIT	1	PZ																		

COMPONENT			SPARE PART																																		
Code	Description	Image	Code	Description	Components list																																
RC1243A	Ø10F-Ø10M ELBOW CONNECTION + JG END KIT		KVL1117A	EUR MM 2016+LMT FILTER+PRESS. RED. KIT	<table border="1"> <thead> <tr> <th>Code</th> <th>Description</th> <th>Qty</th> <th>UOM</th> </tr> </thead> <tbody> <tr> <td>RC1372A0</td> <td>Ø10M-1/4 M CIL. STRAIGHT FITTING</td> <td>2</td> <td>PZ</td> </tr> <tr> <td>VI1220A1</td> <td>4,2X12 TCB SELF-TAPPING SCREW</td> <td>4</td> <td>PZ</td> </tr> <tr> <td>VL1014B1</td> <td>PRESSURE REDUCER WITH DISTRIBUTOR</td> <td>1</td> <td>PZ</td> </tr> <tr> <td>VL1014B2</td> <td>PRESSURE REDUCER WITH DISTRIBUTOR</td> <td>1</td> <td>PZ</td> </tr> <tr> <td>VL1034C0</td> <td>MESH WATER FILTER D10</td> <td>1</td> <td>PZ</td> </tr> <tr> <td>VL1062C0</td> <td>PRESSURE REDUCER-FILTER LOCKING FORK</td> <td>1</td> <td>PZ</td> </tr> <tr> <td>VM1054A0</td> <td>H7.8 PRESSURE REDUCER RING NUT</td> <td>1</td> <td>PZ</td> </tr> </tbody> </table>	Code	Description	Qty	UOM	RC1372A0	Ø10M-1/4 M CIL. STRAIGHT FITTING	2	PZ	VI1220A1	4,2X12 TCB SELF-TAPPING SCREW	4	PZ	VL1014B1	PRESSURE REDUCER WITH DISTRIBUTOR	1	PZ	VL1014B2	PRESSURE REDUCER WITH DISTRIBUTOR	1	PZ	VL1034C0	MESH WATER FILTER D10	1	PZ	VL1062C0	PRESSURE REDUCER-FILTER LOCKING FORK	1	PZ	VM1054A0	H7.8 PRESSURE REDUCER RING NUT	1	PZ
			Code	Description	Qty	UOM																															
RC1372A0	Ø10M-1/4 M CIL. STRAIGHT FITTING	2	PZ																																		
VI1220A1	4,2X12 TCB SELF-TAPPING SCREW	4	PZ																																		
VL1014B1	PRESSURE REDUCER WITH DISTRIBUTOR	1	PZ																																		
VL1014B2	PRESSURE REDUCER WITH DISTRIBUTOR	1	PZ																																		
VL1034C0	MESH WATER FILTER D10	1	PZ																																		
VL1062C0	PRESSURE REDUCER-FILTER LOCKING FORK	1	PZ																																		
VM1054A0	H7.8 PRESSURE REDUCER RING NUT	1	PZ																																		
KRC1243A	Ø10F-Ø10M ELBOW CONN + JG END 10 PCS KIT	<table border="1"> <thead> <tr> <th>Code</th> <th>Description</th> <th>Qty</th> <th>UOM</th> </tr> </thead> <tbody> <tr> <td>RC1243A0</td> <td>Ø10F-Ø10M ELBOW CONNECTION + JG END KIT</td> <td>10</td> <td>PZ</td> </tr> <tr> <td>VM1224A0</td> <td>65MY 220MM COLOURS SHRINK TUBE</td> <td>2 0.200</td> <td>M</td> </tr> </tbody> </table>	Code	Description	Qty	UOM	RC1243A0	Ø10F-Ø10M ELBOW CONNECTION + JG END KIT	10	PZ	VM1224A0	65MY 220MM COLOURS SHRINK TUBE	2 0.200	M																							
Code	Description	Qty	UOM																																		
RC1243A0	Ø10F-Ø10M ELBOW CONNECTION + JG END KIT	10	PZ																																		
VM1224A0	65MY 220MM COLOURS SHRINK TUBE	2 0.200	M																																		
VL1135A			KVL1135A	3/4-JG10 FITTING WITH FILTER AND VNR KIT	<table border="1"> <thead> <tr> <th>Code</th> <th>Description</th> <th>Qty</th> <th>UOM</th> </tr> </thead> <tbody> <tr> <td>VL1135A0</td> <td>3/4-JG10 CONNECTOR + FILTER AND NRV</td> <td>1</td> <td>PZ</td> </tr> <tr> <td>VM1224A0</td> <td>65MY 220MM COLOURS SHRINK TUBE</td> <td>2 0.150</td> <td>M</td> </tr> </tbody> </table>	Code	Description	Qty	UOM	VL1135A0	3/4-JG10 CONNECTOR + FILTER AND NRV	1	PZ	VM1224A0	65MY 220MM COLOURS SHRINK TUBE	2 0.150	M																				
Code	Description	Qty	UOM																																		
VL1135A0	3/4-JG10 CONNECTOR + FILTER AND NRV	1	PZ																																		
VM1224A0	65MY 220MM COLOURS SHRINK TUBE	2 0.150	M																																		
TR1162A			KTR1136A	330 °C SAFETY THERMOSTAT KIT	<table border="1"> <thead> <tr> <th>Code</th> <th>Description</th> <th>Qty</th> <th>UOM</th> </tr> </thead> <tbody> <tr> <td>0H7030A0</td> <td>THERMOSTAT BULB INLET COVER</td> <td>1</td> <td>PZ</td> </tr> <tr> <td>GN1531A0</td> <td>THERMOSTAT BULB INLET SEALING</td> <td>1</td> <td>PZ</td> </tr> <tr> <td>MOV0011A0</td> <td>HOOD RING GASKET GN1110A2</td> <td>0.100</td> <td>PZ</td> </tr> </tbody> </table>	Code	Description	Qty	UOM	0H7030A0	THERMOSTAT BULB INLET COVER	1	PZ	GN1531A0	THERMOSTAT BULB INLET SEALING	1	PZ	MOV0011A0	HOOD RING GASKET GN1110A2	0.100	PZ																
Code	Description	Qty	UOM																																		
0H7030A0	THERMOSTAT BULB INLET COVER	1	PZ																																		
GN1531A0	THERMOSTAT BULB INLET SEALING	1	PZ																																		
MOV0011A0	HOOD RING GASKET GN1110A2	0.100	PZ																																		



COMPONENT			SPARE PART																		
Code	Description	Image	Code	Description	Components list																
TR1162A			KTR1136A	330 °C SAFETY THERMOSTAT KIT	<table border="1"> <thead> <tr> <th>Code</th> <th>Description</th> <th>Qty</th> <th>UOM</th> </tr> </thead> <tbody> <tr> <td>SL1045A0</td> <td>S57 BLACK SILICONE - 80ML CARTRIDGE</td> <td>1</td> <td>PZ</td> </tr> <tr> <td>TR1136A0</td> <td>330 °C 1 POLE SAFETY THERMOSTAT</td> <td>1</td> <td>PZ</td> </tr> <tr> <td>VI1220A1</td> <td>4,2X12 TCB SELF-TAPPIN G SCREW</td> <td>3</td> <td>PZ</td> </tr> </tbody> </table>	Code	Description	Qty	UOM	SL1045A0	S57 BLACK SILICONE - 80ML CARTRIDGE	1	PZ	TR1136A0	330 °C 1 POLE SAFETY THERMOSTAT	1	PZ	VI1220A1	4,2X12 TCB SELF-TAPPIN G SCREW	3	PZ
Code	Description	Qty	UOM																		
SL1045A0	S57 BLACK SILICONE - 80ML CARTRIDGE	1	PZ																		
TR1136A0	330 °C 1 POLE SAFETY THERMOSTAT	1	PZ																		
VI1220A1	4,2X12 TCB SELF-TAPPIN G SCREW	3	PZ																		