





Codice assieme	Descrizione assieme	Immagine assieme
ASM0016E/0.D02	Copertura esterna	
ASM0011E/0.D00	Camera di cottura	
ASM0023C/0.D00	Porta	
ASM2087E/0.D00	Impianto elettrico	

ASM0016E/0.D02 - Copertura esterna



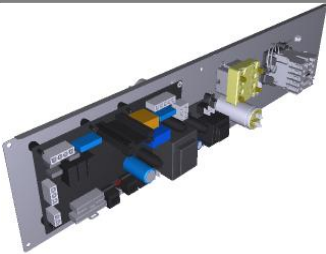
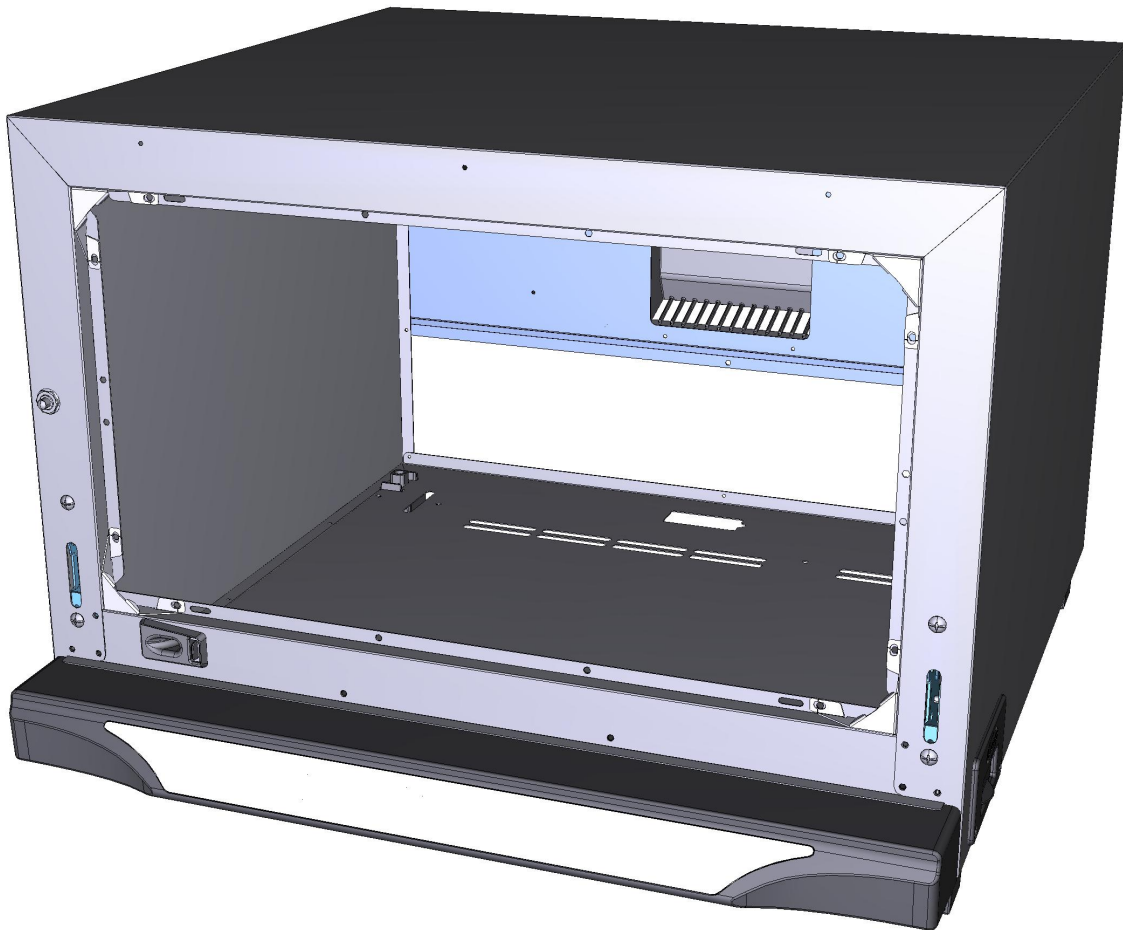

FRONTE





ASM0016E/0.D02 - Copertura esterna

RETRO



COMPONENTE			RICAMBIO																						
Codice	Descrizione	Immagine	Codice	Descrizione	Lista componenti																				
VM1951A	CUFFIA COPRICAMINO IP		KVM1065A	KIT CUFFIA COPRI CAMINO FUMI L.M.	<table border="1"> <thead> <tr> <th>Codice</th> <th>Descrizione</th> <th>Qtà</th> <th>UM</th> </tr> </thead> <tbody> <tr> <td>VM1065A0</td> <td>CUFFIA COPRI CAMINO FUMI L.M.</td> <td>1</td> <td>PZ</td> </tr> </tbody> </table>	Codice	Descrizione	Qtà	UM	VM1065A0	CUFFIA COPRI CAMINO FUMI L.M.	1	PZ												
Codice	Descrizione	Qtà	UM																						
VM1065A0	CUFFIA COPRI CAMINO FUMI L.M.	1	PZ																						
0H1450A	ANGOLO FACCIATA MUFFOLA INOX XB-XV-XG		0H1450A0	ANGOLO FACCIATA MUFFOLA INOX XB-XV-XG																					
PD1001A	PIEDINO 35X35 H26 PLASTICA+GOMMA GRIGIO		KPD1001A	KIT 4 PZ.PIEDINI 35X35 H26	<table border="1"> <thead> <tr> <th>Codice</th> <th>Descrizione</th> <th>Qtà</th> <th>UM</th> </tr> </thead> <tbody> <tr> <td>PD1001A0</td> <td>PIEDINO 35X35 H26 PLASTICA+GO MMA GRIGIO</td> <td>4</td> <td>PZ</td> </tr> </tbody> </table>	Codice	Descrizione	Qtà	UM	PD1001A0	PIEDINO 35X35 H26 PLASTICA+GO MMA GRIGIO	4	PZ												
Codice	Descrizione	Qtà	UM																						
PD1001A0	PIEDINO 35X35 H26 PLASTICA+GO MMA GRIGIO	4	PZ																						
PE2012A	ASSIEME UNOXLINK LM RJ45		KPE2012A	KIT UNOX.LINK LM RJ45	<table border="1"> <thead> <tr> <th>Codice</th> <th>Descrizione</th> <th>Qtà</th> <th>UM</th> </tr> </thead> <tbody> <tr> <td>PE2012A0</td> <td>ASSIEME UNOXLINK LM RJ45</td> <td>1</td> <td>PZ</td> </tr> <tr> <td>VI1960A0</td> <td>VITE AUTOFIL. 4.2X11 TCBS+ AISI410</td> <td>4</td> <td>PZ</td> </tr> </tbody> </table>	Codice	Descrizione	Qtà	UM	PE2012A0	ASSIEME UNOXLINK LM RJ45	1	PZ	VI1960A0	VITE AUTOFIL. 4.2X11 TCBS+ AISI410	4	PZ								
Codice	Descrizione	Qtà	UM																						
PE2012A0	ASSIEME UNOXLINK LM RJ45	1	PZ																						
VI1960A0	VITE AUTOFIL. 4.2X11 TCBS+ AISI410	4	PZ																						
CE1012A	CAVO DI RETE RJ45 L1MT		KVM2190A	KIT CONTROLLO COMPLETO LM600 HAUBIS	<table border="1"> <thead> <tr> <th>Codice</th> <th>Descrizione</th> <th>Qtà</th> <th>UM</th> </tr> </thead> <tbody> <tr> <td>CE1012A0</td> <td>CAVO DI RETE RJ45 L1MT</td> <td>1</td> <td>PZ</td> </tr> <tr> <td>MS1014A0</td> <td>MASCHERINA SERIGRAFATA MATIC LM600 TOUCH</td> <td>1</td> <td>PZ</td> </tr> <tr> <td>MS1014A1</td> <td>MASCHERINA SERIGRAFATA MATIC LM600 TOUCH</td> <td>1</td> <td>PZ</td> </tr> <tr> <td>PE2018B0</td> <td>SCHEDA CONTROLLO LMISS TOUCH HAUBIS</td> <td>1</td> <td>PZ</td> </tr> </tbody> </table>	Codice	Descrizione	Qtà	UM	CE1012A0	CAVO DI RETE RJ45 L1MT	1	PZ	MS1014A0	MASCHERINA SERIGRAFATA MATIC LM600 TOUCH	1	PZ	MS1014A1	MASCHERINA SERIGRAFATA MATIC LM600 TOUCH	1	PZ	PE2018B0	SCHEDA CONTROLLO LMISS TOUCH HAUBIS	1	PZ
Codice	Descrizione	Qtà	UM																						
CE1012A0	CAVO DI RETE RJ45 L1MT	1	PZ																						
MS1014A0	MASCHERINA SERIGRAFATA MATIC LM600 TOUCH	1	PZ																						
MS1014A1	MASCHERINA SERIGRAFATA MATIC LM600 TOUCH	1	PZ																						
PE2018B0	SCHEDA CONTROLLO LMISS TOUCH HAUBIS	1	PZ																						

COMPONENTE			RICAMBIO																															
Codice	Descrizione	Immagine	Codice	Descrizione	Lista componenti																													
CE1012A	CAVO DI RETE RJ45 L1MT		KVM2190A	KIT CONTROLLO COMPLETO LM600 HAUBIS	<table border="1"> <thead> <tr> <th>Codice</th> <th>Descrizione</th> <th>Qtà</th> <th>UM</th> </tr> </thead> <tbody> <tr> <td>VI1635A0</td> <td>VITE M4X8 TSP+ ZINCATA</td> <td>5</td> <td>PZ</td> </tr> <tr> <td>VM1794A0</td> <td>FASCETTA 250X4.8 PA66 NERA</td> <td>2</td> <td>PZ</td> </tr> <tr> <td>VM2016A0</td> <td>CRUSCOTTO COMANDI DYNAMIC LMISS600</td> <td>1</td> <td>PZ</td> </tr> <tr> <td>VM2103A0</td> <td>PIASTRINA FERMAFASCE TTA</td> <td>2</td> <td>PZ</td> </tr> <tr> <td>VM2190A0</td> <td>CONTROLLO COMPLETO LM600 HAUBIS</td> <td>1</td> <td>PZ</td> </tr> </tbody> </table>	Codice	Descrizione	Qtà	UM	VI1635A0	VITE M4X8 TSP+ ZINCATA	5	PZ	VM1794A0	FASCETTA 250X4.8 PA66 NERA	2	PZ	VM2016A0	CRUSCOTTO COMANDI DYNAMIC LMISS600	1	PZ	VM2103A0	PIASTRINA FERMAFASCE TTA	2	PZ	VM2190A0	CONTROLLO COMPLETO LM600 HAUBIS	1	PZ					
			Codice	Descrizione	Qtà	UM																												
			VI1635A0	VITE M4X8 TSP+ ZINCATA	5	PZ																												
VM1794A0	FASCETTA 250X4.8 PA66 NERA	2	PZ																															
VM2016A0	CRUSCOTTO COMANDI DYNAMIC LMISS600	1	PZ																															
VM2103A0	PIASTRINA FERMAFASCE TTA	2	PZ																															
VM2190A0	CONTROLLO COMPLETO LM600 HAUBIS	1	PZ																															
KVM2186A	KIT CONTROLLO COMPLETO LM600 MATIC-TOP	<table border="1"> <thead> <tr> <th>Codice</th> <th>Descrizione</th> <th>Qtà</th> <th>UM</th> </tr> </thead> <tbody> <tr> <td>CE1012A0</td> <td>CAVO DI RETE RJ45 L1MT</td> <td>1</td> <td>PZ</td> </tr> <tr> <td>MS1014A0</td> <td>MASCHERINA SERIGRAFATA MATIC LM600 TOUCH</td> <td>1</td> <td>PZ</td> </tr> <tr> <td>PE1980B0</td> <td>ASM SCHEDA CONTROLLO LMISS TOUCH</td> <td>1</td> <td>PZ</td> </tr> <tr> <td>VI1635A0</td> <td>VITE M4X8 TSP+ ZINCATA</td> <td>5</td> <td>PZ</td> </tr> <tr> <td>VM1794A0</td> <td>FASCETTA 250X4.8 PA66 NERA</td> <td>2</td> <td>PZ</td> </tr> <tr> <td>VM2016A0</td> <td>CRUSCOTTO COMANDI DYNAMIC LMISS600</td> <td>1</td> <td>PZ</td> </tr> <tr> <td>VM2103A0</td> <td>PIASTRINA FERMAFASCE TTA</td> <td>2</td> <td>PZ</td> </tr> </tbody> </table>	Codice	Descrizione	Qtà	UM	CE1012A0	CAVO DI RETE RJ45 L1MT	1	PZ	MS1014A0	MASCHERINA SERIGRAFATA MATIC LM600 TOUCH	1	PZ	PE1980B0	ASM SCHEDA CONTROLLO LMISS TOUCH	1	PZ	VI1635A0	VITE M4X8 TSP+ ZINCATA	5	PZ	VM1794A0	FASCETTA 250X4.8 PA66 NERA	2	PZ	VM2016A0	CRUSCOTTO COMANDI DYNAMIC LMISS600	1	PZ	VM2103A0	PIASTRINA FERMAFASCE TTA	2	PZ
Codice	Descrizione	Qtà	UM																															
CE1012A0	CAVO DI RETE RJ45 L1MT	1	PZ																															
MS1014A0	MASCHERINA SERIGRAFATA MATIC LM600 TOUCH	1	PZ																															
PE1980B0	ASM SCHEDA CONTROLLO LMISS TOUCH	1	PZ																															
VI1635A0	VITE M4X8 TSP+ ZINCATA	5	PZ																															
VM1794A0	FASCETTA 250X4.8 PA66 NERA	2	PZ																															
VM2016A0	CRUSCOTTO COMANDI DYNAMIC LMISS600	1	PZ																															
VM2103A0	PIASTRINA FERMAFASCE TTA	2	PZ																															
KVM2185A	KIT CONTROLLO COMPLETO LM600 DYNAMIC	<table border="1"> <thead> <tr> <th>Codice</th> <th>Descrizione</th> <th>Qtà</th> <th>UM</th> </tr> </thead> <tbody> <tr> <td>CE1012A0</td> <td>CAVO DI RETE RJ45 L1MT</td> <td>1</td> <td>PZ</td> </tr> <tr> <td>MS1012A0</td> <td>MASCHERINA SERIGRAFATA DYNAMIC LM600 TOU</td> <td>1</td> <td>PZ</td> </tr> <tr> <td>PE1980B0</td> <td>ASM SCHEDA CONTROLLO LMISS TOUCH</td> <td>1</td> <td>PZ</td> </tr> <tr> <td>VI1635A0</td> <td>VITE M4X8 TSP+ ZINCATA</td> <td>5</td> <td>PZ</td> </tr> <tr> <td>VM1794A0</td> <td>FASCETTA 250X4.8 PA66 NERA</td> <td>2</td> <td>PZ</td> </tr> </tbody> </table>	Codice	Descrizione	Qtà	UM	CE1012A0	CAVO DI RETE RJ45 L1MT	1	PZ	MS1012A0	MASCHERINA SERIGRAFATA DYNAMIC LM600 TOU	1	PZ	PE1980B0	ASM SCHEDA CONTROLLO LMISS TOUCH	1	PZ	VI1635A0	VITE M4X8 TSP+ ZINCATA	5	PZ	VM1794A0	FASCETTA 250X4.8 PA66 NERA	2	PZ								
Codice	Descrizione	Qtà	UM																															
CE1012A0	CAVO DI RETE RJ45 L1MT	1	PZ																															
MS1012A0	MASCHERINA SERIGRAFATA DYNAMIC LM600 TOU	1	PZ																															
PE1980B0	ASM SCHEDA CONTROLLO LMISS TOUCH	1	PZ																															
VI1635A0	VITE M4X8 TSP+ ZINCATA	5	PZ																															
VM1794A0	FASCETTA 250X4.8 PA66 NERA	2	PZ																															

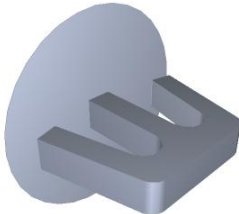
COMPONENTE			RICAMBIO																															
Codice	Descrizione	Immagine	Codice	Descrizione	Lista componenti																													
CE1012A	CAVO DI RETE RJ45 L1MT		KVM2185A	KIT CONTROLLO COMPLETO LM600 DYNAMIC	<table border="1"> <thead> <tr> <th>Codice</th> <th>Descrizione</th> <th>Qtà</th> <th>UM</th> </tr> </thead> <tbody> <tr> <td>VM2016A0</td> <td>CRUSCOTTO COMANDI DYNAMIC LMISS600</td> <td>1</td> <td>PZ</td> </tr> <tr> <td>VM2103A0</td> <td>PIASTRINA FERMAFASCE TTA</td> <td>2</td> <td>PZ</td> </tr> </tbody> </table>	Codice	Descrizione	Qtà	UM	VM2016A0	CRUSCOTTO COMANDI DYNAMIC LMISS600	1	PZ	VM2103A0	PIASTRINA FERMAFASCE TTA	2	PZ																	
			Codice	Descrizione	Qtà	UM																												
			VM2016A0	CRUSCOTTO COMANDI DYNAMIC LMISS600	1	PZ																												
VM2103A0	PIASTRINA FERMAFASCE TTA	2	PZ																															
KVM2184A	KIT CONTROLLO COMPLETO LM600 CLASSIC	<table border="1"> <thead> <tr> <th>Codice</th> <th>Descrizione</th> <th>Qtà</th> <th>UM</th> </tr> </thead> <tbody> <tr> <td>CE1012A0</td> <td>CAVO DI RETE RJ45 L1MT</td> <td>1</td> <td>PZ</td> </tr> <tr> <td>MS1016A0</td> <td>MASCHERINA SERIGRAFATA CLASSIC LM600 TOU</td> <td>1</td> <td>PZ</td> </tr> <tr> <td>PE1980B0</td> <td>ASM SCHEDA CONTROLLO LMISS TOUCH</td> <td>1</td> <td>PZ</td> </tr> <tr> <td>VI1635A0</td> <td>VITE M4X8 TSP+ ZINCATA</td> <td>5</td> <td>PZ</td> </tr> <tr> <td>VM1794A0</td> <td>FASCETTA 250X4.8 PA66 NERA</td> <td>2</td> <td>PZ</td> </tr> <tr> <td>VM2016A0</td> <td>CRUSCOTTO COMANDI DYNAMIC LMISS600</td> <td>1</td> <td>PZ</td> </tr> <tr> <td>VM2103A0</td> <td>PIASTRINA FERMAFASCE TTA</td> <td>2</td> <td>PZ</td> </tr> </tbody> </table>	Codice	Descrizione	Qtà	UM	CE1012A0	CAVO DI RETE RJ45 L1MT	1	PZ	MS1016A0	MASCHERINA SERIGRAFATA CLASSIC LM600 TOU	1	PZ	PE1980B0	ASM SCHEDA CONTROLLO LMISS TOUCH	1	PZ	VI1635A0	VITE M4X8 TSP+ ZINCATA	5	PZ	VM1794A0	FASCETTA 250X4.8 PA66 NERA	2	PZ	VM2016A0	CRUSCOTTO COMANDI DYNAMIC LMISS600	1	PZ	VM2103A0	PIASTRINA FERMAFASCE TTA	2	PZ
Codice	Descrizione	Qtà	UM																															
CE1012A0	CAVO DI RETE RJ45 L1MT	1	PZ																															
MS1016A0	MASCHERINA SERIGRAFATA CLASSIC LM600 TOU	1	PZ																															
PE1980B0	ASM SCHEDA CONTROLLO LMISS TOUCH	1	PZ																															
VI1635A0	VITE M4X8 TSP+ ZINCATA	5	PZ																															
VM1794A0	FASCETTA 250X4.8 PA66 NERA	2	PZ																															
VM2016A0	CRUSCOTTO COMANDI DYNAMIC LMISS600	1	PZ																															
VM2103A0	PIASTRINA FERMAFASCE TTA	2	PZ																															
KCE1012A	KIT CAVO DI RETE RJ45 L1MT	<table border="1"> <thead> <tr> <th>Codice</th> <th>Descrizione</th> <th>Qtà</th> <th>UM</th> </tr> </thead> <tbody> <tr> <td>CE1012A0</td> <td>CAVO DI RETE RJ45 L1MT</td> <td>1</td> <td>PZ</td> </tr> </tbody> </table>	Codice	Descrizione	Qtà	UM	CE1012A0	CAVO DI RETE RJ45 L1MT	1	PZ																								
Codice	Descrizione	Qtà	UM																															
CE1012A0	CAVO DI RETE RJ45 L1MT	1	PZ																															
VM1025A	TAPPO NYLON PA66 V2 GRIGIO Ø16		KVM1025A	KIT 20 TAPPI NYLON PA66 V2 GRIGIO D 6	<table border="1"> <thead> <tr> <th>Codice</th> <th>Descrizione</th> <th>Qtà</th> <th>UM</th> </tr> </thead> <tbody> <tr> <td>VM1025A0</td> <td>TAPPO NYLON PA66 V2 GRIGIO Ø16</td> <td>20</td> <td>PZ</td> </tr> </tbody> </table>	Codice	Descrizione	Qtà	UM	VM1025A0	TAPPO NYLON PA66 V2 GRIGIO Ø16	20	PZ																					
Codice	Descrizione	Qtà	UM																															
VM1025A0	TAPPO NYLON PA66 V2 GRIGIO Ø16	20	PZ																															

COMPONENTE			RICAMBIO														
Codice	Descrizione	Immagine	Codice	Descrizione	Lista componenti												
CR1000A	ATTACCO CERNIERA PORTA FORNO RIBALTA		KCR1000A	KIT ATTACCO CERNIERA RIBALTA LM	<table border="1"> <thead> <tr> <th>Codice</th> <th>Descrizione</th> <th>Qtà</th> <th>UM</th> </tr> </thead> <tbody> <tr> <td>CR1000A0</td> <td>ATTACCO CERNIERA PORTA FORNO RIBALTA</td> <td>1</td> <td>PZ</td> </tr> <tr> <td>VI1875A0</td> <td>VITE M5X10 TC1/2T INOX</td> <td>2</td> <td>PZ</td> </tr> </tbody> </table>	Codice	Descrizione	Qtà	UM	CR1000A0	ATTACCO CERNIERA PORTA FORNO RIBALTA	1	PZ	VI1875A0	VITE M5X10 TC1/2T INOX	2	PZ
Codice	Descrizione	Qtà	UM														
CR1000A0	ATTACCO CERNIERA PORTA FORNO RIBALTA	1	PZ														
VI1875A0	VITE M5X10 TC1/2T INOX	2	PZ														
VE1295A	MICROINTERRUTTO RE PORTA MK 16A 230V UL		KVE1295A	KIT MICROINTERUTTOR E PORTA 16A 230V	<table border="1"> <thead> <tr> <th>Codice</th> <th>Descrizione</th> <th>Qtà</th> <th>UM</th> </tr> </thead> <tbody> <tr> <td>VE1295A0</td> <td>MICROINTERR UTTORE PORTA MK 16A 230V UL</td> <td>1</td> <td>PZ</td> </tr> </tbody> </table>	Codice	Descrizione	Qtà	UM	VE1295A0	MICROINTERR UTTORE PORTA MK 16A 230V UL	1	PZ				
Codice	Descrizione	Qtà	UM														
VE1295A0	MICROINTERR UTTORE PORTA MK 16A 230V UL	1	PZ														
0E1075E	FONDO ESTERNO LM 600		0E1075E0	FONDO ESTERNO LM 600													
VM1952A	COPRIMOTORE IP		KVM1952A	KIT CUFFIA COPRIMOTORE XF/XFT/XAF/XAFT	<table border="1"> <thead> <tr> <th>Codice</th> <th>Descrizione</th> <th>Qtà</th> <th>UM</th> </tr> </thead> <tbody> <tr> <td>VI1220A1</td> <td>VITE AUTOFILETTA NTE 4.2X11 TCS+ MARUTE</td> <td>2</td> <td>PZ</td> </tr> <tr> <td>VM1952A0</td> <td>COPRIMOTOR E IP</td> <td>1</td> <td>PZ</td> </tr> </tbody> </table>	Codice	Descrizione	Qtà	UM	VI1220A1	VITE AUTOFILETTA NTE 4.2X11 TCS+ MARUTE	2	PZ	VM1952A0	COPRIMOTOR E IP	1	PZ
Codice	Descrizione	Qtà	UM														
VI1220A1	VITE AUTOFILETTA NTE 4.2X11 TCS+ MARUTE	2	PZ														
VM1952A0	COPRIMOTOR E IP	1	PZ														
0F1080C	SCHIENA LM STEFANIA		0F1080C0	SCHIENA LM STEFANIA													

COMPONENTE			RICAMBIO										
Codice	Descrizione	Immagine	Codice	Descrizione	Lista componenti								
0D1270C	MANTELLINO LM STEFANIA		0D1270C0	MANTELLINO LM STEFANIA									
VM1225A	PIASTRINA PASSACAVO CONTROLLO CT BT		VM1225A1	PIASTRINA PASSACAVO CONTROLLO CT BT									
VM1556A	PROTEZIONE VENTOLA RAFFREDDAMENTO CT BT		KVM1556A	KIT PROTEZIONE VENTOLA RAFFREDDAMENTO	<table border="1"> <thead> <tr> <th>Codice</th> <th>Descrizione</th> <th>Qta</th> <th>UM</th> </tr> </thead> <tbody> <tr> <td>VM1556A0</td> <td>PROTEZIONE VENTOLA RAFFREDDAME NTO CT BT</td> <td>1</td> <td>PZ</td> </tr> </tbody> </table>	Codice	Descrizione	Qta	UM	VM1556A0	PROTEZIONE VENTOLA RAFFREDDAME NTO CT BT	1	PZ
Codice	Descrizione	Qta	UM										
VM1556A0	PROTEZIONE VENTOLA RAFFREDDAME NTO CT BT	1	PZ										
VN1175A	VENTIL ASSIALE 120X120 230V 50/60HZ 80°C		KVN1175A	KIT VENTIL ASSIALE 120X120 230V 50/60HZ	<table border="1"> <thead> <tr> <th>Codice</th> <th>Descrizione</th> <th>Qta</th> <th>UM</th> </tr> </thead> <tbody> <tr> <td>VN1175A0</td> <td>VENTIL ASSIALE 120X120 230V 50/60HZ 80°C</td> <td>1</td> <td>PZ</td> </tr> </tbody> </table>	Codice	Descrizione	Qta	UM	VN1175A0	VENTIL ASSIALE 120X120 230V 50/60HZ 80°C	1	PZ
Codice	Descrizione	Qta	UM										
VN1175A0	VENTIL ASSIALE 120X120 230V 50/60HZ 80°C	1	PZ										
0D1295B	PROFILO INFERIORE FACCIATA LM 600		0D1295B0	PROFILO INFERIORE FACCIATA LM 600									

COMPONENTE			RICAMBIO																																		
Codice	Descrizione	Immagine	Codice	Descrizione	Lista componenti																																
VM2184B	CONTROLLO COMPLETO LM600 CLASSIC		KVM2184B	KIT CONTROLLO COMPLETO LM600 CLASSIC	<table border="1"> <thead> <tr> <th>Codice</th> <th>Descrizione</th> <th>Qtà</th> <th>UM</th> </tr> </thead> <tbody> <tr> <td>MS1016A1</td> <td>MASCHERINA SERIGRAFATA CLASSIC LM600 TOU</td> <td>1</td> <td>PZ</td> </tr> <tr> <td>PE2018B0</td> <td>SCHEDA CONTROLLO LMISS TOUCH HAUBIS</td> <td>1</td> <td>PZ</td> </tr> <tr> <td>VI1635A0</td> <td>VITE M4X8 TSP+ ZINCATA</td> <td>1</td> <td>PZ</td> </tr> <tr> <td>VM1794A0</td> <td>FASCETTA 250X4.8 PA66 NERA</td> <td>2</td> <td>PZ</td> </tr> <tr> <td>VM2016A0</td> <td>CRUSCOTTO COMANDI DYNAMIC LMISS600</td> <td>1</td> <td>PZ</td> </tr> <tr> <td>VM2103A0</td> <td>PIASTRINA FERMAFASCE TTA</td> <td>2</td> <td>PZ</td> </tr> <tr> <td>VM2184B1</td> <td>CONTROLLO COMPLETO LM600 CLASSI</td> <td>1</td> <td>PZ</td> </tr> </tbody> </table>	Codice	Descrizione	Qtà	UM	MS1016A1	MASCHERINA SERIGRAFATA CLASSIC LM600 TOU	1	PZ	PE2018B0	SCHEDA CONTROLLO LMISS TOUCH HAUBIS	1	PZ	VI1635A0	VITE M4X8 TSP+ ZINCATA	1	PZ	VM1794A0	FASCETTA 250X4.8 PA66 NERA	2	PZ	VM2016A0	CRUSCOTTO COMANDI DYNAMIC LMISS600	1	PZ	VM2103A0	PIASTRINA FERMAFASCE TTA	2	PZ	VM2184B1	CONTROLLO COMPLETO LM600 CLASSI	1	PZ
			Codice	Descrizione	Qtà	UM																															
MS1016A1	MASCHERINA SERIGRAFATA CLASSIC LM600 TOU	1	PZ																																		
PE2018B0	SCHEDA CONTROLLO LMISS TOUCH HAUBIS	1	PZ																																		
VI1635A0	VITE M4X8 TSP+ ZINCATA	1	PZ																																		
VM1794A0	FASCETTA 250X4.8 PA66 NERA	2	PZ																																		
VM2016A0	CRUSCOTTO COMANDI DYNAMIC LMISS600	1	PZ																																		
VM2103A0	PIASTRINA FERMAFASCE TTA	2	PZ																																		
VM2184B1	CONTROLLO COMPLETO LM600 CLASSI	1	PZ																																		
KVM2184A	KIT CONTROLLO COMPLETO LM600 CLASSIC	<table border="1"> <thead> <tr> <th>Codice</th> <th>Descrizione</th> <th>Qtà</th> <th>UM</th> </tr> </thead> <tbody> <tr> <td>CE1012A0</td> <td>CAVO DI RETE RJ45 L1MT</td> <td>1</td> <td>PZ</td> </tr> <tr> <td>MS1016A0</td> <td>MASCHERINA SERIGRAFATA CLASSIC LM600 TOU</td> <td>1</td> <td>PZ</td> </tr> <tr> <td>PE1980B0</td> <td>ASM SCHEDA CONTROLLO LMISS TOUCH</td> <td>1</td> <td>PZ</td> </tr> <tr> <td>VI1635A0</td> <td>VITE M4X8 TSP+ ZINCATA</td> <td>5</td> <td>PZ</td> </tr> <tr> <td>VM1794A0</td> <td>FASCETTA 250X4.8 PA66 NERA</td> <td>2</td> <td>PZ</td> </tr> <tr> <td>VM2016A0</td> <td>CRUSCOTTO COMANDI DYNAMIC LMISS600</td> <td>1</td> <td>PZ</td> </tr> <tr> <td>VM2103A0</td> <td>PIASTRINA FERMAFASCE TTA</td> <td>2</td> <td>PZ</td> </tr> </tbody> </table>	Codice	Descrizione	Qtà	UM	CE1012A0	CAVO DI RETE RJ45 L1MT	1	PZ	MS1016A0	MASCHERINA SERIGRAFATA CLASSIC LM600 TOU	1	PZ	PE1980B0	ASM SCHEDA CONTROLLO LMISS TOUCH	1	PZ	VI1635A0	VITE M4X8 TSP+ ZINCATA	5	PZ	VM1794A0	FASCETTA 250X4.8 PA66 NERA	2	PZ	VM2016A0	CRUSCOTTO COMANDI DYNAMIC LMISS600	1	PZ	VM2103A0	PIASTRINA FERMAFASCE TTA	2	PZ			
Codice	Descrizione	Qtà	UM																																		
CE1012A0	CAVO DI RETE RJ45 L1MT	1	PZ																																		
MS1016A0	MASCHERINA SERIGRAFATA CLASSIC LM600 TOU	1	PZ																																		
PE1980B0	ASM SCHEDA CONTROLLO LMISS TOUCH	1	PZ																																		
VI1635A0	VITE M4X8 TSP+ ZINCATA	5	PZ																																		
VM1794A0	FASCETTA 250X4.8 PA66 NERA	2	PZ																																		
VM2016A0	CRUSCOTTO COMANDI DYNAMIC LMISS600	1	PZ																																		
VM2103A0	PIASTRINA FERMAFASCE TTA	2	PZ																																		

ASM0011E/0.D00 - Camera di cottura

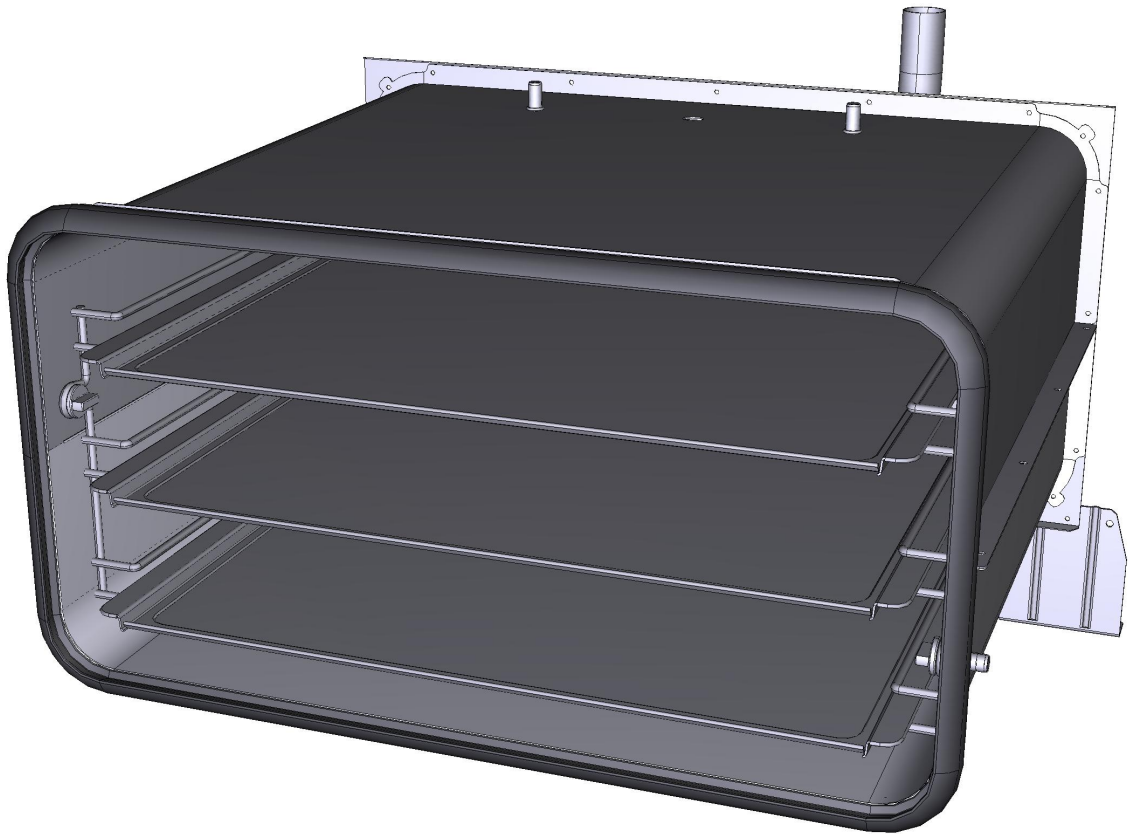

FRONTE





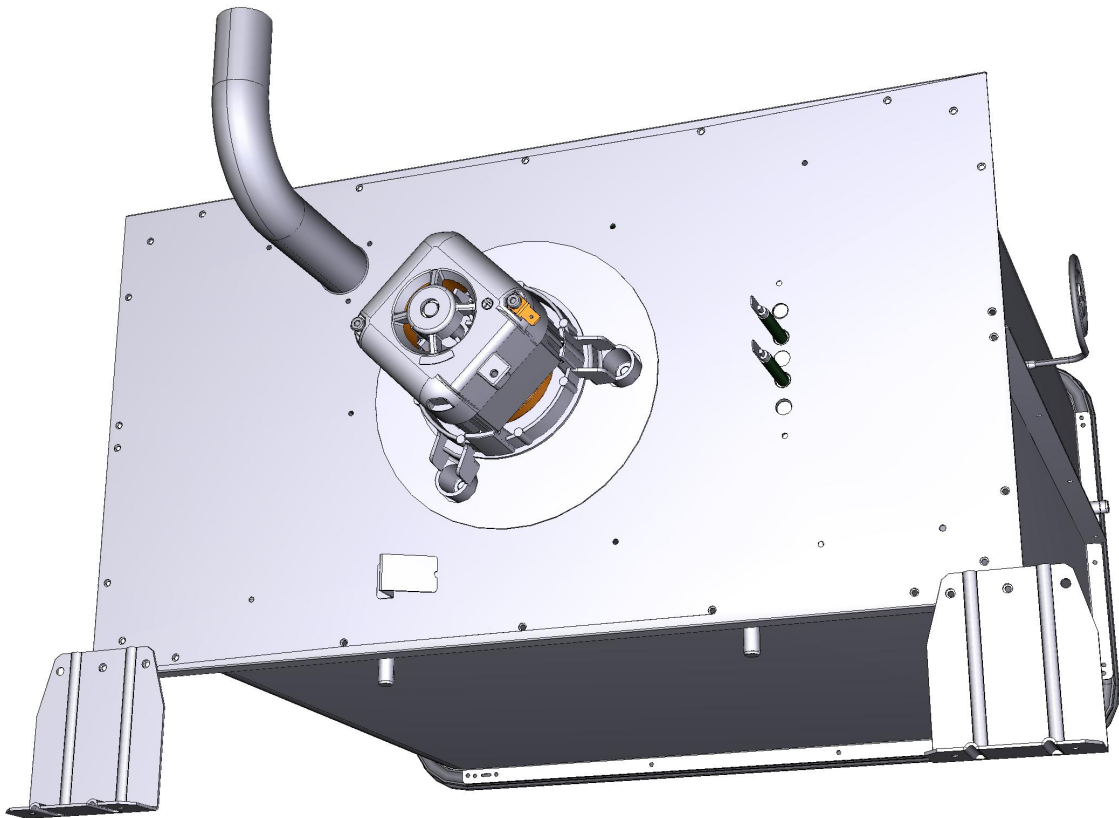

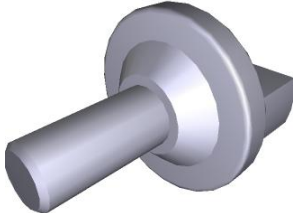

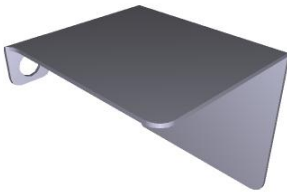

ASM0011E/0.D00 - Camera di cottura

RETRO



COMPONENTE			RICAMBIO																																		
Codice	Descrizione	Immagine	Codice	Descrizione	Lista componenti																																
0H1455A	STAFFA SOSTEGNO MUFFOLA		0H1455A2	STAFFA SOSTEGNO MUFFOLA																																	
VM1815A	NOTTOLINO M6 CROMATO FISS. GRIGLIE		KVM1815A	KIT 10 NOTTOLINI MISS/MICRO/S.4/S.3 SVAS	<table border="1"> <thead> <tr> <th>Codice</th> <th>Descrizione</th> <th>Qtà</th> <th>UM</th> </tr> </thead> <tbody> <tr> <td>VM1815A0</td> <td>NOTTOLINO M6 CROMATO FISS. GRIGLIE</td> <td>10</td> <td>PZ</td> </tr> </tbody> </table>	Codice	Descrizione	Qtà	UM	VM1815A0	NOTTOLINO M6 CROMATO FISS. GRIGLIE	10	PZ																								
Codice	Descrizione	Qtà	UM																																		
VM1815A0	NOTTOLINO M6 CROMATO FISS. GRIGLIE	10	PZ																																		
TR1105A	SONDA TEMPERATURA PT100 L1000		KTR1105A	KIT SONDA TEMPERATURA PT100 L1000	<table border="1"> <thead> <tr> <th>Codice</th> <th>Descrizione</th> <th>Qtà</th> <th>UM</th> </tr> </thead> <tbody> <tr> <td>GN1120A0</td> <td>GUARNIZIONE SONDA DI TEMPERATUR A NTC</td> <td>1</td> <td>PZ</td> </tr> <tr> <td>GN1285A0</td> <td>GUARNIZIONE SONDA DI TEMPERATUR A NTC</td> <td>1</td> <td>PZ</td> </tr> <tr> <td>SL1045A0</td> <td>SILICONE ANTRACITE S53 80 ML</td> <td>1</td> <td>PZ</td> </tr> <tr> <td>TR1105A3</td> <td>SONDA TEMPERATUR A PT100 L1000</td> <td>1</td> <td>PZ</td> </tr> <tr> <td>TR1105A4</td> <td>SONDA TEMPERATUR A PT100 L1000</td> <td>1</td> <td>PZ</td> </tr> <tr> <td>VI1220A1</td> <td>VITE AUTOFILETTA NTE 4.2X11 TCS+ MARUTE</td> <td>2</td> <td>PZ</td> </tr> <tr> <td>VM1465A0</td> <td>COPERCHIO SONDA TEMPERATUR A CHEFTOP</td> <td>1</td> <td>PZ</td> </tr> </tbody> </table>	Codice	Descrizione	Qtà	UM	GN1120A0	GUARNIZIONE SONDA DI TEMPERATUR A NTC	1	PZ	GN1285A0	GUARNIZIONE SONDA DI TEMPERATUR A NTC	1	PZ	SL1045A0	SILICONE ANTRACITE S53 80 ML	1	PZ	TR1105A3	SONDA TEMPERATUR A PT100 L1000	1	PZ	TR1105A4	SONDA TEMPERATUR A PT100 L1000	1	PZ	VI1220A1	VITE AUTOFILETTA NTE 4.2X11 TCS+ MARUTE	2	PZ	VM1465A0	COPERCHIO SONDA TEMPERATUR A CHEFTOP	1	PZ
Codice	Descrizione	Qtà	UM																																		
GN1120A0	GUARNIZIONE SONDA DI TEMPERATUR A NTC	1	PZ																																		
GN1285A0	GUARNIZIONE SONDA DI TEMPERATUR A NTC	1	PZ																																		
SL1045A0	SILICONE ANTRACITE S53 80 ML	1	PZ																																		
TR1105A3	SONDA TEMPERATUR A PT100 L1000	1	PZ																																		
TR1105A4	SONDA TEMPERATUR A PT100 L1000	1	PZ																																		
VI1220A1	VITE AUTOFILETTA NTE 4.2X11 TCS+ MARUTE	2	PZ																																		
VM1465A0	COPERCHIO SONDA TEMPERATUR A CHEFTOP	1	PZ																																		

COMPONENTE			RICAMBIO																						
<i>Codice</i>	<i>Descrizione</i>	<i>Immagine</i>	<i>Codice</i>	<i>Descrizione</i>	<i>Lista componenti</i>																				
TB2120B	CAMINO FUMI LM 600 I30X1		TB2120B0	CAMINO FUMI LM 600 I30X1																					
0H2090B	PIASTRINA USCITA FUMI CAMINO ELEN		0H2090B0	PIASTRINA USCITA FUMI CAMINO ELEN																					
0H3590A	FERMA BULBO TERMOSTATO DI SICUREZZA		0H3590A1	FERMA BULBO TERMOSTATO DI SICUREZZA																					
0C1074A	ANGOLARE FONDO CONVOGLIATORE INOX		0C1074A1	ANGOLARE FONDO CONVOGLIATORE INOX																					
RS1130A	RESISTENZA CIRCOLARE D=230 3 SPIRE		KRS1130A	KIT RESISTENZA STEFANIA/ARIANNA/ ANNA	<table border="1"> <thead> <tr> <th>Codice</th> <th>Descrizione</th> <th>Qtà</th> <th>UM</th> </tr> </thead> <tbody> <tr> <td>GN1327A0</td> <td>GUARNIZIONE RESISTENZA 100X22</td> <td>1</td> <td>PZ</td> </tr> <tr> <td>RS1130A0</td> <td>RESISTENZA CIRCOLARE D=230 3 SPIRE</td> <td>1</td> <td>PZ</td> </tr> <tr> <td>SL1045A0</td> <td>SILICONE ANTRACITE S53 80 ML</td> <td>1</td> <td>PZ</td> </tr> <tr> <td>VI1220A1</td> <td>VITE AUTOFILETTA NTE 4.2X11 TCS+ MARUTE</td> <td>5</td> <td>PZ</td> </tr> </tbody> </table>	Codice	Descrizione	Qtà	UM	GN1327A0	GUARNIZIONE RESISTENZA 100X22	1	PZ	RS1130A0	RESISTENZA CIRCOLARE D=230 3 SPIRE	1	PZ	SL1045A0	SILICONE ANTRACITE S53 80 ML	1	PZ	VI1220A1	VITE AUTOFILETTA NTE 4.2X11 TCS+ MARUTE	5	PZ
Codice	Descrizione	Qtà	UM																						
GN1327A0	GUARNIZIONE RESISTENZA 100X22	1	PZ																						
RS1130A0	RESISTENZA CIRCOLARE D=230 3 SPIRE	1	PZ																						
SL1045A0	SILICONE ANTRACITE S53 80 ML	1	PZ																						
VI1220A1	VITE AUTOFILETTA NTE 4.2X11 TCS+ MARUTE	5	PZ																						

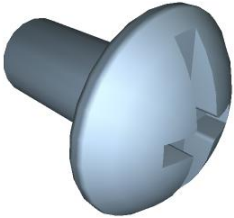
COMPONENTE			RICAMBIO																						
Codice	Descrizione	Immagine	Codice	Descrizione	Lista componenti																				
RS1130A	RESISTENZA CIRCOLARE D=230 3 SPIRE		KRS1130A	KIT RESISTENZA STEFANIA/ARIANNA/ ANNA	<table border="1"> <thead> <tr> <th>Codice</th> <th>Descrizione</th> <th>Qtà</th> <th>UM</th> </tr> </thead> <tbody> <tr> <td>VM1794A0</td> <td>FASCETTA 250X4.8 PA66 NERA</td> <td>2</td> <td>PZ</td> </tr> <tr> <td>VM2103A0</td> <td>PIASTRINA FERMAFASCE TTA</td> <td>2</td> <td>PZ</td> </tr> </tbody> </table>	Codice	Descrizione	Qtà	UM	VM1794A0	FASCETTA 250X4.8 PA66 NERA	2	PZ	VM2103A0	PIASTRINA FERMAFASCE TTA	2	PZ								
Codice	Descrizione	Qtà	UM																						
VM1794A0	FASCETTA 250X4.8 PA66 NERA	2	PZ																						
VM2103A0	PIASTRINA FERMAFASCE TTA	2	PZ																						
GRL1005A	GRIGLIA LATERALE DX/SX CROMATA		KGRL1005A	KIT GRIGLIA LATERALE DX/SX CROMATA	<table border="1"> <thead> <tr> <th>Codice</th> <th>Descrizione</th> <th>Qtà</th> <th>UM</th> </tr> </thead> <tbody> <tr> <td>GRL1005A1</td> <td>GRIGLIA LATERALE DX/SX CROMATA</td> <td>2</td> <td>PZ</td> </tr> <tr> <td>IP1508A0</td> <td>POLISTIROLO PROFILO AD U 2000X60X60</td> <td>2</td> <td>PZ</td> </tr> <tr> <td>IP1508A1</td> <td>POLISTIROLO PROFILO AD U 2000X60X60</td> <td>2</td> <td>M</td> </tr> <tr> <td>VM1059A1</td> <td>FILM TERMORETRA IBILE H800</td> <td>1.500</td> <td>M</td> </tr> </tbody> </table>	Codice	Descrizione	Qtà	UM	GRL1005A1	GRIGLIA LATERALE DX/SX CROMATA	2	PZ	IP1508A0	POLISTIROLO PROFILO AD U 2000X60X60	2	PZ	IP1508A1	POLISTIROLO PROFILO AD U 2000X60X60	2	M	VM1059A1	FILM TERMORETRA IBILE H800	1.500	M
Codice	Descrizione	Qtà	UM																						
GRL1005A1	GRIGLIA LATERALE DX/SX CROMATA	2	PZ																						
IP1508A0	POLISTIROLO PROFILO AD U 2000X60X60	2	PZ																						
IP1508A1	POLISTIROLO PROFILO AD U 2000X60X60	2	M																						
VM1059A1	FILM TERMORETRA IBILE H800	1.500	M																						
GN1351A	GN1110A-GUARNIZI ONE PORTA LM STEFANIA		KGN1351A KGN0010A	KIT GUARNIZIONE PORTA STEFANIA KIT 2,5MT GUARNIZIONE PORTA GN1110A	<table border="1"> <thead> <tr> <th>Codice</th> <th>Descrizione</th> <th>Qtà</th> <th>UM</th> </tr> </thead> <tbody> <tr> <td>GN1110A2</td> <td>GUARNIZIONE PORTA PROFILO 248</td> <td>1.410</td> <td>M</td> </tr> </tbody> </table> <table border="1"> <thead> <tr> <th>Codice</th> <th>Descrizione</th> <th>Qtà</th> <th>UM</th> </tr> </thead> <tbody> <tr> <td>GN1110A2</td> <td>GUARNIZIONE PORTA PROFILO 248</td> <td>2.500</td> <td>M</td> </tr> </tbody> </table>	Codice	Descrizione	Qtà	UM	GN1110A2	GUARNIZIONE PORTA PROFILO 248	1.410	M	Codice	Descrizione	Qtà	UM	GN1110A2	GUARNIZIONE PORTA PROFILO 248	2.500	M				
Codice	Descrizione	Qtà	UM																						
GN1110A2	GUARNIZIONE PORTA PROFILO 248	1.410	M																						
Codice	Descrizione	Qtà	UM																						
GN1110A2	GUARNIZIONE PORTA PROFILO 248	2.500	M																						
0H3020A	DISCO TENUTA ALBERO MOTORE		0H3020A1	DISCO TENUTA ALBERO MOTORE																					
VI1785A	VITE M6X12 T1/2T COMBI OTTONE CROMATO		KVI1785A	KIT VITE M6X12 ROTOR 20 PZ.	<table border="1"> <thead> <tr> <th>Codice</th> <th>Descrizione</th> <th>Qtà</th> <th>UM</th> </tr> </thead> <tbody> <tr> <td>VI1300A0</td> <td>VITE M6X12 T1/2T+ INOX</td> <td>20</td> <td>PZ</td> </tr> <tr> <td>VI1785A1</td> <td>VITE M6X12 T1/2T COMBI OTTONE CROMATO</td> <td>20</td> <td>PZ</td> </tr> </tbody> </table>	Codice	Descrizione	Qtà	UM	VI1300A0	VITE M6X12 T1/2T+ INOX	20	PZ	VI1785A1	VITE M6X12 T1/2T COMBI OTTONE CROMATO	20	PZ								
Codice	Descrizione	Qtà	UM																						
VI1300A0	VITE M6X12 T1/2T+ INOX	20	PZ																						
VI1785A1	VITE M6X12 T1/2T COMBI OTTONE CROMATO	20	PZ																						

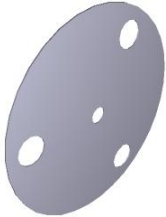
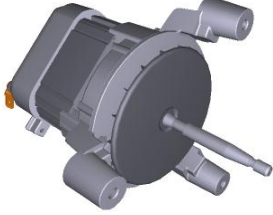
COMPONENTE			RICAMBIO																																						
Codice	Descrizione	Immagine	Codice	Descrizione	Lista componenti																																				
VN1050A	VENTOLA D=196 H=32 38 PALE INOX DADO M6		KVN1050A	KIT VENTOLA D196 H32	<table border="1"> <thead> <tr> <th>Codice</th> <th>Descrizione</th> <th>Qtà</th> <th>UM</th> </tr> </thead> <tbody> <tr> <td>VI1695A0</td> <td>DADO M6X1 H6 CH10 INOX</td> <td>1</td> <td>PZ</td> </tr> <tr> <td>VI1700A0</td> <td>RONDELLA PIANA 18X6.4X1.5 INOX</td> <td>1</td> <td>PZ</td> </tr> <tr> <td>VN1050A2</td> <td>VENTOLA D=196 H=32 38 PALE INOX DADO M6</td> <td>1</td> <td>PZ</td> </tr> </tbody> </table>	Codice	Descrizione	Qtà	UM	VI1695A0	DADO M6X1 H6 CH10 INOX	1	PZ	VI1700A0	RONDELLA PIANA 18X6.4X1.5 INOX	1	PZ	VN1050A2	VENTOLA D=196 H=32 38 PALE INOX DADO M6	1	PZ																				
Codice	Descrizione	Qtà	UM																																						
VI1695A0	DADO M6X1 H6 CH10 INOX	1	PZ																																						
VI1700A0	RONDELLA PIANA 18X6.4X1.5 INOX	1	PZ																																						
VN1050A2	VENTOLA D=196 H=32 38 PALE INOX DADO M6	1	PZ																																						
0H3585A	LAMIERA PROTEZIONE MOTORE ZINCATO L.M.		0H3585A0	LAMIERA PROTEZIONE MOTORE ZINCATO L.M.																																					
VN1035B	MOTORE SISME 230 VAC LINE MISS		KVN1036A	KIT MOTORE 230V 50/60HZ XF	<table border="1"> <thead> <tr> <th>Codice</th> <th>Descrizione</th> <th>Qtà</th> <th>UM</th> </tr> </thead> <tbody> <tr> <td>0H3740A0</td> <td>BOCCOLA RICAMBIO VN1035A1</td> <td>3</td> <td>PZ</td> </tr> <tr> <td>GN1135A2</td> <td>GUARNIZIONE PORTAMOTO RE STAMP.</td> <td>1</td> <td>PZ</td> </tr> <tr> <td>GN1546A0</td> <td>GUARNIZIONE ALBERO MOTORE D8</td> <td>1</td> <td>PZ</td> </tr> <tr> <td>VI1695A0</td> <td>DADO M6X1 H6 CH10 INOX</td> <td>1</td> <td>PZ</td> </tr> <tr> <td>VI1700A0</td> <td>RONDELLA PIANA 18X6.4X1.5 INOX</td> <td>1</td> <td>PZ</td> </tr> <tr> <td>VI1835A1</td> <td>VITE M6X20 TE FLANGIA ZIGRINATA ZN 8</td> <td>3</td> <td>PZ</td> </tr> <tr> <td>VM2103A0</td> <td>PIASTRINA FERMAFASCE TTA</td> <td>2</td> <td>PZ</td> </tr> <tr> <td>VN1036A1</td> <td>MOTORE RICAMBIO LM 600 230 V 50/60 HZ</td> <td>1</td> <td>PZ</td> </tr> </tbody> </table>	Codice	Descrizione	Qtà	UM	0H3740A0	BOCCOLA RICAMBIO VN1035A1	3	PZ	GN1135A2	GUARNIZIONE PORTAMOTO RE STAMP.	1	PZ	GN1546A0	GUARNIZIONE ALBERO MOTORE D8	1	PZ	VI1695A0	DADO M6X1 H6 CH10 INOX	1	PZ	VI1700A0	RONDELLA PIANA 18X6.4X1.5 INOX	1	PZ	VI1835A1	VITE M6X20 TE FLANGIA ZIGRINATA ZN 8	3	PZ	VM2103A0	PIASTRINA FERMAFASCE TTA	2	PZ	VN1036A1	MOTORE RICAMBIO LM 600 230 V 50/60 HZ	1	PZ
Codice	Descrizione	Qtà	UM																																						
0H3740A0	BOCCOLA RICAMBIO VN1035A1	3	PZ																																						
GN1135A2	GUARNIZIONE PORTAMOTO RE STAMP.	1	PZ																																						
GN1546A0	GUARNIZIONE ALBERO MOTORE D8	1	PZ																																						
VI1695A0	DADO M6X1 H6 CH10 INOX	1	PZ																																						
VI1700A0	RONDELLA PIANA 18X6.4X1.5 INOX	1	PZ																																						
VI1835A1	VITE M6X20 TE FLANGIA ZIGRINATA ZN 8	3	PZ																																						
VM2103A0	PIASTRINA FERMAFASCE TTA	2	PZ																																						
VN1036A1	MOTORE RICAMBIO LM 600 230 V 50/60 HZ	1	PZ																																						
			KVN1035B	KIT MOTORE LINEMISS / LINEMICRO	<table border="1"> <thead> <tr> <th>Codice</th> <th>Descrizione</th> <th>Qtà</th> <th>UM</th> </tr> </thead> <tbody> <tr> <td>GN1135A2</td> <td>GUARNIZIONE PORTAMOTO RE STAMP.</td> <td>1</td> <td>PZ</td> </tr> </tbody> </table>	Codice	Descrizione	Qtà	UM	GN1135A2	GUARNIZIONE PORTAMOTO RE STAMP.	1	PZ																												
Codice	Descrizione	Qtà	UM																																						
GN1135A2	GUARNIZIONE PORTAMOTO RE STAMP.	1	PZ																																						

COMPONENTE			RICAMBIO																																						
Codice	Descrizione	Immagine	Codice	Descrizione	Lista componenti																																				
VN1035B	MOTORE SISME 230 VAC LINE MISS		KVN1035B	KIT MOTORE LINEMISS / LINEMICRO	<table border="1"> <thead> <tr> <th>Codice</th> <th>Descrizione</th> <th>Qtà</th> <th>UM</th> </tr> </thead> <tbody> <tr> <td>GN1270A0</td> <td>RONDELLA PIANA 13X5.5X0.8 CARBOGRAFI TE</td> <td>3</td> <td>PZ</td> </tr> <tr> <td>GN1546A0</td> <td>GUARNIZIONE ALBERO MOTORE D8</td> <td>1</td> <td>PZ</td> </tr> <tr> <td>VI1695A0</td> <td>DADO M6X1 H6 CH10 INOX</td> <td>1</td> <td>PZ</td> </tr> <tr> <td>VI1700A0</td> <td>RONDELLA PIANA 18X6.4X1.5 INOX</td> <td>1</td> <td>PZ</td> </tr> <tr> <td>VI1836A0</td> <td>VITE M6X12 TE FLANGIA LISCIA OT63 ROTOR</td> <td>3</td> <td>PZ</td> </tr> <tr> <td>VM1794A0</td> <td>FASCETTA 250X4.8 PA66 NERA</td> <td>3</td> <td>PZ</td> </tr> <tr> <td>VM2103A0</td> <td>PIASTRINA FERMAFASCE TTA</td> <td>3</td> <td>PZ</td> </tr> <tr> <td>VN1035B1</td> <td>MOTORE SISME 230 VAC LINE MIS</td> <td>1</td> <td>PZ</td> </tr> </tbody> </table>	Codice	Descrizione	Qtà	UM	GN1270A0	RONDELLA PIANA 13X5.5X0.8 CARBOGRAFI TE	3	PZ	GN1546A0	GUARNIZIONE ALBERO MOTORE D8	1	PZ	VI1695A0	DADO M6X1 H6 CH10 INOX	1	PZ	VI1700A0	RONDELLA PIANA 18X6.4X1.5 INOX	1	PZ	VI1836A0	VITE M6X12 TE FLANGIA LISCIA OT63 ROTOR	3	PZ	VM1794A0	FASCETTA 250X4.8 PA66 NERA	3	PZ	VM2103A0	PIASTRINA FERMAFASCE TTA	3	PZ	VN1035B1	MOTORE SISME 230 VAC LINE MIS	1	PZ
			Codice	Descrizione	Qtà	UM																																			
GN1270A0	RONDELLA PIANA 13X5.5X0.8 CARBOGRAFI TE	3	PZ																																						
GN1546A0	GUARNIZIONE ALBERO MOTORE D8	1	PZ																																						
VI1695A0	DADO M6X1 H6 CH10 INOX	1	PZ																																						
VI1700A0	RONDELLA PIANA 18X6.4X1.5 INOX	1	PZ																																						
VI1836A0	VITE M6X12 TE FLANGIA LISCIA OT63 ROTOR	3	PZ																																						
VM1794A0	FASCETTA 250X4.8 PA66 NERA	3	PZ																																						
VM2103A0	PIASTRINA FERMAFASCE TTA	3	PZ																																						
VN1035B1	MOTORE SISME 230 VAC LINE MIS	1	PZ																																						
KVN1035A	KIT MOTORE VN1035A 230V	<table border="1"> <thead> <tr> <th>Codice</th> <th>Descrizione</th> <th>Qtà</th> <th>UM</th> </tr> </thead> <tbody> <tr> <td>GN1135A2</td> <td>GUARNIZIONE PORTAMOTO RE STAMP.</td> <td>1</td> <td>PZ</td> </tr> <tr> <td>IP1030A1</td> <td>IMB POL INF SAG D10 MOTORE RICAMBI</td> <td>1</td> <td>PZ</td> </tr> <tr> <td>IP1031A1</td> <td>IMB POL SUP SAG D10 MOTORE RICAMBI</td> <td>1</td> <td>PZ</td> </tr> <tr> <td>VI1695A0</td> <td>DADO M6X1 H6 CH10 INOX</td> <td>1</td> <td>PZ</td> </tr> <tr> <td>VI1700A0</td> <td>RONDELLA PIANA 18X6.4X1.5 INOX</td> <td>1</td> <td>PZ</td> </tr> <tr> <td>VN1035A1</td> <td>MOTORE SISME 230 VAC LINE MIS</td> <td>1</td> <td>PZ</td> </tr> </tbody> </table>	Codice	Descrizione	Qtà	UM	GN1135A2	GUARNIZIONE PORTAMOTO RE STAMP.	1	PZ	IP1030A1	IMB POL INF SAG D10 MOTORE RICAMBI	1	PZ	IP1031A1	IMB POL SUP SAG D10 MOTORE RICAMBI	1	PZ	VI1695A0	DADO M6X1 H6 CH10 INOX	1	PZ	VI1700A0	RONDELLA PIANA 18X6.4X1.5 INOX	1	PZ	VN1035A1	MOTORE SISME 230 VAC LINE MIS	1	PZ											
Codice	Descrizione	Qtà	UM																																						
GN1135A2	GUARNIZIONE PORTAMOTO RE STAMP.	1	PZ																																						
IP1030A1	IMB POL INF SAG D10 MOTORE RICAMBI	1	PZ																																						
IP1031A1	IMB POL SUP SAG D10 MOTORE RICAMBI	1	PZ																																						
VI1695A0	DADO M6X1 H6 CH10 INOX	1	PZ																																						
VI1700A0	RONDELLA PIANA 18X6.4X1.5 INOX	1	PZ																																						
VN1035A1	MOTORE SISME 230 VAC LINE MIS	1	PZ																																						

COMPONENTE			RICAMBIO		
<i>Codice</i>	<i>Descrizione</i>	<i>Immagine</i>	<i>Codice</i>	<i>Descrizione</i>	<i>Lista componenti</i>
GN1546A	GUARNIZIONE ALBERO MOTORE D		GN1546A0	GUARNIZIONE ALBERO MOTORE D	
0G1104A	CARTER ARIA LM STEFANIA CLASSIC		0G1104A0	CARTER ARIA LM STEFANIA CLASSIC	
ATG305	TEGLIA 460X330 PIANA ALLUMINIO		ATG3050	TEGLIA 460X330 PIANA ALLUMINIO	

ASM0023C/0.D00 - Porta



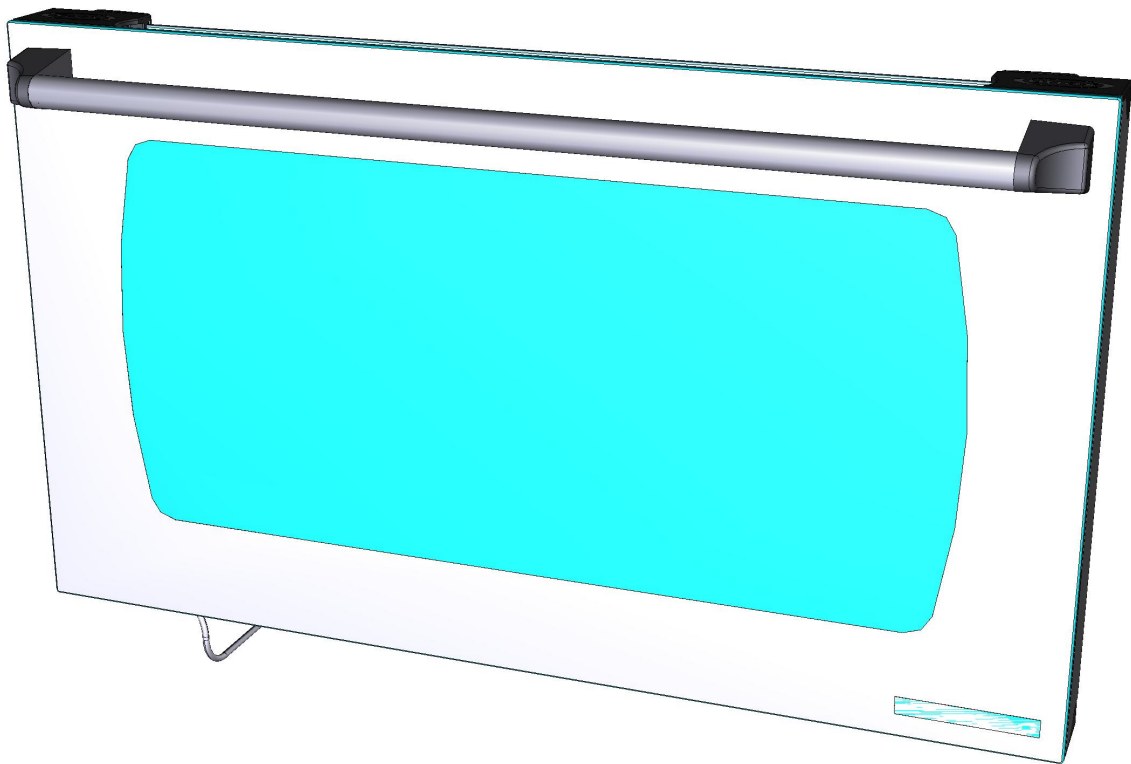

FRONTE



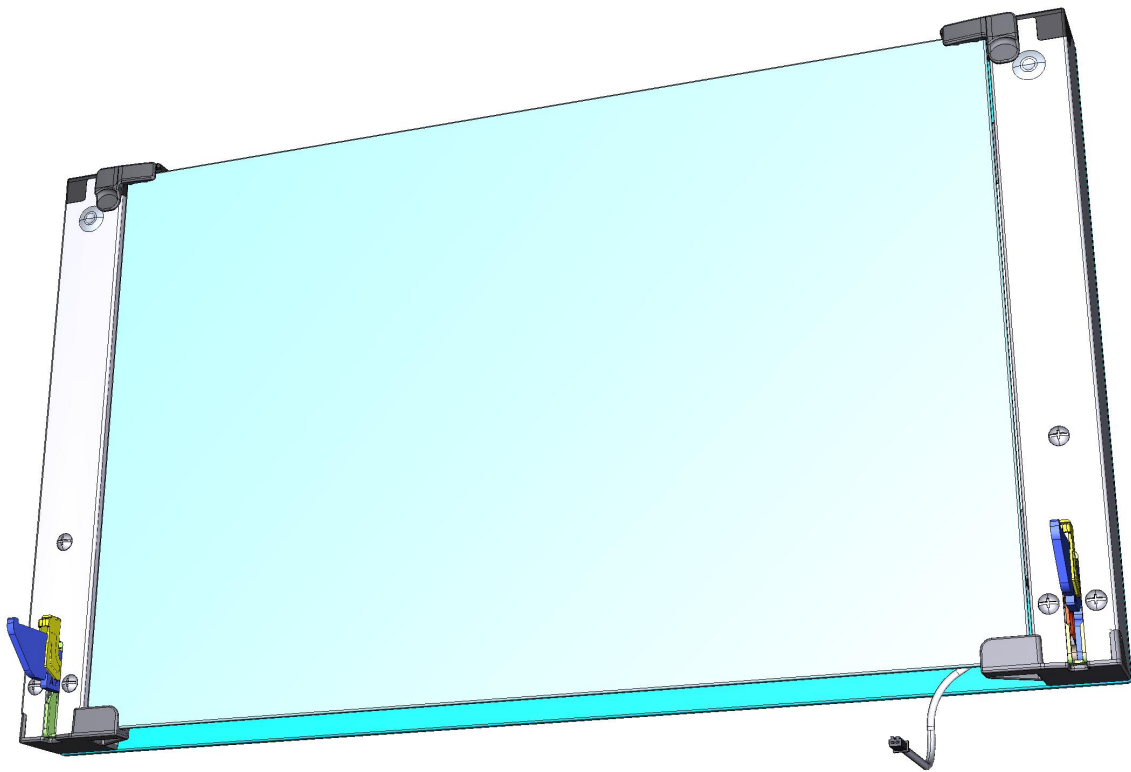

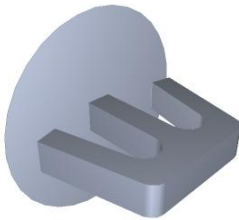
ASM0023C/0.D00 - Porta

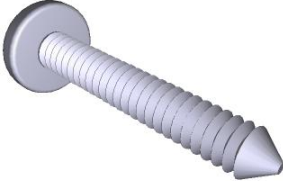
RETRO





COMPONENTE			RICAMBIO																										
Codice	Descrizione	Immagine	Codice	Descrizione	Lista componenti																								
VM1025A	TAPPO NYLON PA66 V2 GRIGIO Ø16		KVM1025A	KIT 20 TAPPI NYLON PA66 V2 GRIGIO D 6	<table border="1"> <thead> <tr> <th>Codice</th> <th>Descrizione</th> <th>Qtà</th> <th>UM</th> </tr> </thead> <tbody> <tr> <td>VM1025A0</td> <td>TAPPO NYLON PA66 V2 GRIGIO Ø16</td> <td>20</td> <td>PZ</td> </tr> </tbody> </table>	Codice	Descrizione	Qtà	UM	VM1025A0	TAPPO NYLON PA66 V2 GRIGIO Ø16	20	PZ																
Codice	Descrizione	Qtà	UM																										
VM1025A0	TAPPO NYLON PA66 V2 GRIGIO Ø16	20	PZ																										
MG1015B	TERMINALE MANIGLIA LMISS/LMICR/CHE FTOP		KMG1015B	KIT 2 PZ.TERMINALE MANIGLIA	<table border="1"> <thead> <tr> <th>Codice</th> <th>Descrizione</th> <th>Qtà</th> <th>UM</th> </tr> </thead> <tbody> <tr> <td>MG1015B0</td> <td>TERMINALE MANIGLIA LMISS/LMICR O/CHEFTOP</td> <td>2</td> <td>PZ</td> </tr> <tr> <td>VI1855A0</td> <td>VITE AUTOFIL. 5X25 TCB+</td> <td>2</td> <td>PZ</td> </tr> <tr> <td>VI1870A0</td> <td>VITE AUTOFIL. X PLASTICA 5X50 TCB+</td> <td>2</td> <td>PZ</td> </tr> <tr> <td>VM1025A0</td> <td>TAPPO NYLON PA66 V2 GRIGIO Ø16</td> <td>2</td> <td>PZ</td> </tr> </tbody> </table>	Codice	Descrizione	Qtà	UM	MG1015B0	TERMINALE MANIGLIA LMISS/LMICR O/CHEFTOP	2	PZ	VI1855A0	VITE AUTOFIL. 5X25 TCB+	2	PZ	VI1870A0	VITE AUTOFIL. X PLASTICA 5X50 TCB+	2	PZ	VM1025A0	TAPPO NYLON PA66 V2 GRIGIO Ø16	2	PZ				
Codice	Descrizione	Qtà	UM																										
MG1015B0	TERMINALE MANIGLIA LMISS/LMICR O/CHEFTOP	2	PZ																										
VI1855A0	VITE AUTOFIL. 5X25 TCB+	2	PZ																										
VI1870A0	VITE AUTOFIL. X PLASTICA 5X50 TCB+	2	PZ																										
VM1025A0	TAPPO NYLON PA66 V2 GRIGIO Ø16	2	PZ																										
VI1855A	VITE AUTOFIL. 5X25 TCB+		KVI1855A	KIT VITE 5X25 UTOFILETTANTE 20 PZ.	<table border="1"> <thead> <tr> <th>Codice</th> <th>Descrizione</th> <th>Qtà</th> <th>UM</th> </tr> </thead> <tbody> <tr> <td>VI1855A0</td> <td>VITE AUTOFIL. 5X25 TCB+</td> <td>20</td> <td>PZ</td> </tr> </tbody> </table>	Codice	Descrizione	Qtà	UM	VI1855A0	VITE AUTOFIL. 5X25 TCB+	20	PZ																
Codice	Descrizione	Qtà	UM																										
VI1855A0	VITE AUTOFIL. 5X25 TCB+	20	PZ																										
0H1925B	TUBO MANIGLIA L= 518 Ø18X1		K0H1925B	KIT MANIGLIA COMPLETA LMISS 600	<table border="1"> <thead> <tr> <th>Codice</th> <th>Descrizione</th> <th>Qtà</th> <th>UM</th> </tr> </thead> <tbody> <tr> <td>0H1925B0</td> <td>TUBO MANIGLIA L= 518 Ø18X1</td> <td>1</td> <td>PZ</td> </tr> <tr> <td>MG1015B0</td> <td>TERMINALE MANIGLIA LMISS/LMICR O/CHEFTOP</td> <td>2</td> <td>PZ</td> </tr> <tr> <td>VI1855A0</td> <td>VITE AUTOFIL. 5X25 TCB+</td> <td>2</td> <td>PZ</td> </tr> <tr> <td>VM1794A0</td> <td>FASCETTA 250X4.8 PA66 NERA</td> <td>2</td> <td>PZ</td> </tr> <tr> <td>VM2103A0</td> <td>PIASTRINA FERMAFASCE TTA</td> <td>2</td> <td>PZ</td> </tr> </tbody> </table>	Codice	Descrizione	Qtà	UM	0H1925B0	TUBO MANIGLIA L= 518 Ø18X1	1	PZ	MG1015B0	TERMINALE MANIGLIA LMISS/LMICR O/CHEFTOP	2	PZ	VI1855A0	VITE AUTOFIL. 5X25 TCB+	2	PZ	VM1794A0	FASCETTA 250X4.8 PA66 NERA	2	PZ	VM2103A0	PIASTRINA FERMAFASCE TTA	2	PZ
Codice	Descrizione	Qtà	UM																										
0H1925B0	TUBO MANIGLIA L= 518 Ø18X1	1	PZ																										
MG1015B0	TERMINALE MANIGLIA LMISS/LMICR O/CHEFTOP	2	PZ																										
VI1855A0	VITE AUTOFIL. 5X25 TCB+	2	PZ																										
VM1794A0	FASCETTA 250X4.8 PA66 NERA	2	PZ																										
VM2103A0	PIASTRINA FERMAFASCE TTA	2	PZ																										

COMPONENTE			RICAMBIO																																																										
Codice	Descrizione	Immagine	Codice	Descrizione	Lista componenti																																																								
VM2064A	TAPPO COLONNINA LM600 INF DX		KVT1252A	KIT VETRO ESTERNO XF135-EG VT1252A	<table border="1"> <thead> <tr> <th>Codice</th> <th>Descrizione</th> <th>Qtà</th> <th>UM</th> </tr> </thead> <tbody> <tr> <td>RC1200A0</td> <td>MOLLA A COMPRESSIO NE DE4 DF0.5 H24</td> <td>2</td> <td>PZ</td> </tr> <tr> <td>SL1050A1</td> <td>NASTRO BIADESIVO 3M TRANSFER VH</td> <td>0.820</td> <td>M</td> </tr> <tr> <td>TB2301A0</td> <td>COLONNINA DX XVC105E 40X40X1</td> <td>2</td> <td>PZ</td> </tr> <tr> <td>TB3081A0</td> <td>COLONNINA SX LM ARI-RO</td> <td>1</td> <td>PZ</td> </tr> <tr> <td>VM1025A0</td> <td>TAPPO NYLON PA66 V2 GRIGIO Ø16</td> <td>2</td> <td>PZ</td> </tr> <tr> <td>VM1695A0</td> <td>PERNO POSIZIONE MANIGLIA</td> <td>2</td> <td>PZ</td> </tr> <tr> <td>VM1920A0</td> <td>PIASTRINA DX CHIUSURA VETRO INT</td> <td>1</td> <td>PZ</td> </tr> <tr> <td>VM1921A0</td> <td>PIASTRINA SX CHIUSURA VETRO INT</td> <td>1</td> <td>PZ</td> </tr> <tr> <td>VM2062A0</td> <td>TAPPO COLONNINA LM600 SUP DX</td> <td>1</td> <td>PZ</td> </tr> <tr> <td>VM2063A0</td> <td>TAPPO COLONNINA LM600 SUP SX</td> <td>1</td> <td>PZ</td> </tr> <tr> <td>VM2064A0</td> <td>TAPPO COLONNINA LM600 INF DX</td> <td>1</td> <td>PZ</td> </tr> <tr> <td>VM2065A0</td> <td>TAPPO COLONNINA LM600 INF SX</td> <td>1</td> <td>PZ</td> </tr> <tr> <td>VT1252A0</td> <td>VETRO EST.XF135 NERO ENGEFOOD</td> <td>1</td> <td>PZ</td> </tr> </tbody> </table>	Codice	Descrizione	Qtà	UM	RC1200A0	MOLLA A COMPRESSIO NE DE4 DF0.5 H24	2	PZ	SL1050A1	NASTRO BIADESIVO 3M TRANSFER VH	0.820	M	TB2301A0	COLONNINA DX XVC105E 40X40X1	2	PZ	TB3081A0	COLONNINA SX LM ARI-RO	1	PZ	VM1025A0	TAPPO NYLON PA66 V2 GRIGIO Ø16	2	PZ	VM1695A0	PERNO POSIZIONE MANIGLIA	2	PZ	VM1920A0	PIASTRINA DX CHIUSURA VETRO INT	1	PZ	VM1921A0	PIASTRINA SX CHIUSURA VETRO INT	1	PZ	VM2062A0	TAPPO COLONNINA LM600 SUP DX	1	PZ	VM2063A0	TAPPO COLONNINA LM600 SUP SX	1	PZ	VM2064A0	TAPPO COLONNINA LM600 INF DX	1	PZ	VM2065A0	TAPPO COLONNINA LM600 INF SX	1	PZ	VT1252A0	VETRO EST.XF135 NERO ENGEFOOD	1	PZ
Codice	Descrizione	Qtà	UM																																																										
RC1200A0	MOLLA A COMPRESSIO NE DE4 DF0.5 H24	2	PZ																																																										
SL1050A1	NASTRO BIADESIVO 3M TRANSFER VH	0.820	M																																																										
TB2301A0	COLONNINA DX XVC105E 40X40X1	2	PZ																																																										
TB3081A0	COLONNINA SX LM ARI-RO	1	PZ																																																										
VM1025A0	TAPPO NYLON PA66 V2 GRIGIO Ø16	2	PZ																																																										
VM1695A0	PERNO POSIZIONE MANIGLIA	2	PZ																																																										
VM1920A0	PIASTRINA DX CHIUSURA VETRO INT	1	PZ																																																										
VM1921A0	PIASTRINA SX CHIUSURA VETRO INT	1	PZ																																																										
VM2062A0	TAPPO COLONNINA LM600 SUP DX	1	PZ																																																										
VM2063A0	TAPPO COLONNINA LM600 SUP SX	1	PZ																																																										
VM2064A0	TAPPO COLONNINA LM600 INF DX	1	PZ																																																										
VM2065A0	TAPPO COLONNINA LM600 INF SX	1	PZ																																																										
VT1252A0	VETRO EST.XF135 NERO ENGEFOOD	1	PZ																																																										
			KVT1063A	KIT VETRO ESTERNO LMISS ARIANNA FORNETTI	<table border="1"> <thead> <tr> <th>Codice</th> <th>Descrizione</th> <th>Qtà</th> <th>UM</th> </tr> </thead> <tbody> <tr> <td>IP1385A1</td> <td>IMB POL ANGOLARE 110X80X2000 D30</td> <td>0.980</td> <td>M</td> </tr> <tr> <td>IP1508A0</td> <td>POLISTIROLO PROFILO AD U 2000X60X60</td> <td>0.960</td> <td>PZ</td> </tr> <tr> <td>IP1508A1</td> <td>POLISTIROLO PROFILO AD U 2000X60X60</td> <td>0.960</td> <td>M</td> </tr> <tr> <td>MS1009A0</td> <td>ETICHETTA LOGO FORNETTI</td> <td>1</td> <td>PZ</td> </tr> </tbody> </table>	Codice	Descrizione	Qtà	UM	IP1385A1	IMB POL ANGOLARE 110X80X2000 D30	0.980	M	IP1508A0	POLISTIROLO PROFILO AD U 2000X60X60	0.960	PZ	IP1508A1	POLISTIROLO PROFILO AD U 2000X60X60	0.960	M	MS1009A0	ETICHETTA LOGO FORNETTI	1	PZ																																				
Codice	Descrizione	Qtà	UM																																																										
IP1385A1	IMB POL ANGOLARE 110X80X2000 D30	0.980	M																																																										
IP1508A0	POLISTIROLO PROFILO AD U 2000X60X60	0.960	PZ																																																										
IP1508A1	POLISTIROLO PROFILO AD U 2000X60X60	0.960	M																																																										
MS1009A0	ETICHETTA LOGO FORNETTI	1	PZ																																																										

COMPONENTE			RICAMBIO																																																																																	
Codice	Descrizione	Immagine	Codice	Descrizione	Lista componenti																																																																															
VM2064A	TAPPO COLONNINA LM600 INF DX		KVT1063A	KIT VETRO ESTERNO LMISS ARIANNA FORNETTI	<table border="1"> <thead> <tr> <th>Codice</th> <th>Descrizione</th> <th>Qtà</th> <th>UM</th> </tr> </thead> <tbody> <tr> <td>RC1200A0</td> <td>MOLLA A COMPRESSIO NE DE4 DF0.5 H24</td> <td>2</td> <td>PZ</td> </tr> <tr> <td>SL1050A1</td> <td>NASTRO BIADESIVO 3M TRANSFER VH</td> <td>0.820</td> <td>M</td> </tr> <tr> <td>TB2301A0</td> <td>COLONNINA DX XVC105E 40X40X1</td> <td>2</td> <td>PZ</td> </tr> <tr> <td>TB3081A0</td> <td>COLONNINA SX LM ARI-RO</td> <td>1</td> <td>PZ</td> </tr> <tr> <td>VM1025A0</td> <td>TAPPO NYLON PA66 V2 GRIGIO Ø16</td> <td>2</td> <td>PZ</td> </tr> <tr> <td>VM1059A1</td> <td>FILM TERMORETRA IBILE H800</td> <td>1.300</td> <td>M</td> </tr> <tr> <td>VM1695A0</td> <td>PERNO POSIZIONE MANIGLIA</td> <td>2</td> <td>PZ</td> </tr> <tr> <td>VM1920A0</td> <td>PIASTRINA DX CHIUSURA VETRO INT</td> <td>1</td> <td>PZ</td> </tr> <tr> <td>VM1921A0</td> <td>PIASTRINA SX CHIUSURA VETRO INT</td> <td>1</td> <td>PZ</td> </tr> <tr> <td>VM2062A0</td> <td>TAPPO COLONNINA LM600 SUP DX</td> <td>1</td> <td>PZ</td> </tr> <tr> <td>VM2063A0</td> <td>TAPPO COLONNINA LM600 SUP SX</td> <td>1</td> <td>PZ</td> </tr> <tr> <td>VM2064A0</td> <td>TAPPO COLONNINA LM600 INF DX</td> <td>1</td> <td>PZ</td> </tr> <tr> <td>VM2065A0</td> <td>TAPPO COLONNINA LM600 INF SX</td> <td>1</td> <td>PZ</td> </tr> <tr> <td>VT1063A0</td> <td>VETRO EST. 598X424 XF135F</td> <td>1</td> <td>PZ</td> </tr> </tbody> </table>	Codice	Descrizione	Qtà	UM	RC1200A0	MOLLA A COMPRESSIO NE DE4 DF0.5 H24	2	PZ	SL1050A1	NASTRO BIADESIVO 3M TRANSFER VH	0.820	M	TB2301A0	COLONNINA DX XVC105E 40X40X1	2	PZ	TB3081A0	COLONNINA SX LM ARI-RO	1	PZ	VM1025A0	TAPPO NYLON PA66 V2 GRIGIO Ø16	2	PZ	VM1059A1	FILM TERMORETRA IBILE H800	1.300	M	VM1695A0	PERNO POSIZIONE MANIGLIA	2	PZ	VM1920A0	PIASTRINA DX CHIUSURA VETRO INT	1	PZ	VM1921A0	PIASTRINA SX CHIUSURA VETRO INT	1	PZ	VM2062A0	TAPPO COLONNINA LM600 SUP DX	1	PZ	VM2063A0	TAPPO COLONNINA LM600 SUP SX	1	PZ	VM2064A0	TAPPO COLONNINA LM600 INF DX	1	PZ	VM2065A0	TAPPO COLONNINA LM600 INF SX	1	PZ	VT1063A0	VETRO EST. 598X424 XF135F	1	PZ	KVT1062A	KIT VETRO ESTERNO LM ARIANNA BLACK	<table border="1"> <thead> <tr> <th>Codice</th> <th>Descrizione</th> <th>Qtà</th> <th>UM</th> </tr> </thead> <tbody> <tr> <td>IP1385A1</td> <td>IMB POL ANGOLARE 110X80X2000 D30</td> <td>1.280</td> <td>M</td> </tr> <tr> <td>RC1200A0</td> <td>MOLLA A COMPRESSIO NE DE4 DF0.5 H24</td> <td>2</td> <td>PZ</td> </tr> <tr> <td>SL1050A1</td> <td>NASTRO BIADESIVO 3M TRANSFER VH</td> <td>0.820</td> <td>M</td> </tr> </tbody> </table>	Codice	Descrizione	Qtà	UM	IP1385A1	IMB POL ANGOLARE 110X80X2000 D30	1.280	M	RC1200A0	MOLLA A COMPRESSIO NE DE4 DF0.5 H24	2	PZ	SL1050A1	NASTRO BIADESIVO 3M TRANSFER VH	0.820	M
			Codice	Descrizione	Qtà	UM																																																																														
RC1200A0	MOLLA A COMPRESSIO NE DE4 DF0.5 H24	2	PZ																																																																																	
SL1050A1	NASTRO BIADESIVO 3M TRANSFER VH	0.820	M																																																																																	
TB2301A0	COLONNINA DX XVC105E 40X40X1	2	PZ																																																																																	
TB3081A0	COLONNINA SX LM ARI-RO	1	PZ																																																																																	
VM1025A0	TAPPO NYLON PA66 V2 GRIGIO Ø16	2	PZ																																																																																	
VM1059A1	FILM TERMORETRA IBILE H800	1.300	M																																																																																	
VM1695A0	PERNO POSIZIONE MANIGLIA	2	PZ																																																																																	
VM1920A0	PIASTRINA DX CHIUSURA VETRO INT	1	PZ																																																																																	
VM1921A0	PIASTRINA SX CHIUSURA VETRO INT	1	PZ																																																																																	
VM2062A0	TAPPO COLONNINA LM600 SUP DX	1	PZ																																																																																	
VM2063A0	TAPPO COLONNINA LM600 SUP SX	1	PZ																																																																																	
VM2064A0	TAPPO COLONNINA LM600 INF DX	1	PZ																																																																																	
VM2065A0	TAPPO COLONNINA LM600 INF SX	1	PZ																																																																																	
VT1063A0	VETRO EST. 598X424 XF135F	1	PZ																																																																																	
Codice	Descrizione	Qtà	UM																																																																																	
IP1385A1	IMB POL ANGOLARE 110X80X2000 D30	1.280	M																																																																																	
RC1200A0	MOLLA A COMPRESSIO NE DE4 DF0.5 H24	2	PZ																																																																																	
SL1050A1	NASTRO BIADESIVO 3M TRANSFER VH	0.820	M																																																																																	

COMPONENTE			RICAMBIO																																																						
Codice	Descrizione	Immagine	Codice	Descrizione	Lista componenti																																																				
VM2064A	TAPPO COLONNINA LM600 INF DX		KVT1062A	KIT VETRO ESTERNO LM ARIANNA BLACK	<table border="1"> <thead> <tr> <th>Codice</th> <th>Descrizione</th> <th>Qtà</th> <th>UM</th> </tr> </thead> <tbody> <tr> <td>TB2301A0</td> <td>COLONNINA DX XVC105E 40X40X1</td> <td>2</td> <td>PZ</td> </tr> <tr> <td>TB3081A0</td> <td>COLONNINA SX LM ARI-RO</td> <td>1</td> <td>PZ</td> </tr> <tr> <td>VM1025A0</td> <td>TAPPO NYLON PA66 V2 GRIGIO Ø16</td> <td>2</td> <td>PZ</td> </tr> <tr> <td>VM1059A1</td> <td>FILM TERMORETRA IBILE H800</td> <td>1</td> <td>M</td> </tr> <tr> <td>VM1695A0</td> <td>PERNO POSIZIONE MANIGLIA</td> <td>2</td> <td>PZ</td> </tr> <tr> <td>VM1920A0</td> <td>PIASTRINA DX CHIUSURA VETRO INT</td> <td>1</td> <td>PZ</td> </tr> <tr> <td>VM1921A0</td> <td>PIASTRINA SX CHIUSURA VETRO INT</td> <td>1</td> <td>PZ</td> </tr> <tr> <td>VM2062A0</td> <td>TAPPO COLONNINA LM600 SUP DX</td> <td>1</td> <td>PZ</td> </tr> <tr> <td>VM2063A0</td> <td>TAPPO COLONNINA LM600 SUP SX</td> <td>1</td> <td>PZ</td> </tr> <tr> <td>VM2064A0</td> <td>TAPPO COLONNINA LM600 INF DX</td> <td>1</td> <td>PZ</td> </tr> <tr> <td>VM2065A0</td> <td>TAPPO COLONNINA LM600 INF SX</td> <td>1</td> <td>PZ</td> </tr> <tr> <td>VT1062A0</td> <td>VETRO ESTERNO GRIGIO LINEMISS ARIANNA</td> <td>1</td> <td>PZ</td> </tr> </tbody> </table>	Codice	Descrizione	Qtà	UM	TB2301A0	COLONNINA DX XVC105E 40X40X1	2	PZ	TB3081A0	COLONNINA SX LM ARI-RO	1	PZ	VM1025A0	TAPPO NYLON PA66 V2 GRIGIO Ø16	2	PZ	VM1059A1	FILM TERMORETRA IBILE H800	1	M	VM1695A0	PERNO POSIZIONE MANIGLIA	2	PZ	VM1920A0	PIASTRINA DX CHIUSURA VETRO INT	1	PZ	VM1921A0	PIASTRINA SX CHIUSURA VETRO INT	1	PZ	VM2062A0	TAPPO COLONNINA LM600 SUP DX	1	PZ	VM2063A0	TAPPO COLONNINA LM600 SUP SX	1	PZ	VM2064A0	TAPPO COLONNINA LM600 INF DX	1	PZ	VM2065A0	TAPPO COLONNINA LM600 INF SX	1	PZ	VT1062A0	VETRO ESTERNO GRIGIO LINEMISS ARIANNA	1	PZ
Codice	Descrizione	Qtà	UM																																																						
TB2301A0	COLONNINA DX XVC105E 40X40X1	2	PZ																																																						
TB3081A0	COLONNINA SX LM ARI-RO	1	PZ																																																						
VM1025A0	TAPPO NYLON PA66 V2 GRIGIO Ø16	2	PZ																																																						
VM1059A1	FILM TERMORETRA IBILE H800	1	M																																																						
VM1695A0	PERNO POSIZIONE MANIGLIA	2	PZ																																																						
VM1920A0	PIASTRINA DX CHIUSURA VETRO INT	1	PZ																																																						
VM1921A0	PIASTRINA SX CHIUSURA VETRO INT	1	PZ																																																						
VM2062A0	TAPPO COLONNINA LM600 SUP DX	1	PZ																																																						
VM2063A0	TAPPO COLONNINA LM600 SUP SX	1	PZ																																																						
VM2064A0	TAPPO COLONNINA LM600 INF DX	1	PZ																																																						
VM2065A0	TAPPO COLONNINA LM600 INF SX	1	PZ																																																						
VT1062A0	VETRO ESTERNO GRIGIO LINEMISS ARIANNA	1	PZ																																																						
			KVT1061A	KIT VETRO ESTERNO LM ARIANNA	<table border="1"> <thead> <tr> <th>Codice</th> <th>Descrizione</th> <th>Qtà</th> <th>UM</th> </tr> </thead> <tbody> <tr> <td>IP1385A1</td> <td>IMB POL ANGOLARE 110X80X2000 D30</td> <td>1.280</td> <td>M</td> </tr> <tr> <td>RC1200A0</td> <td>MOLLA A COMPRESSIO NE DE4 DF0.5 H24</td> <td>2</td> <td>PZ</td> </tr> <tr> <td>SL1050A1</td> <td>NASTRO BIADESIVO 3M TRANSFER VH</td> <td>0.820</td> <td>M</td> </tr> <tr> <td>TB2301A0</td> <td>COLONNINA DX XVC105E 40X40X1</td> <td>2</td> <td>PZ</td> </tr> </tbody> </table>	Codice	Descrizione	Qtà	UM	IP1385A1	IMB POL ANGOLARE 110X80X2000 D30	1.280	M	RC1200A0	MOLLA A COMPRESSIO NE DE4 DF0.5 H24	2	PZ	SL1050A1	NASTRO BIADESIVO 3M TRANSFER VH	0.820	M	TB2301A0	COLONNINA DX XVC105E 40X40X1	2	PZ																																
Codice	Descrizione	Qtà	UM																																																						
IP1385A1	IMB POL ANGOLARE 110X80X2000 D30	1.280	M																																																						
RC1200A0	MOLLA A COMPRESSIO NE DE4 DF0.5 H24	2	PZ																																																						
SL1050A1	NASTRO BIADESIVO 3M TRANSFER VH	0.820	M																																																						
TB2301A0	COLONNINA DX XVC105E 40X40X1	2	PZ																																																						

COMPONENTE			RICAMBIO																																														
Codice	Descrizione	Immagine	Codice	Descrizione	Lista componenti																																												
VM2064A	TAPPO COLONNINA LM600 INF DX		KVT1061A	KIT VETRO ESTERNO LM ARIANNA	<table border="1"> <thead> <tr> <th>Codice</th> <th>Descrizione</th> <th>Qtà</th> <th>UM</th> </tr> </thead> <tbody> <tr> <td>VM1025A0</td> <td>TAPPO NYLON PA66 V2 GRIGIO Ø16</td> <td>2</td> <td>PZ</td> </tr> <tr> <td>VM1059A1</td> <td>FILM TERMORETRA IBILE H800</td> <td>1.300</td> <td>M</td> </tr> <tr> <td>VM1695A0</td> <td>PERNO POSIZIONE MANIGLIA</td> <td>2</td> <td>PZ</td> </tr> <tr> <td>VM1920A0</td> <td>PIASTRINA DX CHIUSURA VETRO INT</td> <td>1</td> <td>PZ</td> </tr> <tr> <td>VM1921A0</td> <td>PIASTRINA SX CHIUSURA VETRO INT</td> <td>1</td> <td>PZ</td> </tr> <tr> <td>VM2062A0</td> <td>TAPPO COLONNINA LM600 SUP DX</td> <td>1</td> <td>PZ</td> </tr> <tr> <td>VM2063A0</td> <td>TAPPO COLONNINA LM600 SUP SX</td> <td>1</td> <td>PZ</td> </tr> <tr> <td>VM2064A0</td> <td>TAPPO COLONNINA LM600 INF DX</td> <td>1</td> <td>PZ</td> </tr> <tr> <td>VM2065A0</td> <td>TAPPO COLONNINA LM600 INF SX</td> <td>1</td> <td>PZ</td> </tr> <tr> <td>VT1061A2</td> <td>VETRO ESTERNO SER. GIALLO 598X424X5</td> <td>1</td> <td>PZ</td> </tr> </tbody> </table>	Codice	Descrizione	Qtà	UM	VM1025A0	TAPPO NYLON PA66 V2 GRIGIO Ø16	2	PZ	VM1059A1	FILM TERMORETRA IBILE H800	1.300	M	VM1695A0	PERNO POSIZIONE MANIGLIA	2	PZ	VM1920A0	PIASTRINA DX CHIUSURA VETRO INT	1	PZ	VM1921A0	PIASTRINA SX CHIUSURA VETRO INT	1	PZ	VM2062A0	TAPPO COLONNINA LM600 SUP DX	1	PZ	VM2063A0	TAPPO COLONNINA LM600 SUP SX	1	PZ	VM2064A0	TAPPO COLONNINA LM600 INF DX	1	PZ	VM2065A0	TAPPO COLONNINA LM600 INF SX	1	PZ	VT1061A2	VETRO ESTERNO SER. GIALLO 598X424X5	1	PZ
			Codice	Descrizione	Qtà	UM																																											
VM1025A0	TAPPO NYLON PA66 V2 GRIGIO Ø16	2	PZ																																														
VM1059A1	FILM TERMORETRA IBILE H800	1.300	M																																														
VM1695A0	PERNO POSIZIONE MANIGLIA	2	PZ																																														
VM1920A0	PIASTRINA DX CHIUSURA VETRO INT	1	PZ																																														
VM1921A0	PIASTRINA SX CHIUSURA VETRO INT	1	PZ																																														
VM2062A0	TAPPO COLONNINA LM600 SUP DX	1	PZ																																														
VM2063A0	TAPPO COLONNINA LM600 SUP SX	1	PZ																																														
VM2064A0	TAPPO COLONNINA LM600 INF DX	1	PZ																																														
VM2065A0	TAPPO COLONNINA LM600 INF SX	1	PZ																																														
VT1061A2	VETRO ESTERNO SER. GIALLO 598X424X5	1	PZ																																														
KVT1057A	KIT VETRO ESTERNO NERO LMISS STEFANIA	<table border="1"> <thead> <tr> <th>Codice</th> <th>Descrizione</th> <th>Qtà</th> <th>UM</th> </tr> </thead> <tbody> <tr> <td>IP1385A1</td> <td>IMB POL ANGOLARE 110X80X2000 D30</td> <td>0.810</td> <td>M</td> </tr> <tr> <td>IP1508A0</td> <td>POLISTIROLO PROFILO AD U 2000X60X60</td> <td>0.950</td> <td>PZ</td> </tr> <tr> <td>IP1508A1</td> <td>POLISTIROLO PROFILO AD U 2000X60X60</td> <td>0.960</td> <td>M</td> </tr> <tr> <td>RC1200A0</td> <td>MOLLA A COMPRESSIO NE DE4 DF0.5 H24</td> <td>2</td> <td>PZ</td> </tr> <tr> <td>SL1050A1</td> <td>NASTRO BIADESIVO 3M TRANSFER VH</td> <td>0.660</td> <td>M</td> </tr> <tr> <td>TB2306A0</td> <td>COLONNINA DX LM STE-ELE 40X40X1</td> <td>2</td> <td>PZ</td> </tr> </tbody> </table>	Codice	Descrizione	Qtà	UM	IP1385A1	IMB POL ANGOLARE 110X80X2000 D30	0.810	M	IP1508A0	POLISTIROLO PROFILO AD U 2000X60X60	0.950	PZ	IP1508A1	POLISTIROLO PROFILO AD U 2000X60X60	0.960	M	RC1200A0	MOLLA A COMPRESSIO NE DE4 DF0.5 H24	2	PZ	SL1050A1	NASTRO BIADESIVO 3M TRANSFER VH	0.660	M	TB2306A0	COLONNINA DX LM STE-ELE 40X40X1	2	PZ																			
Codice	Descrizione	Qtà	UM																																														
IP1385A1	IMB POL ANGOLARE 110X80X2000 D30	0.810	M																																														
IP1508A0	POLISTIROLO PROFILO AD U 2000X60X60	0.950	PZ																																														
IP1508A1	POLISTIROLO PROFILO AD U 2000X60X60	0.960	M																																														
RC1200A0	MOLLA A COMPRESSIO NE DE4 DF0.5 H24	2	PZ																																														
SL1050A1	NASTRO BIADESIVO 3M TRANSFER VH	0.660	M																																														
TB2306A0	COLONNINA DX LM STE-ELE 40X40X1	2	PZ																																														

COMPONENTE			RICAMBIO																																																																													
Codice	Descrizione	Immagine	Codice	Descrizione	Lista componenti																																																																											
VM2064A	TAPPO COLONNINA LM600 INF DX		KVT1057A	KIT VETRO ESTERNO NERO LMISS STEFANIA	<table border="1"> <thead> <tr> <th>Codice</th> <th>Descrizione</th> <th>Qtà</th> <th>UM</th> </tr> </thead> <tbody> <tr> <td>TB3080A0</td> <td>COLONNINA SX LM STE-EL</td> <td>1</td> <td>PZ</td> </tr> <tr> <td>VM1025A0</td> <td>TAPPO NYLON PA66 V2 GRIGIO Ø16</td> <td>2</td> <td>PZ</td> </tr> <tr> <td>VM1059A1</td> <td>FILM TERMORETRA IBILE H800</td> <td>1</td> <td>M</td> </tr> <tr> <td>VM1695A0</td> <td>PERNO POSIZIONE MANIGLIA</td> <td>2</td> <td>PZ</td> </tr> <tr> <td>VM1920A0</td> <td>PIASTRINA DX CHIUSURA VETRO INT</td> <td>1</td> <td>PZ</td> </tr> <tr> <td>VM1921A0</td> <td>PIASTRINA SX CHIUSURA VETRO INT</td> <td>1</td> <td>PZ</td> </tr> <tr> <td>VM2062A0</td> <td>TAPPO COLONNINA LM600 SUP DX</td> <td>1</td> <td>PZ</td> </tr> <tr> <td>VM2063A0</td> <td>TAPPO COLONNINA LM600 SUP SX</td> <td>1</td> <td>PZ</td> </tr> <tr> <td>VM2064A0</td> <td>TAPPO COLONNINA LM600 INF DX</td> <td>1</td> <td>PZ</td> </tr> <tr> <td>VM2065A0</td> <td>TAPPO COLONNINA LM600 INF SX</td> <td>1</td> <td>PZ</td> </tr> <tr> <td>VT1057A0</td> <td>VETRO ESTERNO SER. GRIGIO 598X344X5</td> <td>1</td> <td>PZ</td> </tr> </tbody> </table>	Codice	Descrizione	Qtà	UM	TB3080A0	COLONNINA SX LM STE-EL	1	PZ	VM1025A0	TAPPO NYLON PA66 V2 GRIGIO Ø16	2	PZ	VM1059A1	FILM TERMORETRA IBILE H800	1	M	VM1695A0	PERNO POSIZIONE MANIGLIA	2	PZ	VM1920A0	PIASTRINA DX CHIUSURA VETRO INT	1	PZ	VM1921A0	PIASTRINA SX CHIUSURA VETRO INT	1	PZ	VM2062A0	TAPPO COLONNINA LM600 SUP DX	1	PZ	VM2063A0	TAPPO COLONNINA LM600 SUP SX	1	PZ	VM2064A0	TAPPO COLONNINA LM600 INF DX	1	PZ	VM2065A0	TAPPO COLONNINA LM600 INF SX	1	PZ	VT1057A0	VETRO ESTERNO SER. GRIGIO 598X344X5	1	PZ	KVT1056A	KIT VETRO ESTERNO GIALLO LMISS STEFANIA	<table border="1"> <thead> <tr> <th>Codice</th> <th>Descrizione</th> <th>Qtà</th> <th>UM</th> </tr> </thead> <tbody> <tr> <td>IP1385A1</td> <td>IMB POL ANGOLARE 110X80X2000 D30</td> <td>0.980</td> <td>M</td> </tr> <tr> <td>IP1508A0</td> <td>POLISTIROLO PROFILO AD U 2000X60X60</td> <td>0.960</td> <td>PZ</td> </tr> <tr> <td>IP1508A1</td> <td>POLISTIROLO PROFILO AD U 2000X60X60</td> <td>0.960</td> <td>M</td> </tr> <tr> <td>RC1200A0</td> <td>MOLLA A COMPRESSIO NE DE4 DF0.5 H24</td> <td>2</td> <td>PZ</td> </tr> <tr> <td>SL1050A1</td> <td>NASTRO BIADESIVO 3M TRANSFER VH</td> <td>0.660</td> <td>M</td> </tr> </tbody> </table>	Codice	Descrizione	Qtà	UM	IP1385A1	IMB POL ANGOLARE 110X80X2000 D30	0.980	M	IP1508A0	POLISTIROLO PROFILO AD U 2000X60X60	0.960	PZ	IP1508A1	POLISTIROLO PROFILO AD U 2000X60X60	0.960	M	RC1200A0	MOLLA A COMPRESSIO NE DE4 DF0.5 H24	2	PZ	SL1050A1	NASTRO BIADESIVO 3M TRANSFER VH	0.660	M
			Codice	Descrizione	Qtà	UM																																																																										
TB3080A0	COLONNINA SX LM STE-EL	1	PZ																																																																													
VM1025A0	TAPPO NYLON PA66 V2 GRIGIO Ø16	2	PZ																																																																													
VM1059A1	FILM TERMORETRA IBILE H800	1	M																																																																													
VM1695A0	PERNO POSIZIONE MANIGLIA	2	PZ																																																																													
VM1920A0	PIASTRINA DX CHIUSURA VETRO INT	1	PZ																																																																													
VM1921A0	PIASTRINA SX CHIUSURA VETRO INT	1	PZ																																																																													
VM2062A0	TAPPO COLONNINA LM600 SUP DX	1	PZ																																																																													
VM2063A0	TAPPO COLONNINA LM600 SUP SX	1	PZ																																																																													
VM2064A0	TAPPO COLONNINA LM600 INF DX	1	PZ																																																																													
VM2065A0	TAPPO COLONNINA LM600 INF SX	1	PZ																																																																													
VT1057A0	VETRO ESTERNO SER. GRIGIO 598X344X5	1	PZ																																																																													
Codice	Descrizione	Qtà	UM																																																																													
IP1385A1	IMB POL ANGOLARE 110X80X2000 D30	0.980	M																																																																													
IP1508A0	POLISTIROLO PROFILO AD U 2000X60X60	0.960	PZ																																																																													
IP1508A1	POLISTIROLO PROFILO AD U 2000X60X60	0.960	M																																																																													
RC1200A0	MOLLA A COMPRESSIO NE DE4 DF0.5 H24	2	PZ																																																																													
SL1050A1	NASTRO BIADESIVO 3M TRANSFER VH	0.660	M																																																																													

COMPONENTE			RICAMBIO																																																		
Codice	Descrizione	Immagine	Codice	Descrizione	Lista componenti																																																
VM2064A	TAPPO COLONNINA LM600 INF DX		KVT1056A	KIT VETRO ESTERNO GIALLO LMISS STEFANIA	<table border="1"> <thead> <tr> <th>Codice</th> <th>Descrizione</th> <th>Qtà</th> <th>UM</th> </tr> </thead> <tbody> <tr> <td>TB2306A0</td> <td>COLONNINA DX LM STE-ELE 40X40X1</td> <td>2</td> <td>PZ</td> </tr> <tr> <td>VM1025A0</td> <td>TAPPO NYLON PA66 V2 GRIGIO Ø16</td> <td>2</td> <td>PZ</td> </tr> <tr> <td>VM1059A1</td> <td>FILM TERMORETRA IBILE H800</td> <td>1.300</td> <td>M</td> </tr> <tr> <td>VM1695A0</td> <td>PERNO POSIZIONE MANIGLIA</td> <td>2</td> <td>PZ</td> </tr> <tr> <td>VM1920A0</td> <td>PIASTRINA DX CHIUSURA VETRO INT</td> <td>1</td> <td>PZ</td> </tr> <tr> <td>VM1921A0</td> <td>PIASTRINA SX CHIUSURA VETRO INT</td> <td>1</td> <td>PZ</td> </tr> <tr> <td>VM2062A0</td> <td>TAPPO COLONNINA LM600 SUP DX</td> <td>1</td> <td>PZ</td> </tr> <tr> <td>VM2063A0</td> <td>TAPPO COLONNINA LM600 SUP SX</td> <td>1</td> <td>PZ</td> </tr> <tr> <td>VM2064A0</td> <td>TAPPO COLONNINA LM600 INF DX</td> <td>1</td> <td>PZ</td> </tr> <tr> <td>VM2065A0</td> <td>TAPPO COLONNINA LM600 INF SX</td> <td>1</td> <td>PZ</td> </tr> <tr> <td>VT1056A2</td> <td>VETRO ESTERNO SER. GIALLO 598X344X5</td> <td>1</td> <td>PZ</td> </tr> </tbody> </table>	Codice	Descrizione	Qtà	UM	TB2306A0	COLONNINA DX LM STE-ELE 40X40X1	2	PZ	VM1025A0	TAPPO NYLON PA66 V2 GRIGIO Ø16	2	PZ	VM1059A1	FILM TERMORETRA IBILE H800	1.300	M	VM1695A0	PERNO POSIZIONE MANIGLIA	2	PZ	VM1920A0	PIASTRINA DX CHIUSURA VETRO INT	1	PZ	VM1921A0	PIASTRINA SX CHIUSURA VETRO INT	1	PZ	VM2062A0	TAPPO COLONNINA LM600 SUP DX	1	PZ	VM2063A0	TAPPO COLONNINA LM600 SUP SX	1	PZ	VM2064A0	TAPPO COLONNINA LM600 INF DX	1	PZ	VM2065A0	TAPPO COLONNINA LM600 INF SX	1	PZ	VT1056A2	VETRO ESTERNO SER. GIALLO 598X344X5	1	PZ
Codice	Descrizione	Qtà	UM																																																		
TB2306A0	COLONNINA DX LM STE-ELE 40X40X1	2	PZ																																																		
VM1025A0	TAPPO NYLON PA66 V2 GRIGIO Ø16	2	PZ																																																		
VM1059A1	FILM TERMORETRA IBILE H800	1.300	M																																																		
VM1695A0	PERNO POSIZIONE MANIGLIA	2	PZ																																																		
VM1920A0	PIASTRINA DX CHIUSURA VETRO INT	1	PZ																																																		
VM1921A0	PIASTRINA SX CHIUSURA VETRO INT	1	PZ																																																		
VM2062A0	TAPPO COLONNINA LM600 SUP DX	1	PZ																																																		
VM2063A0	TAPPO COLONNINA LM600 SUP SX	1	PZ																																																		
VM2064A0	TAPPO COLONNINA LM600 INF DX	1	PZ																																																		
VM2065A0	TAPPO COLONNINA LM600 INF SX	1	PZ																																																		
VT1056A2	VETRO ESTERNO SER. GIALLO 598X344X5	1	PZ																																																		
			KVT1052A	KIT VETRO ESTERNO NERO LINEMISS CRISTINA	<table border="1"> <thead> <tr> <th>Codice</th> <th>Descrizione</th> <th>Qtà</th> <th>UM</th> </tr> </thead> <tbody> <tr> <td>RC1200A0</td> <td>MOLLA A COMPRESSIO NE DE4 DF0.5 H24</td> <td>2</td> <td>PZ</td> </tr> <tr> <td>SL1050A1</td> <td>NASTRO BIADESIVO 3M TRANSFER VH</td> <td>0.660</td> <td>M</td> </tr> <tr> <td>TB2306A0</td> <td>COLONNINA DX LM STE-ELE 40X40X1</td> <td>2</td> <td>PZ</td> </tr> <tr> <td>VM1025A0</td> <td>TAPPO NYLON PA66 V2 GRIGIO Ø16</td> <td>2</td> <td>PZ</td> </tr> <tr> <td>VM1695A0</td> <td>PERNO POSIZIONE MANIGLIA</td> <td>2</td> <td>PZ</td> </tr> </tbody> </table>	Codice	Descrizione	Qtà	UM	RC1200A0	MOLLA A COMPRESSIO NE DE4 DF0.5 H24	2	PZ	SL1050A1	NASTRO BIADESIVO 3M TRANSFER VH	0.660	M	TB2306A0	COLONNINA DX LM STE-ELE 40X40X1	2	PZ	VM1025A0	TAPPO NYLON PA66 V2 GRIGIO Ø16	2	PZ	VM1695A0	PERNO POSIZIONE MANIGLIA	2	PZ																								
Codice	Descrizione	Qtà	UM																																																		
RC1200A0	MOLLA A COMPRESSIO NE DE4 DF0.5 H24	2	PZ																																																		
SL1050A1	NASTRO BIADESIVO 3M TRANSFER VH	0.660	M																																																		
TB2306A0	COLONNINA DX LM STE-ELE 40X40X1	2	PZ																																																		
VM1025A0	TAPPO NYLON PA66 V2 GRIGIO Ø16	2	PZ																																																		
VM1695A0	PERNO POSIZIONE MANIGLIA	2	PZ																																																		

COMPONENTE			RICAMBIO																																							
Codice	Descrizione	Immagine	Codice	Descrizione	Lista componenti																																					
VM2064A	TAPPO COLONNINA LM600 INF DX		KVT1052A	KIT VETRO ESTERNO NERO LINEMISS CRISTINA	<table border="1"> <thead> <tr> <th>Codice</th> <th>Descrizione</th> <th>Qtà</th> <th>UM</th> </tr> </thead> <tbody> <tr> <td>VM1920A0</td> <td>PIASTRINA DX CHIUSURA VETRO INT</td> <td>1</td> <td>PZ</td> </tr> <tr> <td>VM1921A0</td> <td>PIASTRINA SX CHIUSURA VETRO INT</td> <td>1</td> <td>PZ</td> </tr> <tr> <td>VM2062A0</td> <td>TAPPO COLONNINA LM600 SUP DX</td> <td>1</td> <td>PZ</td> </tr> <tr> <td>VM2063A0</td> <td>TAPPO COLONNINA LM600 SUP SX</td> <td>1</td> <td>PZ</td> </tr> <tr> <td>VM2064A0</td> <td>TAPPO COLONNINA LM600 INF DX</td> <td>1</td> <td>PZ</td> </tr> <tr> <td>VM2065A0</td> <td>TAPPO COLONNINA LM600 INF SX</td> <td>1</td> <td>PZ</td> </tr> <tr> <td>VT1052A0</td> <td>VETRO ESTERNO SER. GRIGIO 478X344X5</td> <td>1</td> <td>PZ</td> </tr> </tbody> </table>	Codice	Descrizione	Qtà	UM	VM1920A0	PIASTRINA DX CHIUSURA VETRO INT	1	PZ	VM1921A0	PIASTRINA SX CHIUSURA VETRO INT	1	PZ	VM2062A0	TAPPO COLONNINA LM600 SUP DX	1	PZ	VM2063A0	TAPPO COLONNINA LM600 SUP SX	1	PZ	VM2064A0	TAPPO COLONNINA LM600 INF DX	1	PZ	VM2065A0	TAPPO COLONNINA LM600 INF SX	1	PZ	VT1052A0	VETRO ESTERNO SER. GRIGIO 478X344X5	1	PZ					
			Codice	Descrizione	Qtà	UM																																				
VM1920A0	PIASTRINA DX CHIUSURA VETRO INT	1	PZ																																							
VM1921A0	PIASTRINA SX CHIUSURA VETRO INT	1	PZ																																							
VM2062A0	TAPPO COLONNINA LM600 SUP DX	1	PZ																																							
VM2063A0	TAPPO COLONNINA LM600 SUP SX	1	PZ																																							
VM2064A0	TAPPO COLONNINA LM600 INF DX	1	PZ																																							
VM2065A0	TAPPO COLONNINA LM600 INF SX	1	PZ																																							
VT1052A0	VETRO ESTERNO SER. GRIGIO 478X344X5	1	PZ																																							
KVT1051A	KIT VETRO ESTERNO GIALLO L.MISS CRISTINA	<table border="1"> <thead> <tr> <th>Codice</th> <th>Descrizione</th> <th>Qtà</th> <th>UM</th> </tr> </thead> <tbody> <tr> <td>IP1385A1</td> <td>IMB POL ANGOLARE 110X80X2000 D30</td> <td>1.040</td> <td>M</td> </tr> <tr> <td>RC1200A0</td> <td>MOLLA A COMPRESSIO NE DE4 DF0.5 H24</td> <td>2</td> <td>PZ</td> </tr> <tr> <td>SL1050A1</td> <td>NASTRO BIADESIVO 3M TRANSFER VH</td> <td>0.660</td> <td>M</td> </tr> <tr> <td>TB2306A0</td> <td>COLONNINA DX LM STE-ELE 40X40X1</td> <td>2</td> <td>PZ</td> </tr> <tr> <td>VM1025A0</td> <td>TAPPO NYLON PA66 V2 GRIGIO Ø16</td> <td>2</td> <td>PZ</td> </tr> <tr> <td>VM1059A1</td> <td>FILM TERMORETRA IBILE H800</td> <td>1.500</td> <td>M</td> </tr> <tr> <td>VM1695A0</td> <td>PERNO POSIZIONE MANIGLIA</td> <td>2</td> <td>PZ</td> </tr> <tr> <td>VM1920A0</td> <td>PIASTRINA DX CHIUSURA VETRO INT</td> <td>1</td> <td>PZ</td> </tr> <tr> <td>VM1921A0</td> <td>PIASTRINA SX CHIUSURA VETRO INT</td> <td>1</td> <td>PZ</td> </tr> </tbody> </table>	Codice	Descrizione	Qtà	UM	IP1385A1	IMB POL ANGOLARE 110X80X2000 D30	1.040	M	RC1200A0	MOLLA A COMPRESSIO NE DE4 DF0.5 H24	2	PZ	SL1050A1	NASTRO BIADESIVO 3M TRANSFER VH	0.660	M	TB2306A0	COLONNINA DX LM STE-ELE 40X40X1	2	PZ	VM1025A0	TAPPO NYLON PA66 V2 GRIGIO Ø16	2	PZ	VM1059A1	FILM TERMORETRA IBILE H800	1.500	M	VM1695A0	PERNO POSIZIONE MANIGLIA	2	PZ	VM1920A0	PIASTRINA DX CHIUSURA VETRO INT	1	PZ	VM1921A0	PIASTRINA SX CHIUSURA VETRO INT	1	PZ
Codice	Descrizione	Qtà	UM																																							
IP1385A1	IMB POL ANGOLARE 110X80X2000 D30	1.040	M																																							
RC1200A0	MOLLA A COMPRESSIO NE DE4 DF0.5 H24	2	PZ																																							
SL1050A1	NASTRO BIADESIVO 3M TRANSFER VH	0.660	M																																							
TB2306A0	COLONNINA DX LM STE-ELE 40X40X1	2	PZ																																							
VM1025A0	TAPPO NYLON PA66 V2 GRIGIO Ø16	2	PZ																																							
VM1059A1	FILM TERMORETRA IBILE H800	1.500	M																																							
VM1695A0	PERNO POSIZIONE MANIGLIA	2	PZ																																							
VM1920A0	PIASTRINA DX CHIUSURA VETRO INT	1	PZ																																							
VM1921A0	PIASTRINA SX CHIUSURA VETRO INT	1	PZ																																							

COMPONENTE			RICAMBIO																																																										
Codice	Descrizione	Immagine	Codice	Descrizione	Lista componenti																																																								
VM2064A	TAPPO COLONNINA LM600 INF DX		KVT1051A	KIT VETRO ESTERNO GIALLO L.MISS CRISTINA	<table border="1"> <thead> <tr> <th>Codice</th> <th>Descrizione</th> <th>Qtà</th> <th>UM</th> </tr> </thead> <tbody> <tr> <td>VM2062A0</td> <td>TAPPO COLONNINA LM600 SUP DX</td> <td>1</td> <td>PZ</td> </tr> <tr> <td>VM2063A0</td> <td>TAPPO COLONNINA LM600 SUP SX</td> <td>1</td> <td>PZ</td> </tr> <tr> <td>VM2064A0</td> <td>TAPPO COLONNINA LM600 INF DX</td> <td>1</td> <td>PZ</td> </tr> <tr> <td>VM2065A0</td> <td>TAPPO COLONNINA LM600 INF SX</td> <td>1</td> <td>PZ</td> </tr> <tr> <td>VT1051A2</td> <td>VETRO ESTERNO SER. GIALLO 478X344X5</td> <td>1</td> <td>PZ</td> </tr> </tbody> </table>	Codice	Descrizione	Qtà	UM	VM2062A0	TAPPO COLONNINA LM600 SUP DX	1	PZ	VM2063A0	TAPPO COLONNINA LM600 SUP SX	1	PZ	VM2064A0	TAPPO COLONNINA LM600 INF DX	1	PZ	VM2065A0	TAPPO COLONNINA LM600 INF SX	1	PZ	VT1051A2	VETRO ESTERNO SER. GIALLO 478X344X5	1	PZ																																
Codice	Descrizione	Qtà	UM																																																										
VM2062A0	TAPPO COLONNINA LM600 SUP DX	1	PZ																																																										
VM2063A0	TAPPO COLONNINA LM600 SUP SX	1	PZ																																																										
VM2064A0	TAPPO COLONNINA LM600 INF DX	1	PZ																																																										
VM2065A0	TAPPO COLONNINA LM600 INF SX	1	PZ																																																										
VT1051A2	VETRO ESTERNO SER. GIALLO 478X344X5	1	PZ																																																										
VM2065A	TAPPO COLONNINA LM600 INF SX		KVT1252A	KIT VETRO ESTERNO XF135-EG VT1252A	<table border="1"> <thead> <tr> <th>Codice</th> <th>Descrizione</th> <th>Qtà</th> <th>UM</th> </tr> </thead> <tbody> <tr> <td>RC1200A0</td> <td>MOLLA A COMPRESSIO NE DE4 DF0.5 H24</td> <td>2</td> <td>PZ</td> </tr> <tr> <td>SL1050A1</td> <td>NASTRO BIADESIVO 3M TRANSFER VH</td> <td>0.820</td> <td>M</td> </tr> <tr> <td>TB2301A0</td> <td>COLONNINA DX XVC105E 40X40X1</td> <td>2</td> <td>PZ</td> </tr> <tr> <td>TB3081A0</td> <td>COLONNINA SX LM ARI-RO</td> <td>1</td> <td>PZ</td> </tr> <tr> <td>VM1025A0</td> <td>TAPPO NYLON PA66 V2 GRIGIO Ø16</td> <td>2</td> <td>PZ</td> </tr> <tr> <td>VM1695A0</td> <td>PERNO POSIZIONE MANIGLIA</td> <td>2</td> <td>PZ</td> </tr> <tr> <td>VM1920A0</td> <td>PIASTRINA DX CHIUSURA VETRO INT</td> <td>1</td> <td>PZ</td> </tr> <tr> <td>VM1921A0</td> <td>PIASTRINA SX CHIUSURA VETRO INT</td> <td>1</td> <td>PZ</td> </tr> <tr> <td>VM2062A0</td> <td>TAPPO COLONNINA LM600 SUP DX</td> <td>1</td> <td>PZ</td> </tr> <tr> <td>VM2063A0</td> <td>TAPPO COLONNINA LM600 SUP SX</td> <td>1</td> <td>PZ</td> </tr> <tr> <td>VM2064A0</td> <td>TAPPO COLONNINA LM600 INF DX</td> <td>1</td> <td>PZ</td> </tr> <tr> <td>VM2065A0</td> <td>TAPPO COLONNINA LM600 INF SX</td> <td>1</td> <td>PZ</td> </tr> <tr> <td>VT1252A0</td> <td>VETRO EST.XF135 NERO ENGEFOOD</td> <td>1</td> <td>PZ</td> </tr> </tbody> </table>	Codice	Descrizione	Qtà	UM	RC1200A0	MOLLA A COMPRESSIO NE DE4 DF0.5 H24	2	PZ	SL1050A1	NASTRO BIADESIVO 3M TRANSFER VH	0.820	M	TB2301A0	COLONNINA DX XVC105E 40X40X1	2	PZ	TB3081A0	COLONNINA SX LM ARI-RO	1	PZ	VM1025A0	TAPPO NYLON PA66 V2 GRIGIO Ø16	2	PZ	VM1695A0	PERNO POSIZIONE MANIGLIA	2	PZ	VM1920A0	PIASTRINA DX CHIUSURA VETRO INT	1	PZ	VM1921A0	PIASTRINA SX CHIUSURA VETRO INT	1	PZ	VM2062A0	TAPPO COLONNINA LM600 SUP DX	1	PZ	VM2063A0	TAPPO COLONNINA LM600 SUP SX	1	PZ	VM2064A0	TAPPO COLONNINA LM600 INF DX	1	PZ	VM2065A0	TAPPO COLONNINA LM600 INF SX	1	PZ	VT1252A0	VETRO EST.XF135 NERO ENGEFOOD	1	PZ
Codice	Descrizione	Qtà	UM																																																										
RC1200A0	MOLLA A COMPRESSIO NE DE4 DF0.5 H24	2	PZ																																																										
SL1050A1	NASTRO BIADESIVO 3M TRANSFER VH	0.820	M																																																										
TB2301A0	COLONNINA DX XVC105E 40X40X1	2	PZ																																																										
TB3081A0	COLONNINA SX LM ARI-RO	1	PZ																																																										
VM1025A0	TAPPO NYLON PA66 V2 GRIGIO Ø16	2	PZ																																																										
VM1695A0	PERNO POSIZIONE MANIGLIA	2	PZ																																																										
VM1920A0	PIASTRINA DX CHIUSURA VETRO INT	1	PZ																																																										
VM1921A0	PIASTRINA SX CHIUSURA VETRO INT	1	PZ																																																										
VM2062A0	TAPPO COLONNINA LM600 SUP DX	1	PZ																																																										
VM2063A0	TAPPO COLONNINA LM600 SUP SX	1	PZ																																																										
VM2064A0	TAPPO COLONNINA LM600 INF DX	1	PZ																																																										
VM2065A0	TAPPO COLONNINA LM600 INF SX	1	PZ																																																										
VT1252A0	VETRO EST.XF135 NERO ENGEFOOD	1	PZ																																																										

COMPONENTE			RICAMBIO																																																																														
Codice	Descrizione	Immagine	Codice	Descrizione	Lista componenti																																																																												
VM2065A	TAPPO COLONNINA LM600 INF SX		KVT1063A	KIT VETRO ESTERNO LMISS ARIANNA FORNETTI	<table border="1"> <thead> <tr> <th>Codice</th> <th>Descrizione</th> <th>Qtà</th> <th>UM</th> </tr> </thead> <tbody> <tr> <td>IP1385A1</td> <td>IMB POL ANGOLARE 110X80X2000 D30</td> <td>0.980</td> <td>M</td> </tr> <tr> <td>IP1508A0</td> <td>POLISTIROLO PROFILO AD U 2000X60X60</td> <td>0.960</td> <td>PZ</td> </tr> <tr> <td>IP1508A1</td> <td>POLISTIROLO PROFILO AD U 2000X60X60</td> <td>0.960</td> <td>M</td> </tr> <tr> <td>MS1009A0</td> <td>ETICHETTA LOGO FORNETTI</td> <td>1</td> <td>PZ</td> </tr> <tr> <td>RC1200A0</td> <td>MOLLA A COMPRESSIO NE DE4 DF0.5 H24</td> <td>2</td> <td>PZ</td> </tr> <tr> <td>SL1050A1</td> <td>NASTRO BIADESIVO 3M TRANSFER VH</td> <td>0.820</td> <td>M</td> </tr> <tr> <td>TB2301A0</td> <td>COLONNINA DX XVC105E 40X40X1</td> <td>2</td> <td>PZ</td> </tr> <tr> <td>TB3081A0</td> <td>COLONNINA SX LM ARI-RO</td> <td>1</td> <td>PZ</td> </tr> <tr> <td>VM1025A0</td> <td>TAPPO NYLON PA66 V2 GRIGIO Ø16</td> <td>2</td> <td>PZ</td> </tr> <tr> <td>VM1059A1</td> <td>FILM TERMORETRA IBILE H800</td> <td>1.300</td> <td>M</td> </tr> <tr> <td>VM1695A0</td> <td>PERNO POSIZIONE MANIGLIA</td> <td>2</td> <td>PZ</td> </tr> <tr> <td>VM1920A0</td> <td>PIASTRINA DX CHIUSURA VETRO INT</td> <td>1</td> <td>PZ</td> </tr> <tr> <td>VM1921A0</td> <td>PIASTRINA SX CHIUSURA VETRO INT</td> <td>1</td> <td>PZ</td> </tr> <tr> <td>VM2062A0</td> <td>TAPPO COLONNINA LM600 SUP DX</td> <td>1</td> <td>PZ</td> </tr> <tr> <td>VM2063A0</td> <td>TAPPO COLONNINA LM600 SUP SX</td> <td>1</td> <td>PZ</td> </tr> <tr> <td>VM2064A0</td> <td>TAPPO COLONNINA LM600 INF DX</td> <td>1</td> <td>PZ</td> </tr> <tr> <td>VM2065A0</td> <td>TAPPO COLONNINA LM600 INF SX</td> <td>1</td> <td>PZ</td> </tr> <tr> <td>VT1063A0</td> <td>VETRO EST. 598X424 XF135F</td> <td>1</td> <td>PZ</td> </tr> </tbody> </table>	Codice	Descrizione	Qtà	UM	IP1385A1	IMB POL ANGOLARE 110X80X2000 D30	0.980	M	IP1508A0	POLISTIROLO PROFILO AD U 2000X60X60	0.960	PZ	IP1508A1	POLISTIROLO PROFILO AD U 2000X60X60	0.960	M	MS1009A0	ETICHETTA LOGO FORNETTI	1	PZ	RC1200A0	MOLLA A COMPRESSIO NE DE4 DF0.5 H24	2	PZ	SL1050A1	NASTRO BIADESIVO 3M TRANSFER VH	0.820	M	TB2301A0	COLONNINA DX XVC105E 40X40X1	2	PZ	TB3081A0	COLONNINA SX LM ARI-RO	1	PZ	VM1025A0	TAPPO NYLON PA66 V2 GRIGIO Ø16	2	PZ	VM1059A1	FILM TERMORETRA IBILE H800	1.300	M	VM1695A0	PERNO POSIZIONE MANIGLIA	2	PZ	VM1920A0	PIASTRINA DX CHIUSURA VETRO INT	1	PZ	VM1921A0	PIASTRINA SX CHIUSURA VETRO INT	1	PZ	VM2062A0	TAPPO COLONNINA LM600 SUP DX	1	PZ	VM2063A0	TAPPO COLONNINA LM600 SUP SX	1	PZ	VM2064A0	TAPPO COLONNINA LM600 INF DX	1	PZ	VM2065A0	TAPPO COLONNINA LM600 INF SX	1	PZ	VT1063A0	VETRO EST. 598X424 XF135F	1	PZ
Codice	Descrizione	Qtà	UM																																																																														
IP1385A1	IMB POL ANGOLARE 110X80X2000 D30	0.980	M																																																																														
IP1508A0	POLISTIROLO PROFILO AD U 2000X60X60	0.960	PZ																																																																														
IP1508A1	POLISTIROLO PROFILO AD U 2000X60X60	0.960	M																																																																														
MS1009A0	ETICHETTA LOGO FORNETTI	1	PZ																																																																														
RC1200A0	MOLLA A COMPRESSIO NE DE4 DF0.5 H24	2	PZ																																																																														
SL1050A1	NASTRO BIADESIVO 3M TRANSFER VH	0.820	M																																																																														
TB2301A0	COLONNINA DX XVC105E 40X40X1	2	PZ																																																																														
TB3081A0	COLONNINA SX LM ARI-RO	1	PZ																																																																														
VM1025A0	TAPPO NYLON PA66 V2 GRIGIO Ø16	2	PZ																																																																														
VM1059A1	FILM TERMORETRA IBILE H800	1.300	M																																																																														
VM1695A0	PERNO POSIZIONE MANIGLIA	2	PZ																																																																														
VM1920A0	PIASTRINA DX CHIUSURA VETRO INT	1	PZ																																																																														
VM1921A0	PIASTRINA SX CHIUSURA VETRO INT	1	PZ																																																																														
VM2062A0	TAPPO COLONNINA LM600 SUP DX	1	PZ																																																																														
VM2063A0	TAPPO COLONNINA LM600 SUP SX	1	PZ																																																																														
VM2064A0	TAPPO COLONNINA LM600 INF DX	1	PZ																																																																														
VM2065A0	TAPPO COLONNINA LM600 INF SX	1	PZ																																																																														
VT1063A0	VETRO EST. 598X424 XF135F	1	PZ																																																																														



COMPONENTE			RICAMBIO																																																																		
Codice	Descrizione	Immagine	Codice	Descrizione	Lista componenti																																																																
VM2065A	TAPPO COLONNINA LM600 INF SX		KVT1062A	KIT VETRO ESTERNO LM ARIANNA BLACK	<table border="1"> <thead> <tr> <th>Codice</th> <th>Descrizione</th> <th>Qtà</th> <th>UM</th> </tr> </thead> <tbody> <tr> <td>IP1385A1</td> <td>IMB POL ANGOLARE 110X80X2000 D30</td> <td>1.280</td> <td>M</td> </tr> <tr> <td>RC1200A0</td> <td>MOLLA A COMPRESSIO NE DE4 DF0.5 H24</td> <td>2</td> <td>PZ</td> </tr> <tr> <td>SL1050A1</td> <td>NASTRO BIADESIVO 3M TRANSFER VH</td> <td>0.820</td> <td>M</td> </tr> <tr> <td>TB2301A0</td> <td>COLONNINA DX XVC105E 40X40X1</td> <td>2</td> <td>PZ</td> </tr> <tr> <td>TB3081A0</td> <td>COLONNINA SX LM ARI-RO</td> <td>1</td> <td>PZ</td> </tr> <tr> <td>VM1025A0</td> <td>TAPPO NYLON PA66 V2 GRIGIO Ø16</td> <td>2</td> <td>PZ</td> </tr> <tr> <td>VM1059A1</td> <td>FILM TERMORETRA IBILE H800</td> <td>1</td> <td>M</td> </tr> <tr> <td>VM1695A0</td> <td>PERNO POSIZIONE MANIGLIA</td> <td>2</td> <td>PZ</td> </tr> <tr> <td>VM1920A0</td> <td>PIASTRINA DX CHIUSURA VETRO INT</td> <td>1</td> <td>PZ</td> </tr> <tr> <td>VM1921A0</td> <td>PIASTRINA SX CHIUSURA VETRO INT</td> <td>1</td> <td>PZ</td> </tr> <tr> <td>VM2062A0</td> <td>TAPPO COLONNINA LM600 SUP DX</td> <td>1</td> <td>PZ</td> </tr> <tr> <td>VM2063A0</td> <td>TAPPO COLONNINA LM600 SUP SX</td> <td>1</td> <td>PZ</td> </tr> <tr> <td>VM2064A0</td> <td>TAPPO COLONNINA LM600 INF DX</td> <td>1</td> <td>PZ</td> </tr> <tr> <td>VM2065A0</td> <td>TAPPO COLONNINA LM600 INF SX</td> <td>1</td> <td>PZ</td> </tr> <tr> <td>VT1062A0</td> <td>VETRO ESTERNO GRIGIO LINEMISS ARIANNA</td> <td>1</td> <td>PZ</td> </tr> </tbody> </table>	Codice	Descrizione	Qtà	UM	IP1385A1	IMB POL ANGOLARE 110X80X2000 D30	1.280	M	RC1200A0	MOLLA A COMPRESSIO NE DE4 DF0.5 H24	2	PZ	SL1050A1	NASTRO BIADESIVO 3M TRANSFER VH	0.820	M	TB2301A0	COLONNINA DX XVC105E 40X40X1	2	PZ	TB3081A0	COLONNINA SX LM ARI-RO	1	PZ	VM1025A0	TAPPO NYLON PA66 V2 GRIGIO Ø16	2	PZ	VM1059A1	FILM TERMORETRA IBILE H800	1	M	VM1695A0	PERNO POSIZIONE MANIGLIA	2	PZ	VM1920A0	PIASTRINA DX CHIUSURA VETRO INT	1	PZ	VM1921A0	PIASTRINA SX CHIUSURA VETRO INT	1	PZ	VM2062A0	TAPPO COLONNINA LM600 SUP DX	1	PZ	VM2063A0	TAPPO COLONNINA LM600 SUP SX	1	PZ	VM2064A0	TAPPO COLONNINA LM600 INF DX	1	PZ	VM2065A0	TAPPO COLONNINA LM600 INF SX	1	PZ	VT1062A0	VETRO ESTERNO GRIGIO LINEMISS ARIANNA	1	PZ
Codice	Descrizione	Qtà	UM																																																																		
IP1385A1	IMB POL ANGOLARE 110X80X2000 D30	1.280	M																																																																		
RC1200A0	MOLLA A COMPRESSIO NE DE4 DF0.5 H24	2	PZ																																																																		
SL1050A1	NASTRO BIADESIVO 3M TRANSFER VH	0.820	M																																																																		
TB2301A0	COLONNINA DX XVC105E 40X40X1	2	PZ																																																																		
TB3081A0	COLONNINA SX LM ARI-RO	1	PZ																																																																		
VM1025A0	TAPPO NYLON PA66 V2 GRIGIO Ø16	2	PZ																																																																		
VM1059A1	FILM TERMORETRA IBILE H800	1	M																																																																		
VM1695A0	PERNO POSIZIONE MANIGLIA	2	PZ																																																																		
VM1920A0	PIASTRINA DX CHIUSURA VETRO INT	1	PZ																																																																		
VM1921A0	PIASTRINA SX CHIUSURA VETRO INT	1	PZ																																																																		
VM2062A0	TAPPO COLONNINA LM600 SUP DX	1	PZ																																																																		
VM2063A0	TAPPO COLONNINA LM600 SUP SX	1	PZ																																																																		
VM2064A0	TAPPO COLONNINA LM600 INF DX	1	PZ																																																																		
VM2065A0	TAPPO COLONNINA LM600 INF SX	1	PZ																																																																		
VT1062A0	VETRO ESTERNO GRIGIO LINEMISS ARIANNA	1	PZ																																																																		
			KVT1061A	KIT VETRO ESTERNO LM ARIANNA	<table border="1"> <thead> <tr> <th>Codice</th> <th>Descrizione</th> <th>Qtà</th> <th>UM</th> </tr> </thead> <tbody> <tr> <td>IP1385A1</td> <td>IMB POL ANGOLARE 110X80X2000 D30</td> <td>1.280</td> <td>M</td> </tr> </tbody> </table>	Codice	Descrizione	Qtà	UM	IP1385A1	IMB POL ANGOLARE 110X80X2000 D30	1.280	M																																																								
Codice	Descrizione	Qtà	UM																																																																		
IP1385A1	IMB POL ANGOLARE 110X80X2000 D30	1.280	M																																																																		

COMPONENTE			RICAMBIO																																																										
Codice	Descrizione	Immagine	Codice	Descrizione	Lista componenti																																																								
VM2065A	TAPPO COLONNINA LM600 INF SX		KVT1061A	KIT VETRO ESTERNO LM ARIANNA	<table border="1"> <thead> <tr> <th>Codice</th> <th>Descrizione</th> <th>Qtà</th> <th>UM</th> </tr> </thead> <tbody> <tr> <td>RC1200A0</td> <td>MOLLA A COMPRESSIO NE DE4 DF0.5 H24</td> <td>2</td> <td>PZ</td> </tr> <tr> <td>SL1050A1</td> <td>NASTRO BIADESIVO 3M TRANSFER VH</td> <td>0.820</td> <td>M</td> </tr> <tr> <td>TB2301A0</td> <td>COLONNINA DX XVC105E 40X40X1</td> <td>2</td> <td>PZ</td> </tr> <tr> <td>VM1025A0</td> <td>TAPPO NYLON PA66 V2 GRIGIO Ø16</td> <td>2</td> <td>PZ</td> </tr> <tr> <td>VM1059A1</td> <td>FILM TERMORETRA IBILE H800</td> <td>1.300</td> <td>M</td> </tr> <tr> <td>VM1695A0</td> <td>PERNO POSIZIONE MANIGLIA</td> <td>2</td> <td>PZ</td> </tr> <tr> <td>VM1920A0</td> <td>PIASTRINA DX CHIUSURA VETRO INT</td> <td>1</td> <td>PZ</td> </tr> <tr> <td>VM1921A0</td> <td>PIASTRINA SX CHIUSURA VETRO INT</td> <td>1</td> <td>PZ</td> </tr> <tr> <td>VM2062A0</td> <td>TAPPO COLONNINA LM600 SUP DX</td> <td>1</td> <td>PZ</td> </tr> <tr> <td>VM2063A0</td> <td>TAPPO COLONNINA LM600 SUP SX</td> <td>1</td> <td>PZ</td> </tr> <tr> <td>VM2064A0</td> <td>TAPPO COLONNINA LM600 INF DX</td> <td>1</td> <td>PZ</td> </tr> <tr> <td>VM2065A0</td> <td>TAPPO COLONNINA LM600 INF SX</td> <td>1</td> <td>PZ</td> </tr> <tr> <td>VT1061A2</td> <td>VETRO ESTERNO SER. GIALLO 598X424X5</td> <td>1</td> <td>PZ</td> </tr> </tbody> </table>	Codice	Descrizione	Qtà	UM	RC1200A0	MOLLA A COMPRESSIO NE DE4 DF0.5 H24	2	PZ	SL1050A1	NASTRO BIADESIVO 3M TRANSFER VH	0.820	M	TB2301A0	COLONNINA DX XVC105E 40X40X1	2	PZ	VM1025A0	TAPPO NYLON PA66 V2 GRIGIO Ø16	2	PZ	VM1059A1	FILM TERMORETRA IBILE H800	1.300	M	VM1695A0	PERNO POSIZIONE MANIGLIA	2	PZ	VM1920A0	PIASTRINA DX CHIUSURA VETRO INT	1	PZ	VM1921A0	PIASTRINA SX CHIUSURA VETRO INT	1	PZ	VM2062A0	TAPPO COLONNINA LM600 SUP DX	1	PZ	VM2063A0	TAPPO COLONNINA LM600 SUP SX	1	PZ	VM2064A0	TAPPO COLONNINA LM600 INF DX	1	PZ	VM2065A0	TAPPO COLONNINA LM600 INF SX	1	PZ	VT1061A2	VETRO ESTERNO SER. GIALLO 598X424X5	1	PZ
Codice	Descrizione	Qtà	UM																																																										
RC1200A0	MOLLA A COMPRESSIO NE DE4 DF0.5 H24	2	PZ																																																										
SL1050A1	NASTRO BIADESIVO 3M TRANSFER VH	0.820	M																																																										
TB2301A0	COLONNINA DX XVC105E 40X40X1	2	PZ																																																										
VM1025A0	TAPPO NYLON PA66 V2 GRIGIO Ø16	2	PZ																																																										
VM1059A1	FILM TERMORETRA IBILE H800	1.300	M																																																										
VM1695A0	PERNO POSIZIONE MANIGLIA	2	PZ																																																										
VM1920A0	PIASTRINA DX CHIUSURA VETRO INT	1	PZ																																																										
VM1921A0	PIASTRINA SX CHIUSURA VETRO INT	1	PZ																																																										
VM2062A0	TAPPO COLONNINA LM600 SUP DX	1	PZ																																																										
VM2063A0	TAPPO COLONNINA LM600 SUP SX	1	PZ																																																										
VM2064A0	TAPPO COLONNINA LM600 INF DX	1	PZ																																																										
VM2065A0	TAPPO COLONNINA LM600 INF SX	1	PZ																																																										
VT1061A2	VETRO ESTERNO SER. GIALLO 598X424X5	1	PZ																																																										
			KVT1057A	KIT VETRO ESTERNO NERO LMISS STEFANIA	<table border="1"> <thead> <tr> <th>Codice</th> <th>Descrizione</th> <th>Qtà</th> <th>UM</th> </tr> </thead> <tbody> <tr> <td>IP1385A1</td> <td>IMB POL ANGOLARE 110X80X2000 D30</td> <td>0.810</td> <td>M</td> </tr> <tr> <td>IP1508A0</td> <td>POLISTIROLO PROFILO AD U 2000X60X60</td> <td>0.950</td> <td>PZ</td> </tr> <tr> <td>IP1508A1</td> <td>POLISTIROLO PROFILO AD U 2000X60X60</td> <td>0.960</td> <td>M</td> </tr> </tbody> </table>	Codice	Descrizione	Qtà	UM	IP1385A1	IMB POL ANGOLARE 110X80X2000 D30	0.810	M	IP1508A0	POLISTIROLO PROFILO AD U 2000X60X60	0.950	PZ	IP1508A1	POLISTIROLO PROFILO AD U 2000X60X60	0.960	M																																								
Codice	Descrizione	Qtà	UM																																																										
IP1385A1	IMB POL ANGOLARE 110X80X2000 D30	0.810	M																																																										
IP1508A0	POLISTIROLO PROFILO AD U 2000X60X60	0.950	PZ																																																										
IP1508A1	POLISTIROLO PROFILO AD U 2000X60X60	0.960	M																																																										

COMPONENTE			RICAMBIO																																																														
Codice	Descrizione	Immagine	Codice	Descrizione	Lista componenti																																																												
VM2065A	TAPPO COLONNINA LM600 INF SX		KVT1057A	KIT VETRO ESTERNO NERO LMISS STEFANIA	<table border="1"> <thead> <tr> <th>Codice</th> <th>Descrizione</th> <th>Qtà</th> <th>UM</th> </tr> </thead> <tbody> <tr> <td>RC1200A0</td> <td>MOLLA A COMPRESSIO NE DE4 DF0.5 H24</td> <td>2</td> <td>PZ</td> </tr> <tr> <td>SL1050A1</td> <td>NASTRO BIADESIVO 3M TRANSFER VH</td> <td>0.660</td> <td>M</td> </tr> <tr> <td>TB2306A0</td> <td>COLONNINA DX LM STE-ELE 40X40X1</td> <td>2</td> <td>PZ</td> </tr> <tr> <td>TB3080A0</td> <td>COLONNINA SX LM STE-EL</td> <td>1</td> <td>PZ</td> </tr> <tr> <td>VM1025A0</td> <td>TAPPO NYLON PA66 V2 GRIGIO Ø16</td> <td>2</td> <td>PZ</td> </tr> <tr> <td>VM1059A1</td> <td>FILM TERMORETRA IBILE H800</td> <td>1</td> <td>M</td> </tr> <tr> <td>VM1695A0</td> <td>PERNO POSIZIONE MANIGLIA</td> <td>2</td> <td>PZ</td> </tr> <tr> <td>VM1920A0</td> <td>PIASTRINA DX CHIUSURA VETRO INT</td> <td>1</td> <td>PZ</td> </tr> <tr> <td>VM1921A0</td> <td>PIASTRINA SX CHIUSURA VETRO INT</td> <td>1</td> <td>PZ</td> </tr> <tr> <td>VM2062A0</td> <td>TAPPO COLONNINA LM600 SUP DX</td> <td>1</td> <td>PZ</td> </tr> <tr> <td>VM2063A0</td> <td>TAPPO COLONNINA LM600 SUP SX</td> <td>1</td> <td>PZ</td> </tr> <tr> <td>VM2064A0</td> <td>TAPPO COLONNINA LM600 INF DX</td> <td>1</td> <td>PZ</td> </tr> <tr> <td>VM2065A0</td> <td>TAPPO COLONNINA LM600 INF SX</td> <td>1</td> <td>PZ</td> </tr> <tr> <td>VT1057A0</td> <td>VETRO ESTERNO SER. GRIGIO 598X344X5</td> <td>1</td> <td>PZ</td> </tr> </tbody> </table>	Codice	Descrizione	Qtà	UM	RC1200A0	MOLLA A COMPRESSIO NE DE4 DF0.5 H24	2	PZ	SL1050A1	NASTRO BIADESIVO 3M TRANSFER VH	0.660	M	TB2306A0	COLONNINA DX LM STE-ELE 40X40X1	2	PZ	TB3080A0	COLONNINA SX LM STE-EL	1	PZ	VM1025A0	TAPPO NYLON PA66 V2 GRIGIO Ø16	2	PZ	VM1059A1	FILM TERMORETRA IBILE H800	1	M	VM1695A0	PERNO POSIZIONE MANIGLIA	2	PZ	VM1920A0	PIASTRINA DX CHIUSURA VETRO INT	1	PZ	VM1921A0	PIASTRINA SX CHIUSURA VETRO INT	1	PZ	VM2062A0	TAPPO COLONNINA LM600 SUP DX	1	PZ	VM2063A0	TAPPO COLONNINA LM600 SUP SX	1	PZ	VM2064A0	TAPPO COLONNINA LM600 INF DX	1	PZ	VM2065A0	TAPPO COLONNINA LM600 INF SX	1	PZ	VT1057A0	VETRO ESTERNO SER. GRIGIO 598X344X5	1	PZ
Codice	Descrizione	Qtà	UM																																																														
RC1200A0	MOLLA A COMPRESSIO NE DE4 DF0.5 H24	2	PZ																																																														
SL1050A1	NASTRO BIADESIVO 3M TRANSFER VH	0.660	M																																																														
TB2306A0	COLONNINA DX LM STE-ELE 40X40X1	2	PZ																																																														
TB3080A0	COLONNINA SX LM STE-EL	1	PZ																																																														
VM1025A0	TAPPO NYLON PA66 V2 GRIGIO Ø16	2	PZ																																																														
VM1059A1	FILM TERMORETRA IBILE H800	1	M																																																														
VM1695A0	PERNO POSIZIONE MANIGLIA	2	PZ																																																														
VM1920A0	PIASTRINA DX CHIUSURA VETRO INT	1	PZ																																																														
VM1921A0	PIASTRINA SX CHIUSURA VETRO INT	1	PZ																																																														
VM2062A0	TAPPO COLONNINA LM600 SUP DX	1	PZ																																																														
VM2063A0	TAPPO COLONNINA LM600 SUP SX	1	PZ																																																														
VM2064A0	TAPPO COLONNINA LM600 INF DX	1	PZ																																																														
VM2065A0	TAPPO COLONNINA LM600 INF SX	1	PZ																																																														
VT1057A0	VETRO ESTERNO SER. GRIGIO 598X344X5	1	PZ																																																														
			KVT1056A	KIT VETRO ESTERNO GIALLO LMISS STEFANIA	<table border="1"> <thead> <tr> <th>Codice</th> <th>Descrizione</th> <th>Qtà</th> <th>UM</th> </tr> </thead> <tbody> <tr> <td>IP1385A1</td> <td>IMB POL ANGOLARE 110X80X2000 D30</td> <td>0.980</td> <td>M</td> </tr> <tr> <td>IP1508A0</td> <td>POLISTIROLO PROFILO AD U 2000X60X60</td> <td>0.960</td> <td>PZ</td> </tr> </tbody> </table>	Codice	Descrizione	Qtà	UM	IP1385A1	IMB POL ANGOLARE 110X80X2000 D30	0.980	M	IP1508A0	POLISTIROLO PROFILO AD U 2000X60X60	0.960	PZ																																																
Codice	Descrizione	Qtà	UM																																																														
IP1385A1	IMB POL ANGOLARE 110X80X2000 D30	0.980	M																																																														
IP1508A0	POLISTIROLO PROFILO AD U 2000X60X60	0.960	PZ																																																														

COMPONENTE			RICAMBIO																																																														
Codice	Descrizione	Immagine	Codice	Descrizione	Lista componenti																																																												
VM2065A	TAPPO COLONNINA LM600 INF SX		KVT1056A	KIT VETRO ESTERNO GIALLO LMISS STEFANIA	<table border="1"> <thead> <tr> <th>Codice</th> <th>Descrizione</th> <th>Qtà</th> <th>UM</th> </tr> </thead> <tbody> <tr> <td>IP1508A1</td> <td>POLISTIROLO PROFILO AD U 2000X60X60</td> <td>0.960</td> <td>M</td> </tr> <tr> <td>RC1200A0</td> <td>MOLLA A COMPRESSIO NE DE4 DF0.5 H24</td> <td>2</td> <td>PZ</td> </tr> <tr> <td>SL1050A1</td> <td>NASTRO BIADESIVO 3M TRANSFER VH</td> <td>0.660</td> <td>M</td> </tr> <tr> <td>TB2306A0</td> <td>COLONNINA DX LM STE-ELE 40X40X1</td> <td>2</td> <td>PZ</td> </tr> <tr> <td>VM1025A0</td> <td>TAPPO NYLON PA66 V2 GRIGIO Ø16</td> <td>2</td> <td>PZ</td> </tr> <tr> <td>VM1059A1</td> <td>FILM TERMORETRA IBILE H800</td> <td>1.300</td> <td>M</td> </tr> <tr> <td>VM1695A0</td> <td>PERNO POSIZIONE MANIGLIA</td> <td>2</td> <td>PZ</td> </tr> <tr> <td>VM1920A0</td> <td>PIASTRINA DX CHIUSURA VETRO INT</td> <td>1</td> <td>PZ</td> </tr> <tr> <td>VM1921A0</td> <td>PIASTRINA SX CHIUSURA VETRO INT</td> <td>1</td> <td>PZ</td> </tr> <tr> <td>VM2062A0</td> <td>TAPPO COLONNINA LM600 SUP DX</td> <td>1</td> <td>PZ</td> </tr> <tr> <td>VM2063A0</td> <td>TAPPO COLONNINA LM600 SUP SX</td> <td>1</td> <td>PZ</td> </tr> <tr> <td>VM2064A0</td> <td>TAPPO COLONNINA LM600 INF DX</td> <td>1</td> <td>PZ</td> </tr> <tr> <td>VM2065A0</td> <td>TAPPO COLONNINA LM600 INF SX</td> <td>1</td> <td>PZ</td> </tr> <tr> <td>VT1056A2</td> <td>VETRO ESTERNO SER. GIALLO 598X344X5</td> <td>1</td> <td>PZ</td> </tr> </tbody> </table>	Codice	Descrizione	Qtà	UM	IP1508A1	POLISTIROLO PROFILO AD U 2000X60X60	0.960	M	RC1200A0	MOLLA A COMPRESSIO NE DE4 DF0.5 H24	2	PZ	SL1050A1	NASTRO BIADESIVO 3M TRANSFER VH	0.660	M	TB2306A0	COLONNINA DX LM STE-ELE 40X40X1	2	PZ	VM1025A0	TAPPO NYLON PA66 V2 GRIGIO Ø16	2	PZ	VM1059A1	FILM TERMORETRA IBILE H800	1.300	M	VM1695A0	PERNO POSIZIONE MANIGLIA	2	PZ	VM1920A0	PIASTRINA DX CHIUSURA VETRO INT	1	PZ	VM1921A0	PIASTRINA SX CHIUSURA VETRO INT	1	PZ	VM2062A0	TAPPO COLONNINA LM600 SUP DX	1	PZ	VM2063A0	TAPPO COLONNINA LM600 SUP SX	1	PZ	VM2064A0	TAPPO COLONNINA LM600 INF DX	1	PZ	VM2065A0	TAPPO COLONNINA LM600 INF SX	1	PZ	VT1056A2	VETRO ESTERNO SER. GIALLO 598X344X5	1	PZ
Codice	Descrizione	Qtà	UM																																																														
IP1508A1	POLISTIROLO PROFILO AD U 2000X60X60	0.960	M																																																														
RC1200A0	MOLLA A COMPRESSIO NE DE4 DF0.5 H24	2	PZ																																																														
SL1050A1	NASTRO BIADESIVO 3M TRANSFER VH	0.660	M																																																														
TB2306A0	COLONNINA DX LM STE-ELE 40X40X1	2	PZ																																																														
VM1025A0	TAPPO NYLON PA66 V2 GRIGIO Ø16	2	PZ																																																														
VM1059A1	FILM TERMORETRA IBILE H800	1.300	M																																																														
VM1695A0	PERNO POSIZIONE MANIGLIA	2	PZ																																																														
VM1920A0	PIASTRINA DX CHIUSURA VETRO INT	1	PZ																																																														
VM1921A0	PIASTRINA SX CHIUSURA VETRO INT	1	PZ																																																														
VM2062A0	TAPPO COLONNINA LM600 SUP DX	1	PZ																																																														
VM2063A0	TAPPO COLONNINA LM600 SUP SX	1	PZ																																																														
VM2064A0	TAPPO COLONNINA LM600 INF DX	1	PZ																																																														
VM2065A0	TAPPO COLONNINA LM600 INF SX	1	PZ																																																														
VT1056A2	VETRO ESTERNO SER. GIALLO 598X344X5	1	PZ																																																														
			KVT1052A	KIT VETRO ESTERNO NERO LINEMISS CRISTINA	<table border="1"> <thead> <tr> <th>Codice</th> <th>Descrizione</th> <th>Qtà</th> <th>UM</th> </tr> </thead> <tbody> <tr> <td>RC1200A0</td> <td>MOLLA A COMPRESSIO NE DE4 DF0.5 H24</td> <td>2</td> <td>PZ</td> </tr> <tr> <td>SL1050A1</td> <td>NASTRO BIADESIVO 3M TRANSFER VH</td> <td>0.660</td> <td>M</td> </tr> </tbody> </table>	Codice	Descrizione	Qtà	UM	RC1200A0	MOLLA A COMPRESSIO NE DE4 DF0.5 H24	2	PZ	SL1050A1	NASTRO BIADESIVO 3M TRANSFER VH	0.660	M																																																
Codice	Descrizione	Qtà	UM																																																														
RC1200A0	MOLLA A COMPRESSIO NE DE4 DF0.5 H24	2	PZ																																																														
SL1050A1	NASTRO BIADESIVO 3M TRANSFER VH	0.660	M																																																														

COMPONENTE			RICAMBIO																																														
Codice	Descrizione	Immagine	Codice	Descrizione	Lista componenti																																												
VM2065A	TAPPO COLONNINA LM600 INF SX		KVT1052A	KIT VETRO ESTERNO NERO LINEMISS CRISTINA	<table border="1"> <thead> <tr> <th>Codice</th> <th>Descrizione</th> <th>Qtà</th> <th>UM</th> </tr> </thead> <tbody> <tr> <td>TB2306A0</td> <td>COLONNINA DX LM STE-ELE 40X40X1</td> <td>2</td> <td>PZ</td> </tr> <tr> <td>VM1025A0</td> <td>TAPPO NYLON PA66 V2 GRIGIO Ø16</td> <td>2</td> <td>PZ</td> </tr> <tr> <td>VM1695A0</td> <td>PERNO POSIZIONE MANIGLIA</td> <td>2</td> <td>PZ</td> </tr> <tr> <td>VM1920A0</td> <td>PIASTRINA DX CHIUSURA VETRO INT</td> <td>1</td> <td>PZ</td> </tr> <tr> <td>VM1921A0</td> <td>PIASTRINA SX CHIUSURA VETRO INT</td> <td>1</td> <td>PZ</td> </tr> <tr> <td>VM2062A0</td> <td>TAPPO COLONNINA LM600 SUP DX</td> <td>1</td> <td>PZ</td> </tr> <tr> <td>VM2063A0</td> <td>TAPPO COLONNINA LM600 SUP SX</td> <td>1</td> <td>PZ</td> </tr> <tr> <td>VM2064A0</td> <td>TAPPO COLONNINA LM600 INF DX</td> <td>1</td> <td>PZ</td> </tr> <tr> <td>VM2065A0</td> <td>TAPPO COLONNINA LM600 INF SX</td> <td>1</td> <td>PZ</td> </tr> <tr> <td>VT1052A0</td> <td>VETRO ESTERNO SER. GRIGIO 478X344X5</td> <td>1</td> <td>PZ</td> </tr> </tbody> </table>	Codice	Descrizione	Qtà	UM	TB2306A0	COLONNINA DX LM STE-ELE 40X40X1	2	PZ	VM1025A0	TAPPO NYLON PA66 V2 GRIGIO Ø16	2	PZ	VM1695A0	PERNO POSIZIONE MANIGLIA	2	PZ	VM1920A0	PIASTRINA DX CHIUSURA VETRO INT	1	PZ	VM1921A0	PIASTRINA SX CHIUSURA VETRO INT	1	PZ	VM2062A0	TAPPO COLONNINA LM600 SUP DX	1	PZ	VM2063A0	TAPPO COLONNINA LM600 SUP SX	1	PZ	VM2064A0	TAPPO COLONNINA LM600 INF DX	1	PZ	VM2065A0	TAPPO COLONNINA LM600 INF SX	1	PZ	VT1052A0	VETRO ESTERNO SER. GRIGIO 478X344X5	1	PZ
			Codice	Descrizione	Qtà	UM																																											
TB2306A0	COLONNINA DX LM STE-ELE 40X40X1	2	PZ																																														
VM1025A0	TAPPO NYLON PA66 V2 GRIGIO Ø16	2	PZ																																														
VM1695A0	PERNO POSIZIONE MANIGLIA	2	PZ																																														
VM1920A0	PIASTRINA DX CHIUSURA VETRO INT	1	PZ																																														
VM1921A0	PIASTRINA SX CHIUSURA VETRO INT	1	PZ																																														
VM2062A0	TAPPO COLONNINA LM600 SUP DX	1	PZ																																														
VM2063A0	TAPPO COLONNINA LM600 SUP SX	1	PZ																																														
VM2064A0	TAPPO COLONNINA LM600 INF DX	1	PZ																																														
VM2065A0	TAPPO COLONNINA LM600 INF SX	1	PZ																																														
VT1052A0	VETRO ESTERNO SER. GRIGIO 478X344X5	1	PZ																																														
KVT1051A	KIT VETRO ESTERNO GIALLO L.MISS CRISTINA	<table border="1"> <thead> <tr> <th>Codice</th> <th>Descrizione</th> <th>Qtà</th> <th>UM</th> </tr> </thead> <tbody> <tr> <td>IP1385A1</td> <td>IMB POL ANGOLARE 110X80X2000 D30</td> <td>1.040</td> <td>M</td> </tr> <tr> <td>RC1200A0</td> <td>MOLLA A COMPRESSIO NE DE4 DF0.5 H24</td> <td>2</td> <td>PZ</td> </tr> <tr> <td>SL1050A1</td> <td>NASTRO BIADESIVO 3M TRANSFER VH</td> <td>0.660</td> <td>M</td> </tr> <tr> <td>TB2306A0</td> <td>COLONNINA DX LM STE-ELE 40X40X1</td> <td>2</td> <td>PZ</td> </tr> <tr> <td>VM1025A0</td> <td>TAPPO NYLON PA66 V2 GRIGIO Ø16</td> <td>2</td> <td>PZ</td> </tr> <tr> <td>VM1059A1</td> <td>FILM TERMORETRA IBILE H800</td> <td>1.500</td> <td>M</td> </tr> </tbody> </table>	Codice	Descrizione	Qtà	UM	IP1385A1	IMB POL ANGOLARE 110X80X2000 D30	1.040	M	RC1200A0	MOLLA A COMPRESSIO NE DE4 DF0.5 H24	2	PZ	SL1050A1	NASTRO BIADESIVO 3M TRANSFER VH	0.660	M	TB2306A0	COLONNINA DX LM STE-ELE 40X40X1	2	PZ	VM1025A0	TAPPO NYLON PA66 V2 GRIGIO Ø16	2	PZ	VM1059A1	FILM TERMORETRA IBILE H800	1.500	M																			
Codice	Descrizione	Qtà	UM																																														
IP1385A1	IMB POL ANGOLARE 110X80X2000 D30	1.040	M																																														
RC1200A0	MOLLA A COMPRESSIO NE DE4 DF0.5 H24	2	PZ																																														
SL1050A1	NASTRO BIADESIVO 3M TRANSFER VH	0.660	M																																														
TB2306A0	COLONNINA DX LM STE-ELE 40X40X1	2	PZ																																														
VM1025A0	TAPPO NYLON PA66 V2 GRIGIO Ø16	2	PZ																																														
VM1059A1	FILM TERMORETRA IBILE H800	1.500	M																																														

COMPONENTE			RICAMBIO																																										
Codice	Descrizione	Immagine	Codice	Descrizione	Lista componenti																																								
VM2065A	TAPPO COLONNINA LM600 INF SX		KVT1051A	KIT VETRO ESTERNO GIALLO L.MISS CRISTINA	<table border="1"> <thead> <tr> <th>Codice</th> <th>Descrizione</th> <th>Qtà</th> <th>UM</th> </tr> </thead> <tbody> <tr> <td>VM1695A0</td> <td>PERNO POSIZIONE MANIGLIA</td> <td>2</td> <td>PZ</td> </tr> <tr> <td>VM1920A0</td> <td>PIASTRINA DX CHIUSURA VETRO INT</td> <td>1</td> <td>PZ</td> </tr> <tr> <td>VM1921A0</td> <td>PIASTRINA SX CHIUSURA VETRO INT</td> <td>1</td> <td>PZ</td> </tr> <tr> <td>VM2062A0</td> <td>TAPPO COLONNINA LM600 SUP DX</td> <td>1</td> <td>PZ</td> </tr> <tr> <td>VM2063A0</td> <td>TAPPO COLONNINA LM600 SUP SX</td> <td>1</td> <td>PZ</td> </tr> <tr> <td>VM2064A0</td> <td>TAPPO COLONNINA LM600 INF DX</td> <td>1</td> <td>PZ</td> </tr> <tr> <td>VM2065A0</td> <td>TAPPO COLONNINA LM600 INF SX</td> <td>1</td> <td>PZ</td> </tr> <tr> <td>VT1051A2</td> <td>VETRO ESTERNO SER. GIALLO 478X344X5</td> <td>1</td> <td>PZ</td> </tr> </tbody> </table>	Codice	Descrizione	Qtà	UM	VM1695A0	PERNO POSIZIONE MANIGLIA	2	PZ	VM1920A0	PIASTRINA DX CHIUSURA VETRO INT	1	PZ	VM1921A0	PIASTRINA SX CHIUSURA VETRO INT	1	PZ	VM2062A0	TAPPO COLONNINA LM600 SUP DX	1	PZ	VM2063A0	TAPPO COLONNINA LM600 SUP SX	1	PZ	VM2064A0	TAPPO COLONNINA LM600 INF DX	1	PZ	VM2065A0	TAPPO COLONNINA LM600 INF SX	1	PZ	VT1051A2	VETRO ESTERNO SER. GIALLO 478X344X5	1	PZ				
Codice	Descrizione	Qtà	UM																																										
VM1695A0	PERNO POSIZIONE MANIGLIA	2	PZ																																										
VM1920A0	PIASTRINA DX CHIUSURA VETRO INT	1	PZ																																										
VM1921A0	PIASTRINA SX CHIUSURA VETRO INT	1	PZ																																										
VM2062A0	TAPPO COLONNINA LM600 SUP DX	1	PZ																																										
VM2063A0	TAPPO COLONNINA LM600 SUP SX	1	PZ																																										
VM2064A0	TAPPO COLONNINA LM600 INF DX	1	PZ																																										
VM2065A0	TAPPO COLONNINA LM600 INF SX	1	PZ																																										
VT1051A2	VETRO ESTERNO SER. GIALLO 478X344X5	1	PZ																																										
VM1920A	PIASTRINA DX CHIUSURA VETRO INT		KVT1253A	KIT VETRO ESTERNO XF195-EG VT1253A	<table border="1"> <thead> <tr> <th>Codice</th> <th>Descrizione</th> <th>Qtà</th> <th>UM</th> </tr> </thead> <tbody> <tr> <td>IP1235B0</td> <td>IMBALLO POLISTIROLO PIANO</td> <td>1</td> <td>PZ</td> </tr> <tr> <td>RC1200A0</td> <td>MOLLA A COMPRESSIO NE DE4 DF0.5 H24</td> <td>2</td> <td>PZ</td> </tr> <tr> <td>SL1050A1</td> <td>NASTRO BIADESIVO 3M TRANSFER VH</td> <td>0.820</td> <td>M</td> </tr> <tr> <td>TB2301A0</td> <td>COLONNINA DX XVC105E 40X40X1</td> <td>2</td> <td>PZ</td> </tr> <tr> <td>TB3081A0</td> <td>COLONNINA SX LM ARI-RO</td> <td>1</td> <td>PZ</td> </tr> <tr> <td>VM1025A0</td> <td>TAPPO NYLON PA66 V2 GRIGIO Ø16</td> <td>2</td> <td>PZ</td> </tr> <tr> <td>VM1695A0</td> <td>PERNO POSIZIONE MANIGLIA</td> <td>2</td> <td>PZ</td> </tr> <tr> <td>VM1916A0</td> <td>TAPPO COLONNINA SUP DX</td> <td>1</td> <td>PZ</td> </tr> <tr> <td>VM1917A0</td> <td>TAPPO COLONNINA SUP SX</td> <td>1</td> <td>PZ</td> </tr> </tbody> </table>	Codice	Descrizione	Qtà	UM	IP1235B0	IMBALLO POLISTIROLO PIANO	1	PZ	RC1200A0	MOLLA A COMPRESSIO NE DE4 DF0.5 H24	2	PZ	SL1050A1	NASTRO BIADESIVO 3M TRANSFER VH	0.820	M	TB2301A0	COLONNINA DX XVC105E 40X40X1	2	PZ	TB3081A0	COLONNINA SX LM ARI-RO	1	PZ	VM1025A0	TAPPO NYLON PA66 V2 GRIGIO Ø16	2	PZ	VM1695A0	PERNO POSIZIONE MANIGLIA	2	PZ	VM1916A0	TAPPO COLONNINA SUP DX	1	PZ	VM1917A0	TAPPO COLONNINA SUP SX	1	PZ
Codice	Descrizione	Qtà	UM																																										
IP1235B0	IMBALLO POLISTIROLO PIANO	1	PZ																																										
RC1200A0	MOLLA A COMPRESSIO NE DE4 DF0.5 H24	2	PZ																																										
SL1050A1	NASTRO BIADESIVO 3M TRANSFER VH	0.820	M																																										
TB2301A0	COLONNINA DX XVC105E 40X40X1	2	PZ																																										
TB3081A0	COLONNINA SX LM ARI-RO	1	PZ																																										
VM1025A0	TAPPO NYLON PA66 V2 GRIGIO Ø16	2	PZ																																										
VM1695A0	PERNO POSIZIONE MANIGLIA	2	PZ																																										
VM1916A0	TAPPO COLONNINA SUP DX	1	PZ																																										
VM1917A0	TAPPO COLONNINA SUP SX	1	PZ																																										

COMPONENTE			RICAMBIO																																																							
Codice	Descrizione	Immagine	Codice	Descrizione	Lista componenti																																																					
VM1920A	PIASTRINA DX CHIUSURA VETRO INT		KVT1253A	KIT VETRO ESTERNO XF195-EG VT1253A	<table border="1"> <thead> <tr> <th>Codice</th> <th>Descrizione</th> <th>Qtà</th> <th>UM</th> </tr> </thead> <tbody> <tr> <td>VM1918A0</td> <td>TAPPO COLONNINA INF DX</td> <td>1</td> <td>PZ</td> </tr> <tr> <td>VM1919A0</td> <td>TAPPO COLONNINA INF SX</td> <td>1</td> <td>PZ</td> </tr> <tr> <td>VM1920A0</td> <td>PIASTRINA DX CHIUSURA VETRO INT</td> <td>1</td> <td>PZ</td> </tr> <tr> <td>VM1921A0</td> <td>PIASTRINA SX CHIUSURA VETRO INT</td> <td>1</td> <td>PZ</td> </tr> <tr> <td>VT1253A0</td> <td>VETRO EST.XF195 NERO ENGEFOOD</td> <td>1</td> <td>PZ</td> </tr> </tbody> </table>	Codice	Descrizione	Qtà	UM	VM1918A0	TAPPO COLONNINA INF DX	1	PZ	VM1919A0	TAPPO COLONNINA INF SX	1	PZ	VM1920A0	PIASTRINA DX CHIUSURA VETRO INT	1	PZ	VM1921A0	PIASTRINA SX CHIUSURA VETRO INT	1	PZ	VT1253A0	VETRO EST.XF195 NERO ENGEFOOD	1	PZ																													
			Codice	Descrizione	Qtà	UM																																																				
VM1918A0	TAPPO COLONNINA INF DX	1	PZ																																																							
VM1919A0	TAPPO COLONNINA INF SX	1	PZ																																																							
VM1920A0	PIASTRINA DX CHIUSURA VETRO INT	1	PZ																																																							
VM1921A0	PIASTRINA SX CHIUSURA VETRO INT	1	PZ																																																							
VT1253A0	VETRO EST.XF195 NERO ENGEFOOD	1	PZ																																																							
KVT1252A	KIT VETRO ESTERNO XF135-EG VT1252A	<table border="1"> <thead> <tr> <th>Codice</th> <th>Descrizione</th> <th>Qtà</th> <th>UM</th> </tr> </thead> <tbody> <tr> <td>RC1200A0</td> <td>MOLLA A COMPRESSIO NE DE4 DF0.5 H24</td> <td>2</td> <td>PZ</td> </tr> <tr> <td>SL1050A1</td> <td>NASTRO BIADESIVO 3M TRANSFER VH</td> <td>0.820</td> <td>M</td> </tr> <tr> <td>TB2301A0</td> <td>COLONNINA DX XVC105E 40X40X1</td> <td>2</td> <td>PZ</td> </tr> <tr> <td>TB3081A0</td> <td>COLONNINA SX LM ARI-RO</td> <td>1</td> <td>PZ</td> </tr> <tr> <td>VM1025A0</td> <td>TAPPO NYLON PA66 V2 GRIGIO Ø16</td> <td>2</td> <td>PZ</td> </tr> <tr> <td>VM1695A0</td> <td>PERNO POSIZIONE MANIGLIA</td> <td>2</td> <td>PZ</td> </tr> <tr> <td>VM1920A0</td> <td>PIASTRINA DX CHIUSURA VETRO INT</td> <td>1</td> <td>PZ</td> </tr> <tr> <td>VM1921A0</td> <td>PIASTRINA SX CHIUSURA VETRO INT</td> <td>1</td> <td>PZ</td> </tr> <tr> <td>VM2062A0</td> <td>TAPPO COLONNINA LM600 SUP DX</td> <td>1</td> <td>PZ</td> </tr> <tr> <td>VM2063A0</td> <td>TAPPO COLONNINA LM600 SUP SX</td> <td>1</td> <td>PZ</td> </tr> <tr> <td>VM2064A0</td> <td>TAPPO COLONNINA LM600 INF DX</td> <td>1</td> <td>PZ</td> </tr> <tr> <td>VM2065A0</td> <td>TAPPO COLONNINA LM600 INF SX</td> <td>1</td> <td>PZ</td> </tr> <tr> <td>VT1252A0</td> <td>VETRO EST.XF135 NERO ENGEFOOD</td> <td>1</td> <td>PZ</td> </tr> </tbody> </table>	Codice	Descrizione	Qtà	UM	RC1200A0	MOLLA A COMPRESSIO NE DE4 DF0.5 H24	2	PZ	SL1050A1	NASTRO BIADESIVO 3M TRANSFER VH	0.820	M	TB2301A0	COLONNINA DX XVC105E 40X40X1	2	PZ	TB3081A0	COLONNINA SX LM ARI-RO	1	PZ	VM1025A0	TAPPO NYLON PA66 V2 GRIGIO Ø16	2	PZ	VM1695A0	PERNO POSIZIONE MANIGLIA	2	PZ	VM1920A0	PIASTRINA DX CHIUSURA VETRO INT	1	PZ	VM1921A0	PIASTRINA SX CHIUSURA VETRO INT	1	PZ	VM2062A0	TAPPO COLONNINA LM600 SUP DX	1	PZ	VM2063A0	TAPPO COLONNINA LM600 SUP SX	1	PZ	VM2064A0	TAPPO COLONNINA LM600 INF DX	1	PZ	VM2065A0	TAPPO COLONNINA LM600 INF SX	1	PZ	VT1252A0	VETRO EST.XF135 NERO ENGEFOOD	1	PZ
Codice	Descrizione	Qtà	UM																																																							
RC1200A0	MOLLA A COMPRESSIO NE DE4 DF0.5 H24	2	PZ																																																							
SL1050A1	NASTRO BIADESIVO 3M TRANSFER VH	0.820	M																																																							
TB2301A0	COLONNINA DX XVC105E 40X40X1	2	PZ																																																							
TB3081A0	COLONNINA SX LM ARI-RO	1	PZ																																																							
VM1025A0	TAPPO NYLON PA66 V2 GRIGIO Ø16	2	PZ																																																							
VM1695A0	PERNO POSIZIONE MANIGLIA	2	PZ																																																							
VM1920A0	PIASTRINA DX CHIUSURA VETRO INT	1	PZ																																																							
VM1921A0	PIASTRINA SX CHIUSURA VETRO INT	1	PZ																																																							
VM2062A0	TAPPO COLONNINA LM600 SUP DX	1	PZ																																																							
VM2063A0	TAPPO COLONNINA LM600 SUP SX	1	PZ																																																							
VM2064A0	TAPPO COLONNINA LM600 INF DX	1	PZ																																																							
VM2065A0	TAPPO COLONNINA LM600 INF SX	1	PZ																																																							
VT1252A0	VETRO EST.XF135 NERO ENGEFOOD	1	PZ																																																							

COMPONENTE			RICAMBIO																																																																										
Codice	Descrizione	Immagine	Codice	Descrizione	Lista componenti																																																																								
VM1920A	PIASTRINA DX CHIUSURA VETRO INT		KVT1072A	KIT VETRO ESTERNO LM ROSSELLA BLACK	<table border="1"> <thead> <tr> <th>Codice</th> <th>Descrizione</th> <th>Qtà</th> <th>UM</th> </tr> </thead> <tbody> <tr> <td>IP1385A1</td> <td>IMB POL ANGOLARE 110X80X2000 D30</td> <td>0.960</td> <td>M</td> </tr> <tr> <td>IP1508A0</td> <td>POLISTIROLO PROFILO AD U 2000X60X60</td> <td>1.280</td> <td>PZ</td> </tr> <tr> <td>IP1508A1</td> <td>POLISTIROLO PROFILO AD U 2000X60X60</td> <td>1.270</td> <td>M</td> </tr> <tr> <td>RC1200A0</td> <td>MOLLA A COMPRESSIO NE DE4 DF0.5 H24</td> <td>2</td> <td>PZ</td> </tr> <tr> <td>SL1050A1</td> <td>NASTRO BIADESIVO 3M TRANSFER VH</td> <td>0.820</td> <td>M</td> </tr> <tr> <td>TB2301A0</td> <td>COLONNINA DX XVC105E 40X40X1</td> <td>2</td> <td>PZ</td> </tr> <tr> <td>TB3081A0</td> <td>COLONNINA SX LM ARI-RO</td> <td>1</td> <td>PZ</td> </tr> <tr> <td>VM1025A0</td> <td>TAPPO NYLON PA66 V2 GRIGIO Ø16</td> <td>2</td> <td>PZ</td> </tr> <tr> <td>VM1059A1</td> <td>FILM TERMORETRA IBILE H800</td> <td>1.300</td> <td>M</td> </tr> <tr> <td>VM1695A0</td> <td>PERNO POSIZIONE MANIGLIA</td> <td>2</td> <td>PZ</td> </tr> <tr> <td>VM1916A0</td> <td>TAPPO COLONNINA SUP DX</td> <td>1</td> <td>PZ</td> </tr> <tr> <td>VM1917A0</td> <td>TAPPO COLONNINA SUP SX</td> <td>1</td> <td>PZ</td> </tr> <tr> <td>VM1918A0</td> <td>TAPPO COLONNINA INF DX</td> <td>1</td> <td>PZ</td> </tr> <tr> <td>VM1919A0</td> <td>TAPPO COLONNINA INF SX</td> <td>1</td> <td>PZ</td> </tr> <tr> <td>VM1920A0</td> <td>PIASTRINA DX CHIUSURA VETRO INT</td> <td>1</td> <td>PZ</td> </tr> <tr> <td>VM1921A0</td> <td>PIASTRINA SX CHIUSURA VETRO INT</td> <td>1</td> <td>PZ</td> </tr> <tr> <td>VT1072A0</td> <td>VETRO EST. 798X424 NERO LMISS ROSSELLA</td> <td>1</td> <td>PZ</td> </tr> </tbody> </table>	Codice	Descrizione	Qtà	UM	IP1385A1	IMB POL ANGOLARE 110X80X2000 D30	0.960	M	IP1508A0	POLISTIROLO PROFILO AD U 2000X60X60	1.280	PZ	IP1508A1	POLISTIROLO PROFILO AD U 2000X60X60	1.270	M	RC1200A0	MOLLA A COMPRESSIO NE DE4 DF0.5 H24	2	PZ	SL1050A1	NASTRO BIADESIVO 3M TRANSFER VH	0.820	M	TB2301A0	COLONNINA DX XVC105E 40X40X1	2	PZ	TB3081A0	COLONNINA SX LM ARI-RO	1	PZ	VM1025A0	TAPPO NYLON PA66 V2 GRIGIO Ø16	2	PZ	VM1059A1	FILM TERMORETRA IBILE H800	1.300	M	VM1695A0	PERNO POSIZIONE MANIGLIA	2	PZ	VM1916A0	TAPPO COLONNINA SUP DX	1	PZ	VM1917A0	TAPPO COLONNINA SUP SX	1	PZ	VM1918A0	TAPPO COLONNINA INF DX	1	PZ	VM1919A0	TAPPO COLONNINA INF SX	1	PZ	VM1920A0	PIASTRINA DX CHIUSURA VETRO INT	1	PZ	VM1921A0	PIASTRINA SX CHIUSURA VETRO INT	1	PZ	VT1072A0	VETRO EST. 798X424 NERO LMISS ROSSELLA	1	PZ
Codice	Descrizione	Qtà	UM																																																																										
IP1385A1	IMB POL ANGOLARE 110X80X2000 D30	0.960	M																																																																										
IP1508A0	POLISTIROLO PROFILO AD U 2000X60X60	1.280	PZ																																																																										
IP1508A1	POLISTIROLO PROFILO AD U 2000X60X60	1.270	M																																																																										
RC1200A0	MOLLA A COMPRESSIO NE DE4 DF0.5 H24	2	PZ																																																																										
SL1050A1	NASTRO BIADESIVO 3M TRANSFER VH	0.820	M																																																																										
TB2301A0	COLONNINA DX XVC105E 40X40X1	2	PZ																																																																										
TB3081A0	COLONNINA SX LM ARI-RO	1	PZ																																																																										
VM1025A0	TAPPO NYLON PA66 V2 GRIGIO Ø16	2	PZ																																																																										
VM1059A1	FILM TERMORETRA IBILE H800	1.300	M																																																																										
VM1695A0	PERNO POSIZIONE MANIGLIA	2	PZ																																																																										
VM1916A0	TAPPO COLONNINA SUP DX	1	PZ																																																																										
VM1917A0	TAPPO COLONNINA SUP SX	1	PZ																																																																										
VM1918A0	TAPPO COLONNINA INF DX	1	PZ																																																																										
VM1919A0	TAPPO COLONNINA INF SX	1	PZ																																																																										
VM1920A0	PIASTRINA DX CHIUSURA VETRO INT	1	PZ																																																																										
VM1921A0	PIASTRINA SX CHIUSURA VETRO INT	1	PZ																																																																										
VT1072A0	VETRO EST. 798X424 NERO LMISS ROSSELLA	1	PZ																																																																										

COMPONENTE			RICAMBIO																																																																						
Codice	Descrizione	Immagine	Codice	Descrizione	Lista componenti																																																																				
VM1920A	PIASTRINA DX CHIUSURA VETRO INT		KVT1071A	KIT VETRO ESTERNO LM ROSSELLA	<table border="1"> <thead> <tr> <th>Codice</th> <th>Descrizione</th> <th>Qtà</th> <th>UM</th> </tr> </thead> <tbody> <tr> <td>IP1385A1</td> <td>IMB POL ANGOLARE 110X80X2000 D30</td> <td>0.960</td> <td>M</td> </tr> <tr> <td>IP1508A0</td> <td>POLISTIROLO PROFILO AD U 2000X60X60</td> <td>1.300</td> <td>PZ</td> </tr> <tr> <td>IP1508A1</td> <td>POLISTIROLO PROFILO AD U 2000X60X60</td> <td>2</td> <td>M</td> </tr> <tr> <td>RC1200A0</td> <td>MOLLA A COMPRESSIO NE DE4 DF0.5 H24</td> <td>2</td> <td>PZ</td> </tr> <tr> <td>SL1050A1</td> <td>NASTRO BIADESIVO 3M TRANSFER VH</td> <td>0.820</td> <td>M</td> </tr> <tr> <td>TB2301A0</td> <td>COLONNINA DX XVC105E 40X40X1</td> <td>2</td> <td>PZ</td> </tr> <tr> <td>VM1025A0</td> <td>TAPPO NYLON PA66 V2 GRIGIO Ø16</td> <td>2</td> <td>PZ</td> </tr> <tr> <td>VM1059A1</td> <td>FILM TERMORETRA IBILE H800</td> <td>1.350</td> <td>M</td> </tr> <tr> <td>VM1695A0</td> <td>PERNO POSIZIONE MANIGLIA</td> <td>2</td> <td>PZ</td> </tr> <tr> <td>VM1916A0</td> <td>TAPPO COLONNINA SUP DX</td> <td>1</td> <td>PZ</td> </tr> <tr> <td>VM1917A0</td> <td>TAPPO COLONNINA SUP SX</td> <td>1</td> <td>PZ</td> </tr> <tr> <td>VM1918A0</td> <td>TAPPO COLONNINA INF DX</td> <td>1</td> <td>PZ</td> </tr> <tr> <td>VM1919A0</td> <td>TAPPO COLONNINA INF SX</td> <td>1</td> <td>PZ</td> </tr> <tr> <td>VM1920A0</td> <td>PIASTRINA DX CHIUSURA VETRO INT</td> <td>1</td> <td>PZ</td> </tr> <tr> <td>VM1921A0</td> <td>PIASTRINA SX CHIUSURA VETRO INT</td> <td>1</td> <td>PZ</td> </tr> <tr> <td>VT1071A2</td> <td>VETRO ESTERNO SER. GIALLO 798X424X5</td> <td>1</td> <td>PZ</td> </tr> </tbody> </table>	Codice	Descrizione	Qtà	UM	IP1385A1	IMB POL ANGOLARE 110X80X2000 D30	0.960	M	IP1508A0	POLISTIROLO PROFILO AD U 2000X60X60	1.300	PZ	IP1508A1	POLISTIROLO PROFILO AD U 2000X60X60	2	M	RC1200A0	MOLLA A COMPRESSIO NE DE4 DF0.5 H24	2	PZ	SL1050A1	NASTRO BIADESIVO 3M TRANSFER VH	0.820	M	TB2301A0	COLONNINA DX XVC105E 40X40X1	2	PZ	VM1025A0	TAPPO NYLON PA66 V2 GRIGIO Ø16	2	PZ	VM1059A1	FILM TERMORETRA IBILE H800	1.350	M	VM1695A0	PERNO POSIZIONE MANIGLIA	2	PZ	VM1916A0	TAPPO COLONNINA SUP DX	1	PZ	VM1917A0	TAPPO COLONNINA SUP SX	1	PZ	VM1918A0	TAPPO COLONNINA INF DX	1	PZ	VM1919A0	TAPPO COLONNINA INF SX	1	PZ	VM1920A0	PIASTRINA DX CHIUSURA VETRO INT	1	PZ	VM1921A0	PIASTRINA SX CHIUSURA VETRO INT	1	PZ	VT1071A2	VETRO ESTERNO SER. GIALLO 798X424X5	1	PZ
Codice	Descrizione	Qtà	UM																																																																						
IP1385A1	IMB POL ANGOLARE 110X80X2000 D30	0.960	M																																																																						
IP1508A0	POLISTIROLO PROFILO AD U 2000X60X60	1.300	PZ																																																																						
IP1508A1	POLISTIROLO PROFILO AD U 2000X60X60	2	M																																																																						
RC1200A0	MOLLA A COMPRESSIO NE DE4 DF0.5 H24	2	PZ																																																																						
SL1050A1	NASTRO BIADESIVO 3M TRANSFER VH	0.820	M																																																																						
TB2301A0	COLONNINA DX XVC105E 40X40X1	2	PZ																																																																						
VM1025A0	TAPPO NYLON PA66 V2 GRIGIO Ø16	2	PZ																																																																						
VM1059A1	FILM TERMORETRA IBILE H800	1.350	M																																																																						
VM1695A0	PERNO POSIZIONE MANIGLIA	2	PZ																																																																						
VM1916A0	TAPPO COLONNINA SUP DX	1	PZ																																																																						
VM1917A0	TAPPO COLONNINA SUP SX	1	PZ																																																																						
VM1918A0	TAPPO COLONNINA INF DX	1	PZ																																																																						
VM1919A0	TAPPO COLONNINA INF SX	1	PZ																																																																						
VM1920A0	PIASTRINA DX CHIUSURA VETRO INT	1	PZ																																																																						
VM1921A0	PIASTRINA SX CHIUSURA VETRO INT	1	PZ																																																																						
VT1071A2	VETRO ESTERNO SER. GIALLO 798X424X5	1	PZ																																																																						

COMPONENTE			RICAMBIO																																																																										
Codice	Descrizione	Immagine	Codice	Descrizione	Lista componenti																																																																								
VM1920A	PIASTRINA DX CHIUSURA VETRO INT		KVT1067A	KIT VETRO ESTERNO LM ELENA BLACK	<table border="1"> <thead> <tr> <th>Codice</th> <th>Descrizione</th> <th>Qtà</th> <th>UM</th> </tr> </thead> <tbody> <tr> <td>IP1385A1</td> <td>IMB POL ANGOLARE 110X80X2000 D30</td> <td>0.800</td> <td>M</td> </tr> <tr> <td>IP1508A0</td> <td>POLISTIROLO PROFILO AD U 2000X60X60</td> <td>1.710</td> <td>PZ</td> </tr> <tr> <td>IP1508A1</td> <td>POLISTIROLO PROFILO AD U 2000X60X60</td> <td>2</td> <td>M</td> </tr> <tr> <td>RC1200A0</td> <td>MOLLA A COMPRESSIO NE DE4 DF0.5 H24</td> <td>2</td> <td>PZ</td> </tr> <tr> <td>SL1050A1</td> <td>NASTRO BIADESIVO 3M TRANSFER VH</td> <td>0.660</td> <td>M</td> </tr> <tr> <td>TB2306A0</td> <td>COLONNINA DX LM STE-ELE 40X40X1</td> <td>2</td> <td>PZ</td> </tr> <tr> <td>TB3080A0</td> <td>COLONNINA SX LM STE-EL</td> <td>1</td> <td>PZ</td> </tr> <tr> <td>VM1025A0</td> <td>TAPPO NYLON PA66 V2 GRIGIO Ø16</td> <td>2</td> <td>PZ</td> </tr> <tr> <td>VM1059A1</td> <td>FILM TERMORETRA IBILE H800</td> <td>1.350</td> <td>M</td> </tr> <tr> <td>VM1695A0</td> <td>PERNO POSIZIONE MANIGLIA</td> <td>2</td> <td>PZ</td> </tr> <tr> <td>VM1916A0</td> <td>TAPPO COLONNINA SUP DX</td> <td>1</td> <td>PZ</td> </tr> <tr> <td>VM1917A0</td> <td>TAPPO COLONNINA SUP SX</td> <td>1</td> <td>PZ</td> </tr> <tr> <td>VM1918A0</td> <td>TAPPO COLONNINA INF DX</td> <td>1</td> <td>PZ</td> </tr> <tr> <td>VM1919A0</td> <td>TAPPO COLONNINA INF SX</td> <td>1</td> <td>PZ</td> </tr> <tr> <td>VM1920A0</td> <td>PIASTRINA DX CHIUSURA VETRO INT</td> <td>1</td> <td>PZ</td> </tr> <tr> <td>VM1921A0</td> <td>PIASTRINA SX CHIUSURA VETRO INT</td> <td>1</td> <td>PZ</td> </tr> <tr> <td>VT1067A0</td> <td>VETRO ESTERNO GRIGIO 798X344X5 LM ELENA</td> <td>1</td> <td>PZ</td> </tr> </tbody> </table>	Codice	Descrizione	Qtà	UM	IP1385A1	IMB POL ANGOLARE 110X80X2000 D30	0.800	M	IP1508A0	POLISTIROLO PROFILO AD U 2000X60X60	1.710	PZ	IP1508A1	POLISTIROLO PROFILO AD U 2000X60X60	2	M	RC1200A0	MOLLA A COMPRESSIO NE DE4 DF0.5 H24	2	PZ	SL1050A1	NASTRO BIADESIVO 3M TRANSFER VH	0.660	M	TB2306A0	COLONNINA DX LM STE-ELE 40X40X1	2	PZ	TB3080A0	COLONNINA SX LM STE-EL	1	PZ	VM1025A0	TAPPO NYLON PA66 V2 GRIGIO Ø16	2	PZ	VM1059A1	FILM TERMORETRA IBILE H800	1.350	M	VM1695A0	PERNO POSIZIONE MANIGLIA	2	PZ	VM1916A0	TAPPO COLONNINA SUP DX	1	PZ	VM1917A0	TAPPO COLONNINA SUP SX	1	PZ	VM1918A0	TAPPO COLONNINA INF DX	1	PZ	VM1919A0	TAPPO COLONNINA INF SX	1	PZ	VM1920A0	PIASTRINA DX CHIUSURA VETRO INT	1	PZ	VM1921A0	PIASTRINA SX CHIUSURA VETRO INT	1	PZ	VT1067A0	VETRO ESTERNO GRIGIO 798X344X5 LM ELENA	1	PZ
Codice	Descrizione	Qtà	UM																																																																										
IP1385A1	IMB POL ANGOLARE 110X80X2000 D30	0.800	M																																																																										
IP1508A0	POLISTIROLO PROFILO AD U 2000X60X60	1.710	PZ																																																																										
IP1508A1	POLISTIROLO PROFILO AD U 2000X60X60	2	M																																																																										
RC1200A0	MOLLA A COMPRESSIO NE DE4 DF0.5 H24	2	PZ																																																																										
SL1050A1	NASTRO BIADESIVO 3M TRANSFER VH	0.660	M																																																																										
TB2306A0	COLONNINA DX LM STE-ELE 40X40X1	2	PZ																																																																										
TB3080A0	COLONNINA SX LM STE-EL	1	PZ																																																																										
VM1025A0	TAPPO NYLON PA66 V2 GRIGIO Ø16	2	PZ																																																																										
VM1059A1	FILM TERMORETRA IBILE H800	1.350	M																																																																										
VM1695A0	PERNO POSIZIONE MANIGLIA	2	PZ																																																																										
VM1916A0	TAPPO COLONNINA SUP DX	1	PZ																																																																										
VM1917A0	TAPPO COLONNINA SUP SX	1	PZ																																																																										
VM1918A0	TAPPO COLONNINA INF DX	1	PZ																																																																										
VM1919A0	TAPPO COLONNINA INF SX	1	PZ																																																																										
VM1920A0	PIASTRINA DX CHIUSURA VETRO INT	1	PZ																																																																										
VM1921A0	PIASTRINA SX CHIUSURA VETRO INT	1	PZ																																																																										
VT1067A0	VETRO ESTERNO GRIGIO 798X344X5 LM ELENA	1	PZ																																																																										

COMPONENTE			RICAMBIO																																																																						
Codice	Descrizione	Immagine	Codice	Descrizione	Lista componenti																																																																				
VM1920A	PIASTRINA DX CHIUSURA VETRO INT		KVT1066A	KIT VETRO ESTERNO LM ELEN	<table border="1"> <thead> <tr> <th>Codice</th> <th>Descrizione</th> <th>Qtà</th> <th>UM</th> </tr> </thead> <tbody> <tr> <td>IP1385A1</td> <td>IMB POL ANGOLARE 110X80X2000 D30</td> <td>0.800</td> <td>M</td> </tr> <tr> <td>IP1508A0</td> <td>POLISTIROLO PROFILO AD U 2000X60X60</td> <td>1.710</td> <td>PZ</td> </tr> <tr> <td>IP1508A1</td> <td>POLISTIROLO PROFILO AD U 2000X60X60</td> <td>2</td> <td>M</td> </tr> <tr> <td>RC1200A0</td> <td>MOLLA A COMPRESSIO NE DE4 DF0.5 H24</td> <td>2</td> <td>PZ</td> </tr> <tr> <td>SL1050A1</td> <td>NASTRO BIADESIVO 3M TRANSFER VH</td> <td>0.660</td> <td>M</td> </tr> <tr> <td>TB2306A0</td> <td>COLONNINA DX LM STE-ELE 40X40X1</td> <td>2</td> <td>PZ</td> </tr> <tr> <td>VM1025A0</td> <td>TAPPO NYLON PA66 V2 GRIGIO Ø16</td> <td>2</td> <td>PZ</td> </tr> <tr> <td>VM1059A1</td> <td>FILM TERMORETRA IBILE H800</td> <td>1.350</td> <td>M</td> </tr> <tr> <td>VM1695A0</td> <td>PERNO POSIZIONE MANIGLIA</td> <td>2</td> <td>PZ</td> </tr> <tr> <td>VM1916A0</td> <td>TAPPO COLONNINA SUP DX</td> <td>1</td> <td>PZ</td> </tr> <tr> <td>VM1917A0</td> <td>TAPPO COLONNINA SUP SX</td> <td>1</td> <td>PZ</td> </tr> <tr> <td>VM1918A0</td> <td>TAPPO COLONNINA INF DX</td> <td>1</td> <td>PZ</td> </tr> <tr> <td>VM1919A0</td> <td>TAPPO COLONNINA INF SX</td> <td>1</td> <td>PZ</td> </tr> <tr> <td>VM1920A0</td> <td>PIASTRINA DX CHIUSURA VETRO INT</td> <td>1</td> <td>PZ</td> </tr> <tr> <td>VM1921A0</td> <td>PIASTRINA SX CHIUSURA VETRO INT</td> <td>1</td> <td>PZ</td> </tr> <tr> <td>VT1066A2</td> <td>VETRO ESTERNO SER. GIALLO 798X344X5</td> <td>1</td> <td>PZ</td> </tr> </tbody> </table>	Codice	Descrizione	Qtà	UM	IP1385A1	IMB POL ANGOLARE 110X80X2000 D30	0.800	M	IP1508A0	POLISTIROLO PROFILO AD U 2000X60X60	1.710	PZ	IP1508A1	POLISTIROLO PROFILO AD U 2000X60X60	2	M	RC1200A0	MOLLA A COMPRESSIO NE DE4 DF0.5 H24	2	PZ	SL1050A1	NASTRO BIADESIVO 3M TRANSFER VH	0.660	M	TB2306A0	COLONNINA DX LM STE-ELE 40X40X1	2	PZ	VM1025A0	TAPPO NYLON PA66 V2 GRIGIO Ø16	2	PZ	VM1059A1	FILM TERMORETRA IBILE H800	1.350	M	VM1695A0	PERNO POSIZIONE MANIGLIA	2	PZ	VM1916A0	TAPPO COLONNINA SUP DX	1	PZ	VM1917A0	TAPPO COLONNINA SUP SX	1	PZ	VM1918A0	TAPPO COLONNINA INF DX	1	PZ	VM1919A0	TAPPO COLONNINA INF SX	1	PZ	VM1920A0	PIASTRINA DX CHIUSURA VETRO INT	1	PZ	VM1921A0	PIASTRINA SX CHIUSURA VETRO INT	1	PZ	VT1066A2	VETRO ESTERNO SER. GIALLO 798X344X5	1	PZ
Codice	Descrizione	Qtà	UM																																																																						
IP1385A1	IMB POL ANGOLARE 110X80X2000 D30	0.800	M																																																																						
IP1508A0	POLISTIROLO PROFILO AD U 2000X60X60	1.710	PZ																																																																						
IP1508A1	POLISTIROLO PROFILO AD U 2000X60X60	2	M																																																																						
RC1200A0	MOLLA A COMPRESSIO NE DE4 DF0.5 H24	2	PZ																																																																						
SL1050A1	NASTRO BIADESIVO 3M TRANSFER VH	0.660	M																																																																						
TB2306A0	COLONNINA DX LM STE-ELE 40X40X1	2	PZ																																																																						
VM1025A0	TAPPO NYLON PA66 V2 GRIGIO Ø16	2	PZ																																																																						
VM1059A1	FILM TERMORETRA IBILE H800	1.350	M																																																																						
VM1695A0	PERNO POSIZIONE MANIGLIA	2	PZ																																																																						
VM1916A0	TAPPO COLONNINA SUP DX	1	PZ																																																																						
VM1917A0	TAPPO COLONNINA SUP SX	1	PZ																																																																						
VM1918A0	TAPPO COLONNINA INF DX	1	PZ																																																																						
VM1919A0	TAPPO COLONNINA INF SX	1	PZ																																																																						
VM1920A0	PIASTRINA DX CHIUSURA VETRO INT	1	PZ																																																																						
VM1921A0	PIASTRINA SX CHIUSURA VETRO INT	1	PZ																																																																						
VT1066A2	VETRO ESTERNO SER. GIALLO 798X344X5	1	PZ																																																																						

COMPONENTE			RICAMBIO																																																																														
Codice	Descrizione	Immagine	Codice	Descrizione	Lista componenti																																																																												
VM1920A	PIASTRINA DX CHIUSURA VETRO INT		KVT1063A	KIT VETRO ESTERNO LMISS ARIANNA FORNETTI	<table border="1"> <thead> <tr> <th>Codice</th> <th>Descrizione</th> <th>Qtà</th> <th>UM</th> </tr> </thead> <tbody> <tr> <td>IP1385A1</td> <td>IMB POL ANGOLARE 110X80X2000 D30</td> <td>0.980</td> <td>M</td> </tr> <tr> <td>IP1508A0</td> <td>POLISTIROLO PROFILO AD U 2000X60X60</td> <td>0.960</td> <td>PZ</td> </tr> <tr> <td>IP1508A1</td> <td>POLISTIROLO PROFILO AD U 2000X60X60</td> <td>0.960</td> <td>M</td> </tr> <tr> <td>MS1009A0</td> <td>ETICHETTA LOGO FORNETTI</td> <td>1</td> <td>PZ</td> </tr> <tr> <td>RC1200A0</td> <td>MOLLA A COMPRESSIO NE DE4 DF0.5 H24</td> <td>2</td> <td>PZ</td> </tr> <tr> <td>SL1050A1</td> <td>NASTRO BIADESIVO 3M TRANSFER VH</td> <td>0.820</td> <td>M</td> </tr> <tr> <td>TB2301A0</td> <td>COLONNINA DX XVC105E 40X40X1</td> <td>2</td> <td>PZ</td> </tr> <tr> <td>TB3081A0</td> <td>COLONNINA SX LM ARI-RO</td> <td>1</td> <td>PZ</td> </tr> <tr> <td>VM1025A0</td> <td>TAPPO NYLON PA66 V2 GRIGIO Ø16</td> <td>2</td> <td>PZ</td> </tr> <tr> <td>VM1059A1</td> <td>FILM TERMORETRA IBILE H800</td> <td>1.300</td> <td>M</td> </tr> <tr> <td>VM1695A0</td> <td>PERNO POSIZIONE MANIGLIA</td> <td>2</td> <td>PZ</td> </tr> <tr> <td>VM1920A0</td> <td>PIASTRINA DX CHIUSURA VETRO INT</td> <td>1</td> <td>PZ</td> </tr> <tr> <td>VM1921A0</td> <td>PIASTRINA SX CHIUSURA VETRO INT</td> <td>1</td> <td>PZ</td> </tr> <tr> <td>VM2062A0</td> <td>TAPPO COLONNINA LM600 SUP DX</td> <td>1</td> <td>PZ</td> </tr> <tr> <td>VM2063A0</td> <td>TAPPO COLONNINA LM600 SUP SX</td> <td>1</td> <td>PZ</td> </tr> <tr> <td>VM2064A0</td> <td>TAPPO COLONNINA LM600 INF DX</td> <td>1</td> <td>PZ</td> </tr> <tr> <td>VM2065A0</td> <td>TAPPO COLONNINA LM600 INF SX</td> <td>1</td> <td>PZ</td> </tr> <tr> <td>VT1063A0</td> <td>VETRO EST. 598X424 XF135F</td> <td>1</td> <td>PZ</td> </tr> </tbody> </table>	Codice	Descrizione	Qtà	UM	IP1385A1	IMB POL ANGOLARE 110X80X2000 D30	0.980	M	IP1508A0	POLISTIROLO PROFILO AD U 2000X60X60	0.960	PZ	IP1508A1	POLISTIROLO PROFILO AD U 2000X60X60	0.960	M	MS1009A0	ETICHETTA LOGO FORNETTI	1	PZ	RC1200A0	MOLLA A COMPRESSIO NE DE4 DF0.5 H24	2	PZ	SL1050A1	NASTRO BIADESIVO 3M TRANSFER VH	0.820	M	TB2301A0	COLONNINA DX XVC105E 40X40X1	2	PZ	TB3081A0	COLONNINA SX LM ARI-RO	1	PZ	VM1025A0	TAPPO NYLON PA66 V2 GRIGIO Ø16	2	PZ	VM1059A1	FILM TERMORETRA IBILE H800	1.300	M	VM1695A0	PERNO POSIZIONE MANIGLIA	2	PZ	VM1920A0	PIASTRINA DX CHIUSURA VETRO INT	1	PZ	VM1921A0	PIASTRINA SX CHIUSURA VETRO INT	1	PZ	VM2062A0	TAPPO COLONNINA LM600 SUP DX	1	PZ	VM2063A0	TAPPO COLONNINA LM600 SUP SX	1	PZ	VM2064A0	TAPPO COLONNINA LM600 INF DX	1	PZ	VM2065A0	TAPPO COLONNINA LM600 INF SX	1	PZ	VT1063A0	VETRO EST. 598X424 XF135F	1	PZ
Codice	Descrizione	Qtà	UM																																																																														
IP1385A1	IMB POL ANGOLARE 110X80X2000 D30	0.980	M																																																																														
IP1508A0	POLISTIROLO PROFILO AD U 2000X60X60	0.960	PZ																																																																														
IP1508A1	POLISTIROLO PROFILO AD U 2000X60X60	0.960	M																																																																														
MS1009A0	ETICHETTA LOGO FORNETTI	1	PZ																																																																														
RC1200A0	MOLLA A COMPRESSIO NE DE4 DF0.5 H24	2	PZ																																																																														
SL1050A1	NASTRO BIADESIVO 3M TRANSFER VH	0.820	M																																																																														
TB2301A0	COLONNINA DX XVC105E 40X40X1	2	PZ																																																																														
TB3081A0	COLONNINA SX LM ARI-RO	1	PZ																																																																														
VM1025A0	TAPPO NYLON PA66 V2 GRIGIO Ø16	2	PZ																																																																														
VM1059A1	FILM TERMORETRA IBILE H800	1.300	M																																																																														
VM1695A0	PERNO POSIZIONE MANIGLIA	2	PZ																																																																														
VM1920A0	PIASTRINA DX CHIUSURA VETRO INT	1	PZ																																																																														
VM1921A0	PIASTRINA SX CHIUSURA VETRO INT	1	PZ																																																																														
VM2062A0	TAPPO COLONNINA LM600 SUP DX	1	PZ																																																																														
VM2063A0	TAPPO COLONNINA LM600 SUP SX	1	PZ																																																																														
VM2064A0	TAPPO COLONNINA LM600 INF DX	1	PZ																																																																														
VM2065A0	TAPPO COLONNINA LM600 INF SX	1	PZ																																																																														
VT1063A0	VETRO EST. 598X424 XF135F	1	PZ																																																																														

COMPONENTE			RICAMBIO																																																																		
Codice	Descrizione	Immagine	Codice	Descrizione	Lista componenti																																																																
VM1920A	PIASTRINA DX CHIUSURA VETRO INT		KVT1062A	KIT VETRO ESTERNO LM ARIANNA BLACK	<table border="1"> <thead> <tr> <th>Codice</th> <th>Descrizione</th> <th>Qtà</th> <th>UM</th> </tr> </thead> <tbody> <tr> <td>IP1385A1</td> <td>IMB POL ANGOLARE 110X80X2000 D30</td> <td>1.280</td> <td>M</td> </tr> <tr> <td>RC1200A0</td> <td>MOLLA A COMPRESSIO NE DE4 DF0.5 H24</td> <td>2</td> <td>PZ</td> </tr> <tr> <td>SL1050A1</td> <td>NASTRO BIADESIVO 3M TRANSFER VH</td> <td>0.820</td> <td>M</td> </tr> <tr> <td>TB2301A0</td> <td>COLONNINA DX XVC105E 40X40X1</td> <td>2</td> <td>PZ</td> </tr> <tr> <td>TB3081A0</td> <td>COLONNINA SX LM ARI-RO</td> <td>1</td> <td>PZ</td> </tr> <tr> <td>VM1025A0</td> <td>TAPPO NYLON PA66 V2 GRIGIO Ø16</td> <td>2</td> <td>PZ</td> </tr> <tr> <td>VM1059A1</td> <td>FILM TERMORETRA IBILE H800</td> <td>1</td> <td>M</td> </tr> <tr> <td>VM1695A0</td> <td>PERNO POSIZIONE MANIGLIA</td> <td>2</td> <td>PZ</td> </tr> <tr> <td>VM1920A0</td> <td>PIASTRINA DX CHIUSURA VETRO INT</td> <td>1</td> <td>PZ</td> </tr> <tr> <td>VM1921A0</td> <td>PIASTRINA SX CHIUSURA VETRO INT</td> <td>1</td> <td>PZ</td> </tr> <tr> <td>VM2062A0</td> <td>TAPPO COLONNINA LM600 SUP DX</td> <td>1</td> <td>PZ</td> </tr> <tr> <td>VM2063A0</td> <td>TAPPO COLONNINA LM600 SUP SX</td> <td>1</td> <td>PZ</td> </tr> <tr> <td>VM2064A0</td> <td>TAPPO COLONNINA LM600 INF DX</td> <td>1</td> <td>PZ</td> </tr> <tr> <td>VM2065A0</td> <td>TAPPO COLONNINA LM600 INF SX</td> <td>1</td> <td>PZ</td> </tr> <tr> <td>VT1062A0</td> <td>VETRO ESTERNO GRIGIO LINEMISS ARIANNA</td> <td>1</td> <td>PZ</td> </tr> </tbody> </table>	Codice	Descrizione	Qtà	UM	IP1385A1	IMB POL ANGOLARE 110X80X2000 D30	1.280	M	RC1200A0	MOLLA A COMPRESSIO NE DE4 DF0.5 H24	2	PZ	SL1050A1	NASTRO BIADESIVO 3M TRANSFER VH	0.820	M	TB2301A0	COLONNINA DX XVC105E 40X40X1	2	PZ	TB3081A0	COLONNINA SX LM ARI-RO	1	PZ	VM1025A0	TAPPO NYLON PA66 V2 GRIGIO Ø16	2	PZ	VM1059A1	FILM TERMORETRA IBILE H800	1	M	VM1695A0	PERNO POSIZIONE MANIGLIA	2	PZ	VM1920A0	PIASTRINA DX CHIUSURA VETRO INT	1	PZ	VM1921A0	PIASTRINA SX CHIUSURA VETRO INT	1	PZ	VM2062A0	TAPPO COLONNINA LM600 SUP DX	1	PZ	VM2063A0	TAPPO COLONNINA LM600 SUP SX	1	PZ	VM2064A0	TAPPO COLONNINA LM600 INF DX	1	PZ	VM2065A0	TAPPO COLONNINA LM600 INF SX	1	PZ	VT1062A0	VETRO ESTERNO GRIGIO LINEMISS ARIANNA	1	PZ
Codice	Descrizione	Qtà	UM																																																																		
IP1385A1	IMB POL ANGOLARE 110X80X2000 D30	1.280	M																																																																		
RC1200A0	MOLLA A COMPRESSIO NE DE4 DF0.5 H24	2	PZ																																																																		
SL1050A1	NASTRO BIADESIVO 3M TRANSFER VH	0.820	M																																																																		
TB2301A0	COLONNINA DX XVC105E 40X40X1	2	PZ																																																																		
TB3081A0	COLONNINA SX LM ARI-RO	1	PZ																																																																		
VM1025A0	TAPPO NYLON PA66 V2 GRIGIO Ø16	2	PZ																																																																		
VM1059A1	FILM TERMORETRA IBILE H800	1	M																																																																		
VM1695A0	PERNO POSIZIONE MANIGLIA	2	PZ																																																																		
VM1920A0	PIASTRINA DX CHIUSURA VETRO INT	1	PZ																																																																		
VM1921A0	PIASTRINA SX CHIUSURA VETRO INT	1	PZ																																																																		
VM2062A0	TAPPO COLONNINA LM600 SUP DX	1	PZ																																																																		
VM2063A0	TAPPO COLONNINA LM600 SUP SX	1	PZ																																																																		
VM2064A0	TAPPO COLONNINA LM600 INF DX	1	PZ																																																																		
VM2065A0	TAPPO COLONNINA LM600 INF SX	1	PZ																																																																		
VT1062A0	VETRO ESTERNO GRIGIO LINEMISS ARIANNA	1	PZ																																																																		
			KVT1061A	KIT VETRO ESTERNO LM ARIANNA	<table border="1"> <thead> <tr> <th>Codice</th> <th>Descrizione</th> <th>Qtà</th> <th>UM</th> </tr> </thead> <tbody> <tr> <td>IP1385A1</td> <td>IMB POL ANGOLARE 110X80X2000 D30</td> <td>1.280</td> <td>M</td> </tr> </tbody> </table>	Codice	Descrizione	Qtà	UM	IP1385A1	IMB POL ANGOLARE 110X80X2000 D30	1.280	M																																																								
Codice	Descrizione	Qtà	UM																																																																		
IP1385A1	IMB POL ANGOLARE 110X80X2000 D30	1.280	M																																																																		

COMPONENTE			RICAMBIO																																																										
Codice	Descrizione	Immagine	Codice	Descrizione	Lista componenti																																																								
VM1920A	PIASTRINA DX CHIUSURA VETRO INT		KVT1061A	KIT VETRO ESTERNO LM ARIANNA	<table border="1"> <thead> <tr> <th>Codice</th> <th>Descrizione</th> <th>Qtà</th> <th>UM</th> </tr> </thead> <tbody> <tr> <td>RC1200A0</td> <td>MOLLA A COMPRESSIO NE DE4 DF0.5 H24</td> <td>2</td> <td>PZ</td> </tr> <tr> <td>SL1050A1</td> <td>NASTRO BIADESIVO 3M TRANSFER VH</td> <td>0.820</td> <td>M</td> </tr> <tr> <td>TB2301A0</td> <td>COLONNINA DX XVC105E 40X40X1</td> <td>2</td> <td>PZ</td> </tr> <tr> <td>VM1025A0</td> <td>TAPPO NYLON PA66 V2 GRIGIO Ø16</td> <td>2</td> <td>PZ</td> </tr> <tr> <td>VM1059A1</td> <td>FILM TERMORETRA IBILE H800</td> <td>1.300</td> <td>M</td> </tr> <tr> <td>VM1695A0</td> <td>PERNO POSIZIONE MANIGLIA</td> <td>2</td> <td>PZ</td> </tr> <tr> <td>VM1920A0</td> <td>PIASTRINA DX CHIUSURA VETRO INT</td> <td>1</td> <td>PZ</td> </tr> <tr> <td>VM1921A0</td> <td>PIASTRINA SX CHIUSURA VETRO INT</td> <td>1</td> <td>PZ</td> </tr> <tr> <td>VM2062A0</td> <td>TAPPO COLONNINA LM600 SUP DX</td> <td>1</td> <td>PZ</td> </tr> <tr> <td>VM2063A0</td> <td>TAPPO COLONNINA LM600 SUP SX</td> <td>1</td> <td>PZ</td> </tr> <tr> <td>VM2064A0</td> <td>TAPPO COLONNINA LM600 INF DX</td> <td>1</td> <td>PZ</td> </tr> <tr> <td>VM2065A0</td> <td>TAPPO COLONNINA LM600 INF SX</td> <td>1</td> <td>PZ</td> </tr> <tr> <td>VT1061A2</td> <td>VETRO ESTERNO SER. GIALLO 598X424X5</td> <td>1</td> <td>PZ</td> </tr> </tbody> </table>	Codice	Descrizione	Qtà	UM	RC1200A0	MOLLA A COMPRESSIO NE DE4 DF0.5 H24	2	PZ	SL1050A1	NASTRO BIADESIVO 3M TRANSFER VH	0.820	M	TB2301A0	COLONNINA DX XVC105E 40X40X1	2	PZ	VM1025A0	TAPPO NYLON PA66 V2 GRIGIO Ø16	2	PZ	VM1059A1	FILM TERMORETRA IBILE H800	1.300	M	VM1695A0	PERNO POSIZIONE MANIGLIA	2	PZ	VM1920A0	PIASTRINA DX CHIUSURA VETRO INT	1	PZ	VM1921A0	PIASTRINA SX CHIUSURA VETRO INT	1	PZ	VM2062A0	TAPPO COLONNINA LM600 SUP DX	1	PZ	VM2063A0	TAPPO COLONNINA LM600 SUP SX	1	PZ	VM2064A0	TAPPO COLONNINA LM600 INF DX	1	PZ	VM2065A0	TAPPO COLONNINA LM600 INF SX	1	PZ	VT1061A2	VETRO ESTERNO SER. GIALLO 598X424X5	1	PZ
Codice	Descrizione	Qtà	UM																																																										
RC1200A0	MOLLA A COMPRESSIO NE DE4 DF0.5 H24	2	PZ																																																										
SL1050A1	NASTRO BIADESIVO 3M TRANSFER VH	0.820	M																																																										
TB2301A0	COLONNINA DX XVC105E 40X40X1	2	PZ																																																										
VM1025A0	TAPPO NYLON PA66 V2 GRIGIO Ø16	2	PZ																																																										
VM1059A1	FILM TERMORETRA IBILE H800	1.300	M																																																										
VM1695A0	PERNO POSIZIONE MANIGLIA	2	PZ																																																										
VM1920A0	PIASTRINA DX CHIUSURA VETRO INT	1	PZ																																																										
VM1921A0	PIASTRINA SX CHIUSURA VETRO INT	1	PZ																																																										
VM2062A0	TAPPO COLONNINA LM600 SUP DX	1	PZ																																																										
VM2063A0	TAPPO COLONNINA LM600 SUP SX	1	PZ																																																										
VM2064A0	TAPPO COLONNINA LM600 INF DX	1	PZ																																																										
VM2065A0	TAPPO COLONNINA LM600 INF SX	1	PZ																																																										
VT1061A2	VETRO ESTERNO SER. GIALLO 598X424X5	1	PZ																																																										
			KVT1057A	KIT VETRO ESTERNO NERO LMISS STEFANIA	<table border="1"> <thead> <tr> <th>Codice</th> <th>Descrizione</th> <th>Qtà</th> <th>UM</th> </tr> </thead> <tbody> <tr> <td>IP1385A1</td> <td>IMB POL ANGOLARE 110X80X2000 D30</td> <td>0.810</td> <td>M</td> </tr> <tr> <td>IP1508A0</td> <td>POLISTIROLO PROFILO AD U 2000X60X60</td> <td>0.950</td> <td>PZ</td> </tr> <tr> <td>IP1508A1</td> <td>POLISTIROLO PROFILO AD U 2000X60X60</td> <td>0.960</td> <td>M</td> </tr> </tbody> </table>	Codice	Descrizione	Qtà	UM	IP1385A1	IMB POL ANGOLARE 110X80X2000 D30	0.810	M	IP1508A0	POLISTIROLO PROFILO AD U 2000X60X60	0.950	PZ	IP1508A1	POLISTIROLO PROFILO AD U 2000X60X60	0.960	M																																								
Codice	Descrizione	Qtà	UM																																																										
IP1385A1	IMB POL ANGOLARE 110X80X2000 D30	0.810	M																																																										
IP1508A0	POLISTIROLO PROFILO AD U 2000X60X60	0.950	PZ																																																										
IP1508A1	POLISTIROLO PROFILO AD U 2000X60X60	0.960	M																																																										

COMPONENTE			RICAMBIO																																																																													
Codice	Descrizione	Immagine	Codice	Descrizione	Lista componenti																																																																											
VM1920A	PIASTRINA DX CHIUSURA VETRO INT		KVT1057A	KIT VETRO ESTERNO NERO LMISS STEFANIA	<table border="1"> <thead> <tr> <th>Codice</th> <th>Descrizione</th> <th>Qtà</th> <th>UM</th> </tr> </thead> <tbody> <tr> <td>RC1200A0</td> <td>MOLLA A COMPRESSIO NE DE4 DF0.5 H24</td> <td>2</td> <td>PZ</td> </tr> <tr> <td>SL1050A1</td> <td>NASTRO BIADESIVO 3M TRANSFER VH</td> <td>0.660</td> <td>M</td> </tr> <tr> <td>TB2306A0</td> <td>COLONNINA DX LM STE-ELE 40X40X1</td> <td>2</td> <td>PZ</td> </tr> <tr> <td>TB3080A0</td> <td>COLONNINA SX LM STE-EL</td> <td>1</td> <td>PZ</td> </tr> <tr> <td>VM1025A0</td> <td>TAPPO NYLON PA66 V2 GRIGIO Ø16</td> <td>2</td> <td>PZ</td> </tr> <tr> <td>VM1059A1</td> <td>FILM TERMORETRA IBILE H800</td> <td>1</td> <td>M</td> </tr> <tr> <td>VM1695A0</td> <td>PERNO POSIZIONE MANIGLIA</td> <td>2</td> <td>PZ</td> </tr> <tr> <td>VM1920A0</td> <td>PIASTRINA DX CHIUSURA VETRO INT</td> <td>1</td> <td>PZ</td> </tr> <tr> <td>VM1921A0</td> <td>PIASTRINA SX CHIUSURA VETRO INT</td> <td>1</td> <td>PZ</td> </tr> <tr> <td>VM2062A0</td> <td>TAPPO COLONNINA LM600 SUP DX</td> <td>1</td> <td>PZ</td> </tr> <tr> <td>VM2063A0</td> <td>TAPPO COLONNINA LM600 SUP SX</td> <td>1</td> <td>PZ</td> </tr> <tr> <td>VM2064A0</td> <td>TAPPO COLONNINA LM600 INF DX</td> <td>1</td> <td>PZ</td> </tr> <tr> <td>VM2065A0</td> <td>TAPPO COLONNINA LM600 INF SX</td> <td>1</td> <td>PZ</td> </tr> <tr> <td>VT1057A0</td> <td>VETRO ESTERNO SER. GRIGIO 598X344X5</td> <td>1</td> <td>PZ</td> </tr> </tbody> </table>	Codice	Descrizione	Qtà	UM	RC1200A0	MOLLA A COMPRESSIO NE DE4 DF0.5 H24	2	PZ	SL1050A1	NASTRO BIADESIVO 3M TRANSFER VH	0.660	M	TB2306A0	COLONNINA DX LM STE-ELE 40X40X1	2	PZ	TB3080A0	COLONNINA SX LM STE-EL	1	PZ	VM1025A0	TAPPO NYLON PA66 V2 GRIGIO Ø16	2	PZ	VM1059A1	FILM TERMORETRA IBILE H800	1	M	VM1695A0	PERNO POSIZIONE MANIGLIA	2	PZ	VM1920A0	PIASTRINA DX CHIUSURA VETRO INT	1	PZ	VM1921A0	PIASTRINA SX CHIUSURA VETRO INT	1	PZ	VM2062A0	TAPPO COLONNINA LM600 SUP DX	1	PZ	VM2063A0	TAPPO COLONNINA LM600 SUP SX	1	PZ	VM2064A0	TAPPO COLONNINA LM600 INF DX	1	PZ	VM2065A0	TAPPO COLONNINA LM600 INF SX	1	PZ	VT1057A0	VETRO ESTERNO SER. GRIGIO 598X344X5	1	PZ	KVT1056A	KIT VETRO ESTERNO GIALLO LMISS STEFANIA	<table border="1"> <thead> <tr> <th>Codice</th> <th>Descrizione</th> <th>Qtà</th> <th>UM</th> </tr> </thead> <tbody> <tr> <td>IP1385A1</td> <td>IMB POL ANGOLARE 110X80X2000 D30</td> <td>0.980</td> <td>M</td> </tr> <tr> <td>IP1508A0</td> <td>POLISTIROLO PROFILO AD U 2000X60X60</td> <td>0.960</td> <td>PZ</td> </tr> </tbody> </table>	Codice	Descrizione	Qtà	UM	IP1385A1	IMB POL ANGOLARE 110X80X2000 D30	0.980	M	IP1508A0	POLISTIROLO PROFILO AD U 2000X60X60	0.960	PZ
			Codice	Descrizione	Qtà	UM																																																																										
RC1200A0	MOLLA A COMPRESSIO NE DE4 DF0.5 H24	2	PZ																																																																													
SL1050A1	NASTRO BIADESIVO 3M TRANSFER VH	0.660	M																																																																													
TB2306A0	COLONNINA DX LM STE-ELE 40X40X1	2	PZ																																																																													
TB3080A0	COLONNINA SX LM STE-EL	1	PZ																																																																													
VM1025A0	TAPPO NYLON PA66 V2 GRIGIO Ø16	2	PZ																																																																													
VM1059A1	FILM TERMORETRA IBILE H800	1	M																																																																													
VM1695A0	PERNO POSIZIONE MANIGLIA	2	PZ																																																																													
VM1920A0	PIASTRINA DX CHIUSURA VETRO INT	1	PZ																																																																													
VM1921A0	PIASTRINA SX CHIUSURA VETRO INT	1	PZ																																																																													
VM2062A0	TAPPO COLONNINA LM600 SUP DX	1	PZ																																																																													
VM2063A0	TAPPO COLONNINA LM600 SUP SX	1	PZ																																																																													
VM2064A0	TAPPO COLONNINA LM600 INF DX	1	PZ																																																																													
VM2065A0	TAPPO COLONNINA LM600 INF SX	1	PZ																																																																													
VT1057A0	VETRO ESTERNO SER. GRIGIO 598X344X5	1	PZ																																																																													
Codice	Descrizione	Qtà	UM																																																																													
IP1385A1	IMB POL ANGOLARE 110X80X2000 D30	0.980	M																																																																													
IP1508A0	POLISTIROLO PROFILO AD U 2000X60X60	0.960	PZ																																																																													

COMPONENTE			RICAMBIO																																																														
Codice	Descrizione	Immagine	Codice	Descrizione	Lista componenti																																																												
VM1920A	PIASTRINA DX CHIUSURA VETRO INT		KVT1056A	KIT VETRO ESTERNO GIALLO LMISS STEFANIA	<table border="1"> <thead> <tr> <th>Codice</th> <th>Descrizione</th> <th>Qtà</th> <th>UM</th> </tr> </thead> <tbody> <tr> <td>IP1508A1</td> <td>POLISTIROLO PROFILO AD U 2000X60X60</td> <td>0.960</td> <td>M</td> </tr> <tr> <td>RC1200A0</td> <td>MOLLA A COMPRESSIO NE DE4 DF0.5 H24</td> <td>2</td> <td>PZ</td> </tr> <tr> <td>SL1050A1</td> <td>NASTRO BIADESIVO 3M TRANSFER VH</td> <td>0.660</td> <td>M</td> </tr> <tr> <td>TB2306A0</td> <td>COLONNINA DX LM STE-ELE 40X40X1</td> <td>2</td> <td>PZ</td> </tr> <tr> <td>VM1025A0</td> <td>TAPPO NYLON PA66 V2 GRIGIO Ø16</td> <td>2</td> <td>PZ</td> </tr> <tr> <td>VM1059A1</td> <td>FILM TERMORETRA IBILE H800</td> <td>1.300</td> <td>M</td> </tr> <tr> <td>VM1695A0</td> <td>PERNO POSIZIONE MANIGLIA</td> <td>2</td> <td>PZ</td> </tr> <tr> <td>VM1920A0</td> <td>PIASTRINA DX CHIUSURA VETRO INT</td> <td>1</td> <td>PZ</td> </tr> <tr> <td>VM1921A0</td> <td>PIASTRINA SX CHIUSURA VETRO INT</td> <td>1</td> <td>PZ</td> </tr> <tr> <td>VM2062A0</td> <td>TAPPO COLONNINA LM600 SUP DX</td> <td>1</td> <td>PZ</td> </tr> <tr> <td>VM2063A0</td> <td>TAPPO COLONNINA LM600 SUP SX</td> <td>1</td> <td>PZ</td> </tr> <tr> <td>VM2064A0</td> <td>TAPPO COLONNINA LM600 INF DX</td> <td>1</td> <td>PZ</td> </tr> <tr> <td>VM2065A0</td> <td>TAPPO COLONNINA LM600 INF SX</td> <td>1</td> <td>PZ</td> </tr> <tr> <td>VT1056A2</td> <td>VETRO ESTERNO SER. GIALLO 598X344X5</td> <td>1</td> <td>PZ</td> </tr> </tbody> </table>	Codice	Descrizione	Qtà	UM	IP1508A1	POLISTIROLO PROFILO AD U 2000X60X60	0.960	M	RC1200A0	MOLLA A COMPRESSIO NE DE4 DF0.5 H24	2	PZ	SL1050A1	NASTRO BIADESIVO 3M TRANSFER VH	0.660	M	TB2306A0	COLONNINA DX LM STE-ELE 40X40X1	2	PZ	VM1025A0	TAPPO NYLON PA66 V2 GRIGIO Ø16	2	PZ	VM1059A1	FILM TERMORETRA IBILE H800	1.300	M	VM1695A0	PERNO POSIZIONE MANIGLIA	2	PZ	VM1920A0	PIASTRINA DX CHIUSURA VETRO INT	1	PZ	VM1921A0	PIASTRINA SX CHIUSURA VETRO INT	1	PZ	VM2062A0	TAPPO COLONNINA LM600 SUP DX	1	PZ	VM2063A0	TAPPO COLONNINA LM600 SUP SX	1	PZ	VM2064A0	TAPPO COLONNINA LM600 INF DX	1	PZ	VM2065A0	TAPPO COLONNINA LM600 INF SX	1	PZ	VT1056A2	VETRO ESTERNO SER. GIALLO 598X344X5	1	PZ
Codice	Descrizione	Qtà	UM																																																														
IP1508A1	POLISTIROLO PROFILO AD U 2000X60X60	0.960	M																																																														
RC1200A0	MOLLA A COMPRESSIO NE DE4 DF0.5 H24	2	PZ																																																														
SL1050A1	NASTRO BIADESIVO 3M TRANSFER VH	0.660	M																																																														
TB2306A0	COLONNINA DX LM STE-ELE 40X40X1	2	PZ																																																														
VM1025A0	TAPPO NYLON PA66 V2 GRIGIO Ø16	2	PZ																																																														
VM1059A1	FILM TERMORETRA IBILE H800	1.300	M																																																														
VM1695A0	PERNO POSIZIONE MANIGLIA	2	PZ																																																														
VM1920A0	PIASTRINA DX CHIUSURA VETRO INT	1	PZ																																																														
VM1921A0	PIASTRINA SX CHIUSURA VETRO INT	1	PZ																																																														
VM2062A0	TAPPO COLONNINA LM600 SUP DX	1	PZ																																																														
VM2063A0	TAPPO COLONNINA LM600 SUP SX	1	PZ																																																														
VM2064A0	TAPPO COLONNINA LM600 INF DX	1	PZ																																																														
VM2065A0	TAPPO COLONNINA LM600 INF SX	1	PZ																																																														
VT1056A2	VETRO ESTERNO SER. GIALLO 598X344X5	1	PZ																																																														
			KVT1052A	KIT VETRO ESTERNO NERO LINEMISS CRISTINA	<table border="1"> <thead> <tr> <th>Codice</th> <th>Descrizione</th> <th>Qtà</th> <th>UM</th> </tr> </thead> <tbody> <tr> <td>RC1200A0</td> <td>MOLLA A COMPRESSIO NE DE4 DF0.5 H24</td> <td>2</td> <td>PZ</td> </tr> <tr> <td>SL1050A1</td> <td>NASTRO BIADESIVO 3M TRANSFER VH</td> <td>0.660</td> <td>M</td> </tr> </tbody> </table>	Codice	Descrizione	Qtà	UM	RC1200A0	MOLLA A COMPRESSIO NE DE4 DF0.5 H24	2	PZ	SL1050A1	NASTRO BIADESIVO 3M TRANSFER VH	0.660	M																																																
Codice	Descrizione	Qtà	UM																																																														
RC1200A0	MOLLA A COMPRESSIO NE DE4 DF0.5 H24	2	PZ																																																														
SL1050A1	NASTRO BIADESIVO 3M TRANSFER VH	0.660	M																																																														

COMPONENTE			RICAMBIO																																														
Codice	Descrizione	Immagine	Codice	Descrizione	Lista componenti																																												
VM1920A	PIASTRINA DX CHIUSURA VETRO INT		KVT1052A	KIT VETRO ESTERNO NERO LINEMISS CRISTINA	<table border="1"> <thead> <tr> <th>Codice</th> <th>Descrizione</th> <th>Qtà</th> <th>UM</th> </tr> </thead> <tbody> <tr> <td>TB2306A0</td> <td>COLONNINA DX LM STE-ELE 40X40X1</td> <td>2</td> <td>PZ</td> </tr> <tr> <td>VM1025A0</td> <td>TAPPO NYLON PA66 V2 GRIGIO Ø16</td> <td>2</td> <td>PZ</td> </tr> <tr> <td>VM1695A0</td> <td>PERNO POSIZIONE MANIGLIA</td> <td>2</td> <td>PZ</td> </tr> <tr> <td>VM1920A0</td> <td>PIASTRINA DX CHIUSURA VETRO INT</td> <td>1</td> <td>PZ</td> </tr> <tr> <td>VM1921A0</td> <td>PIASTRINA SX CHIUSURA VETRO INT</td> <td>1</td> <td>PZ</td> </tr> <tr> <td>VM2062A0</td> <td>TAPPO COLONNINA LM600 SUP DX</td> <td>1</td> <td>PZ</td> </tr> <tr> <td>VM2063A0</td> <td>TAPPO COLONNINA LM600 SUP SX</td> <td>1</td> <td>PZ</td> </tr> <tr> <td>VM2064A0</td> <td>TAPPO COLONNINA LM600 INF DX</td> <td>1</td> <td>PZ</td> </tr> <tr> <td>VM2065A0</td> <td>TAPPO COLONNINA LM600 INF SX</td> <td>1</td> <td>PZ</td> </tr> <tr> <td>VT1052A0</td> <td>VETRO ESTERNO SER. GRIGIO 478X344X5</td> <td>1</td> <td>PZ</td> </tr> </tbody> </table>	Codice	Descrizione	Qtà	UM	TB2306A0	COLONNINA DX LM STE-ELE 40X40X1	2	PZ	VM1025A0	TAPPO NYLON PA66 V2 GRIGIO Ø16	2	PZ	VM1695A0	PERNO POSIZIONE MANIGLIA	2	PZ	VM1920A0	PIASTRINA DX CHIUSURA VETRO INT	1	PZ	VM1921A0	PIASTRINA SX CHIUSURA VETRO INT	1	PZ	VM2062A0	TAPPO COLONNINA LM600 SUP DX	1	PZ	VM2063A0	TAPPO COLONNINA LM600 SUP SX	1	PZ	VM2064A0	TAPPO COLONNINA LM600 INF DX	1	PZ	VM2065A0	TAPPO COLONNINA LM600 INF SX	1	PZ	VT1052A0	VETRO ESTERNO SER. GRIGIO 478X344X5	1	PZ
			Codice	Descrizione	Qtà	UM																																											
TB2306A0	COLONNINA DX LM STE-ELE 40X40X1	2	PZ																																														
VM1025A0	TAPPO NYLON PA66 V2 GRIGIO Ø16	2	PZ																																														
VM1695A0	PERNO POSIZIONE MANIGLIA	2	PZ																																														
VM1920A0	PIASTRINA DX CHIUSURA VETRO INT	1	PZ																																														
VM1921A0	PIASTRINA SX CHIUSURA VETRO INT	1	PZ																																														
VM2062A0	TAPPO COLONNINA LM600 SUP DX	1	PZ																																														
VM2063A0	TAPPO COLONNINA LM600 SUP SX	1	PZ																																														
VM2064A0	TAPPO COLONNINA LM600 INF DX	1	PZ																																														
VM2065A0	TAPPO COLONNINA LM600 INF SX	1	PZ																																														
VT1052A0	VETRO ESTERNO SER. GRIGIO 478X344X5	1	PZ																																														
KVT1051A	KIT VETRO ESTERNO GIALLO L.MISS CRISTINA	<table border="1"> <thead> <tr> <th>Codice</th> <th>Descrizione</th> <th>Qtà</th> <th>UM</th> </tr> </thead> <tbody> <tr> <td>IP1385A1</td> <td>IMB POL ANGOLARE 110X80X2000 D30</td> <td>1.040</td> <td>M</td> </tr> <tr> <td>RC1200A0</td> <td>MOLLA A COMPRESSIO NE DE4 DF0.5 H24</td> <td>2</td> <td>PZ</td> </tr> <tr> <td>SL1050A1</td> <td>NASTRO BIADESIVO 3M TRANSFER VH</td> <td>0.660</td> <td>M</td> </tr> <tr> <td>TB2306A0</td> <td>COLONNINA DX LM STE-ELE 40X40X1</td> <td>2</td> <td>PZ</td> </tr> <tr> <td>VM1025A0</td> <td>TAPPO NYLON PA66 V2 GRIGIO Ø16</td> <td>2</td> <td>PZ</td> </tr> <tr> <td>VM1059A1</td> <td>FILM TERMORETRA IBILE H800</td> <td>1.500</td> <td>M</td> </tr> </tbody> </table>	Codice	Descrizione	Qtà	UM	IP1385A1	IMB POL ANGOLARE 110X80X2000 D30	1.040	M	RC1200A0	MOLLA A COMPRESSIO NE DE4 DF0.5 H24	2	PZ	SL1050A1	NASTRO BIADESIVO 3M TRANSFER VH	0.660	M	TB2306A0	COLONNINA DX LM STE-ELE 40X40X1	2	PZ	VM1025A0	TAPPO NYLON PA66 V2 GRIGIO Ø16	2	PZ	VM1059A1	FILM TERMORETRA IBILE H800	1.500	M																			
Codice	Descrizione	Qtà	UM																																														
IP1385A1	IMB POL ANGOLARE 110X80X2000 D30	1.040	M																																														
RC1200A0	MOLLA A COMPRESSIO NE DE4 DF0.5 H24	2	PZ																																														
SL1050A1	NASTRO BIADESIVO 3M TRANSFER VH	0.660	M																																														
TB2306A0	COLONNINA DX LM STE-ELE 40X40X1	2	PZ																																														
VM1025A0	TAPPO NYLON PA66 V2 GRIGIO Ø16	2	PZ																																														
VM1059A1	FILM TERMORETRA IBILE H800	1.500	M																																														

COMPONENTE			RICAMBIO																																										
Codice	Descrizione	Immagine	Codice	Descrizione	Lista componenti																																								
VM1920A	PIASTRINA DX CHIUSURA VETRO INT		KVT1051A	KIT VETRO ESTERNO GIALLO L.MISS CRISTINA	<table border="1"> <thead> <tr> <th>Codice</th> <th>Descrizione</th> <th>Qtà</th> <th>UM</th> </tr> </thead> <tbody> <tr> <td>VM1695A0</td> <td>PERNO POSIZIONE MANIGLIA</td> <td>2</td> <td>PZ</td> </tr> <tr> <td>VM1920A0</td> <td>PIASTRINA DX CHIUSURA VETRO INT</td> <td>1</td> <td>PZ</td> </tr> <tr> <td>VM1921A0</td> <td>PIASTRINA SX CHIUSURA VETRO INT</td> <td>1</td> <td>PZ</td> </tr> <tr> <td>VM2062A0</td> <td>TAPPO COLONNINA LM600 SUP DX</td> <td>1</td> <td>PZ</td> </tr> <tr> <td>VM2063A0</td> <td>TAPPO COLONNINA LM600 SUP SX</td> <td>1</td> <td>PZ</td> </tr> <tr> <td>VM2064A0</td> <td>TAPPO COLONNINA LM600 INF DX</td> <td>1</td> <td>PZ</td> </tr> <tr> <td>VM2065A0</td> <td>TAPPO COLONNINA LM600 INF SX</td> <td>1</td> <td>PZ</td> </tr> <tr> <td>VT1051A2</td> <td>VETRO ESTERNO SER. GIALLO 478X344X5</td> <td>1</td> <td>PZ</td> </tr> </tbody> </table>	Codice	Descrizione	Qtà	UM	VM1695A0	PERNO POSIZIONE MANIGLIA	2	PZ	VM1920A0	PIASTRINA DX CHIUSURA VETRO INT	1	PZ	VM1921A0	PIASTRINA SX CHIUSURA VETRO INT	1	PZ	VM2062A0	TAPPO COLONNINA LM600 SUP DX	1	PZ	VM2063A0	TAPPO COLONNINA LM600 SUP SX	1	PZ	VM2064A0	TAPPO COLONNINA LM600 INF DX	1	PZ	VM2065A0	TAPPO COLONNINA LM600 INF SX	1	PZ	VT1051A2	VETRO ESTERNO SER. GIALLO 478X344X5	1	PZ				
Codice	Descrizione	Qtà	UM																																										
VM1695A0	PERNO POSIZIONE MANIGLIA	2	PZ																																										
VM1920A0	PIASTRINA DX CHIUSURA VETRO INT	1	PZ																																										
VM1921A0	PIASTRINA SX CHIUSURA VETRO INT	1	PZ																																										
VM2062A0	TAPPO COLONNINA LM600 SUP DX	1	PZ																																										
VM2063A0	TAPPO COLONNINA LM600 SUP SX	1	PZ																																										
VM2064A0	TAPPO COLONNINA LM600 INF DX	1	PZ																																										
VM2065A0	TAPPO COLONNINA LM600 INF SX	1	PZ																																										
VT1051A2	VETRO ESTERNO SER. GIALLO 478X344X5	1	PZ																																										
VM2062A	TAPPO COLONNINA LM600 SUP DX		KVT1252A	KIT VETRO ESTERNO XF135-EG VT1252A	<table border="1"> <thead> <tr> <th>Codice</th> <th>Descrizione</th> <th>Qtà</th> <th>UM</th> </tr> </thead> <tbody> <tr> <td>RC1200A0</td> <td>MOLLA A COMPRESSIO NE DE4 DF0.5 H24</td> <td>2</td> <td>PZ</td> </tr> <tr> <td>SL1050A1</td> <td>NASTRO BIADESIVO 3M TRANSFER VH</td> <td>0.820</td> <td>M</td> </tr> <tr> <td>TB2301A0</td> <td>COLONNINA DX XVC105E 40X40X1</td> <td>2</td> <td>PZ</td> </tr> <tr> <td>TB3081A0</td> <td>COLONNINA SX LM ARI-RO</td> <td>1</td> <td>PZ</td> </tr> <tr> <td>VM1025A0</td> <td>TAPPO NYLON PA66 V2 GRIGIO Ø16</td> <td>2</td> <td>PZ</td> </tr> <tr> <td>VM1695A0</td> <td>PERNO POSIZIONE MANIGLIA</td> <td>2</td> <td>PZ</td> </tr> <tr> <td>VM1920A0</td> <td>PIASTRINA DX CHIUSURA VETRO INT</td> <td>1</td> <td>PZ</td> </tr> <tr> <td>VM1921A0</td> <td>PIASTRINA SX CHIUSURA VETRO INT</td> <td>1</td> <td>PZ</td> </tr> <tr> <td>VM2062A0</td> <td>TAPPO COLONNINA LM600 SUP DX</td> <td>1</td> <td>PZ</td> </tr> </tbody> </table>	Codice	Descrizione	Qtà	UM	RC1200A0	MOLLA A COMPRESSIO NE DE4 DF0.5 H24	2	PZ	SL1050A1	NASTRO BIADESIVO 3M TRANSFER VH	0.820	M	TB2301A0	COLONNINA DX XVC105E 40X40X1	2	PZ	TB3081A0	COLONNINA SX LM ARI-RO	1	PZ	VM1025A0	TAPPO NYLON PA66 V2 GRIGIO Ø16	2	PZ	VM1695A0	PERNO POSIZIONE MANIGLIA	2	PZ	VM1920A0	PIASTRINA DX CHIUSURA VETRO INT	1	PZ	VM1921A0	PIASTRINA SX CHIUSURA VETRO INT	1	PZ	VM2062A0	TAPPO COLONNINA LM600 SUP DX	1	PZ
Codice	Descrizione	Qtà	UM																																										
RC1200A0	MOLLA A COMPRESSIO NE DE4 DF0.5 H24	2	PZ																																										
SL1050A1	NASTRO BIADESIVO 3M TRANSFER VH	0.820	M																																										
TB2301A0	COLONNINA DX XVC105E 40X40X1	2	PZ																																										
TB3081A0	COLONNINA SX LM ARI-RO	1	PZ																																										
VM1025A0	TAPPO NYLON PA66 V2 GRIGIO Ø16	2	PZ																																										
VM1695A0	PERNO POSIZIONE MANIGLIA	2	PZ																																										
VM1920A0	PIASTRINA DX CHIUSURA VETRO INT	1	PZ																																										
VM1921A0	PIASTRINA SX CHIUSURA VETRO INT	1	PZ																																										
VM2062A0	TAPPO COLONNINA LM600 SUP DX	1	PZ																																										

COMPONENTE			RICAMBIO																																																							
Codice	Descrizione	Immagine	Codice	Descrizione	Lista componenti																																																					
VM2062A	TAPPO COLONNINA LM600 SUP DX		KVT1252A	KIT VETRO ESTERNO XF135-EG VT1252A	<table border="1"> <thead> <tr> <th>Codice</th> <th>Descrizione</th> <th>Qtà</th> <th>UM</th> </tr> </thead> <tbody> <tr> <td>VM2063A0</td> <td>TAPPO COLONNINA LM600 SUP SX</td> <td>1</td> <td>PZ</td> </tr> <tr> <td>VM2064A0</td> <td>TAPPO COLONNINA LM600 INF DX</td> <td>1</td> <td>PZ</td> </tr> <tr> <td>VM2065A0</td> <td>TAPPO COLONNINA LM600 INF SX</td> <td>1</td> <td>PZ</td> </tr> <tr> <td>VT1252A0</td> <td>VETRO EST.XF135 NERO ENGEFOOD</td> <td>1</td> <td>PZ</td> </tr> </tbody> </table>	Codice	Descrizione	Qtà	UM	VM2063A0	TAPPO COLONNINA LM600 SUP SX	1	PZ	VM2064A0	TAPPO COLONNINA LM600 INF DX	1	PZ	VM2065A0	TAPPO COLONNINA LM600 INF SX	1	PZ	VT1252A0	VETRO EST.XF135 NERO ENGEFOOD	1	PZ																																	
			Codice	Descrizione	Qtà	UM																																																				
VM2063A0	TAPPO COLONNINA LM600 SUP SX	1	PZ																																																							
VM2064A0	TAPPO COLONNINA LM600 INF DX	1	PZ																																																							
VM2065A0	TAPPO COLONNINA LM600 INF SX	1	PZ																																																							
VT1252A0	VETRO EST.XF135 NERO ENGEFOOD	1	PZ																																																							
KVT1063A	KIT VETRO ESTERNO LMISS ARIANNA FORNETTI	<table border="1"> <thead> <tr> <th>Codice</th> <th>Descrizione</th> <th>Qtà</th> <th>UM</th> </tr> </thead> <tbody> <tr> <td>IP1385A1</td> <td>IMB POL ANGOLARE 110X80X2000 D30</td> <td>0.980</td> <td>M</td> </tr> <tr> <td>IP1508A0</td> <td>POLISTIROLO PROFILO AD U 2000X60X60</td> <td>0.960</td> <td>PZ</td> </tr> <tr> <td>IP1508A1</td> <td>POLISTIROLO PROFILO AD U 2000X60X60</td> <td>0.960</td> <td>M</td> </tr> <tr> <td>MS1009A0</td> <td>ETICHETTA LOGO FORNETTI</td> <td>1</td> <td>PZ</td> </tr> <tr> <td>RC1200A0</td> <td>MOLLA A COMPRESSIO NE DE4 DF0.5 H24</td> <td>2</td> <td>PZ</td> </tr> <tr> <td>SL1050A1</td> <td>NASTRO BIADESIVO 3M TRANSFER VH</td> <td>0.820</td> <td>M</td> </tr> <tr> <td>TB2301A0</td> <td>COLONNINA DX XVC105E 40X40X1</td> <td>2</td> <td>PZ</td> </tr> <tr> <td>TB3081A0</td> <td>COLONNINA SX LM ARI-RO</td> <td>1</td> <td>PZ</td> </tr> <tr> <td>VM1025A0</td> <td>TAPPO NYLON PA66 V2 GRIGIO Ø16</td> <td>2</td> <td>PZ</td> </tr> <tr> <td>VM1059A1</td> <td>FILM TERMORETRA IBILE H800</td> <td>1.300</td> <td>M</td> </tr> <tr> <td>VM1695A0</td> <td>PERNO POSIZIONE MANIGLIA</td> <td>2</td> <td>PZ</td> </tr> <tr> <td>VM1920A0</td> <td>PIASTRINA DX CHIUSURA VETRO INT</td> <td>1</td> <td>PZ</td> </tr> <tr> <td>VM1921A0</td> <td>PIASTRINA SX CHIUSURA VETRO INT</td> <td>1</td> <td>PZ</td> </tr> </tbody> </table>	Codice	Descrizione	Qtà	UM	IP1385A1	IMB POL ANGOLARE 110X80X2000 D30	0.980	M	IP1508A0	POLISTIROLO PROFILO AD U 2000X60X60	0.960	PZ	IP1508A1	POLISTIROLO PROFILO AD U 2000X60X60	0.960	M	MS1009A0	ETICHETTA LOGO FORNETTI	1	PZ	RC1200A0	MOLLA A COMPRESSIO NE DE4 DF0.5 H24	2	PZ	SL1050A1	NASTRO BIADESIVO 3M TRANSFER VH	0.820	M	TB2301A0	COLONNINA DX XVC105E 40X40X1	2	PZ	TB3081A0	COLONNINA SX LM ARI-RO	1	PZ	VM1025A0	TAPPO NYLON PA66 V2 GRIGIO Ø16	2	PZ	VM1059A1	FILM TERMORETRA IBILE H800	1.300	M	VM1695A0	PERNO POSIZIONE MANIGLIA	2	PZ	VM1920A0	PIASTRINA DX CHIUSURA VETRO INT	1	PZ	VM1921A0	PIASTRINA SX CHIUSURA VETRO INT	1	PZ
Codice	Descrizione	Qtà	UM																																																							
IP1385A1	IMB POL ANGOLARE 110X80X2000 D30	0.980	M																																																							
IP1508A0	POLISTIROLO PROFILO AD U 2000X60X60	0.960	PZ																																																							
IP1508A1	POLISTIROLO PROFILO AD U 2000X60X60	0.960	M																																																							
MS1009A0	ETICHETTA LOGO FORNETTI	1	PZ																																																							
RC1200A0	MOLLA A COMPRESSIO NE DE4 DF0.5 H24	2	PZ																																																							
SL1050A1	NASTRO BIADESIVO 3M TRANSFER VH	0.820	M																																																							
TB2301A0	COLONNINA DX XVC105E 40X40X1	2	PZ																																																							
TB3081A0	COLONNINA SX LM ARI-RO	1	PZ																																																							
VM1025A0	TAPPO NYLON PA66 V2 GRIGIO Ø16	2	PZ																																																							
VM1059A1	FILM TERMORETRA IBILE H800	1.300	M																																																							
VM1695A0	PERNO POSIZIONE MANIGLIA	2	PZ																																																							
VM1920A0	PIASTRINA DX CHIUSURA VETRO INT	1	PZ																																																							
VM1921A0	PIASTRINA SX CHIUSURA VETRO INT	1	PZ																																																							



COMPONENTE			RICAMBIO																																																			
Codice	Descrizione	Immagine	Codice	Descrizione	Lista componenti																																																	
VM2062A	TAPPO COLONNINA LM600 SUP DX		KVT1063A	KIT VETRO ESTERNO LMISS ARIANNA FORNETTI	<table border="1"> <thead> <tr> <th>Codice</th> <th>Descrizione</th> <th>Qtà</th> <th>UM</th> </tr> </thead> <tbody> <tr> <td>VM2062A0</td> <td>TAPPO COLONNINA LM600 SUP DX</td> <td>1</td> <td>PZ</td> </tr> <tr> <td>VM2063A0</td> <td>TAPPO COLONNINA LM600 SUP SX</td> <td>1</td> <td>PZ</td> </tr> <tr> <td>VM2064A0</td> <td>TAPPO COLONNINA LM600 INF DX</td> <td>1</td> <td>PZ</td> </tr> <tr> <td>VM2065A0</td> <td>TAPPO COLONNINA LM600 INF SX</td> <td>1</td> <td>PZ</td> </tr> <tr> <td>VT1063A0</td> <td>VETRO EST. 598X424 XF135F</td> <td>1</td> <td>PZ</td> </tr> </tbody> </table>	Codice	Descrizione	Qtà	UM	VM2062A0	TAPPO COLONNINA LM600 SUP DX	1	PZ	VM2063A0	TAPPO COLONNINA LM600 SUP SX	1	PZ	VM2064A0	TAPPO COLONNINA LM600 INF DX	1	PZ	VM2065A0	TAPPO COLONNINA LM600 INF SX	1	PZ	VT1063A0	VETRO EST. 598X424 XF135F	1	PZ																									
			Codice	Descrizione	Qtà	UM																																																
VM2062A0	TAPPO COLONNINA LM600 SUP DX	1	PZ																																																			
VM2063A0	TAPPO COLONNINA LM600 SUP SX	1	PZ																																																			
VM2064A0	TAPPO COLONNINA LM600 INF DX	1	PZ																																																			
VM2065A0	TAPPO COLONNINA LM600 INF SX	1	PZ																																																			
VT1063A0	VETRO EST. 598X424 XF135F	1	PZ																																																			
KVT1062A	KIT VETRO ESTERNO LM ARIANNA BLACK	<table border="1"> <thead> <tr> <th>Codice</th> <th>Descrizione</th> <th>Qtà</th> <th>UM</th> </tr> </thead> <tbody> <tr> <td>IP1385A1</td> <td>IMB POL ANGOLARE 110X80X2000 D30</td> <td>1.280</td> <td>M</td> </tr> <tr> <td>RC1200A0</td> <td>MOLLA A COMPRESSIO NE DE4 DF0.5 H24</td> <td>2</td> <td>PZ</td> </tr> <tr> <td>SL1050A1</td> <td>NASTRO BIADESIVO 3M TRANSFER VH</td> <td>0.820</td> <td>M</td> </tr> <tr> <td>TB2301A0</td> <td>COLONNINA DX XVC105E 40X40X1</td> <td>2</td> <td>PZ</td> </tr> <tr> <td>TB3081A0</td> <td>COLONNINA SX LM ARI-RO</td> <td>1</td> <td>PZ</td> </tr> <tr> <td>VM1025A0</td> <td>TAPPO NYLON PA66 V2 GRIGIO Ø16</td> <td>2</td> <td>PZ</td> </tr> <tr> <td>VM1059A1</td> <td>FILM TERMORETRA IBILE H800</td> <td>1</td> <td>M</td> </tr> <tr> <td>VM1695A0</td> <td>PERNO POSIZIONE MANIGLIA</td> <td>2</td> <td>PZ</td> </tr> <tr> <td>VM1920A0</td> <td>PIASTRINA DX CHIUSURA VETRO INT</td> <td>1</td> <td>PZ</td> </tr> <tr> <td>VM1921A0</td> <td>PIASTRINA SX CHIUSURA VETRO INT</td> <td>1</td> <td>PZ</td> </tr> <tr> <td>VM2062A0</td> <td>TAPPO COLONNINA LM600 SUP DX</td> <td>1</td> <td>PZ</td> </tr> <tr> <td>VM2063A0</td> <td>TAPPO COLONNINA LM600 SUP SX</td> <td>1</td> <td>PZ</td> </tr> </tbody> </table>	Codice	Descrizione	Qtà	UM	IP1385A1	IMB POL ANGOLARE 110X80X2000 D30	1.280	M	RC1200A0	MOLLA A COMPRESSIO NE DE4 DF0.5 H24	2	PZ	SL1050A1	NASTRO BIADESIVO 3M TRANSFER VH	0.820	M	TB2301A0	COLONNINA DX XVC105E 40X40X1	2	PZ	TB3081A0	COLONNINA SX LM ARI-RO	1	PZ	VM1025A0	TAPPO NYLON PA66 V2 GRIGIO Ø16	2	PZ	VM1059A1	FILM TERMORETRA IBILE H800	1	M	VM1695A0	PERNO POSIZIONE MANIGLIA	2	PZ	VM1920A0	PIASTRINA DX CHIUSURA VETRO INT	1	PZ	VM1921A0	PIASTRINA SX CHIUSURA VETRO INT	1	PZ	VM2062A0	TAPPO COLONNINA LM600 SUP DX	1	PZ	VM2063A0	TAPPO COLONNINA LM600 SUP SX	1	PZ
Codice	Descrizione	Qtà	UM																																																			
IP1385A1	IMB POL ANGOLARE 110X80X2000 D30	1.280	M																																																			
RC1200A0	MOLLA A COMPRESSIO NE DE4 DF0.5 H24	2	PZ																																																			
SL1050A1	NASTRO BIADESIVO 3M TRANSFER VH	0.820	M																																																			
TB2301A0	COLONNINA DX XVC105E 40X40X1	2	PZ																																																			
TB3081A0	COLONNINA SX LM ARI-RO	1	PZ																																																			
VM1025A0	TAPPO NYLON PA66 V2 GRIGIO Ø16	2	PZ																																																			
VM1059A1	FILM TERMORETRA IBILE H800	1	M																																																			
VM1695A0	PERNO POSIZIONE MANIGLIA	2	PZ																																																			
VM1920A0	PIASTRINA DX CHIUSURA VETRO INT	1	PZ																																																			
VM1921A0	PIASTRINA SX CHIUSURA VETRO INT	1	PZ																																																			
VM2062A0	TAPPO COLONNINA LM600 SUP DX	1	PZ																																																			
VM2063A0	TAPPO COLONNINA LM600 SUP SX	1	PZ																																																			

COMPONENTE			RICAMBIO																																																											
Codice	Descrizione	Immagine	Codice	Descrizione	Lista componenti																																																									
VM2062A	TAPPO COLONNINA LM600 SUP DX		KVT1062A	KIT VETRO ESTERNO LM ARIANNA BLACK	<table border="1"> <thead> <tr> <th>Codice</th> <th>Descrizione</th> <th>Qtà</th> <th>UM</th> </tr> </thead> <tbody> <tr> <td>VM2064A0</td> <td>TAPPO COLONNINA LM600 INF DX</td> <td>1</td> <td>PZ</td> </tr> <tr> <td>VM2065A0</td> <td>TAPPO COLONNINA LM600 INF SX</td> <td>1</td> <td>PZ</td> </tr> <tr> <td>VT1062A0</td> <td>VETRO ESTERNO GRIGIO LINEMISS ARIANNA</td> <td>1</td> <td>PZ</td> </tr> </tbody> </table>	Codice	Descrizione	Qtà	UM	VM2064A0	TAPPO COLONNINA LM600 INF DX	1	PZ	VM2065A0	TAPPO COLONNINA LM600 INF SX	1	PZ	VT1062A0	VETRO ESTERNO GRIGIO LINEMISS ARIANNA	1	PZ																																									
			Codice	Descrizione	Qtà	UM																																																								
VM2064A0	TAPPO COLONNINA LM600 INF DX	1	PZ																																																											
VM2065A0	TAPPO COLONNINA LM600 INF SX	1	PZ																																																											
VT1062A0	VETRO ESTERNO GRIGIO LINEMISS ARIANNA	1	PZ																																																											
KVT1061A	KIT VETRO ESTERNO LM ARIANNA	<table border="1"> <thead> <tr> <th>Codice</th> <th>Descrizione</th> <th>Qtà</th> <th>UM</th> </tr> </thead> <tbody> <tr> <td>IP1385A1</td> <td>IMB POL ANGOLARE 110X80X2000 D30</td> <td>1.280</td> <td>M</td> </tr> <tr> <td>RC1200A0</td> <td>MOLLA A COMPRESSIO NE DE4 DF0.5 H24</td> <td>2</td> <td>PZ</td> </tr> <tr> <td>SL1050A1</td> <td>NASTRO BIADESIVO 3M TRANSFER VH</td> <td>0.820</td> <td>M</td> </tr> <tr> <td>TB2301A0</td> <td>COLONNINA DX XVC105E 40X40X1</td> <td>2</td> <td>PZ</td> </tr> <tr> <td>VM1025A0</td> <td>TAPPO NYLON PA66 V2 GRIGIO Ø16</td> <td>2</td> <td>PZ</td> </tr> <tr> <td>VM1059A1</td> <td>FILM TERMORETRA IBILE H800</td> <td>1.300</td> <td>M</td> </tr> <tr> <td>VM1695A0</td> <td>PERNO POSIZIONE MANIGLIA</td> <td>2</td> <td>PZ</td> </tr> <tr> <td>VM1920A0</td> <td>PIASTRINA DX CHIUSURA VETRO INT</td> <td>1</td> <td>PZ</td> </tr> <tr> <td>VM1921A0</td> <td>PIASTRINA SX CHIUSURA VETRO INT</td> <td>1</td> <td>PZ</td> </tr> <tr> <td>VM2062A0</td> <td>TAPPO COLONNINA LM600 SUP DX</td> <td>1</td> <td>PZ</td> </tr> <tr> <td>VM2063A0</td> <td>TAPPO COLONNINA LM600 SUP SX</td> <td>1</td> <td>PZ</td> </tr> <tr> <td>VM2064A0</td> <td>TAPPO COLONNINA LM600 INF DX</td> <td>1</td> <td>PZ</td> </tr> <tr> <td>VM2065A0</td> <td>TAPPO COLONNINA LM600 INF SX</td> <td>1</td> <td>PZ</td> </tr> <tr> <td>VT1061A2</td> <td>VETRO ESTERNO SER. GIALLO 598X424X5</td> <td>1</td> <td>PZ</td> </tr> </tbody> </table>	Codice	Descrizione	Qtà	UM	IP1385A1	IMB POL ANGOLARE 110X80X2000 D30	1.280	M	RC1200A0	MOLLA A COMPRESSIO NE DE4 DF0.5 H24	2	PZ	SL1050A1	NASTRO BIADESIVO 3M TRANSFER VH	0.820	M	TB2301A0	COLONNINA DX XVC105E 40X40X1	2	PZ	VM1025A0	TAPPO NYLON PA66 V2 GRIGIO Ø16	2	PZ	VM1059A1	FILM TERMORETRA IBILE H800	1.300	M	VM1695A0	PERNO POSIZIONE MANIGLIA	2	PZ	VM1920A0	PIASTRINA DX CHIUSURA VETRO INT	1	PZ	VM1921A0	PIASTRINA SX CHIUSURA VETRO INT	1	PZ	VM2062A0	TAPPO COLONNINA LM600 SUP DX	1	PZ	VM2063A0	TAPPO COLONNINA LM600 SUP SX	1	PZ	VM2064A0	TAPPO COLONNINA LM600 INF DX	1	PZ	VM2065A0	TAPPO COLONNINA LM600 INF SX	1	PZ	VT1061A2	VETRO ESTERNO SER. GIALLO 598X424X5	1	PZ
Codice	Descrizione	Qtà	UM																																																											
IP1385A1	IMB POL ANGOLARE 110X80X2000 D30	1.280	M																																																											
RC1200A0	MOLLA A COMPRESSIO NE DE4 DF0.5 H24	2	PZ																																																											
SL1050A1	NASTRO BIADESIVO 3M TRANSFER VH	0.820	M																																																											
TB2301A0	COLONNINA DX XVC105E 40X40X1	2	PZ																																																											
VM1025A0	TAPPO NYLON PA66 V2 GRIGIO Ø16	2	PZ																																																											
VM1059A1	FILM TERMORETRA IBILE H800	1.300	M																																																											
VM1695A0	PERNO POSIZIONE MANIGLIA	2	PZ																																																											
VM1920A0	PIASTRINA DX CHIUSURA VETRO INT	1	PZ																																																											
VM1921A0	PIASTRINA SX CHIUSURA VETRO INT	1	PZ																																																											
VM2062A0	TAPPO COLONNINA LM600 SUP DX	1	PZ																																																											
VM2063A0	TAPPO COLONNINA LM600 SUP SX	1	PZ																																																											
VM2064A0	TAPPO COLONNINA LM600 INF DX	1	PZ																																																											
VM2065A0	TAPPO COLONNINA LM600 INF SX	1	PZ																																																											
VT1061A2	VETRO ESTERNO SER. GIALLO 598X424X5	1	PZ																																																											

COMPONENTE			RICAMBIO																																																																										
Codice	Descrizione	Immagine	Codice	Descrizione	Lista componenti																																																																								
VM2062A	TAPPO COLONNINA LM600 SUP DX		KVT1057A	KIT VETRO ESTERNO NERO LMISS STEFANIA	<table border="1"> <thead> <tr> <th>Codice</th> <th>Descrizione</th> <th>Qtà</th> <th>UM</th> </tr> </thead> <tbody> <tr> <td>IP1385A1</td> <td>IMB POL ANGOLARE 110X80X2000 D30</td> <td>0.810</td> <td>M</td> </tr> <tr> <td>IP1508A0</td> <td>POLISTIROLO PROFILO AD U 2000X60X60</td> <td>0.950</td> <td>PZ</td> </tr> <tr> <td>IP1508A1</td> <td>POLISTIROLO PROFILO AD U 2000X60X60</td> <td>0.960</td> <td>M</td> </tr> <tr> <td>RC1200A0</td> <td>MOLLA A COMPRESSIO NE DE4 DF0.5 H24</td> <td>2</td> <td>PZ</td> </tr> <tr> <td>SL1050A1</td> <td>NASTRO BIADESIVO 3M TRANSFER VH</td> <td>0.660</td> <td>M</td> </tr> <tr> <td>TB2306A0</td> <td>COLONNINA DX LM STE-ELE 40X40X1</td> <td>2</td> <td>PZ</td> </tr> <tr> <td>TB3080A0</td> <td>COLONNINA SX LM STE-EL</td> <td>1</td> <td>PZ</td> </tr> <tr> <td>VM1025A0</td> <td>TAPPO NYLON PA66 V2 GRIGIO Ø16</td> <td>2</td> <td>PZ</td> </tr> <tr> <td>VM1059A1</td> <td>FILM TERMORETRA IBILE H800</td> <td>1</td> <td>M</td> </tr> <tr> <td>VM1695A0</td> <td>PERNO POSIZIONE MANIGLIA</td> <td>2</td> <td>PZ</td> </tr> <tr> <td>VM1920A0</td> <td>PIASTRINA DX CHIUSURA VETRO INT</td> <td>1</td> <td>PZ</td> </tr> <tr> <td>VM1921A0</td> <td>PIASTRINA SX CHIUSURA VETRO INT</td> <td>1</td> <td>PZ</td> </tr> <tr> <td>VM2062A0</td> <td>TAPPO COLONNINA LM600 SUP DX</td> <td>1</td> <td>PZ</td> </tr> <tr> <td>VM2063A0</td> <td>TAPPO COLONNINA LM600 SUP SX</td> <td>1</td> <td>PZ</td> </tr> <tr> <td>VM2064A0</td> <td>TAPPO COLONNINA LM600 INF DX</td> <td>1</td> <td>PZ</td> </tr> <tr> <td>VM2065A0</td> <td>TAPPO COLONNINA LM600 INF SX</td> <td>1</td> <td>PZ</td> </tr> <tr> <td>VT1057A0</td> <td>VETRO ESTERNO SER. GRIGIO 598X344X5</td> <td>1</td> <td>PZ</td> </tr> </tbody> </table>	Codice	Descrizione	Qtà	UM	IP1385A1	IMB POL ANGOLARE 110X80X2000 D30	0.810	M	IP1508A0	POLISTIROLO PROFILO AD U 2000X60X60	0.950	PZ	IP1508A1	POLISTIROLO PROFILO AD U 2000X60X60	0.960	M	RC1200A0	MOLLA A COMPRESSIO NE DE4 DF0.5 H24	2	PZ	SL1050A1	NASTRO BIADESIVO 3M TRANSFER VH	0.660	M	TB2306A0	COLONNINA DX LM STE-ELE 40X40X1	2	PZ	TB3080A0	COLONNINA SX LM STE-EL	1	PZ	VM1025A0	TAPPO NYLON PA66 V2 GRIGIO Ø16	2	PZ	VM1059A1	FILM TERMORETRA IBILE H800	1	M	VM1695A0	PERNO POSIZIONE MANIGLIA	2	PZ	VM1920A0	PIASTRINA DX CHIUSURA VETRO INT	1	PZ	VM1921A0	PIASTRINA SX CHIUSURA VETRO INT	1	PZ	VM2062A0	TAPPO COLONNINA LM600 SUP DX	1	PZ	VM2063A0	TAPPO COLONNINA LM600 SUP SX	1	PZ	VM2064A0	TAPPO COLONNINA LM600 INF DX	1	PZ	VM2065A0	TAPPO COLONNINA LM600 INF SX	1	PZ	VT1057A0	VETRO ESTERNO SER. GRIGIO 598X344X5	1	PZ
Codice	Descrizione	Qtà	UM																																																																										
IP1385A1	IMB POL ANGOLARE 110X80X2000 D30	0.810	M																																																																										
IP1508A0	POLISTIROLO PROFILO AD U 2000X60X60	0.950	PZ																																																																										
IP1508A1	POLISTIROLO PROFILO AD U 2000X60X60	0.960	M																																																																										
RC1200A0	MOLLA A COMPRESSIO NE DE4 DF0.5 H24	2	PZ																																																																										
SL1050A1	NASTRO BIADESIVO 3M TRANSFER VH	0.660	M																																																																										
TB2306A0	COLONNINA DX LM STE-ELE 40X40X1	2	PZ																																																																										
TB3080A0	COLONNINA SX LM STE-EL	1	PZ																																																																										
VM1025A0	TAPPO NYLON PA66 V2 GRIGIO Ø16	2	PZ																																																																										
VM1059A1	FILM TERMORETRA IBILE H800	1	M																																																																										
VM1695A0	PERNO POSIZIONE MANIGLIA	2	PZ																																																																										
VM1920A0	PIASTRINA DX CHIUSURA VETRO INT	1	PZ																																																																										
VM1921A0	PIASTRINA SX CHIUSURA VETRO INT	1	PZ																																																																										
VM2062A0	TAPPO COLONNINA LM600 SUP DX	1	PZ																																																																										
VM2063A0	TAPPO COLONNINA LM600 SUP SX	1	PZ																																																																										
VM2064A0	TAPPO COLONNINA LM600 INF DX	1	PZ																																																																										
VM2065A0	TAPPO COLONNINA LM600 INF SX	1	PZ																																																																										
VT1057A0	VETRO ESTERNO SER. GRIGIO 598X344X5	1	PZ																																																																										

COMPONENTE			RICAMBIO																																																																						
Codice	Descrizione	Immagine	Codice	Descrizione	Lista componenti																																																																				
VM2062A	TAPPO COLONNINA LM600 SUP DX		KVT1056A	KIT VETRO ESTERNO GIALLO LMISS STEFANIA	<table border="1"> <thead> <tr> <th>Codice</th> <th>Descrizione</th> <th>Qtà</th> <th>UM</th> </tr> </thead> <tbody> <tr> <td>IP1385A1</td> <td>IMB POL ANGOLARE 110X80X2000 D30</td> <td>0.980</td> <td>M</td> </tr> <tr> <td>IP1508A0</td> <td>POLISTIROLO PROFILO AD U 2000X60X60</td> <td>0.960</td> <td>PZ</td> </tr> <tr> <td>IP1508A1</td> <td>POLISTIROLO PROFILO AD U 2000X60X60</td> <td>0.960</td> <td>M</td> </tr> <tr> <td>RC1200A0</td> <td>MOLLA A COMPRESSIO NE DE4 DF0.5 H24</td> <td>2</td> <td>PZ</td> </tr> <tr> <td>SL1050A1</td> <td>NASTRO BIADESIVO 3M TRANSFER VH</td> <td>0.660</td> <td>M</td> </tr> <tr> <td>TB2306A0</td> <td>COLONNINA DX LM STE-ELE 40X40X1</td> <td>2</td> <td>PZ</td> </tr> <tr> <td>VM1025A0</td> <td>TAPPO NYLON PA66 V2 GRIGIO Ø16</td> <td>2</td> <td>PZ</td> </tr> <tr> <td>VM1059A1</td> <td>FILM TERMORETRA IBILE H800</td> <td>1.300</td> <td>M</td> </tr> <tr> <td>VM1695A0</td> <td>PERNO POSIZIONE MANIGLIA</td> <td>2</td> <td>PZ</td> </tr> <tr> <td>VM1920A0</td> <td>PIASTRINA DX CHIUSURA VETRO INT</td> <td>1</td> <td>PZ</td> </tr> <tr> <td>VM1921A0</td> <td>PIASTRINA SX CHIUSURA VETRO INT</td> <td>1</td> <td>PZ</td> </tr> <tr> <td>VM2062A0</td> <td>TAPPO COLONNINA LM600 SUP DX</td> <td>1</td> <td>PZ</td> </tr> <tr> <td>VM2063A0</td> <td>TAPPO COLONNINA LM600 SUP SX</td> <td>1</td> <td>PZ</td> </tr> <tr> <td>VM2064A0</td> <td>TAPPO COLONNINA LM600 INF DX</td> <td>1</td> <td>PZ</td> </tr> <tr> <td>VM2065A0</td> <td>TAPPO COLONNINA LM600 INF SX</td> <td>1</td> <td>PZ</td> </tr> <tr> <td>VT1056A2</td> <td>VETRO ESTERNO SER. GIALLO 598X344X5</td> <td>1</td> <td>PZ</td> </tr> </tbody> </table>	Codice	Descrizione	Qtà	UM	IP1385A1	IMB POL ANGOLARE 110X80X2000 D30	0.980	M	IP1508A0	POLISTIROLO PROFILO AD U 2000X60X60	0.960	PZ	IP1508A1	POLISTIROLO PROFILO AD U 2000X60X60	0.960	M	RC1200A0	MOLLA A COMPRESSIO NE DE4 DF0.5 H24	2	PZ	SL1050A1	NASTRO BIADESIVO 3M TRANSFER VH	0.660	M	TB2306A0	COLONNINA DX LM STE-ELE 40X40X1	2	PZ	VM1025A0	TAPPO NYLON PA66 V2 GRIGIO Ø16	2	PZ	VM1059A1	FILM TERMORETRA IBILE H800	1.300	M	VM1695A0	PERNO POSIZIONE MANIGLIA	2	PZ	VM1920A0	PIASTRINA DX CHIUSURA VETRO INT	1	PZ	VM1921A0	PIASTRINA SX CHIUSURA VETRO INT	1	PZ	VM2062A0	TAPPO COLONNINA LM600 SUP DX	1	PZ	VM2063A0	TAPPO COLONNINA LM600 SUP SX	1	PZ	VM2064A0	TAPPO COLONNINA LM600 INF DX	1	PZ	VM2065A0	TAPPO COLONNINA LM600 INF SX	1	PZ	VT1056A2	VETRO ESTERNO SER. GIALLO 598X344X5	1	PZ
Codice	Descrizione	Qtà	UM																																																																						
IP1385A1	IMB POL ANGOLARE 110X80X2000 D30	0.980	M																																																																						
IP1508A0	POLISTIROLO PROFILO AD U 2000X60X60	0.960	PZ																																																																						
IP1508A1	POLISTIROLO PROFILO AD U 2000X60X60	0.960	M																																																																						
RC1200A0	MOLLA A COMPRESSIO NE DE4 DF0.5 H24	2	PZ																																																																						
SL1050A1	NASTRO BIADESIVO 3M TRANSFER VH	0.660	M																																																																						
TB2306A0	COLONNINA DX LM STE-ELE 40X40X1	2	PZ																																																																						
VM1025A0	TAPPO NYLON PA66 V2 GRIGIO Ø16	2	PZ																																																																						
VM1059A1	FILM TERMORETRA IBILE H800	1.300	M																																																																						
VM1695A0	PERNO POSIZIONE MANIGLIA	2	PZ																																																																						
VM1920A0	PIASTRINA DX CHIUSURA VETRO INT	1	PZ																																																																						
VM1921A0	PIASTRINA SX CHIUSURA VETRO INT	1	PZ																																																																						
VM2062A0	TAPPO COLONNINA LM600 SUP DX	1	PZ																																																																						
VM2063A0	TAPPO COLONNINA LM600 SUP SX	1	PZ																																																																						
VM2064A0	TAPPO COLONNINA LM600 INF DX	1	PZ																																																																						
VM2065A0	TAPPO COLONNINA LM600 INF SX	1	PZ																																																																						
VT1056A2	VETRO ESTERNO SER. GIALLO 598X344X5	1	PZ																																																																						

COMPONENTE			RICAMBIO																																																																									
Codice	Descrizione	Immagine	Codice	Descrizione	Lista componenti																																																																							
VM2062A	TAPPO COLONNINA LM600 SUP DX		KVT1052A	KIT VETRO ESTERNO NERO LINEMISS CRISTINA	<table border="1"> <thead> <tr> <th>Codice</th> <th>Descrizione</th> <th>Qtà</th> <th>UM</th> </tr> </thead> <tbody> <tr> <td>RC1200A0</td> <td>MOLLA A COMPRESSIO NE DE4 DF0.5 H24</td> <td>2</td> <td>PZ</td> </tr> <tr> <td>SL1050A1</td> <td>NASTRO BIADESIVO 3M TRANSFER VH</td> <td>0.660</td> <td>M</td> </tr> <tr> <td>TB2306A0</td> <td>COLONNINA DX LM STE-ELE 40X40X1</td> <td>2</td> <td>PZ</td> </tr> <tr> <td>VM1025A0</td> <td>TAPPO NYLON PA66 V2 GRIGIO Ø16</td> <td>2</td> <td>PZ</td> </tr> <tr> <td>VM1695A0</td> <td>PERNO POSIZIONE MANIGLIA</td> <td>2</td> <td>PZ</td> </tr> <tr> <td>VM1920A0</td> <td>PIASTRINA DX CHIUSURA VETRO INT</td> <td>1</td> <td>PZ</td> </tr> <tr> <td>VM1921A0</td> <td>PIASTRINA SX CHIUSURA VETRO INT</td> <td>1</td> <td>PZ</td> </tr> <tr> <td>VM2062A0</td> <td>TAPPO COLONNINA LM600 SUP DX</td> <td>1</td> <td>PZ</td> </tr> <tr> <td>VM2063A0</td> <td>TAPPO COLONNINA LM600 SUP SX</td> <td>1</td> <td>PZ</td> </tr> <tr> <td>VM2064A0</td> <td>TAPPO COLONNINA LM600 INF DX</td> <td>1</td> <td>PZ</td> </tr> <tr> <td>VM2065A0</td> <td>TAPPO COLONNINA LM600 INF SX</td> <td>1</td> <td>PZ</td> </tr> <tr> <td>VT1052A0</td> <td>VETRO ESTERNO SER. GRIGIO 478X344X5</td> <td>1</td> <td>PZ</td> </tr> </tbody> </table>	Codice	Descrizione	Qtà	UM	RC1200A0	MOLLA A COMPRESSIO NE DE4 DF0.5 H24	2	PZ	SL1050A1	NASTRO BIADESIVO 3M TRANSFER VH	0.660	M	TB2306A0	COLONNINA DX LM STE-ELE 40X40X1	2	PZ	VM1025A0	TAPPO NYLON PA66 V2 GRIGIO Ø16	2	PZ	VM1695A0	PERNO POSIZIONE MANIGLIA	2	PZ	VM1920A0	PIASTRINA DX CHIUSURA VETRO INT	1	PZ	VM1921A0	PIASTRINA SX CHIUSURA VETRO INT	1	PZ	VM2062A0	TAPPO COLONNINA LM600 SUP DX	1	PZ	VM2063A0	TAPPO COLONNINA LM600 SUP SX	1	PZ	VM2064A0	TAPPO COLONNINA LM600 INF DX	1	PZ	VM2065A0	TAPPO COLONNINA LM600 INF SX	1	PZ	VT1052A0	VETRO ESTERNO SER. GRIGIO 478X344X5	1	PZ	KVT1051A	KIT VETRO ESTERNO GIALLO L.MISS CRISTINA	<table border="1"> <thead> <tr> <th>Codice</th> <th>Descrizione</th> <th>Qtà</th> <th>UM</th> </tr> </thead> <tbody> <tr> <td>IP1385A1</td> <td>IMB POL ANGOLARE 110X80X2000 D30</td> <td>1.040</td> <td>M</td> </tr> <tr> <td>RC1200A0</td> <td>MOLLA A COMPRESSIO NE DE4 DF0.5 H24</td> <td>2</td> <td>PZ</td> </tr> <tr> <td>SL1050A1</td> <td>NASTRO BIADESIVO 3M TRANSFER VH</td> <td>0.660</td> <td>M</td> </tr> </tbody> </table>	Codice	Descrizione	Qtà	UM	IP1385A1	IMB POL ANGOLARE 110X80X2000 D30	1.040	M	RC1200A0	MOLLA A COMPRESSIO NE DE4 DF0.5 H24	2	PZ	SL1050A1	NASTRO BIADESIVO 3M TRANSFER VH	0.660	M
			Codice	Descrizione	Qtà	UM																																																																						
RC1200A0	MOLLA A COMPRESSIO NE DE4 DF0.5 H24	2	PZ																																																																									
SL1050A1	NASTRO BIADESIVO 3M TRANSFER VH	0.660	M																																																																									
TB2306A0	COLONNINA DX LM STE-ELE 40X40X1	2	PZ																																																																									
VM1025A0	TAPPO NYLON PA66 V2 GRIGIO Ø16	2	PZ																																																																									
VM1695A0	PERNO POSIZIONE MANIGLIA	2	PZ																																																																									
VM1920A0	PIASTRINA DX CHIUSURA VETRO INT	1	PZ																																																																									
VM1921A0	PIASTRINA SX CHIUSURA VETRO INT	1	PZ																																																																									
VM2062A0	TAPPO COLONNINA LM600 SUP DX	1	PZ																																																																									
VM2063A0	TAPPO COLONNINA LM600 SUP SX	1	PZ																																																																									
VM2064A0	TAPPO COLONNINA LM600 INF DX	1	PZ																																																																									
VM2065A0	TAPPO COLONNINA LM600 INF SX	1	PZ																																																																									
VT1052A0	VETRO ESTERNO SER. GRIGIO 478X344X5	1	PZ																																																																									
Codice	Descrizione	Qtà	UM																																																																									
IP1385A1	IMB POL ANGOLARE 110X80X2000 D30	1.040	M																																																																									
RC1200A0	MOLLA A COMPRESSIO NE DE4 DF0.5 H24	2	PZ																																																																									
SL1050A1	NASTRO BIADESIVO 3M TRANSFER VH	0.660	M																																																																									

COMPONENTE			RICAMBIO																																																		
Codice	Descrizione	Immagine	Codice	Descrizione	Lista componenti																																																
VM2062A	TAPPO COLONNINA LM600 SUP DX		KVT1051A	KIT VETRO ESTERNO GIALLO L.MISS CRISTINA	<table border="1"> <thead> <tr> <th>Codice</th> <th>Descrizione</th> <th>Qtà</th> <th>UM</th> </tr> </thead> <tbody> <tr> <td>TB2306A0</td> <td>COLONNINA DX LM STE-ELE 40X40X1</td> <td>2</td> <td>PZ</td> </tr> <tr> <td>VM1025A0</td> <td>TAPPO NYLON PA66 V2 GRIGIO Ø16</td> <td>2</td> <td>PZ</td> </tr> <tr> <td>VM1059A1</td> <td>FILM TERMORETRA IBILE H800</td> <td>1.500</td> <td>M</td> </tr> <tr> <td>VM1695A0</td> <td>PERNO POSIZIONE MANIGLIA</td> <td>2</td> <td>PZ</td> </tr> <tr> <td>VM1920A0</td> <td>PIASTRINA DX CHIUSURA VETRO INT</td> <td>1</td> <td>PZ</td> </tr> <tr> <td>VM1921A0</td> <td>PIASTRINA SX CHIUSURA VETRO INT</td> <td>1</td> <td>PZ</td> </tr> <tr> <td>VM2062A0</td> <td>TAPPO COLONNINA LM600 SUP DX</td> <td>1</td> <td>PZ</td> </tr> <tr> <td>VM2063A0</td> <td>TAPPO COLONNINA LM600 SUP SX</td> <td>1</td> <td>PZ</td> </tr> <tr> <td>VM2064A0</td> <td>TAPPO COLONNINA LM600 INF DX</td> <td>1</td> <td>PZ</td> </tr> <tr> <td>VM2065A0</td> <td>TAPPO COLONNINA LM600 INF SX</td> <td>1</td> <td>PZ</td> </tr> <tr> <td>VT1051A2</td> <td>VETRO ESTERNO SER. GIALLO 478X344X5</td> <td>1</td> <td>PZ</td> </tr> </tbody> </table>	Codice	Descrizione	Qtà	UM	TB2306A0	COLONNINA DX LM STE-ELE 40X40X1	2	PZ	VM1025A0	TAPPO NYLON PA66 V2 GRIGIO Ø16	2	PZ	VM1059A1	FILM TERMORETRA IBILE H800	1.500	M	VM1695A0	PERNO POSIZIONE MANIGLIA	2	PZ	VM1920A0	PIASTRINA DX CHIUSURA VETRO INT	1	PZ	VM1921A0	PIASTRINA SX CHIUSURA VETRO INT	1	PZ	VM2062A0	TAPPO COLONNINA LM600 SUP DX	1	PZ	VM2063A0	TAPPO COLONNINA LM600 SUP SX	1	PZ	VM2064A0	TAPPO COLONNINA LM600 INF DX	1	PZ	VM2065A0	TAPPO COLONNINA LM600 INF SX	1	PZ	VT1051A2	VETRO ESTERNO SER. GIALLO 478X344X5	1	PZ
Codice	Descrizione	Qtà	UM																																																		
TB2306A0	COLONNINA DX LM STE-ELE 40X40X1	2	PZ																																																		
VM1025A0	TAPPO NYLON PA66 V2 GRIGIO Ø16	2	PZ																																																		
VM1059A1	FILM TERMORETRA IBILE H800	1.500	M																																																		
VM1695A0	PERNO POSIZIONE MANIGLIA	2	PZ																																																		
VM1920A0	PIASTRINA DX CHIUSURA VETRO INT	1	PZ																																																		
VM1921A0	PIASTRINA SX CHIUSURA VETRO INT	1	PZ																																																		
VM2062A0	TAPPO COLONNINA LM600 SUP DX	1	PZ																																																		
VM2063A0	TAPPO COLONNINA LM600 SUP SX	1	PZ																																																		
VM2064A0	TAPPO COLONNINA LM600 INF DX	1	PZ																																																		
VM2065A0	TAPPO COLONNINA LM600 INF SX	1	PZ																																																		
VT1051A2	VETRO ESTERNO SER. GIALLO 478X344X5	1	PZ																																																		
VM2063A	TAPPO COLONNINA LM600 SUP SX		KVT1252A	KIT VETRO ESTERNO XF135-EG VT1252A	<table border="1"> <thead> <tr> <th>Codice</th> <th>Descrizione</th> <th>Qtà</th> <th>UM</th> </tr> </thead> <tbody> <tr> <td>RC1200A0</td> <td>MOLLA A COMPRESSIO NE DE4 DF0.5 H24</td> <td>2</td> <td>PZ</td> </tr> <tr> <td>SL1050A1</td> <td>NASTRO BIADESIVO 3M TRANSFER VH</td> <td>0.820</td> <td>M</td> </tr> <tr> <td>TB2301A0</td> <td>COLONNINA DX XVC105E 40X40X1</td> <td>2</td> <td>PZ</td> </tr> <tr> <td>TB3081A0</td> <td>COLONNINA SX LM ARI-RO</td> <td>1</td> <td>PZ</td> </tr> <tr> <td>VM1025A0</td> <td>TAPPO NYLON PA66 V2 GRIGIO Ø16</td> <td>2</td> <td>PZ</td> </tr> <tr> <td>VM1695A0</td> <td>PERNO POSIZIONE MANIGLIA</td> <td>2</td> <td>PZ</td> </tr> </tbody> </table>	Codice	Descrizione	Qtà	UM	RC1200A0	MOLLA A COMPRESSIO NE DE4 DF0.5 H24	2	PZ	SL1050A1	NASTRO BIADESIVO 3M TRANSFER VH	0.820	M	TB2301A0	COLONNINA DX XVC105E 40X40X1	2	PZ	TB3081A0	COLONNINA SX LM ARI-RO	1	PZ	VM1025A0	TAPPO NYLON PA66 V2 GRIGIO Ø16	2	PZ	VM1695A0	PERNO POSIZIONE MANIGLIA	2	PZ																				
Codice	Descrizione	Qtà	UM																																																		
RC1200A0	MOLLA A COMPRESSIO NE DE4 DF0.5 H24	2	PZ																																																		
SL1050A1	NASTRO BIADESIVO 3M TRANSFER VH	0.820	M																																																		
TB2301A0	COLONNINA DX XVC105E 40X40X1	2	PZ																																																		
TB3081A0	COLONNINA SX LM ARI-RO	1	PZ																																																		
VM1025A0	TAPPO NYLON PA66 V2 GRIGIO Ø16	2	PZ																																																		
VM1695A0	PERNO POSIZIONE MANIGLIA	2	PZ																																																		

COMPONENTE			RICAMBIO																																														
Codice	Descrizione	Immagine	Codice	Descrizione	Lista componenti																																												
VM2063A	TAPPO COLONNINA LM600 SUP SX		KVT1252A	KIT VETRO ESTERNO XF135-EG VT1252A	<table border="1"> <thead> <tr> <th>Codice</th> <th>Descrizione</th> <th>Qtà</th> <th>UM</th> </tr> </thead> <tbody> <tr> <td>VM1920A0</td> <td>PIASTRINA DX CHIUSURA VETRO INT</td> <td>1</td> <td>PZ</td> </tr> <tr> <td>VM1921A0</td> <td>PIASTRINA SX CHIUSURA VETRO INT</td> <td>1</td> <td>PZ</td> </tr> <tr> <td>VM2062A0</td> <td>TAPPO COLONNINA LM600 SUP DX</td> <td>1</td> <td>PZ</td> </tr> <tr> <td>VM2063A0</td> <td>TAPPO COLONNINA LM600 SUP SX</td> <td>1</td> <td>PZ</td> </tr> <tr> <td>VM2064A0</td> <td>TAPPO COLONNINA LM600 INF DX</td> <td>1</td> <td>PZ</td> </tr> <tr> <td>VM2065A0</td> <td>TAPPO COLONNINA LM600 INF SX</td> <td>1</td> <td>PZ</td> </tr> <tr> <td>VT1252A0</td> <td>VETRO EST.XF135 NERO ENGEFOOD</td> <td>1</td> <td>PZ</td> </tr> </tbody> </table>	Codice	Descrizione	Qtà	UM	VM1920A0	PIASTRINA DX CHIUSURA VETRO INT	1	PZ	VM1921A0	PIASTRINA SX CHIUSURA VETRO INT	1	PZ	VM2062A0	TAPPO COLONNINA LM600 SUP DX	1	PZ	VM2063A0	TAPPO COLONNINA LM600 SUP SX	1	PZ	VM2064A0	TAPPO COLONNINA LM600 INF DX	1	PZ	VM2065A0	TAPPO COLONNINA LM600 INF SX	1	PZ	VT1252A0	VETRO EST.XF135 NERO ENGEFOOD	1	PZ												
Codice	Descrizione	Qtà	UM																																														
VM1920A0	PIASTRINA DX CHIUSURA VETRO INT	1	PZ																																														
VM1921A0	PIASTRINA SX CHIUSURA VETRO INT	1	PZ																																														
VM2062A0	TAPPO COLONNINA LM600 SUP DX	1	PZ																																														
VM2063A0	TAPPO COLONNINA LM600 SUP SX	1	PZ																																														
VM2064A0	TAPPO COLONNINA LM600 INF DX	1	PZ																																														
VM2065A0	TAPPO COLONNINA LM600 INF SX	1	PZ																																														
VT1252A0	VETRO EST.XF135 NERO ENGEFOOD	1	PZ																																														
			KVT1063A	KIT VETRO ESTERNO LMISS ARIANNA FORNETTI	<table border="1"> <thead> <tr> <th>Codice</th> <th>Descrizione</th> <th>Qtà</th> <th>UM</th> </tr> </thead> <tbody> <tr> <td>IP1385A1</td> <td>IMB POL ANGOLARE 110X80X2000 D30</td> <td>0.980</td> <td>M</td> </tr> <tr> <td>IP1508A0</td> <td>POLISTIROLO PROFILO AD U 2000X60X60</td> <td>0.960</td> <td>PZ</td> </tr> <tr> <td>IP1508A1</td> <td>POLISTIROLO PROFILO AD U 2000X60X60</td> <td>0.960</td> <td>M</td> </tr> <tr> <td>MS1009A0</td> <td>ETICHETTA LOGO FORNETTI</td> <td>1</td> <td>PZ</td> </tr> <tr> <td>RC1200A0</td> <td>MOLLA A COMPRESSIO NE DE4 DF0.5 H24</td> <td>2</td> <td>PZ</td> </tr> <tr> <td>SL1050A1</td> <td>NASTRO BIADESIVO 3M TRANSFER VH</td> <td>0.820</td> <td>M</td> </tr> <tr> <td>TB2301A0</td> <td>COLONNINA DX XVC105E 40X40X1</td> <td>2</td> <td>PZ</td> </tr> <tr> <td>TB3081A0</td> <td>COLONNINA SX LM ARI-RO</td> <td>1</td> <td>PZ</td> </tr> <tr> <td>VM1025A0</td> <td>TAPPO NYLON PA66 V2 GRIGIO Ø16</td> <td>2</td> <td>PZ</td> </tr> <tr> <td>VM1059A1</td> <td>FILM TERMORETRA IBILE H800</td> <td>1.300</td> <td>M</td> </tr> </tbody> </table>	Codice	Descrizione	Qtà	UM	IP1385A1	IMB POL ANGOLARE 110X80X2000 D30	0.980	M	IP1508A0	POLISTIROLO PROFILO AD U 2000X60X60	0.960	PZ	IP1508A1	POLISTIROLO PROFILO AD U 2000X60X60	0.960	M	MS1009A0	ETICHETTA LOGO FORNETTI	1	PZ	RC1200A0	MOLLA A COMPRESSIO NE DE4 DF0.5 H24	2	PZ	SL1050A1	NASTRO BIADESIVO 3M TRANSFER VH	0.820	M	TB2301A0	COLONNINA DX XVC105E 40X40X1	2	PZ	TB3081A0	COLONNINA SX LM ARI-RO	1	PZ	VM1025A0	TAPPO NYLON PA66 V2 GRIGIO Ø16	2	PZ	VM1059A1	FILM TERMORETRA IBILE H800	1.300	M
Codice	Descrizione	Qtà	UM																																														
IP1385A1	IMB POL ANGOLARE 110X80X2000 D30	0.980	M																																														
IP1508A0	POLISTIROLO PROFILO AD U 2000X60X60	0.960	PZ																																														
IP1508A1	POLISTIROLO PROFILO AD U 2000X60X60	0.960	M																																														
MS1009A0	ETICHETTA LOGO FORNETTI	1	PZ																																														
RC1200A0	MOLLA A COMPRESSIO NE DE4 DF0.5 H24	2	PZ																																														
SL1050A1	NASTRO BIADESIVO 3M TRANSFER VH	0.820	M																																														
TB2301A0	COLONNINA DX XVC105E 40X40X1	2	PZ																																														
TB3081A0	COLONNINA SX LM ARI-RO	1	PZ																																														
VM1025A0	TAPPO NYLON PA66 V2 GRIGIO Ø16	2	PZ																																														
VM1059A1	FILM TERMORETRA IBILE H800	1.300	M																																														

COMPONENTE			RICAMBIO																																										
Codice	Descrizione	Immagine	Codice	Descrizione	Lista componenti																																								
VM2063A	TAPPO COLONNINA LM600 SUP SX		KVT1063A	KIT VETRO ESTERNO LMISS ARIANNA FORNETTI	<table border="1"> <thead> <tr> <th>Codice</th> <th>Descrizione</th> <th>Qtà</th> <th>UM</th> </tr> </thead> <tbody> <tr> <td>VM1695A0</td> <td>PERNO POSIZIONE MANIGLIA</td> <td>2</td> <td>PZ</td> </tr> <tr> <td>VM1920A0</td> <td>PIASTRINA DX CHIUSURA VETRO INT</td> <td>1</td> <td>PZ</td> </tr> <tr> <td>VM1921A0</td> <td>PIASTRINA SX CHIUSURA VETRO INT</td> <td>1</td> <td>PZ</td> </tr> <tr> <td>VM2062A0</td> <td>TAPPO COLONNINA LM600 SUP DX</td> <td>1</td> <td>PZ</td> </tr> <tr> <td>VM2063A0</td> <td>TAPPO COLONNINA LM600 SUP SX</td> <td>1</td> <td>PZ</td> </tr> <tr> <td>VM2064A0</td> <td>TAPPO COLONNINA LM600 INF DX</td> <td>1</td> <td>PZ</td> </tr> <tr> <td>VM2065A0</td> <td>TAPPO COLONNINA LM600 INF SX</td> <td>1</td> <td>PZ</td> </tr> <tr> <td>VT1063A0</td> <td>VETRO EST. 598X424 XF135F</td> <td>1</td> <td>PZ</td> </tr> </tbody> </table>	Codice	Descrizione	Qtà	UM	VM1695A0	PERNO POSIZIONE MANIGLIA	2	PZ	VM1920A0	PIASTRINA DX CHIUSURA VETRO INT	1	PZ	VM1921A0	PIASTRINA SX CHIUSURA VETRO INT	1	PZ	VM2062A0	TAPPO COLONNINA LM600 SUP DX	1	PZ	VM2063A0	TAPPO COLONNINA LM600 SUP SX	1	PZ	VM2064A0	TAPPO COLONNINA LM600 INF DX	1	PZ	VM2065A0	TAPPO COLONNINA LM600 INF SX	1	PZ	VT1063A0	VETRO EST. 598X424 XF135F	1	PZ				
Codice	Descrizione	Qtà	UM																																										
VM1695A0	PERNO POSIZIONE MANIGLIA	2	PZ																																										
VM1920A0	PIASTRINA DX CHIUSURA VETRO INT	1	PZ																																										
VM1921A0	PIASTRINA SX CHIUSURA VETRO INT	1	PZ																																										
VM2062A0	TAPPO COLONNINA LM600 SUP DX	1	PZ																																										
VM2063A0	TAPPO COLONNINA LM600 SUP SX	1	PZ																																										
VM2064A0	TAPPO COLONNINA LM600 INF DX	1	PZ																																										
VM2065A0	TAPPO COLONNINA LM600 INF SX	1	PZ																																										
VT1063A0	VETRO EST. 598X424 XF135F	1	PZ																																										
			KVT1062A	KIT VETRO ESTERNO LM ARIANNA BLACK	<table border="1"> <thead> <tr> <th>Codice</th> <th>Descrizione</th> <th>Qtà</th> <th>UM</th> </tr> </thead> <tbody> <tr> <td>IP1385A1</td> <td>IMB POL ANGOLARE 110X80X2000 D30</td> <td>1.280</td> <td>M</td> </tr> <tr> <td>RC1200A0</td> <td>MOLLA A COMPRESSIO NE DE4 DF0.5 H24</td> <td>2</td> <td>PZ</td> </tr> <tr> <td>SL1050A1</td> <td>NASTRO BIADESIVO 3M TRANSFER VH</td> <td>0.820</td> <td>M</td> </tr> <tr> <td>TB2301A0</td> <td>COLONNINA DX XVC105E 40X40X1</td> <td>2</td> <td>PZ</td> </tr> <tr> <td>TB3081A0</td> <td>COLONNINA SX LM ARI-RO</td> <td>1</td> <td>PZ</td> </tr> <tr> <td>VM1025A0</td> <td>TAPPO NYLON PA66 V2 GRIGIO Ø16</td> <td>2</td> <td>PZ</td> </tr> <tr> <td>VM1059A1</td> <td>FILM TERMORETRA IBILE H800</td> <td>1</td> <td>M</td> </tr> <tr> <td>VM1695A0</td> <td>PERNO POSIZIONE MANIGLIA</td> <td>2</td> <td>PZ</td> </tr> <tr> <td>VM1920A0</td> <td>PIASTRINA DX CHIUSURA VETRO INT</td> <td>1</td> <td>PZ</td> </tr> </tbody> </table>	Codice	Descrizione	Qtà	UM	IP1385A1	IMB POL ANGOLARE 110X80X2000 D30	1.280	M	RC1200A0	MOLLA A COMPRESSIO NE DE4 DF0.5 H24	2	PZ	SL1050A1	NASTRO BIADESIVO 3M TRANSFER VH	0.820	M	TB2301A0	COLONNINA DX XVC105E 40X40X1	2	PZ	TB3081A0	COLONNINA SX LM ARI-RO	1	PZ	VM1025A0	TAPPO NYLON PA66 V2 GRIGIO Ø16	2	PZ	VM1059A1	FILM TERMORETRA IBILE H800	1	M	VM1695A0	PERNO POSIZIONE MANIGLIA	2	PZ	VM1920A0	PIASTRINA DX CHIUSURA VETRO INT	1	PZ
Codice	Descrizione	Qtà	UM																																										
IP1385A1	IMB POL ANGOLARE 110X80X2000 D30	1.280	M																																										
RC1200A0	MOLLA A COMPRESSIO NE DE4 DF0.5 H24	2	PZ																																										
SL1050A1	NASTRO BIADESIVO 3M TRANSFER VH	0.820	M																																										
TB2301A0	COLONNINA DX XVC105E 40X40X1	2	PZ																																										
TB3081A0	COLONNINA SX LM ARI-RO	1	PZ																																										
VM1025A0	TAPPO NYLON PA66 V2 GRIGIO Ø16	2	PZ																																										
VM1059A1	FILM TERMORETRA IBILE H800	1	M																																										
VM1695A0	PERNO POSIZIONE MANIGLIA	2	PZ																																										
VM1920A0	PIASTRINA DX CHIUSURA VETRO INT	1	PZ																																										



COMPONENTE			RICAMBIO																																														
Codice	Descrizione	Immagine	Codice	Descrizione	Lista componenti																																												
VM2063A	TAPPO COLONNINA LM600 SUP SX		KVT1062A	KIT VETRO ESTERNO LM ARIANNA BLACK	<table border="1"> <thead> <tr> <th>Codice</th> <th>Descrizione</th> <th>Qtà</th> <th>UM</th> </tr> </thead> <tbody> <tr> <td>VM1921A0</td> <td>PIASTRINA SX CHIUSURA VETRO INT</td> <td>1</td> <td>PZ</td> </tr> <tr> <td>VM2062A0</td> <td>TAPPO COLONNINA LM600 SUP DX</td> <td>1</td> <td>PZ</td> </tr> <tr> <td>VM2063A0</td> <td>TAPPO COLONNINA LM600 SUP SX</td> <td>1</td> <td>PZ</td> </tr> <tr> <td>VM2064A0</td> <td>TAPPO COLONNINA LM600 INF DX</td> <td>1</td> <td>PZ</td> </tr> <tr> <td>VM2065A0</td> <td>TAPPO COLONNINA LM600 INF SX</td> <td>1</td> <td>PZ</td> </tr> <tr> <td>VT1062A0</td> <td>VETRO ESTERNO GRIGIO LINEMISS ARIANNA</td> <td>1</td> <td>PZ</td> </tr> </tbody> </table>	Codice	Descrizione	Qtà	UM	VM1921A0	PIASTRINA SX CHIUSURA VETRO INT	1	PZ	VM2062A0	TAPPO COLONNINA LM600 SUP DX	1	PZ	VM2063A0	TAPPO COLONNINA LM600 SUP SX	1	PZ	VM2064A0	TAPPO COLONNINA LM600 INF DX	1	PZ	VM2065A0	TAPPO COLONNINA LM600 INF SX	1	PZ	VT1062A0	VETRO ESTERNO GRIGIO LINEMISS ARIANNA	1	PZ																
Codice	Descrizione	Qtà	UM																																														
VM1921A0	PIASTRINA SX CHIUSURA VETRO INT	1	PZ																																														
VM2062A0	TAPPO COLONNINA LM600 SUP DX	1	PZ																																														
VM2063A0	TAPPO COLONNINA LM600 SUP SX	1	PZ																																														
VM2064A0	TAPPO COLONNINA LM600 INF DX	1	PZ																																														
VM2065A0	TAPPO COLONNINA LM600 INF SX	1	PZ																																														
VT1062A0	VETRO ESTERNO GRIGIO LINEMISS ARIANNA	1	PZ																																														
			KVT1061A	KIT VETRO ESTERNO LM ARIANNA	<table border="1"> <thead> <tr> <th>Codice</th> <th>Descrizione</th> <th>Qtà</th> <th>UM</th> </tr> </thead> <tbody> <tr> <td>IP1385A1</td> <td>IMB POL ANGOLARE 110X80X2000 D30</td> <td>1.280</td> <td>M</td> </tr> <tr> <td>RC1200A0</td> <td>MOLLA A COMPRESSIO NE DE4 DF0.5 H24</td> <td>2</td> <td>PZ</td> </tr> <tr> <td>SL1050A1</td> <td>NASTRO BIADESIVO 3M TRANSFER VH</td> <td>0.820</td> <td>M</td> </tr> <tr> <td>TB2301A0</td> <td>COLONNINA DX XVC105E 40X40X1</td> <td>2</td> <td>PZ</td> </tr> <tr> <td>VM1025A0</td> <td>TAPPO NYLON PA66 V2 GRIGIO Ø16</td> <td>2</td> <td>PZ</td> </tr> <tr> <td>VM1059A1</td> <td>FILM TERMORETRA IBILE H800</td> <td>1.300</td> <td>M</td> </tr> <tr> <td>VM1695A0</td> <td>PERNO POSIZIONE MANIGLIA</td> <td>2</td> <td>PZ</td> </tr> <tr> <td>VM1920A0</td> <td>PIASTRINA DX CHIUSURA VETRO INT</td> <td>1</td> <td>PZ</td> </tr> <tr> <td>VM1921A0</td> <td>PIASTRINA SX CHIUSURA VETRO INT</td> <td>1</td> <td>PZ</td> </tr> <tr> <td>VM2062A0</td> <td>TAPPO COLONNINA LM600 SUP DX</td> <td>1</td> <td>PZ</td> </tr> </tbody> </table>	Codice	Descrizione	Qtà	UM	IP1385A1	IMB POL ANGOLARE 110X80X2000 D30	1.280	M	RC1200A0	MOLLA A COMPRESSIO NE DE4 DF0.5 H24	2	PZ	SL1050A1	NASTRO BIADESIVO 3M TRANSFER VH	0.820	M	TB2301A0	COLONNINA DX XVC105E 40X40X1	2	PZ	VM1025A0	TAPPO NYLON PA66 V2 GRIGIO Ø16	2	PZ	VM1059A1	FILM TERMORETRA IBILE H800	1.300	M	VM1695A0	PERNO POSIZIONE MANIGLIA	2	PZ	VM1920A0	PIASTRINA DX CHIUSURA VETRO INT	1	PZ	VM1921A0	PIASTRINA SX CHIUSURA VETRO INT	1	PZ	VM2062A0	TAPPO COLONNINA LM600 SUP DX	1	PZ
Codice	Descrizione	Qtà	UM																																														
IP1385A1	IMB POL ANGOLARE 110X80X2000 D30	1.280	M																																														
RC1200A0	MOLLA A COMPRESSIO NE DE4 DF0.5 H24	2	PZ																																														
SL1050A1	NASTRO BIADESIVO 3M TRANSFER VH	0.820	M																																														
TB2301A0	COLONNINA DX XVC105E 40X40X1	2	PZ																																														
VM1025A0	TAPPO NYLON PA66 V2 GRIGIO Ø16	2	PZ																																														
VM1059A1	FILM TERMORETRA IBILE H800	1.300	M																																														
VM1695A0	PERNO POSIZIONE MANIGLIA	2	PZ																																														
VM1920A0	PIASTRINA DX CHIUSURA VETRO INT	1	PZ																																														
VM1921A0	PIASTRINA SX CHIUSURA VETRO INT	1	PZ																																														
VM2062A0	TAPPO COLONNINA LM600 SUP DX	1	PZ																																														



COMPONENTE			RICAMBIO																																																										
Codice	Descrizione	Immagine	Codice	Descrizione	Lista componenti																																																								
VM2063A	TAPPO COLONNINA LM600 SUP SX		KVT1061A	KIT VETRO ESTERNO LM ARIANNA	<table border="1"> <thead> <tr> <th>Codice</th> <th>Descrizione</th> <th>Qtà</th> <th>UM</th> </tr> </thead> <tbody> <tr> <td>VM2063A0</td> <td>TAPPO COLONNINA LM600 SUP SX</td> <td>1</td> <td>PZ</td> </tr> <tr> <td>VM2064A0</td> <td>TAPPO COLONNINA LM600 INF DX</td> <td>1</td> <td>PZ</td> </tr> <tr> <td>VM2065A0</td> <td>TAPPO COLONNINA LM600 INF SX</td> <td>1</td> <td>PZ</td> </tr> <tr> <td>VT1061A2</td> <td>VETRO ESTERNO SER. GIALLO 598X424X5</td> <td>1</td> <td>PZ</td> </tr> </tbody> </table>	Codice	Descrizione	Qtà	UM	VM2063A0	TAPPO COLONNINA LM600 SUP SX	1	PZ	VM2064A0	TAPPO COLONNINA LM600 INF DX	1	PZ	VM2065A0	TAPPO COLONNINA LM600 INF SX	1	PZ	VT1061A2	VETRO ESTERNO SER. GIALLO 598X424X5	1	PZ																																				
Codice	Descrizione	Qtà	UM																																																										
VM2063A0	TAPPO COLONNINA LM600 SUP SX	1	PZ																																																										
VM2064A0	TAPPO COLONNINA LM600 INF DX	1	PZ																																																										
VM2065A0	TAPPO COLONNINA LM600 INF SX	1	PZ																																																										
VT1061A2	VETRO ESTERNO SER. GIALLO 598X424X5	1	PZ																																																										
			KVT1057A	KIT VETRO ESTERNO NERO LMISS STEFANIA	<table border="1"> <thead> <tr> <th>Codice</th> <th>Descrizione</th> <th>Qtà</th> <th>UM</th> </tr> </thead> <tbody> <tr> <td>IP1385A1</td> <td>IMB POL ANGOLARE 110X80X2000 D30</td> <td>0.810</td> <td>M</td> </tr> <tr> <td>IP1508A0</td> <td>POLISTIROLO PROFILO AD U 2000X60X60</td> <td>0.950</td> <td>PZ</td> </tr> <tr> <td>IP1508A1</td> <td>POLISTIROLO PROFILO AD U 2000X60X60</td> <td>0.960</td> <td>M</td> </tr> <tr> <td>RC1200A0</td> <td>MOLLA A COMPRESSIO NE DE4 DF0.5 H24</td> <td>2</td> <td>PZ</td> </tr> <tr> <td>SL1050A1</td> <td>NASTRO BIADESIVO 3M TRANSFER VH</td> <td>0.660</td> <td>M</td> </tr> <tr> <td>TB2306A0</td> <td>COLONNINA DX LM STE-ELE 40X40X1</td> <td>2</td> <td>PZ</td> </tr> <tr> <td>TB3080A0</td> <td>COLONNINA SX LM STE-EL</td> <td>1</td> <td>PZ</td> </tr> <tr> <td>VM1025A0</td> <td>TAPPO NYLON PA66 V2 GRIGIO Ø16</td> <td>2</td> <td>PZ</td> </tr> <tr> <td>VM1059A1</td> <td>FILM TERMORETRA IBILE H800</td> <td>1</td> <td>M</td> </tr> <tr> <td>VM1695A0</td> <td>PERNO POSIZIONE MANIGLIA</td> <td>2</td> <td>PZ</td> </tr> <tr> <td>VM1920A0</td> <td>PIASTRINA DX CHIUSURA VETRO INT</td> <td>1</td> <td>PZ</td> </tr> <tr> <td>VM1921A0</td> <td>PIASTRINA SX CHIUSURA VETRO INT</td> <td>1</td> <td>PZ</td> </tr> <tr> <td>VM2062A0</td> <td>TAPPO COLONNINA LM600 SUP DX</td> <td>1</td> <td>PZ</td> </tr> </tbody> </table>	Codice	Descrizione	Qtà	UM	IP1385A1	IMB POL ANGOLARE 110X80X2000 D30	0.810	M	IP1508A0	POLISTIROLO PROFILO AD U 2000X60X60	0.950	PZ	IP1508A1	POLISTIROLO PROFILO AD U 2000X60X60	0.960	M	RC1200A0	MOLLA A COMPRESSIO NE DE4 DF0.5 H24	2	PZ	SL1050A1	NASTRO BIADESIVO 3M TRANSFER VH	0.660	M	TB2306A0	COLONNINA DX LM STE-ELE 40X40X1	2	PZ	TB3080A0	COLONNINA SX LM STE-EL	1	PZ	VM1025A0	TAPPO NYLON PA66 V2 GRIGIO Ø16	2	PZ	VM1059A1	FILM TERMORETRA IBILE H800	1	M	VM1695A0	PERNO POSIZIONE MANIGLIA	2	PZ	VM1920A0	PIASTRINA DX CHIUSURA VETRO INT	1	PZ	VM1921A0	PIASTRINA SX CHIUSURA VETRO INT	1	PZ	VM2062A0	TAPPO COLONNINA LM600 SUP DX	1	PZ
Codice	Descrizione	Qtà	UM																																																										
IP1385A1	IMB POL ANGOLARE 110X80X2000 D30	0.810	M																																																										
IP1508A0	POLISTIROLO PROFILO AD U 2000X60X60	0.950	PZ																																																										
IP1508A1	POLISTIROLO PROFILO AD U 2000X60X60	0.960	M																																																										
RC1200A0	MOLLA A COMPRESSIO NE DE4 DF0.5 H24	2	PZ																																																										
SL1050A1	NASTRO BIADESIVO 3M TRANSFER VH	0.660	M																																																										
TB2306A0	COLONNINA DX LM STE-ELE 40X40X1	2	PZ																																																										
TB3080A0	COLONNINA SX LM STE-EL	1	PZ																																																										
VM1025A0	TAPPO NYLON PA66 V2 GRIGIO Ø16	2	PZ																																																										
VM1059A1	FILM TERMORETRA IBILE H800	1	M																																																										
VM1695A0	PERNO POSIZIONE MANIGLIA	2	PZ																																																										
VM1920A0	PIASTRINA DX CHIUSURA VETRO INT	1	PZ																																																										
VM1921A0	PIASTRINA SX CHIUSURA VETRO INT	1	PZ																																																										
VM2062A0	TAPPO COLONNINA LM600 SUP DX	1	PZ																																																										

COMPONENTE			RICAMBIO																																																			
Codice	Descrizione	Immagine	Codice	Descrizione	Lista componenti																																																	
VM2063A	TAPPO COLONNINA LM600 SUP SX		KVT1057A	KIT VETRO ESTERNO NERO LMISS STEFANIA	<table border="1"> <thead> <tr> <th>Codice</th> <th>Descrizione</th> <th>Qtà</th> <th>UM</th> </tr> </thead> <tbody> <tr> <td>VM2063A0</td> <td>TAPPO COLONNINA LM600 SUP SX</td> <td>1</td> <td>PZ</td> </tr> <tr> <td>VM2064A0</td> <td>TAPPO COLONNINA LM600 INF DX</td> <td>1</td> <td>PZ</td> </tr> <tr> <td>VM2065A0</td> <td>TAPPO COLONNINA LM600 INF SX</td> <td>1</td> <td>PZ</td> </tr> <tr> <td>VT1057A0</td> <td>VETRO ESTERNO SER. GRIGIO 598X344X5</td> <td>1</td> <td>PZ</td> </tr> </tbody> </table>	Codice	Descrizione	Qtà	UM	VM2063A0	TAPPO COLONNINA LM600 SUP SX	1	PZ	VM2064A0	TAPPO COLONNINA LM600 INF DX	1	PZ	VM2065A0	TAPPO COLONNINA LM600 INF SX	1	PZ	VT1057A0	VETRO ESTERNO SER. GRIGIO 598X344X5	1	PZ																													
			Codice	Descrizione	Qtà	UM																																																
VM2063A0	TAPPO COLONNINA LM600 SUP SX	1	PZ																																																			
VM2064A0	TAPPO COLONNINA LM600 INF DX	1	PZ																																																			
VM2065A0	TAPPO COLONNINA LM600 INF SX	1	PZ																																																			
VT1057A0	VETRO ESTERNO SER. GRIGIO 598X344X5	1	PZ																																																			
KVT1056A	KIT VETRO ESTERNO GIALLO LMISS STEFANIA	<table border="1"> <thead> <tr> <th>Codice</th> <th>Descrizione</th> <th>Qtà</th> <th>UM</th> </tr> </thead> <tbody> <tr> <td>IP1385A1</td> <td>IMB POL ANGOLARE 110X80X2000 D30</td> <td>0.980</td> <td>M</td> </tr> <tr> <td>IP1508A0</td> <td>POLISTIROLO PROFILO AD U 2000X60X60</td> <td>0.960</td> <td>PZ</td> </tr> <tr> <td>IP1508A1</td> <td>POLISTIROLO PROFILO AD U 2000X60X60</td> <td>0.960</td> <td>M</td> </tr> <tr> <td>RC1200A0</td> <td>MOLLA A COMPRESSIO NE DE4 DF0.5 H24</td> <td>2</td> <td>PZ</td> </tr> <tr> <td>SL1050A1</td> <td>NASTRO BIADESIVO 3M TRANSFER VH</td> <td>0.660</td> <td>M</td> </tr> <tr> <td>TB2306A0</td> <td>COLONNINA DX LM STE-ELE 40X40X1</td> <td>2</td> <td>PZ</td> </tr> <tr> <td>VM1025A0</td> <td>TAPPO NYLON PA66 V2 GRIGIO Ø16</td> <td>2</td> <td>PZ</td> </tr> <tr> <td>VM1059A1</td> <td>FILM TERMORETRA IBILE H800</td> <td>1.300</td> <td>M</td> </tr> <tr> <td>VM1695A0</td> <td>PERNO POSIZIONE MANIGLIA</td> <td>2</td> <td>PZ</td> </tr> <tr> <td>VM1920A0</td> <td>PIASTRINA DX CHIUSURA VETRO INT</td> <td>1</td> <td>PZ</td> </tr> <tr> <td>VM1921A0</td> <td>PIASTRINA SX CHIUSURA VETRO INT</td> <td>1</td> <td>PZ</td> </tr> <tr> <td>VM2062A0</td> <td>TAPPO COLONNINA LM600 SUP DX</td> <td>1</td> <td>PZ</td> </tr> </tbody> </table>	Codice	Descrizione	Qtà	UM	IP1385A1	IMB POL ANGOLARE 110X80X2000 D30	0.980	M	IP1508A0	POLISTIROLO PROFILO AD U 2000X60X60	0.960	PZ	IP1508A1	POLISTIROLO PROFILO AD U 2000X60X60	0.960	M	RC1200A0	MOLLA A COMPRESSIO NE DE4 DF0.5 H24	2	PZ	SL1050A1	NASTRO BIADESIVO 3M TRANSFER VH	0.660	M	TB2306A0	COLONNINA DX LM STE-ELE 40X40X1	2	PZ	VM1025A0	TAPPO NYLON PA66 V2 GRIGIO Ø16	2	PZ	VM1059A1	FILM TERMORETRA IBILE H800	1.300	M	VM1695A0	PERNO POSIZIONE MANIGLIA	2	PZ	VM1920A0	PIASTRINA DX CHIUSURA VETRO INT	1	PZ	VM1921A0	PIASTRINA SX CHIUSURA VETRO INT	1	PZ	VM2062A0	TAPPO COLONNINA LM600 SUP DX	1	PZ
Codice	Descrizione	Qtà	UM																																																			
IP1385A1	IMB POL ANGOLARE 110X80X2000 D30	0.980	M																																																			
IP1508A0	POLISTIROLO PROFILO AD U 2000X60X60	0.960	PZ																																																			
IP1508A1	POLISTIROLO PROFILO AD U 2000X60X60	0.960	M																																																			
RC1200A0	MOLLA A COMPRESSIO NE DE4 DF0.5 H24	2	PZ																																																			
SL1050A1	NASTRO BIADESIVO 3M TRANSFER VH	0.660	M																																																			
TB2306A0	COLONNINA DX LM STE-ELE 40X40X1	2	PZ																																																			
VM1025A0	TAPPO NYLON PA66 V2 GRIGIO Ø16	2	PZ																																																			
VM1059A1	FILM TERMORETRA IBILE H800	1.300	M																																																			
VM1695A0	PERNO POSIZIONE MANIGLIA	2	PZ																																																			
VM1920A0	PIASTRINA DX CHIUSURA VETRO INT	1	PZ																																																			
VM1921A0	PIASTRINA SX CHIUSURA VETRO INT	1	PZ																																																			
VM2062A0	TAPPO COLONNINA LM600 SUP DX	1	PZ																																																			

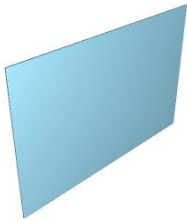
COMPONENTE			RICAMBIO																																																			
Codice	Descrizione	Immagine	Codice	Descrizione	Lista componenti																																																	
VM2063A	TAPPO COLONNINA LM600 SUP SX		KVT1056A	KIT VETRO ESTERNO GIALLO LMISS STEFANIA	<table border="1"> <thead> <tr> <th>Codice</th> <th>Descrizione</th> <th>Qtà</th> <th>UM</th> </tr> </thead> <tbody> <tr> <td>VM2063A0</td> <td>TAPPO COLONNINA LM600 SUP SX</td> <td>1</td> <td>PZ</td> </tr> <tr> <td>VM2064A0</td> <td>TAPPO COLONNINA LM600 INF DX</td> <td>1</td> <td>PZ</td> </tr> <tr> <td>VM2065A0</td> <td>TAPPO COLONNINA LM600 INF SX</td> <td>1</td> <td>PZ</td> </tr> <tr> <td>VT1056A2</td> <td>VETRO ESTERNO SER. GIALLO 598X344X5</td> <td>1</td> <td>PZ</td> </tr> </tbody> </table>	Codice	Descrizione	Qtà	UM	VM2063A0	TAPPO COLONNINA LM600 SUP SX	1	PZ	VM2064A0	TAPPO COLONNINA LM600 INF DX	1	PZ	VM2065A0	TAPPO COLONNINA LM600 INF SX	1	PZ	VT1056A2	VETRO ESTERNO SER. GIALLO 598X344X5	1	PZ																													
			Codice	Descrizione	Qtà	UM																																																
VM2063A0	TAPPO COLONNINA LM600 SUP SX	1	PZ																																																			
VM2064A0	TAPPO COLONNINA LM600 INF DX	1	PZ																																																			
VM2065A0	TAPPO COLONNINA LM600 INF SX	1	PZ																																																			
VT1056A2	VETRO ESTERNO SER. GIALLO 598X344X5	1	PZ																																																			
KVT1052A	KIT VETRO ESTERNO NERO LINEMISS CRISTINA	<table border="1"> <thead> <tr> <th>Codice</th> <th>Descrizione</th> <th>Qtà</th> <th>UM</th> </tr> </thead> <tbody> <tr> <td>RC1200A0</td> <td>MOLLA A COMPRESSIO NE DE4 DF0.5 H24</td> <td>2</td> <td>PZ</td> </tr> <tr> <td>SL1050A1</td> <td>NASTRO BIADESIVO 3M TRANSFER VH</td> <td>0.660</td> <td>M</td> </tr> <tr> <td>TB2306A0</td> <td>COLONNINA DX LM STE-ELE 40X40X1</td> <td>2</td> <td>PZ</td> </tr> <tr> <td>VM1025A0</td> <td>TAPPO NYLON PA66 V2 GRIGIO Ø16</td> <td>2</td> <td>PZ</td> </tr> <tr> <td>VM1695A0</td> <td>PERNO POSIZIONE MANIGLIA</td> <td>2</td> <td>PZ</td> </tr> <tr> <td>VM1920A0</td> <td>PIASTRINA DX CHIUSURA VETRO INT</td> <td>1</td> <td>PZ</td> </tr> <tr> <td>VM1921A0</td> <td>PIASTRINA SX CHIUSURA VETRO INT</td> <td>1</td> <td>PZ</td> </tr> <tr> <td>VM2062A0</td> <td>TAPPO COLONNINA LM600 SUP DX</td> <td>1</td> <td>PZ</td> </tr> <tr> <td>VM2063A0</td> <td>TAPPO COLONNINA LM600 SUP SX</td> <td>1</td> <td>PZ</td> </tr> <tr> <td>VM2064A0</td> <td>TAPPO COLONNINA LM600 INF DX</td> <td>1</td> <td>PZ</td> </tr> <tr> <td>VM2065A0</td> <td>TAPPO COLONNINA LM600 INF SX</td> <td>1</td> <td>PZ</td> </tr> <tr> <td>VT1052A0</td> <td>VETRO ESTERNO SER. GRIGIO 478X344X5</td> <td>1</td> <td>PZ</td> </tr> </tbody> </table>	Codice	Descrizione	Qtà	UM	RC1200A0	MOLLA A COMPRESSIO NE DE4 DF0.5 H24	2	PZ	SL1050A1	NASTRO BIADESIVO 3M TRANSFER VH	0.660	M	TB2306A0	COLONNINA DX LM STE-ELE 40X40X1	2	PZ	VM1025A0	TAPPO NYLON PA66 V2 GRIGIO Ø16	2	PZ	VM1695A0	PERNO POSIZIONE MANIGLIA	2	PZ	VM1920A0	PIASTRINA DX CHIUSURA VETRO INT	1	PZ	VM1921A0	PIASTRINA SX CHIUSURA VETRO INT	1	PZ	VM2062A0	TAPPO COLONNINA LM600 SUP DX	1	PZ	VM2063A0	TAPPO COLONNINA LM600 SUP SX	1	PZ	VM2064A0	TAPPO COLONNINA LM600 INF DX	1	PZ	VM2065A0	TAPPO COLONNINA LM600 INF SX	1	PZ	VT1052A0	VETRO ESTERNO SER. GRIGIO 478X344X5	1	PZ
Codice	Descrizione	Qtà	UM																																																			
RC1200A0	MOLLA A COMPRESSIO NE DE4 DF0.5 H24	2	PZ																																																			
SL1050A1	NASTRO BIADESIVO 3M TRANSFER VH	0.660	M																																																			
TB2306A0	COLONNINA DX LM STE-ELE 40X40X1	2	PZ																																																			
VM1025A0	TAPPO NYLON PA66 V2 GRIGIO Ø16	2	PZ																																																			
VM1695A0	PERNO POSIZIONE MANIGLIA	2	PZ																																																			
VM1920A0	PIASTRINA DX CHIUSURA VETRO INT	1	PZ																																																			
VM1921A0	PIASTRINA SX CHIUSURA VETRO INT	1	PZ																																																			
VM2062A0	TAPPO COLONNINA LM600 SUP DX	1	PZ																																																			
VM2063A0	TAPPO COLONNINA LM600 SUP SX	1	PZ																																																			
VM2064A0	TAPPO COLONNINA LM600 INF DX	1	PZ																																																			
VM2065A0	TAPPO COLONNINA LM600 INF SX	1	PZ																																																			
VT1052A0	VETRO ESTERNO SER. GRIGIO 478X344X5	1	PZ																																																			

COMPONENTE			RICAMBIO																																																														
Codice	Descrizione	Immagine	Codice	Descrizione	Lista componenti																																																												
VM2063A	TAPPO COLONNINA LM600 SUP SX		KVT1051A	KIT VETRO ESTERNO GIALLO L.MISS CRISTINA	<table border="1"> <thead> <tr> <th>Codice</th> <th>Descrizione</th> <th>Qtà</th> <th>UM</th> </tr> </thead> <tbody> <tr> <td>IP1385A1</td> <td>IMB POL ANGOLARE 110X80X2000 D30</td> <td>1.040</td> <td>M</td> </tr> <tr> <td>RC1200A0</td> <td>MOLLA A COMPRESSIO NE DE4 DF0.5 H24</td> <td>2</td> <td>PZ</td> </tr> <tr> <td>SL1050A1</td> <td>NASTRO BIADESIVO 3M TRANSFER VH</td> <td>0.660</td> <td>M</td> </tr> <tr> <td>TB2306A0</td> <td>COLONNINA DX LM STE-ELE 40X40X1</td> <td>2</td> <td>PZ</td> </tr> <tr> <td>VM1025A0</td> <td>TAPPO NYLON PA66 V2 GRIGIO Ø16</td> <td>2</td> <td>PZ</td> </tr> <tr> <td>VM1059A1</td> <td>FILM TERMORETRA IBILE H800</td> <td>1.500</td> <td>M</td> </tr> <tr> <td>VM1695A0</td> <td>PERNO POSIZIONE MANIGLIA</td> <td>2</td> <td>PZ</td> </tr> <tr> <td>VM1920A0</td> <td>PIASTRINA DX CHIUSURA VETRO INT</td> <td>1</td> <td>PZ</td> </tr> <tr> <td>VM1921A0</td> <td>PIASTRINA SX CHIUSURA VETRO INT</td> <td>1</td> <td>PZ</td> </tr> <tr> <td>VM2062A0</td> <td>TAPPO COLONNINA LM600 SUP DX</td> <td>1</td> <td>PZ</td> </tr> <tr> <td>VM2063A0</td> <td>TAPPO COLONNINA LM600 SUP SX</td> <td>1</td> <td>PZ</td> </tr> <tr> <td>VM2064A0</td> <td>TAPPO COLONNINA LM600 INF DX</td> <td>1</td> <td>PZ</td> </tr> <tr> <td>VM2065A0</td> <td>TAPPO COLONNINA LM600 INF SX</td> <td>1</td> <td>PZ</td> </tr> <tr> <td>VT1051A2</td> <td>VETRO ESTERNO SER. GIALLO 478X344X5</td> <td>1</td> <td>PZ</td> </tr> </tbody> </table>	Codice	Descrizione	Qtà	UM	IP1385A1	IMB POL ANGOLARE 110X80X2000 D30	1.040	M	RC1200A0	MOLLA A COMPRESSIO NE DE4 DF0.5 H24	2	PZ	SL1050A1	NASTRO BIADESIVO 3M TRANSFER VH	0.660	M	TB2306A0	COLONNINA DX LM STE-ELE 40X40X1	2	PZ	VM1025A0	TAPPO NYLON PA66 V2 GRIGIO Ø16	2	PZ	VM1059A1	FILM TERMORETRA IBILE H800	1.500	M	VM1695A0	PERNO POSIZIONE MANIGLIA	2	PZ	VM1920A0	PIASTRINA DX CHIUSURA VETRO INT	1	PZ	VM1921A0	PIASTRINA SX CHIUSURA VETRO INT	1	PZ	VM2062A0	TAPPO COLONNINA LM600 SUP DX	1	PZ	VM2063A0	TAPPO COLONNINA LM600 SUP SX	1	PZ	VM2064A0	TAPPO COLONNINA LM600 INF DX	1	PZ	VM2065A0	TAPPO COLONNINA LM600 INF SX	1	PZ	VT1051A2	VETRO ESTERNO SER. GIALLO 478X344X5	1	PZ
Codice	Descrizione	Qtà	UM																																																														
IP1385A1	IMB POL ANGOLARE 110X80X2000 D30	1.040	M																																																														
RC1200A0	MOLLA A COMPRESSIO NE DE4 DF0.5 H24	2	PZ																																																														
SL1050A1	NASTRO BIADESIVO 3M TRANSFER VH	0.660	M																																																														
TB2306A0	COLONNINA DX LM STE-ELE 40X40X1	2	PZ																																																														
VM1025A0	TAPPO NYLON PA66 V2 GRIGIO Ø16	2	PZ																																																														
VM1059A1	FILM TERMORETRA IBILE H800	1.500	M																																																														
VM1695A0	PERNO POSIZIONE MANIGLIA	2	PZ																																																														
VM1920A0	PIASTRINA DX CHIUSURA VETRO INT	1	PZ																																																														
VM1921A0	PIASTRINA SX CHIUSURA VETRO INT	1	PZ																																																														
VM2062A0	TAPPO COLONNINA LM600 SUP DX	1	PZ																																																														
VM2063A0	TAPPO COLONNINA LM600 SUP SX	1	PZ																																																														
VM2064A0	TAPPO COLONNINA LM600 INF DX	1	PZ																																																														
VM2065A0	TAPPO COLONNINA LM600 INF SX	1	PZ																																																														
VT1051A2	VETRO ESTERNO SER. GIALLO 478X344X5	1	PZ																																																														

COMPONENTE			RICAMBIO																																						
Codice	Descrizione	Immagine	Codice	Descrizione	Lista componenti																																				
VT1055A	VETRO INTERNO 515X334X4 BETFL		KVT1055A	KIT VETRO INTERNO LM STEFANIA VT1055A	<table border="1"> <thead> <tr> <th>Codice</th> <th>Descrizione</th> <th>Qtà</th> <th>UM</th> </tr> </thead> <tbody> <tr> <td>ED1011A0</td> <td>ETICHETTA VETRO LATO BASSO EMISSIVO</td> <td>1</td> <td>PZ</td> </tr> <tr> <td>ED1235A0</td> <td>ETICHETTA VETRO INTERNO PER RICAMBI</td> <td>1</td> <td>PZ</td> </tr> <tr> <td>GN1130A0</td> <td>GUARNIZIONE SUPPORTO VETRO L.M. L=23MM</td> <td>4</td> <td>PZ</td> </tr> <tr> <td>IP1508A0</td> <td>POLISTIROLO PROFILO AD U 2000X60X60</td> <td>1.700</td> <td>PZ</td> </tr> <tr> <td>IP1508A1</td> <td>POLISTIROLO PROFILO AD U 2000X60X60</td> <td>2</td> <td>M</td> </tr> <tr> <td>VM1059A1</td> <td>FILM TERMORETRA IBILE H800</td> <td>1.300</td> <td>M</td> </tr> <tr> <td>VT1055A0</td> <td>VETRO INTERNO 515X334X4 BETFL</td> <td>1</td> <td>PZ</td> </tr> </tbody> </table>	Codice	Descrizione	Qtà	UM	ED1011A0	ETICHETTA VETRO LATO BASSO EMISSIVO	1	PZ	ED1235A0	ETICHETTA VETRO INTERNO PER RICAMBI	1	PZ	GN1130A0	GUARNIZIONE SUPPORTO VETRO L.M. L=23MM	4	PZ	IP1508A0	POLISTIROLO PROFILO AD U 2000X60X60	1.700	PZ	IP1508A1	POLISTIROLO PROFILO AD U 2000X60X60	2	M	VM1059A1	FILM TERMORETRA IBILE H800	1.300	M	VT1055A0	VETRO INTERNO 515X334X4 BETFL	1	PZ				
Codice	Descrizione	Qtà	UM																																						
ED1011A0	ETICHETTA VETRO LATO BASSO EMISSIVO	1	PZ																																						
ED1235A0	ETICHETTA VETRO INTERNO PER RICAMBI	1	PZ																																						
GN1130A0	GUARNIZIONE SUPPORTO VETRO L.M. L=23MM	4	PZ																																						
IP1508A0	POLISTIROLO PROFILO AD U 2000X60X60	1.700	PZ																																						
IP1508A1	POLISTIROLO PROFILO AD U 2000X60X60	2	M																																						
VM1059A1	FILM TERMORETRA IBILE H800	1.300	M																																						
VT1055A0	VETRO INTERNO 515X334X4 BETFL	1	PZ																																						
VT1057A	VETRO ESTERNO SER. GRIGIO 598X344X5		KVT1057A	KIT VETRO ESTERNO NERO LMISS STEFANIA	<table border="1"> <thead> <tr> <th>Codice</th> <th>Descrizione</th> <th>Qtà</th> <th>UM</th> </tr> </thead> <tbody> <tr> <td>IP1385A1</td> <td>IMB POL ANGOLARE 110X80X2000 D30</td> <td>0.810</td> <td>M</td> </tr> <tr> <td>IP1508A0</td> <td>POLISTIROLO PROFILO AD U 2000X60X60</td> <td>0.950</td> <td>PZ</td> </tr> <tr> <td>IP1508A1</td> <td>POLISTIROLO PROFILO AD U 2000X60X60</td> <td>0.960</td> <td>M</td> </tr> <tr> <td>RC1200A0</td> <td>MOLLA A COMPRESSIO NE DE4 DF0.5 H24</td> <td>2</td> <td>PZ</td> </tr> <tr> <td>SL1050A1</td> <td>NASTRO BIADESIVO 3M TRANSFER VH</td> <td>0.660</td> <td>M</td> </tr> <tr> <td>TB2306A0</td> <td>COLONNINA DX LM STE-ELE 40X40X1</td> <td>2</td> <td>PZ</td> </tr> <tr> <td>TB3080A0</td> <td>COLONNINA SX LM STE-EL</td> <td>1</td> <td>PZ</td> </tr> <tr> <td>VM1025A0</td> <td>TAPPO NYLON PA66 V2 GRIGIO Ø16</td> <td>2</td> <td>PZ</td> </tr> </tbody> </table>	Codice	Descrizione	Qtà	UM	IP1385A1	IMB POL ANGOLARE 110X80X2000 D30	0.810	M	IP1508A0	POLISTIROLO PROFILO AD U 2000X60X60	0.950	PZ	IP1508A1	POLISTIROLO PROFILO AD U 2000X60X60	0.960	M	RC1200A0	MOLLA A COMPRESSIO NE DE4 DF0.5 H24	2	PZ	SL1050A1	NASTRO BIADESIVO 3M TRANSFER VH	0.660	M	TB2306A0	COLONNINA DX LM STE-ELE 40X40X1	2	PZ	TB3080A0	COLONNINA SX LM STE-EL	1	PZ	VM1025A0	TAPPO NYLON PA66 V2 GRIGIO Ø16	2	PZ
Codice	Descrizione	Qtà	UM																																						
IP1385A1	IMB POL ANGOLARE 110X80X2000 D30	0.810	M																																						
IP1508A0	POLISTIROLO PROFILO AD U 2000X60X60	0.950	PZ																																						
IP1508A1	POLISTIROLO PROFILO AD U 2000X60X60	0.960	M																																						
RC1200A0	MOLLA A COMPRESSIO NE DE4 DF0.5 H24	2	PZ																																						
SL1050A1	NASTRO BIADESIVO 3M TRANSFER VH	0.660	M																																						
TB2306A0	COLONNINA DX LM STE-ELE 40X40X1	2	PZ																																						
TB3080A0	COLONNINA SX LM STE-EL	1	PZ																																						
VM1025A0	TAPPO NYLON PA66 V2 GRIGIO Ø16	2	PZ																																						



COMPONENTE			RICAMBIO																																										
Codice	Descrizione	Immagine	Codice	Descrizione	Lista componenti																																								
VT1057A	VETRO ESTERNO SER. GRIGIO 598X344X5		KVT1057A	KIT VETRO ESTERNO NERO LMISS STEFANIA	<table border="1"> <thead> <tr> <th>Codice</th> <th>Descrizione</th> <th>Qtà</th> <th>UM</th> </tr> </thead> <tbody> <tr> <td>VM1059A1</td> <td>FILM TERMORETRA IBILE H800</td> <td>1</td> <td>M</td> </tr> <tr> <td>VM1695A0</td> <td>PERNO POSIZIONE MANIGLIA</td> <td>2</td> <td>PZ</td> </tr> <tr> <td>VM1920A0</td> <td>PIASTRINA DX CHIUSURA VETRO INT</td> <td>1</td> <td>PZ</td> </tr> <tr> <td>VM1921A0</td> <td>PIASTRINA SX CHIUSURA VETRO INT</td> <td>1</td> <td>PZ</td> </tr> <tr> <td>VM2062A0</td> <td>TAPPO COLONNINA LM600 SUP DX</td> <td>1</td> <td>PZ</td> </tr> <tr> <td>VM2063A0</td> <td>TAPPO COLONNINA LM600 SUP SX</td> <td>1</td> <td>PZ</td> </tr> <tr> <td>VM2064A0</td> <td>TAPPO COLONNINA LM600 INF DX</td> <td>1</td> <td>PZ</td> </tr> <tr> <td>VM2065A0</td> <td>TAPPO COLONNINA LM600 INF SX</td> <td>1</td> <td>PZ</td> </tr> <tr> <td>VT1057A0</td> <td>VETRO ESTERNO SER. GRIGIO 598X344X5</td> <td>1</td> <td>PZ</td> </tr> </tbody> </table>	Codice	Descrizione	Qtà	UM	VM1059A1	FILM TERMORETRA IBILE H800	1	M	VM1695A0	PERNO POSIZIONE MANIGLIA	2	PZ	VM1920A0	PIASTRINA DX CHIUSURA VETRO INT	1	PZ	VM1921A0	PIASTRINA SX CHIUSURA VETRO INT	1	PZ	VM2062A0	TAPPO COLONNINA LM600 SUP DX	1	PZ	VM2063A0	TAPPO COLONNINA LM600 SUP SX	1	PZ	VM2064A0	TAPPO COLONNINA LM600 INF DX	1	PZ	VM2065A0	TAPPO COLONNINA LM600 INF SX	1	PZ	VT1057A0	VETRO ESTERNO SER. GRIGIO 598X344X5	1	PZ
Codice	Descrizione	Qtà	UM																																										
VM1059A1	FILM TERMORETRA IBILE H800	1	M																																										
VM1695A0	PERNO POSIZIONE MANIGLIA	2	PZ																																										
VM1920A0	PIASTRINA DX CHIUSURA VETRO INT	1	PZ																																										
VM1921A0	PIASTRINA SX CHIUSURA VETRO INT	1	PZ																																										
VM2062A0	TAPPO COLONNINA LM600 SUP DX	1	PZ																																										
VM2063A0	TAPPO COLONNINA LM600 SUP SX	1	PZ																																										
VM2064A0	TAPPO COLONNINA LM600 INF DX	1	PZ																																										
VM2065A0	TAPPO COLONNINA LM600 INF SX	1	PZ																																										
VT1057A0	VETRO ESTERNO SER. GRIGIO 598X344X5	1	PZ																																										
CR1010A	CERNIERA PORTA RIBALTA LINEMISS STEFANIA		KCR1010A	KIT CERNIERE LINEMISS STEFANIA	<table border="1"> <thead> <tr> <th>Codice</th> <th>Descrizione</th> <th>Qtà</th> <th>UM</th> </tr> </thead> <tbody> <tr> <td>CR1010A0</td> <td>CERNIERA PORTA RIBALTA LINEMISS STEFANIA</td> <td>2</td> <td>PZ</td> </tr> <tr> <td>VI1875A0</td> <td>VITE M5X10 TC1/2T INOX</td> <td>6</td> <td>PZ</td> </tr> </tbody> </table>	Codice	Descrizione	Qtà	UM	CR1010A0	CERNIERA PORTA RIBALTA LINEMISS STEFANIA	2	PZ	VI1875A0	VITE M5X10 TC1/2T INOX	6	PZ																												
Codice	Descrizione	Qtà	UM																																										
CR1010A0	CERNIERA PORTA RIBALTA LINEMISS STEFANIA	2	PZ																																										
VI1875A0	VITE M5X10 TC1/2T INOX	6	PZ																																										
LP1036A	BARRA LED E200 L100 LM COMPLETA		KLP1036A	KIT BARRA LED L200 LMISS	<table border="1"> <thead> <tr> <th>Codice</th> <th>Descrizione</th> <th>Qtà</th> <th>UM</th> </tr> </thead> <tbody> <tr> <td>IP1385A1</td> <td>IMB POL ANGOLARE 110X80X2000 D30</td> <td>0.700</td> <td>M</td> </tr> <tr> <td>LP1030A0</td> <td>BARRA ILLUMINAZION E LED MM L200 E468</td> <td>1</td> <td>PZ</td> </tr> <tr> <td>LP1036A2</td> <td>BARRA LED E200 L200 LM-LUX COMPLETA</td> <td>1</td> <td>PZ</td> </tr> <tr> <td>VM1058A1</td> <td>FILM TERMORETRA IBILE H410</td> <td>0.700</td> <td>M</td> </tr> <tr> <td>VM1059A1</td> <td>FILM TERMORETRA IBILE H800</td> <td>0.700</td> <td>M</td> </tr> </tbody> </table>	Codice	Descrizione	Qtà	UM	IP1385A1	IMB POL ANGOLARE 110X80X2000 D30	0.700	M	LP1030A0	BARRA ILLUMINAZION E LED MM L200 E468	1	PZ	LP1036A2	BARRA LED E200 L200 LM-LUX COMPLETA	1	PZ	VM1058A1	FILM TERMORETRA IBILE H410	0.700	M	VM1059A1	FILM TERMORETRA IBILE H800	0.700	M																
Codice	Descrizione	Qtà	UM																																										
IP1385A1	IMB POL ANGOLARE 110X80X2000 D30	0.700	M																																										
LP1030A0	BARRA ILLUMINAZION E LED MM L200 E468	1	PZ																																										
LP1036A2	BARRA LED E200 L200 LM-LUX COMPLETA	1	PZ																																										
VM1058A1	FILM TERMORETRA IBILE H410	0.700	M																																										
VM1059A1	FILM TERMORETRA IBILE H800	0.700	M																																										

ASM2087E/0.D00 - Impianto elettrico

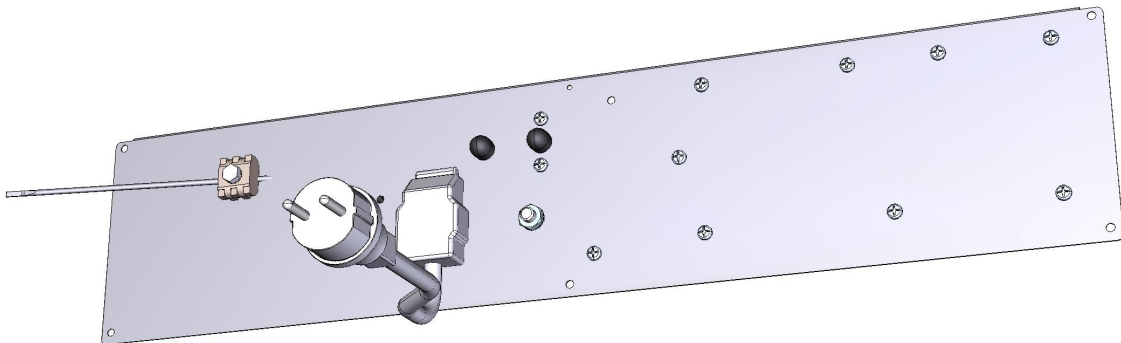
RETRO

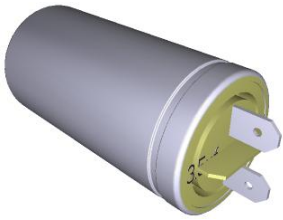

COMPONENTE			RICAMBIO																						
Codice	Descrizione	Immagine	Codice	Descrizione	Lista componenti																				
VE1115A	MINICONTATTORE QUADRIPOLORE 20 A 230V		KVE1115A	KIT MINICONTATTORE QUADRIPOLORE 20A 230V	<table border="1"> <thead> <tr> <th>Codice</th> <th>Descrizione</th> <th>Qtà</th> <th>UM</th> </tr> </thead> <tbody> <tr> <td>VE1115A0</td> <td>MINICONTATT ORE QUADRIPOLORE 20 A 230V</td> <td>1</td> <td>PZ</td> </tr> <tr> <td>VM1075A1</td> <td>CLIP DI FISSAGGIO PER TELERUTTORI</td> <td>4</td> <td>PZ</td> </tr> </tbody> </table>	Codice	Descrizione	Qtà	UM	VE1115A0	MINICONTATT ORE QUADRIPOLORE 20 A 230V	1	PZ	VM1075A1	CLIP DI FISSAGGIO PER TELERUTTORI	4	PZ								
Codice	Descrizione	Qtà	UM																						
VE1115A0	MINICONTATT ORE QUADRIPOLORE 20 A 230V	1	PZ																						
VM1075A1	CLIP DI FISSAGGIO PER TELERUTTORI	4	PZ																						
VM1056A	STAFFA TELERUTTORE PICCOLO VE1115A		VM1056A0	STAFFA TELERUTTORE PICCOLO VE1115A																					
VM1750A	MORSETTO A PETTINE		KVM1750A	KIT MORSETTIERA A PETTINE	<table border="1"> <thead> <tr> <th>Codice</th> <th>Descrizione</th> <th>Qtà</th> <th>UM</th> </tr> </thead> <tbody> <tr> <td>VM1750A0</td> <td>MORSETTO A PETTINE</td> <td>1</td> <td>PZ</td> </tr> </tbody> </table>	Codice	Descrizione	Qtà	UM	VM1750A0	MORSETTO A PETTINE	1	PZ												
Codice	Descrizione	Qtà	UM																						
VM1750A0	MORSETTO A PETTINE	1	PZ																						
PE1983B	SCHEDA POTENZA 230V LM DYNAMIC/CLASSIC		KPE1983B	KIT SCHEDA POTENZA 230V LMISS	<table border="1"> <thead> <tr> <th>Codice</th> <th>Descrizione</th> <th>Qtà</th> <th>UM</th> </tr> </thead> <tbody> <tr> <td>PE1983B0</td> <td>SCHEDA POTENZA 230V LM DYNAMIC/CLASSIC</td> <td>1</td> <td>PZ</td> </tr> <tr> <td>V11850A0</td> <td>VITE M4X6 TCB+ NICHELATA</td> <td>7</td> <td>PZ</td> </tr> <tr> <td>VM1745A0</td> <td>SUPPORTO PER SCHEDA</td> <td>6</td> <td>PZ</td> </tr> <tr> <td>VM2147A0</td> <td>SPUGNA ESD ROSA LISCIA 410X343X15 M</td> <td>1</td> <td>PZ</td> </tr> </tbody> </table>	Codice	Descrizione	Qtà	UM	PE1983B0	SCHEDA POTENZA 230V LM DYNAMIC/CLASSIC	1	PZ	V11850A0	VITE M4X6 TCB+ NICHELATA	7	PZ	VM1745A0	SUPPORTO PER SCHEDA	6	PZ	VM2147A0	SPUGNA ESD ROSA LISCIA 410X343X15 M	1	PZ
Codice	Descrizione	Qtà	UM																						
PE1983B0	SCHEDA POTENZA 230V LM DYNAMIC/CLASSIC	1	PZ																						
V11850A0	VITE M4X6 TCB+ NICHELATA	7	PZ																						
VM1745A0	SUPPORTO PER SCHEDA	6	PZ																						
VM2147A0	SPUGNA ESD ROSA LISCIA 410X343X15 M	1	PZ																						
MR1000A	CAVO 3X1,5 H07RN-F MT1,5+K2/3+SCHUK		KMR1000A	KIT CAVO 3X1,5 H07RN-F MT1,5+K2/3+SCHUK	<table border="1"> <thead> <tr> <th>Codice</th> <th>Descrizione</th> <th>Qtà</th> <th>UM</th> </tr> </thead> <tbody> <tr> <td>MR1000A0</td> <td>CAVO 3X1,5 H07RN-F MT1,5+K2/3+SCHUKO</td> <td>1</td> <td>PZ</td> </tr> </tbody> </table>	Codice	Descrizione	Qtà	UM	MR1000A0	CAVO 3X1,5 H07RN-F MT1,5+K2/3+SCHUKO	1	PZ												
Codice	Descrizione	Qtà	UM																						
MR1000A0	CAVO 3X1,5 H07RN-F MT1,5+K2/3+SCHUKO	1	PZ																						

COMPONENTE			RICAMBIO																		
Codice	Descrizione	Immagine	Codice	Descrizione	Lista componenti																
CN1010A	CONDENSATORE 3,5?F 450V, CE/UL, CLASSE P		KVE1145A	KIT CONDENSATOR	<table border="1"> <thead> <tr> <th>Codice</th> <th>Descrizione</th> <th>Qtà</th> <th>UM</th> </tr> </thead> <tbody> <tr> <td>CN1010A0</td> <td>CONDENSATO RE 3,5?F 450V, CE/UL, CLASSE P</td> <td>1</td> <td>PZ</td> </tr> <tr> <td>VI1931A0</td> <td>DADO M8X1.65 H4 CH13 ZINCATO</td> <td>1</td> <td>PZ</td> </tr> <tr> <td>VI1932A0</td> <td>RONDELLA DENTELLATA D8 ZINCATA</td> <td>1</td> <td>PZ</td> </tr> </tbody> </table>	Codice	Descrizione	Qtà	UM	CN1010A0	CONDENSATO RE 3,5?F 450V, CE/UL, CLASSE P	1	PZ	VI1931A0	DADO M8X1.65 H4 CH13 ZINCATO	1	PZ	VI1932A0	RONDELLA DENTELLATA D8 ZINCATA	1	PZ
			Codice	Descrizione	Qtà	UM															
			CN1010A0	CONDENSATO RE 3,5?F 450V, CE/UL, CLASSE P	1	PZ															
VI1931A0	DADO M8X1.65 H4 CH13 ZINCATO	1	PZ																		
VI1932A0	RONDELLA DENTELLATA D8 ZINCATA	1	PZ																		
KCN1010A	KIT CONDENSATORE 3.5UF CN1010A	<table border="1"> <thead> <tr> <th>Codice</th> <th>Descrizione</th> <th>Qtà</th> <th>UM</th> </tr> </thead> <tbody> <tr> <td>CN1010A0</td> <td>CONDENSATO RE 3,5?F 450V, CE/UL, CLASSE P</td> <td>1</td> <td>PZ</td> </tr> <tr> <td>VI1931A0</td> <td>DADO M8X1.65 H4 CH13 ZINCATO</td> <td>1</td> <td>PZ</td> </tr> <tr> <td>VI1932A0</td> <td>RONDELLA DENTELLATA D8 ZINCATA</td> <td>1</td> <td>PZ</td> </tr> </tbody> </table>	Codice	Descrizione	Qtà	UM	CN1010A0	CONDENSATO RE 3,5?F 450V, CE/UL, CLASSE P	1	PZ	VI1931A0	DADO M8X1.65 H4 CH13 ZINCATO	1	PZ	VI1932A0	RONDELLA DENTELLATA D8 ZINCATA	1	PZ			
Codice	Descrizione	Qtà	UM																		
CN1010A0	CONDENSATO RE 3,5?F 450V, CE/UL, CLASSE P	1	PZ																		
VI1931A0	DADO M8X1.65 H4 CH13 ZINCATO	1	PZ																		
VI1932A0	RONDELLA DENTELLATA D8 ZINCATA	1	PZ																		
KCN1003A	KIT CONDENSATORE MOTORE 6,3 UF	<table border="1"> <thead> <tr> <th>Codice</th> <th>Descrizione</th> <th>Qtà</th> <th>UM</th> </tr> </thead> <tbody> <tr> <td>CN1003A0</td> <td>CONDENSATO RE CORAZZATO 6,3 UF</td> <td>1</td> <td>PZ</td> </tr> <tr> <td>VI1931A0</td> <td>DADO M8X1.65 H4 CH13 ZINCATO</td> <td>1</td> <td>PZ</td> </tr> <tr> <td>VI1932A0</td> <td>RONDELLA DENTELLATA D8 ZINCATA</td> <td>1</td> <td>PZ</td> </tr> </tbody> </table>	Codice	Descrizione	Qtà	UM	CN1003A0	CONDENSATO RE CORAZZATO 6,3 UF	1	PZ	VI1931A0	DADO M8X1.65 H4 CH13 ZINCATO	1	PZ	VI1932A0	RONDELLA DENTELLATA D8 ZINCATA	1	PZ			
Codice	Descrizione	Qtà	UM																		
CN1003A0	CONDENSATO RE CORAZZATO 6,3 UF	1	PZ																		
VI1931A0	DADO M8X1.65 H4 CH13 ZINCATO	1	PZ																		
VI1932A0	RONDELLA DENTELLATA D8 ZINCATA	1	PZ																		
TR1140A	TERM.SIC.BIP. 350°C RIARMO MANUALE		KTR1140A	KIT TERMOSTATO SICUREZZA BIPOLARE	<table border="1"> <thead> <tr> <th>Codice</th> <th>Descrizione</th> <th>Qtà</th> <th>UM</th> </tr> </thead> <tbody> <tr> <td>TR1140A0</td> <td>TERM.SIC.BIP. 350°C RIARMO MANUALE</td> <td>1</td> <td>PZ</td> </tr> </tbody> </table>	Codice	Descrizione	Qtà	UM	TR1140A0	TERM.SIC.BIP. 350°C RIARMO MANUALE	1	PZ								
Codice	Descrizione	Qtà	UM																		
TR1140A0	TERM.SIC.BIP. 350°C RIARMO MANUALE	1	PZ																		

COMPONENTE			RICAMBIO														
Codice	Descrizione	Immagine	Codice	Descrizione	Lista componenti												
PE1781A	ALIMENTATORE 200-240VAC 12VCC 1,5VA		KPE1781A	KIT ALIMENTATORE 200-240VAC 12VCC 1.5VA	<table border="1"> <thead> <tr> <th>Codice</th> <th>Descrizione</th> <th>Qtà</th> <th>UM</th> </tr> </thead> <tbody> <tr> <td>PE1781A0</td> <td>ALIMENTATORE 200-240VAC 12VCC 1,5VA</td> <td>1</td> <td>PZ</td> </tr> <tr> <td>VM1745A0</td> <td>SUPPORTO PER SCHEDA</td> <td>4</td> <td>PZ</td> </tr> </tbody> </table>	Codice	Descrizione	Qtà	UM	PE1781A0	ALIMENTATORE 200-240VAC 12VCC 1,5VA	1	PZ	VM1745A0	SUPPORTO PER SCHEDA	4	PZ
Codice	Descrizione	Qtà	UM														
PE1781A0	ALIMENTATORE 200-240VAC 12VCC 1,5VA	1	PZ														
VM1745A0	SUPPORTO PER SCHEDA	4	PZ														
0H6524D	PORTACOMPONENTI LMISS600 CLASSI		0H6524D0	PORTACOMPONENTI LMISS600 CLASSI													