







Assembly code	Assembly revision	Assembly image
ASM3069A/0.D04	Electrical system	
ASM1771C/0.D00	External cover	
ASM1745B/0.D05	Cooking chamber	
ASM3007B/0.D01	Door	



**ASM3069A/0.D04 - Electrical system**

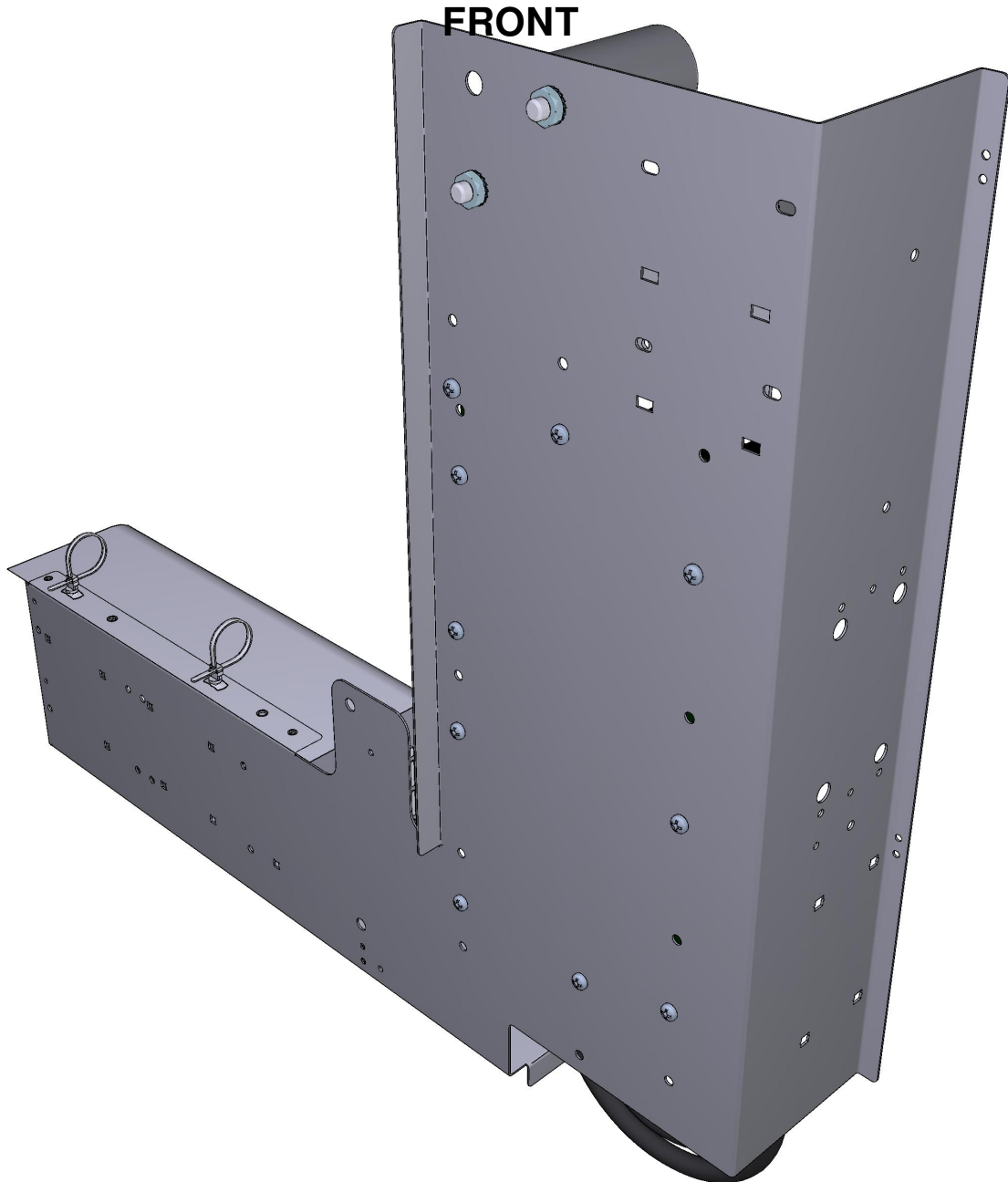

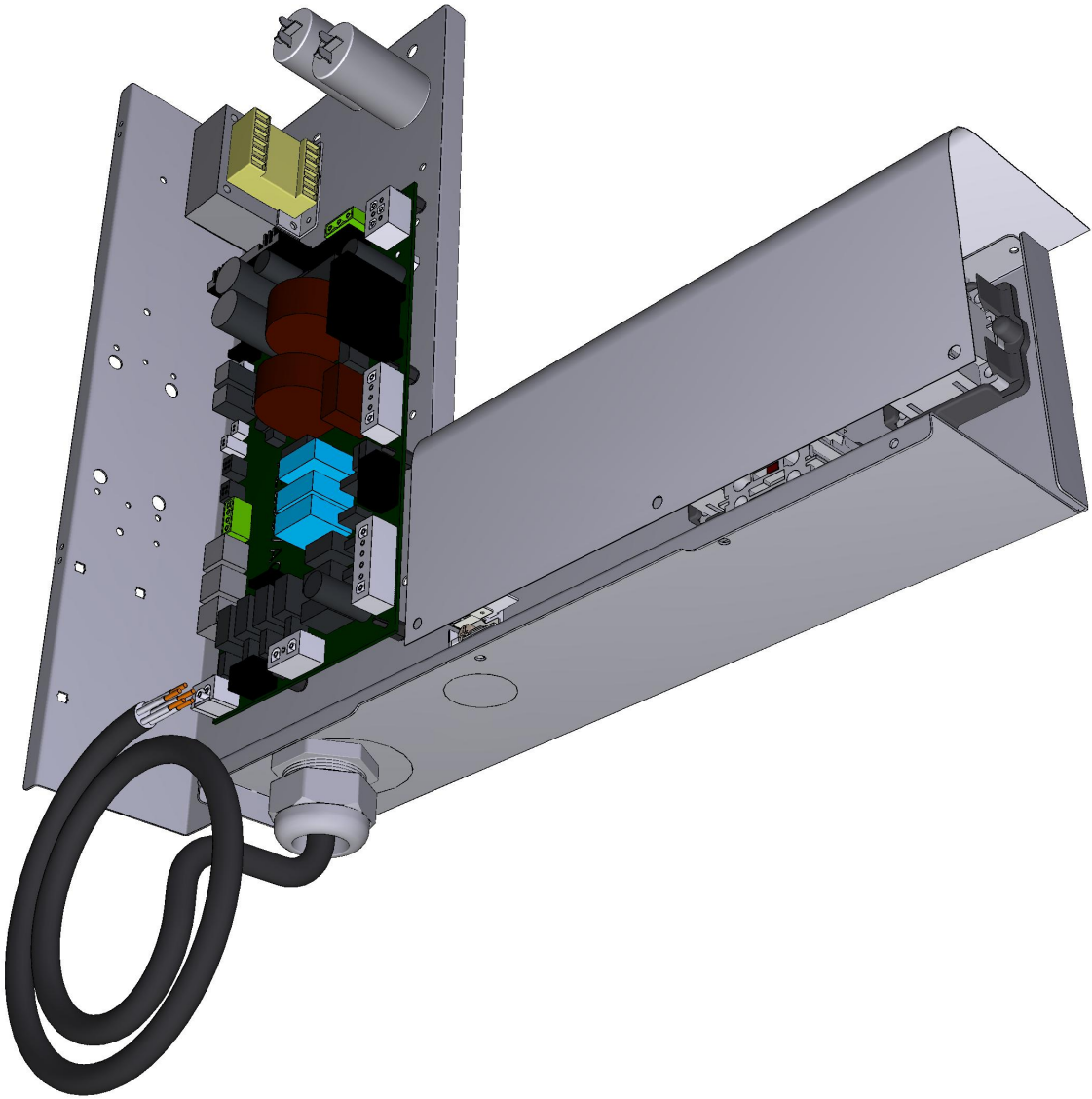

**ASM3069A/0.D04 - Electrical system**

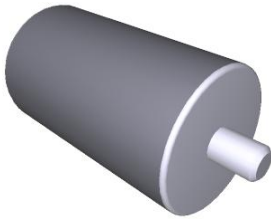
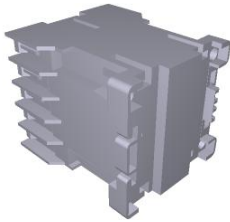

**REAR**



COMPONENT			SPARE PART																						
Code	Description	Image	Code	Description	Components list																				
CN1003A	6,3 UF MOTOR CAPACITOR		KCN1003A	6,3 UF MOTOR CAPACITOR KIT	<table border="1"> <thead> <tr> <th>Code</th> <th>Description</th> <th>Qty</th> <th>UOM</th> </tr> </thead> <tbody> <tr> <td>CN1003A0</td> <td>6,3 UF MOTOR CAPACITOR</td> <td>1</td> <td>PZ</td> </tr> <tr> <td>VI1931A0</td> <td>M8 NUT+INDENTE D WASHER D=8 X COND.</td> <td>1</td> <td>PZ</td> </tr> <tr> <td>VI1932A0</td> <td>M8 NUT+INDENTE D WASHER D=8 X COND.</td> <td>1</td> <td>PZ</td> </tr> <tr> <td>VM1224A0</td> <td>65MY 220MM 2 COLOURS SHRINK TUBE</td> <td>0.200</td> <td>M</td> </tr> </tbody> </table>	Code	Description	Qty	UOM	CN1003A0	6,3 UF MOTOR CAPACITOR	1	PZ	VI1931A0	M8 NUT+INDENTE D WASHER D=8 X COND.	1	PZ	VI1932A0	M8 NUT+INDENTE D WASHER D=8 X COND.	1	PZ	VM1224A0	65MY 220MM 2 COLOURS SHRINK TUBE	0.200	M
Code	Description	Qty	UOM																						
CN1003A0	6,3 UF MOTOR CAPACITOR	1	PZ																						
VI1931A0	M8 NUT+INDENTE D WASHER D=8 X COND.	1	PZ																						
VI1932A0	M8 NUT+INDENTE D WASHER D=8 X COND.	1	PZ																						
VM1224A0	65MY 220MM 2 COLOURS SHRINK TUBE	0.200	M																						
VE1115A	20 A 230V 4 POLES MINICONTACTOR		KVE1115A	20A 230V 4 POLES MINICONTACTOR KI	<table border="1"> <thead> <tr> <th>Code</th> <th>Description</th> <th>Qty</th> <th>UOM</th> </tr> </thead> <tbody> <tr> <td>VE1115A0</td> <td>20 A 230V 4 POLES MINICONTACT OR</td> <td>1</td> <td>PZ</td> </tr> <tr> <td>VM1075A1</td> <td>PLASTIC CLIP TO FIX CONTACTORS</td> <td>4</td> <td>PZ</td> </tr> <tr> <td>VM1224A0</td> <td>65MY 220MM 2 COLOURS SHRINK TUBE</td> <td>0.250</td> <td>M</td> </tr> </tbody> </table>	Code	Description	Qty	UOM	VE1115A0	20 A 230V 4 POLES MINICONTACT OR	1	PZ	VM1075A1	PLASTIC CLIP TO FIX CONTACTORS	4	PZ	VM1224A0	65MY 220MM 2 COLOURS SHRINK TUBE	0.250	M				
Code	Description	Qty	UOM																						
VE1115A0	20 A 230V 4 POLES MINICONTACT OR	1	PZ																						
VM1075A1	PLASTIC CLIP TO FIX CONTACTORS	4	PZ																						
VM1224A0	65MY 220MM 2 COLOURS SHRINK TUBE	0.250	M																						
VM1056A	SMALL CONTACTOR BRACKET VE1115A		VM1056A0	SMALL CONTACTOR BRACKET VE1115A																					
MR1004A	41A 450V 7 POLES TERMINAL		KMR1004A	7FTW 1+2+3/4+5+6 TERMINAL BLOCK KIT	<table border="1"> <thead> <tr> <th>Code</th> <th>Description</th> <th>Qty</th> <th>UOM</th> </tr> </thead> <tbody> <tr> <td>MR1004A1</td> <td>41A 450V 7 POLES TERMINAL</td> <td>1</td> <td>PZ</td> </tr> <tr> <td>VM1224A0</td> <td>65MY 220MM 2 COLOURS SHRINK TUBE</td> <td>0.300</td> <td>M</td> </tr> </tbody> </table>	Code	Description	Qty	UOM	MR1004A1	41A 450V 7 POLES TERMINAL	1	PZ	VM1224A0	65MY 220MM 2 COLOURS SHRINK TUBE	0.300	M								
Code	Description	Qty	UOM																						
MR1004A1	41A 450V 7 POLES TERMINAL	1	PZ																						
VM1224A0	65MY 220MM 2 COLOURS SHRINK TUBE	0.300	M																						

COMPONENT			SPARE PART																										
Code	Description	Image	Code	Description	Components list																								
VE1644A	PG 29 STRAIN RELIEF NUT		KVE1645A	REDUCED PG 29 STRAIN RELIEF + NUT KIT	<table border="1"> <thead> <tr> <th>Code</th> <th>Description</th> <th>Qty</th> <th>UOM</th> </tr> </thead> <tbody> <tr> <td>VE1644A0</td> <td>PG 29 STRAIN RELIEF NUT</td> <td>1</td> <td>PZ</td> </tr> <tr> <td>VE1645A1</td> <td>REDUCED PG 29 STRAIN RELIEF</td> <td>1</td> <td>PZ</td> </tr> <tr> <td>VM1224A0</td> <td>65MY 220MM 2 COLOURS SHRINK TUBE</td> <td>0.300</td> <td>M</td> </tr> </tbody> </table>	Code	Description	Qty	UOM	VE1644A0	PG 29 STRAIN RELIEF NUT	1	PZ	VE1645A1	REDUCED PG 29 STRAIN RELIEF	1	PZ	VM1224A0	65MY 220MM 2 COLOURS SHRINK TUBE	0.300	M								
Code	Description	Qty	UOM																										
VE1644A0	PG 29 STRAIN RELIEF NUT	1	PZ																										
VE1645A1	REDUCED PG 29 STRAIN RELIEF	1	PZ																										
VM1224A0	65MY 220MM 2 COLOURS SHRINK TUBE	0.300	M																										
VE1645A	REDUCED PG 29 STRAIN RELIEF		KVE1645A	REDUCED PG 29 STRAIN RELIEF + NUT KIT	<table border="1"> <thead> <tr> <th>Code</th> <th>Description</th> <th>Qty</th> <th>UOM</th> </tr> </thead> <tbody> <tr> <td>VE1644A0</td> <td>PG 29 STRAIN RELIEF NUT</td> <td>1</td> <td>PZ</td> </tr> <tr> <td>VE1645A1</td> <td>REDUCED PG 29 STRAIN RELIEF</td> <td>1</td> <td>PZ</td> </tr> <tr> <td>VM1224A0</td> <td>65MY 220MM 2 COLOURS SHRINK TUBE</td> <td>0.300</td> <td>M</td> </tr> </tbody> </table>	Code	Description	Qty	UOM	VE1644A0	PG 29 STRAIN RELIEF NUT	1	PZ	VE1645A1	REDUCED PG 29 STRAIN RELIEF	1	PZ	VM1224A0	65MY 220MM 2 COLOURS SHRINK TUBE	0.300	M								
Code	Description	Qty	UOM																										
VE1644A0	PG 29 STRAIN RELIEF NUT	1	PZ																										
VE1645A1	REDUCED PG 29 STRAIN RELIEF	1	PZ																										
VM1224A0	65MY 220MM 2 COLOURS SHRINK TUBE	0.300	M																										
CE1355A	CABLE 5 X 2,5 MMQ H07RNF L = 1,5 MT		KCE1355A	L=1.5M 5X2.5MMQ POWER CABLE KIT	<table border="1"> <thead> <tr> <th>Code</th> <th>Description</th> <th>Qty</th> <th>UOM</th> </tr> </thead> <tbody> <tr> <td>CE1355A1</td> <td>CABLE 5 X 2,5 MMQ H07RNF L = 1,5 MT</td> <td>1</td> <td>PZ</td> </tr> <tr> <td>VM1224A0</td> <td>65MY 220MM 2 COLOURS SHRINK TUBE</td> <td>0.350</td> <td>M</td> </tr> </tbody> </table>	Code	Description	Qty	UOM	CE1355A1	CABLE 5 X 2,5 MMQ H07RNF L = 1,5 MT	1	PZ	VM1224A0	65MY 220MM 2 COLOURS SHRINK TUBE	0.350	M												
Code	Description	Qty	UOM																										
CE1355A1	CABLE 5 X 2,5 MMQ H07RNF L = 1,5 MT	1	PZ																										
VM1224A0	65MY 220MM 2 COLOURS SHRINK TUBE	0.350	M																										
VM1745A	CARD SUPPORT		KVM1745A	BOARD SUPPORT 10 PCS KIT	<table border="1"> <thead> <tr> <th>Code</th> <th>Description</th> <th>Qty</th> <th>UOM</th> </tr> </thead> <tbody> <tr> <td>VM1224A0</td> <td>65MY 220MM 2 COLOURS SHRINK TUBE</td> <td>0.200</td> <td>M</td> </tr> <tr> <td>VM1745A0</td> <td>CARD SUPPORT</td> <td>10</td> <td>PZ</td> </tr> </tbody> </table>	Code	Description	Qty	UOM	VM1224A0	65MY 220MM 2 COLOURS SHRINK TUBE	0.200	M	VM1745A0	CARD SUPPORT	10	PZ												
Code	Description	Qty	UOM																										
VM1224A0	65MY 220MM 2 COLOURS SHRINK TUBE	0.200	M																										
VM1745A0	CARD SUPPORT	10	PZ																										
PE2037A	MIND.MAPS ONE POWER CARD		KPE2037A	MIND.MAPS ONE POWER BOARD KIT	<table border="1"> <thead> <tr> <th>Code</th> <th>Description</th> <th>Qty</th> <th>UOM</th> </tr> </thead> <tbody> <tr> <td>MOV0003A0</td> <td>HOOD RING GASKET GN1110A2</td> <td>0.100</td> <td>PZ</td> </tr> <tr> <td>PE2037A0</td> <td>MIND.MAPS ONE POWER CARD</td> <td>1</td> <td>PZ</td> </tr> <tr> <td>VI1850A0</td> <td>M4X6 NICKEL PLATED FIXING SCRE</td> <td>9</td> <td>PZ</td> </tr> <tr> <td>VM1745A0</td> <td>CARD SUPPORT</td> <td>9</td> <td>PZ</td> </tr> <tr> <td>VM2147A0</td> <td>410X343X15 MM PINK SMOOTH ESD SPONGE</td> <td>1</td> <td>PZ</td> </tr> </tbody> </table>	Code	Description	Qty	UOM	MOV0003A0	HOOD RING GASKET GN1110A2	0.100	PZ	PE2037A0	MIND.MAPS ONE POWER CARD	1	PZ	VI1850A0	M4X6 NICKEL PLATED FIXING SCRE	9	PZ	VM1745A0	CARD SUPPORT	9	PZ	VM2147A0	410X343X15 MM PINK SMOOTH ESD SPONGE	1	PZ
Code	Description	Qty	UOM																										
MOV0003A0	HOOD RING GASKET GN1110A2	0.100	PZ																										
PE2037A0	MIND.MAPS ONE POWER CARD	1	PZ																										
VI1850A0	M4X6 NICKEL PLATED FIXING SCRE	9	PZ																										
VM1745A0	CARD SUPPORT	9	PZ																										
VM2147A0	410X343X15 MM PINK SMOOTH ESD SPONGE	1	PZ																										

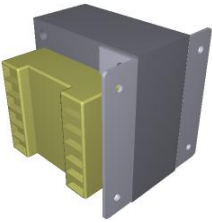
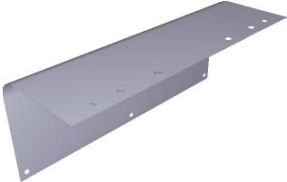

COMPONENT			SPARE PART														
Code	Description	Image	Code	Description	Components list												
VE1639A	TRANSFORMER 230-12VAC 60VA		KVE1639A	230-12VAC 60VA TRANSFORMER KIT	<table border="1"> <thead> <tr> <th>Code</th> <th>Description</th> <th>Qty</th> <th>UOM</th> </tr> </thead> <tbody> <tr> <td>VE1639A0</td> <td>TRANSFORMER 230-12VAC 60VA</td> <td>1</td> <td>PZ</td> </tr> <tr> <td>VI1950A0</td> <td>ST. STEEL 4,2X13 TCB SELF-DRILLING SCREW</td> <td>4</td> <td>PZ</td> </tr> </tbody> </table>	Code	Description	Qty	UOM	VE1639A0	TRANSFORMER 230-12VAC 60VA	1	PZ	VI1950A0	ST. STEEL 4,2X13 TCB SELF-DRILLING SCREW	4	PZ
Code	Description	Qty	UOM														
VE1639A0	TRANSFORMER 230-12VAC 60VA	1	PZ														
VI1950A0	ST. STEEL 4,2X13 TCB SELF-DRILLING SCREW	4	PZ														
VM2387A	MM XEVC REMOTE CONTROL SWITCH PROTECTION		VM2387A0	MM XEVC REMOTE CONTROL SWITCH PROTECTION													
0H7371A	XEBC MM COMPONENTS HOLDING PLATE		0H7371A0	XEBC MM COMPONENTS HOLDING PLATE													



**ASM1771C/0.D00 - External cover**

**FRONT**

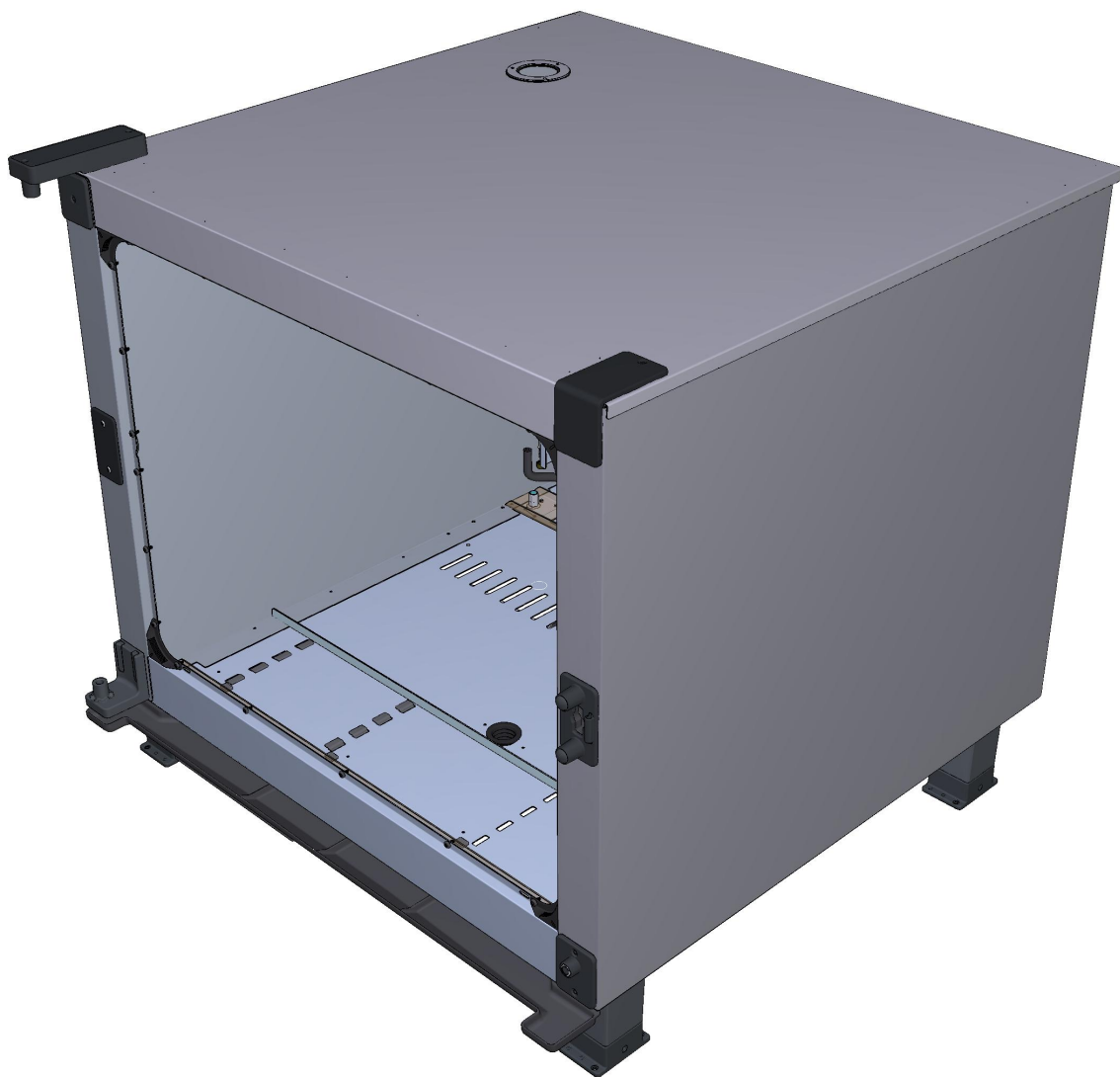

ASM1771C/0.D00 - External cover

REAR

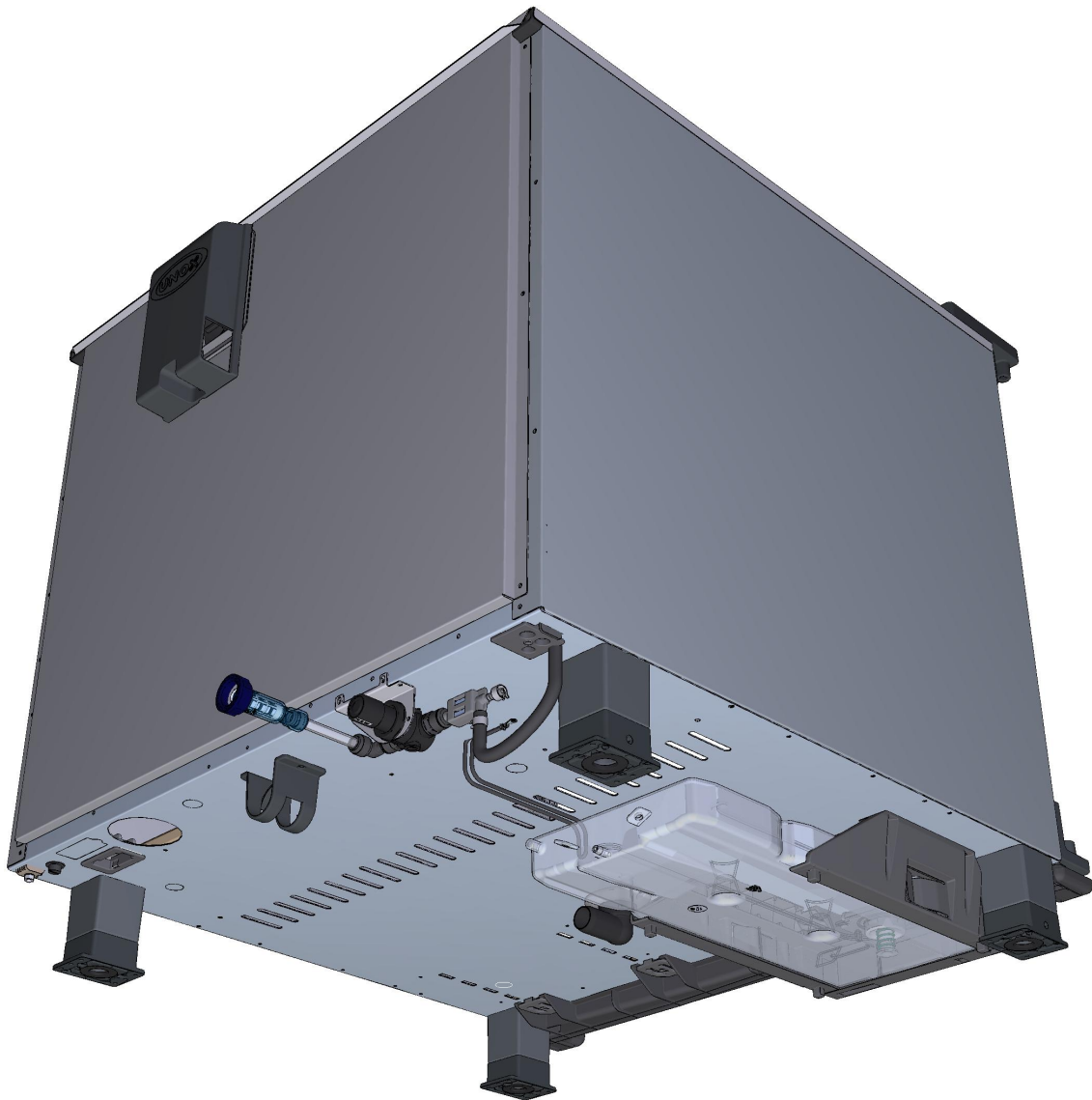











COMPONENT			SPARE PART																										
Code	Description	Image	Code	Description	Components list																								
VM1750A	BRASS COMB CLAM		KVM1750A	COMB TERMINAL BLOCK KIT	<table border="1"> <thead> <tr> <th>Code</th> <th>Description</th> <th>Qty</th> <th>UOM</th> </tr> </thead> <tbody> <tr> <td>VM1224A0</td> <td>65MY 220MM 2 COLOURS SHRINK TUBE</td> <td>0.150</td> <td>M</td> </tr> <tr> <td>VM1750A0</td> <td>BRASS COMB CLAMP</td> <td>1</td> <td>PZ</td> </tr> </tbody> </table>	Code	Description	Qty	UOM	VM1224A0	65MY 220MM 2 COLOURS SHRINK TUBE	0.150	M	VM1750A0	BRASS COMB CLAMP	1	PZ												
Code	Description	Qty	UOM																										
VM1224A0	65MY 220MM 2 COLOURS SHRINK TUBE	0.150	M																										
VM1750A0	BRASS COMB CLAMP	1	PZ																										
VM2074A	DRIP TRAY FIXING CLIP WITH SCREW		KVM1220A	CT/BT DRIP TRAY FIXING CLIPS 4PCS KIT	<table border="1"> <thead> <tr> <th>Code</th> <th>Description</th> <th>Qty</th> <th>UOM</th> </tr> </thead> <tbody> <tr> <td>VI1220A1</td> <td>4.2X12 TCB SELF-TAPPIN G SCREW</td> <td>4</td> <td>PZ</td> </tr> <tr> <td>VM1220A0</td> <td>CLIP TO FIX DRIP TRAY C.T</td> <td>4</td> <td>PZ</td> </tr> <tr> <td>VM1224A0</td> <td>65MY 220MM 2 COLOURS SHRINK TUBE</td> <td>0.250</td> <td>M</td> </tr> <tr> <td>VM2074A0</td> <td>DRIP TRAY FIXING CLIP WITH SCREW</td> <td>4</td> <td>PZ</td> </tr> </tbody> </table>	Code	Description	Qty	UOM	VI1220A1	4.2X12 TCB SELF-TAPPIN G SCREW	4	PZ	VM1220A0	CLIP TO FIX DRIP TRAY C.T	4	PZ	VM1224A0	65MY 220MM 2 COLOURS SHRINK TUBE	0.250	M	VM2074A0	DRIP TRAY FIXING CLIP WITH SCREW	4	PZ				
Code	Description	Qty	UOM																										
VI1220A1	4.2X12 TCB SELF-TAPPIN G SCREW	4	PZ																										
VM1220A0	CLIP TO FIX DRIP TRAY C.T	4	PZ																										
VM1224A0	65MY 220MM 2 COLOURS SHRINK TUBE	0.250	M																										
VM2074A0	DRIP TRAY FIXING CLIP WITH SCREW	4	PZ																										
VN1165A	230VAC 50/60HZ COOLING DOWN FA		KVN1165A	S.5E ADVANCE/MM 230V COOLING FAN KIT	<table border="1"> <thead> <tr> <th>Code</th> <th>Description</th> <th>Qty</th> <th>UOM</th> </tr> </thead> <tbody> <tr> <td>MOV0017A0</td> <td>HOOD RING GASKET GN1110A2</td> <td>0.100</td> <td>PZ</td> </tr> <tr> <td>VI1099A0</td> <td>SELF-DRILLIN G SCREW 4.8X13 TCB+ Z</td> <td>4</td> <td>PZ</td> </tr> <tr> <td>VM1555A2</td> <td>CT BT COOLING FAN SUPPORT</td> <td>1</td> <td>PZ</td> </tr> <tr> <td>VN1165A0</td> <td>230VAC 50/60HZ COOLING DOWN FAN</td> <td>1</td> <td>PZ</td> </tr> <tr> <td>VN1165A0</td> <td>230VAC 50/60HZ COOLING DOWN FAN</td> <td>1</td> <td>PZ</td> </tr> </tbody> </table>	Code	Description	Qty	UOM	MOV0017A0	HOOD RING GASKET GN1110A2	0.100	PZ	VI1099A0	SELF-DRILLIN G SCREW 4.8X13 TCB+ Z	4	PZ	VM1555A2	CT BT COOLING FAN SUPPORT	1	PZ	VN1165A0	230VAC 50/60HZ COOLING DOWN FAN	1	PZ	VN1165A0	230VAC 50/60HZ COOLING DOWN FAN	1	PZ
Code	Description	Qty	UOM																										
MOV0017A0	HOOD RING GASKET GN1110A2	0.100	PZ																										
VI1099A0	SELF-DRILLIN G SCREW 4.8X13 TCB+ Z	4	PZ																										
VM1555A2	CT BT COOLING FAN SUPPORT	1	PZ																										
VN1165A0	230VAC 50/60HZ COOLING DOWN FAN	1	PZ																										
VN1165A0	230VAC 50/60HZ COOLING DOWN FAN	1	PZ																										
VM1555A	CT BT COOLING FAN SUPPORT		KVN1165A	S.5E ADVANCE/MM 230V COOLING FAN KIT	<table border="1"> <thead> <tr> <th>Code</th> <th>Description</th> <th>Qty</th> <th>UOM</th> </tr> </thead> <tbody> <tr> <td>MOV0017A0</td> <td>HOOD RING GASKET GN1110A2</td> <td>0.100</td> <td>PZ</td> </tr> <tr> <td>VI1099A0</td> <td>SELF-DRILLIN G SCREW 4.8X13 TCB+ Z</td> <td>4</td> <td>PZ</td> </tr> <tr> <td>VM1555A2</td> <td>CT BT COOLING FAN SUPPORT</td> <td>1</td> <td>PZ</td> </tr> <tr> <td>VN1165A0</td> <td>230VAC 50/60HZ COOLING DOWN FAN</td> <td>1</td> <td>PZ</td> </tr> <tr> <td>VN1165A0</td> <td>230VAC 50/60HZ COOLING DOWN FAN</td> <td>1</td> <td>PZ</td> </tr> </tbody> </table>	Code	Description	Qty	UOM	MOV0017A0	HOOD RING GASKET GN1110A2	0.100	PZ	VI1099A0	SELF-DRILLIN G SCREW 4.8X13 TCB+ Z	4	PZ	VM1555A2	CT BT COOLING FAN SUPPORT	1	PZ	VN1165A0	230VAC 50/60HZ COOLING DOWN FAN	1	PZ	VN1165A0	230VAC 50/60HZ COOLING DOWN FAN	1	PZ
Code	Description	Qty	UOM																										
MOV0017A0	HOOD RING GASKET GN1110A2	0.100	PZ																										
VI1099A0	SELF-DRILLIN G SCREW 4.8X13 TCB+ Z	4	PZ																										
VM1555A2	CT BT COOLING FAN SUPPORT	1	PZ																										
VN1165A0	230VAC 50/60HZ COOLING DOWN FAN	1	PZ																										
VN1165A0	230VAC 50/60HZ COOLING DOWN FAN	1	PZ																										

COMPONENT			SPARE PART																						
Code	Description	Image	Code	Description	Components list																				
VM1555A	CT BT COOLING FAN SUPPORT		KVN1164A	S.5/5E 12VDC COOLING DOWN FAN KIT	<table border="1"> <thead> <tr> <th>Code</th> <th>Description</th> <th>Qty</th> <th>UOM</th> </tr> </thead> <tbody> <tr> <td>VI1099A0</td> <td>SELF-DRILLING G SCREW 4.8X13 TCB+ Z</td> <td>4</td> <td>PZ</td> </tr> <tr> <td>VM1555A2</td> <td>CT BT COOLING FAN SUPPORT</td> <td>1</td> <td>PZ</td> </tr> <tr> <td>VN1164A0</td> <td>12VDC COOLING DOWN FAN</td> <td>1</td> <td>PZ</td> </tr> <tr> <td>VN1164A0</td> <td>12VDC COOLING DOWN FAN</td> <td>1</td> <td>PZ</td> </tr> </tbody> </table>	Code	Description	Qty	UOM	VI1099A0	SELF-DRILLING G SCREW 4.8X13 TCB+ Z	4	PZ	VM1555A2	CT BT COOLING FAN SUPPORT	1	PZ	VN1164A0	12VDC COOLING DOWN FAN	1	PZ	VN1164A0	12VDC COOLING DOWN FAN	1	PZ
Code	Description	Qty	UOM																						
VI1099A0	SELF-DRILLING G SCREW 4.8X13 TCB+ Z	4	PZ																						
VM1555A2	CT BT COOLING FAN SUPPORT	1	PZ																						
VN1164A0	12VDC COOLING DOWN FAN	1	PZ																						
VN1164A0	12VDC COOLING DOWN FAN	1	PZ																						
VM1556A	XBC-XVC COOLING FAN GUARD		KVM1556A	XBC-XVC COOLING FAN GUARD KIT	<table border="1"> <thead> <tr> <th>Code</th> <th>Description</th> <th>Qty</th> <th>UOM</th> </tr> </thead> <tbody> <tr> <td>VM1556A0</td> <td>XBC-XVC COOLING FAN GUARD</td> <td>1</td> <td>PZ</td> </tr> </tbody> </table>	Code	Description	Qty	UOM	VM1556A0	XBC-XVC COOLING FAN GUARD	1	PZ												
Code	Description	Qty	UOM																						
VM1556A0	XBC-XVC COOLING FAN GUARD	1	PZ																						
VL1026A	BEND FOR DRAIN PIPE		KVL1026A	DRAIN PIPE BEND KIT	<table border="1"> <thead> <tr> <th>Code</th> <th>Description</th> <th>Qty</th> <th>UOM</th> </tr> </thead> <tbody> <tr> <td>GN1400A0</td> <td>U-TRAP SEAL</td> <td>1</td> <td>PZ</td> </tr> <tr> <td>VL1026A0</td> <td>BEND FOR DRAIN PIPE</td> <td>1</td> <td>PZ</td> </tr> <tr> <td>VM1224A0</td> <td>65MY 220MM 2 COLOURS SHRINK TUBE</td> <td>0.300</td> <td>M</td> </tr> <tr> <td>VM2039A0</td> <td>DRAIN BEND FIXING RING</td> <td>1</td> <td>PZ</td> </tr> </tbody> </table>	Code	Description	Qty	UOM	GN1400A0	U-TRAP SEAL	1	PZ	VL1026A0	BEND FOR DRAIN PIPE	1	PZ	VM1224A0	65MY 220MM 2 COLOURS SHRINK TUBE	0.300	M	VM2039A0	DRAIN BEND FIXING RING	1	PZ
Code	Description	Qty	UOM																						
GN1400A0	U-TRAP SEAL	1	PZ																						
VL1026A0	BEND FOR DRAIN PIPE	1	PZ																						
VM1224A0	65MY 220MM 2 COLOURS SHRINK TUBE	0.300	M																						
VM2039A0	DRAIN BEND FIXING RING	1	PZ																						
VM2039A	DRAIN BEND FIXING RING		KVL1026A	DRAIN PIPE BEND KIT	<table border="1"> <thead> <tr> <th>Code</th> <th>Description</th> <th>Qty</th> <th>UOM</th> </tr> </thead> <tbody> <tr> <td>GN1400A0</td> <td>U-TRAP SEAL</td> <td>1</td> <td>PZ</td> </tr> <tr> <td>VL1026A0</td> <td>BEND FOR DRAIN PIPE</td> <td>1</td> <td>PZ</td> </tr> <tr> <td>VM1224A0</td> <td>65MY 220MM 2 COLOURS SHRINK TUBE</td> <td>0.300</td> <td>M</td> </tr> <tr> <td>VM2039A0</td> <td>DRAIN BEND FIXING RING</td> <td>1</td> <td>PZ</td> </tr> </tbody> </table>	Code	Description	Qty	UOM	GN1400A0	U-TRAP SEAL	1	PZ	VL1026A0	BEND FOR DRAIN PIPE	1	PZ	VM1224A0	65MY 220MM 2 COLOURS SHRINK TUBE	0.300	M	VM2039A0	DRAIN BEND FIXING RING	1	PZ
Code	Description	Qty	UOM																						
GN1400A0	U-TRAP SEAL	1	PZ																						
VL1026A0	BEND FOR DRAIN PIPE	1	PZ																						
VM1224A0	65MY 220MM 2 COLOURS SHRINK TUBE	0.300	M																						
VM2039A0	DRAIN BEND FIXING RING	1	PZ																						
VM2035A	DRAIN PIPE SUPPORT		KVM2035A	DRAIN PIPE SUPPORT 2 PCS. KI	<table border="1"> <thead> <tr> <th>Code</th> <th>Description</th> <th>Qty</th> <th>UOM</th> </tr> </thead> <tbody> <tr> <td>VM1224A0</td> <td>65MY 220MM 2 COLOURS SHRINK TUBE</td> <td>0.250</td> <td>M</td> </tr> <tr> <td>VM2035A0</td> <td>DRAIN PIPE SUPPORT</td> <td>2</td> <td>PZ</td> </tr> </tbody> </table>	Code	Description	Qty	UOM	VM1224A0	65MY 220MM 2 COLOURS SHRINK TUBE	0.250	M	VM2035A0	DRAIN PIPE SUPPORT	2	PZ								
Code	Description	Qty	UOM																						
VM1224A0	65MY 220MM 2 COLOURS SHRINK TUBE	0.250	M																						
VM2035A0	DRAIN PIPE SUPPORT	2	PZ																						



COMPONENT			SPARE PART																		
Code	Description	Image	Code	Description	Components list																
VM1810A	RIGHT WATERTIGHT CAP		VM1810A0	RIGHT WATERTIGHT CAP																	
VM1811A	LEFT WATERTIGHT CAP		VM1811A0	LEFT WATERTIGHT CAP																	
VM2311A	SCREWS COVER		KVM2311A	SCREWS COVER PLATE KIT	<table border="1"> <thead> <tr> <th>Code</th> <th>Description</th> <th>Qty</th> <th>UOM</th> </tr> </thead> <tbody> <tr> <td>VM1224A0</td> <td>65MY 220MM 2 COLOURS SHRINK TUBE</td> <td>0.200</td> <td>M</td> </tr> <tr> <td>VM2311A0</td> <td>SCREWS COVER</td> <td>1</td> <td>PZ</td> </tr> </tbody> </table>	Code	Description	Qty	UOM	VM1224A0	65MY 220MM 2 COLOURS SHRINK TUBE	0.200	M	VM2311A0	SCREWS COVER	1	PZ				
Code	Description	Qty	UOM																		
VM1224A0	65MY 220MM 2 COLOURS SHRINK TUBE	0.200	M																		
VM2311A0	SCREWS COVER	1	PZ																		
GN1558A	EXHAUST SEAL		K0H7291A	GASKET AND SEALING DISC CHIMNEY KIT	<table border="1"> <thead> <tr> <th>Code</th> <th>Description</th> <th>Qty</th> <th>UOM</th> </tr> </thead> <tbody> <tr> <td>0H7291A0</td> <td>CHIMNEY HOLDING DIS</td> <td>1</td> <td>PZ</td> </tr> <tr> <td>GN1558A0</td> <td>EXHAUST SEA</td> <td>1</td> <td>PZ</td> </tr> <tr> <td>VM1224A0</td> <td>65MY 220MM 2 COLOURS SHRINK TUBE</td> <td>0.200</td> <td>M</td> </tr> </tbody> </table>	Code	Description	Qty	UOM	0H7291A0	CHIMNEY HOLDING DIS	1	PZ	GN1558A0	EXHAUST SEA	1	PZ	VM1224A0	65MY 220MM 2 COLOURS SHRINK TUBE	0.200	M
Code	Description	Qty	UOM																		
0H7291A0	CHIMNEY HOLDING DIS	1	PZ																		
GN1558A0	EXHAUST SEA	1	PZ																		
VM1224A0	65MY 220MM 2 COLOURS SHRINK TUBE	0.200	M																		
0H7291A	CHIMNEY HOLDING DISC		K0H7291A	GASKET AND SEALING DISC CHIMNEY KIT	<table border="1"> <thead> <tr> <th>Code</th> <th>Description</th> <th>Qty</th> <th>UOM</th> </tr> </thead> <tbody> <tr> <td>0H7291A0</td> <td>CHIMNEY HOLDING DIS</td> <td>1</td> <td>PZ</td> </tr> <tr> <td>GN1558A0</td> <td>EXHAUST SEA</td> <td>1</td> <td>PZ</td> </tr> <tr> <td>VM1224A0</td> <td>65MY 220MM 2 COLOURS SHRINK TUBE</td> <td>0.200</td> <td>M</td> </tr> </tbody> </table>	Code	Description	Qty	UOM	0H7291A0	CHIMNEY HOLDING DIS	1	PZ	GN1558A0	EXHAUST SEA	1	PZ	VM1224A0	65MY 220MM 2 COLOURS SHRINK TUBE	0.200	M
Code	Description	Qty	UOM																		
0H7291A0	CHIMNEY HOLDING DIS	1	PZ																		
GN1558A0	EXHAUST SEA	1	PZ																		
VM1224A0	65MY 220MM 2 COLOURS SHRINK TUBE	0.200	M																		



COMPONENT			SPARE PART																										
Code	Description	Image	Code	Description	Components list																								
VM1118A	DET&RINSE PLUS TANK LEFT GUIDE		KVM1118A	DET&RINSE TANK LEFT GUIDE KIT FOR MM	<table border="1"> <thead> <tr> <th>Code</th> <th>Description</th> <th>Qty</th> <th>UOM</th> </tr> </thead> <tbody> <tr> <td>V11220A1</td> <td>4,2X12 TCB SELF-TAPPIN G SCREW</td> <td>2</td> <td>PZ</td> </tr> <tr> <td>VM1118A0</td> <td>DET&amp;RINSE PLUS TANK LEFT GUIDE</td> <td>1</td> <td>PZ</td> </tr> </tbody> </table>	Code	Description	Qty	UOM	V11220A1	4,2X12 TCB SELF-TAPPIN G SCREW	2	PZ	VM1118A0	DET&RINSE PLUS TANK LEFT GUIDE	1	PZ												
Code	Description	Qty	UOM																										
V11220A1	4,2X12 TCB SELF-TAPPIN G SCREW	2	PZ																										
VM1118A0	DET&RINSE PLUS TANK LEFT GUIDE	1	PZ																										
VM1119A	DET&RINSE PLUS TANK RIGHT GUIDE		KVM1119A	DET&RINSE TANK RIGHT GUIDE KIT FOR MM	<table border="1"> <thead> <tr> <th>Code</th> <th>Description</th> <th>Qty</th> <th>UOM</th> </tr> </thead> <tbody> <tr> <td>V11220A1</td> <td>4,2X12 TCB SELF-TAPPIN G SCREW</td> <td>2</td> <td>PZ</td> </tr> <tr> <td>VM1119A0</td> <td>DET&amp;RINSE PLUS TANK RIGHT GUIDE</td> <td>1</td> <td>PZ</td> </tr> </tbody> </table>	Code	Description	Qty	UOM	V11220A1	4,2X12 TCB SELF-TAPPIN G SCREW	2	PZ	VM1119A0	DET&RINSE PLUS TANK RIGHT GUIDE	1	PZ												
Code	Description	Qty	UOM																										
V11220A1	4,2X12 TCB SELF-TAPPIN G SCREW	2	PZ																										
VM1119A0	DET&RINSE PLUS TANK RIGHT GUIDE	1	PZ																										
SB1015A	4L DETERGENT TAN		KSB1015A	4L DETERGENT TANK KIT	<table border="1"> <thead> <tr> <th>Code</th> <th>Description</th> <th>Qty</th> <th>UOM</th> </tr> </thead> <tbody> <tr> <td>IP1385A1</td> <td>CORNER POLYSTYREN E PACKING 110X80X2000</td> <td>1.200</td> <td>M</td> </tr> <tr> <td>IP1410A0</td> <td>POLYSTYREN E PACKING TO PROTECT</td> <td>2</td> <td>PZ</td> </tr> <tr> <td>SB1015A2</td> <td>4L DETERGENT TANK</td> <td>1</td> <td>PZ</td> </tr> <tr> <td>VM1059A1</td> <td>HEAT SHRINK FILM H800</td> <td>1.200</td> <td>M</td> </tr> </tbody> </table>	Code	Description	Qty	UOM	IP1385A1	CORNER POLYSTYREN E PACKING 110X80X2000	1.200	M	IP1410A0	POLYSTYREN E PACKING TO PROTECT	2	PZ	SB1015A2	4L DETERGENT TANK	1	PZ	VM1059A1	HEAT SHRINK FILM H800	1.200	M				
Code	Description	Qty	UOM																										
IP1385A1	CORNER POLYSTYREN E PACKING 110X80X2000	1.200	M																										
IP1410A0	POLYSTYREN E PACKING TO PROTECT	2	PZ																										
SB1015A2	4L DETERGENT TANK	1	PZ																										
VM1059A1	HEAT SHRINK FILM H800	1.200	M																										
VM1992A	E SERIES BAKERTOP DRIP TRAY		KVM1992A	E SERIES BAKERTOP DRIP TRAY	<table border="1"> <thead> <tr> <th>Code</th> <th>Description</th> <th>Qty</th> <th>UOM</th> </tr> </thead> <tbody> <tr> <td>VM1220A0</td> <td>CLIP TO FIX DRIP TRAY C.T</td> <td>4</td> <td>PZ</td> </tr> <tr> <td>VM1794A0</td> <td>250X4.8 PA66 BLACK CLAMP</td> <td>2</td> <td>PZ</td> </tr> <tr> <td>VM1992A0</td> <td>E SERIES BAKERTOP DRIP TRAY</td> <td>1</td> <td>PZ</td> </tr> <tr> <td>VM2074A0</td> <td>DRIP TRAY FIXING CLIP WITH SCREW</td> <td>4</td> <td>PZ</td> </tr> <tr> <td>VM2103A0</td> <td>CLAMP LOCK</td> <td>2</td> <td>PZ</td> </tr> </tbody> </table>	Code	Description	Qty	UOM	VM1220A0	CLIP TO FIX DRIP TRAY C.T	4	PZ	VM1794A0	250X4.8 PA66 BLACK CLAMP	2	PZ	VM1992A0	E SERIES BAKERTOP DRIP TRAY	1	PZ	VM2074A0	DRIP TRAY FIXING CLIP WITH SCREW	4	PZ	VM2103A0	CLAMP LOCK	2	PZ
Code	Description	Qty	UOM																										
VM1220A0	CLIP TO FIX DRIP TRAY C.T	4	PZ																										
VM1794A0	250X4.8 PA66 BLACK CLAMP	2	PZ																										
VM1992A0	E SERIES BAKERTOP DRIP TRAY	1	PZ																										
VM2074A0	DRIP TRAY FIXING CLIP WITH SCREW	4	PZ																										
VM2103A0	CLAMP LOCK	2	PZ																										





COMPONENT			SPARE PART														
Code	Description	Image	Code	Description	Components list												
0H2561A	6 S. DOOR COUNTERBRACKET		0H2561A0	6 S. DOOR COUNTERBRACKET													
VI1995A	M5X25 ST.STEEL SCREW		VI1995A0	M5X25 ST.STEEL SCREW													
VM2352A	MM LOWER DOOR BRACKET LEFT SCREW COVERI		VM2352A0	MM LOWER DOOR BRACKET LEFT SCREW COVERI													
VM2353A	MM LOWER DOOR BRACKET RIGHT SCREW COVERI		VM2353A0	MM LOWER DOOR BRACKET RIGHT SCREW COVERI													
VM1240A	NYLON SUPPORT CAP		KVM1240A	4 PCS COUNTER BRACKET SUPPORT CAP KIT	<table border="1"> <thead> <tr> <th>Code</th> <th>Description</th> <th>Qty</th> <th>UOM</th> </tr> </thead> <tbody> <tr> <td>VM1224A0</td> <td>65MY 220MM 2 COLOURS SHRINK TUBE</td> <td>0.200</td> <td>M</td> </tr> <tr> <td>VM1240A0</td> <td>NYLON SUPPORT CAP</td> <td>4</td> <td>PZ</td> </tr> </tbody> </table>	Code	Description	Qty	UOM	VM1224A0	65MY 220MM 2 COLOURS SHRINK TUBE	0.200	M	VM1240A0	NYLON SUPPORT CAP	4	PZ
Code	Description	Qty	UOM														
VM1224A0	65MY 220MM 2 COLOURS SHRINK TUBE	0.200	M														
VM1240A0	NYLON SUPPORT CAP	4	PZ														



COMPONENT			SPARE PART																																						
Code	Description	Image	Code	Description	Components list																																				
VM2273A	MM DOOR LEFT LOWER BRACKET		KVM2273A	MIND.MAPS DOOR LOWER LEFT BRACKET KIT	<table border="1"> <thead> <tr> <th>Code</th> <th>Description</th> <th>Qty</th> <th>UOM</th> </tr> </thead> <tbody> <tr> <td>0H7330A0</td> <td>DOOR LOWER BRACKET WASHER</td> <td>2</td> <td>PZ</td> </tr> <tr> <td>VI1995A0</td> <td>M5X25 ST.STEEL SCREW</td> <td>4</td> <td>PZ</td> </tr> <tr> <td>VM1224A0</td> <td>65MY 220MM 2 COLOURS SHRINK TUBE</td> <td>0.300</td> <td>M</td> </tr> <tr> <td>VM2273A1</td> <td>MM DOOR LEFT LOWER BRACKET</td> <td>1</td> <td>PZ</td> </tr> <tr> <td>VM2352A0</td> <td>MM LOWER DOOR BRACKET LEFT SCREW COVERI</td> <td>1</td> <td>PZ</td> </tr> <tr> <td>VM2352A0</td> <td>MM LOWER DOOR BRACKET LEFT SCREW COVERI</td> <td>1</td> <td>PZ</td> </tr> <tr> <td>VM2353A0</td> <td>MM LOWER DOOR BRACKET RIGHT SCREW COVERI</td> <td>1</td> <td>PZ</td> </tr> <tr> <td>VM2353A0</td> <td>MM LOWER DOOR BRACKET RIGHT SCREW COVERI</td> <td>1</td> <td>PZ</td> </tr> </tbody> </table>	Code	Description	Qty	UOM	0H7330A0	DOOR LOWER BRACKET WASHER	2	PZ	VI1995A0	M5X25 ST.STEEL SCREW	4	PZ	VM1224A0	65MY 220MM 2 COLOURS SHRINK TUBE	0.300	M	VM2273A1	MM DOOR LEFT LOWER BRACKET	1	PZ	VM2352A0	MM LOWER DOOR BRACKET LEFT SCREW COVERI	1	PZ	VM2352A0	MM LOWER DOOR BRACKET LEFT SCREW COVERI	1	PZ	VM2353A0	MM LOWER DOOR BRACKET RIGHT SCREW COVERI	1	PZ	VM2353A0	MM LOWER DOOR BRACKET RIGHT SCREW COVERI	1	PZ
Code	Description	Qty	UOM																																						
0H7330A0	DOOR LOWER BRACKET WASHER	2	PZ																																						
VI1995A0	M5X25 ST.STEEL SCREW	4	PZ																																						
VM1224A0	65MY 220MM 2 COLOURS SHRINK TUBE	0.300	M																																						
VM2273A1	MM DOOR LEFT LOWER BRACKET	1	PZ																																						
VM2352A0	MM LOWER DOOR BRACKET LEFT SCREW COVERI	1	PZ																																						
VM2352A0	MM LOWER DOOR BRACKET LEFT SCREW COVERI	1	PZ																																						
VM2353A0	MM LOWER DOOR BRACKET RIGHT SCREW COVERI	1	PZ																																						
VM2353A0	MM LOWER DOOR BRACKET RIGHT SCREW COVERI	1	PZ																																						
0H2561A	6 S. DOOR COUNTERBRACKET		0H2561A0	6 S. DOOR COUNTERBRACKET																																					
VI1995A	M5X25 ST.STEEL SCREW		VI1995A0	M5X25 ST.STEEL SCREW																																					







COMPONENT			SPARE PART																														
Code	Description	Image	Code	Description	Components list																												
VM1240A	NYLON SUPPORT CAP		KVM1240A	4 PCS COUNTER BRACKET SUPPORT CAP KIT	<table border="1"> <thead> <tr> <th>Code</th> <th>Description</th> <th>Qty</th> <th>UOM</th> </tr> </thead> <tbody> <tr> <td>VM1224A0</td> <td>65MY 220MM 2 COLOURS SHRINK TUBE</td> <td>0.200</td> <td>M</td> </tr> <tr> <td>VM1240A0</td> <td>NYLON SUPPORT CAP</td> <td>4</td> <td>PZ</td> </tr> </tbody> </table>	Code	Description	Qty	UOM	VM1224A0	65MY 220MM 2 COLOURS SHRINK TUBE	0.200	M	VM1240A0	NYLON SUPPORT CAP	4	PZ																
Code	Description	Qty	UOM																														
VM1224A0	65MY 220MM 2 COLOURS SHRINK TUBE	0.200	M																														
VM1240A0	NYLON SUPPORT CAP	4	PZ																														
VM2298A	DOOR BRACKET UPPER COVER		KVM2298A	MIND.MAPS DOOR UPPER BRACKET COVER KIT	<table border="1"> <thead> <tr> <th>Code</th> <th>Description</th> <th>Qty</th> <th>UOM</th> </tr> </thead> <tbody> <tr> <td>VI1220A0</td> <td>SELF-TAPPIN G SCREW 4.2X12 TCB</td> <td>2</td> <td>PZ</td> </tr> <tr> <td>VM1224A0</td> <td>65MY 220MM 2 COLOURS SHRINK TUBE</td> <td>0.200</td> <td>M</td> </tr> <tr> <td>VM2298A0</td> <td>DOOR BRACKET UPPER COVER</td> <td>1</td> <td>PZ</td> </tr> </tbody> </table>	Code	Description	Qty	UOM	VI1220A0	SELF-TAPPIN G SCREW 4.2X12 TCB	2	PZ	VM1224A0	65MY 220MM 2 COLOURS SHRINK TUBE	0.200	M	VM2298A0	DOOR BRACKET UPPER COVER	1	PZ												
Code	Description	Qty	UOM																														
VI1220A0	SELF-TAPPIN G SCREW 4.2X12 TCB	2	PZ																														
VM1224A0	65MY 220MM 2 COLOURS SHRINK TUBE	0.200	M																														
VM2298A0	DOOR BRACKET UPPER COVER	1	PZ																														
VM2271A	MM DOOR LEFT UPPER BRACKET		KVM2271A	MIND.MAPS UPPER LEFT DOOR BRACKET KIT	<table border="1"> <thead> <tr> <th>Code</th> <th>Description</th> <th>Qty</th> <th>UOM</th> </tr> </thead> <tbody> <tr> <td>VI1220A1</td> <td>4.2X12 TCB SELF-TAPPIN G SCREW</td> <td>2</td> <td>PZ</td> </tr> <tr> <td>VI1995A0</td> <td>M5X25 ST.STEEL SCREW</td> <td>4</td> <td>PZ</td> </tr> <tr> <td>VI1997A0</td> <td>5X10X1 FLAT WASHER</td> <td>4</td> <td>PZ</td> </tr> <tr> <td>VM1224A0</td> <td>65MY 220MM 2 COLOURS SHRINK TUBE</td> <td>0.300</td> <td>M</td> </tr> <tr> <td>VM2271A0</td> <td>MM DOOR LEFT UPPER BRACKET</td> <td>1</td> <td>PZ</td> </tr> <tr> <td>VM2298A0</td> <td>DOOR BRACKET UPPER COVER</td> <td>1</td> <td>PZ</td> </tr> </tbody> </table>	Code	Description	Qty	UOM	VI1220A1	4.2X12 TCB SELF-TAPPIN G SCREW	2	PZ	VI1995A0	M5X25 ST.STEEL SCREW	4	PZ	VI1997A0	5X10X1 FLAT WASHER	4	PZ	VM1224A0	65MY 220MM 2 COLOURS SHRINK TUBE	0.300	M	VM2271A0	MM DOOR LEFT UPPER BRACKET	1	PZ	VM2298A0	DOOR BRACKET UPPER COVER	1	PZ
Code	Description	Qty	UOM																														
VI1220A1	4.2X12 TCB SELF-TAPPIN G SCREW	2	PZ																														
VI1995A0	M5X25 ST.STEEL SCREW	4	PZ																														
VI1997A0	5X10X1 FLAT WASHER	4	PZ																														
VM1224A0	65MY 220MM 2 COLOURS SHRINK TUBE	0.300	M																														
VM2271A0	MM DOOR LEFT UPPER BRACKET	1	PZ																														
VM2298A0	DOOR BRACKET UPPER COVER	1	PZ																														
PD1074A	H=100 SQUARE FOOT		KPD1074A	MIND.MAPS H100 FOOT KIT	<table border="1"> <thead> <tr> <th>Code</th> <th>Description</th> <th>Qty</th> <th>UOM</th> </tr> </thead> <tbody> <tr> <td>PD1074A0</td> <td>H=100 SQUARE FOOT</td> <td>1</td> <td>PZ</td> </tr> <tr> <td>PD1075A0</td> <td>FOOT LOCKING BRACKET</td> <td>1</td> <td>PZ</td> </tr> <tr> <td>PD1075A1</td> <td>PD1074 FOOT LOCKING BRACKET</td> <td>1</td> <td>PZ</td> </tr> <tr> <td>VI1220A1</td> <td>4.2X12 TCB SELF-TAPPIN G SCREW</td> <td>5</td> <td>PZ</td> </tr> <tr> <td>VM1224A0</td> <td>65MY 220MM 2 COLOURS SHRINK TUBE</td> <td>0.300</td> <td>M</td> </tr> </tbody> </table>	Code	Description	Qty	UOM	PD1074A0	H=100 SQUARE FOOT	1	PZ	PD1075A0	FOOT LOCKING BRACKET	1	PZ	PD1075A1	PD1074 FOOT LOCKING BRACKET	1	PZ	VI1220A1	4.2X12 TCB SELF-TAPPIN G SCREW	5	PZ	VM1224A0	65MY 220MM 2 COLOURS SHRINK TUBE	0.300	M				
Code	Description	Qty	UOM																														
PD1074A0	H=100 SQUARE FOOT	1	PZ																														
PD1075A0	FOOT LOCKING BRACKET	1	PZ																														
PD1075A1	PD1074 FOOT LOCKING BRACKET	1	PZ																														
VI1220A1	4.2X12 TCB SELF-TAPPIN G SCREW	5	PZ																														
VM1224A0	65MY 220MM 2 COLOURS SHRINK TUBE	0.300	M																														

COMPONENT			SPARE PART																										
Code	Description	Image	Code	Description	Components list																								
PD1075A	PD1074 FOOT LOCKING BRACKET		KPD1075A	OVEN FOOT STOPPING BRACKET KIT	<table border="1"> <thead> <tr> <th>Code</th> <th>Description</th> <th>Qty</th> <th>UOM</th> </tr> </thead> <tbody> <tr> <td>PD1075A0</td> <td>FOOT LOCKING BRACKET</td> <td>4</td> <td>PZ</td> </tr> <tr> <td>PD1075A1</td> <td>PD1074 FOOT LOCKING BRACKET</td> <td>4</td> <td>PZ</td> </tr> <tr> <td>VI1950A0</td> <td>ST. STEEL 4,2X13 TCB SELF-DRILLIN G SCREW</td> <td>8</td> <td>PZ</td> </tr> </tbody> </table>	Code	Description	Qty	UOM	PD1075A0	FOOT LOCKING BRACKET	4	PZ	PD1075A1	PD1074 FOOT LOCKING BRACKET	4	PZ	VI1950A0	ST. STEEL 4,2X13 TCB SELF-DRILLIN G SCREW	8	PZ								
Code	Description	Qty	UOM																										
PD1075A0	FOOT LOCKING BRACKET	4	PZ																										
PD1075A1	PD1074 FOOT LOCKING BRACKET	4	PZ																										
VI1950A0	ST. STEEL 4,2X13 TCB SELF-DRILLIN G SCREW	8	PZ																										
VM2061A	ACCESSORIES CABLES WALL PASSING		KVM1505A	THROUGH-WALL CONNECTION+DIAPHRAGM KIT	<table border="1"> <thead> <tr> <th>Code</th> <th>Description</th> <th>Qty</th> <th>UOM</th> </tr> </thead> <tbody> <tr> <td>VI1220A1</td> <td>4,2X12 TCB SELF-TAPPIN G SCREW</td> <td>1</td> <td>PZ</td> </tr> <tr> <td>VM1224A0</td> <td>65MY 220MM 2 COLOURS SHRINK TUBE</td> <td>0.200</td> <td>M</td> </tr> <tr> <td>VM1505A0</td> <td>WALL PASSING WITH DIAPHRAGM</td> <td>3</td> <td>PZ</td> </tr> <tr> <td>VM2055A0</td> <td>UPPER WALL PASSING ACCESSORY CABLES</td> <td>1</td> <td>PZ</td> </tr> <tr> <td>VM2056A0</td> <td>LOWER WALL PASSING ACCESSORY CABLES</td> <td>1</td> <td>PZ</td> </tr> </tbody> </table>	Code	Description	Qty	UOM	VI1220A1	4,2X12 TCB SELF-TAPPIN G SCREW	1	PZ	VM1224A0	65MY 220MM 2 COLOURS SHRINK TUBE	0.200	M	VM1505A0	WALL PASSING WITH DIAPHRAGM	3	PZ	VM2055A0	UPPER WALL PASSING ACCESSORY CABLES	1	PZ	VM2056A0	LOWER WALL PASSING ACCESSORY CABLES	1	PZ
Code	Description	Qty	UOM																										
VI1220A1	4,2X12 TCB SELF-TAPPIN G SCREW	1	PZ																										
VM1224A0	65MY 220MM 2 COLOURS SHRINK TUBE	0.200	M																										
VM1505A0	WALL PASSING WITH DIAPHRAGM	3	PZ																										
VM2055A0	UPPER WALL PASSING ACCESSORY CABLES	1	PZ																										
VM2056A0	LOWER WALL PASSING ACCESSORY CABLES	1	PZ																										
VM2450A	THROUG-WALL CONNECTION 3 PIPES		KVM2450A	3 PIPES THROUGH-WALL CONNECTION KIT	<table border="1"> <thead> <tr> <th>Code</th> <th>Description</th> <th>Qty</th> <th>UOM</th> </tr> </thead> <tbody> <tr> <td>VM1224A0</td> <td>65MY 220MM 2 COLOURS SHRINK TUBE</td> <td>0.200</td> <td>M</td> </tr> <tr> <td>VM2450A0</td> <td>THROUG-WAL L CONNECTION 3 PIPES</td> <td>1</td> <td>PZ</td> </tr> <tr> <td>VM2450A0</td> <td>THROUG-WAL L CONNECTION 3 PIPES</td> <td>1</td> <td>PZ</td> </tr> </tbody> </table>	Code	Description	Qty	UOM	VM1224A0	65MY 220MM 2 COLOURS SHRINK TUBE	0.200	M	VM2450A0	THROUG-WAL L CONNECTION 3 PIPES	1	PZ	VM2450A0	THROUG-WAL L CONNECTION 3 PIPES	1	PZ								
Code	Description	Qty	UOM																										
VM1224A0	65MY 220MM 2 COLOURS SHRINK TUBE	0.200	M																										
VM2450A0	THROUG-WAL L CONNECTION 3 PIPES	1	PZ																										
VM2450A0	THROUG-WAL L CONNECTION 3 PIPES	1	PZ																										
0H2561A	6 S. DOOR COUNTERBRACKET		0H2561A0	6 S. DOOR COUNTERBRACKET																									



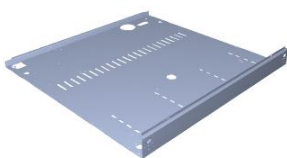

COMPONENT			SPARE PART														
Code	Description	Image	Code	Description	Components list												
VM1240A	NYLON SUPPORT CAP		KVM1240A	4 PCS COUNTER BRACKET SUPPORT CAP KIT	<table border="1"> <thead> <tr> <th>Code</th> <th>Description</th> <th>Qty</th> <th>UOM</th> </tr> </thead> <tbody> <tr> <td>VM1224A0</td> <td>65MY 220MM 2 COLOURS SHRINK TUBE</td> <td>0.200</td> <td>M</td> </tr> <tr> <td>VM1240A0</td> <td>NYLON SUPPORT CAP</td> <td>4</td> <td>PZ</td> </tr> </tbody> </table>	Code	Description	Qty	UOM	VM1224A0	65MY 220MM 2 COLOURS SHRINK TUBE	0.200	M	VM1240A0	NYLON SUPPORT CAP	4	PZ
Code	Description	Qty	UOM														
VM1224A0	65MY 220MM 2 COLOURS SHRINK TUBE	0.200	M														
VM1240A0	NYLON SUPPORT CAP	4	PZ														
VM2310A	UPPER DOOR BRACKET HOLES COVER		KVM2310A	UPPER BRACKET HOLE COVER KIT	<table border="1"> <thead> <tr> <th>Code</th> <th>Description</th> <th>Qty</th> <th>UOM</th> </tr> </thead> <tbody> <tr> <td>VM1224A0</td> <td>65MY 220MM 2 COLOURS SHRINK TUBE</td> <td>0.300</td> <td>M</td> </tr> <tr> <td>VM2310A0</td> <td>UPPER DOOR BRACKET HOLES COVER</td> <td>1</td> <td>PZ</td> </tr> </tbody> </table>	Code	Description	Qty	UOM	VM1224A0	65MY 220MM 2 COLOURS SHRINK TUBE	0.300	M	VM2310A0	UPPER DOOR BRACKET HOLES COVER	1	PZ
Code	Description	Qty	UOM														
VM1224A0	65MY 220MM 2 COLOURS SHRINK TUBE	0.300	M														
VM2310A0	UPPER DOOR BRACKET HOLES COVER	1	PZ														
0D2305B	XEBC-04EU-E EXTERNAL TOP COVER		0D2305B1	XEBC-04EU-E EXTERNAL TOP COVER													
0E1351C	XEBC EXTERNAL BOTTOM PANEL		0E1351C0	XEBC EXTERNAL BOTTOM PANEL													
0D2308A	XEBC-06EU-E LEFT SIDE PANEL		0D2308A3	XEBC-06EU-E LEFT SIDE PANEL													

COMPONENT			SPARE PART																						
Code	Description	Image	Code	Description	Components list																				
VM2249A	COOKING CHAMBER FRONT CORNER		KVM2249A	CHAMBER FRONT PROFILE CORNER KIT	<table border="1"> <thead> <tr> <th>Code</th> <th>Description</th> <th>Qty</th> <th>UOM</th> </tr> </thead> <tbody> <tr> <td>VM1224A0</td> <td>65MY 220MM 2 COLOURS SHRINK TUBE</td> <td>0.150</td> <td>M</td> </tr> <tr> <td>VM2249A0</td> <td>COOKING CHAMBER FRONT CORNER</td> <td>1</td> <td>PZ</td> </tr> </tbody> </table>	Code	Description	Qty	UOM	VM1224A0	65MY 220MM 2 COLOURS SHRINK TUBE	0.150	M	VM2249A0	COOKING CHAMBER FRONT CORNER	1	PZ								
Code	Description	Qty	UOM																						
VM1224A0	65MY 220MM 2 COLOURS SHRINK TUBE	0.150	M																						
VM2249A0	COOKING CHAMBER FRONT CORNER	1	PZ																						
VL1086A	LIMESCALE REMOVER NEODYMIUM MAGNET		KVL1086A	NEODYMIUM MAGNET ANTI-LIMESCALE KI	<table border="1"> <thead> <tr> <th>Code</th> <th>Description</th> <th>Qty</th> <th>UOM</th> </tr> </thead> <tbody> <tr> <td>VL1086A0</td> <td>LIMESCALE REMOVER NEODYMIUM MAGNET</td> <td>2</td> <td>PZ</td> </tr> <tr> <td>VM1224A0</td> <td>65MY 220MM 2 COLOURS SHRINK TUBE</td> <td>0.200</td> <td>M</td> </tr> </tbody> </table>	Code	Description	Qty	UOM	VL1086A0	LIMESCALE REMOVER NEODYMIUM MAGNET	2	PZ	VM1224A0	65MY 220MM 2 COLOURS SHRINK TUBE	0.200	M								
Code	Description	Qty	UOM																						
VL1086A0	LIMESCALE REMOVER NEODYMIUM MAGNET	2	PZ																						
VM1224A0	65MY 220MM 2 COLOURS SHRINK TUBE	0.200	M																						
VL1096A	2PCS T-SHAPED FIT-D6-D10 HOLD-MAGNET		KVL1096A	T - SHAPED FIT-D6-D10 HOLD-2 MAGNETS KIT	<table border="1"> <thead> <tr> <th>Code</th> <th>Description</th> <th>Qty</th> <th>UOM</th> </tr> </thead> <tbody> <tr> <td>RC1018A0</td> <td>ZINC PLATED D12 ELASTIC CLAMP</td> <td>2</td> <td>PZ</td> </tr> <tr> <td>VL1086A0</td> <td>LIMESCALE REMOVER NEODYMIUM MAGNET</td> <td>2</td> <td>PZ</td> </tr> <tr> <td>VL1096A1</td> <td>2PCS T-SHAPED FIT-D6-D10 HOLD-MAGNET</td> <td>1</td> <td>PZ</td> </tr> <tr> <td>VM1224A0</td> <td>65MY 220MM 2 COLOURS SHRINK TUBE</td> <td>0.200</td> <td>M</td> </tr> </tbody> </table>	Code	Description	Qty	UOM	RC1018A0	ZINC PLATED D12 ELASTIC CLAMP	2	PZ	VL1086A0	LIMESCALE REMOVER NEODYMIUM MAGNET	2	PZ	VL1096A1	2PCS T-SHAPED FIT-D6-D10 HOLD-MAGNET	1	PZ	VM1224A0	65MY 220MM 2 COLOURS SHRINK TUBE	0.200	M
Code	Description	Qty	UOM																						
RC1018A0	ZINC PLATED D12 ELASTIC CLAMP	2	PZ																						
VL1086A0	LIMESCALE REMOVER NEODYMIUM MAGNET	2	PZ																						
VL1096A1	2PCS T-SHAPED FIT-D6-D10 HOLD-MAGNET	1	PZ																						
VM1224A0	65MY 220MM 2 COLOURS SHRINK TUBE	0.200	M																						
VM1054A	H7.8 PRESSURE REDUCER RING NUT		KVM1054A	H7.8 PRESSURE REDUCER DIAL KIT	<table border="1"> <thead> <tr> <th>Code</th> <th>Description</th> <th>Qty</th> <th>UOM</th> </tr> </thead> <tbody> <tr> <td>VM1054A0</td> <td>H7.8 PRESSURE REDUCER RING NUT</td> <td>1</td> <td>PZ</td> </tr> <tr> <td>VM1224A0</td> <td>65MY 220MM 2 COLOURS SHRINK TUBE</td> <td>0.200</td> <td>M</td> </tr> </tbody> </table>	Code	Description	Qty	UOM	VM1054A0	H7.8 PRESSURE REDUCER RING NUT	1	PZ	VM1224A0	65MY 220MM 2 COLOURS SHRINK TUBE	0.200	M								
Code	Description	Qty	UOM																						
VM1054A0	H7.8 PRESSURE REDUCER RING NUT	1	PZ																						
VM1224A0	65MY 220MM 2 COLOURS SHRINK TUBE	0.200	M																						
			KVL1117A	EUR MM 2016+LMT FILTER+PRESS. RED. KIT	<table border="1"> <thead> <tr> <th>Code</th> <th>Description</th> <th>Qty</th> <th>UOM</th> </tr> </thead> <tbody> <tr> <td>0H7472A1</td> <td>DISTRIBUTOR SUPPORT PLATE</td> <td>1</td> <td>PZ</td> </tr> <tr> <td>RC1004A0</td> <td>Ø10-Ø8-8 Y CONNECTION</td> <td>1</td> <td>PZ</td> </tr> <tr> <td>RC1243A0</td> <td>Ø10F-Ø10M ELBOW CONNECTION + JG END KIT</td> <td>1</td> <td>PZ</td> </tr> </tbody> </table>	Code	Description	Qty	UOM	0H7472A1	DISTRIBUTOR SUPPORT PLATE	1	PZ	RC1004A0	Ø10-Ø8-8 Y CONNECTION	1	PZ	RC1243A0	Ø10F-Ø10M ELBOW CONNECTION + JG END KIT	1	PZ				
Code	Description	Qty	UOM																						
0H7472A1	DISTRIBUTOR SUPPORT PLATE	1	PZ																						
RC1004A0	Ø10-Ø8-8 Y CONNECTION	1	PZ																						
RC1243A0	Ø10F-Ø10M ELBOW CONNECTION + JG END KIT	1	PZ																						



COMPONENT			SPARE PART																																		
Code	Description	Image	Code	Description	Components list																																
VM1054A	H7.8 PRESSURE REDUCER RING NUT		KVL1117A	EUR MM 2016+LMT FILTER+PRESS. RED. KIT	<table border="1"> <thead> <tr> <th>Code</th> <th>Description</th> <th>Qty</th> <th>UOM</th> </tr> </thead> <tbody> <tr> <td>RC1372A0</td> <td>Ø10M-1/4 M CIL. STRAIGHT FITTING</td> <td>2</td> <td>PZ</td> </tr> <tr> <td>VI1220A1</td> <td>4,2X12 TCB SELF-TAPPING SCREW</td> <td>4</td> <td>PZ</td> </tr> <tr> <td>VL1014B1</td> <td>PRESSURE REDUCER WITH DISTRIBUTOR</td> <td>1</td> <td>PZ</td> </tr> <tr> <td>VL1014B2</td> <td>PRESSURE REDUCER WITH DISTRIBUTOR</td> <td>1</td> <td>PZ</td> </tr> <tr> <td>VL1034C0</td> <td>MESH WATER FILTER D10</td> <td>1</td> <td>PZ</td> </tr> <tr> <td>VL1062C0</td> <td>PRESSURE REDUCER-FILTER LOCKING FORK</td> <td>1</td> <td>PZ</td> </tr> <tr> <td>VM1054A0</td> <td>H7.8 PRESSURE REDUCER RING NUT</td> <td>1</td> <td>PZ</td> </tr> </tbody> </table>	Code	Description	Qty	UOM	RC1372A0	Ø10M-1/4 M CIL. STRAIGHT FITTING	2	PZ	VI1220A1	4,2X12 TCB SELF-TAPPING SCREW	4	PZ	VL1014B1	PRESSURE REDUCER WITH DISTRIBUTOR	1	PZ	VL1014B2	PRESSURE REDUCER WITH DISTRIBUTOR	1	PZ	VL1034C0	MESH WATER FILTER D10	1	PZ	VL1062C0	PRESSURE REDUCER-FILTER LOCKING FORK	1	PZ	VM1054A0	H7.8 PRESSURE REDUCER RING NUT	1	PZ
Code	Description	Qty	UOM																																		
RC1372A0	Ø10M-1/4 M CIL. STRAIGHT FITTING	2	PZ																																		
VI1220A1	4,2X12 TCB SELF-TAPPING SCREW	4	PZ																																		
VL1014B1	PRESSURE REDUCER WITH DISTRIBUTOR	1	PZ																																		
VL1014B2	PRESSURE REDUCER WITH DISTRIBUTOR	1	PZ																																		
VL1034C0	MESH WATER FILTER D10	1	PZ																																		
VL1062C0	PRESSURE REDUCER-FILTER LOCKING FORK	1	PZ																																		
VM1054A0	H7.8 PRESSURE REDUCER RING NUT	1	PZ																																		
RC1396A	JG D10-1/4 STRAIGHT END FITTING		KVL0014B	EUR 2017 MIND.MAPS PRESSURE REDUCER KIT	<table border="1"> <thead> <tr> <th>Code</th> <th>Description</th> <th>Qty</th> <th>UOM</th> </tr> </thead> <tbody> <tr> <td>RC1372A0</td> <td>Ø10M-1/4 M CIL. STRAIGHT FITTING</td> <td>1</td> <td>PZ</td> </tr> <tr> <td>RC1396A0</td> <td>JG D10-1/4 STRAIGHT END FITTING</td> <td>1</td> <td>PZ</td> </tr> <tr> <td>VL1014B1</td> <td>PRESSURE REDUCER WITH DISTRIBUTOR</td> <td>1</td> <td>PZ</td> </tr> <tr> <td>VL1014B2</td> <td>PRESSURE REDUCER WITH DISTRIBUTOR</td> <td>1</td> <td>PZ</td> </tr> <tr> <td>VM1054A0</td> <td>H7.8 PRESSURE REDUCER RING NUT</td> <td>1</td> <td>PZ</td> </tr> </tbody> </table>	Code	Description	Qty	UOM	RC1372A0	Ø10M-1/4 M CIL. STRAIGHT FITTING	1	PZ	RC1396A0	JG D10-1/4 STRAIGHT END FITTING	1	PZ	VL1014B1	PRESSURE REDUCER WITH DISTRIBUTOR	1	PZ	VL1014B2	PRESSURE REDUCER WITH DISTRIBUTOR	1	PZ	VM1054A0	H7.8 PRESSURE REDUCER RING NUT	1	PZ								
Code	Description	Qty	UOM																																		
RC1372A0	Ø10M-1/4 M CIL. STRAIGHT FITTING	1	PZ																																		
RC1396A0	JG D10-1/4 STRAIGHT END FITTING	1	PZ																																		
VL1014B1	PRESSURE REDUCER WITH DISTRIBUTOR	1	PZ																																		
VL1014B2	PRESSURE REDUCER WITH DISTRIBUTOR	1	PZ																																		
VM1054A0	H7.8 PRESSURE REDUCER RING NUT	1	PZ																																		
VL1014B	PRESSURE REDUCER WITH DISTRIBUTOR		KVL0020A	PRESS. REDUCER 03-05XX=OCT18 / MM=MAR19	<table border="1"> <thead> <tr> <th>Code</th> <th>Description</th> <th>Qty</th> <th>UOM</th> </tr> </thead> <tbody> <tr> <td>RC1396A0</td> <td>JG D10-1/4 STRAIGHT END FITTING</td> <td>2</td> <td>PZ</td> </tr> <tr> <td>VL1014B1</td> <td>PRESSURE REDUCER WITH DISTRIBUTOR</td> <td>1</td> <td>PZ</td> </tr> </tbody> </table>	Code	Description	Qty	UOM	RC1396A0	JG D10-1/4 STRAIGHT END FITTING	2	PZ	VL1014B1	PRESSURE REDUCER WITH DISTRIBUTOR	1	PZ																				
Code	Description	Qty	UOM																																		
RC1396A0	JG D10-1/4 STRAIGHT END FITTING	2	PZ																																		
VL1014B1	PRESSURE REDUCER WITH DISTRIBUTOR	1	PZ																																		

COMPONENT			SPARE PART																							
Code	Description	Image	Code	Description	Components list																					
VL1014B	PRESSURE REDUCER WITH DISTRIBUTOR		KVL0020A	PRESS. REDUCER 03-05XX=OCT18 / MM=MAR19	<table border="1"> <thead> <tr> <th>Code</th> <th>Description</th> <th>Qty</th> <th>UOM</th> </tr> </thead> <tbody> <tr> <td>VL1014B2</td> <td>PRESSURE REDUCER WITH DISTRIBUTOR</td> <td>1</td> <td>PZ</td> </tr> <tr> <td>VM1054A0</td> <td>H7.8 PRESSURE REDUCER RING NUT</td> <td>1</td> <td>PZ</td> </tr> </tbody> </table>	Code	Description	Qty	UOM	VL1014B2	PRESSURE REDUCER WITH DISTRIBUTOR	1	PZ	VM1054A0	H7.8 PRESSURE REDUCER RING NUT	1	PZ									
			Code	Description	Qty	UOM																				
			VL1014B2	PRESSURE REDUCER WITH DISTRIBUTOR	1	PZ																				
			VM1054A0	H7.8 PRESSURE REDUCER RING NUT	1	PZ																				
KVL0014B	EUR 2017 MIND.MAPS PRESSURE REDUCER KIT	<table border="1"> <thead> <tr> <th>Code</th> <th>Description</th> <th>Qty</th> <th>UOM</th> </tr> </thead> <tbody> <tr> <td>RC1372A0</td> <td>Ø10M-1/4 M CIL. STRAIGHT FITTING</td> <td>1</td> <td>PZ</td> </tr> <tr> <td>RC1396A0</td> <td>JG D10-1/4 STRAIGHT END FITTING</td> <td>1</td> <td>PZ</td> </tr> <tr> <td>VL1014B1</td> <td>PRESSURE REDUCER WITH DISTRIBUTOR</td> <td>1</td> <td>PZ</td> </tr> <tr> <td>VL1014B2</td> <td>PRESSURE REDUCER WITH DISTRIBUTOR</td> <td>1</td> <td>PZ</td> </tr> <tr> <td>VM1054A0</td> <td>H7.8 PRESSURE REDUCER RING NUT</td> <td>1</td> <td>PZ</td> </tr> </tbody> </table>	Code	Description	Qty	UOM	RC1372A0	Ø10M-1/4 M CIL. STRAIGHT FITTING	1	PZ	RC1396A0	JG D10-1/4 STRAIGHT END FITTING	1	PZ	VL1014B1	PRESSURE REDUCER WITH DISTRIBUTOR	1	PZ	VL1014B2	PRESSURE REDUCER WITH DISTRIBUTOR	1	PZ	VM1054A0	H7.8 PRESSURE REDUCER RING NUT	1	PZ
Code	Description	Qty	UOM																							
RC1372A0	Ø10M-1/4 M CIL. STRAIGHT FITTING	1	PZ																							
RC1396A0	JG D10-1/4 STRAIGHT END FITTING	1	PZ																							
VL1014B1	PRESSURE REDUCER WITH DISTRIBUTOR	1	PZ																							
VL1014B2	PRESSURE REDUCER WITH DISTRIBUTOR	1	PZ																							
VM1054A0	H7.8 PRESSURE REDUCER RING NUT	1	PZ																							
KVL0014A	EUR MIND.MAPS PRESSURE REDUCER KIT 2016	<table border="1"> <thead> <tr> <th>Code</th> <th>Description</th> <th>Qty</th> <th>UOM</th> </tr> </thead> <tbody> <tr> <td>RC1372A0</td> <td>Ø10M-1/4 M CIL. STRAIGHT FITTING</td> <td>2</td> <td>PZ</td> </tr> <tr> <td>VL1014B1</td> <td>PRESSURE REDUCER WITH DISTRIBUTOR</td> <td>1</td> <td>PZ</td> </tr> <tr> <td>VL1014B2</td> <td>PRESSURE REDUCER WITH DISTRIBUTOR</td> <td>1</td> <td>PZ</td> </tr> <tr> <td>VM1054A0</td> <td>H7.8 PRESSURE REDUCER RING NUT</td> <td>1</td> <td>PZ</td> </tr> </tbody> </table>	Code	Description	Qty	UOM	RC1372A0	Ø10M-1/4 M CIL. STRAIGHT FITTING	2	PZ	VL1014B1	PRESSURE REDUCER WITH DISTRIBUTOR	1	PZ	VL1014B2	PRESSURE REDUCER WITH DISTRIBUTOR	1	PZ	VM1054A0	H7.8 PRESSURE REDUCER RING NUT	1	PZ				
Code	Description	Qty	UOM																							
RC1372A0	Ø10M-1/4 M CIL. STRAIGHT FITTING	2	PZ																							
VL1014B1	PRESSURE REDUCER WITH DISTRIBUTOR	1	PZ																							
VL1014B2	PRESSURE REDUCER WITH DISTRIBUTOR	1	PZ																							
VM1054A0	H7.8 PRESSURE REDUCER RING NUT	1	PZ																							
KVL0010A	S.4 - 5 WATER PRESSURE REDUCER KIT	<table border="1"> <thead> <tr> <th>Code</th> <th>Description</th> <th>Qty</th> <th>UOM</th> </tr> </thead> <tbody> <tr> <td>EL1210A0</td> <td>D8-BSP1/4 JG STRAIGHT END CONNECTION</td> <td>2</td> <td>PZ</td> </tr> </tbody> </table>	Code	Description	Qty	UOM	EL1210A0	D8-BSP1/4 JG STRAIGHT END CONNECTION	2	PZ																
Code	Description	Qty	UOM																							
EL1210A0	D8-BSP1/4 JG STRAIGHT END CONNECTION	2	PZ																							

COMPONENT			SPARE PART																																														
Code	Description	Image	Code	Description	Components list																																												
VL1014B	PRESSURE REDUCER WITH DISTRIBUTOR		KVL0010A	S.4 - 5 WATER PRESSURE REDUCER KIT	<table border="1"> <thead> <tr> <th>Code</th> <th>Description</th> <th>Qty</th> <th>UOM</th> </tr> </thead> <tbody> <tr> <td>VL1014B1</td> <td>PRESSURE REDUCER WITH DISTRIBUTOR</td> <td>1</td> <td>PZ</td> </tr> <tr> <td>VL1014B2</td> <td>PRESSURE REDUCER WITH DISTRIBUTOR</td> <td>1</td> <td>PZ</td> </tr> </tbody> </table>	Code	Description	Qty	UOM	VL1014B1	PRESSURE REDUCER WITH DISTRIBUTOR	1	PZ	VL1014B2	PRESSURE REDUCER WITH DISTRIBUTOR	1	PZ																																
					Code	Description	Qty	UOM																																									
VL1014B1	PRESSURE REDUCER WITH DISTRIBUTOR	1	PZ																																														
VL1014B2	PRESSURE REDUCER WITH DISTRIBUTOR	1	PZ																																														
RC1243A	Ø10F-Ø10M ELBOW CONNECTION + JG END KIT		KVL1117A	EUR MM 2016+LMT FILTER+PRESS. RED. KIT	<table border="1"> <thead> <tr> <th>Code</th> <th>Description</th> <th>Qty</th> <th>UOM</th> </tr> </thead> <tbody> <tr> <td>0H7472A1</td> <td>DISTRIBUTOR SUPPORT PLATE</td> <td>1</td> <td>PZ</td> </tr> <tr> <td>RC1004A0</td> <td>Ø10-Ø8-8 Y CONNECTION</td> <td>1</td> <td>PZ</td> </tr> <tr> <td>RC1243A0</td> <td>Ø10F-Ø10M ELBOW CONNECTION + JG END KIT</td> <td>1</td> <td>PZ</td> </tr> <tr> <td>RC1372A0</td> <td>Ø10M-1/4 M CIL. STRAIGHT FITTING</td> <td>2</td> <td>PZ</td> </tr> <tr> <td>VI1220A1</td> <td>4,2X12 TCB SELF-TAPPING SCREW</td> <td>4</td> <td>PZ</td> </tr> <tr> <td>VL1014B1</td> <td>PRESSURE REDUCER WITH DISTRIBUTOR</td> <td>1</td> <td>PZ</td> </tr> <tr> <td>VL1014B2</td> <td>PRESSURE REDUCER WITH DISTRIBUTOR</td> <td>1</td> <td>PZ</td> </tr> <tr> <td>VL1034C0</td> <td>MESH WATER FILTER D10</td> <td>1</td> <td>PZ</td> </tr> <tr> <td>VL1062C0</td> <td>PRESSURE REDUCER-FILTER LOCKING FORK</td> <td>1</td> <td>PZ</td> </tr> <tr> <td>VM1054A0</td> <td>H7.8 PRESSURE REDUCER RING NUT</td> <td>1</td> <td>PZ</td> </tr> </tbody> </table>	Code	Description	Qty	UOM	0H7472A1	DISTRIBUTOR SUPPORT PLATE	1	PZ	RC1004A0	Ø10-Ø8-8 Y CONNECTION	1	PZ	RC1243A0	Ø10F-Ø10M ELBOW CONNECTION + JG END KIT	1	PZ	RC1372A0	Ø10M-1/4 M CIL. STRAIGHT FITTING	2	PZ	VI1220A1	4,2X12 TCB SELF-TAPPING SCREW	4	PZ	VL1014B1	PRESSURE REDUCER WITH DISTRIBUTOR	1	PZ	VL1014B2	PRESSURE REDUCER WITH DISTRIBUTOR	1	PZ	VL1034C0	MESH WATER FILTER D10	1	PZ	VL1062C0	PRESSURE REDUCER-FILTER LOCKING FORK	1	PZ	VM1054A0	H7.8 PRESSURE REDUCER RING NUT	1	PZ
					Code	Description	Qty	UOM																																									
					0H7472A1	DISTRIBUTOR SUPPORT PLATE	1	PZ																																									
					RC1004A0	Ø10-Ø8-8 Y CONNECTION	1	PZ																																									
					RC1243A0	Ø10F-Ø10M ELBOW CONNECTION + JG END KIT	1	PZ																																									
					RC1372A0	Ø10M-1/4 M CIL. STRAIGHT FITTING	2	PZ																																									
					VI1220A1	4,2X12 TCB SELF-TAPPING SCREW	4	PZ																																									
					VL1014B1	PRESSURE REDUCER WITH DISTRIBUTOR	1	PZ																																									
					VL1014B2	PRESSURE REDUCER WITH DISTRIBUTOR	1	PZ																																									
					VL1034C0	MESH WATER FILTER D10	1	PZ																																									
					VL1062C0	PRESSURE REDUCER-FILTER LOCKING FORK	1	PZ																																									
					VM1054A0	H7.8 PRESSURE REDUCER RING NUT	1	PZ																																									
					KRC1243A	Ø10F-Ø10M ELBOW CONN + JG END 10 PCS KIT				<table border="1"> <thead> <tr> <th>Code</th> <th>Description</th> <th>Qty</th> <th>UOM</th> </tr> </thead> <tbody> <tr> <td>RC1243A0</td> <td>Ø10F-Ø10M ELBOW CONNECTION + JG END KIT</td> <td>10</td> <td>PZ</td> </tr> <tr> <td>VM1224A0</td> <td>65MY 220MM 2 COLOURS SHRINK TUBE</td> <td>0.200</td> <td>M</td> </tr> </tbody> </table>	Code	Description	Qty	UOM	RC1243A0	Ø10F-Ø10M ELBOW CONNECTION + JG END KIT	10	PZ	VM1224A0	65MY 220MM 2 COLOURS SHRINK TUBE	0.200	M																											
										Code	Description	Qty	UOM																																				
RC1243A0	Ø10F-Ø10M ELBOW CONNECTION + JG END KIT	10	PZ																																														
VM1224A0	65MY 220MM 2 COLOURS SHRINK TUBE	0.200	M																																														



COMPONENT			SPARE PART														
Code	Description	Image	Code	Description	Components list												
VL1135A	3/4-JG10 CONNECTOR + FILTER AND NRV		KVL1135A	3/4-JG10 FITTING WITH FILTER AND VNR KIT	<table border="1"> <thead> <tr> <th>Code</th> <th>Description</th> <th>Qty</th> <th>UOM</th> </tr> </thead> <tbody> <tr> <td>VL1135A0</td> <td>3/4-JG10 CONNECTOR + FILTER AND NRV</td> <td>1</td> <td>PZ</td> </tr> <tr> <td>VM1224A0</td> <td>65MY 220MM 2 COLOURS SHRINK TUBE</td> <td>0.150</td> <td>M</td> </tr> </tbody> </table>	Code	Description	Qty	UOM	VL1135A0	3/4-JG10 CONNECTOR + FILTER AND NRV	1	PZ	VM1224A0	65MY 220MM 2 COLOURS SHRINK TUBE	0.150	M
Code	Description	Qty	UOM														
VL1135A0	3/4-JG10 CONNECTOR + FILTER AND NRV	1	PZ														
VM1224A0	65MY 220MM 2 COLOURS SHRINK TUBE	0.150	M														
TB3251A	TB3131A-H2O STEAM INLET PIPE		KTB3131A	WHITE-BLACK 6X12 REINFORCED PIPE 3M KIT	<table border="1"> <thead> <tr> <th>Code</th> <th>Description</th> <th>Qty</th> <th>UOM</th> </tr> </thead> <tbody> <tr> <td>TB3131A0</td> <td>WHITE-BLACK EPDM TEXTILE BRAID HOSE 6X12</td> <td>3</td> <td>M</td> </tr> <tr> <td>VM1794A0</td> <td>250X4.8 PA66 BLACK CLAMP</td> <td>1</td> <td>PZ</td> </tr> </tbody> </table>	Code	Description	Qty	UOM	TB3131A0	WHITE-BLACK EPDM TEXTILE BRAID HOSE 6X12	3	M	VM1794A0	250X4.8 PA66 BLACK CLAMP	1	PZ
Code	Description	Qty	UOM														
TB3131A0	WHITE-BLACK EPDM TEXTILE BRAID HOSE 6X12	3	M														
VM1794A0	250X4.8 PA66 BLACK CLAMP	1	PZ														
0H8038A	MM REDUCER SUPPORT PLATE		0H8038A0	MM REDUCER SUPPORT PLATE													
0H2561A	6 S. DOOR COUNTERBRACKET		0H2561A0	6 S. DOOR COUNTERBRACKET													
VM1240A	NYLON SUPPORT CAP		KVM1240A	4 PCS COUNTER BRACKET SUPPORT CAP KIT	<table border="1"> <thead> <tr> <th>Code</th> <th>Description</th> <th>Qty</th> <th>UOM</th> </tr> </thead> <tbody> <tr> <td>VM1224A0</td> <td>65MY 220MM 2 COLOURS SHRINK TUBE</td> <td>0.200</td> <td>M</td> </tr> <tr> <td>VM1240A0</td> <td>NYLON SUPPORT CAP</td> <td>4</td> <td>PZ</td> </tr> </tbody> </table>	Code	Description	Qty	UOM	VM1224A0	65MY 220MM 2 COLOURS SHRINK TUBE	0.200	M	VM1240A0	NYLON SUPPORT CAP	4	PZ
Code	Description	Qty	UOM														
VM1224A0	65MY 220MM 2 COLOURS SHRINK TUBE	0.200	M														
VM1240A0	NYLON SUPPORT CAP	4	PZ														

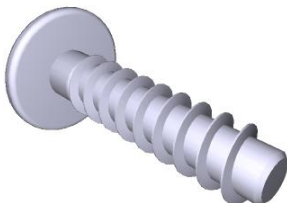

COMPONENT			SPARE PART																																						
Code	Description	Image	Code	Description	Components list																																				
VE1020B	MAGNET DOOR MICROSWITCH		KVE1020B	MICROSWITCH KIT	<table border="1"> <thead> <tr> <th>Code</th> <th>Description</th> <th>Qty</th> <th>UOM</th> </tr> </thead> <tbody> <tr> <td>CE1030A0</td> <td>FEMALE FASTON COVER 6.3X0.8 0,5-1MMQ</td> <td>2</td> <td>PZ</td> </tr> <tr> <td>CE1660A0</td> <td>6,3X0,8 FEMALE FASTON COVE</td> <td>2</td> <td>PZ</td> </tr> <tr> <td>CE1730A0</td> <td>PVC CABLE NP 2 X AWG22 STYLE 2095</td> <td>0.150</td> <td>M</td> </tr> <tr> <td>CE1740A0</td> <td>MINIFIT MALE END FITTING</td> <td>2</td> <td>PZ</td> </tr> <tr> <td>CE1745A0</td> <td>2 WAYS FEMALE MINIFIT CONNECTOR</td> <td>1</td> <td>PZ</td> </tr> <tr> <td>VE1020B0</td> <td>MAGNET DOOR MICROSWITC</td> <td>1</td> <td>PZ</td> </tr> <tr> <td>VE1030A1</td> <td>MAGNET FOR DOOR MICROSWITC H D=22,9MM</td> <td>1</td> <td>PZ</td> </tr> <tr> <td>VM1224A0</td> <td>65MY 220MM 2 COLOURS SHRINK TUBE</td> <td>0.250</td> <td>M</td> </tr> </tbody> </table>	Code	Description	Qty	UOM	CE1030A0	FEMALE FASTON COVER 6.3X0.8 0,5-1MMQ	2	PZ	CE1660A0	6,3X0,8 FEMALE FASTON COVE	2	PZ	CE1730A0	PVC CABLE NP 2 X AWG22 STYLE 2095	0.150	M	CE1740A0	MINIFIT MALE END FITTING	2	PZ	CE1745A0	2 WAYS FEMALE MINIFIT CONNECTOR	1	PZ	VE1020B0	MAGNET DOOR MICROSWITC	1	PZ	VE1030A1	MAGNET FOR DOOR MICROSWITC H D=22,9MM	1	PZ	VM1224A0	65MY 220MM 2 COLOURS SHRINK TUBE	0.250	M
					Code	Description	Qty	UOM																																	
					CE1030A0	FEMALE FASTON COVER 6.3X0.8 0,5-1MMQ	2	PZ																																	
					CE1660A0	6,3X0,8 FEMALE FASTON COVE	2	PZ																																	
					CE1730A0	PVC CABLE NP 2 X AWG22 STYLE 2095	0.150	M																																	
					CE1740A0	MINIFIT MALE END FITTING	2	PZ																																	
					CE1745A0	2 WAYS FEMALE MINIFIT CONNECTOR	1	PZ																																	
					VE1020B0	MAGNET DOOR MICROSWITC	1	PZ																																	
					VE1030A1	MAGNET FOR DOOR MICROSWITC H D=22,9MM	1	PZ																																	
					VM1224A0	65MY 220MM 2 COLOURS SHRINK TUBE	0.250	M																																	
VP1075A	PLUS/1/ZERO MICROSWITCH SUPPORT COVER		KVP1075A	- M MICROSWITCH SUPPORT PLATE KI	<table border="1"> <thead> <tr> <th>Code</th> <th>Description</th> <th>Qty</th> <th>UOM</th> </tr> </thead> <tbody> <tr> <td>VM1224A0</td> <td>65MY 220MM 2 COLOURS SHRINK TUBE</td> <td>0.200</td> <td>M</td> </tr> <tr> <td>VP1075A0</td> <td>PLUS/1/ZERO MICROSWITC H SUPPORT COVER</td> <td>1</td> <td>PZ</td> </tr> </tbody> </table>	Code	Description	Qty	UOM	VM1224A0	65MY 220MM 2 COLOURS SHRINK TUBE	0.200	M	VP1075A0	PLUS/1/ZERO MICROSWITC H SUPPORT COVER	1	PZ																								
					Code	Description	Qty	UOM																																	
VM1224A0	65MY 220MM 2 COLOURS SHRINK TUBE	0.200	M																																						
VP1075A0	PLUS/1/ZERO MICROSWITC H SUPPORT COVER	1	PZ																																						
VM1190A	CT BT RIGHT DOOR SPRING LATCH		KVM1190A	CHEFTOP/BAKERTO P DOOR RIGHT LATCH KIT	<table border="1"> <thead> <tr> <th>Code</th> <th>Description</th> <th>Qty</th> <th>UOM</th> </tr> </thead> <tbody> <tr> <td>VI0239A1</td> <td>SELF-TAPPIN G SCREW 4.2X25 TCB+ INOX</td> <td>2</td> <td>PZ</td> </tr> <tr> <td>VI1220A1</td> <td>4,2X12 TCB SELF-TAPPIN G SCREW</td> <td>2</td> <td>PZ</td> </tr> <tr> <td>VM1190A2</td> <td>CT BT RIGHT DOOR SPRING LATCH</td> <td>1</td> <td>PZ</td> </tr> <tr> <td>VM1192A1</td> <td>CT BT DOOR SPRING LATCH BACK COVER</td> <td>1</td> <td>PZ</td> </tr> <tr> <td>VM1224A0</td> <td>65MY 220MM 2 COLOURS SHRINK TUBE</td> <td>0.200</td> <td>M</td> </tr> <tr> <td>VM1460A0</td> <td>XBC/XVC RIGHT DOOR LATCH CAP</td> <td>1</td> <td>PZ</td> </tr> </tbody> </table>	Code	Description	Qty	UOM	VI0239A1	SELF-TAPPIN G SCREW 4.2X25 TCB+ INOX	2	PZ	VI1220A1	4,2X12 TCB SELF-TAPPIN G SCREW	2	PZ	VM1190A2	CT BT RIGHT DOOR SPRING LATCH	1	PZ	VM1192A1	CT BT DOOR SPRING LATCH BACK COVER	1	PZ	VM1224A0	65MY 220MM 2 COLOURS SHRINK TUBE	0.200	M	VM1460A0	XBC/XVC RIGHT DOOR LATCH CAP	1	PZ								
					Code	Description	Qty	UOM																																	
					VI0239A1	SELF-TAPPIN G SCREW 4.2X25 TCB+ INOX	2	PZ																																	
					VI1220A1	4,2X12 TCB SELF-TAPPIN G SCREW	2	PZ																																	
					VM1190A2	CT BT RIGHT DOOR SPRING LATCH	1	PZ																																	
					VM1192A1	CT BT DOOR SPRING LATCH BACK COVER	1	PZ																																	
VM1224A0	65MY 220MM 2 COLOURS SHRINK TUBE	0.200	M																																						
VM1460A0	XBC/XVC RIGHT DOOR LATCH CAP	1	PZ																																						





COMPONENT			SPARE PART																														
Code	Description	Image	Code	Description	Components list																												
VM1192A	CT BT DOOR SPRING LATCH BACK COVER		KVM1191A	CHEFTOP/BAKERTO P DOOR LEFT LATCH KIT	<table border="1"> <thead> <tr> <th>Code</th> <th>Description</th> <th>Qty</th> <th>UOM</th> </tr> </thead> <tbody> <tr> <td>VI0239A1</td> <td>SELF-TAPPIN G SCREW 4.2X25 TCB+ INOX</td> <td>2</td> <td>PZ</td> </tr> <tr> <td>VI1220A1</td> <td>4.2X12 TCB SELF-TAPPIN G SCREW</td> <td>2</td> <td>PZ</td> </tr> <tr> <td>VM1191A2</td> <td>CT BT LEFT DOOR SPRING LATCH</td> <td>1</td> <td>PZ</td> </tr> <tr> <td>VM1192A1</td> <td>CT BT DOOR SPRING LATCH BACK COVER</td> <td>1</td> <td>PZ</td> </tr> <tr> <td>VM1224A0</td> <td>65MY 220MM 2 COLOURS SHRINK TUBE</td> <td>0.200</td> <td>M</td> </tr> <tr> <td>VM1460A0</td> <td>XBC/XVC RIGHT DOOR LATCH CAP</td> <td>1</td> <td>PZ</td> </tr> </tbody> </table>	Code	Description	Qty	UOM	VI0239A1	SELF-TAPPIN G SCREW 4.2X25 TCB+ INOX	2	PZ	VI1220A1	4.2X12 TCB SELF-TAPPIN G SCREW	2	PZ	VM1191A2	CT BT LEFT DOOR SPRING LATCH	1	PZ	VM1192A1	CT BT DOOR SPRING LATCH BACK COVER	1	PZ	VM1224A0	65MY 220MM 2 COLOURS SHRINK TUBE	0.200	M	VM1460A0	XBC/XVC RIGHT DOOR LATCH CAP	1	PZ
			Code	Description	Qty	UOM																											
VI0239A1	SELF-TAPPIN G SCREW 4.2X25 TCB+ INOX	2	PZ																														
VI1220A1	4.2X12 TCB SELF-TAPPIN G SCREW	2	PZ																														
VM1191A2	CT BT LEFT DOOR SPRING LATCH	1	PZ																														
VM1192A1	CT BT DOOR SPRING LATCH BACK COVER	1	PZ																														
VM1224A0	65MY 220MM 2 COLOURS SHRINK TUBE	0.200	M																														
VM1460A0	XBC/XVC RIGHT DOOR LATCH CAP	1	PZ																														
KVM1190A	CHEFTOP/BAKERTO P DOOR RIGHT LATCH KIT	<table border="1"> <thead> <tr> <th>Code</th> <th>Description</th> <th>Qty</th> <th>UOM</th> </tr> </thead> <tbody> <tr> <td>VI0239A1</td> <td>SELF-TAPPIN G SCREW 4.2X25 TCB+ INOX</td> <td>2</td> <td>PZ</td> </tr> <tr> <td>VI1220A1</td> <td>4.2X12 TCB SELF-TAPPIN G SCREW</td> <td>2</td> <td>PZ</td> </tr> <tr> <td>VM1190A2</td> <td>CT BT RIGHT DOOR SPRING LATCH</td> <td>1</td> <td>PZ</td> </tr> <tr> <td>VM1192A1</td> <td>CT BT DOOR SPRING LATCH BACK COVER</td> <td>1</td> <td>PZ</td> </tr> <tr> <td>VM1224A0</td> <td>65MY 220MM 2 COLOURS SHRINK TUBE</td> <td>0.200</td> <td>M</td> </tr> <tr> <td>VM1460A0</td> <td>XBC/XVC RIGHT DOOR LATCH CAP</td> <td>1</td> <td>PZ</td> </tr> </tbody> </table>	Code	Description	Qty	UOM	VI0239A1	SELF-TAPPIN G SCREW 4.2X25 TCB+ INOX	2	PZ	VI1220A1	4.2X12 TCB SELF-TAPPIN G SCREW	2	PZ	VM1190A2	CT BT RIGHT DOOR SPRING LATCH	1	PZ	VM1192A1	CT BT DOOR SPRING LATCH BACK COVER	1	PZ	VM1224A0	65MY 220MM 2 COLOURS SHRINK TUBE	0.200	M	VM1460A0	XBC/XVC RIGHT DOOR LATCH CAP	1	PZ			
Code	Description	Qty	UOM																														
VI0239A1	SELF-TAPPIN G SCREW 4.2X25 TCB+ INOX	2	PZ																														
VI1220A1	4.2X12 TCB SELF-TAPPIN G SCREW	2	PZ																														
VM1190A2	CT BT RIGHT DOOR SPRING LATCH	1	PZ																														
VM1192A1	CT BT DOOR SPRING LATCH BACK COVER	1	PZ																														
VM1224A0	65MY 220MM 2 COLOURS SHRINK TUBE	0.200	M																														
VM1460A0	XBC/XVC RIGHT DOOR LATCH CAP	1	PZ																														
VI1074A	4X16 SCREW FOR PLASTIC		VI1074A0	4X16 SCREW FOR PLASTIC																													







COMPONENT			SPARE PART																														
Code	Description	Image	Code	Description	Components list																												
VM1630A	INTERNAL GLASS PUSHING CAP		KVM1630A	CAP FOR INTERNAL GLASS 10 PCS KIT	<table border="1"> <thead> <tr> <th>Code</th> <th>Description</th> <th>Qty</th> <th>UOM</th> </tr> </thead> <tbody> <tr> <td>VM1224A0</td> <td>65MY 220MM 2 COLOURS SHRINK TUBE</td> <td>0.200</td> <td>M</td> </tr> <tr> <td>VM1630A0</td> <td>INTERNAL GLASS PUSHING CAP</td> <td>10</td> <td>PZ</td> </tr> <tr> <td>VM1630A1</td> <td>INTERNAL GLASS PUSHING CAP</td> <td>10</td> <td>PZ</td> </tr> </tbody> </table>	Code	Description	Qty	UOM	VM1224A0	65MY 220MM 2 COLOURS SHRINK TUBE	0.200	M	VM1630A0	INTERNAL GLASS PUSHING CAP	10	PZ	VM1630A1	INTERNAL GLASS PUSHING CAP	10	PZ												
Code	Description	Qty	UOM																														
VM1224A0	65MY 220MM 2 COLOURS SHRINK TUBE	0.200	M																														
VM1630A0	INTERNAL GLASS PUSHING CAP	10	PZ																														
VM1630A1	INTERNAL GLASS PUSHING CAP	10	PZ																														
VM2280B	HANDLE LATCH PLATE COVER		KVM2280B	VM2280B -M HANDLE LATCH PLATE COVER KIT	<table border="1"> <thead> <tr> <th>Code</th> <th>Description</th> <th>Qty</th> <th>UOM</th> </tr> </thead> <tbody> <tr> <td>VI1074A0</td> <td>4X16 SCREW FOR PLASTIC</td> <td>2</td> <td>PZ</td> </tr> <tr> <td>VM1224A0</td> <td>65MY 220MM 2 COLOURS SHRINK TUBE</td> <td>0.200</td> <td>M</td> </tr> <tr> <td>VM1630A1</td> <td>INTERNAL GLASS PUSHING CAP</td> <td>2</td> <td>PZ</td> </tr> <tr> <td>VM2280B0</td> <td>HANDLE LATCH PLATE COVER</td> <td>1</td> <td>PZ</td> </tr> </tbody> </table>	Code	Description	Qty	UOM	VI1074A0	4X16 SCREW FOR PLASTIC	2	PZ	VM1224A0	65MY 220MM 2 COLOURS SHRINK TUBE	0.200	M	VM1630A1	INTERNAL GLASS PUSHING CAP	2	PZ	VM2280B0	HANDLE LATCH PLATE COVER	1	PZ								
Code	Description	Qty	UOM																														
VI1074A0	4X16 SCREW FOR PLASTIC	2	PZ																														
VM1224A0	65MY 220MM 2 COLOURS SHRINK TUBE	0.200	M																														
VM1630A1	INTERNAL GLASS PUSHING CAP	2	PZ																														
VM2280B0	HANDLE LATCH PLATE COVER	1	PZ																														
VM2281A	DOOR LATCH HOLES COVER		KVM2281A	HOLE PLATE COVER KIT	<table border="1"> <thead> <tr> <th>Code</th> <th>Description</th> <th>Qty</th> <th>UOM</th> </tr> </thead> <tbody> <tr> <td>VM1224A0</td> <td>65MY 220MM 2 COLOURS SHRINK TUBE</td> <td>0.200</td> <td>M</td> </tr> <tr> <td>VM2281A0</td> <td>DOOR LATCH HOLES COVER</td> <td>1</td> <td>PZ</td> </tr> </tbody> </table>	Code	Description	Qty	UOM	VM1224A0	65MY 220MM 2 COLOURS SHRINK TUBE	0.200	M	VM2281A0	DOOR LATCH HOLES COVER	1	PZ																
Code	Description	Qty	UOM																														
VM1224A0	65MY 220MM 2 COLOURS SHRINK TUBE	0.200	M																														
VM2281A0	DOOR LATCH HOLES COVER	1	PZ																														
VM1192A	CT BT DOOR SPRING LATCH BACK COVER		KVM1191A	CHEFTOP/BAKERTO P DOOR LEFT LATCH KIT	<table border="1"> <thead> <tr> <th>Code</th> <th>Description</th> <th>Qty</th> <th>UOM</th> </tr> </thead> <tbody> <tr> <td>VI0239A1</td> <td>SELF-TAPPIN G SCREW 4.2X25 TCB+ INOX</td> <td>2</td> <td>PZ</td> </tr> <tr> <td>VI1220A1</td> <td>4.2X12 TCB SELF-TAPPIN G SCREW</td> <td>2</td> <td>PZ</td> </tr> <tr> <td>VM1191A2</td> <td>CT BT LEFT DOOR SPRING LATCH</td> <td>1</td> <td>PZ</td> </tr> <tr> <td>VM1192A1</td> <td>CT BT DOOR SPRING LATCH BACK COVER</td> <td>1</td> <td>PZ</td> </tr> <tr> <td>VM1224A0</td> <td>65MY 220MM 2 COLOURS SHRINK TUBE</td> <td>0.200</td> <td>M</td> </tr> <tr> <td>VM1460A0</td> <td>XBC/XVC RIGHT DOOR LATCH CAP</td> <td>1</td> <td>PZ</td> </tr> </tbody> </table>	Code	Description	Qty	UOM	VI0239A1	SELF-TAPPIN G SCREW 4.2X25 TCB+ INOX	2	PZ	VI1220A1	4.2X12 TCB SELF-TAPPIN G SCREW	2	PZ	VM1191A2	CT BT LEFT DOOR SPRING LATCH	1	PZ	VM1192A1	CT BT DOOR SPRING LATCH BACK COVER	1	PZ	VM1224A0	65MY 220MM 2 COLOURS SHRINK TUBE	0.200	M	VM1460A0	XBC/XVC RIGHT DOOR LATCH CAP	1	PZ
Code	Description	Qty	UOM																														
VI0239A1	SELF-TAPPIN G SCREW 4.2X25 TCB+ INOX	2	PZ																														
VI1220A1	4.2X12 TCB SELF-TAPPIN G SCREW	2	PZ																														
VM1191A2	CT BT LEFT DOOR SPRING LATCH	1	PZ																														
VM1192A1	CT BT DOOR SPRING LATCH BACK COVER	1	PZ																														
VM1224A0	65MY 220MM 2 COLOURS SHRINK TUBE	0.200	M																														
VM1460A0	XBC/XVC RIGHT DOOR LATCH CAP	1	PZ																														

COMPONENT			SPARE PART																														
Code	Description	Image	Code	Description	Components list																												
VM1192A	CT BT DOOR SPRING LATCH BACK COVER		KVM1190A	CHEFTOP/BAKERTO P DOOR RIGHT LATCH KIT	<table border="1"> <thead> <tr> <th>Code</th> <th>Description</th> <th>Qty</th> <th>UOM</th> </tr> </thead> <tbody> <tr> <td>VI0239A1</td> <td>SELF-TAPPIN G SCREW 4.2X25 TCB+ INOX</td> <td>2</td> <td>PZ</td> </tr> <tr> <td>VI1220A1</td> <td>4.2X12 TCB SELF-TAPPIN G SCREW</td> <td>2</td> <td>PZ</td> </tr> <tr> <td>VM1190A2</td> <td>CT BT RIGHT DOOR SPRING LATCH</td> <td>1</td> <td>PZ</td> </tr> <tr> <td>VM1192A1</td> <td>CT BT DOOR SPRING LATCH BACK COVER</td> <td>1</td> <td>PZ</td> </tr> <tr> <td>VM1224A0</td> <td>65MY 220MM 2 COLOURS SHRINK TUBE</td> <td>0.200</td> <td>M</td> </tr> <tr> <td>VM1460A0</td> <td>XBC/XVC RIGHT DOOR LATCH CAP</td> <td>1</td> <td>PZ</td> </tr> </tbody> </table>	Code	Description	Qty	UOM	VI0239A1	SELF-TAPPIN G SCREW 4.2X25 TCB+ INOX	2	PZ	VI1220A1	4.2X12 TCB SELF-TAPPIN G SCREW	2	PZ	VM1190A2	CT BT RIGHT DOOR SPRING LATCH	1	PZ	VM1192A1	CT BT DOOR SPRING LATCH BACK COVER	1	PZ	VM1224A0	65MY 220MM 2 COLOURS SHRINK TUBE	0.200	M	VM1460A0	XBC/XVC RIGHT DOOR LATCH CAP	1	PZ
					Code	Description	Qty	UOM																									
					VI0239A1	SELF-TAPPIN G SCREW 4.2X25 TCB+ INOX	2	PZ																									
					VI1220A1	4.2X12 TCB SELF-TAPPIN G SCREW	2	PZ																									
					VM1190A2	CT BT RIGHT DOOR SPRING LATCH	1	PZ																									
					VM1192A1	CT BT DOOR SPRING LATCH BACK COVER	1	PZ																									
					VM1224A0	65MY 220MM 2 COLOURS SHRINK TUBE	0.200	M																									
VM1460A0	XBC/XVC RIGHT DOOR LATCH CAP	1	PZ																														
VM1191A	CT BT LEFT DOOR SPRING LATCH		KVM1191A	CHEFTOP/BAKERTO P DOOR LEFT LATCH KIT	<table border="1"> <thead> <tr> <th>Code</th> <th>Description</th> <th>Qty</th> <th>UOM</th> </tr> </thead> <tbody> <tr> <td>VI0239A1</td> <td>SELF-TAPPIN G SCREW 4.2X25 TCB+ INOX</td> <td>2</td> <td>PZ</td> </tr> <tr> <td>VI1220A1</td> <td>4.2X12 TCB SELF-TAPPIN G SCREW</td> <td>2</td> <td>PZ</td> </tr> <tr> <td>VM1191A2</td> <td>CT BT LEFT DOOR SPRING LATCH</td> <td>1</td> <td>PZ</td> </tr> <tr> <td>VM1192A1</td> <td>CT BT DOOR SPRING LATCH BACK COVER</td> <td>1</td> <td>PZ</td> </tr> <tr> <td>VM1224A0</td> <td>65MY 220MM 2 COLOURS SHRINK TUBE</td> <td>0.200</td> <td>M</td> </tr> <tr> <td>VM1460A0</td> <td>XBC/XVC RIGHT DOOR LATCH CAP</td> <td>1</td> <td>PZ</td> </tr> </tbody> </table>	Code	Description	Qty	UOM	VI0239A1	SELF-TAPPIN G SCREW 4.2X25 TCB+ INOX	2	PZ	VI1220A1	4.2X12 TCB SELF-TAPPIN G SCREW	2	PZ	VM1191A2	CT BT LEFT DOOR SPRING LATCH	1	PZ	VM1192A1	CT BT DOOR SPRING LATCH BACK COVER	1	PZ	VM1224A0	65MY 220MM 2 COLOURS SHRINK TUBE	0.200	M	VM1460A0	XBC/XVC RIGHT DOOR LATCH CAP	1	PZ
					Code	Description	Qty	UOM																									
					VI0239A1	SELF-TAPPIN G SCREW 4.2X25 TCB+ INOX	2	PZ																									
					VI1220A1	4.2X12 TCB SELF-TAPPIN G SCREW	2	PZ																									
					VM1191A2	CT BT LEFT DOOR SPRING LATCH	1	PZ																									
					VM1192A1	CT BT DOOR SPRING LATCH BACK COVER	1	PZ																									
					VM1224A0	65MY 220MM 2 COLOURS SHRINK TUBE	0.200	M																									
VM1460A0	XBC/XVC RIGHT DOOR LATCH CAP	1	PZ																														
VI1074A	4X16 SCREW FOR PLASTIC		VI1074A0	4X16 SCREW FOR PLASTIC																													

COMPONENT			SPARE PART																														
Code	Description	Image	Code	Description	Components list																												
EL1438A	BARBED STEAM SOLENOID VALVE 5+9		KEL1438A	5+9 BARBED 6 STEAM SOLENOID VALVE KIT	<table border="1"> <thead> <tr> <th>Code</th> <th>Description</th> <th>Qty</th> <th>UOM</th> </tr> </thead> <tbody> <tr> <td>EL1438A0</td> <td>BARBED STEAM SOLENOID VALVE 5+9</td> <td>1</td> <td>PZ</td> </tr> <tr> <td>RC1018A0</td> <td>ZINC PLATED D12 ELASTIC CLAMP</td> <td>2</td> <td>PZ</td> </tr> <tr> <td>VM1224A0</td> <td>65MY 220MM 2 COLOURS SHRINK TUBE</td> <td>0.250</td> <td>M</td> </tr> </tbody> </table>	Code	Description	Qty	UOM	EL1438A0	BARBED STEAM SOLENOID VALVE 5+9	1	PZ	RC1018A0	ZINC PLATED D12 ELASTIC CLAMP	2	PZ	VM1224A0	65MY 220MM 2 COLOURS SHRINK TUBE	0.250	M												
Code	Description	Qty	UOM																														
EL1438A0	BARBED STEAM SOLENOID VALVE 5+9	1	PZ																														
RC1018A0	ZINC PLATED D12 ELASTIC CLAMP	2	PZ																														
VM1224A0	65MY 220MM 2 COLOURS SHRINK TUBE	0.250	M																														
RC1414A	D12 HOSE CLAMP		RC1414A0	D12 HOSE CLAMP																													
TB3192A			KTB3131A	WHITE-BLACK 6X12 REINFORCED PIPE 3M KIT	<table border="1"> <thead> <tr> <th>Code</th> <th>Description</th> <th>Qty</th> <th>UOM</th> </tr> </thead> <tbody> <tr> <td>TB3131A0</td> <td>WHITE-BLACK EPDM TEXTILE BRAID HOSE 6X12</td> <td>3</td> <td>M</td> </tr> <tr> <td>VM1794A0</td> <td>250X4.8 PA66 BLACK CLAMP</td> <td>1</td> <td>PZ</td> </tr> </tbody> </table>	Code	Description	Qty	UOM	TB3131A0	WHITE-BLACK EPDM TEXTILE BRAID HOSE 6X12	3	M	VM1794A0	250X4.8 PA66 BLACK CLAMP	1	PZ																
Code	Description	Qty	UOM																														
TB3131A0	WHITE-BLACK EPDM TEXTILE BRAID HOSE 6X12	3	M																														
VM1794A0	250X4.8 PA66 BLACK CLAMP	1	PZ																														
VL1182A			KVL1106A	EUR 1 ROTOR ARM ONE CLEANING SYSTEM KIT	<table border="1"> <thead> <tr> <th>Code</th> <th>Description</th> <th>Qty</th> <th>UOM</th> </tr> </thead> <tbody> <tr> <td>0H2143A0</td> <td>LAMIERA BLOCCA VNR VL1128</td> <td>1</td> <td>PZ</td> </tr> <tr> <td>0H7819A0</td> <td>ONE WASHING SYS SUPPORT WITH STEAM VALVE</td> <td>1</td> <td>PZ</td> </tr> <tr> <td>EL1436A0</td> <td>H2O SOLENOID JG D8 CHECK VALVE</td> <td>1</td> <td>PZ</td> </tr> <tr> <td>EL1436B0</td> <td>JG D8-BARBED D6 NRV WATER SOLENOID</td> <td>1</td> <td>PZ</td> </tr> <tr> <td>GN1526A0</td> <td>INT. D.=6.9 TH=1.8 O-RIN</td> <td>1</td> <td>PZ</td> </tr> <tr> <td>RC1242A0</td> <td>D=10 CLOSED CAP</td> <td>2</td> <td>PZ</td> </tr> </tbody> </table>	Code	Description	Qty	UOM	0H2143A0	LAMIERA BLOCCA VNR VL1128	1	PZ	0H7819A0	ONE WASHING SYS SUPPORT WITH STEAM VALVE	1	PZ	EL1436A0	H2O SOLENOID JG D8 CHECK VALVE	1	PZ	EL1436B0	JG D8-BARBED D6 NRV WATER SOLENOID	1	PZ	GN1526A0	INT. D.=6.9 TH=1.8 O-RIN	1	PZ	RC1242A0	D=10 CLOSED CAP	2	PZ
Code	Description	Qty	UOM																														
0H2143A0	LAMIERA BLOCCA VNR VL1128	1	PZ																														
0H7819A0	ONE WASHING SYS SUPPORT WITH STEAM VALVE	1	PZ																														
EL1436A0	H2O SOLENOID JG D8 CHECK VALVE	1	PZ																														
EL1436B0	JG D8-BARBED D6 NRV WATER SOLENOID	1	PZ																														
GN1526A0	INT. D.=6.9 TH=1.8 O-RIN	1	PZ																														
RC1242A0	D=10 CLOSED CAP	2	PZ																														



COMPONENT			SPARE PART																																										
Code	Description	Image	Code	Description	Components list																																								
VL1182A			KVL1106A	EUR 1 ROTOR ARM ONE CLEANING SYSTEM KIT	<table border="1"> <thead> <tr> <th>Code</th> <th>Description</th> <th>Qty</th> <th>UOM</th> </tr> </thead> <tbody> <tr> <td>TB2820A0</td> <td>6X10 EPDM PIPE FOR WASHING SYSTEM</td> <td>1.420</td> <td>M</td> </tr> <tr> <td>VI1220A1</td> <td>4,2X12 TCB SELF-TAPPIN G SCREW</td> <td>1</td> <td>PZ</td> </tr> <tr> <td>VL1019A0</td> <td>VIBRATION PUMP</td> <td>1</td> <td>PZ</td> </tr> <tr> <td>VL1053B0</td> <td>ONE WASHING SYS EXT DISTRIBUTOR</td> <td>1</td> <td>PZ</td> </tr> <tr> <td>VL1054B0</td> <td>ONE WASHING SYS INLET DISTRIBUTOR</td> <td>1</td> <td>PZ</td> </tr> <tr> <td>VL1102A1</td> <td>DETERGENT LINE FILTER + BARBED VNR 6 MM</td> <td>1</td> <td>PZ</td> </tr> <tr> <td>VL1128A0</td> <td>D6 BARBED CHECK VALVE</td> <td>1</td> <td>PZ</td> </tr> <tr> <td>VL1128A1</td> <td>D6 BARBED CHECK VALVE</td> <td>1</td> <td>PZ</td> </tr> <tr> <td>VM2172A0</td> <td>PUMP-WITH-CI RCUIT LOCKING PIN</td> <td>1</td> <td>PZ</td> </tr> </tbody> </table>	Code	Description	Qty	UOM	TB2820A0	6X10 EPDM PIPE FOR WASHING SYSTEM	1.420	M	VI1220A1	4,2X12 TCB SELF-TAPPIN G SCREW	1	PZ	VL1019A0	VIBRATION PUMP	1	PZ	VL1053B0	ONE WASHING SYS EXT DISTRIBUTOR	1	PZ	VL1054B0	ONE WASHING SYS INLET DISTRIBUTOR	1	PZ	VL1102A1	DETERGENT LINE FILTER + BARBED VNR 6 MM	1	PZ	VL1128A0	D6 BARBED CHECK VALVE	1	PZ	VL1128A1	D6 BARBED CHECK VALVE	1	PZ	VM2172A0	PUMP-WITH-CI RCUIT LOCKING PIN	1	PZ
Code	Description	Qty	UOM																																										
TB2820A0	6X10 EPDM PIPE FOR WASHING SYSTEM	1.420	M																																										
VI1220A1	4,2X12 TCB SELF-TAPPIN G SCREW	1	PZ																																										
VL1019A0	VIBRATION PUMP	1	PZ																																										
VL1053B0	ONE WASHING SYS EXT DISTRIBUTOR	1	PZ																																										
VL1054B0	ONE WASHING SYS INLET DISTRIBUTOR	1	PZ																																										
VL1102A1	DETERGENT LINE FILTER + BARBED VNR 6 MM	1	PZ																																										
VL1128A0	D6 BARBED CHECK VALVE	1	PZ																																										
VL1128A1	D6 BARBED CHECK VALVE	1	PZ																																										
VM2172A0	PUMP-WITH-CI RCUIT LOCKING PIN	1	PZ																																										
GN1526A	INT. D.=6.9 TH=1.8 O-RING		KGN1526A	O-RING INT D6.9 THICK1.8 10PCS KIT	<table border="1"> <thead> <tr> <th>Code</th> <th>Description</th> <th>Qty</th> <th>UOM</th> </tr> </thead> <tbody> <tr> <td>GN1526A0</td> <td>INT. D.=6.9 TH=1.8 O-RIN</td> <td>10</td> <td>PZ</td> </tr> </tbody> </table>	Code	Description	Qty	UOM	GN1526A0	INT. D.=6.9 TH=1.8 O-RIN	10	PZ																																
Code	Description	Qty	UOM																																										
GN1526A0	INT. D.=6.9 TH=1.8 O-RIN	10	PZ																																										
VM2172A	PUMP-WITH-CIRCUIT LOCKING PIN		VM2172A0	PUMP-WITH-CIRCUIT LOCKING PIN																																									

COMPONENT			SPARE PART																																										
Code	Description	Image	Code	Description	Components list																																								
RC1019A	D=10 ELASTIC CLAM		KRC1019A	Ø10 ZINC PLATED ELASTIC CLAMP 15 PCS KIT	<table border="1"> <thead> <tr> <th>Code</th> <th>Description</th> <th>Qty</th> <th>UOM</th> </tr> </thead> <tbody> <tr> <td>RC1019A0</td> <td>D=10 ELASTIC CLAMP</td> <td>17</td> <td>PZ</td> </tr> <tr> <td>VM1224A0</td> <td>65MY 220MM 2 COLOURS SHRINK TUBE</td> <td>0.200</td> <td>M</td> </tr> </tbody> </table>	Code	Description	Qty	UOM	RC1019A0	D=10 ELASTIC CLAMP	17	PZ	VM1224A0	65MY 220MM 2 COLOURS SHRINK TUBE	0.200	M																												
					Code	Description	Qty	UOM																																					
RC1019A0	D=10 ELASTIC CLAMP	17	PZ																																										
VM1224A0	65MY 220MM 2 COLOURS SHRINK TUBE	0.200	M																																										
<table border="1"> <thead> <tr> <th>Code</th> <th>Description</th> <th>Qty</th> <th>UOM</th> </tr> </thead> <tbody> <tr> <td>RC1019A0</td> <td>D=10 ELASTIC CLAMP</td> <td>5</td> <td>PZ</td> </tr> <tr> <td>TB2820A0</td> <td>6X10 EPDM PIPE FOR WASHING SYSTEM</td> <td>0.710</td> <td>M</td> </tr> <tr> <td>VL1102A1</td> <td>DETERGENT LINE FILTER + BARBED VNR 6 MM</td> <td>1</td> <td>PZ</td> </tr> <tr> <td>VM1224A0</td> <td>65MY 220MM 2 COLOURS SHRINK TUBE</td> <td>0.300</td> <td>M</td> </tr> </tbody> </table>	Code	Description	Qty	UOM	RC1019A0	D=10 ELASTIC CLAMP	5	PZ	TB2820A0	6X10 EPDM PIPE FOR WASHING SYSTEM	0.710	M	VL1102A1	DETERGENT LINE FILTER + BARBED VNR 6 MM	1	PZ	VM1224A0	65MY 220MM 2 COLOURS SHRINK TUBE	0.300	M																									
Code	Description	Qty	UOM																																										
RC1019A0	D=10 ELASTIC CLAMP	5	PZ																																										
TB2820A0	6X10 EPDM PIPE FOR WASHING SYSTEM	0.710	M																																										
VL1102A1	DETERGENT LINE FILTER + BARBED VNR 6 MM	1	PZ																																										
VM1224A0	65MY 220MM 2 COLOURS SHRINK TUBE	0.300	M																																										
VL1102A	DETERGENT LINE FILTER + BARBED VNR 6 MM		KVL1102A	DETERGENT FILTER + NRV KIT	<table border="1"> <thead> <tr> <th>Code</th> <th>Description</th> <th>Qty</th> <th>UOM</th> </tr> </thead> <tbody> <tr> <td>0H2202A1</td> <td>ONE WASHING WITH STEAM VALVE SUPPORT</td> <td>2</td> <td>PZ</td> </tr> <tr> <td>CE1030A0</td> <td>FEMALE FASTON COVER 6.3X0.8 0.5-1MMQ</td> <td>4</td> <td>PZ</td> </tr> <tr> <td>CE1395A0</td> <td>6,3 X 0,8 MALE FASTO</td> <td>2</td> <td>PZ</td> </tr> <tr> <td>CE1545A0</td> <td>BLUE UNIP AWG18 ST.3135 WIRE</td> <td>1</td> <td>M</td> </tr> <tr> <td>CE1570A0</td> <td>WHITE UNIP AWG18 ST.3135 WIRE</td> <td>1</td> <td>M</td> </tr> <tr> <td>CE1660A0</td> <td>6,3X0,8 FEMALE FASTON COVE</td> <td>4</td> <td>PZ</td> </tr> <tr> <td>CE1661A0</td> <td>MALE FASTON COVER 6.3X0.</td> <td>2</td> <td>PZ</td> </tr> <tr> <td>EL1020A1</td> <td>D8 INTERMEDIAT E T-SHAPED FITTING</td> <td>1</td> <td>PZ</td> </tr> <tr> <td>EL1440A0</td> <td>WATER SELF CLEANING VALVE</td> <td>2</td> <td>PZ</td> </tr> </tbody> </table>	Code	Description	Qty	UOM	0H2202A1	ONE WASHING WITH STEAM VALVE SUPPORT	2	PZ	CE1030A0	FEMALE FASTON COVER 6.3X0.8 0.5-1MMQ	4	PZ	CE1395A0	6,3 X 0,8 MALE FASTO	2	PZ	CE1545A0	BLUE UNIP AWG18 ST.3135 WIRE	1	M	CE1570A0	WHITE UNIP AWG18 ST.3135 WIRE	1	M	CE1660A0	6,3X0,8 FEMALE FASTON COVE	4	PZ	CE1661A0	MALE FASTON COVER 6.3X0.	2	PZ	EL1020A1	D8 INTERMEDIAT E T-SHAPED FITTING	1	PZ	EL1440A0	WATER SELF CLEANING VALVE	2	PZ
Code	Description	Qty	UOM																																										
0H2202A1	ONE WASHING WITH STEAM VALVE SUPPORT	2	PZ																																										
CE1030A0	FEMALE FASTON COVER 6.3X0.8 0.5-1MMQ	4	PZ																																										
CE1395A0	6,3 X 0,8 MALE FASTO	2	PZ																																										
CE1545A0	BLUE UNIP AWG18 ST.3135 WIRE	1	M																																										
CE1570A0	WHITE UNIP AWG18 ST.3135 WIRE	1	M																																										
CE1660A0	6,3X0,8 FEMALE FASTON COVE	4	PZ																																										
CE1661A0	MALE FASTON COVER 6.3X0.	2	PZ																																										
EL1020A1	D8 INTERMEDIAT E T-SHAPED FITTING	1	PZ																																										
EL1440A0	WATER SELF CLEANING VALVE	2	PZ																																										
VL1165A	BB6-AR6 STRAIGHT FITTING		KVL2618A	2 ROTOR ARMS ONE CLEANING SYSTEM KIT	<table border="1"> <thead> <tr> <th>Code</th> <th>Description</th> <th>Qty</th> <th>UOM</th> </tr> </thead> <tbody> <tr> <td>0H2202A1</td> <td>ONE WASHING WITH STEAM VALVE SUPPORT</td> <td>2</td> <td>PZ</td> </tr> <tr> <td>CE1030A0</td> <td>FEMALE FASTON COVER 6.3X0.8 0.5-1MMQ</td> <td>4</td> <td>PZ</td> </tr> <tr> <td>CE1395A0</td> <td>6,3 X 0,8 MALE FASTO</td> <td>2</td> <td>PZ</td> </tr> <tr> <td>CE1545A0</td> <td>BLUE UNIP AWG18 ST.3135 WIRE</td> <td>1</td> <td>M</td> </tr> <tr> <td>CE1570A0</td> <td>WHITE UNIP AWG18 ST.3135 WIRE</td> <td>1</td> <td>M</td> </tr> <tr> <td>CE1660A0</td> <td>6,3X0,8 FEMALE FASTON COVE</td> <td>4</td> <td>PZ</td> </tr> <tr> <td>CE1661A0</td> <td>MALE FASTON COVER 6.3X0.</td> <td>2</td> <td>PZ</td> </tr> <tr> <td>EL1020A1</td> <td>D8 INTERMEDIAT E T-SHAPED FITTING</td> <td>1</td> <td>PZ</td> </tr> <tr> <td>EL1440A0</td> <td>WATER SELF CLEANING VALVE</td> <td>2</td> <td>PZ</td> </tr> </tbody> </table>	Code	Description	Qty	UOM	0H2202A1	ONE WASHING WITH STEAM VALVE SUPPORT	2	PZ	CE1030A0	FEMALE FASTON COVER 6.3X0.8 0.5-1MMQ	4	PZ	CE1395A0	6,3 X 0,8 MALE FASTO	2	PZ	CE1545A0	BLUE UNIP AWG18 ST.3135 WIRE	1	M	CE1570A0	WHITE UNIP AWG18 ST.3135 WIRE	1	M	CE1660A0	6,3X0,8 FEMALE FASTON COVE	4	PZ	CE1661A0	MALE FASTON COVER 6.3X0.	2	PZ	EL1020A1	D8 INTERMEDIAT E T-SHAPED FITTING	1	PZ	EL1440A0	WATER SELF CLEANING VALVE	2	PZ
Code	Description	Qty	UOM																																										
0H2202A1	ONE WASHING WITH STEAM VALVE SUPPORT	2	PZ																																										
CE1030A0	FEMALE FASTON COVER 6.3X0.8 0.5-1MMQ	4	PZ																																										
CE1395A0	6,3 X 0,8 MALE FASTO	2	PZ																																										
CE1545A0	BLUE UNIP AWG18 ST.3135 WIRE	1	M																																										
CE1570A0	WHITE UNIP AWG18 ST.3135 WIRE	1	M																																										
CE1660A0	6,3X0,8 FEMALE FASTON COVE	4	PZ																																										
CE1661A0	MALE FASTON COVER 6.3X0.	2	PZ																																										
EL1020A1	D8 INTERMEDIAT E T-SHAPED FITTING	1	PZ																																										
EL1440A0	WATER SELF CLEANING VALVE	2	PZ																																										

COMPONENT			SPARE PART																																																																																						
Code	Description	Image	Code	Description	Components list																																																																																				
VL1165A	BB6-AR6 STRAIGHT FITTING		KVL2618A	2 ROTOR ARMS ONE CLEANING SYSTEM KIT	<table border="1"> <thead> <tr> <th>Code</th> <th>Description</th> <th>Qty</th> <th>UOM</th> </tr> </thead> <tbody> <tr> <td>GN1526A0</td> <td>INT. D.=6.9 TH=1.8 O-RIN</td> <td>6</td> <td>PZ</td> </tr> <tr> <td>IP1385A1</td> <td>CORNER POLYSTYREN E PACKING 110X80X2000</td> <td>0.500</td> <td>M</td> </tr> <tr> <td>RC1018A0</td> <td>ZINC PLATED D12 ELASTIC CLAMP</td> <td>4</td> <td>PZ</td> </tr> <tr> <td>RC1019A0</td> <td>D=10 ELASTIC CLAMP</td> <td>31</td> <td>PZ</td> </tr> <tr> <td>RC1130A0</td> <td>130X2,6 CLAM</td> <td>4</td> <td>PZ</td> </tr> <tr> <td>RC1242A0</td> <td>D=10 CLOSED CAP</td> <td>4</td> <td>PZ</td> </tr> <tr> <td>TB2820A0</td> <td>6X10 EPDM PIPE FOR WASHING SYSTEM</td> <td>2.920</td> <td>M</td> </tr> <tr> <td>TB3132A0</td> <td>WHITE-BLUE EPDM TEXTILE BRAID HOSE 6X12</td> <td>1.340</td> <td>M</td> </tr> <tr> <td>VI1220A1</td> <td>4,2X12 TCB SELF-TAPPIN G SCREW</td> <td>2</td> <td>PZ</td> </tr> <tr> <td>VL1019A0</td> <td>VIBRATION PUMP</td> <td>2</td> <td>PZ</td> </tr> <tr> <td>VL1047A1</td> <td>D6 PIPE HOLDER - D8 J.G. TERMINAL</td> <td>2</td> <td>PZ</td> </tr> <tr> <td>VL1054B0</td> <td>ONE WASHING SYS INLET DISTRIBUTOR</td> <td>2</td> <td>PZ</td> </tr> <tr> <td>VL1102A1</td> <td>DETERGENT LINE FILTER + BARBED VNR 6 MM</td> <td>2</td> <td>PZ</td> </tr> <tr> <td>VL1127A1</td> <td>6MM BARBED T-SHAPED FITTING</td> <td>1</td> <td>PZ</td> </tr> <tr> <td>VL1128A1</td> <td>D6 BARBED CHECK VALVE</td> <td>4</td> <td>PZ</td> </tr> <tr> <td>VL1165A0</td> <td>BB6-AR6 STRAIGHT FITTING</td> <td>2</td> <td>PZ</td> </tr> <tr> <td>VL1166A0</td> <td>BB6-AR6 L FITTING</td> <td>2</td> <td>PZ</td> </tr> <tr> <td>VL1174C0</td> <td>D1.2 MM CALIBRATED NOZZLE</td> <td>2</td> <td>PZ</td> </tr> <tr> <td>VL1191A0</td> <td>ONE WASHING DISTRIBUTOR OUTLETS KIT</td> <td>2</td> <td>PZ</td> </tr> <tr> <td>VM2172A0</td> <td>PUMP-WITH-CI RCUIT LOCKING PIN</td> <td>4</td> <td>PZ</td> </tr> </tbody> </table>	Code	Description	Qty	UOM	GN1526A0	INT. D.=6.9 TH=1.8 O-RIN	6	PZ	IP1385A1	CORNER POLYSTYREN E PACKING 110X80X2000	0.500	M	RC1018A0	ZINC PLATED D12 ELASTIC CLAMP	4	PZ	RC1019A0	D=10 ELASTIC CLAMP	31	PZ	RC1130A0	130X2,6 CLAM	4	PZ	RC1242A0	D=10 CLOSED CAP	4	PZ	TB2820A0	6X10 EPDM PIPE FOR WASHING SYSTEM	2.920	M	TB3132A0	WHITE-BLUE EPDM TEXTILE BRAID HOSE 6X12	1.340	M	VI1220A1	4,2X12 TCB SELF-TAPPIN G SCREW	2	PZ	VL1019A0	VIBRATION PUMP	2	PZ	VL1047A1	D6 PIPE HOLDER - D8 J.G. TERMINAL	2	PZ	VL1054B0	ONE WASHING SYS INLET DISTRIBUTOR	2	PZ	VL1102A1	DETERGENT LINE FILTER + BARBED VNR 6 MM	2	PZ	VL1127A1	6MM BARBED T-SHAPED FITTING	1	PZ	VL1128A1	D6 BARBED CHECK VALVE	4	PZ	VL1165A0	BB6-AR6 STRAIGHT FITTING	2	PZ	VL1166A0	BB6-AR6 L FITTING	2	PZ	VL1174C0	D1.2 MM CALIBRATED NOZZLE	2	PZ	VL1191A0	ONE WASHING DISTRIBUTOR OUTLETS KIT	2	PZ	VM2172A0	PUMP-WITH-CI RCUIT LOCKING PIN	4	PZ
Code	Description	Qty	UOM																																																																																						
GN1526A0	INT. D.=6.9 TH=1.8 O-RIN	6	PZ																																																																																						
IP1385A1	CORNER POLYSTYREN E PACKING 110X80X2000	0.500	M																																																																																						
RC1018A0	ZINC PLATED D12 ELASTIC CLAMP	4	PZ																																																																																						
RC1019A0	D=10 ELASTIC CLAMP	31	PZ																																																																																						
RC1130A0	130X2,6 CLAM	4	PZ																																																																																						
RC1242A0	D=10 CLOSED CAP	4	PZ																																																																																						
TB2820A0	6X10 EPDM PIPE FOR WASHING SYSTEM	2.920	M																																																																																						
TB3132A0	WHITE-BLUE EPDM TEXTILE BRAID HOSE 6X12	1.340	M																																																																																						
VI1220A1	4,2X12 TCB SELF-TAPPIN G SCREW	2	PZ																																																																																						
VL1019A0	VIBRATION PUMP	2	PZ																																																																																						
VL1047A1	D6 PIPE HOLDER - D8 J.G. TERMINAL	2	PZ																																																																																						
VL1054B0	ONE WASHING SYS INLET DISTRIBUTOR	2	PZ																																																																																						
VL1102A1	DETERGENT LINE FILTER + BARBED VNR 6 MM	2	PZ																																																																																						
VL1127A1	6MM BARBED T-SHAPED FITTING	1	PZ																																																																																						
VL1128A1	D6 BARBED CHECK VALVE	4	PZ																																																																																						
VL1165A0	BB6-AR6 STRAIGHT FITTING	2	PZ																																																																																						
VL1166A0	BB6-AR6 L FITTING	2	PZ																																																																																						
VL1174C0	D1.2 MM CALIBRATED NOZZLE	2	PZ																																																																																						
VL1191A0	ONE WASHING DISTRIBUTOR OUTLETS KIT	2	PZ																																																																																						
VM2172A0	PUMP-WITH-CI RCUIT LOCKING PIN	4	PZ																																																																																						





COMPONENT			SPARE PART																																																																																		
Code	Description	Image	Code	Description	Components list																																																																																
VL1165A	BB6-AR6 STRAIGHT FITTING		KVL1225A	US HOOD WASHING SYSTEM KIT	<table border="1"> <thead> <tr> <th>Code</th> <th>Description</th> <th>Qty</th> <th>UOM</th> </tr> </thead> <tbody> <tr> <td>0H2213A1</td> <td></td> <td>1</td> <td>PZ</td> </tr> <tr> <td>EL1450A0</td> <td>US SELF-CLEANING WATER SOLENOID</td> <td>2</td> <td>PZ</td> </tr> <tr> <td>GN1526A0</td> <td>INT. D.=6.9 TH=1.8 O-RING</td> <td>5</td> <td>PZ</td> </tr> <tr> <td>RC1018A0</td> <td>ZINC PLATED D12 ELASTIC CLAMP</td> <td>5</td> <td>PZ</td> </tr> <tr> <td>RC1019A0</td> <td>D=10 ELASTIC CLAMP</td> <td>16</td> <td>PZ</td> </tr> <tr> <td>RC1131A0</td> <td>200X2.6 BLACK CLAMP</td> <td>1</td> <td>PZ</td> </tr> <tr> <td>RC1242A0</td> <td>D=10 CLOSED CAP</td> <td>2</td> <td>PZ</td> </tr> <tr> <td>TB2820A0</td> <td>6X10 EPDM PIPE FOR WASHING SYSTEM</td> <td>2.240</td> <td>M</td> </tr> <tr> <td>TB3132A0</td> <td>WHITE-BLUE EPDM TEXTILE BRAID HOSE 6X12</td> <td>0.440</td> <td>M</td> </tr> <tr> <td>VI1220A1</td> <td>4,2X12 TCB SELF-TAPPING SCREW</td> <td>3</td> <td>PZ</td> </tr> <tr> <td>VL1019A0</td> <td>VIBRATION PUMP</td> <td>1</td> <td>PZ</td> </tr> <tr> <td>VL1047A1</td> <td>D6 PIPE HOLDER - D6 J.G. TERMINAL</td> <td>1</td> <td>PZ</td> </tr> <tr> <td>VL1054B0</td> <td>ONE WASHING SYSTEM INLET DISTRIBUTOR</td> <td>1</td> <td>PZ</td> </tr> <tr> <td>VL1102A1</td> <td>DETERGENT LINE FILTER + BARBED VNR 6 MM</td> <td>1</td> <td>PZ</td> </tr> <tr> <td>VL1127A1</td> <td>6MM BARBED T-SHAPED FITTING</td> <td>1</td> <td>PZ</td> </tr> <tr> <td>VL1128A1</td> <td>D6 BARBED CHECK VALVE</td> <td>2</td> <td>PZ</td> </tr> <tr> <td>VL1165A0</td> <td>BB6-AR6 STRAIGHT FITTING</td> <td>2</td> <td>PZ</td> </tr> <tr> <td>VL1166A0</td> <td>BB6-AR6 L FITTING</td> <td>2</td> <td>PZ</td> </tr> <tr> <td>VL1174C0</td> <td>D1.2 MM CALIBRATED NOZZLE</td> <td>1</td> <td>PZ</td> </tr> </tbody> </table>	Code	Description	Qty	UOM	0H2213A1		1	PZ	EL1450A0	US SELF-CLEANING WATER SOLENOID	2	PZ	GN1526A0	INT. D.=6.9 TH=1.8 O-RING	5	PZ	RC1018A0	ZINC PLATED D12 ELASTIC CLAMP	5	PZ	RC1019A0	D=10 ELASTIC CLAMP	16	PZ	RC1131A0	200X2.6 BLACK CLAMP	1	PZ	RC1242A0	D=10 CLOSED CAP	2	PZ	TB2820A0	6X10 EPDM PIPE FOR WASHING SYSTEM	2.240	M	TB3132A0	WHITE-BLUE EPDM TEXTILE BRAID HOSE 6X12	0.440	M	VI1220A1	4,2X12 TCB SELF-TAPPING SCREW	3	PZ	VL1019A0	VIBRATION PUMP	1	PZ	VL1047A1	D6 PIPE HOLDER - D6 J.G. TERMINAL	1	PZ	VL1054B0	ONE WASHING SYSTEM INLET DISTRIBUTOR	1	PZ	VL1102A1	DETERGENT LINE FILTER + BARBED VNR 6 MM	1	PZ	VL1127A1	6MM BARBED T-SHAPED FITTING	1	PZ	VL1128A1	D6 BARBED CHECK VALVE	2	PZ	VL1165A0	BB6-AR6 STRAIGHT FITTING	2	PZ	VL1166A0	BB6-AR6 L FITTING	2	PZ	VL1174C0	D1.2 MM CALIBRATED NOZZLE	1	PZ
Code	Description	Qty	UOM																																																																																		
0H2213A1		1	PZ																																																																																		
EL1450A0	US SELF-CLEANING WATER SOLENOID	2	PZ																																																																																		
GN1526A0	INT. D.=6.9 TH=1.8 O-RING	5	PZ																																																																																		
RC1018A0	ZINC PLATED D12 ELASTIC CLAMP	5	PZ																																																																																		
RC1019A0	D=10 ELASTIC CLAMP	16	PZ																																																																																		
RC1131A0	200X2.6 BLACK CLAMP	1	PZ																																																																																		
RC1242A0	D=10 CLOSED CAP	2	PZ																																																																																		
TB2820A0	6X10 EPDM PIPE FOR WASHING SYSTEM	2.240	M																																																																																		
TB3132A0	WHITE-BLUE EPDM TEXTILE BRAID HOSE 6X12	0.440	M																																																																																		
VI1220A1	4,2X12 TCB SELF-TAPPING SCREW	3	PZ																																																																																		
VL1019A0	VIBRATION PUMP	1	PZ																																																																																		
VL1047A1	D6 PIPE HOLDER - D6 J.G. TERMINAL	1	PZ																																																																																		
VL1054B0	ONE WASHING SYSTEM INLET DISTRIBUTOR	1	PZ																																																																																		
VL1102A1	DETERGENT LINE FILTER + BARBED VNR 6 MM	1	PZ																																																																																		
VL1127A1	6MM BARBED T-SHAPED FITTING	1	PZ																																																																																		
VL1128A1	D6 BARBED CHECK VALVE	2	PZ																																																																																		
VL1165A0	BB6-AR6 STRAIGHT FITTING	2	PZ																																																																																		
VL1166A0	BB6-AR6 L FITTING	2	PZ																																																																																		
VL1174C0	D1.2 MM CALIBRATED NOZZLE	1	PZ																																																																																		



COMPONENT			SPARE PART																																																																						
Code	Description	Image	Code	Description	Components list																																																																				
VL1165A	BB6-AR6 STRAIGHT FITTING		KVL1225A	US HOOD WASHING SYSTEM KIT	<table border="1"> <thead> <tr> <th>Code</th> <th>Description</th> <th>Qty</th> <th>UOM</th> </tr> </thead> <tbody> <tr> <td>VL1191A0</td> <td>ONE WASHING DISTRIBUTOR OUTLETS KIT</td> <td>1</td> <td>PZ</td> </tr> <tr> <td>VM1605A0</td> <td>CLIP TWIST LOCK DIAM. 10,2-12,7 MM</td> <td>2</td> <td>PZ</td> </tr> <tr> <td>VM2172A0</td> <td>PUMP-WITH-CI RCUIT LOCKING PIN</td> <td>5</td> <td>PZ</td> </tr> </tbody> </table>	Code	Description	Qty	UOM	VL1191A0	ONE WASHING DISTRIBUTOR OUTLETS KIT	1	PZ	VM1605A0	CLIP TWIST LOCK DIAM. 10,2-12,7 MM	2	PZ	VM2172A0	PUMP-WITH-CI RCUIT LOCKING PIN	5	PZ																																																				
Code	Description	Qty	UOM																																																																						
VL1191A0	ONE WASHING DISTRIBUTOR OUTLETS KIT	1	PZ																																																																						
VM1605A0	CLIP TWIST LOCK DIAM. 10,2-12,7 MM	2	PZ																																																																						
VM2172A0	PUMP-WITH-CI RCUIT LOCKING PIN	5	PZ																																																																						
			KVL1222A	EUR 0311 ONE PLUS CLEANING SYSTEM KIT	<table border="1"> <thead> <tr> <th>Code</th> <th>Description</th> <th>Qty</th> <th>UOM</th> </tr> </thead> <tbody> <tr> <td>0H2486A0</td> <td></td> <td>1</td> <td>PZ</td> </tr> <tr> <td>EL1440A0</td> <td>WATER SELF CLEANING VALVE</td> <td>1</td> <td>PZ</td> </tr> <tr> <td>GN1526A0</td> <td>INT. D.=6.9 TH=1.8 O-RING</td> <td>3</td> <td>PZ</td> </tr> <tr> <td>RC1018A0</td> <td>ZINC PLATED D12 ELASTIC CLAMP</td> <td>2</td> <td>PZ</td> </tr> <tr> <td>RC1019A0</td> <td>D=10 ELASTIC CLAMP</td> <td>14</td> <td>PZ</td> </tr> <tr> <td>RC1242A0</td> <td>D=10 CLOSED CAP</td> <td>2</td> <td>PZ</td> </tr> <tr> <td>TB2820A0</td> <td>6X10 EPDM PIPE FOR WASHING SYSTEM</td> <td>1.460</td> <td>M</td> </tr> <tr> <td>TB3132A0</td> <td>WHITE-BLUE EPDM TEXTILE BRAID HOSE 6X12</td> <td>0.670</td> <td>M</td> </tr> <tr> <td>VI1220A1</td> <td>4,2X12 TCB SELF-TAPPIN G SCREW</td> <td>4</td> <td>PZ</td> </tr> <tr> <td>VL1019A0</td> <td>VIBRATION PUMP</td> <td>1</td> <td>PZ</td> </tr> <tr> <td>VL1047A1</td> <td>D6 PIPE HOLDER - D8 J.G. TERMINAL</td> <td>1</td> <td>PZ</td> </tr> <tr> <td>VL1054B0</td> <td>ONE WASHING SYS INLET DISTRIBUTOR</td> <td>1</td> <td>PZ</td> </tr> <tr> <td>VL1102A1</td> <td>DETERGENT LINE FILTER + BARBED VNR 6 MM</td> <td>1</td> <td>PZ</td> </tr> <tr> <td>VL1128A1</td> <td>D6 BARBED CHECK VALVE</td> <td>2</td> <td>PZ</td> </tr> <tr> <td>VL1165A0</td> <td>BB6-AR6 STRAIGHT FITTING</td> <td>1</td> <td>PZ</td> </tr> <tr> <td>VL1166A0</td> <td>BB6-AR6 L FITTING</td> <td>1</td> <td>PZ</td> </tr> </tbody> </table>	Code	Description	Qty	UOM	0H2486A0		1	PZ	EL1440A0	WATER SELF CLEANING VALVE	1	PZ	GN1526A0	INT. D.=6.9 TH=1.8 O-RING	3	PZ	RC1018A0	ZINC PLATED D12 ELASTIC CLAMP	2	PZ	RC1019A0	D=10 ELASTIC CLAMP	14	PZ	RC1242A0	D=10 CLOSED CAP	2	PZ	TB2820A0	6X10 EPDM PIPE FOR WASHING SYSTEM	1.460	M	TB3132A0	WHITE-BLUE EPDM TEXTILE BRAID HOSE 6X12	0.670	M	VI1220A1	4,2X12 TCB SELF-TAPPIN G SCREW	4	PZ	VL1019A0	VIBRATION PUMP	1	PZ	VL1047A1	D6 PIPE HOLDER - D8 J.G. TERMINAL	1	PZ	VL1054B0	ONE WASHING SYS INLET DISTRIBUTOR	1	PZ	VL1102A1	DETERGENT LINE FILTER + BARBED VNR 6 MM	1	PZ	VL1128A1	D6 BARBED CHECK VALVE	2	PZ	VL1165A0	BB6-AR6 STRAIGHT FITTING	1	PZ	VL1166A0	BB6-AR6 L FITTING	1	PZ
Code	Description	Qty	UOM																																																																						
0H2486A0		1	PZ																																																																						
EL1440A0	WATER SELF CLEANING VALVE	1	PZ																																																																						
GN1526A0	INT. D.=6.9 TH=1.8 O-RING	3	PZ																																																																						
RC1018A0	ZINC PLATED D12 ELASTIC CLAMP	2	PZ																																																																						
RC1019A0	D=10 ELASTIC CLAMP	14	PZ																																																																						
RC1242A0	D=10 CLOSED CAP	2	PZ																																																																						
TB2820A0	6X10 EPDM PIPE FOR WASHING SYSTEM	1.460	M																																																																						
TB3132A0	WHITE-BLUE EPDM TEXTILE BRAID HOSE 6X12	0.670	M																																																																						
VI1220A1	4,2X12 TCB SELF-TAPPIN G SCREW	4	PZ																																																																						
VL1019A0	VIBRATION PUMP	1	PZ																																																																						
VL1047A1	D6 PIPE HOLDER - D8 J.G. TERMINAL	1	PZ																																																																						
VL1054B0	ONE WASHING SYS INLET DISTRIBUTOR	1	PZ																																																																						
VL1102A1	DETERGENT LINE FILTER + BARBED VNR 6 MM	1	PZ																																																																						
VL1128A1	D6 BARBED CHECK VALVE	2	PZ																																																																						
VL1165A0	BB6-AR6 STRAIGHT FITTING	1	PZ																																																																						
VL1166A0	BB6-AR6 L FITTING	1	PZ																																																																						



COMPONENT			SPARE PART																																																															
Code	Description	Image	Code	Description	Components list																																																													
VL1165A	BB6-AR6 STRAIGHT FITTING		KVL1222A	EUR 0311 ONE PLUS CLEANING SYSTEM KIT	<table border="1"> <thead> <tr> <th>Code</th> <th>Description</th> <th>Qty</th> <th>UOM</th> </tr> </thead> <tbody> <tr> <td>VL1174C0</td> <td>D1.2 MM CALIBRATED NOZZLE</td> <td>1</td> <td>PZ</td> </tr> <tr> <td>VL1191A0</td> <td>ONE WASHING DISTRIBUTOR OUTLETS KIT</td> <td>1</td> <td>PZ</td> </tr> <tr> <td>VM2172A0</td> <td>PUMP-WITH-CI RCUIT LOCKING PIN</td> <td>3</td> <td>PZ</td> </tr> </tbody> </table>	Code	Description	Qty	UOM	VL1174C0	D1.2 MM CALIBRATED NOZZLE	1	PZ	VL1191A0	ONE WASHING DISTRIBUTOR OUTLETS KIT	1	PZ	VM2172A0	PUMP-WITH-CI RCUIT LOCKING PIN	3	PZ																																													
			Code	Description	Qty	UOM																																																												
VL1174C0	D1.2 MM CALIBRATED NOZZLE	1	PZ																																																															
VL1191A0	ONE WASHING DISTRIBUTOR OUTLETS KIT	1	PZ																																																															
VM2172A0	PUMP-WITH-CI RCUIT LOCKING PIN	3	PZ																																																															
KVL1213A	US PLUS COMPACT WASHING SYSTEM KIT	<table border="1"> <thead> <tr> <th>Code</th> <th>Description</th> <th>Qty</th> <th>UOM</th> </tr> </thead> <tbody> <tr> <td>0H2428A0</td> <td></td> <td>1</td> <td>PZ</td> </tr> <tr> <td>EL1450A0</td> <td>US SELF-CLEANING WATER SOLENOID</td> <td>3</td> <td>PZ</td> </tr> <tr> <td>GN1312A0</td> <td>RUBBER CABLE-PASSING NG DE=26 DI=15 SP=10</td> <td>1</td> <td>PZ</td> </tr> <tr> <td>GN1526A0</td> <td>INT. D.=6.9 TH=1.8 O-RING</td> <td>7</td> <td>PZ</td> </tr> <tr> <td>RC1018A0</td> <td>ZINC PLATED D12 ELASTIC CLAMP</td> <td>3</td> <td>PZ</td> </tr> <tr> <td>RC1019A0</td> <td>D=10 ELASTIC CLAMP</td> <td>14</td> <td>PZ</td> </tr> <tr> <td>RC1130A0</td> <td>130X2,6 CLAMP</td> <td>1</td> <td>PZ</td> </tr> <tr> <td>RC1131A0</td> <td>200X2,6 BLACK CLAMP</td> <td>1</td> <td>PZ</td> </tr> <tr> <td>RC1242A0</td> <td>D=10 CLOSED CAP</td> <td>2</td> <td>PZ</td> </tr> <tr> <td>RC1356A0</td> <td>"STRAIGHT THREADED FEMALE END 8X1/4" BS</td> <td>1</td> <td>PZ</td> </tr> <tr> <td>TB2820A0</td> <td>6X10 EPDM PIPE FOR WASHING SYSTEM</td> <td>0.790</td> <td>M</td> </tr> <tr> <td>TB3132A0</td> <td>WHITE-BLUE EPDM TEXTILE BRAID HOSE 6X12</td> <td>1.400</td> <td>M</td> </tr> <tr> <td>VI1220A1</td> <td>4,2X12 TCB SELF-TAPPING SCREW</td> <td>3</td> <td>PZ</td> </tr> <tr> <td>VL1019A0</td> <td>VIBRATION PUMP</td> <td>1</td> <td>PZ</td> </tr> <tr> <td>VL1047A1</td> <td>D6 PIPE HOLDER - D8 J.G. TERMINAL</td> <td>1</td> <td>PZ</td> </tr> </tbody> </table>	Code	Description	Qty	UOM	0H2428A0		1	PZ	EL1450A0	US SELF-CLEANING WATER SOLENOID	3	PZ	GN1312A0	RUBBER CABLE-PASSING NG DE=26 DI=15 SP=10	1	PZ	GN1526A0	INT. D.=6.9 TH=1.8 O-RING	7	PZ	RC1018A0	ZINC PLATED D12 ELASTIC CLAMP	3	PZ	RC1019A0	D=10 ELASTIC CLAMP	14	PZ	RC1130A0	130X2,6 CLAMP	1	PZ	RC1131A0	200X2,6 BLACK CLAMP	1	PZ	RC1242A0	D=10 CLOSED CAP	2	PZ	RC1356A0	"STRAIGHT THREADED FEMALE END 8X1/4" BS	1	PZ	TB2820A0	6X10 EPDM PIPE FOR WASHING SYSTEM	0.790	M	TB3132A0	WHITE-BLUE EPDM TEXTILE BRAID HOSE 6X12	1.400	M	VI1220A1	4,2X12 TCB SELF-TAPPING SCREW	3	PZ	VL1019A0	VIBRATION PUMP	1	PZ	VL1047A1	D6 PIPE HOLDER - D8 J.G. TERMINAL	1	PZ
Code	Description	Qty	UOM																																																															
0H2428A0		1	PZ																																																															
EL1450A0	US SELF-CLEANING WATER SOLENOID	3	PZ																																																															
GN1312A0	RUBBER CABLE-PASSING NG DE=26 DI=15 SP=10	1	PZ																																																															
GN1526A0	INT. D.=6.9 TH=1.8 O-RING	7	PZ																																																															
RC1018A0	ZINC PLATED D12 ELASTIC CLAMP	3	PZ																																																															
RC1019A0	D=10 ELASTIC CLAMP	14	PZ																																																															
RC1130A0	130X2,6 CLAMP	1	PZ																																																															
RC1131A0	200X2,6 BLACK CLAMP	1	PZ																																																															
RC1242A0	D=10 CLOSED CAP	2	PZ																																																															
RC1356A0	"STRAIGHT THREADED FEMALE END 8X1/4" BS	1	PZ																																																															
TB2820A0	6X10 EPDM PIPE FOR WASHING SYSTEM	0.790	M																																																															
TB3132A0	WHITE-BLUE EPDM TEXTILE BRAID HOSE 6X12	1.400	M																																																															
VI1220A1	4,2X12 TCB SELF-TAPPING SCREW	3	PZ																																																															
VL1019A0	VIBRATION PUMP	1	PZ																																																															
VL1047A1	D6 PIPE HOLDER - D8 J.G. TERMINAL	1	PZ																																																															

COMPONENT			SPARE PART																																														
Code	Description	Image	Code	Description	Components list																																												
VL1165A	BB6-AR6 STRAIGHT FITTING		KVL1213A	US PLUS COMPACT WASHING SYSTEM KIT	<table border="1"> <thead> <tr> <th>Code</th> <th>Description</th> <th>Qty</th> <th>UOM</th> </tr> </thead> <tbody> <tr> <td>VL1054B0</td> <td>ONE WASHING SYS INLET DISTRIBUTOR</td> <td>1</td> <td>PZ</td> </tr> <tr> <td>VL1065A1</td> <td>1/4 MALE N.O. PRESSURE SWITCH</td> <td>1</td> <td>PZ</td> </tr> <tr> <td>VL1102A1</td> <td>DETERGENT LINE FILTER + BARBED VNR 6 MM</td> <td>1</td> <td>PZ</td> </tr> <tr> <td>VL1128A1</td> <td>D6 BARBED CHECK VALVE</td> <td>2</td> <td>PZ</td> </tr> <tr> <td>VL1165A0</td> <td>BB6-AR6 STRAIGHT FITTING</td> <td>1</td> <td>PZ</td> </tr> <tr> <td>VL1166A0</td> <td>BB6-AR6 L FITTING</td> <td>3</td> <td>PZ</td> </tr> <tr> <td>VL1174C0</td> <td>D1.2 MM CALIBRATED NOZZLE</td> <td>1</td> <td>PZ</td> </tr> <tr> <td>VL1185A0</td> <td>2 WAYS PLUS WASHING DISTRIBUTOR</td> <td>1</td> <td>PZ</td> </tr> <tr> <td>VM2172A0</td> <td>PUMP-WITH-CI RCUIT LOCKING PIN</td> <td>6</td> <td>PZ</td> </tr> </tbody> </table>	Code	Description	Qty	UOM	VL1054B0	ONE WASHING SYS INLET DISTRIBUTOR	1	PZ	VL1065A1	1/4 MALE N.O. PRESSURE SWITCH	1	PZ	VL1102A1	DETERGENT LINE FILTER + BARBED VNR 6 MM	1	PZ	VL1128A1	D6 BARBED CHECK VALVE	2	PZ	VL1165A0	BB6-AR6 STRAIGHT FITTING	1	PZ	VL1166A0	BB6-AR6 L FITTING	3	PZ	VL1174C0	D1.2 MM CALIBRATED NOZZLE	1	PZ	VL1185A0	2 WAYS PLUS WASHING DISTRIBUTOR	1	PZ	VM2172A0	PUMP-WITH-CI RCUIT LOCKING PIN	6	PZ				
Code	Description	Qty	UOM																																														
VL1054B0	ONE WASHING SYS INLET DISTRIBUTOR	1	PZ																																														
VL1065A1	1/4 MALE N.O. PRESSURE SWITCH	1	PZ																																														
VL1102A1	DETERGENT LINE FILTER + BARBED VNR 6 MM	1	PZ																																														
VL1128A1	D6 BARBED CHECK VALVE	2	PZ																																														
VL1165A0	BB6-AR6 STRAIGHT FITTING	1	PZ																																														
VL1166A0	BB6-AR6 L FITTING	3	PZ																																														
VL1174C0	D1.2 MM CALIBRATED NOZZLE	1	PZ																																														
VL1185A0	2 WAYS PLUS WASHING DISTRIBUTOR	1	PZ																																														
VM2172A0	PUMP-WITH-CI RCUIT LOCKING PIN	6	PZ																																														
			KVL1212A	EUR COMPACT PLUS CLEANING SYSTEM KIT	<table border="1"> <thead> <tr> <th>Code</th> <th>Description</th> <th>Qty</th> <th>UOM</th> </tr> </thead> <tbody> <tr> <td>0H2428A0</td> <td></td> <td>1</td> <td>PZ</td> </tr> <tr> <td>EL1440A0</td> <td>WATER SELF CLEANING VALVE</td> <td>3</td> <td>PZ</td> </tr> <tr> <td>GN1312A0</td> <td>RUBBER CABLE-PASSI NG DE=26 DI=15 SP=10</td> <td>1</td> <td>PZ</td> </tr> <tr> <td>GN1526A0</td> <td>INT. D.=6.9 TH=1.8 O-RIN</td> <td>7</td> <td>PZ</td> </tr> <tr> <td>RC1018A0</td> <td>ZINC PLATED D12 ELASTIC CLAMP</td> <td>3</td> <td>PZ</td> </tr> <tr> <td>RC1019A0</td> <td>D=10 ELASTIC CLAMP</td> <td>14</td> <td>PZ</td> </tr> <tr> <td>RC1130A0</td> <td>130X2,6 CLAM</td> <td>1</td> <td>PZ</td> </tr> <tr> <td>RC1131A0</td> <td>200X2.6 BLACK CLAMP</td> <td>1</td> <td>PZ</td> </tr> <tr> <td>RC1242A0</td> <td>D=10 CLOSED CAP</td> <td>2</td> <td>PZ</td> </tr> <tr> <td>RC1356A0</td> <td>"STRAIGHT THREADED FEMALE END 8X1/4" BS</td> <td>1</td> <td>PZ</td> </tr> </tbody> </table>	Code	Description	Qty	UOM	0H2428A0		1	PZ	EL1440A0	WATER SELF CLEANING VALVE	3	PZ	GN1312A0	RUBBER CABLE-PASSI NG DE=26 DI=15 SP=10	1	PZ	GN1526A0	INT. D.=6.9 TH=1.8 O-RIN	7	PZ	RC1018A0	ZINC PLATED D12 ELASTIC CLAMP	3	PZ	RC1019A0	D=10 ELASTIC CLAMP	14	PZ	RC1130A0	130X2,6 CLAM	1	PZ	RC1131A0	200X2.6 BLACK CLAMP	1	PZ	RC1242A0	D=10 CLOSED CAP	2	PZ	RC1356A0	"STRAIGHT THREADED FEMALE END 8X1/4" BS	1	PZ
Code	Description	Qty	UOM																																														
0H2428A0		1	PZ																																														
EL1440A0	WATER SELF CLEANING VALVE	3	PZ																																														
GN1312A0	RUBBER CABLE-PASSI NG DE=26 DI=15 SP=10	1	PZ																																														
GN1526A0	INT. D.=6.9 TH=1.8 O-RIN	7	PZ																																														
RC1018A0	ZINC PLATED D12 ELASTIC CLAMP	3	PZ																																														
RC1019A0	D=10 ELASTIC CLAMP	14	PZ																																														
RC1130A0	130X2,6 CLAM	1	PZ																																														
RC1131A0	200X2.6 BLACK CLAMP	1	PZ																																														
RC1242A0	D=10 CLOSED CAP	2	PZ																																														
RC1356A0	"STRAIGHT THREADED FEMALE END 8X1/4" BS	1	PZ																																														



COMPONENT			SPARE PART																																																														
Code	Description	Image	Code	Description	Components list																																																												
VL1165A	BB6-AR6 STRAIGHT FITTING		KVL1212A	EUR COMPACT PLUS CLEANING SYSTEM KIT	<table border="1"> <thead> <tr> <th>Code</th> <th>Description</th> <th>Qty</th> <th>UOM</th> </tr> </thead> <tbody> <tr> <td>TB2820A0</td> <td>6X10 EPDM PIPE FOR WASHING SYSTEM</td> <td>1.340</td> <td>M</td> </tr> <tr> <td>TB3132A0</td> <td>WHITE-BLUE EPDM TEXTILE BRAID HOSE 6X12</td> <td>1.400</td> <td>M</td> </tr> <tr> <td>VI1220A1</td> <td>4,2X12 TCB SELF-TAPPIN G SCREW</td> <td>3</td> <td>PZ</td> </tr> <tr> <td>VL1019A0</td> <td>VIBRATION PUMP</td> <td>1</td> <td>PZ</td> </tr> <tr> <td>VL1047A1</td> <td>D6 PIPE HOLDER - D8 J.G. TERMINAL</td> <td>1</td> <td>PZ</td> </tr> <tr> <td>VL1054B0</td> <td>ONE WASHING SYS INLET DISTRIBUTOR</td> <td>1</td> <td>PZ</td> </tr> <tr> <td>VL1065A1</td> <td>1/4 MALE N.O. PRESSURE SWITCH</td> <td>1</td> <td>PZ</td> </tr> <tr> <td>VL1102A1</td> <td>DETERGENT LINE FILTER + BARBED VNR 6 MM</td> <td>1</td> <td>PZ</td> </tr> <tr> <td>VL1128A1</td> <td>D6 BARBED CHECK VALVE</td> <td>2</td> <td>PZ</td> </tr> <tr> <td>VL1165A0</td> <td>BB6-AR6 STRAIGHT FITTING</td> <td>1</td> <td>PZ</td> </tr> <tr> <td>VL1166A0</td> <td>BB6-AR6 L FITTING</td> <td>3</td> <td>PZ</td> </tr> <tr> <td>VL1174C0</td> <td>D1.2 MM CALIBRATED NOZZLE</td> <td>1</td> <td>PZ</td> </tr> <tr> <td>VL1185A0</td> <td>2 WAYS PLUS WASHING DISTRIBUTOR</td> <td>1</td> <td>PZ</td> </tr> <tr> <td>VM2172A0</td> <td>PUMP-WITH-CI RCUIT LOCKING PIN</td> <td>6</td> <td>PZ</td> </tr> </tbody> </table>	Code	Description	Qty	UOM	TB2820A0	6X10 EPDM PIPE FOR WASHING SYSTEM	1.340	M	TB3132A0	WHITE-BLUE EPDM TEXTILE BRAID HOSE 6X12	1.400	M	VI1220A1	4,2X12 TCB SELF-TAPPIN G SCREW	3	PZ	VL1019A0	VIBRATION PUMP	1	PZ	VL1047A1	D6 PIPE HOLDER - D8 J.G. TERMINAL	1	PZ	VL1054B0	ONE WASHING SYS INLET DISTRIBUTOR	1	PZ	VL1065A1	1/4 MALE N.O. PRESSURE SWITCH	1	PZ	VL1102A1	DETERGENT LINE FILTER + BARBED VNR 6 MM	1	PZ	VL1128A1	D6 BARBED CHECK VALVE	2	PZ	VL1165A0	BB6-AR6 STRAIGHT FITTING	1	PZ	VL1166A0	BB6-AR6 L FITTING	3	PZ	VL1174C0	D1.2 MM CALIBRATED NOZZLE	1	PZ	VL1185A0	2 WAYS PLUS WASHING DISTRIBUTOR	1	PZ	VM2172A0	PUMP-WITH-CI RCUIT LOCKING PIN	6	PZ
Code	Description	Qty	UOM																																																														
TB2820A0	6X10 EPDM PIPE FOR WASHING SYSTEM	1.340	M																																																														
TB3132A0	WHITE-BLUE EPDM TEXTILE BRAID HOSE 6X12	1.400	M																																																														
VI1220A1	4,2X12 TCB SELF-TAPPIN G SCREW	3	PZ																																																														
VL1019A0	VIBRATION PUMP	1	PZ																																																														
VL1047A1	D6 PIPE HOLDER - D8 J.G. TERMINAL	1	PZ																																																														
VL1054B0	ONE WASHING SYS INLET DISTRIBUTOR	1	PZ																																																														
VL1065A1	1/4 MALE N.O. PRESSURE SWITCH	1	PZ																																																														
VL1102A1	DETERGENT LINE FILTER + BARBED VNR 6 MM	1	PZ																																																														
VL1128A1	D6 BARBED CHECK VALVE	2	PZ																																																														
VL1165A0	BB6-AR6 STRAIGHT FITTING	1	PZ																																																														
VL1166A0	BB6-AR6 L FITTING	3	PZ																																																														
VL1174C0	D1.2 MM CALIBRATED NOZZLE	1	PZ																																																														
VL1185A0	2 WAYS PLUS WASHING DISTRIBUTOR	1	PZ																																																														
VM2172A0	PUMP-WITH-CI RCUIT LOCKING PIN	6	PZ																																																														
			KVL1211A	ONE COMPACT AND 0523-EP WASH. SYSTEM KIT	<table border="1"> <thead> <tr> <th>Code</th> <th>Description</th> <th>Qty</th> <th>UOM</th> </tr> </thead> <tbody> <tr> <td>0H2427A0</td> <td></td> <td>1</td> <td>PZ</td> </tr> <tr> <td>EL1440A0</td> <td>WATER SELF CLEANING VALVE</td> <td>1</td> <td>PZ</td> </tr> <tr> <td>GN1526A0</td> <td>INT. D.=6.9 TH=1.8 O-RIN</td> <td>3</td> <td>PZ</td> </tr> <tr> <td>RC1018A0</td> <td>ZINC PLATED D12 ELASTIC CLAMP</td> <td>2</td> <td>PZ</td> </tr> </tbody> </table>	Code	Description	Qty	UOM	0H2427A0		1	PZ	EL1440A0	WATER SELF CLEANING VALVE	1	PZ	GN1526A0	INT. D.=6.9 TH=1.8 O-RIN	3	PZ	RC1018A0	ZINC PLATED D12 ELASTIC CLAMP	2	PZ																																								
Code	Description	Qty	UOM																																																														
0H2427A0		1	PZ																																																														
EL1440A0	WATER SELF CLEANING VALVE	1	PZ																																																														
GN1526A0	INT. D.=6.9 TH=1.8 O-RIN	3	PZ																																																														
RC1018A0	ZINC PLATED D12 ELASTIC CLAMP	2	PZ																																																														

COMPONENT			SPARE PART																																																																																					
Code	Description	Image	Code	Description	Components list																																																																																			
VL1165A	BB6-AR6 STRAIGHT FITTING		KVL1211A	ONE COMPACT AND 0523-EP WASH. SYSTEM KIT	<table border="1"> <thead> <tr> <th>Code</th> <th>Description</th> <th>Qty</th> <th>UOM</th> </tr> </thead> <tbody> <tr> <td>RC1019A0</td> <td>D=10 ELASTIC CLAMP</td> <td>14</td> <td>PZ</td> </tr> <tr> <td>RC1130A0</td> <td>130X2,6 CLAM</td> <td>1</td> <td>PZ</td> </tr> <tr> <td>RC1242A0</td> <td>D=10 CLOSED CAP</td> <td>2</td> <td>PZ</td> </tr> <tr> <td>TB2820A0</td> <td>6X10 EPDM PIPE FOR WASHING SYSTEM</td> <td>1.290</td> <td>M</td> </tr> <tr> <td>TB3132A0</td> <td>WHITE-BLUE EPDM TEXTILE BRAID HOSE 6X12</td> <td>0.670</td> <td>M</td> </tr> <tr> <td>VI1220A1</td> <td>4,2X12 TCB SELF-TAPPING SCREW</td> <td>4</td> <td>PZ</td> </tr> <tr> <td>VL1019A0</td> <td>VIBRATION PUMP</td> <td>1</td> <td>PZ</td> </tr> <tr> <td>VL1047A1</td> <td>D6 PIPE HOLDER - D6 J.G. TERMINAL</td> <td>1</td> <td>PZ</td> </tr> <tr> <td>VL1054B0</td> <td>ONE WASHING SYS INLET DISTRIBUTOR</td> <td>1</td> <td>PZ</td> </tr> <tr> <td>VL1102A1</td> <td>DETERGENT LINE FILTER + BARBED VNR 6 MM</td> <td>1</td> <td>PZ</td> </tr> <tr> <td>VL1128A1</td> <td>D6 BARBED CHECK VALVE</td> <td>2</td> <td>PZ</td> </tr> <tr> <td>VL1165A0</td> <td>BB6-AR6 STRAIGHT FITTING</td> <td>1</td> <td>PZ</td> </tr> <tr> <td>VL1166A0</td> <td>BB6-AR6 L FITTING</td> <td>1</td> <td>PZ</td> </tr> <tr> <td>VL1174C0</td> <td>D1.2 MM CALIBRATED NOZZLE</td> <td>1</td> <td>PZ</td> </tr> <tr> <td>VL1191A0</td> <td>ONE WASHING DISTRIBUTOR OUTLETS KIT</td> <td>1</td> <td>PZ</td> </tr> <tr> <td>VM2172A0</td> <td>PUMP-WITH-CI RCUIT LOCKING PIN</td> <td>3</td> <td>PZ</td> </tr> </tbody> </table>	Code	Description	Qty	UOM	RC1019A0	D=10 ELASTIC CLAMP	14	PZ	RC1130A0	130X2,6 CLAM	1	PZ	RC1242A0	D=10 CLOSED CAP	2	PZ	TB2820A0	6X10 EPDM PIPE FOR WASHING SYSTEM	1.290	M	TB3132A0	WHITE-BLUE EPDM TEXTILE BRAID HOSE 6X12	0.670	M	VI1220A1	4,2X12 TCB SELF-TAPPING SCREW	4	PZ	VL1019A0	VIBRATION PUMP	1	PZ	VL1047A1	D6 PIPE HOLDER - D6 J.G. TERMINAL	1	PZ	VL1054B0	ONE WASHING SYS INLET DISTRIBUTOR	1	PZ	VL1102A1	DETERGENT LINE FILTER + BARBED VNR 6 MM	1	PZ	VL1128A1	D6 BARBED CHECK VALVE	2	PZ	VL1165A0	BB6-AR6 STRAIGHT FITTING	1	PZ	VL1166A0	BB6-AR6 L FITTING	1	PZ	VL1174C0	D1.2 MM CALIBRATED NOZZLE	1	PZ	VL1191A0	ONE WASHING DISTRIBUTOR OUTLETS KIT	1	PZ	VM2172A0	PUMP-WITH-CI RCUIT LOCKING PIN	3	PZ	KVL1209A	US PLUS 3 ROTOR ARMS WASHING SYSTEM KIT	<table border="1"> <thead> <tr> <th>Code</th> <th>Description</th> <th>Qty</th> <th>UOM</th> </tr> </thead> <tbody> <tr> <td>0H2354A0</td> <td>XEVC-XEVL WASHING CIRCUIT PLAT</td> <td>1</td> <td>PZ</td> </tr> <tr> <td>0H2411A0</td> <td></td> <td>1</td> <td>PZ</td> </tr> </tbody> </table>	Code	Description	Qty	UOM	0H2354A0	XEVC-XEVL WASHING CIRCUIT PLAT	1	PZ	0H2411A0		1	PZ
			Code	Description	Qty	UOM																																																																																		
RC1019A0	D=10 ELASTIC CLAMP	14	PZ																																																																																					
RC1130A0	130X2,6 CLAM	1	PZ																																																																																					
RC1242A0	D=10 CLOSED CAP	2	PZ																																																																																					
TB2820A0	6X10 EPDM PIPE FOR WASHING SYSTEM	1.290	M																																																																																					
TB3132A0	WHITE-BLUE EPDM TEXTILE BRAID HOSE 6X12	0.670	M																																																																																					
VI1220A1	4,2X12 TCB SELF-TAPPING SCREW	4	PZ																																																																																					
VL1019A0	VIBRATION PUMP	1	PZ																																																																																					
VL1047A1	D6 PIPE HOLDER - D6 J.G. TERMINAL	1	PZ																																																																																					
VL1054B0	ONE WASHING SYS INLET DISTRIBUTOR	1	PZ																																																																																					
VL1102A1	DETERGENT LINE FILTER + BARBED VNR 6 MM	1	PZ																																																																																					
VL1128A1	D6 BARBED CHECK VALVE	2	PZ																																																																																					
VL1165A0	BB6-AR6 STRAIGHT FITTING	1	PZ																																																																																					
VL1166A0	BB6-AR6 L FITTING	1	PZ																																																																																					
VL1174C0	D1.2 MM CALIBRATED NOZZLE	1	PZ																																																																																					
VL1191A0	ONE WASHING DISTRIBUTOR OUTLETS KIT	1	PZ																																																																																					
VM2172A0	PUMP-WITH-CI RCUIT LOCKING PIN	3	PZ																																																																																					
Code	Description	Qty	UOM																																																																																					
0H2354A0	XEVC-XEVL WASHING CIRCUIT PLAT	1	PZ																																																																																					
0H2411A0		1	PZ																																																																																					



COMPONENT			SPARE PART																																																																																						
Code	Description	Image	Code	Description	Components list																																																																																				
VL1165A	BB6-AR6 STRAIGHT FITTING		KVL1209A	US PLUS 3 ROTOR ARMS WASHING SYSTEM KIT	<table border="1"> <thead> <tr> <th>Code</th> <th>Description</th> <th>Qty</th> <th>UOM</th> </tr> </thead> <tbody> <tr> <td>EL1450A0</td> <td>US SELF-CLEANIN G WATER SOLENOID</td> <td>4</td> <td>PZ</td> </tr> <tr> <td>GN1526A0</td> <td>INT. D.=6.9 TH=1.8 O-RIN</td> <td>9</td> <td>PZ</td> </tr> <tr> <td>RC1018A0</td> <td>ZINC PLATED D12 ELASTIC CLAMP</td> <td>13</td> <td>PZ</td> </tr> <tr> <td>RC1019A0</td> <td>D=10 ELASTIC CLAMP</td> <td>15</td> <td>PZ</td> </tr> <tr> <td>RC1130A0</td> <td>130X2,6 CLAM</td> <td>1</td> <td>PZ</td> </tr> <tr> <td>RC1131A0</td> <td>200X2.6 BLACK CLAMP</td> <td>3</td> <td>PZ</td> </tr> <tr> <td>RC1242A0</td> <td>D=10 CLOSED CAP</td> <td>2</td> <td>PZ</td> </tr> <tr> <td>RC1356A0</td> <td>"STRAIGHT THREADED FEMALE END 8X1/4" BS</td> <td>1</td> <td>PZ</td> </tr> <tr> <td>TB2820A0</td> <td>6X10 EPDM PIPE FOR WASHING SYSTEM</td> <td>2.750</td> <td>M</td> </tr> <tr> <td>TB3132A0</td> <td>WHITE-BLUE EPDM TEXTILE BRAID HOSE 6X12</td> <td>1.980</td> <td>M</td> </tr> <tr> <td>VI1220A1</td> <td>4,2X12 TCB SELF-TAPPIN G SCREW</td> <td>3</td> <td>PZ</td> </tr> <tr> <td>VL1019A0</td> <td>VIBRATION PUMP</td> <td>1</td> <td>PZ</td> </tr> <tr> <td>VL1065A1</td> <td>1/4 MALE N.O. PRESSURE SWITCH</td> <td>1</td> <td>PZ</td> </tr> <tr> <td>VL1102A1</td> <td>DETERGENT LINE FILTER + BARBED VNR 6 MM</td> <td>1</td> <td>PZ</td> </tr> <tr> <td>VL1127A1</td> <td>6MM BARBED T-SHAPED FITTING</td> <td>2</td> <td>PZ</td> </tr> <tr> <td>VL1128A1</td> <td>D6 BARBED CHECK VALVE</td> <td>3</td> <td>PZ</td> </tr> <tr> <td>VL1165A0</td> <td>BB6-AR6 STRAIGHT FITTING</td> <td>1</td> <td>PZ</td> </tr> <tr> <td>VL1166A0</td> <td>BB6-AR6 L FITTING</td> <td>4</td> <td>PZ</td> </tr> <tr> <td>VL1167A0</td> <td></td> <td>1</td> <td>PZ</td> </tr> <tr> <td>VL1167A1</td> <td></td> <td>1</td> <td>PZ</td> </tr> </tbody> </table>	Code	Description	Qty	UOM	EL1450A0	US SELF-CLEANIN G WATER SOLENOID	4	PZ	GN1526A0	INT. D.=6.9 TH=1.8 O-RIN	9	PZ	RC1018A0	ZINC PLATED D12 ELASTIC CLAMP	13	PZ	RC1019A0	D=10 ELASTIC CLAMP	15	PZ	RC1130A0	130X2,6 CLAM	1	PZ	RC1131A0	200X2.6 BLACK CLAMP	3	PZ	RC1242A0	D=10 CLOSED CAP	2	PZ	RC1356A0	"STRAIGHT THREADED FEMALE END 8X1/4" BS	1	PZ	TB2820A0	6X10 EPDM PIPE FOR WASHING SYSTEM	2.750	M	TB3132A0	WHITE-BLUE EPDM TEXTILE BRAID HOSE 6X12	1.980	M	VI1220A1	4,2X12 TCB SELF-TAPPIN G SCREW	3	PZ	VL1019A0	VIBRATION PUMP	1	PZ	VL1065A1	1/4 MALE N.O. PRESSURE SWITCH	1	PZ	VL1102A1	DETERGENT LINE FILTER + BARBED VNR 6 MM	1	PZ	VL1127A1	6MM BARBED T-SHAPED FITTING	2	PZ	VL1128A1	D6 BARBED CHECK VALVE	3	PZ	VL1165A0	BB6-AR6 STRAIGHT FITTING	1	PZ	VL1166A0	BB6-AR6 L FITTING	4	PZ	VL1167A0		1	PZ	VL1167A1		1	PZ
Code	Description	Qty	UOM																																																																																						
EL1450A0	US SELF-CLEANIN G WATER SOLENOID	4	PZ																																																																																						
GN1526A0	INT. D.=6.9 TH=1.8 O-RIN	9	PZ																																																																																						
RC1018A0	ZINC PLATED D12 ELASTIC CLAMP	13	PZ																																																																																						
RC1019A0	D=10 ELASTIC CLAMP	15	PZ																																																																																						
RC1130A0	130X2,6 CLAM	1	PZ																																																																																						
RC1131A0	200X2.6 BLACK CLAMP	3	PZ																																																																																						
RC1242A0	D=10 CLOSED CAP	2	PZ																																																																																						
RC1356A0	"STRAIGHT THREADED FEMALE END 8X1/4" BS	1	PZ																																																																																						
TB2820A0	6X10 EPDM PIPE FOR WASHING SYSTEM	2.750	M																																																																																						
TB3132A0	WHITE-BLUE EPDM TEXTILE BRAID HOSE 6X12	1.980	M																																																																																						
VI1220A1	4,2X12 TCB SELF-TAPPIN G SCREW	3	PZ																																																																																						
VL1019A0	VIBRATION PUMP	1	PZ																																																																																						
VL1065A1	1/4 MALE N.O. PRESSURE SWITCH	1	PZ																																																																																						
VL1102A1	DETERGENT LINE FILTER + BARBED VNR 6 MM	1	PZ																																																																																						
VL1127A1	6MM BARBED T-SHAPED FITTING	2	PZ																																																																																						
VL1128A1	D6 BARBED CHECK VALVE	3	PZ																																																																																						
VL1165A0	BB6-AR6 STRAIGHT FITTING	1	PZ																																																																																						
VL1166A0	BB6-AR6 L FITTING	4	PZ																																																																																						
VL1167A0		1	PZ																																																																																						
VL1167A1		1	PZ																																																																																						



COMPONENT			SPARE PART																																															
Code	Description	Image	Code	Description	Components list																																													
VL1165A	BB6-AR6 STRAIGHT FITTING		KVL1209A	US PLUS 3 ROTOR ARMS WASHING SYSTEM KIT	<table border="1"> <thead> <tr> <th>Code</th> <th>Description</th> <th>Qty</th> <th>UOM</th> </tr> </thead> <tbody> <tr> <td>VL1167A2</td> <td>GN21 3 ROTOR ARMS B-B FLOW RESTRICTOR</td> <td>1</td> <td>PZ</td> </tr> <tr> <td>VL1174C0</td> <td>D1.2 MM CALIBRATED NOZZLE</td> <td>1</td> <td>PZ</td> </tr> <tr> <td>VL1185A0</td> <td>2 WAYS PLUS WASHING DISTRIBUTOR</td> <td>1</td> <td>PZ</td> </tr> <tr> <td>VL1186A0</td> <td>3 WAYS PLUS WASHING DISTRIBUTOR</td> <td>1</td> <td>PZ</td> </tr> <tr> <td>VL1190A0</td> <td>PLUS WASHING SYSTEM INLET DISTRIBUTOR</td> <td>1</td> <td>PZ</td> </tr> <tr> <td>VM1605A0</td> <td>CLIP TWIST LOCK DIAM. 10.2-12.7 MM</td> <td>6</td> <td>PZ</td> </tr> <tr> <td>VM2172A0</td> <td>PUMP-WITH-CI RCUIT LOCKING PIN</td> <td>9</td> <td>PZ</td> </tr> </tbody> </table>	Code	Description	Qty	UOM	VL1167A2	GN21 3 ROTOR ARMS B-B FLOW RESTRICTOR	1	PZ	VL1174C0	D1.2 MM CALIBRATED NOZZLE	1	PZ	VL1185A0	2 WAYS PLUS WASHING DISTRIBUTOR	1	PZ	VL1186A0	3 WAYS PLUS WASHING DISTRIBUTOR	1	PZ	VL1190A0	PLUS WASHING SYSTEM INLET DISTRIBUTOR	1	PZ	VM1605A0	CLIP TWIST LOCK DIAM. 10.2-12.7 MM	6	PZ	VM2172A0	PUMP-WITH-CI RCUIT LOCKING PIN	9	PZ													
			Code	Description	Qty	UOM																																												
VL1167A2	GN21 3 ROTOR ARMS B-B FLOW RESTRICTOR	1	PZ																																															
VL1174C0	D1.2 MM CALIBRATED NOZZLE	1	PZ																																															
VL1185A0	2 WAYS PLUS WASHING DISTRIBUTOR	1	PZ																																															
VL1186A0	3 WAYS PLUS WASHING DISTRIBUTOR	1	PZ																																															
VL1190A0	PLUS WASHING SYSTEM INLET DISTRIBUTOR	1	PZ																																															
VM1605A0	CLIP TWIST LOCK DIAM. 10.2-12.7 MM	6	PZ																																															
VM2172A0	PUMP-WITH-CI RCUIT LOCKING PIN	9	PZ																																															
KVL1208A	US PLUS 2 ROTOR ARMS WASHING SYSTEM KIT	<table border="1"> <thead> <tr> <th>Code</th> <th>Description</th> <th>Qty</th> <th>UOM</th> </tr> </thead> <tbody> <tr> <td>0H2354A0</td> <td>XEVC-XEVL WASHING CIRCUIT PLAT</td> <td>1</td> <td>PZ</td> </tr> <tr> <td>0H2411A0</td> <td>US</td> <td>1</td> <td>PZ</td> </tr> <tr> <td>EL1450A0</td> <td>SELF-CLEANIN G WATER SOLENOID</td> <td>4</td> <td>PZ</td> </tr> <tr> <td>GN1526A0</td> <td>INT. D.=6.9 TH=1.8 O-RIN</td> <td>9</td> <td>PZ</td> </tr> <tr> <td>RC1018A0</td> <td>ZINC PLATED D12 ELASTIC CLAMP</td> <td>4</td> <td>PZ</td> </tr> <tr> <td>RC1019A0</td> <td>D=10 ELASTIC CLAMP</td> <td>16</td> <td>PZ</td> </tr> <tr> <td>RC1130A0</td> <td>130X2,6 CLAM</td> <td>1</td> <td>PZ</td> </tr> <tr> <td>RC1131A0</td> <td>200X2.6 BLACK CLAMP</td> <td>3</td> <td>PZ</td> </tr> <tr> <td>RC1242A0</td> <td>D=10 CLOSED CAP</td> <td>2</td> <td>PZ</td> </tr> <tr> <td>RC1356A0</td> <td>"STRAIGHT THREADED FEMALE END 8X1/4" BS</td> <td>1</td> <td>PZ</td> </tr> <tr> <td>TB2820A0</td> <td>6X10 EPDM PIPE FOR WASHING SYSTEM</td> <td>2.890</td> <td>M</td> </tr> </tbody> </table>	Code	Description	Qty	UOM	0H2354A0	XEVC-XEVL WASHING CIRCUIT PLAT	1	PZ	0H2411A0	US	1	PZ	EL1450A0	SELF-CLEANIN G WATER SOLENOID	4	PZ	GN1526A0	INT. D.=6.9 TH=1.8 O-RIN	9	PZ	RC1018A0	ZINC PLATED D12 ELASTIC CLAMP	4	PZ	RC1019A0	D=10 ELASTIC CLAMP	16	PZ	RC1130A0	130X2,6 CLAM	1	PZ	RC1131A0	200X2.6 BLACK CLAMP	3	PZ	RC1242A0	D=10 CLOSED CAP	2	PZ	RC1356A0	"STRAIGHT THREADED FEMALE END 8X1/4" BS	1	PZ	TB2820A0	6X10 EPDM PIPE FOR WASHING SYSTEM	2.890	M
Code	Description	Qty	UOM																																															
0H2354A0	XEVC-XEVL WASHING CIRCUIT PLAT	1	PZ																																															
0H2411A0	US	1	PZ																																															
EL1450A0	SELF-CLEANIN G WATER SOLENOID	4	PZ																																															
GN1526A0	INT. D.=6.9 TH=1.8 O-RIN	9	PZ																																															
RC1018A0	ZINC PLATED D12 ELASTIC CLAMP	4	PZ																																															
RC1019A0	D=10 ELASTIC CLAMP	16	PZ																																															
RC1130A0	130X2,6 CLAM	1	PZ																																															
RC1131A0	200X2.6 BLACK CLAMP	3	PZ																																															
RC1242A0	D=10 CLOSED CAP	2	PZ																																															
RC1356A0	"STRAIGHT THREADED FEMALE END 8X1/4" BS	1	PZ																																															
TB2820A0	6X10 EPDM PIPE FOR WASHING SYSTEM	2.890	M																																															





COMPONENT			SPARE PART																																																																																	
Code	Description	Image	Code	Description	Components list																																																																															
VL1165A	BB6-AR6 STRAIGHT FITTING		KVL1208A	US PLUS 2 ROTOR ARMS WASHING SYSTEM KIT	<table border="1"> <thead> <tr> <th>Code</th> <th>Description</th> <th>Qty</th> <th>UOM</th> </tr> </thead> <tbody> <tr> <td>TB3132A0</td> <td>WHITE-BLUE EPDM TEXTILE BRAID HOSE 6X12</td> <td>1.600</td> <td>M</td> </tr> <tr> <td>VI1220A1</td> <td>4,2X12 TCB SELF-TAPPING SCREW</td> <td>3</td> <td>PZ</td> </tr> <tr> <td>VL1019A0</td> <td>VIBRATION PUMP</td> <td>1</td> <td>PZ</td> </tr> <tr> <td>VL1047A1</td> <td>D6 PIPE HOLDER - D8 J.G. TERMINAL</td> <td>1</td> <td>PZ</td> </tr> <tr> <td>VL1065A1</td> <td>1/4 MALE N.O. PRESSURE SWITCH</td> <td>1</td> <td>PZ</td> </tr> <tr> <td>VL1102A1</td> <td>DETERGENT LINE FILTER + BARBED VNR 6 MM</td> <td>1</td> <td>PZ</td> </tr> <tr> <td>VL1128A1</td> <td>D6 BARBED CHECK VALVE</td> <td>2</td> <td>PZ</td> </tr> <tr> <td>VL1141A1</td> <td>STRAIGHT CONNECT BB6-BB6</td> <td>1</td> <td>PZ</td> </tr> <tr> <td>VL1165A0</td> <td>BB6-AR6 STRAIGHT FITTING</td> <td>1</td> <td>PZ</td> </tr> <tr> <td>VL1166A0</td> <td>BB6-AR6 L FITTING</td> <td>4</td> <td>PZ</td> </tr> <tr> <td>VL1174C0</td> <td>D1.2 MM CALIBRATED NOZZLE</td> <td>1</td> <td>PZ</td> </tr> <tr> <td>VL1186A0</td> <td>3 WAYS PLUS WASHING DISTRIBUTOR</td> <td>1</td> <td>PZ</td> </tr> <tr> <td>VL1190A0</td> <td>PLUS WASHING SYSTEM INLET DISTRIBUTOR</td> <td>1</td> <td>PZ</td> </tr> <tr> <td>VM1605A0</td> <td>CLIP TWIST LOCK DIAM. 10,2-12,7 MM</td> <td>6</td> <td>PZ</td> </tr> <tr> <td>VM2172A0</td> <td>PUMP-WITH-CI RCUIT LOCKING PIN</td> <td>9</td> <td>PZ</td> </tr> </tbody> </table>	Code	Description	Qty	UOM	TB3132A0	WHITE-BLUE EPDM TEXTILE BRAID HOSE 6X12	1.600	M	VI1220A1	4,2X12 TCB SELF-TAPPING SCREW	3	PZ	VL1019A0	VIBRATION PUMP	1	PZ	VL1047A1	D6 PIPE HOLDER - D8 J.G. TERMINAL	1	PZ	VL1065A1	1/4 MALE N.O. PRESSURE SWITCH	1	PZ	VL1102A1	DETERGENT LINE FILTER + BARBED VNR 6 MM	1	PZ	VL1128A1	D6 BARBED CHECK VALVE	2	PZ	VL1141A1	STRAIGHT CONNECT BB6-BB6	1	PZ	VL1165A0	BB6-AR6 STRAIGHT FITTING	1	PZ	VL1166A0	BB6-AR6 L FITTING	4	PZ	VL1174C0	D1.2 MM CALIBRATED NOZZLE	1	PZ	VL1186A0	3 WAYS PLUS WASHING DISTRIBUTOR	1	PZ	VL1190A0	PLUS WASHING SYSTEM INLET DISTRIBUTOR	1	PZ	VM1605A0	CLIP TWIST LOCK DIAM. 10,2-12,7 MM	6	PZ	VM2172A0	PUMP-WITH-CI RCUIT LOCKING PIN	9	PZ	KVL1207A	US PLUS 1 ROTOR ARM WASHING SYSTEM KIT	<table border="1"> <thead> <tr> <th>Code</th> <th>Description</th> <th>Qty</th> <th>UOM</th> </tr> </thead> <tbody> <tr> <td>0H2354A0</td> <td>XEVC-XEVL WASHING CIRCUIT PLAT</td> <td>1</td> <td>PZ</td> </tr> <tr> <td>0H2411A0</td> <td></td> <td>1</td> <td>PZ</td> </tr> </tbody> </table>	Code	Description	Qty	UOM	0H2354A0	XEVC-XEVL WASHING CIRCUIT PLAT	1	PZ	0H2411A0		1	PZ
			Code	Description	Qty	UOM																																																																														
TB3132A0	WHITE-BLUE EPDM TEXTILE BRAID HOSE 6X12	1.600	M																																																																																	
VI1220A1	4,2X12 TCB SELF-TAPPING SCREW	3	PZ																																																																																	
VL1019A0	VIBRATION PUMP	1	PZ																																																																																	
VL1047A1	D6 PIPE HOLDER - D8 J.G. TERMINAL	1	PZ																																																																																	
VL1065A1	1/4 MALE N.O. PRESSURE SWITCH	1	PZ																																																																																	
VL1102A1	DETERGENT LINE FILTER + BARBED VNR 6 MM	1	PZ																																																																																	
VL1128A1	D6 BARBED CHECK VALVE	2	PZ																																																																																	
VL1141A1	STRAIGHT CONNECT BB6-BB6	1	PZ																																																																																	
VL1165A0	BB6-AR6 STRAIGHT FITTING	1	PZ																																																																																	
VL1166A0	BB6-AR6 L FITTING	4	PZ																																																																																	
VL1174C0	D1.2 MM CALIBRATED NOZZLE	1	PZ																																																																																	
VL1186A0	3 WAYS PLUS WASHING DISTRIBUTOR	1	PZ																																																																																	
VL1190A0	PLUS WASHING SYSTEM INLET DISTRIBUTOR	1	PZ																																																																																	
VM1605A0	CLIP TWIST LOCK DIAM. 10,2-12,7 MM	6	PZ																																																																																	
VM2172A0	PUMP-WITH-CI RCUIT LOCKING PIN	9	PZ																																																																																	
Code	Description	Qty	UOM																																																																																	
0H2354A0	XEVC-XEVL WASHING CIRCUIT PLAT	1	PZ																																																																																	
0H2411A0		1	PZ																																																																																	



COMPONENT			SPARE PART																																																																																		
Code	Description	Image	Code	Description	Components list																																																																																
VL1165A	BB6-AR6 STRAIGHT FITTING		KVL1207A	US PLUS 1 ROTOR ARM WASHING SYSTEM KIT	<table border="1"> <thead> <tr> <th>Code</th> <th>Description</th> <th>Qty</th> <th>UOM</th> </tr> </thead> <tbody> <tr> <td>EL1450A0</td> <td>US SELF-CLEANING WATER SOLENOID</td> <td>3</td> <td>PZ</td> </tr> <tr> <td>GN1526A0</td> <td>INT. D.=6.9 TH=1.8 O-RING</td> <td>7</td> <td>PZ</td> </tr> <tr> <td>RC1018A0</td> <td>ZINC PLATED D12 ELASTIC CLAMP</td> <td>3</td> <td>PZ</td> </tr> <tr> <td>RC1019A0</td> <td>D=10 ELASTIC CLAMP</td> <td>14</td> <td>PZ</td> </tr> <tr> <td>RC1130A0</td> <td>130X2,6 CLAM</td> <td>1</td> <td>PZ</td> </tr> <tr> <td>RC1131A0</td> <td>200X2.6 BLACK CLAMP</td> <td>2</td> <td>PZ</td> </tr> <tr> <td>RC1242A0</td> <td>D=10 CLOSED CAP</td> <td>2</td> <td>PZ</td> </tr> <tr> <td>RC1356A0</td> <td>"STRAIGHT THREADED FEMALE END 8X1/4" BS</td> <td>1</td> <td>PZ</td> </tr> <tr> <td>TB2820A0</td> <td>6X10 EPDM PIPE FOR WASHING SYSTEM</td> <td>1.460</td> <td>M</td> </tr> <tr> <td>TB3132A0</td> <td>WHITE-BLUE EPDM TEXTILE BRAID HOSE 6X12</td> <td>0.770</td> <td>M</td> </tr> <tr> <td>VI1220A1</td> <td>4,2X12 TCB SELF-TAPPING G SCREW</td> <td>3</td> <td>PZ</td> </tr> <tr> <td>VL1019A0</td> <td>VIBRATION PUMP</td> <td>1</td> <td>PZ</td> </tr> <tr> <td>VL1047A1</td> <td>D6 PIPE HOLDER - D8 J.G. TERMINAL</td> <td>1</td> <td>PZ</td> </tr> <tr> <td>VL1065A1</td> <td>1/4 MALE N.O. PRESSURE SWITCH</td> <td>1</td> <td>PZ</td> </tr> <tr> <td>VL1102A1</td> <td>DETERGENT LINE FILTER + BARBED VNR 6 MM</td> <td>1</td> <td>PZ</td> </tr> <tr> <td>VL1128A1</td> <td>D6 BARBED CHECK VALVE</td> <td>2</td> <td>PZ</td> </tr> <tr> <td>VL1165A0</td> <td>BB6-AR6 STRAIGHT FITTING</td> <td>1</td> <td>PZ</td> </tr> <tr> <td>VL1166A0</td> <td>BB6-AR6 L FITTING</td> <td>3</td> <td>PZ</td> </tr> <tr> <td>VL1174C0</td> <td>D1.2 MM CALIBRATED NOZZLE</td> <td>1</td> <td>PZ</td> </tr> </tbody> </table>	Code	Description	Qty	UOM	EL1450A0	US SELF-CLEANING WATER SOLENOID	3	PZ	GN1526A0	INT. D.=6.9 TH=1.8 O-RING	7	PZ	RC1018A0	ZINC PLATED D12 ELASTIC CLAMP	3	PZ	RC1019A0	D=10 ELASTIC CLAMP	14	PZ	RC1130A0	130X2,6 CLAM	1	PZ	RC1131A0	200X2.6 BLACK CLAMP	2	PZ	RC1242A0	D=10 CLOSED CAP	2	PZ	RC1356A0	"STRAIGHT THREADED FEMALE END 8X1/4" BS	1	PZ	TB2820A0	6X10 EPDM PIPE FOR WASHING SYSTEM	1.460	M	TB3132A0	WHITE-BLUE EPDM TEXTILE BRAID HOSE 6X12	0.770	M	VI1220A1	4,2X12 TCB SELF-TAPPING G SCREW	3	PZ	VL1019A0	VIBRATION PUMP	1	PZ	VL1047A1	D6 PIPE HOLDER - D8 J.G. TERMINAL	1	PZ	VL1065A1	1/4 MALE N.O. PRESSURE SWITCH	1	PZ	VL1102A1	DETERGENT LINE FILTER + BARBED VNR 6 MM	1	PZ	VL1128A1	D6 BARBED CHECK VALVE	2	PZ	VL1165A0	BB6-AR6 STRAIGHT FITTING	1	PZ	VL1166A0	BB6-AR6 L FITTING	3	PZ	VL1174C0	D1.2 MM CALIBRATED NOZZLE	1	PZ
Code	Description	Qty	UOM																																																																																		
EL1450A0	US SELF-CLEANING WATER SOLENOID	3	PZ																																																																																		
GN1526A0	INT. D.=6.9 TH=1.8 O-RING	7	PZ																																																																																		
RC1018A0	ZINC PLATED D12 ELASTIC CLAMP	3	PZ																																																																																		
RC1019A0	D=10 ELASTIC CLAMP	14	PZ																																																																																		
RC1130A0	130X2,6 CLAM	1	PZ																																																																																		
RC1131A0	200X2.6 BLACK CLAMP	2	PZ																																																																																		
RC1242A0	D=10 CLOSED CAP	2	PZ																																																																																		
RC1356A0	"STRAIGHT THREADED FEMALE END 8X1/4" BS	1	PZ																																																																																		
TB2820A0	6X10 EPDM PIPE FOR WASHING SYSTEM	1.460	M																																																																																		
TB3132A0	WHITE-BLUE EPDM TEXTILE BRAID HOSE 6X12	0.770	M																																																																																		
VI1220A1	4,2X12 TCB SELF-TAPPING G SCREW	3	PZ																																																																																		
VL1019A0	VIBRATION PUMP	1	PZ																																																																																		
VL1047A1	D6 PIPE HOLDER - D8 J.G. TERMINAL	1	PZ																																																																																		
VL1065A1	1/4 MALE N.O. PRESSURE SWITCH	1	PZ																																																																																		
VL1102A1	DETERGENT LINE FILTER + BARBED VNR 6 MM	1	PZ																																																																																		
VL1128A1	D6 BARBED CHECK VALVE	2	PZ																																																																																		
VL1165A0	BB6-AR6 STRAIGHT FITTING	1	PZ																																																																																		
VL1166A0	BB6-AR6 L FITTING	3	PZ																																																																																		
VL1174C0	D1.2 MM CALIBRATED NOZZLE	1	PZ																																																																																		



COMPONENT			SPARE PART																																																											
Code	Description	Image	Code	Description	Components list																																																									
VL1165A	BB6-AR6 STRAIGHT FITTING		KVL1207A	US PLUS 1 ROTOR ARM WASHING SYSTEM KIT	<table border="1"> <thead> <tr> <th>Code</th> <th>Description</th> <th>Qty</th> <th>UOM</th> </tr> </thead> <tbody> <tr> <td>VL1185A0</td> <td>2 WAYS PLUS WASHING DISTRIBUTOR</td> <td>1</td> <td>PZ</td> </tr> <tr> <td>VL1190A0</td> <td>PLUS WASHING SYSTEM INLET DISTRIBUTOR</td> <td>1</td> <td>PZ</td> </tr> <tr> <td>VM1605A0</td> <td>CLIP TWIST LOCK DIAM. 10,2-12,7 MM</td> <td>6</td> <td>PZ</td> </tr> <tr> <td>VM2172A0</td> <td>PUMP-WITH-CI RCUIT LOCKING PIN</td> <td>6</td> <td>PZ</td> </tr> </tbody> </table>	Code	Description	Qty	UOM	VL1185A0	2 WAYS PLUS WASHING DISTRIBUTOR	1	PZ	VL1190A0	PLUS WASHING SYSTEM INLET DISTRIBUTOR	1	PZ	VM1605A0	CLIP TWIST LOCK DIAM. 10,2-12,7 MM	6	PZ	VM2172A0	PUMP-WITH-CI RCUIT LOCKING PIN	6	PZ																																					
			Code	Description	Qty	UOM																																																								
VL1185A0	2 WAYS PLUS WASHING DISTRIBUTOR	1	PZ																																																											
VL1190A0	PLUS WASHING SYSTEM INLET DISTRIBUTOR	1	PZ																																																											
VM1605A0	CLIP TWIST LOCK DIAM. 10,2-12,7 MM	6	PZ																																																											
VM2172A0	PUMP-WITH-CI RCUIT LOCKING PIN	6	PZ																																																											
KVL1198A	MM EU HOOD CLEANING SYSTEM KIT	<table border="1"> <thead> <tr> <th>Code</th> <th>Description</th> <th>Qty</th> <th>UOM</th> </tr> </thead> <tbody> <tr> <td>0H2213A1</td> <td></td> <td>1</td> <td>PZ</td> </tr> <tr> <td>EL1440A0</td> <td>WATER SELF CLEANING VALVE</td> <td>2</td> <td>PZ</td> </tr> <tr> <td>GN1526A0</td> <td>INT. D.=6.9 TH=1.8 O-RIN</td> <td>5</td> <td>PZ</td> </tr> <tr> <td>RC1018A0</td> <td>ZINC PLATED D12 ELASTIC CLAMP</td> <td>6</td> <td>PZ</td> </tr> <tr> <td>RC1019A0</td> <td>D=10 ELASTIC CLAMP</td> <td>16</td> <td>PZ</td> </tr> <tr> <td>RC1131A0</td> <td>200X2.6 BLACK CLAMP</td> <td>1</td> <td>PZ</td> </tr> <tr> <td>RC1242A0</td> <td>D=10 CLOSED CAP</td> <td>2</td> <td>PZ</td> </tr> <tr> <td>TB2820A0</td> <td>6X10 EPDM PIPE FOR WASHING SYSTEM</td> <td>2.240</td> <td>M</td> </tr> <tr> <td>TB3132A0</td> <td>WHITE-BLUE EPDM TEXTILE BRAID HOSE 6X12</td> <td>0.440</td> <td>M</td> </tr> <tr> <td>VI1220A1</td> <td>4,2X12 TCB SELF-TAPPIN G SCREW</td> <td>3</td> <td>PZ</td> </tr> <tr> <td>VL1019A0</td> <td>VIBRATION PUMP</td> <td>1</td> <td>PZ</td> </tr> <tr> <td>VL1047A1</td> <td>D6 PIPE HOLDER - D8 J.G. TERMINAL</td> <td>2</td> <td>PZ</td> </tr> <tr> <td>VL1054B0</td> <td>ONE WASHING SYS INLET DISTRIBUTOR</td> <td>1</td> <td>PZ</td> </tr> <tr> <td>VL1102A1</td> <td>DETERGENT LINE FILTER + BARBED VNR 6 MM</td> <td>1</td> <td>PZ</td> </tr> </tbody> </table>	Code	Description	Qty	UOM	0H2213A1		1	PZ	EL1440A0	WATER SELF CLEANING VALVE	2	PZ	GN1526A0	INT. D.=6.9 TH=1.8 O-RIN	5	PZ	RC1018A0	ZINC PLATED D12 ELASTIC CLAMP	6	PZ	RC1019A0	D=10 ELASTIC CLAMP	16	PZ	RC1131A0	200X2.6 BLACK CLAMP	1	PZ	RC1242A0	D=10 CLOSED CAP	2	PZ	TB2820A0	6X10 EPDM PIPE FOR WASHING SYSTEM	2.240	M	TB3132A0	WHITE-BLUE EPDM TEXTILE BRAID HOSE 6X12	0.440	M	VI1220A1	4,2X12 TCB SELF-TAPPIN G SCREW	3	PZ	VL1019A0	VIBRATION PUMP	1	PZ	VL1047A1	D6 PIPE HOLDER - D8 J.G. TERMINAL	2	PZ	VL1054B0	ONE WASHING SYS INLET DISTRIBUTOR	1	PZ	VL1102A1	DETERGENT LINE FILTER + BARBED VNR 6 MM	1	PZ
Code	Description	Qty	UOM																																																											
0H2213A1		1	PZ																																																											
EL1440A0	WATER SELF CLEANING VALVE	2	PZ																																																											
GN1526A0	INT. D.=6.9 TH=1.8 O-RIN	5	PZ																																																											
RC1018A0	ZINC PLATED D12 ELASTIC CLAMP	6	PZ																																																											
RC1019A0	D=10 ELASTIC CLAMP	16	PZ																																																											
RC1131A0	200X2.6 BLACK CLAMP	1	PZ																																																											
RC1242A0	D=10 CLOSED CAP	2	PZ																																																											
TB2820A0	6X10 EPDM PIPE FOR WASHING SYSTEM	2.240	M																																																											
TB3132A0	WHITE-BLUE EPDM TEXTILE BRAID HOSE 6X12	0.440	M																																																											
VI1220A1	4,2X12 TCB SELF-TAPPIN G SCREW	3	PZ																																																											
VL1019A0	VIBRATION PUMP	1	PZ																																																											
VL1047A1	D6 PIPE HOLDER - D8 J.G. TERMINAL	2	PZ																																																											
VL1054B0	ONE WASHING SYS INLET DISTRIBUTOR	1	PZ																																																											
VL1102A1	DETERGENT LINE FILTER + BARBED VNR 6 MM	1	PZ																																																											

COMPONENT			SPARE PART																																																										
Code	Description	Image	Code	Description	Components list																																																								
VL1165A	BB6-AR6 STRAIGHT FITTING		KVL1198A	MM EU HOOD CLEANING SYSTEM KIT	<table border="1"> <thead> <tr> <th>Code</th> <th>Description</th> <th>Qty</th> <th>UOM</th> </tr> </thead> <tbody> <tr> <td>VL1127A1</td> <td>6MM BARBED T-SHAPED FITTING</td> <td>1</td> <td>PZ</td> </tr> <tr> <td>VL1128A1</td> <td>D6 BARBED CHECK VALVE</td> <td>2</td> <td>PZ</td> </tr> <tr> <td>VL1165A0</td> <td>BB6-AR6 STRAIGHT FITTING</td> <td>2</td> <td>PZ</td> </tr> <tr> <td>VL1166A0</td> <td>BB6-AR6 L FITTING</td> <td>2</td> <td>PZ</td> </tr> <tr> <td>VL1174C0</td> <td>D1.2 MM CALIBRATED NOZZLE</td> <td>1</td> <td>PZ</td> </tr> <tr> <td>VL1191A0</td> <td>ONE WASHING DISTRIBUTOR OUTLETS KIT</td> <td>1</td> <td>PZ</td> </tr> <tr> <td>VM1605A0</td> <td>CLIP TWIST LOCK DIAM. 10,2-12,7 MM</td> <td>4</td> <td>PZ</td> </tr> <tr> <td>VM2172A0</td> <td>PUMP-WITH-CI RCUIT LOCKING PIN</td> <td>5</td> <td>PZ</td> </tr> </tbody> </table>	Code	Description	Qty	UOM	VL1127A1	6MM BARBED T-SHAPED FITTING	1	PZ	VL1128A1	D6 BARBED CHECK VALVE	2	PZ	VL1165A0	BB6-AR6 STRAIGHT FITTING	2	PZ	VL1166A0	BB6-AR6 L FITTING	2	PZ	VL1174C0	D1.2 MM CALIBRATED NOZZLE	1	PZ	VL1191A0	ONE WASHING DISTRIBUTOR OUTLETS KIT	1	PZ	VM1605A0	CLIP TWIST LOCK DIAM. 10,2-12,7 MM	4	PZ	VM2172A0	PUMP-WITH-CI RCUIT LOCKING PIN	5	PZ																				
Code	Description	Qty	UOM																																																										
VL1127A1	6MM BARBED T-SHAPED FITTING	1	PZ																																																										
VL1128A1	D6 BARBED CHECK VALVE	2	PZ																																																										
VL1165A0	BB6-AR6 STRAIGHT FITTING	2	PZ																																																										
VL1166A0	BB6-AR6 L FITTING	2	PZ																																																										
VL1174C0	D1.2 MM CALIBRATED NOZZLE	1	PZ																																																										
VL1191A0	ONE WASHING DISTRIBUTOR OUTLETS KIT	1	PZ																																																										
VM1605A0	CLIP TWIST LOCK DIAM. 10,2-12,7 MM	4	PZ																																																										
VM2172A0	PUMP-WITH-CI RCUIT LOCKING PIN	5	PZ																																																										
			KVL1187A	3 ROTOR ARMS PLUS EU CLEANING SYSTEM KIT	<table border="1"> <thead> <tr> <th>Code</th> <th>Description</th> <th>Qty</th> <th>UOM</th> </tr> </thead> <tbody> <tr> <td>0H2143A0</td> <td>LAMIERA BLOCCA VNR VL1128</td> <td>3</td> <td>PZ</td> </tr> <tr> <td>0H2168A0</td> <td></td> <td>1</td> <td>PZ</td> </tr> <tr> <td>0H2354A0</td> <td>XEVC-XEVL WASHING CIRCUIT PLAT</td> <td>1</td> <td>PZ</td> </tr> <tr> <td>EL1120A0</td> <td>D8-D6 FEMALE STRAIGHT INTERM. CONNECTION</td> <td>1</td> <td>PZ</td> </tr> <tr> <td>EL1220A0</td> <td>JG STRAIGHT CONNECTION Ø8F-Ø8F</td> <td>2</td> <td>PZ</td> </tr> <tr> <td>EL1440A0</td> <td>WATER SELF CLEANING VALVE</td> <td>4</td> <td>PZ</td> </tr> <tr> <td>GN1526A0</td> <td>INT. D.=6.9 TH=1.8 O-RIN</td> <td>9</td> <td>PZ</td> </tr> <tr> <td>RC1018A0</td> <td>ZINC PLATED D12 ELASTIC CLAMP</td> <td>10</td> <td>PZ</td> </tr> <tr> <td>RC1019A0</td> <td>D=10 ELASTIC CLAMP</td> <td>22</td> <td>PZ</td> </tr> <tr> <td>RC1130A0</td> <td>130X2,6 CLAM</td> <td>4</td> <td>PZ</td> </tr> <tr> <td>RC1131A0</td> <td>200X2,6 BLACK CLAMP</td> <td>3</td> <td>PZ</td> </tr> <tr> <td>RC1242A0</td> <td>D=10 CLOSED CAP</td> <td>2</td> <td>PZ</td> </tr> <tr> <td>RC1310A0</td> <td>140X4 CLAMP WITH CLIP</td> <td>1</td> <td>PZ</td> </tr> </tbody> </table>	Code	Description	Qty	UOM	0H2143A0	LAMIERA BLOCCA VNR VL1128	3	PZ	0H2168A0		1	PZ	0H2354A0	XEVC-XEVL WASHING CIRCUIT PLAT	1	PZ	EL1120A0	D8-D6 FEMALE STRAIGHT INTERM. CONNECTION	1	PZ	EL1220A0	JG STRAIGHT CONNECTION Ø8F-Ø8F	2	PZ	EL1440A0	WATER SELF CLEANING VALVE	4	PZ	GN1526A0	INT. D.=6.9 TH=1.8 O-RIN	9	PZ	RC1018A0	ZINC PLATED D12 ELASTIC CLAMP	10	PZ	RC1019A0	D=10 ELASTIC CLAMP	22	PZ	RC1130A0	130X2,6 CLAM	4	PZ	RC1131A0	200X2,6 BLACK CLAMP	3	PZ	RC1242A0	D=10 CLOSED CAP	2	PZ	RC1310A0	140X4 CLAMP WITH CLIP	1	PZ
Code	Description	Qty	UOM																																																										
0H2143A0	LAMIERA BLOCCA VNR VL1128	3	PZ																																																										
0H2168A0		1	PZ																																																										
0H2354A0	XEVC-XEVL WASHING CIRCUIT PLAT	1	PZ																																																										
EL1120A0	D8-D6 FEMALE STRAIGHT INTERM. CONNECTION	1	PZ																																																										
EL1220A0	JG STRAIGHT CONNECTION Ø8F-Ø8F	2	PZ																																																										
EL1440A0	WATER SELF CLEANING VALVE	4	PZ																																																										
GN1526A0	INT. D.=6.9 TH=1.8 O-RIN	9	PZ																																																										
RC1018A0	ZINC PLATED D12 ELASTIC CLAMP	10	PZ																																																										
RC1019A0	D=10 ELASTIC CLAMP	22	PZ																																																										
RC1130A0	130X2,6 CLAM	4	PZ																																																										
RC1131A0	200X2,6 BLACK CLAMP	3	PZ																																																										
RC1242A0	D=10 CLOSED CAP	2	PZ																																																										
RC1310A0	140X4 CLAMP WITH CLIP	1	PZ																																																										





COMPONENT			SPARE PART																																																																										
Code	Description	Image	Code	Description	Components list																																																																								
VL1165A	BB6-AR6 STRAIGHT FITTING		KVL1187A	3 ROTOR ARMS PLUS EU CLEANING SYSTEM KIT	<table border="1"> <thead> <tr> <th>Code</th> <th>Description</th> <th>Qty</th> <th>UOM</th> </tr> </thead> <tbody> <tr> <td>RC1356A0</td> <td>"STRAIGHT THREADED FEMALE END 8X1/4" BS</td> <td>1</td> <td>PZ</td> </tr> <tr> <td>TB2820A0</td> <td>6X10 EPDM PIPE FOR WASHING SYSTEM</td> <td>1.510</td> <td>M</td> </tr> <tr> <td>TB3132A0</td> <td>WHITE-BLUE EPDM TEXTILE BRAID HOSE 6X12</td> <td>1.210</td> <td>M</td> </tr> <tr> <td>VI1220A1</td> <td>4,2X12 TCB SELF-TAPPIN G SCREW</td> <td>3</td> <td>PZ</td> </tr> <tr> <td>VL1019A0</td> <td>VIBRATION PUMP</td> <td>1</td> <td>PZ</td> </tr> <tr> <td>VL1046A1</td> <td>D6 PIPE HOLDER - D6 J.G. TERMINAL</td> <td>3</td> <td>PZ</td> </tr> <tr> <td>VL1047A1</td> <td>D6 PIPE HOLDER - D8 J.G. TERMINAL</td> <td>1</td> <td>PZ</td> </tr> <tr> <td>VL1064A0</td> <td>WASHING SYSTEM OUTLETS DISTRIBUTOR</td> <td>1</td> <td>PZ</td> </tr> <tr> <td>VL1065A1</td> <td>1/4 MALE N.O. PRESSURE SWITCH</td> <td>1</td> <td>PZ</td> </tr> <tr> <td>VL1067A0</td> <td>WASHING SYSTEM INLETS DISTRIBUTOR</td> <td>1</td> <td>PZ</td> </tr> <tr> <td>VL1092A0</td> <td>WASHING SYSTEM OUTLET DOUBLE DISTRIBUTOR</td> <td>1</td> <td>PZ</td> </tr> <tr> <td>VL1102A1</td> <td>DETERGENT LINE FILTER + BARBED VNR 6 MM</td> <td>1</td> <td>PZ</td> </tr> <tr> <td>VL1127A1</td> <td>6MM BARBED T-SHAPED FITTING</td> <td>2</td> <td>PZ</td> </tr> <tr> <td>VL1128A0</td> <td>D6 BARBED CHECK VALVE</td> <td>3</td> <td>PZ</td> </tr> <tr> <td>VL1128A1</td> <td>D6 BARBED CHECK VALVE</td> <td>3</td> <td>PZ</td> </tr> <tr> <td>VL1165A0</td> <td>BB6-AR6 STRAIGHT FITTING</td> <td>4</td> <td>PZ</td> </tr> <tr> <td>VL1166A0</td> <td>BB6-AR6 L FITTING</td> <td>4</td> <td>PZ</td> </tr> </tbody> </table>	Code	Description	Qty	UOM	RC1356A0	"STRAIGHT THREADED FEMALE END 8X1/4" BS	1	PZ	TB2820A0	6X10 EPDM PIPE FOR WASHING SYSTEM	1.510	M	TB3132A0	WHITE-BLUE EPDM TEXTILE BRAID HOSE 6X12	1.210	M	VI1220A1	4,2X12 TCB SELF-TAPPIN G SCREW	3	PZ	VL1019A0	VIBRATION PUMP	1	PZ	VL1046A1	D6 PIPE HOLDER - D6 J.G. TERMINAL	3	PZ	VL1047A1	D6 PIPE HOLDER - D8 J.G. TERMINAL	1	PZ	VL1064A0	WASHING SYSTEM OUTLETS DISTRIBUTOR	1	PZ	VL1065A1	1/4 MALE N.O. PRESSURE SWITCH	1	PZ	VL1067A0	WASHING SYSTEM INLETS DISTRIBUTOR	1	PZ	VL1092A0	WASHING SYSTEM OUTLET DOUBLE DISTRIBUTOR	1	PZ	VL1102A1	DETERGENT LINE FILTER + BARBED VNR 6 MM	1	PZ	VL1127A1	6MM BARBED T-SHAPED FITTING	2	PZ	VL1128A0	D6 BARBED CHECK VALVE	3	PZ	VL1128A1	D6 BARBED CHECK VALVE	3	PZ	VL1165A0	BB6-AR6 STRAIGHT FITTING	4	PZ	VL1166A0	BB6-AR6 L FITTING	4	PZ
Code	Description	Qty	UOM																																																																										
RC1356A0	"STRAIGHT THREADED FEMALE END 8X1/4" BS	1	PZ																																																																										
TB2820A0	6X10 EPDM PIPE FOR WASHING SYSTEM	1.510	M																																																																										
TB3132A0	WHITE-BLUE EPDM TEXTILE BRAID HOSE 6X12	1.210	M																																																																										
VI1220A1	4,2X12 TCB SELF-TAPPIN G SCREW	3	PZ																																																																										
VL1019A0	VIBRATION PUMP	1	PZ																																																																										
VL1046A1	D6 PIPE HOLDER - D6 J.G. TERMINAL	3	PZ																																																																										
VL1047A1	D6 PIPE HOLDER - D8 J.G. TERMINAL	1	PZ																																																																										
VL1064A0	WASHING SYSTEM OUTLETS DISTRIBUTOR	1	PZ																																																																										
VL1065A1	1/4 MALE N.O. PRESSURE SWITCH	1	PZ																																																																										
VL1067A0	WASHING SYSTEM INLETS DISTRIBUTOR	1	PZ																																																																										
VL1092A0	WASHING SYSTEM OUTLET DOUBLE DISTRIBUTOR	1	PZ																																																																										
VL1102A1	DETERGENT LINE FILTER + BARBED VNR 6 MM	1	PZ																																																																										
VL1127A1	6MM BARBED T-SHAPED FITTING	2	PZ																																																																										
VL1128A0	D6 BARBED CHECK VALVE	3	PZ																																																																										
VL1128A1	D6 BARBED CHECK VALVE	3	PZ																																																																										
VL1165A0	BB6-AR6 STRAIGHT FITTING	4	PZ																																																																										
VL1166A0	BB6-AR6 L FITTING	4	PZ																																																																										

COMPONENT			SPARE PART																																															
Code	Description	Image	Code	Description	Components list																																													
VL1165A	BB6-AR6 STRAIGHT FITTING		KVL1187A	3 ROTOR ARMS PLUS EU CLEANING SYSTEM KIT	<table border="1"> <thead> <tr> <th>Code</th> <th>Description</th> <th>Qty</th> <th>UOM</th> </tr> </thead> <tbody> <tr> <td>VL1167A0</td> <td></td> <td>1</td> <td>PZ</td> </tr> <tr> <td>VL1167A1</td> <td></td> <td>1</td> <td>PZ</td> </tr> <tr> <td>VL1167A2</td> <td>GN21 3 ROTOR ARMS B-B FLOW RESTRICTOR</td> <td>1</td> <td>PZ</td> </tr> <tr> <td>VL1174C0</td> <td>D1.2 MM CALIBRATED NOZZLE</td> <td>1</td> <td>PZ</td> </tr> <tr> <td>VL1185A0</td> <td>2 WAYS PLUS WASHING DISTRIBUTOR</td> <td>1</td> <td>PZ</td> </tr> <tr> <td>VL1186A0</td> <td>3 WAYS PLUS WASHING DISTRIBUTOR</td> <td>1</td> <td>PZ</td> </tr> <tr> <td>VL1190A0</td> <td>PLUS WASHING SYSTEM INLET DISTRIBUTOR</td> <td>1</td> <td>PZ</td> </tr> <tr> <td>VM1605A0</td> <td>CLIP TWIST LOCK DIAM. 10,2-12,7 MM</td> <td>3</td> <td>PZ</td> </tr> <tr> <td>VM2172A0</td> <td>PUMP-WITH-CI RCUIT LOCKING PIN</td> <td>9</td> <td>PZ</td> </tr> </tbody> </table>	Code	Description	Qty	UOM	VL1167A0		1	PZ	VL1167A1		1	PZ	VL1167A2	GN21 3 ROTOR ARMS B-B FLOW RESTRICTOR	1	PZ	VL1174C0	D1.2 MM CALIBRATED NOZZLE	1	PZ	VL1185A0	2 WAYS PLUS WASHING DISTRIBUTOR	1	PZ	VL1186A0	3 WAYS PLUS WASHING DISTRIBUTOR	1	PZ	VL1190A0	PLUS WASHING SYSTEM INLET DISTRIBUTOR	1	PZ	VM1605A0	CLIP TWIST LOCK DIAM. 10,2-12,7 MM	3	PZ	VM2172A0	PUMP-WITH-CI RCUIT LOCKING PIN	9	PZ					
			Code	Description	Qty	UOM																																												
VL1167A0		1	PZ																																															
VL1167A1		1	PZ																																															
VL1167A2	GN21 3 ROTOR ARMS B-B FLOW RESTRICTOR	1	PZ																																															
VL1174C0	D1.2 MM CALIBRATED NOZZLE	1	PZ																																															
VL1185A0	2 WAYS PLUS WASHING DISTRIBUTOR	1	PZ																																															
VL1186A0	3 WAYS PLUS WASHING DISTRIBUTOR	1	PZ																																															
VL1190A0	PLUS WASHING SYSTEM INLET DISTRIBUTOR	1	PZ																																															
VM1605A0	CLIP TWIST LOCK DIAM. 10,2-12,7 MM	3	PZ																																															
VM2172A0	PUMP-WITH-CI RCUIT LOCKING PIN	9	PZ																																															
KVL1184A	2 ROTOR ARMS PLUS EU CLEANING SYSTEM KIT	<table border="1"> <thead> <tr> <th>Code</th> <th>Description</th> <th>Qty</th> <th>UOM</th> </tr> </thead> <tbody> <tr> <td>0H2143A0</td> <td>LAMIERA BLOCCA VNR VL1128</td> <td>2</td> <td>PZ</td> </tr> <tr> <td>0H2168A0</td> <td></td> <td>1</td> <td>PZ</td> </tr> <tr> <td>0H2354A0</td> <td>XEVC-XEVL WASHING CIRCUIT PLAT</td> <td>1</td> <td>PZ</td> </tr> <tr> <td>EL1220A0</td> <td>JG STRAIGHT CONNECTION Ø8F-Ø8F</td> <td>3</td> <td>PZ</td> </tr> <tr> <td>EL1440A0</td> <td>WATER SELF CLEANING VALVE</td> <td>4</td> <td>PZ</td> </tr> <tr> <td>GN1526A0</td> <td>INT. D.=6.9 TH=1.8 O-RIN</td> <td>9</td> <td>PZ</td> </tr> <tr> <td>RC1018A0</td> <td>ZINC PLATED D12 ELASTIC CLAMP</td> <td>2</td> <td>PZ</td> </tr> <tr> <td>RC1019A0</td> <td>D=10 ELASTIC CLAMP</td> <td>21</td> <td>PZ</td> </tr> <tr> <td>RC1130A0</td> <td>130X2,6 CLAM</td> <td>7</td> <td>PZ</td> </tr> <tr> <td>RC1131A0</td> <td>200X2,6 BLACK CLAMP</td> <td>3</td> <td>PZ</td> </tr> <tr> <td>RC1242A0</td> <td>D=10 CLOSED CAP</td> <td>2</td> <td>PZ</td> </tr> </tbody> </table>	Code	Description	Qty	UOM	0H2143A0	LAMIERA BLOCCA VNR VL1128	2	PZ	0H2168A0		1	PZ	0H2354A0	XEVC-XEVL WASHING CIRCUIT PLAT	1	PZ	EL1220A0	JG STRAIGHT CONNECTION Ø8F-Ø8F	3	PZ	EL1440A0	WATER SELF CLEANING VALVE	4	PZ	GN1526A0	INT. D.=6.9 TH=1.8 O-RIN	9	PZ	RC1018A0	ZINC PLATED D12 ELASTIC CLAMP	2	PZ	RC1019A0	D=10 ELASTIC CLAMP	21	PZ	RC1130A0	130X2,6 CLAM	7	PZ	RC1131A0	200X2,6 BLACK CLAMP	3	PZ	RC1242A0	D=10 CLOSED CAP	2	PZ
Code	Description	Qty	UOM																																															
0H2143A0	LAMIERA BLOCCA VNR VL1128	2	PZ																																															
0H2168A0		1	PZ																																															
0H2354A0	XEVC-XEVL WASHING CIRCUIT PLAT	1	PZ																																															
EL1220A0	JG STRAIGHT CONNECTION Ø8F-Ø8F	3	PZ																																															
EL1440A0	WATER SELF CLEANING VALVE	4	PZ																																															
GN1526A0	INT. D.=6.9 TH=1.8 O-RIN	9	PZ																																															
RC1018A0	ZINC PLATED D12 ELASTIC CLAMP	2	PZ																																															
RC1019A0	D=10 ELASTIC CLAMP	21	PZ																																															
RC1130A0	130X2,6 CLAM	7	PZ																																															
RC1131A0	200X2,6 BLACK CLAMP	3	PZ																																															
RC1242A0	D=10 CLOSED CAP	2	PZ																																															



COMPONENT			SPARE PART																																																																										
Code	Description	Image	Code	Description	Components list																																																																								
VL1165A	BB6-AR6 STRAIGHT FITTING		KVL1184A	2 ROTOR ARMS PLUS EU CLEANING SYSTEM KIT	<table border="1"> <thead> <tr> <th>Code</th> <th>Description</th> <th>Qty</th> <th>UOM</th> </tr> </thead> <tbody> <tr> <td>RC1356A0</td> <td>"STRAIGHT THREADED FEMALE END 8X1/4" BS</td> <td>1</td> <td>PZ</td> </tr> <tr> <td>TB2820A0</td> <td>6X10 EPDM PIPE FOR WASHING SYSTEM</td> <td>2.400</td> <td>M</td> </tr> <tr> <td>TB3132A0</td> <td>WHITE-BLUE EPDM TEXTILE BRAID HOSE 6X12</td> <td>1.220</td> <td>M</td> </tr> <tr> <td>VL1019A0</td> <td>VIBRATION PUMP</td> <td>1</td> <td>PZ</td> </tr> <tr> <td>VL1046A1</td> <td>D6 PIPE HOLDER - D6 J.G. TERMINAL</td> <td>3</td> <td>PZ</td> </tr> <tr> <td>VL1047A1</td> <td>D6 PIPE HOLDER - D8 J.G. TERMINAL</td> <td>1</td> <td>PZ</td> </tr> <tr> <td>VL1065A1</td> <td>1/4 MALE N.O. PRESSURE SWITCH</td> <td>1</td> <td>PZ</td> </tr> <tr> <td>VL1067A0</td> <td>WASHING SYSTEM INLETS DISTRIBUTOR</td> <td>1</td> <td>PZ</td> </tr> <tr> <td>VL1092A0</td> <td>WASHING SYSTEM OUTLET DOUBLE DISTRIBUTOR</td> <td>1</td> <td>PZ</td> </tr> <tr> <td>VL1102A1</td> <td>DETERGENT LINE FILTER + BARBED VNR 6 MM</td> <td>1</td> <td>PZ</td> </tr> <tr> <td>VL1128A0</td> <td>D6 BARBED CHECK VALVE</td> <td>2</td> <td>PZ</td> </tr> <tr> <td>VL1128A1</td> <td>D6 BARBED CHECK VALVE</td> <td>2</td> <td>PZ</td> </tr> <tr> <td>VL1141A1</td> <td>STRAIGHT CONNECT BB6-BB6</td> <td>1</td> <td>PZ</td> </tr> <tr> <td>VL1165A0</td> <td>BB6-AR6 STRAIGHT FITTING</td> <td>4</td> <td>PZ</td> </tr> <tr> <td>VL1166A0</td> <td>BB6-AR6 L FITTING</td> <td>4</td> <td>PZ</td> </tr> <tr> <td>VL1174C0</td> <td>D1.2 MM CALIBRATED NOZZLE</td> <td>1</td> <td>PZ</td> </tr> <tr> <td>VL1186A0</td> <td>3 WAYS PLUS WASHING DISTRIBUTOR</td> <td>1</td> <td>PZ</td> </tr> </tbody> </table>	Code	Description	Qty	UOM	RC1356A0	"STRAIGHT THREADED FEMALE END 8X1/4" BS	1	PZ	TB2820A0	6X10 EPDM PIPE FOR WASHING SYSTEM	2.400	M	TB3132A0	WHITE-BLUE EPDM TEXTILE BRAID HOSE 6X12	1.220	M	VL1019A0	VIBRATION PUMP	1	PZ	VL1046A1	D6 PIPE HOLDER - D6 J.G. TERMINAL	3	PZ	VL1047A1	D6 PIPE HOLDER - D8 J.G. TERMINAL	1	PZ	VL1065A1	1/4 MALE N.O. PRESSURE SWITCH	1	PZ	VL1067A0	WASHING SYSTEM INLETS DISTRIBUTOR	1	PZ	VL1092A0	WASHING SYSTEM OUTLET DOUBLE DISTRIBUTOR	1	PZ	VL1102A1	DETERGENT LINE FILTER + BARBED VNR 6 MM	1	PZ	VL1128A0	D6 BARBED CHECK VALVE	2	PZ	VL1128A1	D6 BARBED CHECK VALVE	2	PZ	VL1141A1	STRAIGHT CONNECT BB6-BB6	1	PZ	VL1165A0	BB6-AR6 STRAIGHT FITTING	4	PZ	VL1166A0	BB6-AR6 L FITTING	4	PZ	VL1174C0	D1.2 MM CALIBRATED NOZZLE	1	PZ	VL1186A0	3 WAYS PLUS WASHING DISTRIBUTOR	1	PZ
Code	Description	Qty	UOM																																																																										
RC1356A0	"STRAIGHT THREADED FEMALE END 8X1/4" BS	1	PZ																																																																										
TB2820A0	6X10 EPDM PIPE FOR WASHING SYSTEM	2.400	M																																																																										
TB3132A0	WHITE-BLUE EPDM TEXTILE BRAID HOSE 6X12	1.220	M																																																																										
VL1019A0	VIBRATION PUMP	1	PZ																																																																										
VL1046A1	D6 PIPE HOLDER - D6 J.G. TERMINAL	3	PZ																																																																										
VL1047A1	D6 PIPE HOLDER - D8 J.G. TERMINAL	1	PZ																																																																										
VL1065A1	1/4 MALE N.O. PRESSURE SWITCH	1	PZ																																																																										
VL1067A0	WASHING SYSTEM INLETS DISTRIBUTOR	1	PZ																																																																										
VL1092A0	WASHING SYSTEM OUTLET DOUBLE DISTRIBUTOR	1	PZ																																																																										
VL1102A1	DETERGENT LINE FILTER + BARBED VNR 6 MM	1	PZ																																																																										
VL1128A0	D6 BARBED CHECK VALVE	2	PZ																																																																										
VL1128A1	D6 BARBED CHECK VALVE	2	PZ																																																																										
VL1141A1	STRAIGHT CONNECT BB6-BB6	1	PZ																																																																										
VL1165A0	BB6-AR6 STRAIGHT FITTING	4	PZ																																																																										
VL1166A0	BB6-AR6 L FITTING	4	PZ																																																																										
VL1174C0	D1.2 MM CALIBRATED NOZZLE	1	PZ																																																																										
VL1186A0	3 WAYS PLUS WASHING DISTRIBUTOR	1	PZ																																																																										

COMPONENT			SPARE PART																																																																						
Code	Description	Image	Code	Description	Components list																																																																				
VL1165A	BB6-AR6 STRAIGHT FITTING		KVL1184A	2 ROTOR ARMS PLUS EU CLEANING SYSTEM KIT	<table border="1"> <thead> <tr> <th>Code</th> <th>Description</th> <th>Qty</th> <th>UOM</th> </tr> </thead> <tbody> <tr> <td>VL1190A0</td> <td>PLUS WASHING SYSTEM INLET DISTRIBUTOR</td> <td>1</td> <td>PZ</td> </tr> <tr> <td>VM1605A0</td> <td>CLIP TWIST LOCK DIAM. 10,2-12,7 MM</td> <td>4</td> <td>PZ</td> </tr> <tr> <td>VM2172A0</td> <td>PUMP-WITH-CI RCUIT LOCKING PIN</td> <td>9</td> <td>PZ</td> </tr> </tbody> </table>	Code	Description	Qty	UOM	VL1190A0	PLUS WASHING SYSTEM INLET DISTRIBUTOR	1	PZ	VM1605A0	CLIP TWIST LOCK DIAM. 10,2-12,7 MM	4	PZ	VM2172A0	PUMP-WITH-CI RCUIT LOCKING PIN	9	PZ																																																				
Code	Description	Qty	UOM																																																																						
VL1190A0	PLUS WASHING SYSTEM INLET DISTRIBUTOR	1	PZ																																																																						
VM1605A0	CLIP TWIST LOCK DIAM. 10,2-12,7 MM	4	PZ																																																																						
VM2172A0	PUMP-WITH-CI RCUIT LOCKING PIN	9	PZ																																																																						
			KVL1183A	1 ROTOR ARM PLUS CLEANING SYSTEM KIT	<table border="1"> <thead> <tr> <th>Code</th> <th>Description</th> <th>Qty</th> <th>UOM</th> </tr> </thead> <tbody> <tr> <td>0H2143A0</td> <td>LAMIERA BLOCCA VNR VL1128</td> <td>2</td> <td>PZ</td> </tr> <tr> <td>0H2168A1</td> <td></td> <td>1</td> <td>PZ</td> </tr> <tr> <td>0H2354A0</td> <td>XEVC-XEVL WASHING CIRCUIT PLAT</td> <td>1</td> <td>PZ</td> </tr> <tr> <td>EL1440A0</td> <td>WATER SELF CLEANING VALVE</td> <td>3</td> <td>PZ</td> </tr> <tr> <td>GN1526A0</td> <td>INT. D.=6.9 TH=1.8 O-RIN</td> <td>7</td> <td>PZ</td> </tr> <tr> <td>RC1018A0</td> <td>ZINC PLATED D12 ELASTIC CLAMP</td> <td>2</td> <td>PZ</td> </tr> <tr> <td>RC1019A0</td> <td>D=10 ELASTIC CLAMP</td> <td>14</td> <td>PZ</td> </tr> <tr> <td>RC1130A0</td> <td>130X2,6 CLAM</td> <td>5</td> <td>PZ</td> </tr> <tr> <td>RC1131A0</td> <td>200X2.6 BLACK CLAMP</td> <td>2</td> <td>PZ</td> </tr> <tr> <td>RC1242A0</td> <td>D=10 CLOSED CAP</td> <td>2</td> <td>PZ</td> </tr> <tr> <td>RC1356A0</td> <td>"STRAIGHT THREADED FEMALE END 8X1/4" BS</td> <td>1</td> <td>PZ</td> </tr> <tr> <td>TB2820A0</td> <td>6X10 EPDM PIPE FOR WASHING SYSTEM</td> <td>1.410</td> <td>M</td> </tr> <tr> <td>TB3132A0</td> <td>WHITE-BLUE EPDM TEXTILE BRAID HOSE 6X12</td> <td>0.770</td> <td>M</td> </tr> <tr> <td>VI1220A1</td> <td>4,2X12 TCB SELF-TAPPIN G SCREW</td> <td>3</td> <td>PZ</td> </tr> <tr> <td>VL1019A0</td> <td>VIBRATION PUMP</td> <td>1</td> <td>PZ</td> </tr> <tr> <td>VL1047A1</td> <td>D6 PIPE HOLDER - D8 J.G. TERMINAL</td> <td>1</td> <td>PZ</td> </tr> </tbody> </table>	Code	Description	Qty	UOM	0H2143A0	LAMIERA BLOCCA VNR VL1128	2	PZ	0H2168A1		1	PZ	0H2354A0	XEVC-XEVL WASHING CIRCUIT PLAT	1	PZ	EL1440A0	WATER SELF CLEANING VALVE	3	PZ	GN1526A0	INT. D.=6.9 TH=1.8 O-RIN	7	PZ	RC1018A0	ZINC PLATED D12 ELASTIC CLAMP	2	PZ	RC1019A0	D=10 ELASTIC CLAMP	14	PZ	RC1130A0	130X2,6 CLAM	5	PZ	RC1131A0	200X2.6 BLACK CLAMP	2	PZ	RC1242A0	D=10 CLOSED CAP	2	PZ	RC1356A0	"STRAIGHT THREADED FEMALE END 8X1/4" BS	1	PZ	TB2820A0	6X10 EPDM PIPE FOR WASHING SYSTEM	1.410	M	TB3132A0	WHITE-BLUE EPDM TEXTILE BRAID HOSE 6X12	0.770	M	VI1220A1	4,2X12 TCB SELF-TAPPIN G SCREW	3	PZ	VL1019A0	VIBRATION PUMP	1	PZ	VL1047A1	D6 PIPE HOLDER - D8 J.G. TERMINAL	1	PZ
Code	Description	Qty	UOM																																																																						
0H2143A0	LAMIERA BLOCCA VNR VL1128	2	PZ																																																																						
0H2168A1		1	PZ																																																																						
0H2354A0	XEVC-XEVL WASHING CIRCUIT PLAT	1	PZ																																																																						
EL1440A0	WATER SELF CLEANING VALVE	3	PZ																																																																						
GN1526A0	INT. D.=6.9 TH=1.8 O-RIN	7	PZ																																																																						
RC1018A0	ZINC PLATED D12 ELASTIC CLAMP	2	PZ																																																																						
RC1019A0	D=10 ELASTIC CLAMP	14	PZ																																																																						
RC1130A0	130X2,6 CLAM	5	PZ																																																																						
RC1131A0	200X2.6 BLACK CLAMP	2	PZ																																																																						
RC1242A0	D=10 CLOSED CAP	2	PZ																																																																						
RC1356A0	"STRAIGHT THREADED FEMALE END 8X1/4" BS	1	PZ																																																																						
TB2820A0	6X10 EPDM PIPE FOR WASHING SYSTEM	1.410	M																																																																						
TB3132A0	WHITE-BLUE EPDM TEXTILE BRAID HOSE 6X12	0.770	M																																																																						
VI1220A1	4,2X12 TCB SELF-TAPPIN G SCREW	3	PZ																																																																						
VL1019A0	VIBRATION PUMP	1	PZ																																																																						
VL1047A1	D6 PIPE HOLDER - D8 J.G. TERMINAL	1	PZ																																																																						

COMPONENT			SPARE PART																																																		
Code	Description	Image	Code	Description	Components list																																																
VL1165A	BB6-AR6 STRAIGHT FITTING		KVL1183A	1 ROTOR ARM PLUS CLEANING SYSTEM KIT	<table border="1"> <thead> <tr> <th>Code</th> <th>Description</th> <th>Qty</th> <th>UOM</th> </tr> </thead> <tbody> <tr> <td>VL1065A1</td> <td>1/4 MALE N.O. PRESSURE SWITCH</td> <td>1</td> <td>PZ</td> </tr> <tr> <td>VL1102A1</td> <td>DETERGENT LINE FILTER + BARBED VNR 6 MM</td> <td>1</td> <td>PZ</td> </tr> <tr> <td>VL1128A0</td> <td>D6 BARBED CHECK VALVE</td> <td>2</td> <td>PZ</td> </tr> <tr> <td>VL1128A1</td> <td>D6 BARBED CHECK VALVE</td> <td>2</td> <td>PZ</td> </tr> <tr> <td>VL1165A0</td> <td>BB6-AR6 STRAIGHT FITTING</td> <td>1</td> <td>PZ</td> </tr> <tr> <td>VL1166A0</td> <td>BB6-AR6 L FITTING</td> <td>3</td> <td>PZ</td> </tr> <tr> <td>VL1174C0</td> <td>D1.2 MM CALIBRATED NOZZLE</td> <td>1</td> <td>PZ</td> </tr> <tr> <td>VL1185A0</td> <td>2 WAYS PLUS WASHING DISTRIBUTOR</td> <td>1</td> <td>PZ</td> </tr> <tr> <td>VL1190A0</td> <td>PLUS WASHING SYSTEM INLET DISTRIBUTOR</td> <td>1</td> <td>PZ</td> </tr> <tr> <td>VM1605A0</td> <td>CLIP TWIST LOCK DIAM. 10,2-12,7 MM</td> <td>3</td> <td>PZ</td> </tr> <tr> <td>VM2172A0</td> <td>PUMP-WITH-CI RCUIT LOCKING PIN</td> <td>7</td> <td>PZ</td> </tr> </tbody> </table>	Code	Description	Qty	UOM	VL1065A1	1/4 MALE N.O. PRESSURE SWITCH	1	PZ	VL1102A1	DETERGENT LINE FILTER + BARBED VNR 6 MM	1	PZ	VL1128A0	D6 BARBED CHECK VALVE	2	PZ	VL1128A1	D6 BARBED CHECK VALVE	2	PZ	VL1165A0	BB6-AR6 STRAIGHT FITTING	1	PZ	VL1166A0	BB6-AR6 L FITTING	3	PZ	VL1174C0	D1.2 MM CALIBRATED NOZZLE	1	PZ	VL1185A0	2 WAYS PLUS WASHING DISTRIBUTOR	1	PZ	VL1190A0	PLUS WASHING SYSTEM INLET DISTRIBUTOR	1	PZ	VM1605A0	CLIP TWIST LOCK DIAM. 10,2-12,7 MM	3	PZ	VM2172A0	PUMP-WITH-CI RCUIT LOCKING PIN	7	PZ
			Code	Description	Qty	UOM																																															
VL1065A1	1/4 MALE N.O. PRESSURE SWITCH	1	PZ																																																		
VL1102A1	DETERGENT LINE FILTER + BARBED VNR 6 MM	1	PZ																																																		
VL1128A0	D6 BARBED CHECK VALVE	2	PZ																																																		
VL1128A1	D6 BARBED CHECK VALVE	2	PZ																																																		
VL1165A0	BB6-AR6 STRAIGHT FITTING	1	PZ																																																		
VL1166A0	BB6-AR6 L FITTING	3	PZ																																																		
VL1174C0	D1.2 MM CALIBRATED NOZZLE	1	PZ																																																		
VL1185A0	2 WAYS PLUS WASHING DISTRIBUTOR	1	PZ																																																		
VL1190A0	PLUS WASHING SYSTEM INLET DISTRIBUTOR	1	PZ																																																		
VM1605A0	CLIP TWIST LOCK DIAM. 10,2-12,7 MM	3	PZ																																																		
VM2172A0	PUMP-WITH-CI RCUIT LOCKING PIN	7	PZ																																																		
KVL1182A	ONE CLEANING SYSTEM KIT (0311 EXC.)	<table border="1"> <thead> <tr> <th>Code</th> <th>Description</th> <th>Qty</th> <th>UOM</th> </tr> </thead> <tbody> <tr> <td>0H2143A0</td> <td>LAMIERA BLOCCA VNR VL1128</td> <td>2</td> <td>PZ</td> </tr> <tr> <td>0H2202A1</td> <td>ONE WASHING WITH STEAM VALVE SUPPORT</td> <td>1</td> <td>PZ</td> </tr> <tr> <td>EL1440A0</td> <td>WATER SELF CLEANING VALVE</td> <td>1</td> <td>PZ</td> </tr> <tr> <td>GN1526A0</td> <td>INT. D.=6.9 TH=1.8 O-RIN</td> <td>3</td> <td>PZ</td> </tr> <tr> <td>RC1018A0</td> <td>ZINC PLATED D12 ELASTIC CLAMP</td> <td>1</td> <td>PZ</td> </tr> <tr> <td>RC1019A0</td> <td>D=10 ELASTIC CLAMP</td> <td>14</td> <td>PZ</td> </tr> <tr> <td>RC1130A0</td> <td>130X2,6 CLAM</td> <td>2</td> <td>PZ</td> </tr> </tbody> </table>	Code	Description	Qty	UOM	0H2143A0	LAMIERA BLOCCA VNR VL1128	2	PZ	0H2202A1	ONE WASHING WITH STEAM VALVE SUPPORT	1	PZ	EL1440A0	WATER SELF CLEANING VALVE	1	PZ	GN1526A0	INT. D.=6.9 TH=1.8 O-RIN	3	PZ	RC1018A0	ZINC PLATED D12 ELASTIC CLAMP	1	PZ	RC1019A0	D=10 ELASTIC CLAMP	14	PZ	RC1130A0	130X2,6 CLAM	2	PZ																			
Code	Description	Qty	UOM																																																		
0H2143A0	LAMIERA BLOCCA VNR VL1128	2	PZ																																																		
0H2202A1	ONE WASHING WITH STEAM VALVE SUPPORT	1	PZ																																																		
EL1440A0	WATER SELF CLEANING VALVE	1	PZ																																																		
GN1526A0	INT. D.=6.9 TH=1.8 O-RIN	3	PZ																																																		
RC1018A0	ZINC PLATED D12 ELASTIC CLAMP	1	PZ																																																		
RC1019A0	D=10 ELASTIC CLAMP	14	PZ																																																		
RC1130A0	130X2,6 CLAM	2	PZ																																																		



COMPONENT			SPARE PART																																																																						
Code	Description	Image	Code	Description	Components list																																																																				
VL1165A	BB6-AR6 STRAIGHT FITTING		KVL1182A	ONE CLEANING SYSTEM KIT (0311 EXC.)	<table border="1"> <thead> <tr> <th>Code</th> <th>Description</th> <th>Qty</th> <th>UOM</th> </tr> </thead> <tbody> <tr> <td>RC1242A0</td> <td>D=10 CLOSED CAP</td> <td>2</td> <td>PZ</td> </tr> <tr> <td>TB2820A0</td> <td>6X10 EPDM PIPE FOR WASHING SYSTEM</td> <td>1.410</td> <td>M</td> </tr> <tr> <td>TB3132A0</td> <td>WHITE-BLUE EPDM TEXTILE BRAID HOSE 6X12</td> <td>0.670</td> <td>M</td> </tr> <tr> <td>VI1220A1</td> <td>4,2X12 TCB SELF-TAPPING SCREW</td> <td>1</td> <td>PZ</td> </tr> <tr> <td>VL1019A0</td> <td>VIBRATION PUMP</td> <td>1</td> <td>PZ</td> </tr> <tr> <td>VL1047A1</td> <td>D6 PIPE HOLDER - D8 J.G. TERMINAL</td> <td>1</td> <td>PZ</td> </tr> <tr> <td>VL1054B0</td> <td>ONE WASHING SYS INLET DISTRIBUTOR</td> <td>1</td> <td>PZ</td> </tr> <tr> <td>VL1102A1</td> <td>DETERGENT LINE FILTER + BARBED VNR 6 MM</td> <td>1</td> <td>PZ</td> </tr> <tr> <td>VL1128A0</td> <td>D6 BARBED CHECK VALVE</td> <td>2</td> <td>PZ</td> </tr> <tr> <td>VL1128A1</td> <td>D6 BARBED CHECK VALVE</td> <td>2</td> <td>PZ</td> </tr> <tr> <td>VL1165A0</td> <td>BB6-AR6 STRAIGHT FITTING</td> <td>1</td> <td>PZ</td> </tr> <tr> <td>VL1166A0</td> <td>BB6-AR6 L FITTING</td> <td>1</td> <td>PZ</td> </tr> <tr> <td>VL1174C0</td> <td>D1.2 MM CALIBRATED NOZZLE</td> <td>1</td> <td>PZ</td> </tr> <tr> <td>VL1191A0</td> <td>ONE WASHING DISTRIBUTOR OUTLETS KIT</td> <td>1</td> <td>PZ</td> </tr> <tr> <td>VM1605A0</td> <td>CLIP TWIST LOCK DIAM. 10,2-12,7 MM</td> <td>3</td> <td>PZ</td> </tr> <tr> <td>VM2172A0</td> <td>PUMP-WITH-CLIP LOCKING PIN</td> <td>2</td> <td>PZ</td> </tr> </tbody> </table>	Code	Description	Qty	UOM	RC1242A0	D=10 CLOSED CAP	2	PZ	TB2820A0	6X10 EPDM PIPE FOR WASHING SYSTEM	1.410	M	TB3132A0	WHITE-BLUE EPDM TEXTILE BRAID HOSE 6X12	0.670	M	VI1220A1	4,2X12 TCB SELF-TAPPING SCREW	1	PZ	VL1019A0	VIBRATION PUMP	1	PZ	VL1047A1	D6 PIPE HOLDER - D8 J.G. TERMINAL	1	PZ	VL1054B0	ONE WASHING SYS INLET DISTRIBUTOR	1	PZ	VL1102A1	DETERGENT LINE FILTER + BARBED VNR 6 MM	1	PZ	VL1128A0	D6 BARBED CHECK VALVE	2	PZ	VL1128A1	D6 BARBED CHECK VALVE	2	PZ	VL1165A0	BB6-AR6 STRAIGHT FITTING	1	PZ	VL1166A0	BB6-AR6 L FITTING	1	PZ	VL1174C0	D1.2 MM CALIBRATED NOZZLE	1	PZ	VL1191A0	ONE WASHING DISTRIBUTOR OUTLETS KIT	1	PZ	VM1605A0	CLIP TWIST LOCK DIAM. 10,2-12,7 MM	3	PZ	VM2172A0	PUMP-WITH-CLIP LOCKING PIN	2	PZ
Code	Description	Qty	UOM																																																																						
RC1242A0	D=10 CLOSED CAP	2	PZ																																																																						
TB2820A0	6X10 EPDM PIPE FOR WASHING SYSTEM	1.410	M																																																																						
TB3132A0	WHITE-BLUE EPDM TEXTILE BRAID HOSE 6X12	0.670	M																																																																						
VI1220A1	4,2X12 TCB SELF-TAPPING SCREW	1	PZ																																																																						
VL1019A0	VIBRATION PUMP	1	PZ																																																																						
VL1047A1	D6 PIPE HOLDER - D8 J.G. TERMINAL	1	PZ																																																																						
VL1054B0	ONE WASHING SYS INLET DISTRIBUTOR	1	PZ																																																																						
VL1102A1	DETERGENT LINE FILTER + BARBED VNR 6 MM	1	PZ																																																																						
VL1128A0	D6 BARBED CHECK VALVE	2	PZ																																																																						
VL1128A1	D6 BARBED CHECK VALVE	2	PZ																																																																						
VL1165A0	BB6-AR6 STRAIGHT FITTING	1	PZ																																																																						
VL1166A0	BB6-AR6 L FITTING	1	PZ																																																																						
VL1174C0	D1.2 MM CALIBRATED NOZZLE	1	PZ																																																																						
VL1191A0	ONE WASHING DISTRIBUTOR OUTLETS KIT	1	PZ																																																																						
VM1605A0	CLIP TWIST LOCK DIAM. 10,2-12,7 MM	3	PZ																																																																						
VM2172A0	PUMP-WITH-CLIP LOCKING PIN	2	PZ																																																																						







COMPONENT			SPARE PART																																																																														
Code	Description	Image	Code	Description	Components list																																																																												
VL1166A	BB6-AR6 L FITTING		KVL2618A	2 ROTOR ARMS ONE CLEANING SYSTEM KIT	<table border="1"> <thead> <tr> <th>Code</th> <th>Description</th> <th>Qty</th> <th>UOM</th> </tr> </thead> <tbody> <tr> <td>0H2202A1</td> <td>ONE WASHING WITH STEAM VALVE SUPPORT</td> <td>2</td> <td>PZ</td> </tr> <tr> <td>CE1030A0</td> <td>FEMALE FASTON COVER 6.3X0.8 0,5-1MMQ</td> <td>4</td> <td>PZ</td> </tr> <tr> <td>CE1395A0</td> <td>6,3 X 0,8 IMALE FASTO</td> <td>2</td> <td>PZ</td> </tr> <tr> <td>CE1545A0</td> <td>BLUE UNIP AWG18 ST.3135 WIRE</td> <td>1</td> <td>M</td> </tr> <tr> <td>CE1570A0</td> <td>WHITE UNIP AWG18 ST.3135 WIRE</td> <td>1</td> <td>M</td> </tr> <tr> <td>CE1660A0</td> <td>6,3X0,8 FEMALE FASTON COVE</td> <td>4</td> <td>PZ</td> </tr> <tr> <td>CE1661A0</td> <td>MALE FASTON COVER 6,3X0,</td> <td>2</td> <td>PZ</td> </tr> <tr> <td>EL1020A1</td> <td>D8 INTERMEDIAT E T-SHAPED FITTING</td> <td>1</td> <td>PZ</td> </tr> <tr> <td>EL1440A0</td> <td>WATER SELF CLEANING VALVE</td> <td>2</td> <td>PZ</td> </tr> <tr> <td>GN1526A0</td> <td>INT. D.=6.9 TH=1.8 O-RIN</td> <td>6</td> <td>PZ</td> </tr> <tr> <td>IP1385A1</td> <td>CORNER POLYSTYREN E PACKING 110X80X2000</td> <td>0.500</td> <td>M</td> </tr> <tr> <td>RC1018A0</td> <td>ZINC PLATED D12 ELASTIC CLAMP</td> <td>4</td> <td>PZ</td> </tr> <tr> <td>RC1019A0</td> <td>D=10 ELASTIC CLAMP</td> <td>31</td> <td>PZ</td> </tr> <tr> <td>RC1130A0</td> <td>130X2,6 CLAM</td> <td>4</td> <td>PZ</td> </tr> <tr> <td>RC1242A0</td> <td>D=10 CLOSED CAP</td> <td>4</td> <td>PZ</td> </tr> <tr> <td>TB2820A0</td> <td>6X10 EPDM PIPE FOR WASHING SYSTEM</td> <td>2.920</td> <td>M</td> </tr> <tr> <td>TB3132A0</td> <td>WHITE-BLUE EPDM TEXTILE BRAID HOSE 6X12</td> <td>1.340</td> <td>M</td> </tr> <tr> <td>VI1220A1</td> <td>4,2X12 TCB SELF-TAPPIN G SCREW</td> <td>2</td> <td>PZ</td> </tr> </tbody> </table>	Code	Description	Qty	UOM	0H2202A1	ONE WASHING WITH STEAM VALVE SUPPORT	2	PZ	CE1030A0	FEMALE FASTON COVER 6.3X0.8 0,5-1MMQ	4	PZ	CE1395A0	6,3 X 0,8 IMALE FASTO	2	PZ	CE1545A0	BLUE UNIP AWG18 ST.3135 WIRE	1	M	CE1570A0	WHITE UNIP AWG18 ST.3135 WIRE	1	M	CE1660A0	6,3X0,8 FEMALE FASTON COVE	4	PZ	CE1661A0	MALE FASTON COVER 6,3X0,	2	PZ	EL1020A1	D8 INTERMEDIAT E T-SHAPED FITTING	1	PZ	EL1440A0	WATER SELF CLEANING VALVE	2	PZ	GN1526A0	INT. D.=6.9 TH=1.8 O-RIN	6	PZ	IP1385A1	CORNER POLYSTYREN E PACKING 110X80X2000	0.500	M	RC1018A0	ZINC PLATED D12 ELASTIC CLAMP	4	PZ	RC1019A0	D=10 ELASTIC CLAMP	31	PZ	RC1130A0	130X2,6 CLAM	4	PZ	RC1242A0	D=10 CLOSED CAP	4	PZ	TB2820A0	6X10 EPDM PIPE FOR WASHING SYSTEM	2.920	M	TB3132A0	WHITE-BLUE EPDM TEXTILE BRAID HOSE 6X12	1.340	M	VI1220A1	4,2X12 TCB SELF-TAPPIN G SCREW	2	PZ
Code	Description	Qty	UOM																																																																														
0H2202A1	ONE WASHING WITH STEAM VALVE SUPPORT	2	PZ																																																																														
CE1030A0	FEMALE FASTON COVER 6.3X0.8 0,5-1MMQ	4	PZ																																																																														
CE1395A0	6,3 X 0,8 IMALE FASTO	2	PZ																																																																														
CE1545A0	BLUE UNIP AWG18 ST.3135 WIRE	1	M																																																																														
CE1570A0	WHITE UNIP AWG18 ST.3135 WIRE	1	M																																																																														
CE1660A0	6,3X0,8 FEMALE FASTON COVE	4	PZ																																																																														
CE1661A0	MALE FASTON COVER 6,3X0,	2	PZ																																																																														
EL1020A1	D8 INTERMEDIAT E T-SHAPED FITTING	1	PZ																																																																														
EL1440A0	WATER SELF CLEANING VALVE	2	PZ																																																																														
GN1526A0	INT. D.=6.9 TH=1.8 O-RIN	6	PZ																																																																														
IP1385A1	CORNER POLYSTYREN E PACKING 110X80X2000	0.500	M																																																																														
RC1018A0	ZINC PLATED D12 ELASTIC CLAMP	4	PZ																																																																														
RC1019A0	D=10 ELASTIC CLAMP	31	PZ																																																																														
RC1130A0	130X2,6 CLAM	4	PZ																																																																														
RC1242A0	D=10 CLOSED CAP	4	PZ																																																																														
TB2820A0	6X10 EPDM PIPE FOR WASHING SYSTEM	2.920	M																																																																														
TB3132A0	WHITE-BLUE EPDM TEXTILE BRAID HOSE 6X12	1.340	M																																																																														
VI1220A1	4,2X12 TCB SELF-TAPPIN G SCREW	2	PZ																																																																														

COMPONENT			SPARE PART																																																		
Code	Description	Image	Code	Description	Components list																																																
VL1166A	BB6-AR6 L FITTING		KVL2618A	2 ROTOR ARMS ONE CLEANING SYSTEM KIT	<table border="1"> <thead> <tr> <th>Code</th> <th>Description</th> <th>Qty</th> <th>UOM</th> </tr> </thead> <tbody> <tr> <td>VL1019A0</td> <td>VIBRATION PUMP</td> <td>2</td> <td>PZ</td> </tr> <tr> <td>VL1047A1</td> <td>D6 PIPE HOLDER - D8 J.G. TERMINAL</td> <td>2</td> <td>PZ</td> </tr> <tr> <td>VL1054B0</td> <td>ONE WASHING SYS INLET DISTRIBUTOR</td> <td>2</td> <td>PZ</td> </tr> <tr> <td>VL1102A1</td> <td>DETERGENT LINE FILTER + BARBED VNR 6 MM</td> <td>2</td> <td>PZ</td> </tr> <tr> <td>VL1127A1</td> <td>6MM BARBED T-SHAPED FITTING</td> <td>1</td> <td>PZ</td> </tr> <tr> <td>VL1128A1</td> <td>D6 BARBED CHECK VALVE</td> <td>4</td> <td>PZ</td> </tr> <tr> <td>VL1165A0</td> <td>BB6-AR6 STRAIGHT FITTING</td> <td>2</td> <td>PZ</td> </tr> <tr> <td>VL1166A0</td> <td>BB6-AR6 L FITTING</td> <td>2</td> <td>PZ</td> </tr> <tr> <td>VL1174C0</td> <td>D1.2 MM CALIBRATED NOZZLE</td> <td>2</td> <td>PZ</td> </tr> <tr> <td>VL1191A0</td> <td>ONE WASHING DISTRIBUTOR OUTLETS KIT</td> <td>2</td> <td>PZ</td> </tr> <tr> <td>VM2172A0</td> <td>PUMP-WITH-CI RCUIT LOCKING PIN</td> <td>4</td> <td>PZ</td> </tr> </tbody> </table>	Code	Description	Qty	UOM	VL1019A0	VIBRATION PUMP	2	PZ	VL1047A1	D6 PIPE HOLDER - D8 J.G. TERMINAL	2	PZ	VL1054B0	ONE WASHING SYS INLET DISTRIBUTOR	2	PZ	VL1102A1	DETERGENT LINE FILTER + BARBED VNR 6 MM	2	PZ	VL1127A1	6MM BARBED T-SHAPED FITTING	1	PZ	VL1128A1	D6 BARBED CHECK VALVE	4	PZ	VL1165A0	BB6-AR6 STRAIGHT FITTING	2	PZ	VL1166A0	BB6-AR6 L FITTING	2	PZ	VL1174C0	D1.2 MM CALIBRATED NOZZLE	2	PZ	VL1191A0	ONE WASHING DISTRIBUTOR OUTLETS KIT	2	PZ	VM2172A0	PUMP-WITH-CI RCUIT LOCKING PIN	4	PZ
Code	Description	Qty	UOM																																																		
VL1019A0	VIBRATION PUMP	2	PZ																																																		
VL1047A1	D6 PIPE HOLDER - D8 J.G. TERMINAL	2	PZ																																																		
VL1054B0	ONE WASHING SYS INLET DISTRIBUTOR	2	PZ																																																		
VL1102A1	DETERGENT LINE FILTER + BARBED VNR 6 MM	2	PZ																																																		
VL1127A1	6MM BARBED T-SHAPED FITTING	1	PZ																																																		
VL1128A1	D6 BARBED CHECK VALVE	4	PZ																																																		
VL1165A0	BB6-AR6 STRAIGHT FITTING	2	PZ																																																		
VL1166A0	BB6-AR6 L FITTING	2	PZ																																																		
VL1174C0	D1.2 MM CALIBRATED NOZZLE	2	PZ																																																		
VL1191A0	ONE WASHING DISTRIBUTOR OUTLETS KIT	2	PZ																																																		
VM2172A0	PUMP-WITH-CI RCUIT LOCKING PIN	4	PZ																																																		
			KVL1225A	US HOOD WASHING SYSTEM KIT	<table border="1"> <thead> <tr> <th>Code</th> <th>Description</th> <th>Qty</th> <th>UOM</th> </tr> </thead> <tbody> <tr> <td>0H2213A1</td> <td></td> <td>1</td> <td>PZ</td> </tr> <tr> <td>EL1450A0</td> <td>US SELF-CLEANING WATER SOLENOID</td> <td>2</td> <td>PZ</td> </tr> <tr> <td>GN1526A0</td> <td>INT. D.=6.9 TH=1.8 O-RING</td> <td>5</td> <td>PZ</td> </tr> <tr> <td>RC1018A0</td> <td>ZINC PLATED D12 ELASTIC CLAMP</td> <td>5</td> <td>PZ</td> </tr> <tr> <td>RC1019A0</td> <td>D=10 ELASTIC CLAMP</td> <td>16</td> <td>PZ</td> </tr> <tr> <td>RC1131A0</td> <td>200X2.6 BLACK CLAMP</td> <td>1</td> <td>PZ</td> </tr> <tr> <td>RC1242A0</td> <td>D=10 CLOSED CAP</td> <td>2</td> <td>PZ</td> </tr> <tr> <td>TB2820A0</td> <td>6X10 EPDM PIPE FOR WASHING SYSTEM</td> <td>2.240</td> <td>M</td> </tr> </tbody> </table>	Code	Description	Qty	UOM	0H2213A1		1	PZ	EL1450A0	US SELF-CLEANING WATER SOLENOID	2	PZ	GN1526A0	INT. D.=6.9 TH=1.8 O-RING	5	PZ	RC1018A0	ZINC PLATED D12 ELASTIC CLAMP	5	PZ	RC1019A0	D=10 ELASTIC CLAMP	16	PZ	RC1131A0	200X2.6 BLACK CLAMP	1	PZ	RC1242A0	D=10 CLOSED CAP	2	PZ	TB2820A0	6X10 EPDM PIPE FOR WASHING SYSTEM	2.240	M												
Code	Description	Qty	UOM																																																		
0H2213A1		1	PZ																																																		
EL1450A0	US SELF-CLEANING WATER SOLENOID	2	PZ																																																		
GN1526A0	INT. D.=6.9 TH=1.8 O-RING	5	PZ																																																		
RC1018A0	ZINC PLATED D12 ELASTIC CLAMP	5	PZ																																																		
RC1019A0	D=10 ELASTIC CLAMP	16	PZ																																																		
RC1131A0	200X2.6 BLACK CLAMP	1	PZ																																																		
RC1242A0	D=10 CLOSED CAP	2	PZ																																																		
TB2820A0	6X10 EPDM PIPE FOR WASHING SYSTEM	2.240	M																																																		





COMPONENT			SPARE PART																																																														
Code	Description	Image	Code	Description	Components list																																																												
VL1166A	BB6-AR6 L FITTING		KVL1225A	US HOOD WASHING SYSTEM KIT	<table border="1"> <thead> <tr> <th>Code</th> <th>Description</th> <th>Qty</th> <th>UOM</th> </tr> </thead> <tbody> <tr> <td>TB3132A0</td> <td>WHITE-BLUE EPDM TEXTILE BRAID HOSE 6X12</td> <td>0.440</td> <td>M</td> </tr> <tr> <td>V11220A1</td> <td>4,2X12 TCB SELF-TAPPING SCREW</td> <td>3</td> <td>PZ</td> </tr> <tr> <td>VL1019A0</td> <td>VIBRATION PUMP</td> <td>1</td> <td>PZ</td> </tr> <tr> <td>VL1047A1</td> <td>D6 PIPE HOLDER - D8 J.G. TERMINAL</td> <td>1</td> <td>PZ</td> </tr> <tr> <td>VL1054B0</td> <td>ONE WASHING SYS INLET DISTRIBUTOR</td> <td>1</td> <td>PZ</td> </tr> <tr> <td>VL1102A1</td> <td>DETERGENT LINE FILTER + BARBED VNR 6 MM</td> <td>1</td> <td>PZ</td> </tr> <tr> <td>VL1127A1</td> <td>6MM BARBED T-SHAPED FITTING</td> <td>1</td> <td>PZ</td> </tr> <tr> <td>VL1128A1</td> <td>D6 BARBED CHECK VALVE</td> <td>2</td> <td>PZ</td> </tr> <tr> <td>VL1165A0</td> <td>BB6-AR6 STRAIGHT FITTING</td> <td>2</td> <td>PZ</td> </tr> <tr> <td>VL1166A0</td> <td>BB6-AR6 L FITTING</td> <td>2</td> <td>PZ</td> </tr> <tr> <td>VL1174C0</td> <td>D1.2 MM CALIBRATED NOZZLE</td> <td>1</td> <td>PZ</td> </tr> <tr> <td>VL1191A0</td> <td>ONE WASHING DISTRIBUTOR OUTLETS KIT</td> <td>1</td> <td>PZ</td> </tr> <tr> <td>VM1605A0</td> <td>CLIP TWIST LOCK DIAM. 10,2-12,7 MM</td> <td>2</td> <td>PZ</td> </tr> <tr> <td>VM2172A0</td> <td>PUMP-WITH-CIRCUIT LOCKING PIN</td> <td>5</td> <td>PZ</td> </tr> </tbody> </table>	Code	Description	Qty	UOM	TB3132A0	WHITE-BLUE EPDM TEXTILE BRAID HOSE 6X12	0.440	M	V11220A1	4,2X12 TCB SELF-TAPPING SCREW	3	PZ	VL1019A0	VIBRATION PUMP	1	PZ	VL1047A1	D6 PIPE HOLDER - D8 J.G. TERMINAL	1	PZ	VL1054B0	ONE WASHING SYS INLET DISTRIBUTOR	1	PZ	VL1102A1	DETERGENT LINE FILTER + BARBED VNR 6 MM	1	PZ	VL1127A1	6MM BARBED T-SHAPED FITTING	1	PZ	VL1128A1	D6 BARBED CHECK VALVE	2	PZ	VL1165A0	BB6-AR6 STRAIGHT FITTING	2	PZ	VL1166A0	BB6-AR6 L FITTING	2	PZ	VL1174C0	D1.2 MM CALIBRATED NOZZLE	1	PZ	VL1191A0	ONE WASHING DISTRIBUTOR OUTLETS KIT	1	PZ	VM1605A0	CLIP TWIST LOCK DIAM. 10,2-12,7 MM	2	PZ	VM2172A0	PUMP-WITH-CIRCUIT LOCKING PIN	5	PZ
Code	Description	Qty	UOM																																																														
TB3132A0	WHITE-BLUE EPDM TEXTILE BRAID HOSE 6X12	0.440	M																																																														
V11220A1	4,2X12 TCB SELF-TAPPING SCREW	3	PZ																																																														
VL1019A0	VIBRATION PUMP	1	PZ																																																														
VL1047A1	D6 PIPE HOLDER - D8 J.G. TERMINAL	1	PZ																																																														
VL1054B0	ONE WASHING SYS INLET DISTRIBUTOR	1	PZ																																																														
VL1102A1	DETERGENT LINE FILTER + BARBED VNR 6 MM	1	PZ																																																														
VL1127A1	6MM BARBED T-SHAPED FITTING	1	PZ																																																														
VL1128A1	D6 BARBED CHECK VALVE	2	PZ																																																														
VL1165A0	BB6-AR6 STRAIGHT FITTING	2	PZ																																																														
VL1166A0	BB6-AR6 L FITTING	2	PZ																																																														
VL1174C0	D1.2 MM CALIBRATED NOZZLE	1	PZ																																																														
VL1191A0	ONE WASHING DISTRIBUTOR OUTLETS KIT	1	PZ																																																														
VM1605A0	CLIP TWIST LOCK DIAM. 10,2-12,7 MM	2	PZ																																																														
VM2172A0	PUMP-WITH-CIRCUIT LOCKING PIN	5	PZ																																																														
			KVL1222A	EUR 0311 ONE PLUS CLEANING SYSTEM KIT	<table border="1"> <thead> <tr> <th>Code</th> <th>Description</th> <th>Qty</th> <th>UOM</th> </tr> </thead> <tbody> <tr> <td>0H2486A0</td> <td></td> <td>1</td> <td>PZ</td> </tr> <tr> <td>EL1440A0</td> <td>WATER SELF CLEANING VALVE</td> <td>1</td> <td>PZ</td> </tr> <tr> <td>GN1526A0</td> <td>INT. D.=6.9 TH=1.8 O-RING</td> <td>3</td> <td>PZ</td> </tr> <tr> <td>RC1018A0</td> <td>ZINC PLATED D12 ELASTIC CLAMP</td> <td>2</td> <td>PZ</td> </tr> </tbody> </table>	Code	Description	Qty	UOM	0H2486A0		1	PZ	EL1440A0	WATER SELF CLEANING VALVE	1	PZ	GN1526A0	INT. D.=6.9 TH=1.8 O-RING	3	PZ	RC1018A0	ZINC PLATED D12 ELASTIC CLAMP	2	PZ																																								
Code	Description	Qty	UOM																																																														
0H2486A0		1	PZ																																																														
EL1440A0	WATER SELF CLEANING VALVE	1	PZ																																																														
GN1526A0	INT. D.=6.9 TH=1.8 O-RING	3	PZ																																																														
RC1018A0	ZINC PLATED D12 ELASTIC CLAMP	2	PZ																																																														



COMPONENT			SPARE PART																																																																																	
Code	Description	Image	Code	Description	Components list																																																																															
VL1166A	BB6-AR6 L FITTING		KVL1222A	EUR 0311 ONE PLUS CLEANING SYSTEM KIT	<table border="1"> <thead> <tr> <th>Code</th> <th>Description</th> <th>Qty</th> <th>UOM</th> </tr> </thead> <tbody> <tr> <td>RC1019A0</td> <td>D=10 ELASTIC CLAMP</td> <td>14</td> <td>PZ</td> </tr> <tr> <td>RC1242A0</td> <td>D=10 CLOSED CAP</td> <td>2</td> <td>PZ</td> </tr> <tr> <td>TB2820A0</td> <td>6X10 EPDM PIPE FOR WASHING SYSTEM</td> <td>1.460</td> <td>M</td> </tr> <tr> <td>TB3132A0</td> <td>WHITE-BLUE EPDM TEXTILE BRAID HOSE 6X12</td> <td>0.670</td> <td>M</td> </tr> <tr> <td>VI1220A1</td> <td>4,2X12 TCB SELF-TAPPIN G SCREW</td> <td>4</td> <td>PZ</td> </tr> <tr> <td>VL1019A0</td> <td>VIBRATION PUMP</td> <td>1</td> <td>PZ</td> </tr> <tr> <td>VL1047A1</td> <td>D6 PIPE HOLDER - D8 J.G. TERMINAL</td> <td>1</td> <td>PZ</td> </tr> <tr> <td>VL1054B0</td> <td>ONE WASHING SYS INLET DISTRIBUTOR</td> <td>1</td> <td>PZ</td> </tr> <tr> <td>VL1102A1</td> <td>DETERGENT LINE FILTER + BARBED VNR 6 MM</td> <td>1</td> <td>PZ</td> </tr> <tr> <td>VL1128A1</td> <td>D6 BARBED CHECK VALVE</td> <td>2</td> <td>PZ</td> </tr> <tr> <td>VL1165A0</td> <td>BB6-AR6 STRAIGHT FITTING</td> <td>1</td> <td>PZ</td> </tr> <tr> <td>VL1166A0</td> <td>BB6-AR6 L FITTING</td> <td>1</td> <td>PZ</td> </tr> <tr> <td>VL1174C0</td> <td>D1.2 MM CALIBRATED NOZZLE</td> <td>1</td> <td>PZ</td> </tr> <tr> <td>VL1191A0</td> <td>ONE WASHING DISTRIBUTOR OUTLETS KIT</td> <td>1</td> <td>PZ</td> </tr> <tr> <td>VM2172A0</td> <td>PUMP-WITH-CI RCUIT LOCKING PIN</td> <td>3</td> <td>PZ</td> </tr> </tbody> </table>	Code	Description	Qty	UOM	RC1019A0	D=10 ELASTIC CLAMP	14	PZ	RC1242A0	D=10 CLOSED CAP	2	PZ	TB2820A0	6X10 EPDM PIPE FOR WASHING SYSTEM	1.460	M	TB3132A0	WHITE-BLUE EPDM TEXTILE BRAID HOSE 6X12	0.670	M	VI1220A1	4,2X12 TCB SELF-TAPPIN G SCREW	4	PZ	VL1019A0	VIBRATION PUMP	1	PZ	VL1047A1	D6 PIPE HOLDER - D8 J.G. TERMINAL	1	PZ	VL1054B0	ONE WASHING SYS INLET DISTRIBUTOR	1	PZ	VL1102A1	DETERGENT LINE FILTER + BARBED VNR 6 MM	1	PZ	VL1128A1	D6 BARBED CHECK VALVE	2	PZ	VL1165A0	BB6-AR6 STRAIGHT FITTING	1	PZ	VL1166A0	BB6-AR6 L FITTING	1	PZ	VL1174C0	D1.2 MM CALIBRATED NOZZLE	1	PZ	VL1191A0	ONE WASHING DISTRIBUTOR OUTLETS KIT	1	PZ	VM2172A0	PUMP-WITH-CI RCUIT LOCKING PIN	3	PZ	KVL1213A	US PLUS COMPACT WASHING SYSTEM KIT	<table border="1"> <thead> <tr> <th>Code</th> <th>Description</th> <th>Qty</th> <th>UOM</th> </tr> </thead> <tbody> <tr> <td>0H2428A0</td> <td>US</td> <td>1</td> <td>PZ</td> </tr> <tr> <td>EL1450A0</td> <td>SELF-CLEANIN G WATER SOLENOID</td> <td>3</td> <td>PZ</td> </tr> </tbody> </table>	Code	Description	Qty	UOM	0H2428A0	US	1	PZ	EL1450A0	SELF-CLEANIN G WATER SOLENOID	3	PZ
			Code	Description	Qty	UOM																																																																														
RC1019A0	D=10 ELASTIC CLAMP	14	PZ																																																																																	
RC1242A0	D=10 CLOSED CAP	2	PZ																																																																																	
TB2820A0	6X10 EPDM PIPE FOR WASHING SYSTEM	1.460	M																																																																																	
TB3132A0	WHITE-BLUE EPDM TEXTILE BRAID HOSE 6X12	0.670	M																																																																																	
VI1220A1	4,2X12 TCB SELF-TAPPIN G SCREW	4	PZ																																																																																	
VL1019A0	VIBRATION PUMP	1	PZ																																																																																	
VL1047A1	D6 PIPE HOLDER - D8 J.G. TERMINAL	1	PZ																																																																																	
VL1054B0	ONE WASHING SYS INLET DISTRIBUTOR	1	PZ																																																																																	
VL1102A1	DETERGENT LINE FILTER + BARBED VNR 6 MM	1	PZ																																																																																	
VL1128A1	D6 BARBED CHECK VALVE	2	PZ																																																																																	
VL1165A0	BB6-AR6 STRAIGHT FITTING	1	PZ																																																																																	
VL1166A0	BB6-AR6 L FITTING	1	PZ																																																																																	
VL1174C0	D1.2 MM CALIBRATED NOZZLE	1	PZ																																																																																	
VL1191A0	ONE WASHING DISTRIBUTOR OUTLETS KIT	1	PZ																																																																																	
VM2172A0	PUMP-WITH-CI RCUIT LOCKING PIN	3	PZ																																																																																	
Code	Description	Qty	UOM																																																																																	
0H2428A0	US	1	PZ																																																																																	
EL1450A0	SELF-CLEANIN G WATER SOLENOID	3	PZ																																																																																	

COMPONENT			SPARE PART																																																																																		
Code	Description	Image	Code	Description	Components list																																																																																
VL1166A	BB6-AR6 L FITTING		KVL1213A	US PLUS COMPACT WASHING SYSTEM KIT	<table border="1"> <thead> <tr> <th>Code</th> <th>Description</th> <th>Qty</th> <th>UOM</th> </tr> </thead> <tbody> <tr> <td>GN1312A0</td> <td>RUBBER CABLE-PASSI NG DE=26 DI=15 SP=10</td> <td>1</td> <td>PZ</td> </tr> <tr> <td>GN1526A0</td> <td>INT. D.=6.9 TH=1.8 O-RIN</td> <td>7</td> <td>PZ</td> </tr> <tr> <td>RC1018A0</td> <td>ZINC PLATED D12 ELASTIC CLAMP</td> <td>3</td> <td>PZ</td> </tr> <tr> <td>RC1019A0</td> <td>D=10 ELASTIC CLAMP</td> <td>14</td> <td>PZ</td> </tr> <tr> <td>RC1130A0</td> <td>130X2,6 CLAM</td> <td>1</td> <td>PZ</td> </tr> <tr> <td>RC1131A0</td> <td>200X2.6 BLACK CLAMP</td> <td>1</td> <td>PZ</td> </tr> <tr> <td>RC1242A0</td> <td>D=10 CLOSED CAP</td> <td>2</td> <td>PZ</td> </tr> <tr> <td>RC1356A0</td> <td>"STRAIGHT THREADED FEMALE END 8X1/4" BS</td> <td>1</td> <td>PZ</td> </tr> <tr> <td>TB2820A0</td> <td>6X10 EPDM PIPE FOR WASHING SYSTEM</td> <td>0.790</td> <td>M</td> </tr> <tr> <td>TB3132A0</td> <td>WHITE-BLUE EPDM TEXTILE BRAID HOSE 6X12</td> <td>1.400</td> <td>M</td> </tr> <tr> <td>VI1220A1</td> <td>4,2X12 TCB SELF-TAPPIN G SCREW</td> <td>3</td> <td>PZ</td> </tr> <tr> <td>VL1019A0</td> <td>VIBRATION PUMP</td> <td>1</td> <td>PZ</td> </tr> <tr> <td>VL1047A1</td> <td>D6 PIPE HOLDER - D8 J.G. TERMINAL</td> <td>1</td> <td>PZ</td> </tr> <tr> <td>VL1054B0</td> <td>ONE WASHING SYS INLET DISTRIBUTOR</td> <td>1</td> <td>PZ</td> </tr> <tr> <td>VL1065A1</td> <td>1/4 MALE N.O. PRESSURE SWITCH</td> <td>1</td> <td>PZ</td> </tr> <tr> <td>VL1102A1</td> <td>DETERGENT LINE FILTER + BARBED VNR 6 MM</td> <td>1</td> <td>PZ</td> </tr> <tr> <td>VL1128A1</td> <td>D6 BARBED CHECK VALVE</td> <td>2</td> <td>PZ</td> </tr> <tr> <td>VL1165A0</td> <td>BB6-AR6 STRAIGHT FITTING</td> <td>1</td> <td>PZ</td> </tr> <tr> <td>VL1166A0</td> <td>BB6-AR6 L FITTING</td> <td>3</td> <td>PZ</td> </tr> </tbody> </table>	Code	Description	Qty	UOM	GN1312A0	RUBBER CABLE-PASSI NG DE=26 DI=15 SP=10	1	PZ	GN1526A0	INT. D.=6.9 TH=1.8 O-RIN	7	PZ	RC1018A0	ZINC PLATED D12 ELASTIC CLAMP	3	PZ	RC1019A0	D=10 ELASTIC CLAMP	14	PZ	RC1130A0	130X2,6 CLAM	1	PZ	RC1131A0	200X2.6 BLACK CLAMP	1	PZ	RC1242A0	D=10 CLOSED CAP	2	PZ	RC1356A0	"STRAIGHT THREADED FEMALE END 8X1/4" BS	1	PZ	TB2820A0	6X10 EPDM PIPE FOR WASHING SYSTEM	0.790	M	TB3132A0	WHITE-BLUE EPDM TEXTILE BRAID HOSE 6X12	1.400	M	VI1220A1	4,2X12 TCB SELF-TAPPIN G SCREW	3	PZ	VL1019A0	VIBRATION PUMP	1	PZ	VL1047A1	D6 PIPE HOLDER - D8 J.G. TERMINAL	1	PZ	VL1054B0	ONE WASHING SYS INLET DISTRIBUTOR	1	PZ	VL1065A1	1/4 MALE N.O. PRESSURE SWITCH	1	PZ	VL1102A1	DETERGENT LINE FILTER + BARBED VNR 6 MM	1	PZ	VL1128A1	D6 BARBED CHECK VALVE	2	PZ	VL1165A0	BB6-AR6 STRAIGHT FITTING	1	PZ	VL1166A0	BB6-AR6 L FITTING	3	PZ
Code	Description	Qty	UOM																																																																																		
GN1312A0	RUBBER CABLE-PASSI NG DE=26 DI=15 SP=10	1	PZ																																																																																		
GN1526A0	INT. D.=6.9 TH=1.8 O-RIN	7	PZ																																																																																		
RC1018A0	ZINC PLATED D12 ELASTIC CLAMP	3	PZ																																																																																		
RC1019A0	D=10 ELASTIC CLAMP	14	PZ																																																																																		
RC1130A0	130X2,6 CLAM	1	PZ																																																																																		
RC1131A0	200X2.6 BLACK CLAMP	1	PZ																																																																																		
RC1242A0	D=10 CLOSED CAP	2	PZ																																																																																		
RC1356A0	"STRAIGHT THREADED FEMALE END 8X1/4" BS	1	PZ																																																																																		
TB2820A0	6X10 EPDM PIPE FOR WASHING SYSTEM	0.790	M																																																																																		
TB3132A0	WHITE-BLUE EPDM TEXTILE BRAID HOSE 6X12	1.400	M																																																																																		
VI1220A1	4,2X12 TCB SELF-TAPPIN G SCREW	3	PZ																																																																																		
VL1019A0	VIBRATION PUMP	1	PZ																																																																																		
VL1047A1	D6 PIPE HOLDER - D8 J.G. TERMINAL	1	PZ																																																																																		
VL1054B0	ONE WASHING SYS INLET DISTRIBUTOR	1	PZ																																																																																		
VL1065A1	1/4 MALE N.O. PRESSURE SWITCH	1	PZ																																																																																		
VL1102A1	DETERGENT LINE FILTER + BARBED VNR 6 MM	1	PZ																																																																																		
VL1128A1	D6 BARBED CHECK VALVE	2	PZ																																																																																		
VL1165A0	BB6-AR6 STRAIGHT FITTING	1	PZ																																																																																		
VL1166A0	BB6-AR6 L FITTING	3	PZ																																																																																		

COMPONENT			SPARE PART																																																																						
Code	Description	Image	Code	Description	Components list																																																																				
VL1166A	BB6-AR6 L FITTING		KVL1213A	US PLUS COMPACT WASHING SYSTEM KIT	<table border="1"> <thead> <tr> <th>Code</th> <th>Description</th> <th>Qty</th> <th>UOM</th> </tr> </thead> <tbody> <tr> <td>VL1174C0</td> <td>D1.2 MM CALIBRATED NOZZLE</td> <td>1</td> <td>PZ</td> </tr> <tr> <td>VL1185A0</td> <td>2 WAYS PLUS WASHING DISTRIBUTOR</td> <td>1</td> <td>PZ</td> </tr> <tr> <td>VM2172A0</td> <td>PUMP-WITH-CI RCUIT LOCKING PIN</td> <td>6</td> <td>PZ</td> </tr> </tbody> </table>	Code	Description	Qty	UOM	VL1174C0	D1.2 MM CALIBRATED NOZZLE	1	PZ	VL1185A0	2 WAYS PLUS WASHING DISTRIBUTOR	1	PZ	VM2172A0	PUMP-WITH-CI RCUIT LOCKING PIN	6	PZ																																																				
Code	Description	Qty	UOM																																																																						
VL1174C0	D1.2 MM CALIBRATED NOZZLE	1	PZ																																																																						
VL1185A0	2 WAYS PLUS WASHING DISTRIBUTOR	1	PZ																																																																						
VM2172A0	PUMP-WITH-CI RCUIT LOCKING PIN	6	PZ																																																																						
			KVL1212A	EUR COMPACT PLUS CLEANING SYSTEM KIT	<table border="1"> <thead> <tr> <th>Code</th> <th>Description</th> <th>Qty</th> <th>UOM</th> </tr> </thead> <tbody> <tr> <td>0H2428A0</td> <td></td> <td>1</td> <td>PZ</td> </tr> <tr> <td>EL1440A0</td> <td>WATER SELF CLEANING VALVE</td> <td>3</td> <td>PZ</td> </tr> <tr> <td>GN1312A0</td> <td>RUBBER CABLE-PASSI NG DE=26 DI=15 SP=10</td> <td>1</td> <td>PZ</td> </tr> <tr> <td>GN1526A0</td> <td>INT. D.=6.9 TH=1.8 O-RIN</td> <td>7</td> <td>PZ</td> </tr> <tr> <td>RC1018A0</td> <td>ZINC PLATED D12 ELASTIC CLAMP</td> <td>3</td> <td>PZ</td> </tr> <tr> <td>RC1019A0</td> <td>D=10 ELASTIC CLAMP</td> <td>14</td> <td>PZ</td> </tr> <tr> <td>RC1130A0</td> <td>130X2,6 CLAM</td> <td>1</td> <td>PZ</td> </tr> <tr> <td>RC1131A0</td> <td>200X2,6 BLACK CLAMP</td> <td>1</td> <td>PZ</td> </tr> <tr> <td>RC1242A0</td> <td>D=10 CLOSED CAP</td> <td>2</td> <td>PZ</td> </tr> <tr> <td>RC1356A0</td> <td>"STRAIGHT THREADED FEMALE END 8X1/4" BS</td> <td>1</td> <td>PZ</td> </tr> <tr> <td>TB2820A0</td> <td>6X10 EPDM PIPE FOR WASHING SYSTEM</td> <td>1.340</td> <td>M</td> </tr> <tr> <td>TB3132A0</td> <td>WHITE-BLUE EPDM TEXTILE BRAID HOSE 6X12</td> <td>1.400</td> <td>M</td> </tr> <tr> <td>VI1220A1</td> <td>4,2X12 TCB SELF-TAPPIN G SCREW</td> <td>3</td> <td>PZ</td> </tr> <tr> <td>VL1019A0</td> <td>VIBRATION PUMP</td> <td>1</td> <td>PZ</td> </tr> <tr> <td>VL1047A1</td> <td>D6 PIPE HOLDER - D8 J.G. TERMINAL</td> <td>1</td> <td>PZ</td> </tr> <tr> <td>VL1054B0</td> <td>ONE WASHING SYS INLET DISTRIBUTOR</td> <td>1</td> <td>PZ</td> </tr> </tbody> </table>	Code	Description	Qty	UOM	0H2428A0		1	PZ	EL1440A0	WATER SELF CLEANING VALVE	3	PZ	GN1312A0	RUBBER CABLE-PASSI NG DE=26 DI=15 SP=10	1	PZ	GN1526A0	INT. D.=6.9 TH=1.8 O-RIN	7	PZ	RC1018A0	ZINC PLATED D12 ELASTIC CLAMP	3	PZ	RC1019A0	D=10 ELASTIC CLAMP	14	PZ	RC1130A0	130X2,6 CLAM	1	PZ	RC1131A0	200X2,6 BLACK CLAMP	1	PZ	RC1242A0	D=10 CLOSED CAP	2	PZ	RC1356A0	"STRAIGHT THREADED FEMALE END 8X1/4" BS	1	PZ	TB2820A0	6X10 EPDM PIPE FOR WASHING SYSTEM	1.340	M	TB3132A0	WHITE-BLUE EPDM TEXTILE BRAID HOSE 6X12	1.400	M	VI1220A1	4,2X12 TCB SELF-TAPPIN G SCREW	3	PZ	VL1019A0	VIBRATION PUMP	1	PZ	VL1047A1	D6 PIPE HOLDER - D8 J.G. TERMINAL	1	PZ	VL1054B0	ONE WASHING SYS INLET DISTRIBUTOR	1	PZ
Code	Description	Qty	UOM																																																																						
0H2428A0		1	PZ																																																																						
EL1440A0	WATER SELF CLEANING VALVE	3	PZ																																																																						
GN1312A0	RUBBER CABLE-PASSI NG DE=26 DI=15 SP=10	1	PZ																																																																						
GN1526A0	INT. D.=6.9 TH=1.8 O-RIN	7	PZ																																																																						
RC1018A0	ZINC PLATED D12 ELASTIC CLAMP	3	PZ																																																																						
RC1019A0	D=10 ELASTIC CLAMP	14	PZ																																																																						
RC1130A0	130X2,6 CLAM	1	PZ																																																																						
RC1131A0	200X2,6 BLACK CLAMP	1	PZ																																																																						
RC1242A0	D=10 CLOSED CAP	2	PZ																																																																						
RC1356A0	"STRAIGHT THREADED FEMALE END 8X1/4" BS	1	PZ																																																																						
TB2820A0	6X10 EPDM PIPE FOR WASHING SYSTEM	1.340	M																																																																						
TB3132A0	WHITE-BLUE EPDM TEXTILE BRAID HOSE 6X12	1.400	M																																																																						
VI1220A1	4,2X12 TCB SELF-TAPPIN G SCREW	3	PZ																																																																						
VL1019A0	VIBRATION PUMP	1	PZ																																																																						
VL1047A1	D6 PIPE HOLDER - D8 J.G. TERMINAL	1	PZ																																																																						
VL1054B0	ONE WASHING SYS INLET DISTRIBUTOR	1	PZ																																																																						

COMPONENT			SPARE PART																																																						
Code	Description	Image	Code	Description	Components list																																																				
VL1166A	BB6-AR6 L FITTING		KVL1212A	EUR COMPACT PLUS CLEANING SYSTEM KIT	<table border="1"> <thead> <tr> <th>Code</th> <th>Description</th> <th>Qty</th> <th>UOM</th> </tr> </thead> <tbody> <tr> <td>VL1065A1</td> <td>1/4 MALE N.O. PRESSURE SWITCH</td> <td>1</td> <td>PZ</td> </tr> <tr> <td>VL1102A1</td> <td>DETERGENT LINE FILTER + BARBED VNR 6 MM</td> <td>1</td> <td>PZ</td> </tr> <tr> <td>VL1128A1</td> <td>D6 BARBED CHECK VALVE</td> <td>2</td> <td>PZ</td> </tr> <tr> <td>VL1165A0</td> <td>BB6-AR6 STRAIGHT FITTING</td> <td>1</td> <td>PZ</td> </tr> <tr> <td>VL1166A0</td> <td>BB6-AR6 L FITTING</td> <td>3</td> <td>PZ</td> </tr> <tr> <td>VL1174C0</td> <td>D1.2 MM CALIBRATED NOZZLE</td> <td>1</td> <td>PZ</td> </tr> <tr> <td>VL1185A0</td> <td>2 WAYS PLUS WASHING DISTRIBUTOR</td> <td>1</td> <td>PZ</td> </tr> <tr> <td>VM2172A0</td> <td>PUMP-WITH-CI RCUIT LOCKING PIN</td> <td>6</td> <td>PZ</td> </tr> </tbody> </table>	Code	Description	Qty	UOM	VL1065A1	1/4 MALE N.O. PRESSURE SWITCH	1	PZ	VL1102A1	DETERGENT LINE FILTER + BARBED VNR 6 MM	1	PZ	VL1128A1	D6 BARBED CHECK VALVE	2	PZ	VL1165A0	BB6-AR6 STRAIGHT FITTING	1	PZ	VL1166A0	BB6-AR6 L FITTING	3	PZ	VL1174C0	D1.2 MM CALIBRATED NOZZLE	1	PZ	VL1185A0	2 WAYS PLUS WASHING DISTRIBUTOR	1	PZ	VM2172A0	PUMP-WITH-CI RCUIT LOCKING PIN	6	PZ																
Code	Description	Qty	UOM																																																						
VL1065A1	1/4 MALE N.O. PRESSURE SWITCH	1	PZ																																																						
VL1102A1	DETERGENT LINE FILTER + BARBED VNR 6 MM	1	PZ																																																						
VL1128A1	D6 BARBED CHECK VALVE	2	PZ																																																						
VL1165A0	BB6-AR6 STRAIGHT FITTING	1	PZ																																																						
VL1166A0	BB6-AR6 L FITTING	3	PZ																																																						
VL1174C0	D1.2 MM CALIBRATED NOZZLE	1	PZ																																																						
VL1185A0	2 WAYS PLUS WASHING DISTRIBUTOR	1	PZ																																																						
VM2172A0	PUMP-WITH-CI RCUIT LOCKING PIN	6	PZ																																																						
			KVL1211A	ONE COMPACT AND 0523-EP WASH. SYSTEM KIT	<table border="1"> <thead> <tr> <th>Code</th> <th>Description</th> <th>Qty</th> <th>UOM</th> </tr> </thead> <tbody> <tr> <td>0H2427A0</td> <td></td> <td>1</td> <td>PZ</td> </tr> <tr> <td>EL1440A0</td> <td>WATER SELF CLEANING VALVE</td> <td>1</td> <td>PZ</td> </tr> <tr> <td>GN1526A0</td> <td>INT. D.=6.9 TH=1.8 O-RIN</td> <td>3</td> <td>PZ</td> </tr> <tr> <td>RC1018A0</td> <td>ZINC PLATED D12 ELASTIC CLAMP</td> <td>2</td> <td>PZ</td> </tr> <tr> <td>RC1019A0</td> <td>D=10 ELASTIC CLAMP</td> <td>14</td> <td>PZ</td> </tr> <tr> <td>RC1130A0</td> <td>130X2,6 CLAM</td> <td>1</td> <td>PZ</td> </tr> <tr> <td>RC1242A0</td> <td>D=10 CLOSED CAP</td> <td>2</td> <td>PZ</td> </tr> <tr> <td>TB2820A0</td> <td>6X10 EPDM PIPE FOR WASHING SYSTEM</td> <td>1.290</td> <td>M</td> </tr> <tr> <td>TB3132A0</td> <td>WHITE-BLUE EPDM TEXTILE BRAID HOSE 6X12</td> <td>0.670</td> <td>M</td> </tr> <tr> <td>VI1220A1</td> <td>4,2X12 TCB SELF-TAPPIN G SCREW</td> <td>4</td> <td>PZ</td> </tr> <tr> <td>VL1019A0</td> <td>VIBRATION PUMP</td> <td>1</td> <td>PZ</td> </tr> <tr> <td>VL1047A1</td> <td>D6 PIPE HOLDER - D8 J.G. TERMINAL</td> <td>1</td> <td>PZ</td> </tr> </tbody> </table>	Code	Description	Qty	UOM	0H2427A0		1	PZ	EL1440A0	WATER SELF CLEANING VALVE	1	PZ	GN1526A0	INT. D.=6.9 TH=1.8 O-RIN	3	PZ	RC1018A0	ZINC PLATED D12 ELASTIC CLAMP	2	PZ	RC1019A0	D=10 ELASTIC CLAMP	14	PZ	RC1130A0	130X2,6 CLAM	1	PZ	RC1242A0	D=10 CLOSED CAP	2	PZ	TB2820A0	6X10 EPDM PIPE FOR WASHING SYSTEM	1.290	M	TB3132A0	WHITE-BLUE EPDM TEXTILE BRAID HOSE 6X12	0.670	M	VI1220A1	4,2X12 TCB SELF-TAPPIN G SCREW	4	PZ	VL1019A0	VIBRATION PUMP	1	PZ	VL1047A1	D6 PIPE HOLDER - D8 J.G. TERMINAL	1	PZ
Code	Description	Qty	UOM																																																						
0H2427A0		1	PZ																																																						
EL1440A0	WATER SELF CLEANING VALVE	1	PZ																																																						
GN1526A0	INT. D.=6.9 TH=1.8 O-RIN	3	PZ																																																						
RC1018A0	ZINC PLATED D12 ELASTIC CLAMP	2	PZ																																																						
RC1019A0	D=10 ELASTIC CLAMP	14	PZ																																																						
RC1130A0	130X2,6 CLAM	1	PZ																																																						
RC1242A0	D=10 CLOSED CAP	2	PZ																																																						
TB2820A0	6X10 EPDM PIPE FOR WASHING SYSTEM	1.290	M																																																						
TB3132A0	WHITE-BLUE EPDM TEXTILE BRAID HOSE 6X12	0.670	M																																																						
VI1220A1	4,2X12 TCB SELF-TAPPIN G SCREW	4	PZ																																																						
VL1019A0	VIBRATION PUMP	1	PZ																																																						
VL1047A1	D6 PIPE HOLDER - D8 J.G. TERMINAL	1	PZ																																																						



COMPONENT			SPARE PART																																																		
Code	Description	Image	Code	Description	Components list																																																
VL1166A	BB6-AR6 L FITTING		KVL1211A	ONE COMPACT AND 0523-EP WASH. SYSTEM KIT	<table border="1"> <thead> <tr> <th>Code</th> <th>Description</th> <th>Qty</th> <th>UOM</th> </tr> </thead> <tbody> <tr> <td>VL1054B0</td> <td>ONE WASHING SYS INLET DISTRIBUTOR</td> <td>1</td> <td>PZ</td> </tr> <tr> <td>VL1102A1</td> <td>DETERGENT LINE FILTER + BARBED VNR 6 MM</td> <td>1</td> <td>PZ</td> </tr> <tr> <td>VL1128A1</td> <td>D6 BARBED CHECK VALVE</td> <td>2</td> <td>PZ</td> </tr> <tr> <td>VL1165A0</td> <td>BB6-AR6 STRAIGHT FITTING</td> <td>1</td> <td>PZ</td> </tr> <tr> <td>VL1166A0</td> <td>BB6-AR6 L FITTING</td> <td>1</td> <td>PZ</td> </tr> <tr> <td>VL1174C0</td> <td>D1.2 MM CALIBRATED NOZZLE</td> <td>1</td> <td>PZ</td> </tr> <tr> <td>VL1191A0</td> <td>ONE WASHING DISTRIBUTOR OUTLETS KIT</td> <td>1</td> <td>PZ</td> </tr> <tr> <td>VM2172A0</td> <td>PUMP-WITH-CI RCUIT LOCKING PIN</td> <td>3</td> <td>PZ</td> </tr> </tbody> </table>	Code	Description	Qty	UOM	VL1054B0	ONE WASHING SYS INLET DISTRIBUTOR	1	PZ	VL1102A1	DETERGENT LINE FILTER + BARBED VNR 6 MM	1	PZ	VL1128A1	D6 BARBED CHECK VALVE	2	PZ	VL1165A0	BB6-AR6 STRAIGHT FITTING	1	PZ	VL1166A0	BB6-AR6 L FITTING	1	PZ	VL1174C0	D1.2 MM CALIBRATED NOZZLE	1	PZ	VL1191A0	ONE WASHING DISTRIBUTOR OUTLETS KIT	1	PZ	VM2172A0	PUMP-WITH-CI RCUIT LOCKING PIN	3	PZ												
Code	Description	Qty	UOM																																																		
VL1054B0	ONE WASHING SYS INLET DISTRIBUTOR	1	PZ																																																		
VL1102A1	DETERGENT LINE FILTER + BARBED VNR 6 MM	1	PZ																																																		
VL1128A1	D6 BARBED CHECK VALVE	2	PZ																																																		
VL1165A0	BB6-AR6 STRAIGHT FITTING	1	PZ																																																		
VL1166A0	BB6-AR6 L FITTING	1	PZ																																																		
VL1174C0	D1.2 MM CALIBRATED NOZZLE	1	PZ																																																		
VL1191A0	ONE WASHING DISTRIBUTOR OUTLETS KIT	1	PZ																																																		
VM2172A0	PUMP-WITH-CI RCUIT LOCKING PIN	3	PZ																																																		
			KVL1209A	US PLUS 3 ROTOR ARMS WASHING SYSTEM KIT	<table border="1"> <thead> <tr> <th>Code</th> <th>Description</th> <th>Qty</th> <th>UOM</th> </tr> </thead> <tbody> <tr> <td>0H2354A0</td> <td>XEVC-XEVL WASHING CIRCUIT PLAT</td> <td>1</td> <td>PZ</td> </tr> <tr> <td>0H2411A0</td> <td></td> <td>1</td> <td>PZ</td> </tr> <tr> <td>EL1450A0</td> <td>US SELF-CLEANIN G WATER SOLENOID</td> <td>4</td> <td>PZ</td> </tr> <tr> <td>GN1526A0</td> <td>INT. D.=6.9 TH=1.8 O-RIN</td> <td>9</td> <td>PZ</td> </tr> <tr> <td>RC1018A0</td> <td>ZINC PLATED D12 ELASTIC CLAMP</td> <td>13</td> <td>PZ</td> </tr> <tr> <td>RC1019A0</td> <td>D=10 ELASTIC CLAMP</td> <td>15</td> <td>PZ</td> </tr> <tr> <td>RC1130A0</td> <td>130X2.6 CLAM</td> <td>1</td> <td>PZ</td> </tr> <tr> <td>RC1131A0</td> <td>200X2.6 BLACK CLAMP</td> <td>3</td> <td>PZ</td> </tr> <tr> <td>RC1242A0</td> <td>D=10 CLOSED CAP</td> <td>2</td> <td>PZ</td> </tr> <tr> <td>RC1356A0</td> <td>"STRAIGHT THREADED FEMALE END 8X1/4" BS</td> <td>1</td> <td>PZ</td> </tr> <tr> <td>TB2820A0</td> <td>6X10 EPDM PIPE FOR WASHING SYSTEM</td> <td>2.750</td> <td>M</td> </tr> </tbody> </table>	Code	Description	Qty	UOM	0H2354A0	XEVC-XEVL WASHING CIRCUIT PLAT	1	PZ	0H2411A0		1	PZ	EL1450A0	US SELF-CLEANIN G WATER SOLENOID	4	PZ	GN1526A0	INT. D.=6.9 TH=1.8 O-RIN	9	PZ	RC1018A0	ZINC PLATED D12 ELASTIC CLAMP	13	PZ	RC1019A0	D=10 ELASTIC CLAMP	15	PZ	RC1130A0	130X2.6 CLAM	1	PZ	RC1131A0	200X2.6 BLACK CLAMP	3	PZ	RC1242A0	D=10 CLOSED CAP	2	PZ	RC1356A0	"STRAIGHT THREADED FEMALE END 8X1/4" BS	1	PZ	TB2820A0	6X10 EPDM PIPE FOR WASHING SYSTEM	2.750	M
Code	Description	Qty	UOM																																																		
0H2354A0	XEVC-XEVL WASHING CIRCUIT PLAT	1	PZ																																																		
0H2411A0		1	PZ																																																		
EL1450A0	US SELF-CLEANIN G WATER SOLENOID	4	PZ																																																		
GN1526A0	INT. D.=6.9 TH=1.8 O-RIN	9	PZ																																																		
RC1018A0	ZINC PLATED D12 ELASTIC CLAMP	13	PZ																																																		
RC1019A0	D=10 ELASTIC CLAMP	15	PZ																																																		
RC1130A0	130X2.6 CLAM	1	PZ																																																		
RC1131A0	200X2.6 BLACK CLAMP	3	PZ																																																		
RC1242A0	D=10 CLOSED CAP	2	PZ																																																		
RC1356A0	"STRAIGHT THREADED FEMALE END 8X1/4" BS	1	PZ																																																		
TB2820A0	6X10 EPDM PIPE FOR WASHING SYSTEM	2.750	M																																																		







COMPONENT			SPARE PART																																																																														
Code	Description	Image	Code	Description	Components list																																																																												
VL1166A	BB6-AR6 L FITTING		KVL1209A	US PLUS 3 ROTOR ARMS WASHING SYSTEM KIT	<table border="1"> <thead> <tr> <th>Code</th> <th>Description</th> <th>Qty</th> <th>UOM</th> </tr> </thead> <tbody> <tr> <td>TB3132A0</td> <td>WHITE-BLUE EPDM TEXTILE BRAID HOSE 6X12</td> <td>1.980</td> <td>M</td> </tr> <tr> <td>VI1220A1</td> <td>4,2X12 TCB SELF-TAPPING SCREW</td> <td>3</td> <td>PZ</td> </tr> <tr> <td>VL1019A0</td> <td>VIBRATION PUMP</td> <td>1</td> <td>PZ</td> </tr> <tr> <td>VL1065A1</td> <td>1/4 MALE N.O. PRESSURE SWITCH</td> <td>1</td> <td>PZ</td> </tr> <tr> <td>VL1102A1</td> <td>DETERGENT LINE FILTER + BARBED VNR 6 MM</td> <td>1</td> <td>PZ</td> </tr> <tr> <td>VL1127A1</td> <td>6MM BARBED T-SHAPED FITTING</td> <td>2</td> <td>PZ</td> </tr> <tr> <td>VL1128A1</td> <td>D6 BARBED CHECK VALVE</td> <td>3</td> <td>PZ</td> </tr> <tr> <td>VL1165A0</td> <td>BB6-AR6 STRAIGHT FITTING</td> <td>1</td> <td>PZ</td> </tr> <tr> <td>VL1166A0</td> <td>BB6-AR6 L FITTING</td> <td>4</td> <td>PZ</td> </tr> <tr> <td>VL1167A0</td> <td></td> <td>1</td> <td>PZ</td> </tr> <tr> <td>VL1167A1</td> <td></td> <td>1</td> <td>PZ</td> </tr> <tr> <td>VL1167A2</td> <td>GN21 3 ROTOR ARMS B-B FLOW RESTRICTOR</td> <td>1</td> <td>PZ</td> </tr> <tr> <td>VL1174C0</td> <td>D1.2 MM CALIBRATED NOZZLE</td> <td>1</td> <td>PZ</td> </tr> <tr> <td>VL1185A0</td> <td>2 WAYS PLUS WASHING DISTRIBUTOR</td> <td>1</td> <td>PZ</td> </tr> <tr> <td>VL1186A0</td> <td>3 WAYS PLUS WASHING DISTRIBUTOR</td> <td>1</td> <td>PZ</td> </tr> <tr> <td>VL1190A0</td> <td>PLUS WASHING SYSTEM INLET DISTRIBUTOR</td> <td>1</td> <td>PZ</td> </tr> <tr> <td>VM1605A0</td> <td>CLIP TWIST LOCK DIAM. 10,2-12,7 MM</td> <td>6</td> <td>PZ</td> </tr> <tr> <td>VM2172A0</td> <td>PUMP-WITH-RCUIT LOCKING PIN</td> <td>9</td> <td>PZ</td> </tr> </tbody> </table>	Code	Description	Qty	UOM	TB3132A0	WHITE-BLUE EPDM TEXTILE BRAID HOSE 6X12	1.980	M	VI1220A1	4,2X12 TCB SELF-TAPPING SCREW	3	PZ	VL1019A0	VIBRATION PUMP	1	PZ	VL1065A1	1/4 MALE N.O. PRESSURE SWITCH	1	PZ	VL1102A1	DETERGENT LINE FILTER + BARBED VNR 6 MM	1	PZ	VL1127A1	6MM BARBED T-SHAPED FITTING	2	PZ	VL1128A1	D6 BARBED CHECK VALVE	3	PZ	VL1165A0	BB6-AR6 STRAIGHT FITTING	1	PZ	VL1166A0	BB6-AR6 L FITTING	4	PZ	VL1167A0		1	PZ	VL1167A1		1	PZ	VL1167A2	GN21 3 ROTOR ARMS B-B FLOW RESTRICTOR	1	PZ	VL1174C0	D1.2 MM CALIBRATED NOZZLE	1	PZ	VL1185A0	2 WAYS PLUS WASHING DISTRIBUTOR	1	PZ	VL1186A0	3 WAYS PLUS WASHING DISTRIBUTOR	1	PZ	VL1190A0	PLUS WASHING SYSTEM INLET DISTRIBUTOR	1	PZ	VM1605A0	CLIP TWIST LOCK DIAM. 10,2-12,7 MM	6	PZ	VM2172A0	PUMP-WITH-RCUIT LOCKING PIN	9	PZ
Code	Description	Qty	UOM																																																																														
TB3132A0	WHITE-BLUE EPDM TEXTILE BRAID HOSE 6X12	1.980	M																																																																														
VI1220A1	4,2X12 TCB SELF-TAPPING SCREW	3	PZ																																																																														
VL1019A0	VIBRATION PUMP	1	PZ																																																																														
VL1065A1	1/4 MALE N.O. PRESSURE SWITCH	1	PZ																																																																														
VL1102A1	DETERGENT LINE FILTER + BARBED VNR 6 MM	1	PZ																																																																														
VL1127A1	6MM BARBED T-SHAPED FITTING	2	PZ																																																																														
VL1128A1	D6 BARBED CHECK VALVE	3	PZ																																																																														
VL1165A0	BB6-AR6 STRAIGHT FITTING	1	PZ																																																																														
VL1166A0	BB6-AR6 L FITTING	4	PZ																																																																														
VL1167A0		1	PZ																																																																														
VL1167A1		1	PZ																																																																														
VL1167A2	GN21 3 ROTOR ARMS B-B FLOW RESTRICTOR	1	PZ																																																																														
VL1174C0	D1.2 MM CALIBRATED NOZZLE	1	PZ																																																																														
VL1185A0	2 WAYS PLUS WASHING DISTRIBUTOR	1	PZ																																																																														
VL1186A0	3 WAYS PLUS WASHING DISTRIBUTOR	1	PZ																																																																														
VL1190A0	PLUS WASHING SYSTEM INLET DISTRIBUTOR	1	PZ																																																																														
VM1605A0	CLIP TWIST LOCK DIAM. 10,2-12,7 MM	6	PZ																																																																														
VM2172A0	PUMP-WITH-RCUIT LOCKING PIN	9	PZ																																																																														



COMPONENT			SPARE PART																																																																																						
Code	Description	Image	Code	Description	Components list																																																																																				
VL1166A	BB6-AR6 L FITTING		KVL1208A	US PLUS 2 ROTOR ARMS WASHING SYSTEM KIT	<table border="1"> <thead> <tr> <th>Code</th> <th>Description</th> <th>Qty</th> <th>UOM</th> </tr> </thead> <tbody> <tr> <td>0H2354A0</td> <td>XEVC-XEVL WASHING CIRCUIT PLAT</td> <td>1</td> <td>PZ</td> </tr> <tr> <td>0H2411A0</td> <td></td> <td>1</td> <td>PZ</td> </tr> <tr> <td>EL1450A0</td> <td>US SELF-CLEANIN G WATER SOLENOID</td> <td>4</td> <td>PZ</td> </tr> <tr> <td>GN1526A0</td> <td>INT. D.=6.9 TH=1.8 O-RIN</td> <td>9</td> <td>PZ</td> </tr> <tr> <td>RC1018A0</td> <td>ZINC PLATED D12 ELASTIC CLAMP</td> <td>4</td> <td>PZ</td> </tr> <tr> <td>RC1019A0</td> <td>D=10 ELASTIC CLAMP</td> <td>16</td> <td>PZ</td> </tr> <tr> <td>RC1130A0</td> <td>130X2,6 CLAM</td> <td>1</td> <td>PZ</td> </tr> <tr> <td>RC1131A0</td> <td>200X2.6 BLACK CLAMP</td> <td>3</td> <td>PZ</td> </tr> <tr> <td>RC1242A0</td> <td>D=10 CLOSED CAP</td> <td>2</td> <td>PZ</td> </tr> <tr> <td>RC1356A0</td> <td>*STRAIGHT THREADED FEMALE END 8X1/4" BS</td> <td>1</td> <td>PZ</td> </tr> <tr> <td>TB2820A0</td> <td>6X10 EPDM PIPE FOR WASHING SYSTEM</td> <td>2.890</td> <td>M</td> </tr> <tr> <td>TB3132A0</td> <td>WHITE-BLUE EPDM TEXTILE BRAID HOSE 6X12</td> <td>1.600</td> <td>M</td> </tr> <tr> <td>VI1220A1</td> <td>4,2X12 TCB SELF-TAPPIN G SCREW</td> <td>3</td> <td>PZ</td> </tr> <tr> <td>VL1019A0</td> <td>VIBRATION PUMP</td> <td>1</td> <td>PZ</td> </tr> <tr> <td>VL1047A1</td> <td>D6 PIPE HOLDER - D8 J.G. TERMINAL</td> <td>1</td> <td>PZ</td> </tr> <tr> <td>VL1065A1</td> <td>1/4 MALE N.O. PRESSURE SWITCH</td> <td>1</td> <td>PZ</td> </tr> <tr> <td>VL1102A1</td> <td>DETERGENT LINE FILTER + BARBED VNR 6 MM</td> <td>1</td> <td>PZ</td> </tr> <tr> <td>VL1128A1</td> <td>D6 BARBED CHECK VALVE</td> <td>2</td> <td>PZ</td> </tr> <tr> <td>VL1141A1</td> <td>STRAIGHT CONNECT BB6-BB6</td> <td>1</td> <td>PZ</td> </tr> <tr> <td>VL1165A0</td> <td>BB6-AR6 STRAIGHT FITTING</td> <td>1</td> <td>PZ</td> </tr> </tbody> </table>	Code	Description	Qty	UOM	0H2354A0	XEVC-XEVL WASHING CIRCUIT PLAT	1	PZ	0H2411A0		1	PZ	EL1450A0	US SELF-CLEANIN G WATER SOLENOID	4	PZ	GN1526A0	INT. D.=6.9 TH=1.8 O-RIN	9	PZ	RC1018A0	ZINC PLATED D12 ELASTIC CLAMP	4	PZ	RC1019A0	D=10 ELASTIC CLAMP	16	PZ	RC1130A0	130X2,6 CLAM	1	PZ	RC1131A0	200X2.6 BLACK CLAMP	3	PZ	RC1242A0	D=10 CLOSED CAP	2	PZ	RC1356A0	*STRAIGHT THREADED FEMALE END 8X1/4" BS	1	PZ	TB2820A0	6X10 EPDM PIPE FOR WASHING SYSTEM	2.890	M	TB3132A0	WHITE-BLUE EPDM TEXTILE BRAID HOSE 6X12	1.600	M	VI1220A1	4,2X12 TCB SELF-TAPPIN G SCREW	3	PZ	VL1019A0	VIBRATION PUMP	1	PZ	VL1047A1	D6 PIPE HOLDER - D8 J.G. TERMINAL	1	PZ	VL1065A1	1/4 MALE N.O. PRESSURE SWITCH	1	PZ	VL1102A1	DETERGENT LINE FILTER + BARBED VNR 6 MM	1	PZ	VL1128A1	D6 BARBED CHECK VALVE	2	PZ	VL1141A1	STRAIGHT CONNECT BB6-BB6	1	PZ	VL1165A0	BB6-AR6 STRAIGHT FITTING	1	PZ
Code	Description	Qty	UOM																																																																																						
0H2354A0	XEVC-XEVL WASHING CIRCUIT PLAT	1	PZ																																																																																						
0H2411A0		1	PZ																																																																																						
EL1450A0	US SELF-CLEANIN G WATER SOLENOID	4	PZ																																																																																						
GN1526A0	INT. D.=6.9 TH=1.8 O-RIN	9	PZ																																																																																						
RC1018A0	ZINC PLATED D12 ELASTIC CLAMP	4	PZ																																																																																						
RC1019A0	D=10 ELASTIC CLAMP	16	PZ																																																																																						
RC1130A0	130X2,6 CLAM	1	PZ																																																																																						
RC1131A0	200X2.6 BLACK CLAMP	3	PZ																																																																																						
RC1242A0	D=10 CLOSED CAP	2	PZ																																																																																						
RC1356A0	*STRAIGHT THREADED FEMALE END 8X1/4" BS	1	PZ																																																																																						
TB2820A0	6X10 EPDM PIPE FOR WASHING SYSTEM	2.890	M																																																																																						
TB3132A0	WHITE-BLUE EPDM TEXTILE BRAID HOSE 6X12	1.600	M																																																																																						
VI1220A1	4,2X12 TCB SELF-TAPPIN G SCREW	3	PZ																																																																																						
VL1019A0	VIBRATION PUMP	1	PZ																																																																																						
VL1047A1	D6 PIPE HOLDER - D8 J.G. TERMINAL	1	PZ																																																																																						
VL1065A1	1/4 MALE N.O. PRESSURE SWITCH	1	PZ																																																																																						
VL1102A1	DETERGENT LINE FILTER + BARBED VNR 6 MM	1	PZ																																																																																						
VL1128A1	D6 BARBED CHECK VALVE	2	PZ																																																																																						
VL1141A1	STRAIGHT CONNECT BB6-BB6	1	PZ																																																																																						
VL1165A0	BB6-AR6 STRAIGHT FITTING	1	PZ																																																																																						





COMPONENT			SPARE PART																																																							
Code	Description	Image	Code	Description	Components list																																																					
VL1166A	BB6-AR6 L FITTING		KVL1208A	US PLUS 2 ROTOR ARMS WASHING SYSTEM KIT	<table border="1"> <thead> <tr> <th>Code</th> <th>Description</th> <th>Qty</th> <th>UOM</th> </tr> </thead> <tbody> <tr> <td>VL1166A0</td> <td>BB6-AR6 L FITTING</td> <td>4</td> <td>PZ</td> </tr> <tr> <td>VL1174C0</td> <td>D1.2 MM CALIBRATED NOZZLE</td> <td>1</td> <td>PZ</td> </tr> <tr> <td>VL1186A0</td> <td>3 WAYS PLUS WASHING DISTRIBUTOR</td> <td>1</td> <td>PZ</td> </tr> <tr> <td>VL1190A0</td> <td>PLUS WASHING SYSTEM INLET DISTRIBUTOR</td> <td>1</td> <td>PZ</td> </tr> <tr> <td>VM1605A0</td> <td>CLIP TWIST LOCK DIAM. 10,2-12,7 MM</td> <td>6</td> <td>PZ</td> </tr> <tr> <td>VM2172A0</td> <td>PUMP-WITH-CI RCUIT LOCKING PIN</td> <td>9</td> <td>PZ</td> </tr> </tbody> </table>	Code	Description	Qty	UOM	VL1166A0	BB6-AR6 L FITTING	4	PZ	VL1174C0	D1.2 MM CALIBRATED NOZZLE	1	PZ	VL1186A0	3 WAYS PLUS WASHING DISTRIBUTOR	1	PZ	VL1190A0	PLUS WASHING SYSTEM INLET DISTRIBUTOR	1	PZ	VM1605A0	CLIP TWIST LOCK DIAM. 10,2-12,7 MM	6	PZ	VM2172A0	PUMP-WITH-CI RCUIT LOCKING PIN	9	PZ																									
			Code	Description	Qty	UOM																																																				
VL1166A0	BB6-AR6 L FITTING	4	PZ																																																							
VL1174C0	D1.2 MM CALIBRATED NOZZLE	1	PZ																																																							
VL1186A0	3 WAYS PLUS WASHING DISTRIBUTOR	1	PZ																																																							
VL1190A0	PLUS WASHING SYSTEM INLET DISTRIBUTOR	1	PZ																																																							
VM1605A0	CLIP TWIST LOCK DIAM. 10,2-12,7 MM	6	PZ																																																							
VM2172A0	PUMP-WITH-CI RCUIT LOCKING PIN	9	PZ																																																							
KVL1207A	US PLUS 1 ROTOR ARM WASHING SYSTEM KIT	<table border="1"> <thead> <tr> <th>Code</th> <th>Description</th> <th>Qty</th> <th>UOM</th> </tr> </thead> <tbody> <tr> <td>0H2354A0</td> <td>XEVC-XEVL WASHING CIRCUIT PLAT</td> <td>1</td> <td>PZ</td> </tr> <tr> <td>0H2411A0</td> <td></td> <td>1</td> <td>PZ</td> </tr> <tr> <td>EL1450A0</td> <td>US SELF-CLEANIN G WATER SOLENOID</td> <td>3</td> <td>PZ</td> </tr> <tr> <td>GN1526A0</td> <td>INT. D.=6.9 TH=1.8 O-RIN</td> <td>7</td> <td>PZ</td> </tr> <tr> <td>RC1018A0</td> <td>ZINC PLATED D12 ELASTIC CLAMP</td> <td>3</td> <td>PZ</td> </tr> <tr> <td>RC1019A0</td> <td>D=10 ELASTIC CLAMP</td> <td>14</td> <td>PZ</td> </tr> <tr> <td>RC1130A0</td> <td>130X2,6 CLAM</td> <td>1</td> <td>PZ</td> </tr> <tr> <td>RC1131A0</td> <td>200X2.6 BLACK CLAMP</td> <td>2</td> <td>PZ</td> </tr> <tr> <td>RC1242A0</td> <td>D=10 CLOSED CAP</td> <td>2</td> <td>PZ</td> </tr> <tr> <td>RC1356A0</td> <td>"STRAIGHT THREADED FEMALE END 8X1/4" BS</td> <td>1</td> <td>PZ</td> </tr> <tr> <td>TB2820A0</td> <td>6X10 EPDM PIPE FOR WASHING SYSTEM</td> <td>1.460</td> <td>M</td> </tr> <tr> <td>TB3132A0</td> <td>WHITE-BLUE EPDM TEXTILE BRAID HOSE 6X12</td> <td>0.770</td> <td>M</td> </tr> <tr> <td>VI1220A1</td> <td>4,2X12 TCB SELF-TAPPIN G SCREW</td> <td>3</td> <td>PZ</td> </tr> </tbody> </table>	Code	Description	Qty	UOM	0H2354A0	XEVC-XEVL WASHING CIRCUIT PLAT	1	PZ	0H2411A0		1	PZ	EL1450A0	US SELF-CLEANIN G WATER SOLENOID	3	PZ	GN1526A0	INT. D.=6.9 TH=1.8 O-RIN	7	PZ	RC1018A0	ZINC PLATED D12 ELASTIC CLAMP	3	PZ	RC1019A0	D=10 ELASTIC CLAMP	14	PZ	RC1130A0	130X2,6 CLAM	1	PZ	RC1131A0	200X2.6 BLACK CLAMP	2	PZ	RC1242A0	D=10 CLOSED CAP	2	PZ	RC1356A0	"STRAIGHT THREADED FEMALE END 8X1/4" BS	1	PZ	TB2820A0	6X10 EPDM PIPE FOR WASHING SYSTEM	1.460	M	TB3132A0	WHITE-BLUE EPDM TEXTILE BRAID HOSE 6X12	0.770	M	VI1220A1	4,2X12 TCB SELF-TAPPIN G SCREW	3	PZ
Code	Description	Qty	UOM																																																							
0H2354A0	XEVC-XEVL WASHING CIRCUIT PLAT	1	PZ																																																							
0H2411A0		1	PZ																																																							
EL1450A0	US SELF-CLEANIN G WATER SOLENOID	3	PZ																																																							
GN1526A0	INT. D.=6.9 TH=1.8 O-RIN	7	PZ																																																							
RC1018A0	ZINC PLATED D12 ELASTIC CLAMP	3	PZ																																																							
RC1019A0	D=10 ELASTIC CLAMP	14	PZ																																																							
RC1130A0	130X2,6 CLAM	1	PZ																																																							
RC1131A0	200X2.6 BLACK CLAMP	2	PZ																																																							
RC1242A0	D=10 CLOSED CAP	2	PZ																																																							
RC1356A0	"STRAIGHT THREADED FEMALE END 8X1/4" BS	1	PZ																																																							
TB2820A0	6X10 EPDM PIPE FOR WASHING SYSTEM	1.460	M																																																							
TB3132A0	WHITE-BLUE EPDM TEXTILE BRAID HOSE 6X12	0.770	M																																																							
VI1220A1	4,2X12 TCB SELF-TAPPIN G SCREW	3	PZ																																																							

COMPONENT			SPARE PART																																																																																									
Code	Description	Image	Code	Description	Components list																																																																																							
VL1166A	BB6-AR6 L FITTING		KVL1207A	US PLUS 1 ROTOR ARM WASHING SYSTEM KIT	<table border="1"> <thead> <tr> <th>Code</th> <th>Description</th> <th>Qty</th> <th>UOM</th> </tr> </thead> <tbody> <tr> <td>VL1019A0</td> <td>VIBRATION PUMP</td> <td>1</td> <td>PZ</td> </tr> <tr> <td>VL1047A1</td> <td>D6 PIPE HOLDER - D8 J.G. TERMINAL</td> <td>1</td> <td>PZ</td> </tr> <tr> <td>VL1065A1</td> <td>1/4 MALE N.O. PRESSURE SWITCH</td> <td>1</td> <td>PZ</td> </tr> <tr> <td>VL1102A1</td> <td>DETERGENT LINE FILTER + BARBED VNR 6 MM</td> <td>1</td> <td>PZ</td> </tr> <tr> <td>VL1128A1</td> <td>D6 BARBED CHECK VALVE</td> <td>2</td> <td>PZ</td> </tr> <tr> <td>VL1165A0</td> <td>BB6-AR6 STRAIGHT FITTING</td> <td>1</td> <td>PZ</td> </tr> <tr> <td>VL1166A0</td> <td>BB6-AR6 L FITTING</td> <td>3</td> <td>PZ</td> </tr> <tr> <td>VL1174C0</td> <td>D1.2 MM CALIBRATED NOZZLE</td> <td>1</td> <td>PZ</td> </tr> <tr> <td>VL1185A0</td> <td>2 WAYS PLUS WASHING DISTRIBUTOR</td> <td>1</td> <td>PZ</td> </tr> <tr> <td>VL1190A0</td> <td>PLUS WASHING SYSTEM INLET DISTRIBUTOR</td> <td>1</td> <td>PZ</td> </tr> <tr> <td>VM1605A0</td> <td>CLIP TWIST LOCK DIAM. 10.2-12.7 MM</td> <td>6</td> <td>PZ</td> </tr> <tr> <td>VM2172A0</td> <td>PUMP-WITH-CI RCUIT LOCKING PIN</td> <td>6</td> <td>PZ</td> </tr> </tbody> </table>	Code	Description	Qty	UOM	VL1019A0	VIBRATION PUMP	1	PZ	VL1047A1	D6 PIPE HOLDER - D8 J.G. TERMINAL	1	PZ	VL1065A1	1/4 MALE N.O. PRESSURE SWITCH	1	PZ	VL1102A1	DETERGENT LINE FILTER + BARBED VNR 6 MM	1	PZ	VL1128A1	D6 BARBED CHECK VALVE	2	PZ	VL1165A0	BB6-AR6 STRAIGHT FITTING	1	PZ	VL1166A0	BB6-AR6 L FITTING	3	PZ	VL1174C0	D1.2 MM CALIBRATED NOZZLE	1	PZ	VL1185A0	2 WAYS PLUS WASHING DISTRIBUTOR	1	PZ	VL1190A0	PLUS WASHING SYSTEM INLET DISTRIBUTOR	1	PZ	VM1605A0	CLIP TWIST LOCK DIAM. 10.2-12.7 MM	6	PZ	VM2172A0	PUMP-WITH-CI RCUIT LOCKING PIN	6	PZ	KVL1198A	MM EU HOOD CLEANING SYSTEM KIT	<table border="1"> <thead> <tr> <th>Code</th> <th>Description</th> <th>Qty</th> <th>UOM</th> </tr> </thead> <tbody> <tr> <td>0H2213A1</td> <td></td> <td>1</td> <td>PZ</td> </tr> <tr> <td>EL1440A0</td> <td>WATER SELF CLEANING VALVE</td> <td>2</td> <td>PZ</td> </tr> <tr> <td>GN1526A0</td> <td>INT. D.=6.9 TH=1.8 O-RIN</td> <td>5</td> <td>PZ</td> </tr> <tr> <td>RC1018A0</td> <td>ZINC PLATED D12 ELASTIC CLAMP</td> <td>6</td> <td>PZ</td> </tr> <tr> <td>RC1019A0</td> <td>D=10 ELASTIC CLAMP</td> <td>16</td> <td>PZ</td> </tr> <tr> <td>RC1131A0</td> <td>200X2.6 BLACK CLAMP</td> <td>1</td> <td>PZ</td> </tr> <tr> <td>RC1242A0</td> <td>D=10 CLOSED CAP</td> <td>2</td> <td>PZ</td> </tr> </tbody> </table>	Code	Description	Qty	UOM	0H2213A1		1	PZ	EL1440A0	WATER SELF CLEANING VALVE	2	PZ	GN1526A0	INT. D.=6.9 TH=1.8 O-RIN	5	PZ	RC1018A0	ZINC PLATED D12 ELASTIC CLAMP	6	PZ	RC1019A0	D=10 ELASTIC CLAMP	16	PZ	RC1131A0	200X2.6 BLACK CLAMP	1	PZ	RC1242A0	D=10 CLOSED CAP	2	PZ
			Code	Description	Qty	UOM																																																																																						
VL1019A0	VIBRATION PUMP	1	PZ																																																																																									
VL1047A1	D6 PIPE HOLDER - D8 J.G. TERMINAL	1	PZ																																																																																									
VL1065A1	1/4 MALE N.O. PRESSURE SWITCH	1	PZ																																																																																									
VL1102A1	DETERGENT LINE FILTER + BARBED VNR 6 MM	1	PZ																																																																																									
VL1128A1	D6 BARBED CHECK VALVE	2	PZ																																																																																									
VL1165A0	BB6-AR6 STRAIGHT FITTING	1	PZ																																																																																									
VL1166A0	BB6-AR6 L FITTING	3	PZ																																																																																									
VL1174C0	D1.2 MM CALIBRATED NOZZLE	1	PZ																																																																																									
VL1185A0	2 WAYS PLUS WASHING DISTRIBUTOR	1	PZ																																																																																									
VL1190A0	PLUS WASHING SYSTEM INLET DISTRIBUTOR	1	PZ																																																																																									
VM1605A0	CLIP TWIST LOCK DIAM. 10.2-12.7 MM	6	PZ																																																																																									
VM2172A0	PUMP-WITH-CI RCUIT LOCKING PIN	6	PZ																																																																																									
Code	Description	Qty	UOM																																																																																									
0H2213A1		1	PZ																																																																																									
EL1440A0	WATER SELF CLEANING VALVE	2	PZ																																																																																									
GN1526A0	INT. D.=6.9 TH=1.8 O-RIN	5	PZ																																																																																									
RC1018A0	ZINC PLATED D12 ELASTIC CLAMP	6	PZ																																																																																									
RC1019A0	D=10 ELASTIC CLAMP	16	PZ																																																																																									
RC1131A0	200X2.6 BLACK CLAMP	1	PZ																																																																																									
RC1242A0	D=10 CLOSED CAP	2	PZ																																																																																									



COMPONENT			SPARE PART																																																																		
Code	Description	Image	Code	Description	Components list																																																																
VL1166A	BB6-AR6 L FITTING		KVL1198A	MM EU HOOD CLEANING SYSTEM KIT	<table border="1"> <thead> <tr> <th>Code</th> <th>Description</th> <th>Qty</th> <th>UOM</th> </tr> </thead> <tbody> <tr> <td>TB2820A0</td> <td>6X10 EPDM PIPE FOR WASHING SYSTEM</td> <td>2.240</td> <td>M</td> </tr> <tr> <td>TB3132A0</td> <td>WHITE-BLUE EPDM TEXTILE BRAID HOSE 6X12</td> <td>0.440</td> <td>M</td> </tr> <tr> <td>VI1220A1</td> <td>4,2X12 TCB SELF-TAPPIN G SCREW</td> <td>3</td> <td>PZ</td> </tr> <tr> <td>VL1019A0</td> <td>VIBRATION PUMP</td> <td>1</td> <td>PZ</td> </tr> <tr> <td>VL1047A1</td> <td>D6 PIPE HOLDER - D8 J.G. TERMINAL</td> <td>2</td> <td>PZ</td> </tr> <tr> <td>VL1054B0</td> <td>ONE WASHING SYS INLET DISTRIBUTOR</td> <td>1</td> <td>PZ</td> </tr> <tr> <td>VL1102A1</td> <td>DETERGENT LINE FILTER + BARBED VNR 6 MM</td> <td>1</td> <td>PZ</td> </tr> <tr> <td>VL1127A1</td> <td>6MM BARBED T-SHAPED FITTING</td> <td>1</td> <td>PZ</td> </tr> <tr> <td>VL1128A1</td> <td>D6 BARBED CHECK VALVE</td> <td>2</td> <td>PZ</td> </tr> <tr> <td>VL1165A0</td> <td>BB6-AR6 STRAIGHT FITTING</td> <td>2</td> <td>PZ</td> </tr> <tr> <td>VL1166A0</td> <td>BB6-AR6 L FITTING</td> <td>2</td> <td>PZ</td> </tr> <tr> <td>VL1174C0</td> <td>D1.2 MM CALIBRATED NOZZLE</td> <td>1</td> <td>PZ</td> </tr> <tr> <td>VL1191A0</td> <td>ONE WASHING DISTRIBUTOR OUTLETS KIT</td> <td>1</td> <td>PZ</td> </tr> <tr> <td>VM1605A0</td> <td>CLIP TWIST LOCK DIAM. 10,2-12,7 MM</td> <td>4</td> <td>PZ</td> </tr> <tr> <td>VM2172A0</td> <td>PUMP-WITH-CI RCUIT LOCKING PIN</td> <td>5</td> <td>PZ</td> </tr> </tbody> </table>	Code	Description	Qty	UOM	TB2820A0	6X10 EPDM PIPE FOR WASHING SYSTEM	2.240	M	TB3132A0	WHITE-BLUE EPDM TEXTILE BRAID HOSE 6X12	0.440	M	VI1220A1	4,2X12 TCB SELF-TAPPIN G SCREW	3	PZ	VL1019A0	VIBRATION PUMP	1	PZ	VL1047A1	D6 PIPE HOLDER - D8 J.G. TERMINAL	2	PZ	VL1054B0	ONE WASHING SYS INLET DISTRIBUTOR	1	PZ	VL1102A1	DETERGENT LINE FILTER + BARBED VNR 6 MM	1	PZ	VL1127A1	6MM BARBED T-SHAPED FITTING	1	PZ	VL1128A1	D6 BARBED CHECK VALVE	2	PZ	VL1165A0	BB6-AR6 STRAIGHT FITTING	2	PZ	VL1166A0	BB6-AR6 L FITTING	2	PZ	VL1174C0	D1.2 MM CALIBRATED NOZZLE	1	PZ	VL1191A0	ONE WASHING DISTRIBUTOR OUTLETS KIT	1	PZ	VM1605A0	CLIP TWIST LOCK DIAM. 10,2-12,7 MM	4	PZ	VM2172A0	PUMP-WITH-CI RCUIT LOCKING PIN	5	PZ
Code	Description	Qty	UOM																																																																		
TB2820A0	6X10 EPDM PIPE FOR WASHING SYSTEM	2.240	M																																																																		
TB3132A0	WHITE-BLUE EPDM TEXTILE BRAID HOSE 6X12	0.440	M																																																																		
VI1220A1	4,2X12 TCB SELF-TAPPIN G SCREW	3	PZ																																																																		
VL1019A0	VIBRATION PUMP	1	PZ																																																																		
VL1047A1	D6 PIPE HOLDER - D8 J.G. TERMINAL	2	PZ																																																																		
VL1054B0	ONE WASHING SYS INLET DISTRIBUTOR	1	PZ																																																																		
VL1102A1	DETERGENT LINE FILTER + BARBED VNR 6 MM	1	PZ																																																																		
VL1127A1	6MM BARBED T-SHAPED FITTING	1	PZ																																																																		
VL1128A1	D6 BARBED CHECK VALVE	2	PZ																																																																		
VL1165A0	BB6-AR6 STRAIGHT FITTING	2	PZ																																																																		
VL1166A0	BB6-AR6 L FITTING	2	PZ																																																																		
VL1174C0	D1.2 MM CALIBRATED NOZZLE	1	PZ																																																																		
VL1191A0	ONE WASHING DISTRIBUTOR OUTLETS KIT	1	PZ																																																																		
VM1605A0	CLIP TWIST LOCK DIAM. 10,2-12,7 MM	4	PZ																																																																		
VM2172A0	PUMP-WITH-CI RCUIT LOCKING PIN	5	PZ																																																																		
			KVL1187A	3 ROTOR ARMS PLUS EU CLEANING SYSTEM KIT	<table border="1"> <thead> <tr> <th>Code</th> <th>Description</th> <th>Qty</th> <th>UOM</th> </tr> </thead> <tbody> <tr> <td>0H2143A0</td> <td>LAMIERA BLOCCA VNR VL1128</td> <td>3</td> <td>PZ</td> </tr> <tr> <td>0H2168A0</td> <td></td> <td>1</td> <td>PZ</td> </tr> </tbody> </table>	Code	Description	Qty	UOM	0H2143A0	LAMIERA BLOCCA VNR VL1128	3	PZ	0H2168A0		1	PZ																																																				
Code	Description	Qty	UOM																																																																		
0H2143A0	LAMIERA BLOCCA VNR VL1128	3	PZ																																																																		
0H2168A0		1	PZ																																																																		

COMPONENT			SPARE PART																																																																																		
Code	Description	Image	Code	Description	Components list																																																																																
VL1166A	BB6-AR6 L FITTING		KVL1187A	3 ROTOR ARMS PLUS EU CLEANING SYSTEM KIT	<table border="1"> <thead> <tr> <th>Code</th> <th>Description</th> <th>Qty</th> <th>UOM</th> </tr> </thead> <tbody> <tr> <td>0H2354A0</td> <td>XEVC-XEVL WASHING CIRCUIT PLAT</td> <td>1</td> <td>PZ</td> </tr> <tr> <td>EL1120A0</td> <td>D8-D6 FEMALE STRAIGHT INTERM. CONNECTION</td> <td>1</td> <td>PZ</td> </tr> <tr> <td>EL1220A0</td> <td>JG STRAIGHT CONNECTION Ø8F-Ø8F</td> <td>2</td> <td>PZ</td> </tr> <tr> <td>EL1440A0</td> <td>WATER SELF CLEANING VALVE</td> <td>4</td> <td>PZ</td> </tr> <tr> <td>GN1526A0</td> <td>INT. D.=6.9 TH=1.8 O-RIN</td> <td>9</td> <td>PZ</td> </tr> <tr> <td>RC1018A0</td> <td>ZINC PLATED D12 ELASTIC CLAMP</td> <td>10</td> <td>PZ</td> </tr> <tr> <td>RC1019A0</td> <td>D=10 ELASTIC CLAMP</td> <td>22</td> <td>PZ</td> </tr> <tr> <td>RC1130A0</td> <td>130X2,6 CLAM</td> <td>4</td> <td>PZ</td> </tr> <tr> <td>RC1131A0</td> <td>200X2.6 BLACK CLAMP</td> <td>3</td> <td>PZ</td> </tr> <tr> <td>RC1242A0</td> <td>D=10 CLOSED CAP</td> <td>2</td> <td>PZ</td> </tr> <tr> <td>RC1310A0</td> <td>140X4 CLAMP WITH CLIP</td> <td>1</td> <td>PZ</td> </tr> <tr> <td>RC1356A0</td> <td>"STRAIGHT THREADED FEMALE END 8X1/4" BS</td> <td>1</td> <td>PZ</td> </tr> <tr> <td>TB2820A0</td> <td>6X10 EPDM PIPE FOR WASHING SYSTEM</td> <td>1.510</td> <td>M</td> </tr> <tr> <td>TB3132A0</td> <td>WHITE-BLUE EPDM TEXTILE BRAID HOSE 6X12</td> <td>1.210</td> <td>M</td> </tr> <tr> <td>VI1220A1</td> <td>4,2X12 TCB SELF-TAPPIN G SCREW</td> <td>3</td> <td>PZ</td> </tr> <tr> <td>VL1019A0</td> <td>VIBRATION PUMP</td> <td>1</td> <td>PZ</td> </tr> <tr> <td>VL1046A1</td> <td>D6 PIPE HOLDER - D6 J.G. TERMINAL</td> <td>3</td> <td>PZ</td> </tr> <tr> <td>VL1047A1</td> <td>D6 PIPE HOLDER - D8 J.G. TERMINAL</td> <td>1</td> <td>PZ</td> </tr> <tr> <td>VL1064A0</td> <td>WASHING SYSTEM OUTLETS DISTRIBUTOR</td> <td>1</td> <td>PZ</td> </tr> </tbody> </table>	Code	Description	Qty	UOM	0H2354A0	XEVC-XEVL WASHING CIRCUIT PLAT	1	PZ	EL1120A0	D8-D6 FEMALE STRAIGHT INTERM. CONNECTION	1	PZ	EL1220A0	JG STRAIGHT CONNECTION Ø8F-Ø8F	2	PZ	EL1440A0	WATER SELF CLEANING VALVE	4	PZ	GN1526A0	INT. D.=6.9 TH=1.8 O-RIN	9	PZ	RC1018A0	ZINC PLATED D12 ELASTIC CLAMP	10	PZ	RC1019A0	D=10 ELASTIC CLAMP	22	PZ	RC1130A0	130X2,6 CLAM	4	PZ	RC1131A0	200X2.6 BLACK CLAMP	3	PZ	RC1242A0	D=10 CLOSED CAP	2	PZ	RC1310A0	140X4 CLAMP WITH CLIP	1	PZ	RC1356A0	"STRAIGHT THREADED FEMALE END 8X1/4" BS	1	PZ	TB2820A0	6X10 EPDM PIPE FOR WASHING SYSTEM	1.510	M	TB3132A0	WHITE-BLUE EPDM TEXTILE BRAID HOSE 6X12	1.210	M	VI1220A1	4,2X12 TCB SELF-TAPPIN G SCREW	3	PZ	VL1019A0	VIBRATION PUMP	1	PZ	VL1046A1	D6 PIPE HOLDER - D6 J.G. TERMINAL	3	PZ	VL1047A1	D6 PIPE HOLDER - D8 J.G. TERMINAL	1	PZ	VL1064A0	WASHING SYSTEM OUTLETS DISTRIBUTOR	1	PZ
Code	Description	Qty	UOM																																																																																		
0H2354A0	XEVC-XEVL WASHING CIRCUIT PLAT	1	PZ																																																																																		
EL1120A0	D8-D6 FEMALE STRAIGHT INTERM. CONNECTION	1	PZ																																																																																		
EL1220A0	JG STRAIGHT CONNECTION Ø8F-Ø8F	2	PZ																																																																																		
EL1440A0	WATER SELF CLEANING VALVE	4	PZ																																																																																		
GN1526A0	INT. D.=6.9 TH=1.8 O-RIN	9	PZ																																																																																		
RC1018A0	ZINC PLATED D12 ELASTIC CLAMP	10	PZ																																																																																		
RC1019A0	D=10 ELASTIC CLAMP	22	PZ																																																																																		
RC1130A0	130X2,6 CLAM	4	PZ																																																																																		
RC1131A0	200X2.6 BLACK CLAMP	3	PZ																																																																																		
RC1242A0	D=10 CLOSED CAP	2	PZ																																																																																		
RC1310A0	140X4 CLAMP WITH CLIP	1	PZ																																																																																		
RC1356A0	"STRAIGHT THREADED FEMALE END 8X1/4" BS	1	PZ																																																																																		
TB2820A0	6X10 EPDM PIPE FOR WASHING SYSTEM	1.510	M																																																																																		
TB3132A0	WHITE-BLUE EPDM TEXTILE BRAID HOSE 6X12	1.210	M																																																																																		
VI1220A1	4,2X12 TCB SELF-TAPPIN G SCREW	3	PZ																																																																																		
VL1019A0	VIBRATION PUMP	1	PZ																																																																																		
VL1046A1	D6 PIPE HOLDER - D6 J.G. TERMINAL	3	PZ																																																																																		
VL1047A1	D6 PIPE HOLDER - D8 J.G. TERMINAL	1	PZ																																																																																		
VL1064A0	WASHING SYSTEM OUTLETS DISTRIBUTOR	1	PZ																																																																																		

COMPONENT			SPARE PART																																																																														
Code	Description	Image	Code	Description	Components list																																																																												
VL1166A	BB6-AR6 L FITTING		KVL1187A	3 ROTOR ARMS PLUS EU CLEANING SYSTEM KIT	<table border="1"> <thead> <tr> <th>Code</th> <th>Description</th> <th>Qty</th> <th>UOM</th> </tr> </thead> <tbody> <tr> <td>VL1065A1</td> <td>1/4 MALE N.O. PRESSURE SWITCH</td> <td>1</td> <td>PZ</td> </tr> <tr> <td>VL1067A0</td> <td>WASHING SYSTEM INLETS DISTRIBUTOR</td> <td>1</td> <td>PZ</td> </tr> <tr> <td>VL1092A0</td> <td>WASHING SYSTEM OUTLET DOUBLE DISTRIBUTOR</td> <td>1</td> <td>PZ</td> </tr> <tr> <td>VL1102A1</td> <td>DETERGENT LINE FILTER + BARBED VNR 6 MM</td> <td>1</td> <td>PZ</td> </tr> <tr> <td>VL1127A1</td> <td>6MM BARBED T-SHAPED FITTING</td> <td>2</td> <td>PZ</td> </tr> <tr> <td>VL1128A0</td> <td>D6 BARBED CHECK VALVE</td> <td>3</td> <td>PZ</td> </tr> <tr> <td>VL1128A1</td> <td>D6 BARBED CHECK VALVE</td> <td>3</td> <td>PZ</td> </tr> <tr> <td>VL1165A0</td> <td>BB6-AR6 STRAIGHT FITTING</td> <td>4</td> <td>PZ</td> </tr> <tr> <td>VL1166A0</td> <td>BB6-AR6 L FITTING</td> <td>4</td> <td>PZ</td> </tr> <tr> <td>VL1167A0</td> <td></td> <td>1</td> <td>PZ</td> </tr> <tr> <td>VL1167A1</td> <td></td> <td>1</td> <td>PZ</td> </tr> <tr> <td>VL1167A2</td> <td>GN21 3 ROTOR ARMS B-B FLOW RESTRICTOR</td> <td>1</td> <td>PZ</td> </tr> <tr> <td>VL1174C0</td> <td>D1.2 MM CALIBRATED NOZZLE</td> <td>1</td> <td>PZ</td> </tr> <tr> <td>VL1185A0</td> <td>2 WAYS PLUS WASHING DISTRIBUTOR</td> <td>1</td> <td>PZ</td> </tr> <tr> <td>VL1186A0</td> <td>3 WAYS PLUS WASHING DISTRIBUTOR</td> <td>1</td> <td>PZ</td> </tr> <tr> <td>VL1190A0</td> <td>PLUS WASHING SYSTEM INLET DISTRIBUTOR</td> <td>1</td> <td>PZ</td> </tr> <tr> <td>VM1605A0</td> <td>CLIP TWIST LOCK DIAM. 10,2-12,7 MM</td> <td>3</td> <td>PZ</td> </tr> <tr> <td>VM2172A0</td> <td>PUMP-WITH-CI RCUIT LOCKING PIN</td> <td>9</td> <td>PZ</td> </tr> </tbody> </table>	Code	Description	Qty	UOM	VL1065A1	1/4 MALE N.O. PRESSURE SWITCH	1	PZ	VL1067A0	WASHING SYSTEM INLETS DISTRIBUTOR	1	PZ	VL1092A0	WASHING SYSTEM OUTLET DOUBLE DISTRIBUTOR	1	PZ	VL1102A1	DETERGENT LINE FILTER + BARBED VNR 6 MM	1	PZ	VL1127A1	6MM BARBED T-SHAPED FITTING	2	PZ	VL1128A0	D6 BARBED CHECK VALVE	3	PZ	VL1128A1	D6 BARBED CHECK VALVE	3	PZ	VL1165A0	BB6-AR6 STRAIGHT FITTING	4	PZ	VL1166A0	BB6-AR6 L FITTING	4	PZ	VL1167A0		1	PZ	VL1167A1		1	PZ	VL1167A2	GN21 3 ROTOR ARMS B-B FLOW RESTRICTOR	1	PZ	VL1174C0	D1.2 MM CALIBRATED NOZZLE	1	PZ	VL1185A0	2 WAYS PLUS WASHING DISTRIBUTOR	1	PZ	VL1186A0	3 WAYS PLUS WASHING DISTRIBUTOR	1	PZ	VL1190A0	PLUS WASHING SYSTEM INLET DISTRIBUTOR	1	PZ	VM1605A0	CLIP TWIST LOCK DIAM. 10,2-12,7 MM	3	PZ	VM2172A0	PUMP-WITH-CI RCUIT LOCKING PIN	9	PZ
Code	Description	Qty	UOM																																																																														
VL1065A1	1/4 MALE N.O. PRESSURE SWITCH	1	PZ																																																																														
VL1067A0	WASHING SYSTEM INLETS DISTRIBUTOR	1	PZ																																																																														
VL1092A0	WASHING SYSTEM OUTLET DOUBLE DISTRIBUTOR	1	PZ																																																																														
VL1102A1	DETERGENT LINE FILTER + BARBED VNR 6 MM	1	PZ																																																																														
VL1127A1	6MM BARBED T-SHAPED FITTING	2	PZ																																																																														
VL1128A0	D6 BARBED CHECK VALVE	3	PZ																																																																														
VL1128A1	D6 BARBED CHECK VALVE	3	PZ																																																																														
VL1165A0	BB6-AR6 STRAIGHT FITTING	4	PZ																																																																														
VL1166A0	BB6-AR6 L FITTING	4	PZ																																																																														
VL1167A0		1	PZ																																																																														
VL1167A1		1	PZ																																																																														
VL1167A2	GN21 3 ROTOR ARMS B-B FLOW RESTRICTOR	1	PZ																																																																														
VL1174C0	D1.2 MM CALIBRATED NOZZLE	1	PZ																																																																														
VL1185A0	2 WAYS PLUS WASHING DISTRIBUTOR	1	PZ																																																																														
VL1186A0	3 WAYS PLUS WASHING DISTRIBUTOR	1	PZ																																																																														
VL1190A0	PLUS WASHING SYSTEM INLET DISTRIBUTOR	1	PZ																																																																														
VM1605A0	CLIP TWIST LOCK DIAM. 10,2-12,7 MM	3	PZ																																																																														
VM2172A0	PUMP-WITH-CI RCUIT LOCKING PIN	9	PZ																																																																														





COMPONENT			SPARE PART																																																																																		
Code	Description	Image	Code	Description	Components list																																																																																
VL1166A	BB6-AR6 L FITTING		KVL1184A	2 ROTOR ARMS PLUS EU CLEANING SYSTEM KIT	<table border="1"> <thead> <tr> <th>Code</th> <th>Description</th> <th>Qty</th> <th>UOM</th> </tr> </thead> <tbody> <tr> <td>0H2143A0</td> <td>LAMIERA BLOCCA VNR VL1128</td> <td>2</td> <td>PZ</td> </tr> <tr> <td>0H2168A0</td> <td></td> <td>1</td> <td>PZ</td> </tr> <tr> <td>0H2354A0</td> <td>XEVC-XEVL WASHING CIRCUIT PLAT</td> <td>1</td> <td>PZ</td> </tr> <tr> <td>EL1220A0</td> <td>JG STRAIGHT CONNECTION Ø8F-Ø8F</td> <td>3</td> <td>PZ</td> </tr> <tr> <td>EL1440A0</td> <td>WATER SELF CLEANING VALVE</td> <td>4</td> <td>PZ</td> </tr> <tr> <td>GN1526A0</td> <td>INT. D.=6.9 TH=1.8 O-RIN</td> <td>9</td> <td>PZ</td> </tr> <tr> <td>RC1018A0</td> <td>ZINC PLATED D12 ELASTIC CLAMP</td> <td>2</td> <td>PZ</td> </tr> <tr> <td>RC1019A0</td> <td>D=10 ELASTIC CLAMP</td> <td>21</td> <td>PZ</td> </tr> <tr> <td>RC1130A0</td> <td>130X2,6 CLAM</td> <td>7</td> <td>PZ</td> </tr> <tr> <td>RC1131A0</td> <td>200X2.6 BLACK CLAMP</td> <td>3</td> <td>PZ</td> </tr> <tr> <td>RC1242A0</td> <td>D=10 CLOSED CAP</td> <td>2</td> <td>PZ</td> </tr> <tr> <td>RC1356A0</td> <td>"STRAIGHT THREADED FEMALE END 8X1/4" BS</td> <td>1</td> <td>PZ</td> </tr> <tr> <td>TB2820A0</td> <td>6X10 EPDM PIPE FOR WASHING SYSTEM</td> <td>2.400</td> <td>M</td> </tr> <tr> <td>TB3132A0</td> <td>WHITE-BLUE EPDM TEXTILE BRAID HOSE 6X12</td> <td>1.220</td> <td>M</td> </tr> <tr> <td>VL1019A0</td> <td>VIBRATION PUMP</td> <td>1</td> <td>PZ</td> </tr> <tr> <td>VL1046A1</td> <td>D6 PIPE HOLDER - D6 J.G. TERMINAL</td> <td>3</td> <td>PZ</td> </tr> <tr> <td>VL1047A1</td> <td>D6 PIPE HOLDER - D8 J.G. TERMINAL</td> <td>1</td> <td>PZ</td> </tr> <tr> <td>VL1065A1</td> <td>1/4 MALE N.O. PRESSURE SWITCH</td> <td>1</td> <td>PZ</td> </tr> <tr> <td>VL1067A0</td> <td>WASHING SYSTEM INLETS DISTRIBUTOR</td> <td>1</td> <td>PZ</td> </tr> </tbody> </table>	Code	Description	Qty	UOM	0H2143A0	LAMIERA BLOCCA VNR VL1128	2	PZ	0H2168A0		1	PZ	0H2354A0	XEVC-XEVL WASHING CIRCUIT PLAT	1	PZ	EL1220A0	JG STRAIGHT CONNECTION Ø8F-Ø8F	3	PZ	EL1440A0	WATER SELF CLEANING VALVE	4	PZ	GN1526A0	INT. D.=6.9 TH=1.8 O-RIN	9	PZ	RC1018A0	ZINC PLATED D12 ELASTIC CLAMP	2	PZ	RC1019A0	D=10 ELASTIC CLAMP	21	PZ	RC1130A0	130X2,6 CLAM	7	PZ	RC1131A0	200X2.6 BLACK CLAMP	3	PZ	RC1242A0	D=10 CLOSED CAP	2	PZ	RC1356A0	"STRAIGHT THREADED FEMALE END 8X1/4" BS	1	PZ	TB2820A0	6X10 EPDM PIPE FOR WASHING SYSTEM	2.400	M	TB3132A0	WHITE-BLUE EPDM TEXTILE BRAID HOSE 6X12	1.220	M	VL1019A0	VIBRATION PUMP	1	PZ	VL1046A1	D6 PIPE HOLDER - D6 J.G. TERMINAL	3	PZ	VL1047A1	D6 PIPE HOLDER - D8 J.G. TERMINAL	1	PZ	VL1065A1	1/4 MALE N.O. PRESSURE SWITCH	1	PZ	VL1067A0	WASHING SYSTEM INLETS DISTRIBUTOR	1	PZ
Code	Description	Qty	UOM																																																																																		
0H2143A0	LAMIERA BLOCCA VNR VL1128	2	PZ																																																																																		
0H2168A0		1	PZ																																																																																		
0H2354A0	XEVC-XEVL WASHING CIRCUIT PLAT	1	PZ																																																																																		
EL1220A0	JG STRAIGHT CONNECTION Ø8F-Ø8F	3	PZ																																																																																		
EL1440A0	WATER SELF CLEANING VALVE	4	PZ																																																																																		
GN1526A0	INT. D.=6.9 TH=1.8 O-RIN	9	PZ																																																																																		
RC1018A0	ZINC PLATED D12 ELASTIC CLAMP	2	PZ																																																																																		
RC1019A0	D=10 ELASTIC CLAMP	21	PZ																																																																																		
RC1130A0	130X2,6 CLAM	7	PZ																																																																																		
RC1131A0	200X2.6 BLACK CLAMP	3	PZ																																																																																		
RC1242A0	D=10 CLOSED CAP	2	PZ																																																																																		
RC1356A0	"STRAIGHT THREADED FEMALE END 8X1/4" BS	1	PZ																																																																																		
TB2820A0	6X10 EPDM PIPE FOR WASHING SYSTEM	2.400	M																																																																																		
TB3132A0	WHITE-BLUE EPDM TEXTILE BRAID HOSE 6X12	1.220	M																																																																																		
VL1019A0	VIBRATION PUMP	1	PZ																																																																																		
VL1046A1	D6 PIPE HOLDER - D6 J.G. TERMINAL	3	PZ																																																																																		
VL1047A1	D6 PIPE HOLDER - D8 J.G. TERMINAL	1	PZ																																																																																		
VL1065A1	1/4 MALE N.O. PRESSURE SWITCH	1	PZ																																																																																		
VL1067A0	WASHING SYSTEM INLETS DISTRIBUTOR	1	PZ																																																																																		





COMPONENT			SPARE PART																																																						
Code	Description	Image	Code	Description	Components list																																																				
VL1166A	BB6-AR6 L FITTING		KVL1184A	2 ROTOR ARMS PLUS EU CLEANING SYSTEM KIT	<table border="1"> <thead> <tr> <th>Code</th> <th>Description</th> <th>Qty</th> <th>UOM</th> </tr> </thead> <tbody> <tr> <td>VL1092A0</td> <td>WASHING SYSTEM OUTLET DOUBLE DISTRIBUTOR</td> <td>1</td> <td>PZ</td> </tr> <tr> <td>VL1102A1</td> <td>DETERGENT LINE FILTER + BARBED VNR 6 MM</td> <td>1</td> <td>PZ</td> </tr> <tr> <td>VL1128A0</td> <td>D6 BARBED CHECK VALVE</td> <td>2</td> <td>PZ</td> </tr> <tr> <td>VL1128A1</td> <td>D6 BARBED CHECK VALVE</td> <td>2</td> <td>PZ</td> </tr> <tr> <td>VL1141A1</td> <td>STRAIGHT CONNECT BB6-BB6</td> <td>1</td> <td>PZ</td> </tr> <tr> <td>VL1165A0</td> <td>BB6-AR6 STRAIGHT FITTING</td> <td>4</td> <td>PZ</td> </tr> <tr> <td>VL1166A0</td> <td>BB6-AR6 L FITTING</td> <td>4</td> <td>PZ</td> </tr> <tr> <td>VL1174C0</td> <td>D1.2 MM CALIBRATED NOZZLE</td> <td>1</td> <td>PZ</td> </tr> <tr> <td>VL1186A0</td> <td>3 WAYS PLUS WASHING DISTRIBUTOR</td> <td>1</td> <td>PZ</td> </tr> <tr> <td>VL1190A0</td> <td>PLUS WASHING SYSTEM INLET DISTRIBUTOR</td> <td>1</td> <td>PZ</td> </tr> <tr> <td>VM1605A0</td> <td>CLIP TWIST LOCK DIAM. 10,2-12,7 MM</td> <td>4</td> <td>PZ</td> </tr> <tr> <td>VM2172A0</td> <td>PUMP-WITH-CI RCUIT LOCKING PIN</td> <td>9</td> <td>PZ</td> </tr> </tbody> </table>	Code	Description	Qty	UOM	VL1092A0	WASHING SYSTEM OUTLET DOUBLE DISTRIBUTOR	1	PZ	VL1102A1	DETERGENT LINE FILTER + BARBED VNR 6 MM	1	PZ	VL1128A0	D6 BARBED CHECK VALVE	2	PZ	VL1128A1	D6 BARBED CHECK VALVE	2	PZ	VL1141A1	STRAIGHT CONNECT BB6-BB6	1	PZ	VL1165A0	BB6-AR6 STRAIGHT FITTING	4	PZ	VL1166A0	BB6-AR6 L FITTING	4	PZ	VL1174C0	D1.2 MM CALIBRATED NOZZLE	1	PZ	VL1186A0	3 WAYS PLUS WASHING DISTRIBUTOR	1	PZ	VL1190A0	PLUS WASHING SYSTEM INLET DISTRIBUTOR	1	PZ	VM1605A0	CLIP TWIST LOCK DIAM. 10,2-12,7 MM	4	PZ	VM2172A0	PUMP-WITH-CI RCUIT LOCKING PIN	9	PZ
Code	Description	Qty	UOM																																																						
VL1092A0	WASHING SYSTEM OUTLET DOUBLE DISTRIBUTOR	1	PZ																																																						
VL1102A1	DETERGENT LINE FILTER + BARBED VNR 6 MM	1	PZ																																																						
VL1128A0	D6 BARBED CHECK VALVE	2	PZ																																																						
VL1128A1	D6 BARBED CHECK VALVE	2	PZ																																																						
VL1141A1	STRAIGHT CONNECT BB6-BB6	1	PZ																																																						
VL1165A0	BB6-AR6 STRAIGHT FITTING	4	PZ																																																						
VL1166A0	BB6-AR6 L FITTING	4	PZ																																																						
VL1174C0	D1.2 MM CALIBRATED NOZZLE	1	PZ																																																						
VL1186A0	3 WAYS PLUS WASHING DISTRIBUTOR	1	PZ																																																						
VL1190A0	PLUS WASHING SYSTEM INLET DISTRIBUTOR	1	PZ																																																						
VM1605A0	CLIP TWIST LOCK DIAM. 10,2-12,7 MM	4	PZ																																																						
VM2172A0	PUMP-WITH-CI RCUIT LOCKING PIN	9	PZ																																																						
			KVL1183A	1 ROTOR ARM PLUS CLEANING SYSTEM KIT	<table border="1"> <thead> <tr> <th>Code</th> <th>Description</th> <th>Qty</th> <th>UOM</th> </tr> </thead> <tbody> <tr> <td>0H2143A0</td> <td>LAMIERA BLOCCA VNR VL1128</td> <td>2</td> <td>PZ</td> </tr> <tr> <td>0H2168A1</td> <td></td> <td>1</td> <td>PZ</td> </tr> <tr> <td>0H2354A0</td> <td>XEVC-XEVL WASHING CIRCUIT PLAT</td> <td>1</td> <td>PZ</td> </tr> <tr> <td>EL1440A0</td> <td>WATER SELF CLEANING VALVE</td> <td>3</td> <td>PZ</td> </tr> <tr> <td>GN1526A0</td> <td>INT. D.=6.9 TH=1.8 O-RIN</td> <td>7</td> <td>PZ</td> </tr> <tr> <td>RC1018A0</td> <td>ZINC PLATED D12 ELASTIC CLAMP</td> <td>2</td> <td>PZ</td> </tr> </tbody> </table>	Code	Description	Qty	UOM	0H2143A0	LAMIERA BLOCCA VNR VL1128	2	PZ	0H2168A1		1	PZ	0H2354A0	XEVC-XEVL WASHING CIRCUIT PLAT	1	PZ	EL1440A0	WATER SELF CLEANING VALVE	3	PZ	GN1526A0	INT. D.=6.9 TH=1.8 O-RIN	7	PZ	RC1018A0	ZINC PLATED D12 ELASTIC CLAMP	2	PZ																								
Code	Description	Qty	UOM																																																						
0H2143A0	LAMIERA BLOCCA VNR VL1128	2	PZ																																																						
0H2168A1		1	PZ																																																						
0H2354A0	XEVC-XEVL WASHING CIRCUIT PLAT	1	PZ																																																						
EL1440A0	WATER SELF CLEANING VALVE	3	PZ																																																						
GN1526A0	INT. D.=6.9 TH=1.8 O-RIN	7	PZ																																																						
RC1018A0	ZINC PLATED D12 ELASTIC CLAMP	2	PZ																																																						

COMPONENT			SPARE PART																																																																																		
Code	Description	Image	Code	Description	Components list																																																																																
VL1166A	BB6-AR6 L FITTING		KVL1183A	1 ROTOR ARM PLUS CLEANING SYSTEM KIT	<table border="1"> <thead> <tr> <th>Code</th> <th>Description</th> <th>Qty</th> <th>UOM</th> </tr> </thead> <tbody> <tr> <td>RC1019A0</td> <td>D=10 ELASTIC CLAMP</td> <td>14</td> <td>PZ</td> </tr> <tr> <td>RC1130A0</td> <td>130X2,6 CLAM</td> <td>5</td> <td>PZ</td> </tr> <tr> <td>RC1131A0</td> <td>200X2.6 BLACK CLAMP</td> <td>2</td> <td>PZ</td> </tr> <tr> <td>RC1242A0</td> <td>D=10 CLOSED CAP</td> <td>2</td> <td>PZ</td> </tr> <tr> <td>RC1356A0</td> <td>"STRAIGHT THREADED FEMALE END 8X1/4" BS</td> <td>1</td> <td>PZ</td> </tr> <tr> <td>TB2820A0</td> <td>6X10 EPDM PIPE FOR WASHING SYSTEM</td> <td>1.410</td> <td>M</td> </tr> <tr> <td>TB3132A0</td> <td>WHITE-BLUE EPDM TEXTILE BRAID HOSE 6X12</td> <td>0.770</td> <td>M</td> </tr> <tr> <td>VI1220A1</td> <td>4,2X12 TCB SELF-TAPPING SCREW</td> <td>3</td> <td>PZ</td> </tr> <tr> <td>VL1019A0</td> <td>VIBRATION PUMP</td> <td>1</td> <td>PZ</td> </tr> <tr> <td>VL1047A1</td> <td>D6 PIPE HOLDER - D8 J.G. TERMINAL</td> <td>1</td> <td>PZ</td> </tr> <tr> <td>VL1065A1</td> <td>1/4 MALE N.O. PRESSURE SWITCH</td> <td>1</td> <td>PZ</td> </tr> <tr> <td>VL1102A1</td> <td>DETERGENT LINE FILTER + BARBED VNR 6 MM</td> <td>1</td> <td>PZ</td> </tr> <tr> <td>VL1128A0</td> <td>D6 BARBED CHECK VALVE</td> <td>2</td> <td>PZ</td> </tr> <tr> <td>VL1128A1</td> <td>D6 BARBED CHECK VALVE</td> <td>2</td> <td>PZ</td> </tr> <tr> <td>VL1165A0</td> <td>BB6-AR6 STRAIGHT FITTING</td> <td>1</td> <td>PZ</td> </tr> <tr> <td>VL1166A0</td> <td>BB6-AR6 L FITTING</td> <td>3</td> <td>PZ</td> </tr> <tr> <td>VL1174C0</td> <td>D1.2 MM CALIBRATED NOZZLE</td> <td>1</td> <td>PZ</td> </tr> <tr> <td>VL1185A0</td> <td>2 WAYS PLUS WASHING DISTRIBUTOR</td> <td>1</td> <td>PZ</td> </tr> <tr> <td>VL1190A0</td> <td>PLUS WASHING SYSTEM INLET DISTRIBUTOR</td> <td>1</td> <td>PZ</td> </tr> </tbody> </table>	Code	Description	Qty	UOM	RC1019A0	D=10 ELASTIC CLAMP	14	PZ	RC1130A0	130X2,6 CLAM	5	PZ	RC1131A0	200X2.6 BLACK CLAMP	2	PZ	RC1242A0	D=10 CLOSED CAP	2	PZ	RC1356A0	"STRAIGHT THREADED FEMALE END 8X1/4" BS	1	PZ	TB2820A0	6X10 EPDM PIPE FOR WASHING SYSTEM	1.410	M	TB3132A0	WHITE-BLUE EPDM TEXTILE BRAID HOSE 6X12	0.770	M	VI1220A1	4,2X12 TCB SELF-TAPPING SCREW	3	PZ	VL1019A0	VIBRATION PUMP	1	PZ	VL1047A1	D6 PIPE HOLDER - D8 J.G. TERMINAL	1	PZ	VL1065A1	1/4 MALE N.O. PRESSURE SWITCH	1	PZ	VL1102A1	DETERGENT LINE FILTER + BARBED VNR 6 MM	1	PZ	VL1128A0	D6 BARBED CHECK VALVE	2	PZ	VL1128A1	D6 BARBED CHECK VALVE	2	PZ	VL1165A0	BB6-AR6 STRAIGHT FITTING	1	PZ	VL1166A0	BB6-AR6 L FITTING	3	PZ	VL1174C0	D1.2 MM CALIBRATED NOZZLE	1	PZ	VL1185A0	2 WAYS PLUS WASHING DISTRIBUTOR	1	PZ	VL1190A0	PLUS WASHING SYSTEM INLET DISTRIBUTOR	1	PZ
Code	Description	Qty	UOM																																																																																		
RC1019A0	D=10 ELASTIC CLAMP	14	PZ																																																																																		
RC1130A0	130X2,6 CLAM	5	PZ																																																																																		
RC1131A0	200X2.6 BLACK CLAMP	2	PZ																																																																																		
RC1242A0	D=10 CLOSED CAP	2	PZ																																																																																		
RC1356A0	"STRAIGHT THREADED FEMALE END 8X1/4" BS	1	PZ																																																																																		
TB2820A0	6X10 EPDM PIPE FOR WASHING SYSTEM	1.410	M																																																																																		
TB3132A0	WHITE-BLUE EPDM TEXTILE BRAID HOSE 6X12	0.770	M																																																																																		
VI1220A1	4,2X12 TCB SELF-TAPPING SCREW	3	PZ																																																																																		
VL1019A0	VIBRATION PUMP	1	PZ																																																																																		
VL1047A1	D6 PIPE HOLDER - D8 J.G. TERMINAL	1	PZ																																																																																		
VL1065A1	1/4 MALE N.O. PRESSURE SWITCH	1	PZ																																																																																		
VL1102A1	DETERGENT LINE FILTER + BARBED VNR 6 MM	1	PZ																																																																																		
VL1128A0	D6 BARBED CHECK VALVE	2	PZ																																																																																		
VL1128A1	D6 BARBED CHECK VALVE	2	PZ																																																																																		
VL1165A0	BB6-AR6 STRAIGHT FITTING	1	PZ																																																																																		
VL1166A0	BB6-AR6 L FITTING	3	PZ																																																																																		
VL1174C0	D1.2 MM CALIBRATED NOZZLE	1	PZ																																																																																		
VL1185A0	2 WAYS PLUS WASHING DISTRIBUTOR	1	PZ																																																																																		
VL1190A0	PLUS WASHING SYSTEM INLET DISTRIBUTOR	1	PZ																																																																																		

COMPONENT			SPARE PART																																																																			
Code	Description	Image	Code	Description	Components list																																																																	
VL1166A	BB6-AR6 L FITTING		KVL1183A	1 ROTOR ARM PLUS CLEANING SYSTEM KIT	<table border="1"> <thead> <tr> <th>Code</th> <th>Description</th> <th>Qty</th> <th>UOM</th> </tr> </thead> <tbody> <tr> <td>VM1605A0</td> <td>CLIP TWIST LOCK DIAM. 10,2-12,7 MM</td> <td>3</td> <td>PZ</td> </tr> <tr> <td>VM2172A0</td> <td>PUMP-WITH-CI RCUIT LOCKING PIN</td> <td>7</td> <td>PZ</td> </tr> </tbody> </table>	Code	Description	Qty	UOM	VM1605A0	CLIP TWIST LOCK DIAM. 10,2-12,7 MM	3	PZ	VM2172A0	PUMP-WITH-CI RCUIT LOCKING PIN	7	PZ																																																					
			Code	Description	Qty	UOM																																																																
VM1605A0	CLIP TWIST LOCK DIAM. 10,2-12,7 MM	3	PZ																																																																			
VM2172A0	PUMP-WITH-CI RCUIT LOCKING PIN	7	PZ																																																																			
KVL1182A	ONE CLEANING SYSTEM KIT (0311 EXC.)	<table border="1"> <thead> <tr> <th>Code</th> <th>Description</th> <th>Qty</th> <th>UOM</th> </tr> </thead> <tbody> <tr> <td>0H2143A0</td> <td>LAMIERA BLOCCA VNR VL1128</td> <td>2</td> <td>PZ</td> </tr> <tr> <td>0H2202A1</td> <td>ONE WASHING WITH STEAM VALVE SUPPORT</td> <td>1</td> <td>PZ</td> </tr> <tr> <td>EL1440A0</td> <td>WATER SELF CLEANING VALVE</td> <td>1</td> <td>PZ</td> </tr> <tr> <td>GN1526A0</td> <td>INT. D.=6.9 TH=1.8 O-RIN</td> <td>3</td> <td>PZ</td> </tr> <tr> <td>RC1018A0</td> <td>ZINC PLATED D12 ELASTIC CLAMP</td> <td>1</td> <td>PZ</td> </tr> <tr> <td>RC1019A0</td> <td>D=10 ELASTIC CLAMP</td> <td>14</td> <td>PZ</td> </tr> <tr> <td>RC1130A0</td> <td>130X2,6 CLAM</td> <td>2</td> <td>PZ</td> </tr> <tr> <td>RC1242A0</td> <td>D=10 CLOSED CAP</td> <td>2</td> <td>PZ</td> </tr> <tr> <td>TB2820A0</td> <td>6X10 EPDM PIPE FOR WASHING SYSTEM</td> <td>1.410</td> <td>M</td> </tr> <tr> <td>TB3132A0</td> <td>WHITE-BLUE EPDM TEXTILE BRAID HOSE 6X12</td> <td>0.670</td> <td>M</td> </tr> <tr> <td>VI1220A1</td> <td>4,2X12 TCB SELF-TAPPIN G SCREW</td> <td>1</td> <td>PZ</td> </tr> <tr> <td>VL1019A0</td> <td>VIBRATION PUMP</td> <td>1</td> <td>PZ</td> </tr> <tr> <td>VL1047A1</td> <td>D6 PIPE HOLDER - D8 J.G. TERMINAL</td> <td>1</td> <td>PZ</td> </tr> <tr> <td>VL1054B0</td> <td>ONE WASHING SYS INLET DISTRIBUTOR</td> <td>1</td> <td>PZ</td> </tr> <tr> <td>VL1102A1</td> <td>DETERGENT LINE FILTER + BARBED VNR 6 MM</td> <td>1</td> <td>PZ</td> </tr> <tr> <td>VL1128A0</td> <td>D6 BARBED CHECK VALVE</td> <td>2</td> <td>PZ</td> </tr> </tbody> </table>	Code	Description	Qty	UOM	0H2143A0	LAMIERA BLOCCA VNR VL1128	2	PZ	0H2202A1	ONE WASHING WITH STEAM VALVE SUPPORT	1	PZ	EL1440A0	WATER SELF CLEANING VALVE	1	PZ	GN1526A0	INT. D.=6.9 TH=1.8 O-RIN	3	PZ	RC1018A0	ZINC PLATED D12 ELASTIC CLAMP	1	PZ	RC1019A0	D=10 ELASTIC CLAMP	14	PZ	RC1130A0	130X2,6 CLAM	2	PZ	RC1242A0	D=10 CLOSED CAP	2	PZ	TB2820A0	6X10 EPDM PIPE FOR WASHING SYSTEM	1.410	M	TB3132A0	WHITE-BLUE EPDM TEXTILE BRAID HOSE 6X12	0.670	M	VI1220A1	4,2X12 TCB SELF-TAPPIN G SCREW	1	PZ	VL1019A0	VIBRATION PUMP	1	PZ	VL1047A1	D6 PIPE HOLDER - D8 J.G. TERMINAL	1	PZ	VL1054B0	ONE WASHING SYS INLET DISTRIBUTOR	1	PZ	VL1102A1	DETERGENT LINE FILTER + BARBED VNR 6 MM	1	PZ	VL1128A0	D6 BARBED CHECK VALVE	2	PZ
Code	Description	Qty	UOM																																																																			
0H2143A0	LAMIERA BLOCCA VNR VL1128	2	PZ																																																																			
0H2202A1	ONE WASHING WITH STEAM VALVE SUPPORT	1	PZ																																																																			
EL1440A0	WATER SELF CLEANING VALVE	1	PZ																																																																			
GN1526A0	INT. D.=6.9 TH=1.8 O-RIN	3	PZ																																																																			
RC1018A0	ZINC PLATED D12 ELASTIC CLAMP	1	PZ																																																																			
RC1019A0	D=10 ELASTIC CLAMP	14	PZ																																																																			
RC1130A0	130X2,6 CLAM	2	PZ																																																																			
RC1242A0	D=10 CLOSED CAP	2	PZ																																																																			
TB2820A0	6X10 EPDM PIPE FOR WASHING SYSTEM	1.410	M																																																																			
TB3132A0	WHITE-BLUE EPDM TEXTILE BRAID HOSE 6X12	0.670	M																																																																			
VI1220A1	4,2X12 TCB SELF-TAPPIN G SCREW	1	PZ																																																																			
VL1019A0	VIBRATION PUMP	1	PZ																																																																			
VL1047A1	D6 PIPE HOLDER - D8 J.G. TERMINAL	1	PZ																																																																			
VL1054B0	ONE WASHING SYS INLET DISTRIBUTOR	1	PZ																																																																			
VL1102A1	DETERGENT LINE FILTER + BARBED VNR 6 MM	1	PZ																																																																			
VL1128A0	D6 BARBED CHECK VALVE	2	PZ																																																																			

COMPONENT			SPARE PART																																		
Code	Description	Image	Code	Description	Components list																																
VL1166A	BB6-AR6 L FITTING		KVL1182A	ONE CLEANING SYSTEM KIT (0311 EXC.)	<table border="1"> <thead> <tr> <th>Code</th> <th>Description</th> <th>Qty</th> <th>UOM</th> </tr> </thead> <tbody> <tr> <td>VL1128A1</td> <td>D6 BARBED CHECK VALVE</td> <td>2</td> <td>PZ</td> </tr> <tr> <td>VL1165A0</td> <td>BB6-AR6 STRAIGHT FITTING</td> <td>1</td> <td>PZ</td> </tr> <tr> <td>VL1166A0</td> <td>BB6-AR6 L FITTING</td> <td>1</td> <td>PZ</td> </tr> <tr> <td>VL1174C0</td> <td>D1.2 MM CALIBRATED NOZZLE</td> <td>1</td> <td>PZ</td> </tr> <tr> <td>VL1191A0</td> <td>ONE WASHING DISTRIBUTOR OUTLETS KIT</td> <td>1</td> <td>PZ</td> </tr> <tr> <td>VM1605A0</td> <td>CLIP TWIST LOCK DIAM. 10,2-12,7 MM</td> <td>3</td> <td>PZ</td> </tr> <tr> <td>VM2172A0</td> <td>PUMP-WITH-CL RCUIT LOCKING PIN</td> <td>2</td> <td>PZ</td> </tr> </tbody> </table>	Code	Description	Qty	UOM	VL1128A1	D6 BARBED CHECK VALVE	2	PZ	VL1165A0	BB6-AR6 STRAIGHT FITTING	1	PZ	VL1166A0	BB6-AR6 L FITTING	1	PZ	VL1174C0	D1.2 MM CALIBRATED NOZZLE	1	PZ	VL1191A0	ONE WASHING DISTRIBUTOR OUTLETS KIT	1	PZ	VM1605A0	CLIP TWIST LOCK DIAM. 10,2-12,7 MM	3	PZ	VM2172A0	PUMP-WITH-CL RCUIT LOCKING PIN	2	PZ
Code	Description	Qty	UOM																																		
VL1128A1	D6 BARBED CHECK VALVE	2	PZ																																		
VL1165A0	BB6-AR6 STRAIGHT FITTING	1	PZ																																		
VL1166A0	BB6-AR6 L FITTING	1	PZ																																		
VL1174C0	D1.2 MM CALIBRATED NOZZLE	1	PZ																																		
VL1191A0	ONE WASHING DISTRIBUTOR OUTLETS KIT	1	PZ																																		
VM1605A0	CLIP TWIST LOCK DIAM. 10,2-12,7 MM	3	PZ																																		
VM2172A0	PUMP-WITH-CL RCUIT LOCKING PIN	2	PZ																																		
TB3009B	TB3132A-ONE OVEN WASHING INLET		KTB3009B	0,68M 6X12 BLUE-WHITE EPDM PIPE KIT	<table border="1"> <thead> <tr> <th>Code</th> <th>Description</th> <th>Qty</th> <th>UOM</th> </tr> </thead> <tbody> <tr> <td>TB3132A0</td> <td>WHITE-BLUE EPDM TEXTILE BRAID HOSE 6X12</td> <td>0.680</td> <td>M</td> </tr> </tbody> </table>	Code	Description	Qty	UOM	TB3132A0	WHITE-BLUE EPDM TEXTILE BRAID HOSE 6X12	0.680	M																								
Code	Description	Qty	UOM																																		
TB3132A0	WHITE-BLUE EPDM TEXTILE BRAID HOSE 6X12	0.680	M																																		
TB3004A	TB2820A L=550MM EPDM BLACK PIPE		KTB1343A	TB2820A0 6X10 EPM PIPE 3M KIT	<table border="1"> <thead> <tr> <th>Code</th> <th>Description</th> <th>Qty</th> <th>UOM</th> </tr> </thead> <tbody> <tr> <td>TB2820A0</td> <td>6X10 EPDM PIPE FOR WASHING SYSTEM</td> <td>3</td> <td>M</td> </tr> </tbody> </table>	Code	Description	Qty	UOM	TB2820A0	6X10 EPDM PIPE FOR WASHING SYSTEM	3	M																								
Code	Description	Qty	UOM																																		
TB2820A0	6X10 EPDM PIPE FOR WASHING SYSTEM	3	M																																		
TB3225B	TB2820A-TANK-WAS HYNG SYS CONNECTION		KTB1343A	TB2820A0 6X10 EPM PIPE 3M KIT	<table border="1"> <thead> <tr> <th>Code</th> <th>Description</th> <th>Qty</th> <th>UOM</th> </tr> </thead> <tbody> <tr> <td>TB2820A0</td> <td>6X10 EPDM PIPE FOR WASHING SYSTEM</td> <td>3</td> <td>M</td> </tr> </tbody> </table>	Code	Description	Qty	UOM	TB2820A0	6X10 EPDM PIPE FOR WASHING SYSTEM	3	M																								
Code	Description	Qty	UOM																																		
TB2820A0	6X10 EPDM PIPE FOR WASHING SYSTEM	3	M																																		

COMPONENT			SPARE PART																																																																		
Code	Description	Image	Code	Description	Components list																																																																
0H2202A	ONE WASHING WITH STEAM VALVE SUPPORT		0H2202A1	ONE WASHING WITH STEAM VALVE SUPPORT																																																																	
VL1019A	VIBRATION PUMP		KVL2618A	2 ROTOR ARMS ONE CLEANING SYSTEM KIT	<table border="1"> <thead> <tr> <th>Code</th> <th>Description</th> <th>Qty</th> <th>UOM</th> </tr> </thead> <tbody> <tr> <td>0H2202A1</td> <td>ONE WASHING WITH STEAM VALVE SUPPORT</td> <td>2</td> <td>PZ</td> </tr> <tr> <td>CE1030A0</td> <td>FEMALE FASTON COVER 6.3X0.8 0.5-1MMQ</td> <td>4</td> <td>PZ</td> </tr> <tr> <td>CE1395A0</td> <td>6,3 X 0,8 FEMALE FASTON</td> <td>2</td> <td>PZ</td> </tr> <tr> <td>CE1545A0</td> <td>BLUE UNIP AWG18 ST.3135 WIRE</td> <td>1</td> <td>M</td> </tr> <tr> <td>CE1570A0</td> <td>WHITE UNIP AWG18 ST.3135 WIRE</td> <td>1</td> <td>M</td> </tr> <tr> <td>CE1660A0</td> <td>6,3X0,8 FEMALE FASTON COVER</td> <td>4</td> <td>PZ</td> </tr> <tr> <td>CE1661A0</td> <td>MALE FASTON COVER 6,3X0,</td> <td>2</td> <td>PZ</td> </tr> <tr> <td>EL1020A1</td> <td>D8 INTERMEDIAT E T-SHAPED FITTING</td> <td>1</td> <td>PZ</td> </tr> <tr> <td>EL1440A0</td> <td>WATER SELF CLEANING VALVE</td> <td>2</td> <td>PZ</td> </tr> <tr> <td>GN1526A0</td> <td>INT. D.=6.9 TH=1.8 O-RIN</td> <td>6</td> <td>PZ</td> </tr> <tr> <td>IP1385A1</td> <td>CORNER POLYSTYREN E PACKING 110X80X2000</td> <td>0.500</td> <td>M</td> </tr> <tr> <td>RC1018A0</td> <td>ZINC PLATED D12 ELASTIC CLAMP</td> <td>4</td> <td>PZ</td> </tr> <tr> <td>RC1019A0</td> <td>D=10 ELASTIC CLAMP</td> <td>31</td> <td>PZ</td> </tr> <tr> <td>RC1130A0</td> <td>130X2,6 CLAM</td> <td>4</td> <td>PZ</td> </tr> <tr> <td>RC1242A0</td> <td>D=10 CLOSED CAP</td> <td>4</td> <td>PZ</td> </tr> </tbody> </table>	Code	Description	Qty	UOM	0H2202A1	ONE WASHING WITH STEAM VALVE SUPPORT	2	PZ	CE1030A0	FEMALE FASTON COVER 6.3X0.8 0.5-1MMQ	4	PZ	CE1395A0	6,3 X 0,8 FEMALE FASTON	2	PZ	CE1545A0	BLUE UNIP AWG18 ST.3135 WIRE	1	M	CE1570A0	WHITE UNIP AWG18 ST.3135 WIRE	1	M	CE1660A0	6,3X0,8 FEMALE FASTON COVER	4	PZ	CE1661A0	MALE FASTON COVER 6,3X0,	2	PZ	EL1020A1	D8 INTERMEDIAT E T-SHAPED FITTING	1	PZ	EL1440A0	WATER SELF CLEANING VALVE	2	PZ	GN1526A0	INT. D.=6.9 TH=1.8 O-RIN	6	PZ	IP1385A1	CORNER POLYSTYREN E PACKING 110X80X2000	0.500	M	RC1018A0	ZINC PLATED D12 ELASTIC CLAMP	4	PZ	RC1019A0	D=10 ELASTIC CLAMP	31	PZ	RC1130A0	130X2,6 CLAM	4	PZ	RC1242A0	D=10 CLOSED CAP	4	PZ
Code	Description	Qty	UOM																																																																		
0H2202A1	ONE WASHING WITH STEAM VALVE SUPPORT	2	PZ																																																																		
CE1030A0	FEMALE FASTON COVER 6.3X0.8 0.5-1MMQ	4	PZ																																																																		
CE1395A0	6,3 X 0,8 FEMALE FASTON	2	PZ																																																																		
CE1545A0	BLUE UNIP AWG18 ST.3135 WIRE	1	M																																																																		
CE1570A0	WHITE UNIP AWG18 ST.3135 WIRE	1	M																																																																		
CE1660A0	6,3X0,8 FEMALE FASTON COVER	4	PZ																																																																		
CE1661A0	MALE FASTON COVER 6,3X0,	2	PZ																																																																		
EL1020A1	D8 INTERMEDIAT E T-SHAPED FITTING	1	PZ																																																																		
EL1440A0	WATER SELF CLEANING VALVE	2	PZ																																																																		
GN1526A0	INT. D.=6.9 TH=1.8 O-RIN	6	PZ																																																																		
IP1385A1	CORNER POLYSTYREN E PACKING 110X80X2000	0.500	M																																																																		
RC1018A0	ZINC PLATED D12 ELASTIC CLAMP	4	PZ																																																																		
RC1019A0	D=10 ELASTIC CLAMP	31	PZ																																																																		
RC1130A0	130X2,6 CLAM	4	PZ																																																																		
RC1242A0	D=10 CLOSED CAP	4	PZ																																																																		

COMPONENT			SPARE PART																																																																																	
Code	Description	Image	Code	Description	Components list																																																																															
VL1019A	VIBRATION PUMP		KVL2618A	2 ROTOR ARMS ONE CLEANING SYSTEM KIT	<table border="1"> <thead> <tr> <th>Code</th> <th>Description</th> <th>Qty</th> <th>UOM</th> </tr> </thead> <tbody> <tr> <td>TB2820A0</td> <td>6X10 EPDM PIPE FOR WASHING SYSTEM</td> <td>2.920</td> <td>M</td> </tr> <tr> <td>TB3132A0</td> <td>WHITE-BLUE EPDM TEXTILE BRAID HOSE 6X12</td> <td>1.340</td> <td>M</td> </tr> <tr> <td>VI1220A1</td> <td>4,2X12 TCB SELF-TAPPIN G SCREW</td> <td>2</td> <td>PZ</td> </tr> <tr> <td>VL1019A0</td> <td>VIBRATION PUMP</td> <td>2</td> <td>PZ</td> </tr> <tr> <td>VL1047A1</td> <td>D6 PIPE HOLDER - D8 J.G. TERMINAL</td> <td>2</td> <td>PZ</td> </tr> <tr> <td>VL1054B0</td> <td>ONE WASHING SYS INLET DISTRIBUTOR</td> <td>2</td> <td>PZ</td> </tr> <tr> <td>VL1102A1</td> <td>DETERGENT LINE FILTER + BARBED VNR 6 MM</td> <td>2</td> <td>PZ</td> </tr> <tr> <td>VL1127A1</td> <td>6MM BARBED T-SHAPED FITTING</td> <td>1</td> <td>PZ</td> </tr> <tr> <td>VL1128A1</td> <td>D6 BARBED CHECK VALVE</td> <td>4</td> <td>PZ</td> </tr> <tr> <td>VL1165A0</td> <td>BB6-AR6 STRAIGHT FITTING</td> <td>2</td> <td>PZ</td> </tr> <tr> <td>VL1166A0</td> <td>BB6-AR6 L FITTING</td> <td>2</td> <td>PZ</td> </tr> <tr> <td>VL1174C0</td> <td>D1.2 MM CALIBRATED NOZZLE</td> <td>2</td> <td>PZ</td> </tr> <tr> <td>VL1191A0</td> <td>ONE WASHING DISTRIBUTOR OUTLETS KIT</td> <td>2</td> <td>PZ</td> </tr> <tr> <td>VM2172A0</td> <td>PUMP-WITH-CI RCUIT LOCKING PIN</td> <td>4</td> <td>PZ</td> </tr> </tbody> </table>	Code	Description	Qty	UOM	TB2820A0	6X10 EPDM PIPE FOR WASHING SYSTEM	2.920	M	TB3132A0	WHITE-BLUE EPDM TEXTILE BRAID HOSE 6X12	1.340	M	VI1220A1	4,2X12 TCB SELF-TAPPIN G SCREW	2	PZ	VL1019A0	VIBRATION PUMP	2	PZ	VL1047A1	D6 PIPE HOLDER - D8 J.G. TERMINAL	2	PZ	VL1054B0	ONE WASHING SYS INLET DISTRIBUTOR	2	PZ	VL1102A1	DETERGENT LINE FILTER + BARBED VNR 6 MM	2	PZ	VL1127A1	6MM BARBED T-SHAPED FITTING	1	PZ	VL1128A1	D6 BARBED CHECK VALVE	4	PZ	VL1165A0	BB6-AR6 STRAIGHT FITTING	2	PZ	VL1166A0	BB6-AR6 L FITTING	2	PZ	VL1174C0	D1.2 MM CALIBRATED NOZZLE	2	PZ	VL1191A0	ONE WASHING DISTRIBUTOR OUTLETS KIT	2	PZ	VM2172A0	PUMP-WITH-CI RCUIT LOCKING PIN	4	PZ	KVL1225A	US HOOD WASHING SYSTEM KIT	<table border="1"> <thead> <tr> <th>Code</th> <th>Description</th> <th>Qty</th> <th>UOM</th> </tr> </thead> <tbody> <tr> <td>0H2213A1</td> <td></td> <td>1</td> <td>PZ</td> </tr> <tr> <td>EL1450A0</td> <td>US SELF-CLEANIN G WATER SOLENOID</td> <td>2</td> <td>PZ</td> </tr> <tr> <td>GN1526A0</td> <td>INT. D.=6.9 TH=1.8 O-RIN</td> <td>5</td> <td>PZ</td> </tr> </tbody> </table>	Code	Description	Qty	UOM	0H2213A1		1	PZ	EL1450A0	US SELF-CLEANIN G WATER SOLENOID	2	PZ	GN1526A0	INT. D.=6.9 TH=1.8 O-RIN	5	PZ
			Code	Description	Qty	UOM																																																																														
TB2820A0	6X10 EPDM PIPE FOR WASHING SYSTEM	2.920	M																																																																																	
TB3132A0	WHITE-BLUE EPDM TEXTILE BRAID HOSE 6X12	1.340	M																																																																																	
VI1220A1	4,2X12 TCB SELF-TAPPIN G SCREW	2	PZ																																																																																	
VL1019A0	VIBRATION PUMP	2	PZ																																																																																	
VL1047A1	D6 PIPE HOLDER - D8 J.G. TERMINAL	2	PZ																																																																																	
VL1054B0	ONE WASHING SYS INLET DISTRIBUTOR	2	PZ																																																																																	
VL1102A1	DETERGENT LINE FILTER + BARBED VNR 6 MM	2	PZ																																																																																	
VL1127A1	6MM BARBED T-SHAPED FITTING	1	PZ																																																																																	
VL1128A1	D6 BARBED CHECK VALVE	4	PZ																																																																																	
VL1165A0	BB6-AR6 STRAIGHT FITTING	2	PZ																																																																																	
VL1166A0	BB6-AR6 L FITTING	2	PZ																																																																																	
VL1174C0	D1.2 MM CALIBRATED NOZZLE	2	PZ																																																																																	
VL1191A0	ONE WASHING DISTRIBUTOR OUTLETS KIT	2	PZ																																																																																	
VM2172A0	PUMP-WITH-CI RCUIT LOCKING PIN	4	PZ																																																																																	
Code	Description	Qty	UOM																																																																																	
0H2213A1		1	PZ																																																																																	
EL1450A0	US SELF-CLEANIN G WATER SOLENOID	2	PZ																																																																																	
GN1526A0	INT. D.=6.9 TH=1.8 O-RIN	5	PZ																																																																																	

COMPONENT			SPARE PART																																																																																		
Code	Description	Image	Code	Description	Components list																																																																																
VL1019A	VIBRATION PUMP		KVL1225A	US HOOD WASHING SYSTEM KIT	<table border="1"> <thead> <tr> <th>Code</th> <th>Description</th> <th>Qty</th> <th>UOM</th> </tr> </thead> <tbody> <tr> <td>RC1018A0</td> <td>ZINC PLATED D12 ELASTIC CLAMP</td> <td>5</td> <td>PZ</td> </tr> <tr> <td>RC1019A0</td> <td>D=10 ELASTIC CLAMP</td> <td>16</td> <td>PZ</td> </tr> <tr> <td>RC1131A0</td> <td>200X2.6 BLACK CLAMP</td> <td>1</td> <td>PZ</td> </tr> <tr> <td>RC1242A0</td> <td>D=10 CLOSED CAP</td> <td>2</td> <td>PZ</td> </tr> <tr> <td>TB2820A0</td> <td>6X10 EPDM PIPE FOR WASHING SYSTEM</td> <td>2.240</td> <td>M</td> </tr> <tr> <td>TB3132A0</td> <td>WHITE-BLUE EPDM TEXTILE BRAID HOSE 6X12</td> <td>0.440</td> <td>M</td> </tr> <tr> <td>VI1220A1</td> <td>4,2X12 TCB SELF-TAPPIN G SCREW</td> <td>3</td> <td>PZ</td> </tr> <tr> <td>VL1019A0</td> <td>VIBRATION PUMP</td> <td>1</td> <td>PZ</td> </tr> <tr> <td>VL1047A1</td> <td>D6 PIPE HOLDER - D8 J.G. TERMINAL</td> <td>1</td> <td>PZ</td> </tr> <tr> <td>VL1054B0</td> <td>ONE WASHING SYS INLET DISTRIBUTOR</td> <td>1</td> <td>PZ</td> </tr> <tr> <td>VL1102A1</td> <td>DETERGENT LINE FILTER + BARBED VNR 6 MM</td> <td>1</td> <td>PZ</td> </tr> <tr> <td>VL1127A1</td> <td>6MM BARBED T-SHAPED FITTING</td> <td>1</td> <td>PZ</td> </tr> <tr> <td>VL1128A1</td> <td>D6 BARBED CHECK VALVE</td> <td>2</td> <td>PZ</td> </tr> <tr> <td>VL1165A0</td> <td>BB6-AR6 STRAIGHT FITTING</td> <td>2</td> <td>PZ</td> </tr> <tr> <td>VL1166A0</td> <td>BB6-AR6 L FITTING</td> <td>2</td> <td>PZ</td> </tr> <tr> <td>VL1174C0</td> <td>D1.2 MM CALIBRATED NOZZLE</td> <td>1</td> <td>PZ</td> </tr> <tr> <td>VL1191A0</td> <td>ONE WASHING DISTRIBUTOR OUTLETS KIT</td> <td>1</td> <td>PZ</td> </tr> <tr> <td>VM1605A0</td> <td>CLIP TWIST LOCK DIAM. 10,2-12,7 MM</td> <td>2</td> <td>PZ</td> </tr> <tr> <td>VM2172A0</td> <td>PUMP-WITH-CI RCUIT LOCKING PIN</td> <td>5</td> <td>PZ</td> </tr> </tbody> </table>	Code	Description	Qty	UOM	RC1018A0	ZINC PLATED D12 ELASTIC CLAMP	5	PZ	RC1019A0	D=10 ELASTIC CLAMP	16	PZ	RC1131A0	200X2.6 BLACK CLAMP	1	PZ	RC1242A0	D=10 CLOSED CAP	2	PZ	TB2820A0	6X10 EPDM PIPE FOR WASHING SYSTEM	2.240	M	TB3132A0	WHITE-BLUE EPDM TEXTILE BRAID HOSE 6X12	0.440	M	VI1220A1	4,2X12 TCB SELF-TAPPIN G SCREW	3	PZ	VL1019A0	VIBRATION PUMP	1	PZ	VL1047A1	D6 PIPE HOLDER - D8 J.G. TERMINAL	1	PZ	VL1054B0	ONE WASHING SYS INLET DISTRIBUTOR	1	PZ	VL1102A1	DETERGENT LINE FILTER + BARBED VNR 6 MM	1	PZ	VL1127A1	6MM BARBED T-SHAPED FITTING	1	PZ	VL1128A1	D6 BARBED CHECK VALVE	2	PZ	VL1165A0	BB6-AR6 STRAIGHT FITTING	2	PZ	VL1166A0	BB6-AR6 L FITTING	2	PZ	VL1174C0	D1.2 MM CALIBRATED NOZZLE	1	PZ	VL1191A0	ONE WASHING DISTRIBUTOR OUTLETS KIT	1	PZ	VM1605A0	CLIP TWIST LOCK DIAM. 10,2-12,7 MM	2	PZ	VM2172A0	PUMP-WITH-CI RCUIT LOCKING PIN	5	PZ
Code	Description	Qty	UOM																																																																																		
RC1018A0	ZINC PLATED D12 ELASTIC CLAMP	5	PZ																																																																																		
RC1019A0	D=10 ELASTIC CLAMP	16	PZ																																																																																		
RC1131A0	200X2.6 BLACK CLAMP	1	PZ																																																																																		
RC1242A0	D=10 CLOSED CAP	2	PZ																																																																																		
TB2820A0	6X10 EPDM PIPE FOR WASHING SYSTEM	2.240	M																																																																																		
TB3132A0	WHITE-BLUE EPDM TEXTILE BRAID HOSE 6X12	0.440	M																																																																																		
VI1220A1	4,2X12 TCB SELF-TAPPIN G SCREW	3	PZ																																																																																		
VL1019A0	VIBRATION PUMP	1	PZ																																																																																		
VL1047A1	D6 PIPE HOLDER - D8 J.G. TERMINAL	1	PZ																																																																																		
VL1054B0	ONE WASHING SYS INLET DISTRIBUTOR	1	PZ																																																																																		
VL1102A1	DETERGENT LINE FILTER + BARBED VNR 6 MM	1	PZ																																																																																		
VL1127A1	6MM BARBED T-SHAPED FITTING	1	PZ																																																																																		
VL1128A1	D6 BARBED CHECK VALVE	2	PZ																																																																																		
VL1165A0	BB6-AR6 STRAIGHT FITTING	2	PZ																																																																																		
VL1166A0	BB6-AR6 L FITTING	2	PZ																																																																																		
VL1174C0	D1.2 MM CALIBRATED NOZZLE	1	PZ																																																																																		
VL1191A0	ONE WASHING DISTRIBUTOR OUTLETS KIT	1	PZ																																																																																		
VM1605A0	CLIP TWIST LOCK DIAM. 10,2-12,7 MM	2	PZ																																																																																		
VM2172A0	PUMP-WITH-CI RCUIT LOCKING PIN	5	PZ																																																																																		

COMPONENT			SPARE PART																																																																																		
Code	Description	Image	Code	Description	Components list																																																																																
VL1019A	VIBRATION PUMP		KVL1222A	EUR 0311 ONE PLUS CLEANING SYSTEM KIT	<table border="1"> <thead> <tr> <th>Code</th> <th>Description</th> <th>Qty</th> <th>UOM</th> </tr> </thead> <tbody> <tr> <td>0H2486A0</td> <td></td> <td>1</td> <td>PZ</td> </tr> <tr> <td>EL1440A0</td> <td>WATER SELF CLEANING VALVE</td> <td>1</td> <td>PZ</td> </tr> <tr> <td>GN1526A0</td> <td>INT. D.=6.9 TH=1.8 O-RIN</td> <td>3</td> <td>PZ</td> </tr> <tr> <td>RC1018A0</td> <td>ZINC PLATED D12 ELASTIC CLAMP</td> <td>2</td> <td>PZ</td> </tr> <tr> <td>RC1019A0</td> <td>D=10 ELASTIC CLAMP</td> <td>14</td> <td>PZ</td> </tr> <tr> <td>RC1242A0</td> <td>D=10 CLOSED CAP</td> <td>2</td> <td>PZ</td> </tr> <tr> <td>TB2820A0</td> <td>6X10 EPDM PIPE FOR WASHING SYSTEM</td> <td>1.460</td> <td>M</td> </tr> <tr> <td>TB3132A0</td> <td>WHITE-BLUE EPDM TEXTILE BRAID HOSE 6X12</td> <td>0.670</td> <td>M</td> </tr> <tr> <td>VI1220A1</td> <td>4,2X12 TCB SELF-TAPPIN G SCREW</td> <td>4</td> <td>PZ</td> </tr> <tr> <td>VL1019A0</td> <td>VIBRATION PUMP</td> <td>1</td> <td>PZ</td> </tr> <tr> <td>VL1047A1</td> <td>D6 PIPE HOLDER - D8 J.G. TERMINAL</td> <td>1</td> <td>PZ</td> </tr> <tr> <td>VL1054B0</td> <td>ONE WASHING SYS INLET DISTRIBUTOR</td> <td>1</td> <td>PZ</td> </tr> <tr> <td>VL1102A1</td> <td>DETERGENT LINE FILTER + BARBED VNR 6 MM</td> <td>1</td> <td>PZ</td> </tr> <tr> <td>VL1128A1</td> <td>D6 BARBED CHECK VALVE</td> <td>2</td> <td>PZ</td> </tr> <tr> <td>VL1165A0</td> <td>BB6-AR6 STRAIGHT FITTING</td> <td>1</td> <td>PZ</td> </tr> <tr> <td>VL1166A0</td> <td>BB6-AR6 L FITTING</td> <td>1</td> <td>PZ</td> </tr> <tr> <td>VL1174C0</td> <td>D1.2 MM CALIBRATED NOZZLE</td> <td>1</td> <td>PZ</td> </tr> <tr> <td>VL1191A0</td> <td>ONE WASHING DISTRIBUTOR OUTLETS KIT</td> <td>1</td> <td>PZ</td> </tr> <tr> <td>VM2172A0</td> <td>PUMP-WITH-CI RCUIT LOCKING PIN</td> <td>3</td> <td>PZ</td> </tr> </tbody> </table>	Code	Description	Qty	UOM	0H2486A0		1	PZ	EL1440A0	WATER SELF CLEANING VALVE	1	PZ	GN1526A0	INT. D.=6.9 TH=1.8 O-RIN	3	PZ	RC1018A0	ZINC PLATED D12 ELASTIC CLAMP	2	PZ	RC1019A0	D=10 ELASTIC CLAMP	14	PZ	RC1242A0	D=10 CLOSED CAP	2	PZ	TB2820A0	6X10 EPDM PIPE FOR WASHING SYSTEM	1.460	M	TB3132A0	WHITE-BLUE EPDM TEXTILE BRAID HOSE 6X12	0.670	M	VI1220A1	4,2X12 TCB SELF-TAPPIN G SCREW	4	PZ	VL1019A0	VIBRATION PUMP	1	PZ	VL1047A1	D6 PIPE HOLDER - D8 J.G. TERMINAL	1	PZ	VL1054B0	ONE WASHING SYS INLET DISTRIBUTOR	1	PZ	VL1102A1	DETERGENT LINE FILTER + BARBED VNR 6 MM	1	PZ	VL1128A1	D6 BARBED CHECK VALVE	2	PZ	VL1165A0	BB6-AR6 STRAIGHT FITTING	1	PZ	VL1166A0	BB6-AR6 L FITTING	1	PZ	VL1174C0	D1.2 MM CALIBRATED NOZZLE	1	PZ	VL1191A0	ONE WASHING DISTRIBUTOR OUTLETS KIT	1	PZ	VM2172A0	PUMP-WITH-CI RCUIT LOCKING PIN	3	PZ
Code	Description	Qty	UOM																																																																																		
0H2486A0		1	PZ																																																																																		
EL1440A0	WATER SELF CLEANING VALVE	1	PZ																																																																																		
GN1526A0	INT. D.=6.9 TH=1.8 O-RIN	3	PZ																																																																																		
RC1018A0	ZINC PLATED D12 ELASTIC CLAMP	2	PZ																																																																																		
RC1019A0	D=10 ELASTIC CLAMP	14	PZ																																																																																		
RC1242A0	D=10 CLOSED CAP	2	PZ																																																																																		
TB2820A0	6X10 EPDM PIPE FOR WASHING SYSTEM	1.460	M																																																																																		
TB3132A0	WHITE-BLUE EPDM TEXTILE BRAID HOSE 6X12	0.670	M																																																																																		
VI1220A1	4,2X12 TCB SELF-TAPPIN G SCREW	4	PZ																																																																																		
VL1019A0	VIBRATION PUMP	1	PZ																																																																																		
VL1047A1	D6 PIPE HOLDER - D8 J.G. TERMINAL	1	PZ																																																																																		
VL1054B0	ONE WASHING SYS INLET DISTRIBUTOR	1	PZ																																																																																		
VL1102A1	DETERGENT LINE FILTER + BARBED VNR 6 MM	1	PZ																																																																																		
VL1128A1	D6 BARBED CHECK VALVE	2	PZ																																																																																		
VL1165A0	BB6-AR6 STRAIGHT FITTING	1	PZ																																																																																		
VL1166A0	BB6-AR6 L FITTING	1	PZ																																																																																		
VL1174C0	D1.2 MM CALIBRATED NOZZLE	1	PZ																																																																																		
VL1191A0	ONE WASHING DISTRIBUTOR OUTLETS KIT	1	PZ																																																																																		
VM2172A0	PUMP-WITH-CI RCUIT LOCKING PIN	3	PZ																																																																																		





COMPONENT			SPARE PART																																																																																		
Code	Description	Image	Code	Description	Components list																																																																																
VL1019A	VIBRATION PUMP		KVL1213A	US PLUS COMPACT WASHING SYSTEM KIT	<table border="1"> <thead> <tr> <th>Code</th> <th>Description</th> <th>Qty</th> <th>UOM</th> </tr> </thead> <tbody> <tr> <td>0H2428A0</td> <td></td> <td>1</td> <td>PZ</td> </tr> <tr> <td>EL1450A0</td> <td>US SELF-CLEANING WATER SOLENOID</td> <td>3</td> <td>PZ</td> </tr> <tr> <td>GN1312A0</td> <td>RUBBER CABLE-PASSING DE=26 DI=15 SP=10</td> <td>1</td> <td>PZ</td> </tr> <tr> <td>GN1526A0</td> <td>INT. D.=6.9 TH=1.8 O-RING</td> <td>7</td> <td>PZ</td> </tr> <tr> <td>RC1018A0</td> <td>ZINC PLATED D12 ELASTIC CLAMP</td> <td>3</td> <td>PZ</td> </tr> <tr> <td>RC1019A0</td> <td>D=10 ELASTIC CLAMP</td> <td>14</td> <td>PZ</td> </tr> <tr> <td>RC1130A0</td> <td>130X2,6 CLAMP</td> <td>1</td> <td>PZ</td> </tr> <tr> <td>RC1131A0</td> <td>200X2,6 BLACK CLAMP</td> <td>1</td> <td>PZ</td> </tr> <tr> <td>RC1242A0</td> <td>D=10 CLOSED CAP</td> <td>2</td> <td>PZ</td> </tr> <tr> <td>RC1356A0</td> <td>"STRAIGHT THREADED FEMALE END 8X1/4" BS</td> <td>1</td> <td>PZ</td> </tr> <tr> <td>TB2820A0</td> <td>6X10 EPDM PIPE FOR WASHING SYSTEM</td> <td>0.790</td> <td>M</td> </tr> <tr> <td>TB3132A0</td> <td>WHITE-BLUE EPDM TEXTILE BRAID HOSE 6X12</td> <td>1.400</td> <td>M</td> </tr> <tr> <td>VI1220A1</td> <td>4,2X12 TCB SELF-TAPPING SCREW</td> <td>3</td> <td>PZ</td> </tr> <tr> <td>VL1019A0</td> <td>VIBRATION PUMP</td> <td>1</td> <td>PZ</td> </tr> <tr> <td>VL1047A1</td> <td>D6 PIPE HOLDER - D6 J.G. TERMINAL</td> <td>1</td> <td>PZ</td> </tr> <tr> <td>VL1054B0</td> <td>ONE WASHING SYSTEM INLET DISTRIBUTOR</td> <td>1</td> <td>PZ</td> </tr> <tr> <td>VL1065A1</td> <td>1/4 MALE N.O. PRESSURE SWITCH</td> <td>1</td> <td>PZ</td> </tr> <tr> <td>VL1102A1</td> <td>DETERGENT LINE FILTER + BARBED VNR 6 MM</td> <td>1</td> <td>PZ</td> </tr> <tr> <td>VL1128A1</td> <td>D6 BARBED CHECK VALVE</td> <td>2</td> <td>PZ</td> </tr> </tbody> </table>	Code	Description	Qty	UOM	0H2428A0		1	PZ	EL1450A0	US SELF-CLEANING WATER SOLENOID	3	PZ	GN1312A0	RUBBER CABLE-PASSING DE=26 DI=15 SP=10	1	PZ	GN1526A0	INT. D.=6.9 TH=1.8 O-RING	7	PZ	RC1018A0	ZINC PLATED D12 ELASTIC CLAMP	3	PZ	RC1019A0	D=10 ELASTIC CLAMP	14	PZ	RC1130A0	130X2,6 CLAMP	1	PZ	RC1131A0	200X2,6 BLACK CLAMP	1	PZ	RC1242A0	D=10 CLOSED CAP	2	PZ	RC1356A0	"STRAIGHT THREADED FEMALE END 8X1/4" BS	1	PZ	TB2820A0	6X10 EPDM PIPE FOR WASHING SYSTEM	0.790	M	TB3132A0	WHITE-BLUE EPDM TEXTILE BRAID HOSE 6X12	1.400	M	VI1220A1	4,2X12 TCB SELF-TAPPING SCREW	3	PZ	VL1019A0	VIBRATION PUMP	1	PZ	VL1047A1	D6 PIPE HOLDER - D6 J.G. TERMINAL	1	PZ	VL1054B0	ONE WASHING SYSTEM INLET DISTRIBUTOR	1	PZ	VL1065A1	1/4 MALE N.O. PRESSURE SWITCH	1	PZ	VL1102A1	DETERGENT LINE FILTER + BARBED VNR 6 MM	1	PZ	VL1128A1	D6 BARBED CHECK VALVE	2	PZ
Code	Description	Qty	UOM																																																																																		
0H2428A0		1	PZ																																																																																		
EL1450A0	US SELF-CLEANING WATER SOLENOID	3	PZ																																																																																		
GN1312A0	RUBBER CABLE-PASSING DE=26 DI=15 SP=10	1	PZ																																																																																		
GN1526A0	INT. D.=6.9 TH=1.8 O-RING	7	PZ																																																																																		
RC1018A0	ZINC PLATED D12 ELASTIC CLAMP	3	PZ																																																																																		
RC1019A0	D=10 ELASTIC CLAMP	14	PZ																																																																																		
RC1130A0	130X2,6 CLAMP	1	PZ																																																																																		
RC1131A0	200X2,6 BLACK CLAMP	1	PZ																																																																																		
RC1242A0	D=10 CLOSED CAP	2	PZ																																																																																		
RC1356A0	"STRAIGHT THREADED FEMALE END 8X1/4" BS	1	PZ																																																																																		
TB2820A0	6X10 EPDM PIPE FOR WASHING SYSTEM	0.790	M																																																																																		
TB3132A0	WHITE-BLUE EPDM TEXTILE BRAID HOSE 6X12	1.400	M																																																																																		
VI1220A1	4,2X12 TCB SELF-TAPPING SCREW	3	PZ																																																																																		
VL1019A0	VIBRATION PUMP	1	PZ																																																																																		
VL1047A1	D6 PIPE HOLDER - D6 J.G. TERMINAL	1	PZ																																																																																		
VL1054B0	ONE WASHING SYSTEM INLET DISTRIBUTOR	1	PZ																																																																																		
VL1065A1	1/4 MALE N.O. PRESSURE SWITCH	1	PZ																																																																																		
VL1102A1	DETERGENT LINE FILTER + BARBED VNR 6 MM	1	PZ																																																																																		
VL1128A1	D6 BARBED CHECK VALVE	2	PZ																																																																																		

COMPONENT			SPARE PART																																																															
Code	Description	Image	Code	Description	Components list																																																													
VL1019A	VIBRATION PUMP		KVL1213A	US PLUS COMPACT WASHING SYSTEM KIT	<table border="1"> <thead> <tr> <th>Code</th> <th>Description</th> <th>Qty</th> <th>UOM</th> </tr> </thead> <tbody> <tr> <td>VL1165A0</td> <td>BB6-AR6 STRAIGHT FITTING</td> <td>1</td> <td>PZ</td> </tr> <tr> <td>VL1166A0</td> <td>BB6-AR6 L FITTING</td> <td>3</td> <td>PZ</td> </tr> <tr> <td>VL1174C0</td> <td>D1.2 MM CALIBRATED NOZZLE</td> <td>1</td> <td>PZ</td> </tr> <tr> <td>VL1185A0</td> <td>2 WAYS PLUS WASHING DISTRIBUTOR</td> <td>1</td> <td>PZ</td> </tr> <tr> <td>VM2172A0</td> <td>PUMP-WITH-CI RCUIT LOCKING PIN</td> <td>6</td> <td>PZ</td> </tr> </tbody> </table>	Code	Description	Qty	UOM	VL1165A0	BB6-AR6 STRAIGHT FITTING	1	PZ	VL1166A0	BB6-AR6 L FITTING	3	PZ	VL1174C0	D1.2 MM CALIBRATED NOZZLE	1	PZ	VL1185A0	2 WAYS PLUS WASHING DISTRIBUTOR	1	PZ	VM2172A0	PUMP-WITH-CI RCUIT LOCKING PIN	6	PZ																																					
			Code	Description	Qty	UOM																																																												
VL1165A0	BB6-AR6 STRAIGHT FITTING	1	PZ																																																															
VL1166A0	BB6-AR6 L FITTING	3	PZ																																																															
VL1174C0	D1.2 MM CALIBRATED NOZZLE	1	PZ																																																															
VL1185A0	2 WAYS PLUS WASHING DISTRIBUTOR	1	PZ																																																															
VM2172A0	PUMP-WITH-CI RCUIT LOCKING PIN	6	PZ																																																															
KVL1212A	EUR COMPACT PLUS CLEANING SYSTEM KIT	<table border="1"> <thead> <tr> <th>Code</th> <th>Description</th> <th>Qty</th> <th>UOM</th> </tr> </thead> <tbody> <tr> <td>0H2428A0</td> <td></td> <td>1</td> <td>PZ</td> </tr> <tr> <td>EL1440A0</td> <td>WATER SELF CLEANING VALVE</td> <td>3</td> <td>PZ</td> </tr> <tr> <td>GN1312A0</td> <td>RUBBER CABLE-PASSI NG DE=26 DI=15 SP=10</td> <td>1</td> <td>PZ</td> </tr> <tr> <td>GN1526A0</td> <td>INT. D.=6.9 TH=1.8 O-RING</td> <td>7</td> <td>PZ</td> </tr> <tr> <td>RC1018A0</td> <td>ZINC PLATED D12 ELASTIC CLAMP</td> <td>3</td> <td>PZ</td> </tr> <tr> <td>RC1019A0</td> <td>D=10 ELASTIC CLAMP</td> <td>14</td> <td>PZ</td> </tr> <tr> <td>RC1130A0</td> <td>130X2,6 CLAM</td> <td>1</td> <td>PZ</td> </tr> <tr> <td>RC1131A0</td> <td>200X2.6 BLACK CLAMP</td> <td>1</td> <td>PZ</td> </tr> <tr> <td>RC1242A0</td> <td>D=10 CLOSED CAP</td> <td>2</td> <td>PZ</td> </tr> <tr> <td>RC1356A0</td> <td>"STRAIGHT THREADED FEMALE END 8X1/4" BS</td> <td>1</td> <td>PZ</td> </tr> <tr> <td>TB2820A0</td> <td>6X10 EPDM PIPE FOR WASHING SYSTEM</td> <td>1.340</td> <td>M</td> </tr> <tr> <td>TB3132A0</td> <td>WHITE-BLUE EPDM TEXTILE BRAID HOSE 6X12</td> <td>1.400</td> <td>M</td> </tr> <tr> <td>VI1220A1</td> <td>4,2X12 TCB SELF-TAPPING SCREW</td> <td>3</td> <td>PZ</td> </tr> <tr> <td>VL1019A0</td> <td>VIBRATION PUMP</td> <td>1</td> <td>PZ</td> </tr> <tr> <td>VL1047A1</td> <td>D6 PIPE HOLDER - D8 J.G. TERMINAL</td> <td>1</td> <td>PZ</td> </tr> </tbody> </table>	Code	Description	Qty	UOM	0H2428A0		1	PZ	EL1440A0	WATER SELF CLEANING VALVE	3	PZ	GN1312A0	RUBBER CABLE-PASSI NG DE=26 DI=15 SP=10	1	PZ	GN1526A0	INT. D.=6.9 TH=1.8 O-RING	7	PZ	RC1018A0	ZINC PLATED D12 ELASTIC CLAMP	3	PZ	RC1019A0	D=10 ELASTIC CLAMP	14	PZ	RC1130A0	130X2,6 CLAM	1	PZ	RC1131A0	200X2.6 BLACK CLAMP	1	PZ	RC1242A0	D=10 CLOSED CAP	2	PZ	RC1356A0	"STRAIGHT THREADED FEMALE END 8X1/4" BS	1	PZ	TB2820A0	6X10 EPDM PIPE FOR WASHING SYSTEM	1.340	M	TB3132A0	WHITE-BLUE EPDM TEXTILE BRAID HOSE 6X12	1.400	M	VI1220A1	4,2X12 TCB SELF-TAPPING SCREW	3	PZ	VL1019A0	VIBRATION PUMP	1	PZ	VL1047A1	D6 PIPE HOLDER - D8 J.G. TERMINAL	1	PZ
Code	Description	Qty	UOM																																																															
0H2428A0		1	PZ																																																															
EL1440A0	WATER SELF CLEANING VALVE	3	PZ																																																															
GN1312A0	RUBBER CABLE-PASSI NG DE=26 DI=15 SP=10	1	PZ																																																															
GN1526A0	INT. D.=6.9 TH=1.8 O-RING	7	PZ																																																															
RC1018A0	ZINC PLATED D12 ELASTIC CLAMP	3	PZ																																																															
RC1019A0	D=10 ELASTIC CLAMP	14	PZ																																																															
RC1130A0	130X2,6 CLAM	1	PZ																																																															
RC1131A0	200X2.6 BLACK CLAMP	1	PZ																																																															
RC1242A0	D=10 CLOSED CAP	2	PZ																																																															
RC1356A0	"STRAIGHT THREADED FEMALE END 8X1/4" BS	1	PZ																																																															
TB2820A0	6X10 EPDM PIPE FOR WASHING SYSTEM	1.340	M																																																															
TB3132A0	WHITE-BLUE EPDM TEXTILE BRAID HOSE 6X12	1.400	M																																																															
VI1220A1	4,2X12 TCB SELF-TAPPING SCREW	3	PZ																																																															
VL1019A0	VIBRATION PUMP	1	PZ																																																															
VL1047A1	D6 PIPE HOLDER - D8 J.G. TERMINAL	1	PZ																																																															

COMPONENT			SPARE PART																																																		
Code	Description	Image	Code	Description	Components list																																																
VL1019A	VIBRATION PUMP		KVL1212A	EUR COMPACT PLUS CLEANING SYSTEM KIT	<table border="1"> <thead> <tr> <th>Code</th> <th>Description</th> <th>Qty</th> <th>UOM</th> </tr> </thead> <tbody> <tr> <td>VL1054B0</td> <td>ONE WASHING SYS INLET DISTRIBUTOR</td> <td>1</td> <td>PZ</td> </tr> <tr> <td>VL1065A1</td> <td>1/4 MALE N.O. PRESSURE SWITCH</td> <td>1</td> <td>PZ</td> </tr> <tr> <td>VL1102A1</td> <td>DETERGENT LINE FILTER + BARBED VNR 6 MM</td> <td>1</td> <td>PZ</td> </tr> <tr> <td>VL1128A1</td> <td>D6 BARBED CHECK VALVE</td> <td>2</td> <td>PZ</td> </tr> <tr> <td>VL1165A0</td> <td>BB6-AR6 STRAIGHT FITTING</td> <td>1</td> <td>PZ</td> </tr> <tr> <td>VL1166A0</td> <td>BB6-AR6 L FITTING</td> <td>3</td> <td>PZ</td> </tr> <tr> <td>VL1174C0</td> <td>D1.2 MM CALIBRATED NOZZLE</td> <td>1</td> <td>PZ</td> </tr> <tr> <td>VL1185A0</td> <td>2 WAYS PLUS WASHING DISTRIBUTOR</td> <td>1</td> <td>PZ</td> </tr> <tr> <td>VM2172A0</td> <td>PUMP-WITH-CI RCUIT LOCKING PIN</td> <td>6</td> <td>PZ</td> </tr> </tbody> </table>	Code	Description	Qty	UOM	VL1054B0	ONE WASHING SYS INLET DISTRIBUTOR	1	PZ	VL1065A1	1/4 MALE N.O. PRESSURE SWITCH	1	PZ	VL1102A1	DETERGENT LINE FILTER + BARBED VNR 6 MM	1	PZ	VL1128A1	D6 BARBED CHECK VALVE	2	PZ	VL1165A0	BB6-AR6 STRAIGHT FITTING	1	PZ	VL1166A0	BB6-AR6 L FITTING	3	PZ	VL1174C0	D1.2 MM CALIBRATED NOZZLE	1	PZ	VL1185A0	2 WAYS PLUS WASHING DISTRIBUTOR	1	PZ	VM2172A0	PUMP-WITH-CI RCUIT LOCKING PIN	6	PZ								
Code	Description	Qty	UOM																																																		
VL1054B0	ONE WASHING SYS INLET DISTRIBUTOR	1	PZ																																																		
VL1065A1	1/4 MALE N.O. PRESSURE SWITCH	1	PZ																																																		
VL1102A1	DETERGENT LINE FILTER + BARBED VNR 6 MM	1	PZ																																																		
VL1128A1	D6 BARBED CHECK VALVE	2	PZ																																																		
VL1165A0	BB6-AR6 STRAIGHT FITTING	1	PZ																																																		
VL1166A0	BB6-AR6 L FITTING	3	PZ																																																		
VL1174C0	D1.2 MM CALIBRATED NOZZLE	1	PZ																																																		
VL1185A0	2 WAYS PLUS WASHING DISTRIBUTOR	1	PZ																																																		
VM2172A0	PUMP-WITH-CI RCUIT LOCKING PIN	6	PZ																																																		
			KVL1211A	ONE COMPACT AND 0523-EP WASH. SYSTEM KIT	<table border="1"> <thead> <tr> <th>Code</th> <th>Description</th> <th>Qty</th> <th>UOM</th> </tr> </thead> <tbody> <tr> <td>0H2427A0</td> <td></td> <td>1</td> <td>PZ</td> </tr> <tr> <td>EL1440A0</td> <td>WATER SELF CLEANING VALVE</td> <td>1</td> <td>PZ</td> </tr> <tr> <td>GN1526A0</td> <td>INT. D.=6.9 TH=1.8 O-RIN</td> <td>3</td> <td>PZ</td> </tr> <tr> <td>RC1018A0</td> <td>ZINC PLATED D12 ELASTIC CLAMP</td> <td>2</td> <td>PZ</td> </tr> <tr> <td>RC1019A0</td> <td>D=10 ELASTIC CLAMP</td> <td>14</td> <td>PZ</td> </tr> <tr> <td>RC1130A0</td> <td>130X2,6 CLAM</td> <td>1</td> <td>PZ</td> </tr> <tr> <td>RC1242A0</td> <td>D=10 CLOSED CAP</td> <td>2</td> <td>PZ</td> </tr> <tr> <td>TB2820A0</td> <td>6X10 EPDM PIPE FOR WASHING SYSTEM</td> <td>1.290</td> <td>M</td> </tr> <tr> <td>TB3132A0</td> <td>WHITE-BLUE EPDM TEXTILE BRAID HOSE 6X12</td> <td>0.670</td> <td>M</td> </tr> <tr> <td>VI1220A1</td> <td>4,2X12 TCB SELF-TAPPIN G SCREW</td> <td>4</td> <td>PZ</td> </tr> <tr> <td>VL1019A0</td> <td>VIBRATION PUMP</td> <td>1</td> <td>PZ</td> </tr> </tbody> </table>	Code	Description	Qty	UOM	0H2427A0		1	PZ	EL1440A0	WATER SELF CLEANING VALVE	1	PZ	GN1526A0	INT. D.=6.9 TH=1.8 O-RIN	3	PZ	RC1018A0	ZINC PLATED D12 ELASTIC CLAMP	2	PZ	RC1019A0	D=10 ELASTIC CLAMP	14	PZ	RC1130A0	130X2,6 CLAM	1	PZ	RC1242A0	D=10 CLOSED CAP	2	PZ	TB2820A0	6X10 EPDM PIPE FOR WASHING SYSTEM	1.290	M	TB3132A0	WHITE-BLUE EPDM TEXTILE BRAID HOSE 6X12	0.670	M	VI1220A1	4,2X12 TCB SELF-TAPPIN G SCREW	4	PZ	VL1019A0	VIBRATION PUMP	1	PZ
Code	Description	Qty	UOM																																																		
0H2427A0		1	PZ																																																		
EL1440A0	WATER SELF CLEANING VALVE	1	PZ																																																		
GN1526A0	INT. D.=6.9 TH=1.8 O-RIN	3	PZ																																																		
RC1018A0	ZINC PLATED D12 ELASTIC CLAMP	2	PZ																																																		
RC1019A0	D=10 ELASTIC CLAMP	14	PZ																																																		
RC1130A0	130X2,6 CLAM	1	PZ																																																		
RC1242A0	D=10 CLOSED CAP	2	PZ																																																		
TB2820A0	6X10 EPDM PIPE FOR WASHING SYSTEM	1.290	M																																																		
TB3132A0	WHITE-BLUE EPDM TEXTILE BRAID HOSE 6X12	0.670	M																																																		
VI1220A1	4,2X12 TCB SELF-TAPPIN G SCREW	4	PZ																																																		
VL1019A0	VIBRATION PUMP	1	PZ																																																		

COMPONENT			SPARE PART																																														
Code	Description	Image	Code	Description	Components list																																												
VL1019A	VIBRATION PUMP		KVL1211A	ONE COMPACT AND 0523-EP WASH. SYSTEM KIT	<table border="1"> <thead> <tr> <th>Code</th> <th>Description</th> <th>Qty</th> <th>UOM</th> </tr> </thead> <tbody> <tr> <td>VL1047A1</td> <td>D6 PIPE HOLDER - D8 J.G. TERMINAL</td> <td>1</td> <td>PZ</td> </tr> <tr> <td>VL1054B0</td> <td>ONE WASHING SYS INLET DISTRIBUTOR</td> <td>1</td> <td>PZ</td> </tr> <tr> <td>VL1102A1</td> <td>DETERGENT LINE FILTER + BARBED VNR 6 MM</td> <td>1</td> <td>PZ</td> </tr> <tr> <td>VL1128A1</td> <td>D6 BARBED CHECK VALVE</td> <td>2</td> <td>PZ</td> </tr> <tr> <td>VL1165A0</td> <td>BB6-AR6 STRAIGHT FITTING</td> <td>1</td> <td>PZ</td> </tr> <tr> <td>VL1166A0</td> <td>BB6-AR6 L FITTING</td> <td>1</td> <td>PZ</td> </tr> <tr> <td>VL1174C0</td> <td>D1.2 MM CALIBRATED NOZZLE</td> <td>1</td> <td>PZ</td> </tr> <tr> <td>VL1191A0</td> <td>ONE WASHING DISTRIBUTOR OUTLETS KIT</td> <td>1</td> <td>PZ</td> </tr> <tr> <td>VM2172A0</td> <td>PUMP-WITH-CI RCUIT LOCKING PIN</td> <td>3</td> <td>PZ</td> </tr> </tbody> </table>	Code	Description	Qty	UOM	VL1047A1	D6 PIPE HOLDER - D8 J.G. TERMINAL	1	PZ	VL1054B0	ONE WASHING SYS INLET DISTRIBUTOR	1	PZ	VL1102A1	DETERGENT LINE FILTER + BARBED VNR 6 MM	1	PZ	VL1128A1	D6 BARBED CHECK VALVE	2	PZ	VL1165A0	BB6-AR6 STRAIGHT FITTING	1	PZ	VL1166A0	BB6-AR6 L FITTING	1	PZ	VL1174C0	D1.2 MM CALIBRATED NOZZLE	1	PZ	VL1191A0	ONE WASHING DISTRIBUTOR OUTLETS KIT	1	PZ	VM2172A0	PUMP-WITH-CI RCUIT LOCKING PIN	3	PZ				
Code	Description	Qty	UOM																																														
VL1047A1	D6 PIPE HOLDER - D8 J.G. TERMINAL	1	PZ																																														
VL1054B0	ONE WASHING SYS INLET DISTRIBUTOR	1	PZ																																														
VL1102A1	DETERGENT LINE FILTER + BARBED VNR 6 MM	1	PZ																																														
VL1128A1	D6 BARBED CHECK VALVE	2	PZ																																														
VL1165A0	BB6-AR6 STRAIGHT FITTING	1	PZ																																														
VL1166A0	BB6-AR6 L FITTING	1	PZ																																														
VL1174C0	D1.2 MM CALIBRATED NOZZLE	1	PZ																																														
VL1191A0	ONE WASHING DISTRIBUTOR OUTLETS KIT	1	PZ																																														
VM2172A0	PUMP-WITH-CI RCUIT LOCKING PIN	3	PZ																																														
			KVL1208A	US PLUS 2 ROTOR ARMS WASHING SYSTEM KIT	<table border="1"> <thead> <tr> <th>Code</th> <th>Description</th> <th>Qty</th> <th>UOM</th> </tr> </thead> <tbody> <tr> <td>0H2354A0</td> <td>XEVC-XEVL WASHING CIRCUIT PLAT</td> <td>1</td> <td>PZ</td> </tr> <tr> <td>0H2411A0</td> <td></td> <td>1</td> <td>PZ</td> </tr> <tr> <td>EL1450A0</td> <td>US SELF-CLEANIN G WATER SOLENOID</td> <td>4</td> <td>PZ</td> </tr> <tr> <td>GN1526A0</td> <td>INT. D.=6.9 TH=1.8 O-RIN</td> <td>9</td> <td>PZ</td> </tr> <tr> <td>RC1018A0</td> <td>ZINC PLATED D12 ELASTIC CLAMP</td> <td>4</td> <td>PZ</td> </tr> <tr> <td>RC1019A0</td> <td>D=10 ELASTIC CLAMP</td> <td>16</td> <td>PZ</td> </tr> <tr> <td>RC1130A0</td> <td>130X2.6 CLAM</td> <td>1</td> <td>PZ</td> </tr> <tr> <td>RC1131A0</td> <td>200X2.6 BLACK CLAMP</td> <td>3</td> <td>PZ</td> </tr> <tr> <td>RC1242A0</td> <td>D=10 CLOSED CAP</td> <td>2</td> <td>PZ</td> </tr> <tr> <td>RC1356A0</td> <td>"STRAIGHT THREADED FEMALE END 8X1/4" BS</td> <td>1</td> <td>PZ</td> </tr> </tbody> </table>	Code	Description	Qty	UOM	0H2354A0	XEVC-XEVL WASHING CIRCUIT PLAT	1	PZ	0H2411A0		1	PZ	EL1450A0	US SELF-CLEANIN G WATER SOLENOID	4	PZ	GN1526A0	INT. D.=6.9 TH=1.8 O-RIN	9	PZ	RC1018A0	ZINC PLATED D12 ELASTIC CLAMP	4	PZ	RC1019A0	D=10 ELASTIC CLAMP	16	PZ	RC1130A0	130X2.6 CLAM	1	PZ	RC1131A0	200X2.6 BLACK CLAMP	3	PZ	RC1242A0	D=10 CLOSED CAP	2	PZ	RC1356A0	"STRAIGHT THREADED FEMALE END 8X1/4" BS	1	PZ
Code	Description	Qty	UOM																																														
0H2354A0	XEVC-XEVL WASHING CIRCUIT PLAT	1	PZ																																														
0H2411A0		1	PZ																																														
EL1450A0	US SELF-CLEANIN G WATER SOLENOID	4	PZ																																														
GN1526A0	INT. D.=6.9 TH=1.8 O-RIN	9	PZ																																														
RC1018A0	ZINC PLATED D12 ELASTIC CLAMP	4	PZ																																														
RC1019A0	D=10 ELASTIC CLAMP	16	PZ																																														
RC1130A0	130X2.6 CLAM	1	PZ																																														
RC1131A0	200X2.6 BLACK CLAMP	3	PZ																																														
RC1242A0	D=10 CLOSED CAP	2	PZ																																														
RC1356A0	"STRAIGHT THREADED FEMALE END 8X1/4" BS	1	PZ																																														

COMPONENT			SPARE PART																																																																						
Code	Description	Image	Code	Description	Components list																																																																				
VL1019A	VIBRATION PUMP		KVL1208A	US PLUS 2 ROTOR ARMS WASHING SYSTEM KIT	<table border="1"> <thead> <tr> <th>Code</th> <th>Description</th> <th>Qty</th> <th>UOM</th> </tr> </thead> <tbody> <tr> <td>TB2820A0</td> <td>6X10 EPDM PIPE FOR WASHING SYSTEM</td> <td>2.890</td> <td>M</td> </tr> <tr> <td>TB3132A0</td> <td>WHITE-BLUE EPDM TEXTILE BRAID HOSE 6X12</td> <td>1.600</td> <td>M</td> </tr> <tr> <td>VI1220A1</td> <td>4,2X12 TCB SELF-TAPPING SCREW</td> <td>3</td> <td>PZ</td> </tr> <tr> <td>VL1019A0</td> <td>VIBRATION PUMP</td> <td>1</td> <td>PZ</td> </tr> <tr> <td>VL1047A1</td> <td>D6 PIPE HOLDER - D8 J.G. TERMINAL</td> <td>1</td> <td>PZ</td> </tr> <tr> <td>VL1065A1</td> <td>1/4 MALE N.O. PRESSURE SWITCH</td> <td>1</td> <td>PZ</td> </tr> <tr> <td>VL1102A1</td> <td>DETERGENT LINE FILTER + BARBED VNR 6 MM</td> <td>1</td> <td>PZ</td> </tr> <tr> <td>VL1128A1</td> <td>D6 BARBED CHECK VALVE</td> <td>2</td> <td>PZ</td> </tr> <tr> <td>VL1141A1</td> <td>STRAIGHT CONNECT BB6-BB6</td> <td>1</td> <td>PZ</td> </tr> <tr> <td>VL1165A0</td> <td>BB6-AR6 STRAIGHT FITTING</td> <td>1</td> <td>PZ</td> </tr> <tr> <td>VL1166A0</td> <td>BB6-AR6 L FITTING</td> <td>4</td> <td>PZ</td> </tr> <tr> <td>VL1174C0</td> <td>D1.2 MM CALIBRATED NOZZLE</td> <td>1</td> <td>PZ</td> </tr> <tr> <td>VL1186A0</td> <td>3 WAYS PLUS WASHING DISTRIBUTOR</td> <td>1</td> <td>PZ</td> </tr> <tr> <td>VL1190A0</td> <td>PLUS WASHING SYSTEM INLET DISTRIBUTOR</td> <td>1</td> <td>PZ</td> </tr> <tr> <td>VM1605A0</td> <td>CLIP TWIST LOCK DIAM. 10,2-12,7 MM</td> <td>6</td> <td>PZ</td> </tr> <tr> <td>VM2172A0</td> <td>PUMP-WITH-CLIP RCUIT LOCKING PIN</td> <td>9</td> <td>PZ</td> </tr> </tbody> </table>	Code	Description	Qty	UOM	TB2820A0	6X10 EPDM PIPE FOR WASHING SYSTEM	2.890	M	TB3132A0	WHITE-BLUE EPDM TEXTILE BRAID HOSE 6X12	1.600	M	VI1220A1	4,2X12 TCB SELF-TAPPING SCREW	3	PZ	VL1019A0	VIBRATION PUMP	1	PZ	VL1047A1	D6 PIPE HOLDER - D8 J.G. TERMINAL	1	PZ	VL1065A1	1/4 MALE N.O. PRESSURE SWITCH	1	PZ	VL1102A1	DETERGENT LINE FILTER + BARBED VNR 6 MM	1	PZ	VL1128A1	D6 BARBED CHECK VALVE	2	PZ	VL1141A1	STRAIGHT CONNECT BB6-BB6	1	PZ	VL1165A0	BB6-AR6 STRAIGHT FITTING	1	PZ	VL1166A0	BB6-AR6 L FITTING	4	PZ	VL1174C0	D1.2 MM CALIBRATED NOZZLE	1	PZ	VL1186A0	3 WAYS PLUS WASHING DISTRIBUTOR	1	PZ	VL1190A0	PLUS WASHING SYSTEM INLET DISTRIBUTOR	1	PZ	VM1605A0	CLIP TWIST LOCK DIAM. 10,2-12,7 MM	6	PZ	VM2172A0	PUMP-WITH-CLIP RCUIT LOCKING PIN	9	PZ
Code	Description	Qty	UOM																																																																						
TB2820A0	6X10 EPDM PIPE FOR WASHING SYSTEM	2.890	M																																																																						
TB3132A0	WHITE-BLUE EPDM TEXTILE BRAID HOSE 6X12	1.600	M																																																																						
VI1220A1	4,2X12 TCB SELF-TAPPING SCREW	3	PZ																																																																						
VL1019A0	VIBRATION PUMP	1	PZ																																																																						
VL1047A1	D6 PIPE HOLDER - D8 J.G. TERMINAL	1	PZ																																																																						
VL1065A1	1/4 MALE N.O. PRESSURE SWITCH	1	PZ																																																																						
VL1102A1	DETERGENT LINE FILTER + BARBED VNR 6 MM	1	PZ																																																																						
VL1128A1	D6 BARBED CHECK VALVE	2	PZ																																																																						
VL1141A1	STRAIGHT CONNECT BB6-BB6	1	PZ																																																																						
VL1165A0	BB6-AR6 STRAIGHT FITTING	1	PZ																																																																						
VL1166A0	BB6-AR6 L FITTING	4	PZ																																																																						
VL1174C0	D1.2 MM CALIBRATED NOZZLE	1	PZ																																																																						
VL1186A0	3 WAYS PLUS WASHING DISTRIBUTOR	1	PZ																																																																						
VL1190A0	PLUS WASHING SYSTEM INLET DISTRIBUTOR	1	PZ																																																																						
VM1605A0	CLIP TWIST LOCK DIAM. 10,2-12,7 MM	6	PZ																																																																						
VM2172A0	PUMP-WITH-CLIP RCUIT LOCKING PIN	9	PZ																																																																						

COMPONENT			SPARE PART																																																																																						
Code	Description	Image	Code	Description	Components list																																																																																				
VL1019A	VIBRATION PUMP		KVL1207A	US PLUS 1 ROTOR ARM WASHING SYSTEM KIT	<table border="1"> <thead> <tr> <th>Code</th> <th>Description</th> <th>Qty</th> <th>UOM</th> </tr> </thead> <tbody> <tr> <td>0H2354A0</td> <td>XEVC-XEVL WASHING CIRCUIT PLAT</td> <td>1</td> <td>PZ</td> </tr> <tr> <td>0H2411A0</td> <td></td> <td>1</td> <td>PZ</td> </tr> <tr> <td>EL1450A0</td> <td>US SELF-CLEANIN G WATER SOLENOID</td> <td>3</td> <td>PZ</td> </tr> <tr> <td>GN1526A0</td> <td>INT. D.=6.9 TH=1.8 O-RIN</td> <td>7</td> <td>PZ</td> </tr> <tr> <td>RC1018A0</td> <td>ZINC PLATED D12 ELASTIC CLAMP</td> <td>3</td> <td>PZ</td> </tr> <tr> <td>RC1019A0</td> <td>D=10 ELASTIC CLAMP</td> <td>14</td> <td>PZ</td> </tr> <tr> <td>RC1130A0</td> <td>130X2,6 CLAM</td> <td>1</td> <td>PZ</td> </tr> <tr> <td>RC1131A0</td> <td>200X2.6 BLACK CLAMP</td> <td>2</td> <td>PZ</td> </tr> <tr> <td>RC1242A0</td> <td>D=10 CLOSED CAP</td> <td>2</td> <td>PZ</td> </tr> <tr> <td>RC1356A0</td> <td>*STRAIGHT THREADED FEMALE END 8X1/4" BS</td> <td>1</td> <td>PZ</td> </tr> <tr> <td>TB2820A0</td> <td>6X10 EPDM PIPE FOR WASHING SYSTEM</td> <td>1.460</td> <td>M</td> </tr> <tr> <td>TB3132A0</td> <td>WHITE-BLUE EPDM TEXTILE BRAID HOSE 6X12</td> <td>0.770</td> <td>M</td> </tr> <tr> <td>VI1220A1</td> <td>4,2X12 TCB SELF-TAPPIN G SCREW</td> <td>3</td> <td>PZ</td> </tr> <tr> <td>VL1019A0</td> <td>VIBRATION PUMP</td> <td>1</td> <td>PZ</td> </tr> <tr> <td>VL1047A1</td> <td>D6 PIPE HOLDER - D8 J.G. TERMINAL</td> <td>1</td> <td>PZ</td> </tr> <tr> <td>VL1065A1</td> <td>1/4 MALE N.O. PRESSURE SWITCH</td> <td>1</td> <td>PZ</td> </tr> <tr> <td>VL1102A1</td> <td>DETERGENT LINE FILTER + BARBED VNR 6 MM</td> <td>1</td> <td>PZ</td> </tr> <tr> <td>VL1128A1</td> <td>D6 BARBED CHECK VALVE</td> <td>2</td> <td>PZ</td> </tr> <tr> <td>VL1165A0</td> <td>BB6-AR6 STRAIGHT FITTING</td> <td>1</td> <td>PZ</td> </tr> <tr> <td>VL1166A0</td> <td>BB6-AR6 L FITTING</td> <td>3</td> <td>PZ</td> </tr> </tbody> </table>	Code	Description	Qty	UOM	0H2354A0	XEVC-XEVL WASHING CIRCUIT PLAT	1	PZ	0H2411A0		1	PZ	EL1450A0	US SELF-CLEANIN G WATER SOLENOID	3	PZ	GN1526A0	INT. D.=6.9 TH=1.8 O-RIN	7	PZ	RC1018A0	ZINC PLATED D12 ELASTIC CLAMP	3	PZ	RC1019A0	D=10 ELASTIC CLAMP	14	PZ	RC1130A0	130X2,6 CLAM	1	PZ	RC1131A0	200X2.6 BLACK CLAMP	2	PZ	RC1242A0	D=10 CLOSED CAP	2	PZ	RC1356A0	*STRAIGHT THREADED FEMALE END 8X1/4" BS	1	PZ	TB2820A0	6X10 EPDM PIPE FOR WASHING SYSTEM	1.460	M	TB3132A0	WHITE-BLUE EPDM TEXTILE BRAID HOSE 6X12	0.770	M	VI1220A1	4,2X12 TCB SELF-TAPPIN G SCREW	3	PZ	VL1019A0	VIBRATION PUMP	1	PZ	VL1047A1	D6 PIPE HOLDER - D8 J.G. TERMINAL	1	PZ	VL1065A1	1/4 MALE N.O. PRESSURE SWITCH	1	PZ	VL1102A1	DETERGENT LINE FILTER + BARBED VNR 6 MM	1	PZ	VL1128A1	D6 BARBED CHECK VALVE	2	PZ	VL1165A0	BB6-AR6 STRAIGHT FITTING	1	PZ	VL1166A0	BB6-AR6 L FITTING	3	PZ
Code	Description	Qty	UOM																																																																																						
0H2354A0	XEVC-XEVL WASHING CIRCUIT PLAT	1	PZ																																																																																						
0H2411A0		1	PZ																																																																																						
EL1450A0	US SELF-CLEANIN G WATER SOLENOID	3	PZ																																																																																						
GN1526A0	INT. D.=6.9 TH=1.8 O-RIN	7	PZ																																																																																						
RC1018A0	ZINC PLATED D12 ELASTIC CLAMP	3	PZ																																																																																						
RC1019A0	D=10 ELASTIC CLAMP	14	PZ																																																																																						
RC1130A0	130X2,6 CLAM	1	PZ																																																																																						
RC1131A0	200X2.6 BLACK CLAMP	2	PZ																																																																																						
RC1242A0	D=10 CLOSED CAP	2	PZ																																																																																						
RC1356A0	*STRAIGHT THREADED FEMALE END 8X1/4" BS	1	PZ																																																																																						
TB2820A0	6X10 EPDM PIPE FOR WASHING SYSTEM	1.460	M																																																																																						
TB3132A0	WHITE-BLUE EPDM TEXTILE BRAID HOSE 6X12	0.770	M																																																																																						
VI1220A1	4,2X12 TCB SELF-TAPPIN G SCREW	3	PZ																																																																																						
VL1019A0	VIBRATION PUMP	1	PZ																																																																																						
VL1047A1	D6 PIPE HOLDER - D8 J.G. TERMINAL	1	PZ																																																																																						
VL1065A1	1/4 MALE N.O. PRESSURE SWITCH	1	PZ																																																																																						
VL1102A1	DETERGENT LINE FILTER + BARBED VNR 6 MM	1	PZ																																																																																						
VL1128A1	D6 BARBED CHECK VALVE	2	PZ																																																																																						
VL1165A0	BB6-AR6 STRAIGHT FITTING	1	PZ																																																																																						
VL1166A0	BB6-AR6 L FITTING	3	PZ																																																																																						

COMPONENT			SPARE PART																																																										
Code	Description	Image	Code	Description	Components list																																																								
VL1019A	VIBRATION PUMP		KVL1207A	US PLUS 1 ROTOR ARM WASHING SYSTEM KIT	<table border="1"> <thead> <tr> <th>Code</th> <th>Description</th> <th>Qty</th> <th>UOM</th> </tr> </thead> <tbody> <tr> <td>VL1174C0</td> <td>D1.2 MM CALIBRATED NOZZLE</td> <td>1</td> <td>PZ</td> </tr> <tr> <td>VL1185A0</td> <td>2 WAYS PLUS WASHING DISTRIBUTOR</td> <td>1</td> <td>PZ</td> </tr> <tr> <td>VL1190A0</td> <td>PLUS WASHING SYSTEM INLET DISTRIBUTOR</td> <td>1</td> <td>PZ</td> </tr> <tr> <td>VM1605A0</td> <td>CLIP TWIST LOCK DIAM. 10,2-12,7 MM</td> <td>6</td> <td>PZ</td> </tr> <tr> <td>VM2172A0</td> <td>PUMP-WITH-CI RCUIT LOCKING PIN</td> <td>6</td> <td>PZ</td> </tr> </tbody> </table>	Code	Description	Qty	UOM	VL1174C0	D1.2 MM CALIBRATED NOZZLE	1	PZ	VL1185A0	2 WAYS PLUS WASHING DISTRIBUTOR	1	PZ	VL1190A0	PLUS WASHING SYSTEM INLET DISTRIBUTOR	1	PZ	VM1605A0	CLIP TWIST LOCK DIAM. 10,2-12,7 MM	6	PZ	VM2172A0	PUMP-WITH-CI RCUIT LOCKING PIN	6	PZ																																
Code	Description	Qty	UOM																																																										
VL1174C0	D1.2 MM CALIBRATED NOZZLE	1	PZ																																																										
VL1185A0	2 WAYS PLUS WASHING DISTRIBUTOR	1	PZ																																																										
VL1190A0	PLUS WASHING SYSTEM INLET DISTRIBUTOR	1	PZ																																																										
VM1605A0	CLIP TWIST LOCK DIAM. 10,2-12,7 MM	6	PZ																																																										
VM2172A0	PUMP-WITH-CI RCUIT LOCKING PIN	6	PZ																																																										
			KVL1198A	MM EU HOOD CLEANING SYSTEM KIT	<table border="1"> <thead> <tr> <th>Code</th> <th>Description</th> <th>Qty</th> <th>UOM</th> </tr> </thead> <tbody> <tr> <td>0H2213A1</td> <td></td> <td>1</td> <td>PZ</td> </tr> <tr> <td>EL1440A0</td> <td>WATER SELF CLEANING VALVE</td> <td>2</td> <td>PZ</td> </tr> <tr> <td>GN1526A0</td> <td>INT. D.=6.9 TH=1.8 O-RIN</td> <td>5</td> <td>PZ</td> </tr> <tr> <td>RC1018A0</td> <td>ZINC PLATED D12 ELASTIC CLAMP</td> <td>6</td> <td>PZ</td> </tr> <tr> <td>RC1019A0</td> <td>D=10 ELASTIC CLAMP</td> <td>16</td> <td>PZ</td> </tr> <tr> <td>RC1131A0</td> <td>200X2.6 BLACK CLAMP</td> <td>1</td> <td>PZ</td> </tr> <tr> <td>RC1242A0</td> <td>D=10 CLOSED CAP</td> <td>2</td> <td>PZ</td> </tr> <tr> <td>TB2820A0</td> <td>6X10 EPDM PIPE FOR WASHING SYSTEM</td> <td>2.240</td> <td>M</td> </tr> <tr> <td>TB3132A0</td> <td>WHITE-BLUE EPDM TEXTILE BRAID HOSE 6X12</td> <td>0.440</td> <td>M</td> </tr> <tr> <td>VI1220A1</td> <td>4,2X12 TCB SELF-TAPPIN G SCREW</td> <td>3</td> <td>PZ</td> </tr> <tr> <td>VL1019A0</td> <td>VIBRATION PUMP</td> <td>1</td> <td>PZ</td> </tr> <tr> <td>VL1047A1</td> <td>D6 PIPE HOLDER - D6 J.G. TERMINAL</td> <td>2</td> <td>PZ</td> </tr> <tr> <td>VL1054B0</td> <td>ONE WASHING SYS INLET DISTRIBUTOR</td> <td>1</td> <td>PZ</td> </tr> </tbody> </table>	Code	Description	Qty	UOM	0H2213A1		1	PZ	EL1440A0	WATER SELF CLEANING VALVE	2	PZ	GN1526A0	INT. D.=6.9 TH=1.8 O-RIN	5	PZ	RC1018A0	ZINC PLATED D12 ELASTIC CLAMP	6	PZ	RC1019A0	D=10 ELASTIC CLAMP	16	PZ	RC1131A0	200X2.6 BLACK CLAMP	1	PZ	RC1242A0	D=10 CLOSED CAP	2	PZ	TB2820A0	6X10 EPDM PIPE FOR WASHING SYSTEM	2.240	M	TB3132A0	WHITE-BLUE EPDM TEXTILE BRAID HOSE 6X12	0.440	M	VI1220A1	4,2X12 TCB SELF-TAPPIN G SCREW	3	PZ	VL1019A0	VIBRATION PUMP	1	PZ	VL1047A1	D6 PIPE HOLDER - D6 J.G. TERMINAL	2	PZ	VL1054B0	ONE WASHING SYS INLET DISTRIBUTOR	1	PZ
Code	Description	Qty	UOM																																																										
0H2213A1		1	PZ																																																										
EL1440A0	WATER SELF CLEANING VALVE	2	PZ																																																										
GN1526A0	INT. D.=6.9 TH=1.8 O-RIN	5	PZ																																																										
RC1018A0	ZINC PLATED D12 ELASTIC CLAMP	6	PZ																																																										
RC1019A0	D=10 ELASTIC CLAMP	16	PZ																																																										
RC1131A0	200X2.6 BLACK CLAMP	1	PZ																																																										
RC1242A0	D=10 CLOSED CAP	2	PZ																																																										
TB2820A0	6X10 EPDM PIPE FOR WASHING SYSTEM	2.240	M																																																										
TB3132A0	WHITE-BLUE EPDM TEXTILE BRAID HOSE 6X12	0.440	M																																																										
VI1220A1	4,2X12 TCB SELF-TAPPIN G SCREW	3	PZ																																																										
VL1019A0	VIBRATION PUMP	1	PZ																																																										
VL1047A1	D6 PIPE HOLDER - D6 J.G. TERMINAL	2	PZ																																																										
VL1054B0	ONE WASHING SYS INLET DISTRIBUTOR	1	PZ																																																										

COMPONENT			SPARE PART																																																		
Code	Description	Image	Code	Description	Components list																																																
VL1019A	VIBRATION PUMP		KVL1198A	MM EU HOOD CLEANING SYSTEM KIT	<table border="1"> <thead> <tr> <th>Code</th> <th>Description</th> <th>Qty</th> <th>UOM</th> </tr> </thead> <tbody> <tr> <td>VL1102A1</td> <td>DETERGENT LINE FILTER + BARBED VNR 6 MM</td> <td>1</td> <td>PZ</td> </tr> <tr> <td>VL1127A1</td> <td>6MM BARBED T-SHAPED FITTING</td> <td>1</td> <td>PZ</td> </tr> <tr> <td>VL1128A1</td> <td>D6 BARBED CHECK VALVE</td> <td>2</td> <td>PZ</td> </tr> <tr> <td>VL1165A0</td> <td>BB6-AR6 STRAIGHT FITTING</td> <td>2</td> <td>PZ</td> </tr> <tr> <td>VL1166A0</td> <td>BB6-AR6 L FITTING</td> <td>2</td> <td>PZ</td> </tr> <tr> <td>VL1174C0</td> <td>D1.2 MM CALIBRATED NOZZLE</td> <td>1</td> <td>PZ</td> </tr> <tr> <td>VL1191A0</td> <td>ONE WASHING DISTRIBUTOR OUTLETS KIT</td> <td>1</td> <td>PZ</td> </tr> <tr> <td>VM1605A0</td> <td>CLIP TWIST LOCK DIAM. 10.2-12.7 MM</td> <td>4</td> <td>PZ</td> </tr> <tr> <td>VM2172A0</td> <td>PUMP-WITH-CI RCUIT LOCKING PIN</td> <td>5</td> <td>PZ</td> </tr> </tbody> </table>	Code	Description	Qty	UOM	VL1102A1	DETERGENT LINE FILTER + BARBED VNR 6 MM	1	PZ	VL1127A1	6MM BARBED T-SHAPED FITTING	1	PZ	VL1128A1	D6 BARBED CHECK VALVE	2	PZ	VL1165A0	BB6-AR6 STRAIGHT FITTING	2	PZ	VL1166A0	BB6-AR6 L FITTING	2	PZ	VL1174C0	D1.2 MM CALIBRATED NOZZLE	1	PZ	VL1191A0	ONE WASHING DISTRIBUTOR OUTLETS KIT	1	PZ	VM1605A0	CLIP TWIST LOCK DIAM. 10.2-12.7 MM	4	PZ	VM2172A0	PUMP-WITH-CI RCUIT LOCKING PIN	5	PZ								
Code	Description	Qty	UOM																																																		
VL1102A1	DETERGENT LINE FILTER + BARBED VNR 6 MM	1	PZ																																																		
VL1127A1	6MM BARBED T-SHAPED FITTING	1	PZ																																																		
VL1128A1	D6 BARBED CHECK VALVE	2	PZ																																																		
VL1165A0	BB6-AR6 STRAIGHT FITTING	2	PZ																																																		
VL1166A0	BB6-AR6 L FITTING	2	PZ																																																		
VL1174C0	D1.2 MM CALIBRATED NOZZLE	1	PZ																																																		
VL1191A0	ONE WASHING DISTRIBUTOR OUTLETS KIT	1	PZ																																																		
VM1605A0	CLIP TWIST LOCK DIAM. 10.2-12.7 MM	4	PZ																																																		
VM2172A0	PUMP-WITH-CI RCUIT LOCKING PIN	5	PZ																																																		
			KVL1187A	3 ROTOR ARMS PLUS EU CLEANING SYSTEM KIT	<table border="1"> <thead> <tr> <th>Code</th> <th>Description</th> <th>Qty</th> <th>UOM</th> </tr> </thead> <tbody> <tr> <td>0H2143A0</td> <td>LAMIERA BLOCCA VNR VL1128</td> <td>3</td> <td>PZ</td> </tr> <tr> <td>0H2168A0</td> <td></td> <td>1</td> <td>PZ</td> </tr> <tr> <td>0H2354A0</td> <td>XEVC-XEVL WASHING CIRCUIT PLAT</td> <td>1</td> <td>PZ</td> </tr> <tr> <td>EL1120A0</td> <td>D8-D6 FEMALE STRAIGHT INTERM. CONNECTION</td> <td>1</td> <td>PZ</td> </tr> <tr> <td>EL1220A0</td> <td>JG STRAIGHT CONNECTION Ø8F-Ø8F</td> <td>2</td> <td>PZ</td> </tr> <tr> <td>EL1440A0</td> <td>WATER SELF CLEANING VALVE</td> <td>4</td> <td>PZ</td> </tr> <tr> <td>GN1526A0</td> <td>INT. D.=6.9 TH=1.8 O-RIN</td> <td>9</td> <td>PZ</td> </tr> <tr> <td>RC1018A0</td> <td>ZINC PLATED D12 ELASTIC CLAMP</td> <td>10</td> <td>PZ</td> </tr> <tr> <td>RC1019A0</td> <td>D=10 ELASTIC CLAMP</td> <td>22</td> <td>PZ</td> </tr> <tr> <td>RC1130A0</td> <td>130X2.6 CLAM</td> <td>4</td> <td>PZ</td> </tr> <tr> <td>RC1131A0</td> <td>200X2.6 BLACK CLAMP</td> <td>3</td> <td>PZ</td> </tr> </tbody> </table>	Code	Description	Qty	UOM	0H2143A0	LAMIERA BLOCCA VNR VL1128	3	PZ	0H2168A0		1	PZ	0H2354A0	XEVC-XEVL WASHING CIRCUIT PLAT	1	PZ	EL1120A0	D8-D6 FEMALE STRAIGHT INTERM. CONNECTION	1	PZ	EL1220A0	JG STRAIGHT CONNECTION Ø8F-Ø8F	2	PZ	EL1440A0	WATER SELF CLEANING VALVE	4	PZ	GN1526A0	INT. D.=6.9 TH=1.8 O-RIN	9	PZ	RC1018A0	ZINC PLATED D12 ELASTIC CLAMP	10	PZ	RC1019A0	D=10 ELASTIC CLAMP	22	PZ	RC1130A0	130X2.6 CLAM	4	PZ	RC1131A0	200X2.6 BLACK CLAMP	3	PZ
Code	Description	Qty	UOM																																																		
0H2143A0	LAMIERA BLOCCA VNR VL1128	3	PZ																																																		
0H2168A0		1	PZ																																																		
0H2354A0	XEVC-XEVL WASHING CIRCUIT PLAT	1	PZ																																																		
EL1120A0	D8-D6 FEMALE STRAIGHT INTERM. CONNECTION	1	PZ																																																		
EL1220A0	JG STRAIGHT CONNECTION Ø8F-Ø8F	2	PZ																																																		
EL1440A0	WATER SELF CLEANING VALVE	4	PZ																																																		
GN1526A0	INT. D.=6.9 TH=1.8 O-RIN	9	PZ																																																		
RC1018A0	ZINC PLATED D12 ELASTIC CLAMP	10	PZ																																																		
RC1019A0	D=10 ELASTIC CLAMP	22	PZ																																																		
RC1130A0	130X2.6 CLAM	4	PZ																																																		
RC1131A0	200X2.6 BLACK CLAMP	3	PZ																																																		





COMPONENT			SPARE PART																																																																										
Code	Description	Image	Code	Description	Components list																																																																								
VL1019A	VIBRATION PUMP		KVL1187A	3 ROTOR ARMS PLUS EU CLEANING SYSTEM KIT	<table border="1"> <thead> <tr> <th>Code</th> <th>Description</th> <th>Qty</th> <th>UOM</th> </tr> </thead> <tbody> <tr> <td>RC1242A0</td> <td>D=10 CLOSED CAP</td> <td>2</td> <td>PZ</td> </tr> <tr> <td>RC1310A0</td> <td>140X4 CLAMP WITH CLIP</td> <td>1</td> <td>PZ</td> </tr> <tr> <td>RC1356A0</td> <td>"STRAIGHT THREADED FEMALE END 8X1/4" BS</td> <td>1</td> <td>PZ</td> </tr> <tr> <td>TB2820A0</td> <td>6X10 EPDM PIPE FOR WASHING SYSTEM</td> <td>1.510</td> <td>M</td> </tr> <tr> <td>TB3132A0</td> <td>WHITE-BLUE EPDM TEXTILE BRAID HOSE 6X12</td> <td>1.210</td> <td>M</td> </tr> <tr> <td>VI1220A1</td> <td>4,2X12 TCB SELF-TAPPIN G SCREW</td> <td>3</td> <td>PZ</td> </tr> <tr> <td>VL1019A0</td> <td>VIBRATION PUMP</td> <td>1</td> <td>PZ</td> </tr> <tr> <td>VL1046A1</td> <td>D6 PIPE HOLDER - D6 J.G. TERMINAL</td> <td>3</td> <td>PZ</td> </tr> <tr> <td>VL1047A1</td> <td>D6 PIPE HOLDER - D8 J.G. TERMINAL</td> <td>1</td> <td>PZ</td> </tr> <tr> <td>VL1064A0</td> <td>WASHING SYSTEM OUTLETS DISTRIBUTOR</td> <td>1</td> <td>PZ</td> </tr> <tr> <td>VL1065A1</td> <td>1/4 MALE N.O. PRESSURE SWITCH</td> <td>1</td> <td>PZ</td> </tr> <tr> <td>VL1067A0</td> <td>WASHING SYSTEM INLETS DISTRIBUTOR</td> <td>1</td> <td>PZ</td> </tr> <tr> <td>VL1092A0</td> <td>WASHING SYSTEM OUTLET DOUBLE DISTRIBUTOR</td> <td>1</td> <td>PZ</td> </tr> <tr> <td>VL1102A1</td> <td>DETERGENT LINE FILTER + BARBED VNR 6 MM</td> <td>1</td> <td>PZ</td> </tr> <tr> <td>VL1127A1</td> <td>6MM BARBED T-SHAPED FITTING</td> <td>2</td> <td>PZ</td> </tr> <tr> <td>VL1128A0</td> <td>D6 BARBED CHECK VALVE</td> <td>3</td> <td>PZ</td> </tr> <tr> <td>VL1128A1</td> <td>D6 BARBED CHECK VALVE</td> <td>3</td> <td>PZ</td> </tr> </tbody> </table>	Code	Description	Qty	UOM	RC1242A0	D=10 CLOSED CAP	2	PZ	RC1310A0	140X4 CLAMP WITH CLIP	1	PZ	RC1356A0	"STRAIGHT THREADED FEMALE END 8X1/4" BS	1	PZ	TB2820A0	6X10 EPDM PIPE FOR WASHING SYSTEM	1.510	M	TB3132A0	WHITE-BLUE EPDM TEXTILE BRAID HOSE 6X12	1.210	M	VI1220A1	4,2X12 TCB SELF-TAPPIN G SCREW	3	PZ	VL1019A0	VIBRATION PUMP	1	PZ	VL1046A1	D6 PIPE HOLDER - D6 J.G. TERMINAL	3	PZ	VL1047A1	D6 PIPE HOLDER - D8 J.G. TERMINAL	1	PZ	VL1064A0	WASHING SYSTEM OUTLETS DISTRIBUTOR	1	PZ	VL1065A1	1/4 MALE N.O. PRESSURE SWITCH	1	PZ	VL1067A0	WASHING SYSTEM INLETS DISTRIBUTOR	1	PZ	VL1092A0	WASHING SYSTEM OUTLET DOUBLE DISTRIBUTOR	1	PZ	VL1102A1	DETERGENT LINE FILTER + BARBED VNR 6 MM	1	PZ	VL1127A1	6MM BARBED T-SHAPED FITTING	2	PZ	VL1128A0	D6 BARBED CHECK VALVE	3	PZ	VL1128A1	D6 BARBED CHECK VALVE	3	PZ
Code	Description	Qty	UOM																																																																										
RC1242A0	D=10 CLOSED CAP	2	PZ																																																																										
RC1310A0	140X4 CLAMP WITH CLIP	1	PZ																																																																										
RC1356A0	"STRAIGHT THREADED FEMALE END 8X1/4" BS	1	PZ																																																																										
TB2820A0	6X10 EPDM PIPE FOR WASHING SYSTEM	1.510	M																																																																										
TB3132A0	WHITE-BLUE EPDM TEXTILE BRAID HOSE 6X12	1.210	M																																																																										
VI1220A1	4,2X12 TCB SELF-TAPPIN G SCREW	3	PZ																																																																										
VL1019A0	VIBRATION PUMP	1	PZ																																																																										
VL1046A1	D6 PIPE HOLDER - D6 J.G. TERMINAL	3	PZ																																																																										
VL1047A1	D6 PIPE HOLDER - D8 J.G. TERMINAL	1	PZ																																																																										
VL1064A0	WASHING SYSTEM OUTLETS DISTRIBUTOR	1	PZ																																																																										
VL1065A1	1/4 MALE N.O. PRESSURE SWITCH	1	PZ																																																																										
VL1067A0	WASHING SYSTEM INLETS DISTRIBUTOR	1	PZ																																																																										
VL1092A0	WASHING SYSTEM OUTLET DOUBLE DISTRIBUTOR	1	PZ																																																																										
VL1102A1	DETERGENT LINE FILTER + BARBED VNR 6 MM	1	PZ																																																																										
VL1127A1	6MM BARBED T-SHAPED FITTING	2	PZ																																																																										
VL1128A0	D6 BARBED CHECK VALVE	3	PZ																																																																										
VL1128A1	D6 BARBED CHECK VALVE	3	PZ																																																																										

COMPONENT			SPARE PART																																																		
Code	Description	Image	Code	Description	Components list																																																
VL1019A	VIBRATION PUMP		KVL1187A	3 ROTOR ARMS PLUS EU CLEANING SYSTEM KIT	<table border="1"> <thead> <tr> <th>Code</th> <th>Description</th> <th>Qty</th> <th>UOM</th> </tr> </thead> <tbody> <tr> <td>VL1165A0</td> <td>BB6-AR6 STRAIGHT FITTING</td> <td>4</td> <td>PZ</td> </tr> <tr> <td>VL1166A0</td> <td>BB6-AR6 L FITTING</td> <td>4</td> <td>PZ</td> </tr> <tr> <td>VL1167A0</td> <td></td> <td>1</td> <td>PZ</td> </tr> <tr> <td>VL1167A1</td> <td></td> <td>1</td> <td>PZ</td> </tr> <tr> <td>VL1167A2</td> <td>GN21 3 ROTOR ARMS B-B FLOW RESTRICTOR</td> <td>1</td> <td>PZ</td> </tr> <tr> <td>VL1174C0</td> <td>D1.2 MM CALIBRATED NOZZLE</td> <td>1</td> <td>PZ</td> </tr> <tr> <td>VL1185A0</td> <td>2 WAYS PLUS WASHING DISTRIBUTOR</td> <td>1</td> <td>PZ</td> </tr> <tr> <td>VL1186A0</td> <td>3 WAYS PLUS WASHING DISTRIBUTOR</td> <td>1</td> <td>PZ</td> </tr> <tr> <td>VL1190A0</td> <td>PLUS WASHING SYSTEM INLET DISTRIBUTOR</td> <td>1</td> <td>PZ</td> </tr> <tr> <td>VM1605A0</td> <td>CLIP TWIST LOCK DIAM. 10.2-12.7 MM</td> <td>3</td> <td>PZ</td> </tr> <tr> <td>VM2172A0</td> <td>PUMP-WITH-CI RCUIT LOCKING PIN</td> <td>9</td> <td>PZ</td> </tr> </tbody> </table>	Code	Description	Qty	UOM	VL1165A0	BB6-AR6 STRAIGHT FITTING	4	PZ	VL1166A0	BB6-AR6 L FITTING	4	PZ	VL1167A0		1	PZ	VL1167A1		1	PZ	VL1167A2	GN21 3 ROTOR ARMS B-B FLOW RESTRICTOR	1	PZ	VL1174C0	D1.2 MM CALIBRATED NOZZLE	1	PZ	VL1185A0	2 WAYS PLUS WASHING DISTRIBUTOR	1	PZ	VL1186A0	3 WAYS PLUS WASHING DISTRIBUTOR	1	PZ	VL1190A0	PLUS WASHING SYSTEM INLET DISTRIBUTOR	1	PZ	VM1605A0	CLIP TWIST LOCK DIAM. 10.2-12.7 MM	3	PZ	VM2172A0	PUMP-WITH-CI RCUIT LOCKING PIN	9	PZ
			Code	Description	Qty	UOM																																															
VL1165A0	BB6-AR6 STRAIGHT FITTING	4	PZ																																																		
VL1166A0	BB6-AR6 L FITTING	4	PZ																																																		
VL1167A0		1	PZ																																																		
VL1167A1		1	PZ																																																		
VL1167A2	GN21 3 ROTOR ARMS B-B FLOW RESTRICTOR	1	PZ																																																		
VL1174C0	D1.2 MM CALIBRATED NOZZLE	1	PZ																																																		
VL1185A0	2 WAYS PLUS WASHING DISTRIBUTOR	1	PZ																																																		
VL1186A0	3 WAYS PLUS WASHING DISTRIBUTOR	1	PZ																																																		
VL1190A0	PLUS WASHING SYSTEM INLET DISTRIBUTOR	1	PZ																																																		
VM1605A0	CLIP TWIST LOCK DIAM. 10.2-12.7 MM	3	PZ																																																		
VM2172A0	PUMP-WITH-CI RCUIT LOCKING PIN	9	PZ																																																		
KVL1184A	2 ROTOR ARMS PLUS EU CLEANING SYSTEM KIT	<table border="1"> <thead> <tr> <th>Code</th> <th>Description</th> <th>Qty</th> <th>UOM</th> </tr> </thead> <tbody> <tr> <td>0H2143A0</td> <td>LAMIERA BLOCCA VNR VL1128</td> <td>2</td> <td>PZ</td> </tr> <tr> <td>0H2168A0</td> <td></td> <td>1</td> <td>PZ</td> </tr> <tr> <td>0H2354A0</td> <td>XEVC-XEVL WASHING CIRCUIT PLAT</td> <td>1</td> <td>PZ</td> </tr> <tr> <td>EL1220A0</td> <td>JG STRAIGHT CONNECTION Ø8F-Ø8F</td> <td>3</td> <td>PZ</td> </tr> <tr> <td>EL1440A0</td> <td>WATER SELF CLEANING VALVE</td> <td>4</td> <td>PZ</td> </tr> <tr> <td>GN1526A0</td> <td>INT. D.=6.9 TH=1.8 O-RIN</td> <td>9</td> <td>PZ</td> </tr> <tr> <td>RC1018A0</td> <td>ZINC PLATED D12 ELASTIC CLAMP</td> <td>2</td> <td>PZ</td> </tr> <tr> <td>RC1019A0</td> <td>D=10 ELASTIC CLAMP</td> <td>21</td> <td>PZ</td> </tr> <tr> <td>RC1130A0</td> <td>130X2.6 CLAM</td> <td>7</td> <td>PZ</td> </tr> <tr> <td>RC1131A0</td> <td>200X2.6 BLACK CLAMP</td> <td>3</td> <td>PZ</td> </tr> </tbody> </table>	Code	Description	Qty	UOM	0H2143A0	LAMIERA BLOCCA VNR VL1128	2	PZ	0H2168A0		1	PZ	0H2354A0	XEVC-XEVL WASHING CIRCUIT PLAT	1	PZ	EL1220A0	JG STRAIGHT CONNECTION Ø8F-Ø8F	3	PZ	EL1440A0	WATER SELF CLEANING VALVE	4	PZ	GN1526A0	INT. D.=6.9 TH=1.8 O-RIN	9	PZ	RC1018A0	ZINC PLATED D12 ELASTIC CLAMP	2	PZ	RC1019A0	D=10 ELASTIC CLAMP	21	PZ	RC1130A0	130X2.6 CLAM	7	PZ	RC1131A0	200X2.6 BLACK CLAMP	3	PZ							
Code	Description	Qty	UOM																																																		
0H2143A0	LAMIERA BLOCCA VNR VL1128	2	PZ																																																		
0H2168A0		1	PZ																																																		
0H2354A0	XEVC-XEVL WASHING CIRCUIT PLAT	1	PZ																																																		
EL1220A0	JG STRAIGHT CONNECTION Ø8F-Ø8F	3	PZ																																																		
EL1440A0	WATER SELF CLEANING VALVE	4	PZ																																																		
GN1526A0	INT. D.=6.9 TH=1.8 O-RIN	9	PZ																																																		
RC1018A0	ZINC PLATED D12 ELASTIC CLAMP	2	PZ																																																		
RC1019A0	D=10 ELASTIC CLAMP	21	PZ																																																		
RC1130A0	130X2.6 CLAM	7	PZ																																																		
RC1131A0	200X2.6 BLACK CLAMP	3	PZ																																																		

COMPONENT			SPARE PART																																																																										
Code	Description	Image	Code	Description	Components list																																																																								
VL1019A	VIBRATION PUMP		KVL1184A	2 ROTOR ARMS PLUS EU CLEANING SYSTEM KIT	<table border="1"> <thead> <tr> <th>Code</th> <th>Description</th> <th>Qty</th> <th>UOM</th> </tr> </thead> <tbody> <tr> <td>RC1242A0</td> <td>D=10 CLOSED CAP</td> <td>2</td> <td>PZ</td> </tr> <tr> <td>RC1356A0</td> <td>"STRAIGHT THREADED FEMALE END 8X1/4" BS</td> <td>1</td> <td>PZ</td> </tr> <tr> <td>TB2820A0</td> <td>6X10 EPDM PIPE FOR WASHING SYSTEM</td> <td>2.400</td> <td>M</td> </tr> <tr> <td>TB3132A0</td> <td>WHITE-BLUE EPDM TEXTILE BRAID HOSE 6X12</td> <td>1.220</td> <td>M</td> </tr> <tr> <td>VL1019A0</td> <td>VIBRATION PUMP</td> <td>1</td> <td>PZ</td> </tr> <tr> <td>VL1046A1</td> <td>D6 PIPE HOLDER - D6 J.G. TERMINAL</td> <td>3</td> <td>PZ</td> </tr> <tr> <td>VL1047A1</td> <td>D6 PIPE HOLDER - D8 J.G. TERMINAL</td> <td>1</td> <td>PZ</td> </tr> <tr> <td>VL1065A1</td> <td>1/4 MALE N.O. PRESSURE SWITCH</td> <td>1</td> <td>PZ</td> </tr> <tr> <td>VL1067A0</td> <td>WASHING SYSTEM INLETS DISTRIBUTOR</td> <td>1</td> <td>PZ</td> </tr> <tr> <td>VL1092A0</td> <td>WASHING SYSTEM OUTLET DOUBLE DISTRIBUTOR</td> <td>1</td> <td>PZ</td> </tr> <tr> <td>VL1102A1</td> <td>DETERGENT LINE FILTER + BARBED VNR 6 MM</td> <td>1</td> <td>PZ</td> </tr> <tr> <td>VL1128A0</td> <td>D6 BARBED CHECK VALVE</td> <td>2</td> <td>PZ</td> </tr> <tr> <td>VL1128A1</td> <td>D6 BARBED CHECK VALVE</td> <td>2</td> <td>PZ</td> </tr> <tr> <td>VL1141A1</td> <td>STRAIGHT CONNECT BB6-BB6</td> <td>1</td> <td>PZ</td> </tr> <tr> <td>VL1165A0</td> <td>BB6-AR6 STRAIGHT FITTING</td> <td>4</td> <td>PZ</td> </tr> <tr> <td>VL1166A0</td> <td>BB6-AR6 L FITTING</td> <td>4</td> <td>PZ</td> </tr> <tr> <td>VL1174C0</td> <td>D1.2 MM CALIBRATED NOZZLE</td> <td>1</td> <td>PZ</td> </tr> </tbody> </table>	Code	Description	Qty	UOM	RC1242A0	D=10 CLOSED CAP	2	PZ	RC1356A0	"STRAIGHT THREADED FEMALE END 8X1/4" BS	1	PZ	TB2820A0	6X10 EPDM PIPE FOR WASHING SYSTEM	2.400	M	TB3132A0	WHITE-BLUE EPDM TEXTILE BRAID HOSE 6X12	1.220	M	VL1019A0	VIBRATION PUMP	1	PZ	VL1046A1	D6 PIPE HOLDER - D6 J.G. TERMINAL	3	PZ	VL1047A1	D6 PIPE HOLDER - D8 J.G. TERMINAL	1	PZ	VL1065A1	1/4 MALE N.O. PRESSURE SWITCH	1	PZ	VL1067A0	WASHING SYSTEM INLETS DISTRIBUTOR	1	PZ	VL1092A0	WASHING SYSTEM OUTLET DOUBLE DISTRIBUTOR	1	PZ	VL1102A1	DETERGENT LINE FILTER + BARBED VNR 6 MM	1	PZ	VL1128A0	D6 BARBED CHECK VALVE	2	PZ	VL1128A1	D6 BARBED CHECK VALVE	2	PZ	VL1141A1	STRAIGHT CONNECT BB6-BB6	1	PZ	VL1165A0	BB6-AR6 STRAIGHT FITTING	4	PZ	VL1166A0	BB6-AR6 L FITTING	4	PZ	VL1174C0	D1.2 MM CALIBRATED NOZZLE	1	PZ
Code	Description	Qty	UOM																																																																										
RC1242A0	D=10 CLOSED CAP	2	PZ																																																																										
RC1356A0	"STRAIGHT THREADED FEMALE END 8X1/4" BS	1	PZ																																																																										
TB2820A0	6X10 EPDM PIPE FOR WASHING SYSTEM	2.400	M																																																																										
TB3132A0	WHITE-BLUE EPDM TEXTILE BRAID HOSE 6X12	1.220	M																																																																										
VL1019A0	VIBRATION PUMP	1	PZ																																																																										
VL1046A1	D6 PIPE HOLDER - D6 J.G. TERMINAL	3	PZ																																																																										
VL1047A1	D6 PIPE HOLDER - D8 J.G. TERMINAL	1	PZ																																																																										
VL1065A1	1/4 MALE N.O. PRESSURE SWITCH	1	PZ																																																																										
VL1067A0	WASHING SYSTEM INLETS DISTRIBUTOR	1	PZ																																																																										
VL1092A0	WASHING SYSTEM OUTLET DOUBLE DISTRIBUTOR	1	PZ																																																																										
VL1102A1	DETERGENT LINE FILTER + BARBED VNR 6 MM	1	PZ																																																																										
VL1128A0	D6 BARBED CHECK VALVE	2	PZ																																																																										
VL1128A1	D6 BARBED CHECK VALVE	2	PZ																																																																										
VL1141A1	STRAIGHT CONNECT BB6-BB6	1	PZ																																																																										
VL1165A0	BB6-AR6 STRAIGHT FITTING	4	PZ																																																																										
VL1166A0	BB6-AR6 L FITTING	4	PZ																																																																										
VL1174C0	D1.2 MM CALIBRATED NOZZLE	1	PZ																																																																										

COMPONENT			SPARE PART																																																															
Code	Description	Image	Code	Description	Components list																																																													
VL1019A	VIBRATION PUMP		KVL1184A	2 ROTOR ARMS PLUS EU CLEANING SYSTEM KIT	<table border="1"> <thead> <tr> <th>Code</th> <th>Description</th> <th>Qty</th> <th>UOM</th> </tr> </thead> <tbody> <tr> <td>VL1186A0</td> <td>3 WAYS PLUS WASHING DISTRIBUTOR</td> <td>1</td> <td>PZ</td> </tr> <tr> <td>VL1190A0</td> <td>PLUS WASHING SYSTEM INLET DISTRIBUTOR</td> <td>1</td> <td>PZ</td> </tr> <tr> <td>VM1605A0</td> <td>CLIP TWIST LOCK DIAM. 10,2-12,7 MM</td> <td>4</td> <td>PZ</td> </tr> <tr> <td>VM2172A0</td> <td>PUMP-WITH-CI RCUIT LOCKING PIN</td> <td>9</td> <td>PZ</td> </tr> </tbody> </table>	Code	Description	Qty	UOM	VL1186A0	3 WAYS PLUS WASHING DISTRIBUTOR	1	PZ	VL1190A0	PLUS WASHING SYSTEM INLET DISTRIBUTOR	1	PZ	VM1605A0	CLIP TWIST LOCK DIAM. 10,2-12,7 MM	4	PZ	VM2172A0	PUMP-WITH-CI RCUIT LOCKING PIN	9	PZ																																									
			Code	Description	Qty	UOM																																																												
VL1186A0	3 WAYS PLUS WASHING DISTRIBUTOR	1	PZ																																																															
VL1190A0	PLUS WASHING SYSTEM INLET DISTRIBUTOR	1	PZ																																																															
VM1605A0	CLIP TWIST LOCK DIAM. 10,2-12,7 MM	4	PZ																																																															
VM2172A0	PUMP-WITH-CI RCUIT LOCKING PIN	9	PZ																																																															
KVL1183A	1 ROTOR ARM PLUS CLEANING SYSTEM KIT	<table border="1"> <thead> <tr> <th>Code</th> <th>Description</th> <th>Qty</th> <th>UOM</th> </tr> </thead> <tbody> <tr> <td>0H2143A0</td> <td>LAMIERA BLOCCA VNR VL1128</td> <td>2</td> <td>PZ</td> </tr> <tr> <td>0H2168A1</td> <td></td> <td>1</td> <td>PZ</td> </tr> <tr> <td>0H2354A0</td> <td>XEVC-XEVL WASHING CIRCUIT PLAT</td> <td>1</td> <td>PZ</td> </tr> <tr> <td>EL1440A0</td> <td>WATER SELF CLEANING VALVE</td> <td>3</td> <td>PZ</td> </tr> <tr> <td>GN1526A0</td> <td>INT. D.=6.9 TH=1.8 O-RIN</td> <td>7</td> <td>PZ</td> </tr> <tr> <td>RC1018A0</td> <td>ZINC PLATED D12 ELASTIC CLAMP</td> <td>2</td> <td>PZ</td> </tr> <tr> <td>RC1019A0</td> <td>D=10 ELASTIC CLAMP</td> <td>14</td> <td>PZ</td> </tr> <tr> <td>RC1130A0</td> <td>130X2,6 CLAM</td> <td>5</td> <td>PZ</td> </tr> <tr> <td>RC1131A0</td> <td>200X2.6 BLACK CLAMP</td> <td>2</td> <td>PZ</td> </tr> <tr> <td>RC1242A0</td> <td>D=10 CLOSED CAP</td> <td>2</td> <td>PZ</td> </tr> <tr> <td>RC1356A0</td> <td>"STRAIGHT THREADED FEMALE END 8X1/4" BS</td> <td>1</td> <td>PZ</td> </tr> <tr> <td>TB2820A0</td> <td>6X10 EPDM PIPE FOR WASHING SYSTEM</td> <td>1.410</td> <td>M</td> </tr> <tr> <td>TB3132A0</td> <td>WHITE-BLUE EPDM TEXTILE BRAID HOSE 6X12</td> <td>0.770</td> <td>M</td> </tr> <tr> <td>VI1220A1</td> <td>4,2X12 TCB SELF-TAPPIN G SCREW</td> <td>3</td> <td>PZ</td> </tr> <tr> <td>VL1019A0</td> <td>VIBRATION PUMP</td> <td>1</td> <td>PZ</td> </tr> </tbody> </table>	Code	Description	Qty	UOM	0H2143A0	LAMIERA BLOCCA VNR VL1128	2	PZ	0H2168A1		1	PZ	0H2354A0	XEVC-XEVL WASHING CIRCUIT PLAT	1	PZ	EL1440A0	WATER SELF CLEANING VALVE	3	PZ	GN1526A0	INT. D.=6.9 TH=1.8 O-RIN	7	PZ	RC1018A0	ZINC PLATED D12 ELASTIC CLAMP	2	PZ	RC1019A0	D=10 ELASTIC CLAMP	14	PZ	RC1130A0	130X2,6 CLAM	5	PZ	RC1131A0	200X2.6 BLACK CLAMP	2	PZ	RC1242A0	D=10 CLOSED CAP	2	PZ	RC1356A0	"STRAIGHT THREADED FEMALE END 8X1/4" BS	1	PZ	TB2820A0	6X10 EPDM PIPE FOR WASHING SYSTEM	1.410	M	TB3132A0	WHITE-BLUE EPDM TEXTILE BRAID HOSE 6X12	0.770	M	VI1220A1	4,2X12 TCB SELF-TAPPIN G SCREW	3	PZ	VL1019A0	VIBRATION PUMP	1	PZ
Code	Description	Qty	UOM																																																															
0H2143A0	LAMIERA BLOCCA VNR VL1128	2	PZ																																																															
0H2168A1		1	PZ																																																															
0H2354A0	XEVC-XEVL WASHING CIRCUIT PLAT	1	PZ																																																															
EL1440A0	WATER SELF CLEANING VALVE	3	PZ																																																															
GN1526A0	INT. D.=6.9 TH=1.8 O-RIN	7	PZ																																																															
RC1018A0	ZINC PLATED D12 ELASTIC CLAMP	2	PZ																																																															
RC1019A0	D=10 ELASTIC CLAMP	14	PZ																																																															
RC1130A0	130X2,6 CLAM	5	PZ																																																															
RC1131A0	200X2.6 BLACK CLAMP	2	PZ																																																															
RC1242A0	D=10 CLOSED CAP	2	PZ																																																															
RC1356A0	"STRAIGHT THREADED FEMALE END 8X1/4" BS	1	PZ																																																															
TB2820A0	6X10 EPDM PIPE FOR WASHING SYSTEM	1.410	M																																																															
TB3132A0	WHITE-BLUE EPDM TEXTILE BRAID HOSE 6X12	0.770	M																																																															
VI1220A1	4,2X12 TCB SELF-TAPPIN G SCREW	3	PZ																																																															
VL1019A0	VIBRATION PUMP	1	PZ																																																															

COMPONENT			SPARE PART																																																						
Code	Description	Image	Code	Description	Components list																																																				
VL1019A	VIBRATION PUMP		KVL1183A	1 ROTOR ARM PLUS CLEANING SYSTEM KIT	<table border="1"> <thead> <tr> <th>Code</th> <th>Description</th> <th>Qty</th> <th>UOM</th> </tr> </thead> <tbody> <tr> <td>VL1047A1</td> <td>D6 PIPE HOLDER - D8 J.G. TERMINAL</td> <td>1</td> <td>PZ</td> </tr> <tr> <td>VL1065A1</td> <td>1/4 MALE N.O. PRESSURE SWITCH</td> <td>1</td> <td>PZ</td> </tr> <tr> <td>VL1102A1</td> <td>DETERGENT LINE FILTER + BARBED VNR 6 MM</td> <td>1</td> <td>PZ</td> </tr> <tr> <td>VL1128A0</td> <td>D6 BARBED CHECK VALVE</td> <td>2</td> <td>PZ</td> </tr> <tr> <td>VL1128A1</td> <td>D6 BARBED CHECK VALVE</td> <td>2</td> <td>PZ</td> </tr> <tr> <td>VL1165A0</td> <td>BB6-AR6 STRAIGHT FITTING</td> <td>1</td> <td>PZ</td> </tr> <tr> <td>VL1166A0</td> <td>BB6-AR6 L FITTING</td> <td>3</td> <td>PZ</td> </tr> <tr> <td>VL1174C0</td> <td>D1.2 MM CALIBRATED NOZZLE</td> <td>1</td> <td>PZ</td> </tr> <tr> <td>VL1185A0</td> <td>2 WAYS PLUS WASHING DISTRIBUTOR</td> <td>1</td> <td>PZ</td> </tr> <tr> <td>VL1190A0</td> <td>PLUS WASHING SYSTEM INLET DISTRIBUTOR</td> <td>1</td> <td>PZ</td> </tr> <tr> <td>VM1605A0</td> <td>CLIP TWIST LOCK DIAM. 10.2-12.7 MM</td> <td>3</td> <td>PZ</td> </tr> <tr> <td>VM2172A0</td> <td>PUMP-WITH-CI RCUIT LOCKING PIN</td> <td>7</td> <td>PZ</td> </tr> </tbody> </table>	Code	Description	Qty	UOM	VL1047A1	D6 PIPE HOLDER - D8 J.G. TERMINAL	1	PZ	VL1065A1	1/4 MALE N.O. PRESSURE SWITCH	1	PZ	VL1102A1	DETERGENT LINE FILTER + BARBED VNR 6 MM	1	PZ	VL1128A0	D6 BARBED CHECK VALVE	2	PZ	VL1128A1	D6 BARBED CHECK VALVE	2	PZ	VL1165A0	BB6-AR6 STRAIGHT FITTING	1	PZ	VL1166A0	BB6-AR6 L FITTING	3	PZ	VL1174C0	D1.2 MM CALIBRATED NOZZLE	1	PZ	VL1185A0	2 WAYS PLUS WASHING DISTRIBUTOR	1	PZ	VL1190A0	PLUS WASHING SYSTEM INLET DISTRIBUTOR	1	PZ	VM1605A0	CLIP TWIST LOCK DIAM. 10.2-12.7 MM	3	PZ	VM2172A0	PUMP-WITH-CI RCUIT LOCKING PIN	7	PZ
Code	Description	Qty	UOM																																																						
VL1047A1	D6 PIPE HOLDER - D8 J.G. TERMINAL	1	PZ																																																						
VL1065A1	1/4 MALE N.O. PRESSURE SWITCH	1	PZ																																																						
VL1102A1	DETERGENT LINE FILTER + BARBED VNR 6 MM	1	PZ																																																						
VL1128A0	D6 BARBED CHECK VALVE	2	PZ																																																						
VL1128A1	D6 BARBED CHECK VALVE	2	PZ																																																						
VL1165A0	BB6-AR6 STRAIGHT FITTING	1	PZ																																																						
VL1166A0	BB6-AR6 L FITTING	3	PZ																																																						
VL1174C0	D1.2 MM CALIBRATED NOZZLE	1	PZ																																																						
VL1185A0	2 WAYS PLUS WASHING DISTRIBUTOR	1	PZ																																																						
VL1190A0	PLUS WASHING SYSTEM INLET DISTRIBUTOR	1	PZ																																																						
VM1605A0	CLIP TWIST LOCK DIAM. 10.2-12.7 MM	3	PZ																																																						
VM2172A0	PUMP-WITH-CI RCUIT LOCKING PIN	7	PZ																																																						
			KVL1182A	ONE CLEANING SYSTEM KIT (0311 EXC.)	<table border="1"> <thead> <tr> <th>Code</th> <th>Description</th> <th>Qty</th> <th>UOM</th> </tr> </thead> <tbody> <tr> <td>0H2143A0</td> <td>LAMIERA BLOCCA VNR VL1128</td> <td>2</td> <td>PZ</td> </tr> <tr> <td>0H2202A1</td> <td>ONE WASHING WITH STEAM VALVE SUPPORT</td> <td>1</td> <td>PZ</td> </tr> <tr> <td>EL1440A0</td> <td>WATER SELF CLEANING VALVE</td> <td>1</td> <td>PZ</td> </tr> <tr> <td>GN1526A0</td> <td>INT. D.=6.9 TH=1.8 O-RIN</td> <td>3</td> <td>PZ</td> </tr> <tr> <td>RC1018A0</td> <td>ZINC PLATED D12 ELASTIC CLAMP</td> <td>1</td> <td>PZ</td> </tr> </tbody> </table>	Code	Description	Qty	UOM	0H2143A0	LAMIERA BLOCCA VNR VL1128	2	PZ	0H2202A1	ONE WASHING WITH STEAM VALVE SUPPORT	1	PZ	EL1440A0	WATER SELF CLEANING VALVE	1	PZ	GN1526A0	INT. D.=6.9 TH=1.8 O-RIN	3	PZ	RC1018A0	ZINC PLATED D12 ELASTIC CLAMP	1	PZ																												
Code	Description	Qty	UOM																																																						
0H2143A0	LAMIERA BLOCCA VNR VL1128	2	PZ																																																						
0H2202A1	ONE WASHING WITH STEAM VALVE SUPPORT	1	PZ																																																						
EL1440A0	WATER SELF CLEANING VALVE	1	PZ																																																						
GN1526A0	INT. D.=6.9 TH=1.8 O-RIN	3	PZ																																																						
RC1018A0	ZINC PLATED D12 ELASTIC CLAMP	1	PZ																																																						

COMPONENT			SPARE PART																																																																														
Code	Description	Image	Code	Description	Components list																																																																												
VL1019A	VIBRATION PUMP		KVL1182A	ONE CLEANING SYSTEM KIT (0311 EXC.)	<table border="1"> <thead> <tr> <th>Code</th> <th>Description</th> <th>Qty</th> <th>UOM</th> </tr> </thead> <tbody> <tr> <td>RC1019A0</td> <td>D=10 ELASTIC CLAMP</td> <td>14</td> <td>PZ</td> </tr> <tr> <td>RC1130A0</td> <td>130X2,6 CLAM</td> <td>2</td> <td>PZ</td> </tr> <tr> <td>RC1242A0</td> <td>D=10 CLOSED CAP</td> <td>2</td> <td>PZ</td> </tr> <tr> <td>TB2820A0</td> <td>6X10 EPDM PIPE FOR WASHING SYSTEM</td> <td>1.410</td> <td>M</td> </tr> <tr> <td>TB3132A0</td> <td>WHITE-BLUE EPDM TEXTILE BRAID HOSE 6X12</td> <td>0.670</td> <td>M</td> </tr> <tr> <td>VI1220A1</td> <td>4,2X12 TCB SELF-TAPPIN G SCREW</td> <td>1</td> <td>PZ</td> </tr> <tr> <td>VL1019A0</td> <td>VIBRATION PUMP</td> <td>1</td> <td>PZ</td> </tr> <tr> <td>VL1047A1</td> <td>D6 PIPE HOLDER - D6 J.G. TERMINAL</td> <td>1</td> <td>PZ</td> </tr> <tr> <td>VL1054B0</td> <td>ONE WASHING SYS INLET DISTRIBUTOR</td> <td>1</td> <td>PZ</td> </tr> <tr> <td>VL1102A1</td> <td>DETERGENT LINE FILTER + BARBED VNR 6 MM</td> <td>1</td> <td>PZ</td> </tr> <tr> <td>VL1128A0</td> <td>D6 BARBED CHECK VALVE</td> <td>2</td> <td>PZ</td> </tr> <tr> <td>VL1128A1</td> <td>D6 BARBED CHECK VALVE</td> <td>2</td> <td>PZ</td> </tr> <tr> <td>VL1165A0</td> <td>BB6-AR6 STRAIGHT FITTING</td> <td>1</td> <td>PZ</td> </tr> <tr> <td>VL1166A0</td> <td>BB6-AR6 L FITTING</td> <td>1</td> <td>PZ</td> </tr> <tr> <td>VL1174C0</td> <td>D1.2 MM CALIBRATED NOZZLE</td> <td>1</td> <td>PZ</td> </tr> <tr> <td>VL1191A0</td> <td>ONE WASHING DISTRIBUTOR OUTLETS KIT</td> <td>1</td> <td>PZ</td> </tr> <tr> <td>VM1605A0</td> <td>CLIP TWIST LOCK DIAM. 10,2-12,7 MM</td> <td>3</td> <td>PZ</td> </tr> <tr> <td>VM2172A0</td> <td>PUMP-WITH-CI RCUIT LOCKING PIN</td> <td>2</td> <td>PZ</td> </tr> </tbody> </table>	Code	Description	Qty	UOM	RC1019A0	D=10 ELASTIC CLAMP	14	PZ	RC1130A0	130X2,6 CLAM	2	PZ	RC1242A0	D=10 CLOSED CAP	2	PZ	TB2820A0	6X10 EPDM PIPE FOR WASHING SYSTEM	1.410	M	TB3132A0	WHITE-BLUE EPDM TEXTILE BRAID HOSE 6X12	0.670	M	VI1220A1	4,2X12 TCB SELF-TAPPIN G SCREW	1	PZ	VL1019A0	VIBRATION PUMP	1	PZ	VL1047A1	D6 PIPE HOLDER - D6 J.G. TERMINAL	1	PZ	VL1054B0	ONE WASHING SYS INLET DISTRIBUTOR	1	PZ	VL1102A1	DETERGENT LINE FILTER + BARBED VNR 6 MM	1	PZ	VL1128A0	D6 BARBED CHECK VALVE	2	PZ	VL1128A1	D6 BARBED CHECK VALVE	2	PZ	VL1165A0	BB6-AR6 STRAIGHT FITTING	1	PZ	VL1166A0	BB6-AR6 L FITTING	1	PZ	VL1174C0	D1.2 MM CALIBRATED NOZZLE	1	PZ	VL1191A0	ONE WASHING DISTRIBUTOR OUTLETS KIT	1	PZ	VM1605A0	CLIP TWIST LOCK DIAM. 10,2-12,7 MM	3	PZ	VM2172A0	PUMP-WITH-CI RCUIT LOCKING PIN	2	PZ
Code	Description	Qty	UOM																																																																														
RC1019A0	D=10 ELASTIC CLAMP	14	PZ																																																																														
RC1130A0	130X2,6 CLAM	2	PZ																																																																														
RC1242A0	D=10 CLOSED CAP	2	PZ																																																																														
TB2820A0	6X10 EPDM PIPE FOR WASHING SYSTEM	1.410	M																																																																														
TB3132A0	WHITE-BLUE EPDM TEXTILE BRAID HOSE 6X12	0.670	M																																																																														
VI1220A1	4,2X12 TCB SELF-TAPPIN G SCREW	1	PZ																																																																														
VL1019A0	VIBRATION PUMP	1	PZ																																																																														
VL1047A1	D6 PIPE HOLDER - D6 J.G. TERMINAL	1	PZ																																																																														
VL1054B0	ONE WASHING SYS INLET DISTRIBUTOR	1	PZ																																																																														
VL1102A1	DETERGENT LINE FILTER + BARBED VNR 6 MM	1	PZ																																																																														
VL1128A0	D6 BARBED CHECK VALVE	2	PZ																																																																														
VL1128A1	D6 BARBED CHECK VALVE	2	PZ																																																																														
VL1165A0	BB6-AR6 STRAIGHT FITTING	1	PZ																																																																														
VL1166A0	BB6-AR6 L FITTING	1	PZ																																																																														
VL1174C0	D1.2 MM CALIBRATED NOZZLE	1	PZ																																																																														
VL1191A0	ONE WASHING DISTRIBUTOR OUTLETS KIT	1	PZ																																																																														
VM1605A0	CLIP TWIST LOCK DIAM. 10,2-12,7 MM	3	PZ																																																																														
VM2172A0	PUMP-WITH-CI RCUIT LOCKING PIN	2	PZ																																																																														



COMPONENT			SPARE PART																																																																																																					
Code	Description	Image	Code	Description	Components list																																																																																																			
VL1019A	VIBRATION PUMP		KVL0684A	2-3 ROTOR ARM PLUS WASH PUMP+NOZZLE KIT	<table border="1"> <thead> <tr> <th>Code</th> <th>Description</th> <th>Qty</th> <th>UOM</th> </tr> </thead> <tbody> <tr> <td>GN1526A0</td> <td>INT. D.=6.9 TH=1.8 O-RIN</td> <td>4</td> <td>PZ</td> </tr> <tr> <td>RC1019A0</td> <td>D=10 ELASTIC CLAMP</td> <td>4</td> <td>PZ</td> </tr> <tr> <td>RC1130A0</td> <td>130X2,6 CLAM</td> <td>1</td> <td>PZ</td> </tr> <tr> <td>RC1131A0</td> <td>200X2.6 BLACK CLAMP</td> <td>3</td> <td>PZ</td> </tr> <tr> <td>RC1242A0</td> <td>D=10 CLOSED CAP</td> <td>2</td> <td>PZ</td> </tr> <tr> <td>TB2820A0</td> <td>6X10 EPDM PIPE FOR WASHING SYSTEM</td> <td>0.120</td> <td>M</td> </tr> <tr> <td>VL1019A0</td> <td>VIBRATION PUMP</td> <td>1</td> <td>PZ</td> </tr> <tr> <td>VL1128A1</td> <td>D6 BARBED CHECK VALVE</td> <td>1</td> <td>PZ</td> </tr> <tr> <td>VL1174C0</td> <td>D1.2 MM CALIBRATED NOZZLE</td> <td>1</td> <td>PZ</td> </tr> <tr> <td>VL1186A0</td> <td>3 WAYS PLUS WASHING DISTRIBUTOR</td> <td>1</td> <td>PZ</td> </tr> <tr> <td>VL1190A0</td> <td>PLUS WASHING SYSTEM INLET DISTRIBUTOR</td> <td>1</td> <td>PZ</td> </tr> <tr> <td>VM2172A0</td> <td>PUMP-WITH-CI RCUIT LOCKING PIN</td> <td>1</td> <td>PZ</td> </tr> </tbody> </table>	Code	Description	Qty	UOM	GN1526A0	INT. D.=6.9 TH=1.8 O-RIN	4	PZ	RC1019A0	D=10 ELASTIC CLAMP	4	PZ	RC1130A0	130X2,6 CLAM	1	PZ	RC1131A0	200X2.6 BLACK CLAMP	3	PZ	RC1242A0	D=10 CLOSED CAP	2	PZ	TB2820A0	6X10 EPDM PIPE FOR WASHING SYSTEM	0.120	M	VL1019A0	VIBRATION PUMP	1	PZ	VL1128A1	D6 BARBED CHECK VALVE	1	PZ	VL1174C0	D1.2 MM CALIBRATED NOZZLE	1	PZ	VL1186A0	3 WAYS PLUS WASHING DISTRIBUTOR	1	PZ	VL1190A0	PLUS WASHING SYSTEM INLET DISTRIBUTOR	1	PZ	VM2172A0	PUMP-WITH-CI RCUIT LOCKING PIN	1	PZ	KVL0683A	1 ROTOR ARM PLUS WASH PUMP+NOZZLE KIT	<table border="1"> <thead> <tr> <th>Code</th> <th>Description</th> <th>Qty</th> <th>UOM</th> </tr> </thead> <tbody> <tr> <td>GN1526A0</td> <td>INT. D.=6.9 TH=1.8 O-RIN</td> <td>3</td> <td>PZ</td> </tr> <tr> <td>RC1019A0</td> <td>D=10 ELASTIC CLAMP</td> <td>4</td> <td>PZ</td> </tr> <tr> <td>RC1130A0</td> <td>130X2,6 CLAM</td> <td>1</td> <td>PZ</td> </tr> <tr> <td>RC1131A0</td> <td>200X2.6 BLACK CLAMP</td> <td>2</td> <td>PZ</td> </tr> <tr> <td>RC1242A0</td> <td>D=10 CLOSED CAP</td> <td>2</td> <td>PZ</td> </tr> <tr> <td>TB2820A0</td> <td>6X10 EPDM PIPE FOR WASHING SYSTEM</td> <td>0.120</td> <td>M</td> </tr> <tr> <td>VL1019A0</td> <td>VIBRATION PUMP</td> <td>1</td> <td>PZ</td> </tr> <tr> <td>VL1128A1</td> <td>D6 BARBED CHECK VALVE</td> <td>1</td> <td>PZ</td> </tr> <tr> <td>VL1174C0</td> <td>D1.2 MM CALIBRATED NOZZLE</td> <td>1</td> <td>PZ</td> </tr> <tr> <td>VL1185A0</td> <td>2 WAYS PLUS WASHING DISTRIBUTOR</td> <td>1</td> <td>PZ</td> </tr> </tbody> </table>	Code	Description	Qty	UOM	GN1526A0	INT. D.=6.9 TH=1.8 O-RIN	3	PZ	RC1019A0	D=10 ELASTIC CLAMP	4	PZ	RC1130A0	130X2,6 CLAM	1	PZ	RC1131A0	200X2.6 BLACK CLAMP	2	PZ	RC1242A0	D=10 CLOSED CAP	2	PZ	TB2820A0	6X10 EPDM PIPE FOR WASHING SYSTEM	0.120	M	VL1019A0	VIBRATION PUMP	1	PZ	VL1128A1	D6 BARBED CHECK VALVE	1	PZ	VL1174C0	D1.2 MM CALIBRATED NOZZLE	1	PZ	VL1185A0	2 WAYS PLUS WASHING DISTRIBUTOR	1	PZ
			Code	Description	Qty	UOM																																																																																																		
GN1526A0	INT. D.=6.9 TH=1.8 O-RIN	4	PZ																																																																																																					
RC1019A0	D=10 ELASTIC CLAMP	4	PZ																																																																																																					
RC1130A0	130X2,6 CLAM	1	PZ																																																																																																					
RC1131A0	200X2.6 BLACK CLAMP	3	PZ																																																																																																					
RC1242A0	D=10 CLOSED CAP	2	PZ																																																																																																					
TB2820A0	6X10 EPDM PIPE FOR WASHING SYSTEM	0.120	M																																																																																																					
VL1019A0	VIBRATION PUMP	1	PZ																																																																																																					
VL1128A1	D6 BARBED CHECK VALVE	1	PZ																																																																																																					
VL1174C0	D1.2 MM CALIBRATED NOZZLE	1	PZ																																																																																																					
VL1186A0	3 WAYS PLUS WASHING DISTRIBUTOR	1	PZ																																																																																																					
VL1190A0	PLUS WASHING SYSTEM INLET DISTRIBUTOR	1	PZ																																																																																																					
VM2172A0	PUMP-WITH-CI RCUIT LOCKING PIN	1	PZ																																																																																																					
Code	Description	Qty	UOM																																																																																																					
GN1526A0	INT. D.=6.9 TH=1.8 O-RIN	3	PZ																																																																																																					
RC1019A0	D=10 ELASTIC CLAMP	4	PZ																																																																																																					
RC1130A0	130X2,6 CLAM	1	PZ																																																																																																					
RC1131A0	200X2.6 BLACK CLAMP	2	PZ																																																																																																					
RC1242A0	D=10 CLOSED CAP	2	PZ																																																																																																					
TB2820A0	6X10 EPDM PIPE FOR WASHING SYSTEM	0.120	M																																																																																																					
VL1019A0	VIBRATION PUMP	1	PZ																																																																																																					
VL1128A1	D6 BARBED CHECK VALVE	1	PZ																																																																																																					
VL1174C0	D1.2 MM CALIBRATED NOZZLE	1	PZ																																																																																																					
VL1185A0	2 WAYS PLUS WASHING DISTRIBUTOR	1	PZ																																																																																																					

COMPONENT			SPARE PART																																											
Code	Description	Image	Code	Description	Components list																																									
VL1019A	VIBRATION PUMP		KVL0683A	1 ROTOR ARM PLUS WASH PUMP+NOZZLE KIT	<table border="1"> <thead> <tr> <th>Code</th> <th>Description</th> <th>Qty</th> <th>UOM</th> </tr> </thead> <tbody> <tr> <td>VL1190A0</td> <td>PLUS WASHING SYSTEM INLET DISTRIBUTOR</td> <td>1</td> <td>PZ</td> </tr> <tr> <td>VM2172A0</td> <td>PUMP-WITH-CI RCUIT LOCKING PIN</td> <td>1</td> <td>PZ</td> </tr> </tbody> </table>	Code	Description	Qty	UOM	VL1190A0	PLUS WASHING SYSTEM INLET DISTRIBUTOR	1	PZ	VM2172A0	PUMP-WITH-CI RCUIT LOCKING PIN	1	PZ																													
			Code	Description	Qty	UOM																																								
			VL1190A0	PLUS WASHING SYSTEM INLET DISTRIBUTOR	1	PZ																																								
VM2172A0	PUMP-WITH-CI RCUIT LOCKING PIN	1	PZ																																											
KVL0682A	ONE+HOODS WASHING SYSTEM PUMP+NOZZLE KIT	<table border="1"> <thead> <tr> <th>Code</th> <th>Description</th> <th>Qty</th> <th>UOM</th> </tr> </thead> <tbody> <tr> <td>GN1526A0</td> <td>INT. D.=6.9 TH=1.8 O-RING</td> <td>1</td> <td>PZ</td> </tr> <tr> <td>RC1019A0</td> <td>D=10 ELASTIC CLAMP</td> <td>3</td> <td>PZ</td> </tr> <tr> <td>RC1242A0</td> <td>D=10 CLOSED CAP</td> <td>2</td> <td>PZ</td> </tr> <tr> <td>TB2820A0</td> <td>6X10 EPDM PIPE FOR WASHING SYSTEM</td> <td>0.120</td> <td>M</td> </tr> <tr> <td>VL1019A0</td> <td>VIBRATION PUMP</td> <td>1</td> <td>PZ</td> </tr> <tr> <td>VL1054B0</td> <td>ONE WASHING SYS INLET DISTRIBUTOR</td> <td>1</td> <td>PZ</td> </tr> <tr> <td>VL1128A1</td> <td>D6 BARBED CHECK VALVE</td> <td>2</td> <td>PZ</td> </tr> <tr> <td>VL1174C0</td> <td>D1.2 MM CALIBRATED NOZZLE</td> <td>1</td> <td>PZ</td> </tr> <tr> <td>VL1191A0</td> <td>ONE WASHING DISTRIBUTOR OUTLETS KIT</td> <td>1</td> <td>PZ</td> </tr> <tr> <td>VM2172A0</td> <td>PUMP-WITH-CI RCUIT LOCKING PIN</td> <td>1</td> <td>PZ</td> </tr> </tbody> </table>	Code	Description	Qty	UOM	GN1526A0	INT. D.=6.9 TH=1.8 O-RING	1	PZ	RC1019A0	D=10 ELASTIC CLAMP	3	PZ	RC1242A0	D=10 CLOSED CAP	2	PZ	TB2820A0	6X10 EPDM PIPE FOR WASHING SYSTEM	0.120	M	VL1019A0	VIBRATION PUMP	1	PZ	VL1054B0	ONE WASHING SYS INLET DISTRIBUTOR	1	PZ	VL1128A1	D6 BARBED CHECK VALVE	2	PZ	VL1174C0	D1.2 MM CALIBRATED NOZZLE	1	PZ	VL1191A0	ONE WASHING DISTRIBUTOR OUTLETS KIT	1	PZ	VM2172A0	PUMP-WITH-CI RCUIT LOCKING PIN	1	PZ
Code	Description	Qty	UOM																																											
GN1526A0	INT. D.=6.9 TH=1.8 O-RING	1	PZ																																											
RC1019A0	D=10 ELASTIC CLAMP	3	PZ																																											
RC1242A0	D=10 CLOSED CAP	2	PZ																																											
TB2820A0	6X10 EPDM PIPE FOR WASHING SYSTEM	0.120	M																																											
VL1019A0	VIBRATION PUMP	1	PZ																																											
VL1054B0	ONE WASHING SYS INLET DISTRIBUTOR	1	PZ																																											
VL1128A1	D6 BARBED CHECK VALVE	2	PZ																																											
VL1174C0	D1.2 MM CALIBRATED NOZZLE	1	PZ																																											
VL1191A0	ONE WASHING DISTRIBUTOR OUTLETS KIT	1	PZ																																											
VM2172A0	PUMP-WITH-CI RCUIT LOCKING PIN	1	PZ																																											
KVL0001A	LM TOP CLEANING SYSTEM KIT	<table border="1"> <thead> <tr> <th>Code</th> <th>Description</th> <th>Qty</th> <th>UOM</th> </tr> </thead> <tbody> <tr> <td>0H1226B0</td> <td>LINEMISSTOP WASHING SYTEM CIRCUIT COVE</td> <td>1</td> <td>PZ</td> </tr> <tr> <td>0H2143A0</td> <td>LAMIERA BLOCCA VNR VL1128</td> <td>2</td> <td>PZ</td> </tr> <tr> <td>EL1436B0</td> <td>JG D8-BARBED D6 NRV WATER SOLENOID</td> <td>1</td> <td>PZ</td> </tr> <tr> <td>GN1312A0</td> <td>RUBBER CABLE-PASSI NG DE=26 DI=15 SP=10</td> <td>1</td> <td>PZ</td> </tr> </tbody> </table>	Code	Description	Qty	UOM	0H1226B0	LINEMISSTOP WASHING SYTEM CIRCUIT COVE	1	PZ	0H2143A0	LAMIERA BLOCCA VNR VL1128	2	PZ	EL1436B0	JG D8-BARBED D6 NRV WATER SOLENOID	1	PZ	GN1312A0	RUBBER CABLE-PASSI NG DE=26 DI=15 SP=10	1	PZ																								
Code	Description	Qty	UOM																																											
0H1226B0	LINEMISSTOP WASHING SYTEM CIRCUIT COVE	1	PZ																																											
0H2143A0	LAMIERA BLOCCA VNR VL1128	2	PZ																																											
EL1436B0	JG D8-BARBED D6 NRV WATER SOLENOID	1	PZ																																											
GN1312A0	RUBBER CABLE-PASSI NG DE=26 DI=15 SP=10	1	PZ																																											



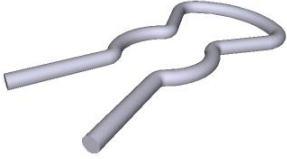

COMPONENT			SPARE PART																																																																																		
Code	Description	Image	Code	Description	Components list																																																																																
VL1019A	VIBRATION PUMP		KVL0001A	LM TOP CLEANING SYSTEM KIT	<table border="1"> <thead> <tr> <th>Code</th> <th>Description</th> <th>Qty</th> <th>UOM</th> </tr> </thead> <tbody> <tr> <td>GN1526A0</td> <td>INT. D.=6.9 TH=1.8 O-RIN</td> <td>1</td> <td>PZ</td> </tr> <tr> <td>RC1019A0</td> <td>D=10 ELASTIC CLAMP</td> <td>5</td> <td>PZ</td> </tr> <tr> <td>RC1242A0</td> <td>D=10 CLOSED CAP</td> <td>2</td> <td>PZ</td> </tr> <tr> <td>RC1381A0</td> <td>BIFILAR PIPE CLIP D10.7</td> <td>3</td> <td>PZ</td> </tr> <tr> <td>TB2343A0</td> <td>9X6 PVC TRANSPAREN T PIPE</td> <td>1.650</td> <td>M</td> </tr> <tr> <td>TB2820A0</td> <td>6X10 EPDM PIPE FOR WASHING SYSTEM</td> <td>0.990</td> <td>M</td> </tr> <tr> <td>VI1220A1</td> <td>4,2X12 TCB SELF-TAPPIN G SCREW</td> <td>1</td> <td>PZ</td> </tr> <tr> <td>VL1019A0</td> <td>VIBRATION PUMP</td> <td>1</td> <td>PZ</td> </tr> <tr> <td>VL1041C0</td> <td>DETERGENT CAP WITH Ø12 HOLE</td> <td>1</td> <td>PZ</td> </tr> <tr> <td>VL1047A1</td> <td>D6 PIPE HOLDER - D6 J.G. TERMINAL</td> <td>1</td> <td>PZ</td> </tr> <tr> <td>VL1053B0</td> <td>ONE WASHING SYS EXT DISTRIBUTOR</td> <td>1</td> <td>PZ</td> </tr> <tr> <td>VL1054B0</td> <td>ONE WASHING SYS INLET DISTRIBUTOR</td> <td>1</td> <td>PZ</td> </tr> <tr> <td>VL1061A0</td> <td>HOLD DOWN WEIGHT+NET FILTER+NON- RET. V.</td> <td>1</td> <td>PZ</td> </tr> <tr> <td>VL1128A0</td> <td>D6 BARBED CHECK VALVE</td> <td>2</td> <td>PZ</td> </tr> <tr> <td>VL1128A1</td> <td>D6 BARBED CHECK VALVE</td> <td>2</td> <td>PZ</td> </tr> <tr> <td>VM1066A0</td> <td>SADDLE CLIP FOR CABLES PASSING</td> <td>3</td> <td>PZ</td> </tr> <tr> <td>VM1088A0</td> <td>NYLON CLICK CLAMP D7.9-D9.2</td> <td>1</td> <td>PZ</td> </tr> <tr> <td>VM1605A0</td> <td>CLIP TWIST LOCK DIAM. 10,2-12,7 MM</td> <td>1</td> <td>PZ</td> </tr> <tr> <td>VM2172A0</td> <td>PUMP-WITH-CI RCUIT LOCKING PIN</td> <td>1</td> <td>PZ</td> </tr> </tbody> </table>	Code	Description	Qty	UOM	GN1526A0	INT. D.=6.9 TH=1.8 O-RIN	1	PZ	RC1019A0	D=10 ELASTIC CLAMP	5	PZ	RC1242A0	D=10 CLOSED CAP	2	PZ	RC1381A0	BIFILAR PIPE CLIP D10.7	3	PZ	TB2343A0	9X6 PVC TRANSPAREN T PIPE	1.650	M	TB2820A0	6X10 EPDM PIPE FOR WASHING SYSTEM	0.990	M	VI1220A1	4,2X12 TCB SELF-TAPPIN G SCREW	1	PZ	VL1019A0	VIBRATION PUMP	1	PZ	VL1041C0	DETERGENT CAP WITH Ø12 HOLE	1	PZ	VL1047A1	D6 PIPE HOLDER - D6 J.G. TERMINAL	1	PZ	VL1053B0	ONE WASHING SYS EXT DISTRIBUTOR	1	PZ	VL1054B0	ONE WASHING SYS INLET DISTRIBUTOR	1	PZ	VL1061A0	HOLD DOWN WEIGHT+NET FILTER+NON- RET. V.	1	PZ	VL1128A0	D6 BARBED CHECK VALVE	2	PZ	VL1128A1	D6 BARBED CHECK VALVE	2	PZ	VM1066A0	SADDLE CLIP FOR CABLES PASSING	3	PZ	VM1088A0	NYLON CLICK CLAMP D7.9-D9.2	1	PZ	VM1605A0	CLIP TWIST LOCK DIAM. 10,2-12,7 MM	1	PZ	VM2172A0	PUMP-WITH-CI RCUIT LOCKING PIN	1	PZ
Code	Description	Qty	UOM																																																																																		
GN1526A0	INT. D.=6.9 TH=1.8 O-RIN	1	PZ																																																																																		
RC1019A0	D=10 ELASTIC CLAMP	5	PZ																																																																																		
RC1242A0	D=10 CLOSED CAP	2	PZ																																																																																		
RC1381A0	BIFILAR PIPE CLIP D10.7	3	PZ																																																																																		
TB2343A0	9X6 PVC TRANSPAREN T PIPE	1.650	M																																																																																		
TB2820A0	6X10 EPDM PIPE FOR WASHING SYSTEM	0.990	M																																																																																		
VI1220A1	4,2X12 TCB SELF-TAPPIN G SCREW	1	PZ																																																																																		
VL1019A0	VIBRATION PUMP	1	PZ																																																																																		
VL1041C0	DETERGENT CAP WITH Ø12 HOLE	1	PZ																																																																																		
VL1047A1	D6 PIPE HOLDER - D6 J.G. TERMINAL	1	PZ																																																																																		
VL1053B0	ONE WASHING SYS EXT DISTRIBUTOR	1	PZ																																																																																		
VL1054B0	ONE WASHING SYS INLET DISTRIBUTOR	1	PZ																																																																																		
VL1061A0	HOLD DOWN WEIGHT+NET FILTER+NON- RET. V.	1	PZ																																																																																		
VL1128A0	D6 BARBED CHECK VALVE	2	PZ																																																																																		
VL1128A1	D6 BARBED CHECK VALVE	2	PZ																																																																																		
VM1066A0	SADDLE CLIP FOR CABLES PASSING	3	PZ																																																																																		
VM1088A0	NYLON CLICK CLAMP D7.9-D9.2	1	PZ																																																																																		
VM1605A0	CLIP TWIST LOCK DIAM. 10,2-12,7 MM	1	PZ																																																																																		
VM2172A0	PUMP-WITH-CI RCUIT LOCKING PIN	1	PZ																																																																																		



COMPONENT			SPARE PART																																		
Code	Description	Image	Code	Description	Components list																																
GN1526A	INT. D.=6.9 TH=1.8 O-RING		KGN1526A	O-RING INT D6.9 THICK1.8 10PCS KIT	<table border="1"> <thead> <tr> <th>Code</th> <th>Description</th> <th>Qty</th> <th>UOM</th> </tr> </thead> <tbody> <tr> <td>GN1526A0</td> <td>INT. D.=6.9 TH=1.8 O-RIN</td> <td>10</td> <td>PZ</td> </tr> </tbody> </table>	Code	Description	Qty	UOM	GN1526A0	INT. D.=6.9 TH=1.8 O-RIN	10	PZ																								
Code	Description	Qty	UOM																																		
GN1526A0	INT. D.=6.9 TH=1.8 O-RIN	10	PZ																																		
VM2172A	PUMP-WITH-CIRCUIT T LOCKING PIN		VM2172A0	PUMP-WITH-CIRCUIT T LOCKING PIN																																	
RC1019A	D=10 ELASTIC CLAMP		KRC1019A	Ø10 ZINC PLATED ELASTIC CLAMP 15 PCS KIT	<table border="1"> <thead> <tr> <th>Code</th> <th>Description</th> <th>Qty</th> <th>UOM</th> </tr> </thead> <tbody> <tr> <td>RC1019A0</td> <td>D=10 ELASTIC CLAMP</td> <td>17</td> <td>PZ</td> </tr> <tr> <td>VM1224A0</td> <td>65MY 220MM 2 COLOURS SHRINK TUBE</td> <td>0.200</td> <td>M</td> </tr> </tbody> </table>	Code	Description	Qty	UOM	RC1019A0	D=10 ELASTIC CLAMP	17	PZ	VM1224A0	65MY 220MM 2 COLOURS SHRINK TUBE	0.200	M																				
Code	Description	Qty	UOM																																		
RC1019A0	D=10 ELASTIC CLAMP	17	PZ																																		
VM1224A0	65MY 220MM 2 COLOURS SHRINK TUBE	0.200	M																																		
VL1054B	ONE WASHING SYS INLET DISTRIBUTOR		KVL2618A	2 ROTOR ARMS ONE CLEANING SYSTEM KIT	<table border="1"> <thead> <tr> <th>Code</th> <th>Description</th> <th>Qty</th> <th>UOM</th> </tr> </thead> <tbody> <tr> <td>0H2202A1</td> <td>ONE WASHING WITH STEAM VALVE SUPPORT</td> <td>2</td> <td>PZ</td> </tr> <tr> <td>CE1030A0</td> <td>FEMALE FASTON COVER 6.3X0.8 0.5-1MMQ</td> <td>4</td> <td>PZ</td> </tr> <tr> <td>CE1395A0</td> <td>6,3 X 0,8 FEMALE FASTO</td> <td>2</td> <td>PZ</td> </tr> <tr> <td>CE1545A0</td> <td>BLUE UNIP AWG18 ST.3135 WIRE</td> <td>1</td> <td>M</td> </tr> <tr> <td>CE1570A0</td> <td>WHITE UNIP AWG18 ST.3135 WIRE</td> <td>1</td> <td>M</td> </tr> <tr> <td>CE1660A0</td> <td>6,3X0,8 FEMALE FASTON COVE</td> <td>4</td> <td>PZ</td> </tr> <tr> <td>CE1661A0</td> <td>MALE FASTON COVER 6,3X0,</td> <td>2</td> <td>PZ</td> </tr> </tbody> </table>	Code	Description	Qty	UOM	0H2202A1	ONE WASHING WITH STEAM VALVE SUPPORT	2	PZ	CE1030A0	FEMALE FASTON COVER 6.3X0.8 0.5-1MMQ	4	PZ	CE1395A0	6,3 X 0,8 FEMALE FASTO	2	PZ	CE1545A0	BLUE UNIP AWG18 ST.3135 WIRE	1	M	CE1570A0	WHITE UNIP AWG18 ST.3135 WIRE	1	M	CE1660A0	6,3X0,8 FEMALE FASTON COVE	4	PZ	CE1661A0	MALE FASTON COVER 6,3X0,	2	PZ
Code	Description	Qty	UOM																																		
0H2202A1	ONE WASHING WITH STEAM VALVE SUPPORT	2	PZ																																		
CE1030A0	FEMALE FASTON COVER 6.3X0.8 0.5-1MMQ	4	PZ																																		
CE1395A0	6,3 X 0,8 FEMALE FASTO	2	PZ																																		
CE1545A0	BLUE UNIP AWG18 ST.3135 WIRE	1	M																																		
CE1570A0	WHITE UNIP AWG18 ST.3135 WIRE	1	M																																		
CE1660A0	6,3X0,8 FEMALE FASTON COVE	4	PZ																																		
CE1661A0	MALE FASTON COVER 6,3X0,	2	PZ																																		



COMPONENT			SPARE PART																																																																																		
Code	Description	Image	Code	Description	Components list																																																																																
VL1054B	ONE WASHING SYS INLET DISTRIBUTOR		KVL2618A	2 ROTOR ARMS ONE CLEANING SYSTEM KIT	<table border="1"> <thead> <tr> <th>Code</th> <th>Description</th> <th>Qty</th> <th>UOM</th> </tr> </thead> <tbody> <tr> <td>EL1020A1</td> <td>D8 INTERMEDIAT E T-SHAPED FITTING</td> <td>1</td> <td>PZ</td> </tr> <tr> <td>EL1440A0</td> <td>WATER SELF CLEANING VALVE</td> <td>2</td> <td>PZ</td> </tr> <tr> <td>GN1526A0</td> <td>INT. D.=6.9 TH=1.8 O-RIN</td> <td>6</td> <td>PZ</td> </tr> <tr> <td>IP1385A1</td> <td>CORNER POLYSTYREN E PACKING 110X80X2000</td> <td>0.500</td> <td>M</td> </tr> <tr> <td>RC1018A0</td> <td>ZINC PLATED D12 ELASTIC CLAMP</td> <td>4</td> <td>PZ</td> </tr> <tr> <td>RC1019A0</td> <td>D=10 ELASTIC CLAMP</td> <td>31</td> <td>PZ</td> </tr> <tr> <td>RC1130A0</td> <td>130X2,6 CLAM</td> <td>4</td> <td>PZ</td> </tr> <tr> <td>RC1242A0</td> <td>D=10 CLOSED CAP</td> <td>4</td> <td>PZ</td> </tr> <tr> <td>TB2820A0</td> <td>6X10 EPDM PIPE FOR WASHING SYSTEM</td> <td>2.920</td> <td>M</td> </tr> <tr> <td>TB3132A0</td> <td>WHITE-BLUE EPDM TEXTILE BRAID HOSE 6X12</td> <td>1.340</td> <td>M</td> </tr> <tr> <td>VI1220A1</td> <td>4,2X12 TCB SELF-TAPPIN G SCREW</td> <td>2</td> <td>PZ</td> </tr> <tr> <td>VL1019A0</td> <td>VIBRATION PUMP</td> <td>2</td> <td>PZ</td> </tr> <tr> <td>VL1047A1</td> <td>D6 PIPE HOLDER - D8 J.G. TERMINAL</td> <td>2</td> <td>PZ</td> </tr> <tr> <td>VL1054B0</td> <td>ONE WASHING SYS INLET DISTRIBUTOR</td> <td>2</td> <td>PZ</td> </tr> <tr> <td>VL1102A1</td> <td>DETERGENT LINE FILTER + BARBED VNR 6 MM</td> <td>2</td> <td>PZ</td> </tr> <tr> <td>VL1127A1</td> <td>6MM BARBED T-SHAPED FITTING</td> <td>1</td> <td>PZ</td> </tr> <tr> <td>VL1128A1</td> <td>D6 BARBED CHECK VALVE</td> <td>4</td> <td>PZ</td> </tr> <tr> <td>VL1165A0</td> <td>BB6-AR6 STRAIGHT FITTING</td> <td>2</td> <td>PZ</td> </tr> <tr> <td>VL1166A0</td> <td>BB6-AR6 L FITTING</td> <td>2</td> <td>PZ</td> </tr> </tbody> </table>	Code	Description	Qty	UOM	EL1020A1	D8 INTERMEDIAT E T-SHAPED FITTING	1	PZ	EL1440A0	WATER SELF CLEANING VALVE	2	PZ	GN1526A0	INT. D.=6.9 TH=1.8 O-RIN	6	PZ	IP1385A1	CORNER POLYSTYREN E PACKING 110X80X2000	0.500	M	RC1018A0	ZINC PLATED D12 ELASTIC CLAMP	4	PZ	RC1019A0	D=10 ELASTIC CLAMP	31	PZ	RC1130A0	130X2,6 CLAM	4	PZ	RC1242A0	D=10 CLOSED CAP	4	PZ	TB2820A0	6X10 EPDM PIPE FOR WASHING SYSTEM	2.920	M	TB3132A0	WHITE-BLUE EPDM TEXTILE BRAID HOSE 6X12	1.340	M	VI1220A1	4,2X12 TCB SELF-TAPPIN G SCREW	2	PZ	VL1019A0	VIBRATION PUMP	2	PZ	VL1047A1	D6 PIPE HOLDER - D8 J.G. TERMINAL	2	PZ	VL1054B0	ONE WASHING SYS INLET DISTRIBUTOR	2	PZ	VL1102A1	DETERGENT LINE FILTER + BARBED VNR 6 MM	2	PZ	VL1127A1	6MM BARBED T-SHAPED FITTING	1	PZ	VL1128A1	D6 BARBED CHECK VALVE	4	PZ	VL1165A0	BB6-AR6 STRAIGHT FITTING	2	PZ	VL1166A0	BB6-AR6 L FITTING	2	PZ
Code	Description	Qty	UOM																																																																																		
EL1020A1	D8 INTERMEDIAT E T-SHAPED FITTING	1	PZ																																																																																		
EL1440A0	WATER SELF CLEANING VALVE	2	PZ																																																																																		
GN1526A0	INT. D.=6.9 TH=1.8 O-RIN	6	PZ																																																																																		
IP1385A1	CORNER POLYSTYREN E PACKING 110X80X2000	0.500	M																																																																																		
RC1018A0	ZINC PLATED D12 ELASTIC CLAMP	4	PZ																																																																																		
RC1019A0	D=10 ELASTIC CLAMP	31	PZ																																																																																		
RC1130A0	130X2,6 CLAM	4	PZ																																																																																		
RC1242A0	D=10 CLOSED CAP	4	PZ																																																																																		
TB2820A0	6X10 EPDM PIPE FOR WASHING SYSTEM	2.920	M																																																																																		
TB3132A0	WHITE-BLUE EPDM TEXTILE BRAID HOSE 6X12	1.340	M																																																																																		
VI1220A1	4,2X12 TCB SELF-TAPPIN G SCREW	2	PZ																																																																																		
VL1019A0	VIBRATION PUMP	2	PZ																																																																																		
VL1047A1	D6 PIPE HOLDER - D8 J.G. TERMINAL	2	PZ																																																																																		
VL1054B0	ONE WASHING SYS INLET DISTRIBUTOR	2	PZ																																																																																		
VL1102A1	DETERGENT LINE FILTER + BARBED VNR 6 MM	2	PZ																																																																																		
VL1127A1	6MM BARBED T-SHAPED FITTING	1	PZ																																																																																		
VL1128A1	D6 BARBED CHECK VALVE	4	PZ																																																																																		
VL1165A0	BB6-AR6 STRAIGHT FITTING	2	PZ																																																																																		
VL1166A0	BB6-AR6 L FITTING	2	PZ																																																																																		

COMPONENT			SPARE PART																																																															
Code	Description	Image	Code	Description	Components list																																																													
VL1054B	ONE WASHING SYS INLET DISTRIBUTOR		KVL2618A	2 ROTOR ARMS ONE CLEANING SYSTEM KIT	<table border="1"> <thead> <tr> <th>Code</th> <th>Description</th> <th>Qty</th> <th>UOM</th> </tr> </thead> <tbody> <tr> <td>VL1174C0</td> <td>D1.2 MM CALIBRATED NOZZLE</td> <td>2</td> <td>PZ</td> </tr> <tr> <td>VL1191A0</td> <td>ONE WASHING DISTRIBUTOR OUTLETS KIT</td> <td>2</td> <td>PZ</td> </tr> <tr> <td>VM2172A0</td> <td>PUMP-WITH-CI RCUIT LOCKING PIN</td> <td>4</td> <td>PZ</td> </tr> </tbody> </table>	Code	Description	Qty	UOM	VL1174C0	D1.2 MM CALIBRATED NOZZLE	2	PZ	VL1191A0	ONE WASHING DISTRIBUTOR OUTLETS KIT	2	PZ	VM2172A0	PUMP-WITH-CI RCUIT LOCKING PIN	4	PZ																																													
			Code	Description	Qty	UOM																																																												
VL1174C0	D1.2 MM CALIBRATED NOZZLE	2	PZ																																																															
VL1191A0	ONE WASHING DISTRIBUTOR OUTLETS KIT	2	PZ																																																															
VM2172A0	PUMP-WITH-CI RCUIT LOCKING PIN	4	PZ																																																															
KVL1225A	US HOOD WASHING SYSTEM KIT	<table border="1"> <thead> <tr> <th>Code</th> <th>Description</th> <th>Qty</th> <th>UOM</th> </tr> </thead> <tbody> <tr> <td>0H2213A1</td> <td></td> <td>1</td> <td>PZ</td> </tr> <tr> <td>EL1450A0</td> <td>US SELF-CLEANIN G WATER SOLENOID</td> <td>2</td> <td>PZ</td> </tr> <tr> <td>GN1526A0</td> <td>INT. D.=6.9 TH=1.8 O-RIN</td> <td>5</td> <td>PZ</td> </tr> <tr> <td>RC1018A0</td> <td>ZINC PLATED D12 ELASTIC CLAMP</td> <td>5</td> <td>PZ</td> </tr> <tr> <td>RC1019A0</td> <td>D=10 ELASTIC CLAMP</td> <td>16</td> <td>PZ</td> </tr> <tr> <td>RC1131A0</td> <td>200X2.6 BLACK CLAMP</td> <td>1</td> <td>PZ</td> </tr> <tr> <td>RC1242A0</td> <td>D=10 CLOSED CAP</td> <td>2</td> <td>PZ</td> </tr> <tr> <td>TB2820A0</td> <td>6X10 EPDM PIPE FOR WASHING SYSTEM</td> <td>2.240</td> <td>M</td> </tr> <tr> <td>TB3132A0</td> <td>WHITE-BLUE EPDM TEXTILE BRAID HOSE 6X12</td> <td>0.440</td> <td>M</td> </tr> <tr> <td>VI1220A1</td> <td>4,2X12 TCB SELF-TAPPIN G SCREW</td> <td>3</td> <td>PZ</td> </tr> <tr> <td>VL1019A0</td> <td>VIBRATION PUMP</td> <td>1</td> <td>PZ</td> </tr> <tr> <td>VL1047A1</td> <td>D6 PIPE HOLDER - D8 J.G. TERMINAL</td> <td>1</td> <td>PZ</td> </tr> <tr> <td>VL1054B0</td> <td>ONE WASHING SYS INLET DISTRIBUTOR</td> <td>1</td> <td>PZ</td> </tr> <tr> <td>VL1102A1</td> <td>DETERGENT LINE FILTER + BARBED VNR 6 MM</td> <td>1</td> <td>PZ</td> </tr> <tr> <td>VL1127A1</td> <td>6MM BARBED T-SHAPED FITTING</td> <td>1</td> <td>PZ</td> </tr> </tbody> </table>	Code	Description	Qty	UOM	0H2213A1		1	PZ	EL1450A0	US SELF-CLEANIN G WATER SOLENOID	2	PZ	GN1526A0	INT. D.=6.9 TH=1.8 O-RIN	5	PZ	RC1018A0	ZINC PLATED D12 ELASTIC CLAMP	5	PZ	RC1019A0	D=10 ELASTIC CLAMP	16	PZ	RC1131A0	200X2.6 BLACK CLAMP	1	PZ	RC1242A0	D=10 CLOSED CAP	2	PZ	TB2820A0	6X10 EPDM PIPE FOR WASHING SYSTEM	2.240	M	TB3132A0	WHITE-BLUE EPDM TEXTILE BRAID HOSE 6X12	0.440	M	VI1220A1	4,2X12 TCB SELF-TAPPIN G SCREW	3	PZ	VL1019A0	VIBRATION PUMP	1	PZ	VL1047A1	D6 PIPE HOLDER - D8 J.G. TERMINAL	1	PZ	VL1054B0	ONE WASHING SYS INLET DISTRIBUTOR	1	PZ	VL1102A1	DETERGENT LINE FILTER + BARBED VNR 6 MM	1	PZ	VL1127A1	6MM BARBED T-SHAPED FITTING	1	PZ
Code	Description	Qty	UOM																																																															
0H2213A1		1	PZ																																																															
EL1450A0	US SELF-CLEANIN G WATER SOLENOID	2	PZ																																																															
GN1526A0	INT. D.=6.9 TH=1.8 O-RIN	5	PZ																																																															
RC1018A0	ZINC PLATED D12 ELASTIC CLAMP	5	PZ																																																															
RC1019A0	D=10 ELASTIC CLAMP	16	PZ																																																															
RC1131A0	200X2.6 BLACK CLAMP	1	PZ																																																															
RC1242A0	D=10 CLOSED CAP	2	PZ																																																															
TB2820A0	6X10 EPDM PIPE FOR WASHING SYSTEM	2.240	M																																																															
TB3132A0	WHITE-BLUE EPDM TEXTILE BRAID HOSE 6X12	0.440	M																																																															
VI1220A1	4,2X12 TCB SELF-TAPPIN G SCREW	3	PZ																																																															
VL1019A0	VIBRATION PUMP	1	PZ																																																															
VL1047A1	D6 PIPE HOLDER - D8 J.G. TERMINAL	1	PZ																																																															
VL1054B0	ONE WASHING SYS INLET DISTRIBUTOR	1	PZ																																																															
VL1102A1	DETERGENT LINE FILTER + BARBED VNR 6 MM	1	PZ																																																															
VL1127A1	6MM BARBED T-SHAPED FITTING	1	PZ																																																															





COMPONENT			SPARE PART																																																			
Code	Description	Image	Code	Description	Components list																																																	
VL1054B	ONE WASHING SYS INLET DISTRIBUTOR		KVL1225A	US HOOD WASHING SYSTEM KIT	<table border="1"> <thead> <tr> <th>Code</th> <th>Description</th> <th>Qty</th> <th>UOM</th> </tr> </thead> <tbody> <tr> <td>VL1128A1</td> <td>D6 BARBED CHECK VALVE</td> <td>2</td> <td>PZ</td> </tr> <tr> <td>VL1165A0</td> <td>BB6-AR6 STRAIGHT FITTING</td> <td>2</td> <td>PZ</td> </tr> <tr> <td>VL1166A0</td> <td>BB6-AR6 L FITTING</td> <td>2</td> <td>PZ</td> </tr> <tr> <td>VL1174C0</td> <td>D1.2 MM CALIBRATED NOZZLE</td> <td>1</td> <td>PZ</td> </tr> <tr> <td>VL1191A0</td> <td>ONE WASHING DISTRIBUTOR OUTLETS KIT</td> <td>1</td> <td>PZ</td> </tr> <tr> <td>VM1605A0</td> <td>CLIP TWIST LOCK DIAM. 10,2-12,7 MM</td> <td>2</td> <td>PZ</td> </tr> <tr> <td>VM2172A0</td> <td>PUMP-WITH-CI RCUIT LOCKING PIN</td> <td>5</td> <td>PZ</td> </tr> </tbody> </table>	Code	Description	Qty	UOM	VL1128A1	D6 BARBED CHECK VALVE	2	PZ	VL1165A0	BB6-AR6 STRAIGHT FITTING	2	PZ	VL1166A0	BB6-AR6 L FITTING	2	PZ	VL1174C0	D1.2 MM CALIBRATED NOZZLE	1	PZ	VL1191A0	ONE WASHING DISTRIBUTOR OUTLETS KIT	1	PZ	VM1605A0	CLIP TWIST LOCK DIAM. 10,2-12,7 MM	2	PZ	VM2172A0	PUMP-WITH-CI RCUIT LOCKING PIN	5	PZ																	
			Code	Description	Qty	UOM																																																
VL1128A1	D6 BARBED CHECK VALVE	2	PZ																																																			
VL1165A0	BB6-AR6 STRAIGHT FITTING	2	PZ																																																			
VL1166A0	BB6-AR6 L FITTING	2	PZ																																																			
VL1174C0	D1.2 MM CALIBRATED NOZZLE	1	PZ																																																			
VL1191A0	ONE WASHING DISTRIBUTOR OUTLETS KIT	1	PZ																																																			
VM1605A0	CLIP TWIST LOCK DIAM. 10,2-12,7 MM	2	PZ																																																			
VM2172A0	PUMP-WITH-CI RCUIT LOCKING PIN	5	PZ																																																			
KVL1222A	EUR 0311 ONE PLUS CLEANING SYSTEM KIT	<table border="1"> <thead> <tr> <th>Code</th> <th>Description</th> <th>Qty</th> <th>UOM</th> </tr> </thead> <tbody> <tr> <td>0H2486A0</td> <td></td> <td>1</td> <td>PZ</td> </tr> <tr> <td>EL1440A0</td> <td>WATER SELF CLEANING VALVE</td> <td>1</td> <td>PZ</td> </tr> <tr> <td>GN1526A0</td> <td>INT. D.=6.9 TH=1.8 O-RIN</td> <td>3</td> <td>PZ</td> </tr> <tr> <td>RC1018A0</td> <td>ZINC PLATED D12 ELASTIC CLAMP</td> <td>2</td> <td>PZ</td> </tr> <tr> <td>RC1019A0</td> <td>D=10 ELASTIC CLAMP</td> <td>14</td> <td>PZ</td> </tr> <tr> <td>RC1242A0</td> <td>D=10 CLOSED CAP</td> <td>2</td> <td>PZ</td> </tr> <tr> <td>TB2820A0</td> <td>6X10 EPDM PIPE FOR WASHING SYSTEM</td> <td>1.460</td> <td>M</td> </tr> <tr> <td>TB3132A0</td> <td>WHITE-BLUE EPDM TEXTILE BRAID HOSE 6X12</td> <td>0.670</td> <td>M</td> </tr> <tr> <td>VI1220A1</td> <td>4,2X12 TCB SELF-TAPPIN G SCREW</td> <td>4</td> <td>PZ</td> </tr> <tr> <td>VL1019A0</td> <td>VIBRATION PUMP</td> <td>1</td> <td>PZ</td> </tr> <tr> <td>VL1047A1</td> <td>D6 PIPE HOLDER - D8 J.G. TERMINAL</td> <td>1</td> <td>PZ</td> </tr> <tr> <td>VL1054B0</td> <td>ONE WASHING SYS INLET DISTRIBUTOR</td> <td>1</td> <td>PZ</td> </tr> </tbody> </table>	Code	Description	Qty	UOM	0H2486A0		1	PZ	EL1440A0	WATER SELF CLEANING VALVE	1	PZ	GN1526A0	INT. D.=6.9 TH=1.8 O-RIN	3	PZ	RC1018A0	ZINC PLATED D12 ELASTIC CLAMP	2	PZ	RC1019A0	D=10 ELASTIC CLAMP	14	PZ	RC1242A0	D=10 CLOSED CAP	2	PZ	TB2820A0	6X10 EPDM PIPE FOR WASHING SYSTEM	1.460	M	TB3132A0	WHITE-BLUE EPDM TEXTILE BRAID HOSE 6X12	0.670	M	VI1220A1	4,2X12 TCB SELF-TAPPIN G SCREW	4	PZ	VL1019A0	VIBRATION PUMP	1	PZ	VL1047A1	D6 PIPE HOLDER - D8 J.G. TERMINAL	1	PZ	VL1054B0	ONE WASHING SYS INLET DISTRIBUTOR	1	PZ
Code	Description	Qty	UOM																																																			
0H2486A0		1	PZ																																																			
EL1440A0	WATER SELF CLEANING VALVE	1	PZ																																																			
GN1526A0	INT. D.=6.9 TH=1.8 O-RIN	3	PZ																																																			
RC1018A0	ZINC PLATED D12 ELASTIC CLAMP	2	PZ																																																			
RC1019A0	D=10 ELASTIC CLAMP	14	PZ																																																			
RC1242A0	D=10 CLOSED CAP	2	PZ																																																			
TB2820A0	6X10 EPDM PIPE FOR WASHING SYSTEM	1.460	M																																																			
TB3132A0	WHITE-BLUE EPDM TEXTILE BRAID HOSE 6X12	0.670	M																																																			
VI1220A1	4,2X12 TCB SELF-TAPPIN G SCREW	4	PZ																																																			
VL1019A0	VIBRATION PUMP	1	PZ																																																			
VL1047A1	D6 PIPE HOLDER - D8 J.G. TERMINAL	1	PZ																																																			
VL1054B0	ONE WASHING SYS INLET DISTRIBUTOR	1	PZ																																																			



COMPONENT			SPARE PART																																																			
Code	Description	Image	Code	Description	Components list																																																	
VL1054B	ONE WASHING SYS INLET DISTRIBUTOR		KVL1222A	EUR 0311 ONE PLUS CLEANING SYSTEM KIT	<table border="1"> <thead> <tr> <th>Code</th> <th>Description</th> <th>Qty</th> <th>UOM</th> </tr> </thead> <tbody> <tr> <td>VL1102A1</td> <td>DETERGENT LINE FILTER + BARBED VNR 6 MM</td> <td>1</td> <td>PZ</td> </tr> <tr> <td>VL1128A1</td> <td>D6 BARBED CHECK VALVE</td> <td>2</td> <td>PZ</td> </tr> <tr> <td>VL1165A0</td> <td>BB6-AR6 STRAIGHT FITTING</td> <td>1</td> <td>PZ</td> </tr> <tr> <td>VL1166A0</td> <td>BB6-AR6 L FITTING</td> <td>1</td> <td>PZ</td> </tr> <tr> <td>VL1174C0</td> <td>D1.2 MM CALIBRATED NOZZLE</td> <td>1</td> <td>PZ</td> </tr> <tr> <td>VL1191A0</td> <td>ONE WASHING DISTRIBUTOR OUTLETS KIT</td> <td>1</td> <td>PZ</td> </tr> <tr> <td>VM2172A0</td> <td>PUMP-WITH-CI RCUIT LOCKING PIN</td> <td>3</td> <td>PZ</td> </tr> </tbody> </table>	Code	Description	Qty	UOM	VL1102A1	DETERGENT LINE FILTER + BARBED VNR 6 MM	1	PZ	VL1128A1	D6 BARBED CHECK VALVE	2	PZ	VL1165A0	BB6-AR6 STRAIGHT FITTING	1	PZ	VL1166A0	BB6-AR6 L FITTING	1	PZ	VL1174C0	D1.2 MM CALIBRATED NOZZLE	1	PZ	VL1191A0	ONE WASHING DISTRIBUTOR OUTLETS KIT	1	PZ	VM2172A0	PUMP-WITH-CI RCUIT LOCKING PIN	3	PZ																	
			Code	Description	Qty	UOM																																																
VL1102A1	DETERGENT LINE FILTER + BARBED VNR 6 MM	1	PZ																																																			
VL1128A1	D6 BARBED CHECK VALVE	2	PZ																																																			
VL1165A0	BB6-AR6 STRAIGHT FITTING	1	PZ																																																			
VL1166A0	BB6-AR6 L FITTING	1	PZ																																																			
VL1174C0	D1.2 MM CALIBRATED NOZZLE	1	PZ																																																			
VL1191A0	ONE WASHING DISTRIBUTOR OUTLETS KIT	1	PZ																																																			
VM2172A0	PUMP-WITH-CI RCUIT LOCKING PIN	3	PZ																																																			
KVL1213A	US PLUS COMPACT WASHING SYSTEM KIT	<table border="1"> <thead> <tr> <th>Code</th> <th>Description</th> <th>Qty</th> <th>UOM</th> </tr> </thead> <tbody> <tr> <td>0H2428A0</td> <td></td> <td>1</td> <td>PZ</td> </tr> <tr> <td>EL1450A0</td> <td>US SELF-CLEANIN G WATER SOLENOID</td> <td>3</td> <td>PZ</td> </tr> <tr> <td>GN1312A0</td> <td>RUBBER CABLE-PASSI NG DE=26 DI=15 SP=10</td> <td>1</td> <td>PZ</td> </tr> <tr> <td>GN1526A0</td> <td>INT. D.=6.9 TH=1.8 O-RIN</td> <td>7</td> <td>PZ</td> </tr> <tr> <td>RC1018A0</td> <td>ZINC PLATED D12 ELASTIC CLAMP</td> <td>3</td> <td>PZ</td> </tr> <tr> <td>RC1019A0</td> <td>D=10 ELASTIC CLAMP</td> <td>14</td> <td>PZ</td> </tr> <tr> <td>RC1130A0</td> <td>130X2.6 CLAM</td> <td>1</td> <td>PZ</td> </tr> <tr> <td>RC1131A0</td> <td>200X2.6 BLACK CLAMP</td> <td>1</td> <td>PZ</td> </tr> <tr> <td>RC1242A0</td> <td>D=10 CLOSED CAP</td> <td>2</td> <td>PZ</td> </tr> <tr> <td>RC1356A0</td> <td>"STRAIGHT THREADED FEMALE END 8X1/4" BS</td> <td>1</td> <td>PZ</td> </tr> <tr> <td>TB2820A0</td> <td>6X10 EPDM PIPE FOR WASHING SYSTEM</td> <td>0.790</td> <td>M</td> </tr> <tr> <td>TB3132A0</td> <td>WHITE-BLUE EPDM TEXTILE BRAID HOSE 6X12</td> <td>1.400</td> <td>M</td> </tr> </tbody> </table>	Code	Description	Qty	UOM	0H2428A0		1	PZ	EL1450A0	US SELF-CLEANIN G WATER SOLENOID	3	PZ	GN1312A0	RUBBER CABLE-PASSI NG DE=26 DI=15 SP=10	1	PZ	GN1526A0	INT. D.=6.9 TH=1.8 O-RIN	7	PZ	RC1018A0	ZINC PLATED D12 ELASTIC CLAMP	3	PZ	RC1019A0	D=10 ELASTIC CLAMP	14	PZ	RC1130A0	130X2.6 CLAM	1	PZ	RC1131A0	200X2.6 BLACK CLAMP	1	PZ	RC1242A0	D=10 CLOSED CAP	2	PZ	RC1356A0	"STRAIGHT THREADED FEMALE END 8X1/4" BS	1	PZ	TB2820A0	6X10 EPDM PIPE FOR WASHING SYSTEM	0.790	M	TB3132A0	WHITE-BLUE EPDM TEXTILE BRAID HOSE 6X12	1.400	M
Code	Description	Qty	UOM																																																			
0H2428A0		1	PZ																																																			
EL1450A0	US SELF-CLEANIN G WATER SOLENOID	3	PZ																																																			
GN1312A0	RUBBER CABLE-PASSI NG DE=26 DI=15 SP=10	1	PZ																																																			
GN1526A0	INT. D.=6.9 TH=1.8 O-RIN	7	PZ																																																			
RC1018A0	ZINC PLATED D12 ELASTIC CLAMP	3	PZ																																																			
RC1019A0	D=10 ELASTIC CLAMP	14	PZ																																																			
RC1130A0	130X2.6 CLAM	1	PZ																																																			
RC1131A0	200X2.6 BLACK CLAMP	1	PZ																																																			
RC1242A0	D=10 CLOSED CAP	2	PZ																																																			
RC1356A0	"STRAIGHT THREADED FEMALE END 8X1/4" BS	1	PZ																																																			
TB2820A0	6X10 EPDM PIPE FOR WASHING SYSTEM	0.790	M																																																			
TB3132A0	WHITE-BLUE EPDM TEXTILE BRAID HOSE 6X12	1.400	M																																																			



COMPONENT			SPARE PART																																																																																													
Code	Description	Image	Code	Description	Components list																																																																																											
VL1054B	ONE WASHING SYS INLET DISTRIBUTOR		KVL1213A	US PLUS COMPACT WASHING SYSTEM KIT	<table border="1"> <thead> <tr> <th>Code</th> <th>Description</th> <th>Qty</th> <th>UOM</th> </tr> </thead> <tbody> <tr> <td>VI1220A1</td> <td>4,2X12 TCB SELF-TAPPIN G SCREW</td> <td>3</td> <td>PZ</td> </tr> <tr> <td>VL1019A0</td> <td>VIBRATION PUMP</td> <td>1</td> <td>PZ</td> </tr> <tr> <td>VL1047A1</td> <td>D6 PIPE HOLDER - D8 J.G. TERMINAL</td> <td>1</td> <td>PZ</td> </tr> <tr> <td>VL1054B0</td> <td>ONE WASHING SYS INLET DISTRIBUTOR</td> <td>1</td> <td>PZ</td> </tr> <tr> <td>VL1065A1</td> <td>1/4 MALE N.O. PRESSURE SWITCH</td> <td>1</td> <td>PZ</td> </tr> <tr> <td>VL1102A1</td> <td>DETERGENT LINE FILTER + BARBED VNR 6 MM</td> <td>1</td> <td>PZ</td> </tr> <tr> <td>VL1128A1</td> <td>D6 BARBED CHECK VALVE</td> <td>2</td> <td>PZ</td> </tr> <tr> <td>VL1165A0</td> <td>BB6-AR6 STRAIGHT FITTING</td> <td>1</td> <td>PZ</td> </tr> <tr> <td>VL1166A0</td> <td>BB6-AR6 L FITTING</td> <td>3</td> <td>PZ</td> </tr> <tr> <td>VL1174C0</td> <td>D1.2 MM CALIBRATED NOZZLE</td> <td>1</td> <td>PZ</td> </tr> <tr> <td>VL1185A0</td> <td>2 WAYS PLUS WASHING DISTRIBUTOR</td> <td>1</td> <td>PZ</td> </tr> <tr> <td>VM2172A0</td> <td>PUMP-WITH-CI RCUIT LOCKING PIN</td> <td>6</td> <td>PZ</td> </tr> </tbody> </table>	Code	Description	Qty	UOM	VI1220A1	4,2X12 TCB SELF-TAPPIN G SCREW	3	PZ	VL1019A0	VIBRATION PUMP	1	PZ	VL1047A1	D6 PIPE HOLDER - D8 J.G. TERMINAL	1	PZ	VL1054B0	ONE WASHING SYS INLET DISTRIBUTOR	1	PZ	VL1065A1	1/4 MALE N.O. PRESSURE SWITCH	1	PZ	VL1102A1	DETERGENT LINE FILTER + BARBED VNR 6 MM	1	PZ	VL1128A1	D6 BARBED CHECK VALVE	2	PZ	VL1165A0	BB6-AR6 STRAIGHT FITTING	1	PZ	VL1166A0	BB6-AR6 L FITTING	3	PZ	VL1174C0	D1.2 MM CALIBRATED NOZZLE	1	PZ	VL1185A0	2 WAYS PLUS WASHING DISTRIBUTOR	1	PZ	VM2172A0	PUMP-WITH-CI RCUIT LOCKING PIN	6	PZ	KVL1212A	EUR COMPACT PLUS CLEANING SYSTEM KIT	<table border="1"> <thead> <tr> <th>Code</th> <th>Description</th> <th>Qty</th> <th>UOM</th> </tr> </thead> <tbody> <tr> <td>0H2428A0</td> <td></td> <td>1</td> <td>PZ</td> </tr> <tr> <td>EL1440A0</td> <td>WATER SELF CLEANING VALVE</td> <td>3</td> <td>PZ</td> </tr> <tr> <td>GN1312A0</td> <td>RUBBER CABLE-PASSI NG DE=26 DI=15 SP=10</td> <td>1</td> <td>PZ</td> </tr> <tr> <td>GN1526A0</td> <td>INT. D.=6.9 TH=1.8 O-RIN</td> <td>7</td> <td>PZ</td> </tr> <tr> <td>RC1018A0</td> <td>ZINC PLATED D12 ELASTIC CLAMP</td> <td>3</td> <td>PZ</td> </tr> <tr> <td>RC1019A0</td> <td>D=10 ELASTIC CLAMP</td> <td>14</td> <td>PZ</td> </tr> <tr> <td>RC1130A0</td> <td>130X2,6 CLAM</td> <td>1</td> <td>PZ</td> </tr> <tr> <td>RC1131A0</td> <td>200X2.6 BLACK CLAMP</td> <td>1</td> <td>PZ</td> </tr> </tbody> </table>	Code	Description	Qty	UOM	0H2428A0		1	PZ	EL1440A0	WATER SELF CLEANING VALVE	3	PZ	GN1312A0	RUBBER CABLE-PASSI NG DE=26 DI=15 SP=10	1	PZ	GN1526A0	INT. D.=6.9 TH=1.8 O-RIN	7	PZ	RC1018A0	ZINC PLATED D12 ELASTIC CLAMP	3	PZ	RC1019A0	D=10 ELASTIC CLAMP	14	PZ	RC1130A0	130X2,6 CLAM	1	PZ	RC1131A0	200X2.6 BLACK CLAMP	1	PZ
			Code	Description	Qty	UOM																																																																																										
VI1220A1	4,2X12 TCB SELF-TAPPIN G SCREW	3	PZ																																																																																													
VL1019A0	VIBRATION PUMP	1	PZ																																																																																													
VL1047A1	D6 PIPE HOLDER - D8 J.G. TERMINAL	1	PZ																																																																																													
VL1054B0	ONE WASHING SYS INLET DISTRIBUTOR	1	PZ																																																																																													
VL1065A1	1/4 MALE N.O. PRESSURE SWITCH	1	PZ																																																																																													
VL1102A1	DETERGENT LINE FILTER + BARBED VNR 6 MM	1	PZ																																																																																													
VL1128A1	D6 BARBED CHECK VALVE	2	PZ																																																																																													
VL1165A0	BB6-AR6 STRAIGHT FITTING	1	PZ																																																																																													
VL1166A0	BB6-AR6 L FITTING	3	PZ																																																																																													
VL1174C0	D1.2 MM CALIBRATED NOZZLE	1	PZ																																																																																													
VL1185A0	2 WAYS PLUS WASHING DISTRIBUTOR	1	PZ																																																																																													
VM2172A0	PUMP-WITH-CI RCUIT LOCKING PIN	6	PZ																																																																																													
Code	Description	Qty	UOM																																																																																													
0H2428A0		1	PZ																																																																																													
EL1440A0	WATER SELF CLEANING VALVE	3	PZ																																																																																													
GN1312A0	RUBBER CABLE-PASSI NG DE=26 DI=15 SP=10	1	PZ																																																																																													
GN1526A0	INT. D.=6.9 TH=1.8 O-RIN	7	PZ																																																																																													
RC1018A0	ZINC PLATED D12 ELASTIC CLAMP	3	PZ																																																																																													
RC1019A0	D=10 ELASTIC CLAMP	14	PZ																																																																																													
RC1130A0	130X2,6 CLAM	1	PZ																																																																																													
RC1131A0	200X2.6 BLACK CLAMP	1	PZ																																																																																													

COMPONENT			SPARE PART																																																																																					
Code	Description	Image	Code	Description	Components list																																																																																			
VL1054B	ONE WASHING SYS INLET DISTRIBUTOR		KVL1212A	EUR COMPACT PLUS CLEANING SYSTEM KIT	<table border="1"> <thead> <tr> <th>Code</th> <th>Description</th> <th>Qty</th> <th>UOM</th> </tr> </thead> <tbody> <tr> <td>RC1242A0</td> <td>D=10 CLOSED CAP</td> <td>2</td> <td>PZ</td> </tr> <tr> <td>RC1356A0</td> <td>"STRAIGHT THREADED FEMALE END 8X1/4" BS</td> <td>1</td> <td>PZ</td> </tr> <tr> <td>TB2820A0</td> <td>6X10 EPDM PIPE FOR WASHING SYSTEM</td> <td>1.340</td> <td>M</td> </tr> <tr> <td>TB3132A0</td> <td>WHITE-BLUE EPDM TEXTILE BRAID HOSE 6X12</td> <td>1.400</td> <td>M</td> </tr> <tr> <td>VI1220A1</td> <td>4,2X12 TCB SELF-TAPPIN G SCREW</td> <td>3</td> <td>PZ</td> </tr> <tr> <td>VL1019A0</td> <td>VIBRATION PUMP</td> <td>1</td> <td>PZ</td> </tr> <tr> <td>VL1047A1</td> <td>D6 PIPE HOLDER - D8 J.G. TERMINAL</td> <td>1</td> <td>PZ</td> </tr> <tr> <td>VL1054B0</td> <td>ONE WASHING SYS INLET DISTRIBUTOR</td> <td>1</td> <td>PZ</td> </tr> <tr> <td>VL1065A1</td> <td>1/4 MALE N.O. PRESSURE SWITCH</td> <td>1</td> <td>PZ</td> </tr> <tr> <td>VL1102A1</td> <td>DETERGENT LINE FILTER + BARBED VNR 6 MM</td> <td>1</td> <td>PZ</td> </tr> <tr> <td>VL1128A1</td> <td>D6 BARBED CHECK VALVE</td> <td>2</td> <td>PZ</td> </tr> <tr> <td>VL1165A0</td> <td>BB6-AR6 STRAIGHT FITTING</td> <td>1</td> <td>PZ</td> </tr> <tr> <td>VL1166A0</td> <td>BB6-AR6 L FITTING</td> <td>3</td> <td>PZ</td> </tr> <tr> <td>VL1174C0</td> <td>D1.2 MM CALIBRATED NOZZLE</td> <td>1</td> <td>PZ</td> </tr> <tr> <td>VL1185A0</td> <td>2 WAYS PLUS WASHING DISTRIBUTOR</td> <td>1</td> <td>PZ</td> </tr> <tr> <td>VM2172A0</td> <td>PUMP-WITH-CI RCUIT LOCKING PIN</td> <td>6</td> <td>PZ</td> </tr> </tbody> </table>	Code	Description	Qty	UOM	RC1242A0	D=10 CLOSED CAP	2	PZ	RC1356A0	"STRAIGHT THREADED FEMALE END 8X1/4" BS	1	PZ	TB2820A0	6X10 EPDM PIPE FOR WASHING SYSTEM	1.340	M	TB3132A0	WHITE-BLUE EPDM TEXTILE BRAID HOSE 6X12	1.400	M	VI1220A1	4,2X12 TCB SELF-TAPPIN G SCREW	3	PZ	VL1019A0	VIBRATION PUMP	1	PZ	VL1047A1	D6 PIPE HOLDER - D8 J.G. TERMINAL	1	PZ	VL1054B0	ONE WASHING SYS INLET DISTRIBUTOR	1	PZ	VL1065A1	1/4 MALE N.O. PRESSURE SWITCH	1	PZ	VL1102A1	DETERGENT LINE FILTER + BARBED VNR 6 MM	1	PZ	VL1128A1	D6 BARBED CHECK VALVE	2	PZ	VL1165A0	BB6-AR6 STRAIGHT FITTING	1	PZ	VL1166A0	BB6-AR6 L FITTING	3	PZ	VL1174C0	D1.2 MM CALIBRATED NOZZLE	1	PZ	VL1185A0	2 WAYS PLUS WASHING DISTRIBUTOR	1	PZ	VM2172A0	PUMP-WITH-CI RCUIT LOCKING PIN	6	PZ	KVL1211A	ONE COMPACT AND 0523-EP WASH. SYSTEM KIT	<table border="1"> <thead> <tr> <th>Code</th> <th>Description</th> <th>Qty</th> <th>UOM</th> </tr> </thead> <tbody> <tr> <td>0H2427A0</td> <td></td> <td>1</td> <td>PZ</td> </tr> <tr> <td>EL1440A0</td> <td>WATER SELF CLEANING VALVE</td> <td>1</td> <td>PZ</td> </tr> </tbody> </table>	Code	Description	Qty	UOM	0H2427A0		1	PZ	EL1440A0	WATER SELF CLEANING VALVE	1	PZ
			Code	Description	Qty	UOM																																																																																		
RC1242A0	D=10 CLOSED CAP	2	PZ																																																																																					
RC1356A0	"STRAIGHT THREADED FEMALE END 8X1/4" BS	1	PZ																																																																																					
TB2820A0	6X10 EPDM PIPE FOR WASHING SYSTEM	1.340	M																																																																																					
TB3132A0	WHITE-BLUE EPDM TEXTILE BRAID HOSE 6X12	1.400	M																																																																																					
VI1220A1	4,2X12 TCB SELF-TAPPIN G SCREW	3	PZ																																																																																					
VL1019A0	VIBRATION PUMP	1	PZ																																																																																					
VL1047A1	D6 PIPE HOLDER - D8 J.G. TERMINAL	1	PZ																																																																																					
VL1054B0	ONE WASHING SYS INLET DISTRIBUTOR	1	PZ																																																																																					
VL1065A1	1/4 MALE N.O. PRESSURE SWITCH	1	PZ																																																																																					
VL1102A1	DETERGENT LINE FILTER + BARBED VNR 6 MM	1	PZ																																																																																					
VL1128A1	D6 BARBED CHECK VALVE	2	PZ																																																																																					
VL1165A0	BB6-AR6 STRAIGHT FITTING	1	PZ																																																																																					
VL1166A0	BB6-AR6 L FITTING	3	PZ																																																																																					
VL1174C0	D1.2 MM CALIBRATED NOZZLE	1	PZ																																																																																					
VL1185A0	2 WAYS PLUS WASHING DISTRIBUTOR	1	PZ																																																																																					
VM2172A0	PUMP-WITH-CI RCUIT LOCKING PIN	6	PZ																																																																																					
Code	Description	Qty	UOM																																																																																					
0H2427A0		1	PZ																																																																																					
EL1440A0	WATER SELF CLEANING VALVE	1	PZ																																																																																					







COMPONENT			SPARE PART																																																																														
Code	Description	Image	Code	Description	Components list																																																																												
VL1054B	ONE WASHING SYS INLET DISTRIBUTOR		KVL1211A	ONE COMPACT AND 0523-EP WASH. SYSTEM KIT	<table border="1"> <thead> <tr> <th>Code</th> <th>Description</th> <th>Qty</th> <th>UOM</th> </tr> </thead> <tbody> <tr> <td>GN1526A0</td> <td>INT. D.=6.9 TH=1.8 O-RIN</td> <td>3</td> <td>PZ</td> </tr> <tr> <td>RC1018A0</td> <td>ZINC PLATED D12 ELASTIC CLAMP</td> <td>2</td> <td>PZ</td> </tr> <tr> <td>RC1019A0</td> <td>D=10 ELASTIC CLAMP</td> <td>14</td> <td>PZ</td> </tr> <tr> <td>RC1130A0</td> <td>130X2,6 CLAM</td> <td>1</td> <td>PZ</td> </tr> <tr> <td>RC1242A0</td> <td>D=10 CLOSED CAP</td> <td>2</td> <td>PZ</td> </tr> <tr> <td>TB2820A0</td> <td>6X10 EPDM PIPE FOR WASHING SYSTEM</td> <td>1.290</td> <td>M</td> </tr> <tr> <td>TB3132A0</td> <td>WHITE-BLUE EPDM TEXTILE BRAID HOSE 6X12</td> <td>0.670</td> <td>M</td> </tr> <tr> <td>VI1220A1</td> <td>4,2X12 TCB SELF-TAPPIN G.SCREW</td> <td>4</td> <td>PZ</td> </tr> <tr> <td>VL1019A0</td> <td>VIBRATION PUMP</td> <td>1</td> <td>PZ</td> </tr> <tr> <td>VL1047A1</td> <td>D6 PIPE HOLDER - D8 J.G. TERMINAL</td> <td>1</td> <td>PZ</td> </tr> <tr> <td>VL1054B0</td> <td>ONE WASHING SYS INLET DISTRIBUTOR</td> <td>1</td> <td>PZ</td> </tr> <tr> <td>VL1102A1</td> <td>DETERGENT LINE FILTER + BARBED VNR 6 MM</td> <td>1</td> <td>PZ</td> </tr> <tr> <td>VL1128A1</td> <td>D6 BARBED CHECK VALVE</td> <td>2</td> <td>PZ</td> </tr> <tr> <td>VL1165A0</td> <td>BB6-AR6 STRAIGHT FITTING</td> <td>1</td> <td>PZ</td> </tr> <tr> <td>VL1166A0</td> <td>BB6-AR6 L FITTING</td> <td>1</td> <td>PZ</td> </tr> <tr> <td>VL1174C0</td> <td>D1.2 MM CALIBRATED NOZZLE</td> <td>1</td> <td>PZ</td> </tr> <tr> <td>VL1191A0</td> <td>ONE WASHING DISTRIBUTOR OUTLETS KIT</td> <td>1</td> <td>PZ</td> </tr> <tr> <td>VM2172A0</td> <td>PUMP-WITH-CI RCUIT LOCKING PIN</td> <td>3</td> <td>PZ</td> </tr> </tbody> </table>	Code	Description	Qty	UOM	GN1526A0	INT. D.=6.9 TH=1.8 O-RIN	3	PZ	RC1018A0	ZINC PLATED D12 ELASTIC CLAMP	2	PZ	RC1019A0	D=10 ELASTIC CLAMP	14	PZ	RC1130A0	130X2,6 CLAM	1	PZ	RC1242A0	D=10 CLOSED CAP	2	PZ	TB2820A0	6X10 EPDM PIPE FOR WASHING SYSTEM	1.290	M	TB3132A0	WHITE-BLUE EPDM TEXTILE BRAID HOSE 6X12	0.670	M	VI1220A1	4,2X12 TCB SELF-TAPPIN G.SCREW	4	PZ	VL1019A0	VIBRATION PUMP	1	PZ	VL1047A1	D6 PIPE HOLDER - D8 J.G. TERMINAL	1	PZ	VL1054B0	ONE WASHING SYS INLET DISTRIBUTOR	1	PZ	VL1102A1	DETERGENT LINE FILTER + BARBED VNR 6 MM	1	PZ	VL1128A1	D6 BARBED CHECK VALVE	2	PZ	VL1165A0	BB6-AR6 STRAIGHT FITTING	1	PZ	VL1166A0	BB6-AR6 L FITTING	1	PZ	VL1174C0	D1.2 MM CALIBRATED NOZZLE	1	PZ	VL1191A0	ONE WASHING DISTRIBUTOR OUTLETS KIT	1	PZ	VM2172A0	PUMP-WITH-CI RCUIT LOCKING PIN	3	PZ
					Code	Description	Qty	UOM																																																																									
					GN1526A0	INT. D.=6.9 TH=1.8 O-RIN	3	PZ																																																																									
					RC1018A0	ZINC PLATED D12 ELASTIC CLAMP	2	PZ																																																																									
					RC1019A0	D=10 ELASTIC CLAMP	14	PZ																																																																									
					RC1130A0	130X2,6 CLAM	1	PZ																																																																									
					RC1242A0	D=10 CLOSED CAP	2	PZ																																																																									
					TB2820A0	6X10 EPDM PIPE FOR WASHING SYSTEM	1.290	M																																																																									
					TB3132A0	WHITE-BLUE EPDM TEXTILE BRAID HOSE 6X12	0.670	M																																																																									
					VI1220A1	4,2X12 TCB SELF-TAPPIN G.SCREW	4	PZ																																																																									
					VL1019A0	VIBRATION PUMP	1	PZ																																																																									
					VL1047A1	D6 PIPE HOLDER - D8 J.G. TERMINAL	1	PZ																																																																									
					VL1054B0	ONE WASHING SYS INLET DISTRIBUTOR	1	PZ																																																																									
					VL1102A1	DETERGENT LINE FILTER + BARBED VNR 6 MM	1	PZ																																																																									
					VL1128A1	D6 BARBED CHECK VALVE	2	PZ																																																																									
					VL1165A0	BB6-AR6 STRAIGHT FITTING	1	PZ																																																																									
					VL1166A0	BB6-AR6 L FITTING	1	PZ																																																																									
					VL1174C0	D1.2 MM CALIBRATED NOZZLE	1	PZ																																																																									
					VL1191A0	ONE WASHING DISTRIBUTOR OUTLETS KIT	1	PZ																																																																									
					VM2172A0	PUMP-WITH-CI RCUIT LOCKING PIN	3	PZ																																																																									







COMPONENT			SPARE PART																																																																																		
Code	Description	Image	Code	Description	Components list																																																																																
VL1054B	ONE WASHING SYS INLET DISTRIBUTOR		KVL1198A	MM EU HOOD CLEANING SYSTEM KIT	<table border="1"> <thead> <tr> <th>Code</th> <th>Description</th> <th>Qty</th> <th>UOM</th> </tr> </thead> <tbody> <tr> <td>0H2213A1</td> <td></td> <td>1</td> <td>PZ</td> </tr> <tr> <td>EL1440A0</td> <td>WATER SELF CLEANING VALVE</td> <td>2</td> <td>PZ</td> </tr> <tr> <td>GN1526A0</td> <td>INT. D.=6.9 TH=1.8 O-RIN</td> <td>5</td> <td>PZ</td> </tr> <tr> <td>RC1018A0</td> <td>ZINC PLATED D12 ELASTIC CLAMP</td> <td>6</td> <td>PZ</td> </tr> <tr> <td>RC1019A0</td> <td>D=10 ELASTIC CLAMP</td> <td>16</td> <td>PZ</td> </tr> <tr> <td>RC1131A0</td> <td>200X2.6 BLACK CLAMP</td> <td>1</td> <td>PZ</td> </tr> <tr> <td>RC1242A0</td> <td>D=10 CLOSED CAP</td> <td>2</td> <td>PZ</td> </tr> <tr> <td>TB2820A0</td> <td>6X10 EPDM PIPE FOR WASHING SYSTEM</td> <td>2.240</td> <td>M</td> </tr> <tr> <td>TB3132A0</td> <td>WHITE-BLUE EPDM TEXTILE BRAID HOSE 6X12</td> <td>0.440</td> <td>M</td> </tr> <tr> <td>VI1220A1</td> <td>4,2X12 TCB SELF-TAPPIN G SCREW</td> <td>3</td> <td>PZ</td> </tr> <tr> <td>VL1019A0</td> <td>VIBRATION PUMP</td> <td>1</td> <td>PZ</td> </tr> <tr> <td>VL1047A1</td> <td>D6 PIPE HOLDER - D8 J.G. TERMINAL</td> <td>2</td> <td>PZ</td> </tr> <tr> <td>VL1054B0</td> <td>ONE WASHING SYS INLET DISTRIBUTOR</td> <td>1</td> <td>PZ</td> </tr> <tr> <td>VL1102A1</td> <td>DETERGENT LINE FILTER + BARBED VNR 6 MM</td> <td>1</td> <td>PZ</td> </tr> <tr> <td>VL1127A1</td> <td>6MM BARBED T-SHAPED FITTING</td> <td>1</td> <td>PZ</td> </tr> <tr> <td>VL1128A1</td> <td>D6 BARBED CHECK VALVE</td> <td>2</td> <td>PZ</td> </tr> <tr> <td>VL1165A0</td> <td>BB6-AR6 STRAIGHT FITTING</td> <td>2</td> <td>PZ</td> </tr> <tr> <td>VL1166A0</td> <td>BB6-AR6 L FITTING</td> <td>2</td> <td>PZ</td> </tr> <tr> <td>VL1174C0</td> <td>D1.2 MM CALIBRATED NOZZLE</td> <td>1</td> <td>PZ</td> </tr> </tbody> </table>	Code	Description	Qty	UOM	0H2213A1		1	PZ	EL1440A0	WATER SELF CLEANING VALVE	2	PZ	GN1526A0	INT. D.=6.9 TH=1.8 O-RIN	5	PZ	RC1018A0	ZINC PLATED D12 ELASTIC CLAMP	6	PZ	RC1019A0	D=10 ELASTIC CLAMP	16	PZ	RC1131A0	200X2.6 BLACK CLAMP	1	PZ	RC1242A0	D=10 CLOSED CAP	2	PZ	TB2820A0	6X10 EPDM PIPE FOR WASHING SYSTEM	2.240	M	TB3132A0	WHITE-BLUE EPDM TEXTILE BRAID HOSE 6X12	0.440	M	VI1220A1	4,2X12 TCB SELF-TAPPIN G SCREW	3	PZ	VL1019A0	VIBRATION PUMP	1	PZ	VL1047A1	D6 PIPE HOLDER - D8 J.G. TERMINAL	2	PZ	VL1054B0	ONE WASHING SYS INLET DISTRIBUTOR	1	PZ	VL1102A1	DETERGENT LINE FILTER + BARBED VNR 6 MM	1	PZ	VL1127A1	6MM BARBED T-SHAPED FITTING	1	PZ	VL1128A1	D6 BARBED CHECK VALVE	2	PZ	VL1165A0	BB6-AR6 STRAIGHT FITTING	2	PZ	VL1166A0	BB6-AR6 L FITTING	2	PZ	VL1174C0	D1.2 MM CALIBRATED NOZZLE	1	PZ
Code	Description	Qty	UOM																																																																																		
0H2213A1		1	PZ																																																																																		
EL1440A0	WATER SELF CLEANING VALVE	2	PZ																																																																																		
GN1526A0	INT. D.=6.9 TH=1.8 O-RIN	5	PZ																																																																																		
RC1018A0	ZINC PLATED D12 ELASTIC CLAMP	6	PZ																																																																																		
RC1019A0	D=10 ELASTIC CLAMP	16	PZ																																																																																		
RC1131A0	200X2.6 BLACK CLAMP	1	PZ																																																																																		
RC1242A0	D=10 CLOSED CAP	2	PZ																																																																																		
TB2820A0	6X10 EPDM PIPE FOR WASHING SYSTEM	2.240	M																																																																																		
TB3132A0	WHITE-BLUE EPDM TEXTILE BRAID HOSE 6X12	0.440	M																																																																																		
VI1220A1	4,2X12 TCB SELF-TAPPIN G SCREW	3	PZ																																																																																		
VL1019A0	VIBRATION PUMP	1	PZ																																																																																		
VL1047A1	D6 PIPE HOLDER - D8 J.G. TERMINAL	2	PZ																																																																																		
VL1054B0	ONE WASHING SYS INLET DISTRIBUTOR	1	PZ																																																																																		
VL1102A1	DETERGENT LINE FILTER + BARBED VNR 6 MM	1	PZ																																																																																		
VL1127A1	6MM BARBED T-SHAPED FITTING	1	PZ																																																																																		
VL1128A1	D6 BARBED CHECK VALVE	2	PZ																																																																																		
VL1165A0	BB6-AR6 STRAIGHT FITTING	2	PZ																																																																																		
VL1166A0	BB6-AR6 L FITTING	2	PZ																																																																																		
VL1174C0	D1.2 MM CALIBRATED NOZZLE	1	PZ																																																																																		

COMPONENT			SPARE PART																																																											
Code	Description	Image	Code	Description	Components list																																																									
VL1054B	ONE WASHING SYS INLET DISTRIBUTOR		KVL1198A	MM EU HOOD CLEANING SYSTEM KIT	<table border="1"> <thead> <tr> <th>Code</th> <th>Description</th> <th>Qty</th> <th>UOM</th> </tr> </thead> <tbody> <tr> <td>VL1191A0</td> <td>ONE WASHING DISTRIBUTOR OUTLETS KIT</td> <td>1</td> <td>PZ</td> </tr> <tr> <td>VM1605A0</td> <td>CLIP TWIST LOCK DIAM. 10,2-12,7 MM</td> <td>4</td> <td>PZ</td> </tr> <tr> <td>VM2172A0</td> <td>PUMP-WITH-CI RCUIT LOCKING PIN</td> <td>5</td> <td>PZ</td> </tr> </tbody> </table>	Code	Description	Qty	UOM	VL1191A0	ONE WASHING DISTRIBUTOR OUTLETS KIT	1	PZ	VM1605A0	CLIP TWIST LOCK DIAM. 10,2-12,7 MM	4	PZ	VM2172A0	PUMP-WITH-CI RCUIT LOCKING PIN	5	PZ																																									
			Code	Description	Qty	UOM																																																								
VL1191A0	ONE WASHING DISTRIBUTOR OUTLETS KIT	1	PZ																																																											
VM1605A0	CLIP TWIST LOCK DIAM. 10,2-12,7 MM	4	PZ																																																											
VM2172A0	PUMP-WITH-CI RCUIT LOCKING PIN	5	PZ																																																											
KVL1182A	ONE CLEANING SYSTEM KIT (0311 EXC.)	<table border="1"> <thead> <tr> <th>Code</th> <th>Description</th> <th>Qty</th> <th>UOM</th> </tr> </thead> <tbody> <tr> <td>0H2143A0</td> <td>LAMIERA BLOCCA VNR VL1128</td> <td>2</td> <td>PZ</td> </tr> <tr> <td>0H2202A1</td> <td>ONE WASHING WITH STEAM VALVE SUPPORT</td> <td>1</td> <td>PZ</td> </tr> <tr> <td>EL1440A0</td> <td>WATER SELF CLEANING VALVE</td> <td>1</td> <td>PZ</td> </tr> <tr> <td>GN1526A0</td> <td>INT. D.=6.9 TH=1.8 O-RIN</td> <td>3</td> <td>PZ</td> </tr> <tr> <td>RC1018A0</td> <td>ZINC PLATED D12 ELASTIC CLAMP</td> <td>1</td> <td>PZ</td> </tr> <tr> <td>RC1019A0</td> <td>D=10 ELASTIC CLAMP</td> <td>14</td> <td>PZ</td> </tr> <tr> <td>RC1130A0</td> <td>130X2,6 CLAM</td> <td>2</td> <td>PZ</td> </tr> <tr> <td>RC1242A0</td> <td>D=10 CLOSED CAP</td> <td>2</td> <td>PZ</td> </tr> <tr> <td>TB2820A0</td> <td>6X10 EPDM PIPE FOR WASHING SYSTEM</td> <td>1.410</td> <td>M</td> </tr> <tr> <td>TB3132A0</td> <td>WHITE-BLUE EPDM TEXTILE BRAID HOSE 6X12</td> <td>0.670</td> <td>M</td> </tr> <tr> <td>VH1220A1</td> <td>4,2X12 TCB SELF-TAPPIN G SCREW</td> <td>1</td> <td>PZ</td> </tr> <tr> <td>VL1019A0</td> <td>VIBRATION PUMP</td> <td>1</td> <td>PZ</td> </tr> <tr> <td>VL1047A1</td> <td>D6 PIPE HOLDER - D8 J.G. TERMINAL</td> <td>1</td> <td>PZ</td> </tr> <tr> <td>VL1054B0</td> <td>ONE WASHING SYS INLET DISTRIBUTOR</td> <td>1</td> <td>PZ</td> </tr> </tbody> </table>	Code	Description	Qty	UOM	0H2143A0	LAMIERA BLOCCA VNR VL1128	2	PZ	0H2202A1	ONE WASHING WITH STEAM VALVE SUPPORT	1	PZ	EL1440A0	WATER SELF CLEANING VALVE	1	PZ	GN1526A0	INT. D.=6.9 TH=1.8 O-RIN	3	PZ	RC1018A0	ZINC PLATED D12 ELASTIC CLAMP	1	PZ	RC1019A0	D=10 ELASTIC CLAMP	14	PZ	RC1130A0	130X2,6 CLAM	2	PZ	RC1242A0	D=10 CLOSED CAP	2	PZ	TB2820A0	6X10 EPDM PIPE FOR WASHING SYSTEM	1.410	M	TB3132A0	WHITE-BLUE EPDM TEXTILE BRAID HOSE 6X12	0.670	M	VH1220A1	4,2X12 TCB SELF-TAPPIN G SCREW	1	PZ	VL1019A0	VIBRATION PUMP	1	PZ	VL1047A1	D6 PIPE HOLDER - D8 J.G. TERMINAL	1	PZ	VL1054B0	ONE WASHING SYS INLET DISTRIBUTOR	1	PZ
Code	Description	Qty	UOM																																																											
0H2143A0	LAMIERA BLOCCA VNR VL1128	2	PZ																																																											
0H2202A1	ONE WASHING WITH STEAM VALVE SUPPORT	1	PZ																																																											
EL1440A0	WATER SELF CLEANING VALVE	1	PZ																																																											
GN1526A0	INT. D.=6.9 TH=1.8 O-RIN	3	PZ																																																											
RC1018A0	ZINC PLATED D12 ELASTIC CLAMP	1	PZ																																																											
RC1019A0	D=10 ELASTIC CLAMP	14	PZ																																																											
RC1130A0	130X2,6 CLAM	2	PZ																																																											
RC1242A0	D=10 CLOSED CAP	2	PZ																																																											
TB2820A0	6X10 EPDM PIPE FOR WASHING SYSTEM	1.410	M																																																											
TB3132A0	WHITE-BLUE EPDM TEXTILE BRAID HOSE 6X12	0.670	M																																																											
VH1220A1	4,2X12 TCB SELF-TAPPIN G SCREW	1	PZ																																																											
VL1019A0	VIBRATION PUMP	1	PZ																																																											
VL1047A1	D6 PIPE HOLDER - D8 J.G. TERMINAL	1	PZ																																																											
VL1054B0	ONE WASHING SYS INLET DISTRIBUTOR	1	PZ																																																											

COMPONENT			SPARE PART																																											
Code	Description	Image	Code	Description	Components list																																									
VL1054B	ONE WASHING SYS INLET DISTRIBUTOR		KVL1182A	ONE CLEANING SYSTEM KIT (0311 EXC.)	<table border="1"> <thead> <tr> <th>Code</th> <th>Description</th> <th>Qty</th> <th>UOM</th> </tr> </thead> <tbody> <tr> <td>VL1102A1</td> <td>DETERGENT LINE FILTER + BARBED VNR 6 MM</td> <td>1</td> <td>PZ</td> </tr> <tr> <td>VL1128A0</td> <td>D6 BARBED CHECK VALVE</td> <td>2</td> <td>PZ</td> </tr> <tr> <td>VL1128A1</td> <td>D6 BARBED CHECK VALVE</td> <td>2</td> <td>PZ</td> </tr> <tr> <td>VL1165A0</td> <td>BB6-AR6 STRAIGHT FITTING</td> <td>1</td> <td>PZ</td> </tr> <tr> <td>VL1166A0</td> <td>BB6-AR6 L FITTING</td> <td>1</td> <td>PZ</td> </tr> <tr> <td>VL1174C0</td> <td>D1.2 MM CALIBRATED NOZZLE</td> <td>1</td> <td>PZ</td> </tr> <tr> <td>VL1191A0</td> <td>ONE WASHING DISTRIBUTOR OUTLETS KIT</td> <td>1</td> <td>PZ</td> </tr> <tr> <td>VM1605A0</td> <td>CLIP TWIST LOCK DIAM. 10,2-12,7 MM</td> <td>3</td> <td>PZ</td> </tr> <tr> <td>VM2172A0</td> <td>PUMP-WITH-CI RCUIT LOCKING PIN</td> <td>2</td> <td>PZ</td> </tr> </tbody> </table>	Code	Description	Qty	UOM	VL1102A1	DETERGENT LINE FILTER + BARBED VNR 6 MM	1	PZ	VL1128A0	D6 BARBED CHECK VALVE	2	PZ	VL1128A1	D6 BARBED CHECK VALVE	2	PZ	VL1165A0	BB6-AR6 STRAIGHT FITTING	1	PZ	VL1166A0	BB6-AR6 L FITTING	1	PZ	VL1174C0	D1.2 MM CALIBRATED NOZZLE	1	PZ	VL1191A0	ONE WASHING DISTRIBUTOR OUTLETS KIT	1	PZ	VM1605A0	CLIP TWIST LOCK DIAM. 10,2-12,7 MM	3	PZ	VM2172A0	PUMP-WITH-CI RCUIT LOCKING PIN	2	PZ	
			Code	Description	Qty	UOM																																								
VL1102A1	DETERGENT LINE FILTER + BARBED VNR 6 MM	1	PZ																																											
VL1128A0	D6 BARBED CHECK VALVE	2	PZ																																											
VL1128A1	D6 BARBED CHECK VALVE	2	PZ																																											
VL1165A0	BB6-AR6 STRAIGHT FITTING	1	PZ																																											
VL1166A0	BB6-AR6 L FITTING	1	PZ																																											
VL1174C0	D1.2 MM CALIBRATED NOZZLE	1	PZ																																											
VL1191A0	ONE WASHING DISTRIBUTOR OUTLETS KIT	1	PZ																																											
VM1605A0	CLIP TWIST LOCK DIAM. 10,2-12,7 MM	3	PZ																																											
VM2172A0	PUMP-WITH-CI RCUIT LOCKING PIN	2	PZ																																											
KVL0682A	ONE+HOODS WASHING SYSTEM PUMP+NOZZLE KIT	<table border="1"> <thead> <tr> <th>Code</th> <th>Description</th> <th>Qty</th> <th>UOM</th> </tr> </thead> <tbody> <tr> <td>GN1526A0</td> <td>INT. D.=6.9 TH=1.8 O-RIN</td> <td>1</td> <td>PZ</td> </tr> <tr> <td>RC1019A0</td> <td>D=10 ELASTIC CLAMP</td> <td>3</td> <td>PZ</td> </tr> <tr> <td>RC1242A0</td> <td>D=10 CLOSED CAP</td> <td>2</td> <td>PZ</td> </tr> <tr> <td>TB2820A0</td> <td>6X10 EPDM PIPE FOR WASHING SYSTEM</td> <td>0.120</td> <td>M</td> </tr> <tr> <td>VL1019A0</td> <td>VIBRATION PUMP</td> <td>1</td> <td>PZ</td> </tr> <tr> <td>VL1054B0</td> <td>ONE WASHING SYS INLET DISTRIBUTOR</td> <td>1</td> <td>PZ</td> </tr> <tr> <td>VL1128A1</td> <td>D6 BARBED CHECK VALVE</td> <td>2</td> <td>PZ</td> </tr> <tr> <td>VL1174C0</td> <td>D1.2 MM CALIBRATED NOZZLE</td> <td>1</td> <td>PZ</td> </tr> <tr> <td>VL1191A0</td> <td>ONE WASHING DISTRIBUTOR OUTLETS KIT</td> <td>1</td> <td>PZ</td> </tr> <tr> <td>VM2172A0</td> <td>PUMP-WITH-CI RCUIT LOCKING PIN</td> <td>1</td> <td>PZ</td> </tr> </tbody> </table>	Code	Description	Qty	UOM	GN1526A0	INT. D.=6.9 TH=1.8 O-RIN	1	PZ	RC1019A0	D=10 ELASTIC CLAMP	3	PZ	RC1242A0	D=10 CLOSED CAP	2	PZ	TB2820A0	6X10 EPDM PIPE FOR WASHING SYSTEM	0.120	M	VL1019A0	VIBRATION PUMP	1	PZ	VL1054B0	ONE WASHING SYS INLET DISTRIBUTOR	1	PZ	VL1128A1	D6 BARBED CHECK VALVE	2	PZ	VL1174C0	D1.2 MM CALIBRATED NOZZLE	1	PZ	VL1191A0	ONE WASHING DISTRIBUTOR OUTLETS KIT	1	PZ	VM2172A0	PUMP-WITH-CI RCUIT LOCKING PIN	1	PZ
Code	Description	Qty	UOM																																											
GN1526A0	INT. D.=6.9 TH=1.8 O-RIN	1	PZ																																											
RC1019A0	D=10 ELASTIC CLAMP	3	PZ																																											
RC1242A0	D=10 CLOSED CAP	2	PZ																																											
TB2820A0	6X10 EPDM PIPE FOR WASHING SYSTEM	0.120	M																																											
VL1019A0	VIBRATION PUMP	1	PZ																																											
VL1054B0	ONE WASHING SYS INLET DISTRIBUTOR	1	PZ																																											
VL1128A1	D6 BARBED CHECK VALVE	2	PZ																																											
VL1174C0	D1.2 MM CALIBRATED NOZZLE	1	PZ																																											
VL1191A0	ONE WASHING DISTRIBUTOR OUTLETS KIT	1	PZ																																											
VM2172A0	PUMP-WITH-CI RCUIT LOCKING PIN	1	PZ																																											

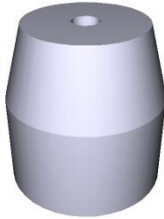

COMPONENT			SPARE PART																																																																														
Code	Description	Image	Code	Description	Components list																																																																												
VL1054B	ONE WASHING SYS INLET DISTRIBUTOR		KVL0001A	LM TOP CLEANING SYSTEM KIT	<table border="1"> <thead> <tr> <th>Code</th> <th>Description</th> <th>Qty</th> <th>UOM</th> </tr> </thead> <tbody> <tr> <td>0H1226B0</td> <td>LINEMISSTOP WASHING SYTEM CIRCUIT COVE</td> <td>1</td> <td>PZ</td> </tr> <tr> <td>0H2143A0</td> <td>LAMIERA BLOCCA VNR VL1128</td> <td>2</td> <td>PZ</td> </tr> <tr> <td>EL1436B0</td> <td>JG D8-BARBED D6 NRV WATER SOLENOID</td> <td>1</td> <td>PZ</td> </tr> <tr> <td>GN1312A0</td> <td>RUBBER CABLE-PASSI NG DE=26 DI=15 SP=10</td> <td>1</td> <td>PZ</td> </tr> <tr> <td>GN1526A0</td> <td>INT. D.=6.9 TH=1.8 O-RIN</td> <td>1</td> <td>PZ</td> </tr> <tr> <td>RC1019A0</td> <td>D=10 ELASTIC CLAMP</td> <td>5</td> <td>PZ</td> </tr> <tr> <td>RC1242A0</td> <td>D=10 CLOSED CAP</td> <td>2</td> <td>PZ</td> </tr> <tr> <td>RC1381A0</td> <td>BIFILAR PIPE CLIP D10.7</td> <td>3</td> <td>PZ</td> </tr> <tr> <td>TB2343A0</td> <td>9X6 PVC TRANSPAREN T PIPE</td> <td>1.650</td> <td>M</td> </tr> <tr> <td>TB2820A0</td> <td>6X10 EPDM PIPE FOR WASHING SYSTEM</td> <td>0.990</td> <td>M</td> </tr> <tr> <td>VI1220A1</td> <td>4,2X12 TCB SELF-TAPPIN G SCREW</td> <td>1</td> <td>PZ</td> </tr> <tr> <td>VL1019A0</td> <td>VIBRATION PUMP</td> <td>1</td> <td>PZ</td> </tr> <tr> <td>VL1041C0</td> <td>DETERGENT CAP WITH Ø12 HOLE</td> <td>1</td> <td>PZ</td> </tr> <tr> <td>VL1047A1</td> <td>D6 PIPE HOLDER - D8 J.G. TERMINAL</td> <td>1</td> <td>PZ</td> </tr> <tr> <td>VL1053B0</td> <td>ONE WASHING SYS EXT DISTRIBUTOR</td> <td>1</td> <td>PZ</td> </tr> <tr> <td>VL1054B0</td> <td>ONE WASHING SYS INLET DISTRIBUTOR</td> <td>1</td> <td>PZ</td> </tr> <tr> <td>VL1061A0</td> <td>HOLD DOWN WEIGHT+NET FILTER+NON- RET. V.</td> <td>1</td> <td>PZ</td> </tr> <tr> <td>VL1128A0</td> <td>D6 BARBED CHECK VALVE</td> <td>2</td> <td>PZ</td> </tr> </tbody> </table>	Code	Description	Qty	UOM	0H1226B0	LINEMISSTOP WASHING SYTEM CIRCUIT COVE	1	PZ	0H2143A0	LAMIERA BLOCCA VNR VL1128	2	PZ	EL1436B0	JG D8-BARBED D6 NRV WATER SOLENOID	1	PZ	GN1312A0	RUBBER CABLE-PASSI NG DE=26 DI=15 SP=10	1	PZ	GN1526A0	INT. D.=6.9 TH=1.8 O-RIN	1	PZ	RC1019A0	D=10 ELASTIC CLAMP	5	PZ	RC1242A0	D=10 CLOSED CAP	2	PZ	RC1381A0	BIFILAR PIPE CLIP D10.7	3	PZ	TB2343A0	9X6 PVC TRANSPAREN T PIPE	1.650	M	TB2820A0	6X10 EPDM PIPE FOR WASHING SYSTEM	0.990	M	VI1220A1	4,2X12 TCB SELF-TAPPIN G SCREW	1	PZ	VL1019A0	VIBRATION PUMP	1	PZ	VL1041C0	DETERGENT CAP WITH Ø12 HOLE	1	PZ	VL1047A1	D6 PIPE HOLDER - D8 J.G. TERMINAL	1	PZ	VL1053B0	ONE WASHING SYS EXT DISTRIBUTOR	1	PZ	VL1054B0	ONE WASHING SYS INLET DISTRIBUTOR	1	PZ	VL1061A0	HOLD DOWN WEIGHT+NET FILTER+NON- RET. V.	1	PZ	VL1128A0	D6 BARBED CHECK VALVE	2	PZ
					Code	Description	Qty	UOM																																																																									
					0H1226B0	LINEMISSTOP WASHING SYTEM CIRCUIT COVE	1	PZ																																																																									
					0H2143A0	LAMIERA BLOCCA VNR VL1128	2	PZ																																																																									
					EL1436B0	JG D8-BARBED D6 NRV WATER SOLENOID	1	PZ																																																																									
					GN1312A0	RUBBER CABLE-PASSI NG DE=26 DI=15 SP=10	1	PZ																																																																									
					GN1526A0	INT. D.=6.9 TH=1.8 O-RIN	1	PZ																																																																									
					RC1019A0	D=10 ELASTIC CLAMP	5	PZ																																																																									
					RC1242A0	D=10 CLOSED CAP	2	PZ																																																																									
					RC1381A0	BIFILAR PIPE CLIP D10.7	3	PZ																																																																									
					TB2343A0	9X6 PVC TRANSPAREN T PIPE	1.650	M																																																																									
					TB2820A0	6X10 EPDM PIPE FOR WASHING SYSTEM	0.990	M																																																																									
					VI1220A1	4,2X12 TCB SELF-TAPPIN G SCREW	1	PZ																																																																									
					VL1019A0	VIBRATION PUMP	1	PZ																																																																									
					VL1041C0	DETERGENT CAP WITH Ø12 HOLE	1	PZ																																																																									
					VL1047A1	D6 PIPE HOLDER - D8 J.G. TERMINAL	1	PZ																																																																									
					VL1053B0	ONE WASHING SYS EXT DISTRIBUTOR	1	PZ																																																																									
					VL1054B0	ONE WASHING SYS INLET DISTRIBUTOR	1	PZ																																																																									
					VL1061A0	HOLD DOWN WEIGHT+NET FILTER+NON- RET. V.	1	PZ																																																																									
					VL1128A0	D6 BARBED CHECK VALVE	2	PZ																																																																									

COMPONENT			SPARE PART																																		
Code	Description	Image	Code	Description	Components list																																
VL1054B	ONE WASHING SYS INLET DISTRIBUTOR		KVL0001A	LM TOP CLEANING SYSTEM KIT	<table border="1"> <thead> <tr> <th>Code</th> <th>Description</th> <th>Qty</th> <th>UOM</th> </tr> </thead> <tbody> <tr> <td>VL1128A1</td> <td>D6 BARBED CHECK VALVE</td> <td>2</td> <td>PZ</td> </tr> <tr> <td>VM1066A0</td> <td>SADDLE CLIP FOR CABLES PASSING</td> <td>3</td> <td>PZ</td> </tr> <tr> <td>VM1088A0</td> <td>NYLON CLICK CLAMP D7.9-D9.2</td> <td>1</td> <td>PZ</td> </tr> <tr> <td>VM1605A0</td> <td>CLIP TWIST LOCK DIAM. 10.2-12.7 MM</td> <td>1</td> <td>PZ</td> </tr> <tr> <td>VM2172A0</td> <td>PUMP-WITH-CI RCUIT LOCKING PIN</td> <td>1</td> <td>PZ</td> </tr> </tbody> </table>	Code	Description	Qty	UOM	VL1128A1	D6 BARBED CHECK VALVE	2	PZ	VM1066A0	SADDLE CLIP FOR CABLES PASSING	3	PZ	VM1088A0	NYLON CLICK CLAMP D7.9-D9.2	1	PZ	VM1605A0	CLIP TWIST LOCK DIAM. 10.2-12.7 MM	1	PZ	VM2172A0	PUMP-WITH-CI RCUIT LOCKING PIN	1	PZ								
					Code	Description	Qty	UOM																													
					VL1128A1	D6 BARBED CHECK VALVE	2	PZ																													
					VM1066A0	SADDLE CLIP FOR CABLES PASSING	3	PZ																													
					VM1088A0	NYLON CLICK CLAMP D7.9-D9.2	1	PZ																													
VM1605A0	CLIP TWIST LOCK DIAM. 10.2-12.7 MM	1	PZ																																		
VM2172A0	PUMP-WITH-CI RCUIT LOCKING PIN	1	PZ																																		
RC1242A	D=10 CLOSED CAP		KRC1242A	Ø10 CLOSED CONNECTION 20PCS KIT	<table border="1"> <thead> <tr> <th>Code</th> <th>Description</th> <th>Qty</th> <th>UOM</th> </tr> </thead> <tbody> <tr> <td>RC1242A0</td> <td>D=10 CLOSED CAP</td> <td>20</td> <td>PZ</td> </tr> <tr> <td>VM1224A0</td> <td>65MY 220MM 2 COLOURS SHRINK TUBE</td> <td>0.200</td> <td>M</td> </tr> </tbody> </table>	Code	Description	Qty	UOM	RC1242A0	D=10 CLOSED CAP	20	PZ	VM1224A0	65MY 220MM 2 COLOURS SHRINK TUBE	0.200	M																				
					Code	Description	Qty	UOM																													
RC1242A0	D=10 CLOSED CAP	20	PZ																																		
VM1224A0	65MY 220MM 2 COLOURS SHRINK TUBE	0.200	M																																		
VL1174C	D1.2 MM CALIBRATED NOZZL		VL1174C0	D1.2 MM CALIBRATED NOZZL																																	
VL1128A	D6 BARBED CHECK VALVE		KVL1128A	D6 VNR BARBED VALVE KIT	<table border="1"> <thead> <tr> <th>Code</th> <th>Description</th> <th>Qty</th> <th>UOM</th> </tr> </thead> <tbody> <tr> <td>0H2143A0</td> <td>LAMIERA BLOCCA VNR VL1128</td> <td>1</td> <td>PZ</td> </tr> <tr> <td>RC1019A0</td> <td>D=10 ELASTIC CLAMP</td> <td>4</td> <td>PZ</td> </tr> <tr> <td>RC1130A0</td> <td>130X2,6 CLAM</td> <td>1</td> <td>PZ</td> </tr> <tr> <td>TB2820A0</td> <td>6X10 EPDM PIPE FOR WASHING SYSTEM</td> <td>0.080</td> <td>M</td> </tr> <tr> <td>VL1128A0</td> <td>D6 BARBED CHECK VALVE</td> <td>1</td> <td>PZ</td> </tr> <tr> <td>VL1128A1</td> <td>D6 BARBED CHECK VALVE</td> <td>1</td> <td>PZ</td> </tr> <tr> <td>VM1224A0</td> <td>65MY 220MM 2 COLOURS SHRINK TUBE</td> <td>0.200</td> <td>M</td> </tr> </tbody> </table>	Code	Description	Qty	UOM	0H2143A0	LAMIERA BLOCCA VNR VL1128	1	PZ	RC1019A0	D=10 ELASTIC CLAMP	4	PZ	RC1130A0	130X2,6 CLAM	1	PZ	TB2820A0	6X10 EPDM PIPE FOR WASHING SYSTEM	0.080	M	VL1128A0	D6 BARBED CHECK VALVE	1	PZ	VL1128A1	D6 BARBED CHECK VALVE	1	PZ	VM1224A0	65MY 220MM 2 COLOURS SHRINK TUBE	0.200	M
					Code	Description	Qty	UOM																													
					0H2143A0	LAMIERA BLOCCA VNR VL1128	1	PZ																													
					RC1019A0	D=10 ELASTIC CLAMP	4	PZ																													
					RC1130A0	130X2,6 CLAM	1	PZ																													
					TB2820A0	6X10 EPDM PIPE FOR WASHING SYSTEM	0.080	M																													
					VL1128A0	D6 BARBED CHECK VALVE	1	PZ																													
					VL1128A1	D6 BARBED CHECK VALVE	1	PZ																													
VM1224A0	65MY 220MM 2 COLOURS SHRINK TUBE	0.200	M																																		



COMPONENT			SPARE PART																																																																														
Code	Description	Image	Code	Description	Components list																																																																												
VL1191A	ONE WASHING DISTRIBUTOR OUTLETS KIT		KVL2618A	2 ROTOR ARMS ONE CLEANING SYSTEM KIT	<table border="1"> <thead> <tr> <th>Code</th> <th>Description</th> <th>Qty</th> <th>UOM</th> </tr> </thead> <tbody> <tr> <td>0H2202A1</td> <td>ONE WASHING WITH STEAM VALVE SUPPORT</td> <td>2</td> <td>PZ</td> </tr> <tr> <td>CE1030A0</td> <td>FEMALE FASTON COVER 6.3X0.8 0,5-1MMQ</td> <td>4</td> <td>PZ</td> </tr> <tr> <td>CE1395A0</td> <td>6,3 X 0,8 IMALE FASTO</td> <td>2</td> <td>PZ</td> </tr> <tr> <td>CE1545A0</td> <td>BLUE UNIP AWG18 ST.3135 WIRE</td> <td>1</td> <td>M</td> </tr> <tr> <td>CE1570A0</td> <td>WHITE UNIP AWG18 ST.3135 WIRE</td> <td>1</td> <td>M</td> </tr> <tr> <td>CE1660A0</td> <td>6,3X0,8 FEMALE FASTON COVE</td> <td>4</td> <td>PZ</td> </tr> <tr> <td>CE1661A0</td> <td>MALE FASTON COVER 6,3X0,</td> <td>2</td> <td>PZ</td> </tr> <tr> <td>EL1020A1</td> <td>D8 INTERMEDIAT E T-SHAPED FITTING</td> <td>1</td> <td>PZ</td> </tr> <tr> <td>EL1440A0</td> <td>WATER SELF CLEANING VALVE</td> <td>2</td> <td>PZ</td> </tr> <tr> <td>GN1526A0</td> <td>INT. D.=6.9 TH=1.8 O-RIN</td> <td>6</td> <td>PZ</td> </tr> <tr> <td>IP1385A1</td> <td>CORNER POLYSTYREN E PACKING 110X80X2000</td> <td>0.500</td> <td>M</td> </tr> <tr> <td>RC1018A0</td> <td>ZINC PLATED D12 ELASTIC CLAMP</td> <td>4</td> <td>PZ</td> </tr> <tr> <td>RC1019A0</td> <td>D=10 ELASTIC CLAMP</td> <td>31</td> <td>PZ</td> </tr> <tr> <td>RC1130A0</td> <td>130X2,6 CLAM</td> <td>4</td> <td>PZ</td> </tr> <tr> <td>RC1242A0</td> <td>D=10 CLOSED CAP</td> <td>4</td> <td>PZ</td> </tr> <tr> <td>TB2820A0</td> <td>6X10 EPDM PIPE FOR WASHING SYSTEM</td> <td>2.920</td> <td>M</td> </tr> <tr> <td>TB3132A0</td> <td>WHITE-BLUE EPDM TEXTILE BRAID HOSE 6X12</td> <td>1.340</td> <td>M</td> </tr> <tr> <td>VI1220A1</td> <td>4,2X12 TCB SELF-TAPPIN G SCREW</td> <td>2</td> <td>PZ</td> </tr> </tbody> </table>	Code	Description	Qty	UOM	0H2202A1	ONE WASHING WITH STEAM VALVE SUPPORT	2	PZ	CE1030A0	FEMALE FASTON COVER 6.3X0.8 0,5-1MMQ	4	PZ	CE1395A0	6,3 X 0,8 IMALE FASTO	2	PZ	CE1545A0	BLUE UNIP AWG18 ST.3135 WIRE	1	M	CE1570A0	WHITE UNIP AWG18 ST.3135 WIRE	1	M	CE1660A0	6,3X0,8 FEMALE FASTON COVE	4	PZ	CE1661A0	MALE FASTON COVER 6,3X0,	2	PZ	EL1020A1	D8 INTERMEDIAT E T-SHAPED FITTING	1	PZ	EL1440A0	WATER SELF CLEANING VALVE	2	PZ	GN1526A0	INT. D.=6.9 TH=1.8 O-RIN	6	PZ	IP1385A1	CORNER POLYSTYREN E PACKING 110X80X2000	0.500	M	RC1018A0	ZINC PLATED D12 ELASTIC CLAMP	4	PZ	RC1019A0	D=10 ELASTIC CLAMP	31	PZ	RC1130A0	130X2,6 CLAM	4	PZ	RC1242A0	D=10 CLOSED CAP	4	PZ	TB2820A0	6X10 EPDM PIPE FOR WASHING SYSTEM	2.920	M	TB3132A0	WHITE-BLUE EPDM TEXTILE BRAID HOSE 6X12	1.340	M	VI1220A1	4,2X12 TCB SELF-TAPPIN G SCREW	2	PZ
Code	Description	Qty	UOM																																																																														
0H2202A1	ONE WASHING WITH STEAM VALVE SUPPORT	2	PZ																																																																														
CE1030A0	FEMALE FASTON COVER 6.3X0.8 0,5-1MMQ	4	PZ																																																																														
CE1395A0	6,3 X 0,8 IMALE FASTO	2	PZ																																																																														
CE1545A0	BLUE UNIP AWG18 ST.3135 WIRE	1	M																																																																														
CE1570A0	WHITE UNIP AWG18 ST.3135 WIRE	1	M																																																																														
CE1660A0	6,3X0,8 FEMALE FASTON COVE	4	PZ																																																																														
CE1661A0	MALE FASTON COVER 6,3X0,	2	PZ																																																																														
EL1020A1	D8 INTERMEDIAT E T-SHAPED FITTING	1	PZ																																																																														
EL1440A0	WATER SELF CLEANING VALVE	2	PZ																																																																														
GN1526A0	INT. D.=6.9 TH=1.8 O-RIN	6	PZ																																																																														
IP1385A1	CORNER POLYSTYREN E PACKING 110X80X2000	0.500	M																																																																														
RC1018A0	ZINC PLATED D12 ELASTIC CLAMP	4	PZ																																																																														
RC1019A0	D=10 ELASTIC CLAMP	31	PZ																																																																														
RC1130A0	130X2,6 CLAM	4	PZ																																																																														
RC1242A0	D=10 CLOSED CAP	4	PZ																																																																														
TB2820A0	6X10 EPDM PIPE FOR WASHING SYSTEM	2.920	M																																																																														
TB3132A0	WHITE-BLUE EPDM TEXTILE BRAID HOSE 6X12	1.340	M																																																																														
VI1220A1	4,2X12 TCB SELF-TAPPIN G SCREW	2	PZ																																																																														

COMPONENT			SPARE PART																																																		
Code	Description	Image	Code	Description	Components list																																																
VL1191A	ONE WASHING DISTRIBUTOR OUTLETS KIT		KVL2618A	2 ROTOR ARMS ONE CLEANING SYSTEM KIT	<table border="1"> <thead> <tr> <th>Code</th> <th>Description</th> <th>Qty</th> <th>UOM</th> </tr> </thead> <tbody> <tr> <td>VL1019A0</td> <td>VIBRATION PUMP</td> <td>2</td> <td>PZ</td> </tr> <tr> <td>VL1047A1</td> <td>D6 PIPE HOLDER - D8 J.G. TERMINAL</td> <td>2</td> <td>PZ</td> </tr> <tr> <td>VL1054B0</td> <td>ONE WASHING SYS INLET DISTRIBUTOR</td> <td>2</td> <td>PZ</td> </tr> <tr> <td>VL1102A1</td> <td>DETERGENT LINE FILTER + BARBED VNR 6 MM</td> <td>2</td> <td>PZ</td> </tr> <tr> <td>VL1127A1</td> <td>6MM BARBED T-SHAPED FITTING</td> <td>1</td> <td>PZ</td> </tr> <tr> <td>VL1128A1</td> <td>D6 BARBED CHECK VALVE</td> <td>4</td> <td>PZ</td> </tr> <tr> <td>VL1165A0</td> <td>BB6-AR6 STRAIGHT FITTING</td> <td>2</td> <td>PZ</td> </tr> <tr> <td>VL1166A0</td> <td>BB6-AR6 L FITTING</td> <td>2</td> <td>PZ</td> </tr> <tr> <td>VL1174C0</td> <td>D1.2 MM CALIBRATED NOZZLE</td> <td>2</td> <td>PZ</td> </tr> <tr> <td>VL1191A0</td> <td>ONE WASHING DISTRIBUTOR OUTLETS KIT</td> <td>2</td> <td>PZ</td> </tr> <tr> <td>VM2172A0</td> <td>PUMP-WITH-CI RCUIT LOCKING PIN</td> <td>4</td> <td>PZ</td> </tr> </tbody> </table>	Code	Description	Qty	UOM	VL1019A0	VIBRATION PUMP	2	PZ	VL1047A1	D6 PIPE HOLDER - D8 J.G. TERMINAL	2	PZ	VL1054B0	ONE WASHING SYS INLET DISTRIBUTOR	2	PZ	VL1102A1	DETERGENT LINE FILTER + BARBED VNR 6 MM	2	PZ	VL1127A1	6MM BARBED T-SHAPED FITTING	1	PZ	VL1128A1	D6 BARBED CHECK VALVE	4	PZ	VL1165A0	BB6-AR6 STRAIGHT FITTING	2	PZ	VL1166A0	BB6-AR6 L FITTING	2	PZ	VL1174C0	D1.2 MM CALIBRATED NOZZLE	2	PZ	VL1191A0	ONE WASHING DISTRIBUTOR OUTLETS KIT	2	PZ	VM2172A0	PUMP-WITH-CI RCUIT LOCKING PIN	4	PZ
			Code	Description	Qty	UOM																																															
VL1019A0	VIBRATION PUMP	2	PZ																																																		
VL1047A1	D6 PIPE HOLDER - D8 J.G. TERMINAL	2	PZ																																																		
VL1054B0	ONE WASHING SYS INLET DISTRIBUTOR	2	PZ																																																		
VL1102A1	DETERGENT LINE FILTER + BARBED VNR 6 MM	2	PZ																																																		
VL1127A1	6MM BARBED T-SHAPED FITTING	1	PZ																																																		
VL1128A1	D6 BARBED CHECK VALVE	4	PZ																																																		
VL1165A0	BB6-AR6 STRAIGHT FITTING	2	PZ																																																		
VL1166A0	BB6-AR6 L FITTING	2	PZ																																																		
VL1174C0	D1.2 MM CALIBRATED NOZZLE	2	PZ																																																		
VL1191A0	ONE WASHING DISTRIBUTOR OUTLETS KIT	2	PZ																																																		
VM2172A0	PUMP-WITH-CI RCUIT LOCKING PIN	4	PZ																																																		
KVL1225A	US HOOD WASHING SYSTEM KIT	<table border="1"> <thead> <tr> <th>Code</th> <th>Description</th> <th>Qty</th> <th>UOM</th> </tr> </thead> <tbody> <tr> <td>0H2213A1</td> <td></td> <td>1</td> <td>PZ</td> </tr> <tr> <td>EL1450A0</td> <td>US SELF-CLEANING WATER SOLENOID</td> <td>2</td> <td>PZ</td> </tr> <tr> <td>GN1526A0</td> <td>INT. D.=6.9 TH=1.8 O-RING</td> <td>5</td> <td>PZ</td> </tr> <tr> <td>RC1018A0</td> <td>ZINC PLATED D12 ELASTIC CLAMP</td> <td>5</td> <td>PZ</td> </tr> <tr> <td>RC1019A0</td> <td>D=10 ELASTIC CLAMP</td> <td>16</td> <td>PZ</td> </tr> <tr> <td>RC1131A0</td> <td>200X2.6 BLACK CLAMP</td> <td>1</td> <td>PZ</td> </tr> <tr> <td>RC1242A0</td> <td>D=10 CLOSED CAP</td> <td>2</td> <td>PZ</td> </tr> <tr> <td>TB2820A0</td> <td>6X10 EPDM PIPE FOR WASHING SYSTEM</td> <td>2.240</td> <td>M</td> </tr> </tbody> </table>	Code	Description	Qty	UOM	0H2213A1		1	PZ	EL1450A0	US SELF-CLEANING WATER SOLENOID	2	PZ	GN1526A0	INT. D.=6.9 TH=1.8 O-RING	5	PZ	RC1018A0	ZINC PLATED D12 ELASTIC CLAMP	5	PZ	RC1019A0	D=10 ELASTIC CLAMP	16	PZ	RC1131A0	200X2.6 BLACK CLAMP	1	PZ	RC1242A0	D=10 CLOSED CAP	2	PZ	TB2820A0	6X10 EPDM PIPE FOR WASHING SYSTEM	2.240	M															
Code	Description	Qty	UOM																																																		
0H2213A1		1	PZ																																																		
EL1450A0	US SELF-CLEANING WATER SOLENOID	2	PZ																																																		
GN1526A0	INT. D.=6.9 TH=1.8 O-RING	5	PZ																																																		
RC1018A0	ZINC PLATED D12 ELASTIC CLAMP	5	PZ																																																		
RC1019A0	D=10 ELASTIC CLAMP	16	PZ																																																		
RC1131A0	200X2.6 BLACK CLAMP	1	PZ																																																		
RC1242A0	D=10 CLOSED CAP	2	PZ																																																		
TB2820A0	6X10 EPDM PIPE FOR WASHING SYSTEM	2.240	M																																																		





COMPONENT			SPARE PART																																																																																					
Code	Description	Image	Code	Description	Components list																																																																																			
VL1191A	ONE WASHING DISTRIBUTOR OUTLETS KIT		KVL1225A	US HOOD WASHING SYSTEM KIT	<table border="1"> <thead> <tr> <th>Code</th> <th>Description</th> <th>Qty</th> <th>UOM</th> </tr> </thead> <tbody> <tr> <td>TB3132A0</td> <td>WHITE-BLUE EPDM TEXTILE BRAID HOSE 6X12</td> <td>0.440</td> <td>M</td> </tr> <tr> <td>V11220A1</td> <td>4,2X12 TCB SELF-TAPPIN G SCREW</td> <td>3</td> <td>PZ</td> </tr> <tr> <td>VL1019A0</td> <td>VIBRATION PUMP</td> <td>1</td> <td>PZ</td> </tr> <tr> <td>VL1047A1</td> <td>D6 PIPE HOLDER - D8 J.G. TERMINAL</td> <td>1</td> <td>PZ</td> </tr> <tr> <td>VL1054B0</td> <td>ONE WASHING SYS INLET DISTRIBUTOR</td> <td>1</td> <td>PZ</td> </tr> <tr> <td>VL1102A1</td> <td>DETERGENT LINE FILTER + BARBED VNR 6 MM</td> <td>1</td> <td>PZ</td> </tr> <tr> <td>VL1127A1</td> <td>6MM BARBED T-SHAPED FITTING</td> <td>1</td> <td>PZ</td> </tr> <tr> <td>VL1128A1</td> <td>D6 BARBED CHECK VALVE</td> <td>2</td> <td>PZ</td> </tr> <tr> <td>VL1165A0</td> <td>BB6-AR6 STRAIGHT FITTING</td> <td>2</td> <td>PZ</td> </tr> <tr> <td>VL1166A0</td> <td>BB6-AR6 L FITTING</td> <td>2</td> <td>PZ</td> </tr> <tr> <td>VL1174C0</td> <td>D1.2 MM CALIBRATED NOZZLE</td> <td>1</td> <td>PZ</td> </tr> <tr> <td>VL1191A0</td> <td>ONE WASHING DISTRIBUTOR OUTLETS KIT</td> <td>1</td> <td>PZ</td> </tr> <tr> <td>VM1605A0</td> <td>CLIP TWIST LOCK DIAM. 10,2-12,7 MM</td> <td>2</td> <td>PZ</td> </tr> <tr> <td>VM2172A0</td> <td>PUMP-WITH-CI RCUIT LOCKING PIN</td> <td>5</td> <td>PZ</td> </tr> </tbody> </table>	Code	Description	Qty	UOM	TB3132A0	WHITE-BLUE EPDM TEXTILE BRAID HOSE 6X12	0.440	M	V11220A1	4,2X12 TCB SELF-TAPPIN G SCREW	3	PZ	VL1019A0	VIBRATION PUMP	1	PZ	VL1047A1	D6 PIPE HOLDER - D8 J.G. TERMINAL	1	PZ	VL1054B0	ONE WASHING SYS INLET DISTRIBUTOR	1	PZ	VL1102A1	DETERGENT LINE FILTER + BARBED VNR 6 MM	1	PZ	VL1127A1	6MM BARBED T-SHAPED FITTING	1	PZ	VL1128A1	D6 BARBED CHECK VALVE	2	PZ	VL1165A0	BB6-AR6 STRAIGHT FITTING	2	PZ	VL1166A0	BB6-AR6 L FITTING	2	PZ	VL1174C0	D1.2 MM CALIBRATED NOZZLE	1	PZ	VL1191A0	ONE WASHING DISTRIBUTOR OUTLETS KIT	1	PZ	VM1605A0	CLIP TWIST LOCK DIAM. 10,2-12,7 MM	2	PZ	VM2172A0	PUMP-WITH-CI RCUIT LOCKING PIN	5	PZ	KVL1222A	EUR 0311 ONE PLUS CLEANING SYSTEM KIT	<table border="1"> <thead> <tr> <th>Code</th> <th>Description</th> <th>Qty</th> <th>UOM</th> </tr> </thead> <tbody> <tr> <td>0H2486A0</td> <td>WATER SELF CLEANING VALVE</td> <td>1</td> <td>PZ</td> </tr> <tr> <td>EL1440A0</td> <td>INT. D.=6.9 TH=1.8 O-RIN</td> <td>1</td> <td>PZ</td> </tr> <tr> <td>GN1526A0</td> <td>ZINC PLATED D12 ELASTIC CLAMP</td> <td>3</td> <td>PZ</td> </tr> <tr> <td>RC1018A0</td> <td>ZINC PLATED D12 ELASTIC CLAMP</td> <td>2</td> <td>PZ</td> </tr> </tbody> </table>	Code	Description	Qty	UOM	0H2486A0	WATER SELF CLEANING VALVE	1	PZ	EL1440A0	INT. D.=6.9 TH=1.8 O-RIN	1	PZ	GN1526A0	ZINC PLATED D12 ELASTIC CLAMP	3	PZ	RC1018A0	ZINC PLATED D12 ELASTIC CLAMP	2	PZ
			Code	Description	Qty	UOM																																																																																		
TB3132A0	WHITE-BLUE EPDM TEXTILE BRAID HOSE 6X12	0.440	M																																																																																					
V11220A1	4,2X12 TCB SELF-TAPPIN G SCREW	3	PZ																																																																																					
VL1019A0	VIBRATION PUMP	1	PZ																																																																																					
VL1047A1	D6 PIPE HOLDER - D8 J.G. TERMINAL	1	PZ																																																																																					
VL1054B0	ONE WASHING SYS INLET DISTRIBUTOR	1	PZ																																																																																					
VL1102A1	DETERGENT LINE FILTER + BARBED VNR 6 MM	1	PZ																																																																																					
VL1127A1	6MM BARBED T-SHAPED FITTING	1	PZ																																																																																					
VL1128A1	D6 BARBED CHECK VALVE	2	PZ																																																																																					
VL1165A0	BB6-AR6 STRAIGHT FITTING	2	PZ																																																																																					
VL1166A0	BB6-AR6 L FITTING	2	PZ																																																																																					
VL1174C0	D1.2 MM CALIBRATED NOZZLE	1	PZ																																																																																					
VL1191A0	ONE WASHING DISTRIBUTOR OUTLETS KIT	1	PZ																																																																																					
VM1605A0	CLIP TWIST LOCK DIAM. 10,2-12,7 MM	2	PZ																																																																																					
VM2172A0	PUMP-WITH-CI RCUIT LOCKING PIN	5	PZ																																																																																					
Code	Description	Qty	UOM																																																																																					
0H2486A0	WATER SELF CLEANING VALVE	1	PZ																																																																																					
EL1440A0	INT. D.=6.9 TH=1.8 O-RIN	1	PZ																																																																																					
GN1526A0	ZINC PLATED D12 ELASTIC CLAMP	3	PZ																																																																																					
RC1018A0	ZINC PLATED D12 ELASTIC CLAMP	2	PZ																																																																																					





COMPONENT			SPARE PART																																																																																					
Code	Description	Image	Code	Description	Components list																																																																																			
VL1191A	ONE WASHING DISTRIBUTOR OUTLETS KIT		KVL1222A	EUR 0311 ONE PLUS CLEANING SYSTEM KIT	<table border="1"> <thead> <tr> <th>Code</th> <th>Description</th> <th>Qty</th> <th>UOM</th> </tr> </thead> <tbody> <tr> <td>RC1019A0</td> <td>D=10 ELASTIC CLAMP</td> <td>14</td> <td>PZ</td> </tr> <tr> <td>RC1242A0</td> <td>D=10 CLOSED CAP</td> <td>2</td> <td>PZ</td> </tr> <tr> <td>TB2820A0</td> <td>6X10 EPDM PIPE FOR WASHING SYSTEM</td> <td>1.460</td> <td>M</td> </tr> <tr> <td>TB3132A0</td> <td>WHITE-BLUE EPDM TEXTILE BRAID HOSE 6X12</td> <td>0.670</td> <td>M</td> </tr> <tr> <td>VI1220A1</td> <td>4,2X12 TCB SELF-TAPPIN G SCREW</td> <td>4</td> <td>PZ</td> </tr> <tr> <td>VL1019A0</td> <td>VIBRATION PUMP</td> <td>1</td> <td>PZ</td> </tr> <tr> <td>VL1047A1</td> <td>D6 PIPE HOLDER - D8 J.G. TERMINAL</td> <td>1</td> <td>PZ</td> </tr> <tr> <td>VL1054B0</td> <td>ONE WASHING SYS INLET DISTRIBUTOR</td> <td>1</td> <td>PZ</td> </tr> <tr> <td>VL1102A1</td> <td>DETERGENT LINE FILTER + BARBED VNR 6 MM</td> <td>1</td> <td>PZ</td> </tr> <tr> <td>VL1128A1</td> <td>D6 BARBED CHECK VALVE</td> <td>2</td> <td>PZ</td> </tr> <tr> <td>VL1165A0</td> <td>BB6-AR6 STRAIGHT FITTING</td> <td>1</td> <td>PZ</td> </tr> <tr> <td>VL1166A0</td> <td>BB6-AR6 L FITTING</td> <td>1</td> <td>PZ</td> </tr> <tr> <td>VL1174C0</td> <td>D1.2 MM CALIBRATED NOZZLE</td> <td>1</td> <td>PZ</td> </tr> <tr> <td>VL1191A0</td> <td>ONE WASHING DISTRIBUTOR OUTLETS KIT</td> <td>1</td> <td>PZ</td> </tr> <tr> <td>VM2172A0</td> <td>PUMP-WITH-CI RCUIT LOCKING PIN</td> <td>3</td> <td>PZ</td> </tr> </tbody> </table>	Code	Description	Qty	UOM	RC1019A0	D=10 ELASTIC CLAMP	14	PZ	RC1242A0	D=10 CLOSED CAP	2	PZ	TB2820A0	6X10 EPDM PIPE FOR WASHING SYSTEM	1.460	M	TB3132A0	WHITE-BLUE EPDM TEXTILE BRAID HOSE 6X12	0.670	M	VI1220A1	4,2X12 TCB SELF-TAPPIN G SCREW	4	PZ	VL1019A0	VIBRATION PUMP	1	PZ	VL1047A1	D6 PIPE HOLDER - D8 J.G. TERMINAL	1	PZ	VL1054B0	ONE WASHING SYS INLET DISTRIBUTOR	1	PZ	VL1102A1	DETERGENT LINE FILTER + BARBED VNR 6 MM	1	PZ	VL1128A1	D6 BARBED CHECK VALVE	2	PZ	VL1165A0	BB6-AR6 STRAIGHT FITTING	1	PZ	VL1166A0	BB6-AR6 L FITTING	1	PZ	VL1174C0	D1.2 MM CALIBRATED NOZZLE	1	PZ	VL1191A0	ONE WASHING DISTRIBUTOR OUTLETS KIT	1	PZ	VM2172A0	PUMP-WITH-CI RCUIT LOCKING PIN	3	PZ	KVL1211A	ONE COMPACT AND 0523-EP WASH. SYSTEM KIT	<table border="1"> <thead> <tr> <th>Code</th> <th>Description</th> <th>Qty</th> <th>UOM</th> </tr> </thead> <tbody> <tr> <td>0H2427A0</td> <td></td> <td>1</td> <td>PZ</td> </tr> <tr> <td>EL1440A0</td> <td>WATER SELF CLEANING VALVE</td> <td>1</td> <td>PZ</td> </tr> <tr> <td>GN1526A0</td> <td>INT. D.=6.9 TH=1.8 O-RIN</td> <td>3</td> <td>PZ</td> </tr> </tbody> </table>	Code	Description	Qty	UOM	0H2427A0		1	PZ	EL1440A0	WATER SELF CLEANING VALVE	1	PZ	GN1526A0	INT. D.=6.9 TH=1.8 O-RIN	3	PZ
			Code	Description	Qty	UOM																																																																																		
RC1019A0	D=10 ELASTIC CLAMP	14	PZ																																																																																					
RC1242A0	D=10 CLOSED CAP	2	PZ																																																																																					
TB2820A0	6X10 EPDM PIPE FOR WASHING SYSTEM	1.460	M																																																																																					
TB3132A0	WHITE-BLUE EPDM TEXTILE BRAID HOSE 6X12	0.670	M																																																																																					
VI1220A1	4,2X12 TCB SELF-TAPPIN G SCREW	4	PZ																																																																																					
VL1019A0	VIBRATION PUMP	1	PZ																																																																																					
VL1047A1	D6 PIPE HOLDER - D8 J.G. TERMINAL	1	PZ																																																																																					
VL1054B0	ONE WASHING SYS INLET DISTRIBUTOR	1	PZ																																																																																					
VL1102A1	DETERGENT LINE FILTER + BARBED VNR 6 MM	1	PZ																																																																																					
VL1128A1	D6 BARBED CHECK VALVE	2	PZ																																																																																					
VL1165A0	BB6-AR6 STRAIGHT FITTING	1	PZ																																																																																					
VL1166A0	BB6-AR6 L FITTING	1	PZ																																																																																					
VL1174C0	D1.2 MM CALIBRATED NOZZLE	1	PZ																																																																																					
VL1191A0	ONE WASHING DISTRIBUTOR OUTLETS KIT	1	PZ																																																																																					
VM2172A0	PUMP-WITH-CI RCUIT LOCKING PIN	3	PZ																																																																																					
Code	Description	Qty	UOM																																																																																					
0H2427A0		1	PZ																																																																																					
EL1440A0	WATER SELF CLEANING VALVE	1	PZ																																																																																					
GN1526A0	INT. D.=6.9 TH=1.8 O-RIN	3	PZ																																																																																					



COMPONENT			SPARE PART																																																																																									
Code	Description	Image	Code	Description	Components list																																																																																							
VL1191A	ONE WASHING DISTRIBUTOR OUTLETS KIT		KVL1211A	ONE COMPACT AND 0523-EP WASH. SYSTEM KIT	<table border="1"> <thead> <tr> <th>Code</th> <th>Description</th> <th>Qty</th> <th>UOM</th> </tr> </thead> <tbody> <tr> <td>RC1018A0</td> <td>ZINC PLATED D12 ELASTIC CLAMP</td> <td>2</td> <td>PZ</td> </tr> <tr> <td>RC1019A0</td> <td>D=10 ELASTIC CLAMP</td> <td>14</td> <td>PZ</td> </tr> <tr> <td>RC1130A0</td> <td>130X2,6 CLAM</td> <td>1</td> <td>PZ</td> </tr> <tr> <td>RC1242A0</td> <td>D=10 CLOSED CAP</td> <td>2</td> <td>PZ</td> </tr> <tr> <td>TB2820A0</td> <td>6X10 EPDM PIPE FOR WASHING SYSTEM</td> <td>1.290</td> <td>M</td> </tr> <tr> <td>TB3132A0</td> <td>WHITE-BLUE EPDM TEXTILE BRAID HOSE 6X12</td> <td>0.670</td> <td>M</td> </tr> <tr> <td>VI1220A1</td> <td>4,2X12 TCB SELF-TAPPIN G SCREW</td> <td>4</td> <td>PZ</td> </tr> <tr> <td>VL1019A0</td> <td>VIBRATION PUMP</td> <td>1</td> <td>PZ</td> </tr> <tr> <td>VL1047A1</td> <td>D6 PIPE HOLDER - D8 J.G. TERMINAL</td> <td>1</td> <td>PZ</td> </tr> <tr> <td>VL1054B0</td> <td>ONE WASHING SYS INLET DISTRIBUTOR</td> <td>1</td> <td>PZ</td> </tr> <tr> <td>VL1102A1</td> <td>DETERGENT LINE FILTER + BARBED VNR 6 MM</td> <td>1</td> <td>PZ</td> </tr> <tr> <td>VL1128A1</td> <td>D6 BARBED CHECK VALVE</td> <td>2</td> <td>PZ</td> </tr> <tr> <td>VL1165A0</td> <td>BB6-AR6 STRAIGHT FITTING</td> <td>1</td> <td>PZ</td> </tr> <tr> <td>VL1166A0</td> <td>BB6-AR6 L FITTING</td> <td>1</td> <td>PZ</td> </tr> <tr> <td>VL1174C0</td> <td>D1.2 MM CALIBRATED NOZZLE</td> <td>1</td> <td>PZ</td> </tr> <tr> <td>VL1191A0</td> <td>ONE WASHING DISTRIBUTOR OUTLETS KIT</td> <td>1</td> <td>PZ</td> </tr> <tr> <td>VM2172A0</td> <td>PUMP-WITH-CI RCUIT LOCKING PIN</td> <td>3</td> <td>PZ</td> </tr> </tbody> </table>	Code	Description	Qty	UOM	RC1018A0	ZINC PLATED D12 ELASTIC CLAMP	2	PZ	RC1019A0	D=10 ELASTIC CLAMP	14	PZ	RC1130A0	130X2,6 CLAM	1	PZ	RC1242A0	D=10 CLOSED CAP	2	PZ	TB2820A0	6X10 EPDM PIPE FOR WASHING SYSTEM	1.290	M	TB3132A0	WHITE-BLUE EPDM TEXTILE BRAID HOSE 6X12	0.670	M	VI1220A1	4,2X12 TCB SELF-TAPPIN G SCREW	4	PZ	VL1019A0	VIBRATION PUMP	1	PZ	VL1047A1	D6 PIPE HOLDER - D8 J.G. TERMINAL	1	PZ	VL1054B0	ONE WASHING SYS INLET DISTRIBUTOR	1	PZ	VL1102A1	DETERGENT LINE FILTER + BARBED VNR 6 MM	1	PZ	VL1128A1	D6 BARBED CHECK VALVE	2	PZ	VL1165A0	BB6-AR6 STRAIGHT FITTING	1	PZ	VL1166A0	BB6-AR6 L FITTING	1	PZ	VL1174C0	D1.2 MM CALIBRATED NOZZLE	1	PZ	VL1191A0	ONE WASHING DISTRIBUTOR OUTLETS KIT	1	PZ	VM2172A0	PUMP-WITH-CI RCUIT LOCKING PIN	3	PZ	KVL1198A	MM EU HOOD CLEANING SYSTEM KIT	<table border="1"> <thead> <tr> <th>Code</th> <th>Description</th> <th>Qty</th> <th>UOM</th> </tr> </thead> <tbody> <tr> <td>0H2213A1</td> <td></td> <td>1</td> <td>PZ</td> </tr> <tr> <td>EL1440A0</td> <td>WATER SELF CLEANING VALVE</td> <td>2</td> <td>PZ</td> </tr> </tbody> </table>	Code	Description	Qty	UOM	0H2213A1		1	PZ	EL1440A0	WATER SELF CLEANING VALVE	2	PZ
			Code	Description	Qty	UOM																																																																																						
RC1018A0	ZINC PLATED D12 ELASTIC CLAMP	2	PZ																																																																																									
RC1019A0	D=10 ELASTIC CLAMP	14	PZ																																																																																									
RC1130A0	130X2,6 CLAM	1	PZ																																																																																									
RC1242A0	D=10 CLOSED CAP	2	PZ																																																																																									
TB2820A0	6X10 EPDM PIPE FOR WASHING SYSTEM	1.290	M																																																																																									
TB3132A0	WHITE-BLUE EPDM TEXTILE BRAID HOSE 6X12	0.670	M																																																																																									
VI1220A1	4,2X12 TCB SELF-TAPPIN G SCREW	4	PZ																																																																																									
VL1019A0	VIBRATION PUMP	1	PZ																																																																																									
VL1047A1	D6 PIPE HOLDER - D8 J.G. TERMINAL	1	PZ																																																																																									
VL1054B0	ONE WASHING SYS INLET DISTRIBUTOR	1	PZ																																																																																									
VL1102A1	DETERGENT LINE FILTER + BARBED VNR 6 MM	1	PZ																																																																																									
VL1128A1	D6 BARBED CHECK VALVE	2	PZ																																																																																									
VL1165A0	BB6-AR6 STRAIGHT FITTING	1	PZ																																																																																									
VL1166A0	BB6-AR6 L FITTING	1	PZ																																																																																									
VL1174C0	D1.2 MM CALIBRATED NOZZLE	1	PZ																																																																																									
VL1191A0	ONE WASHING DISTRIBUTOR OUTLETS KIT	1	PZ																																																																																									
VM2172A0	PUMP-WITH-CI RCUIT LOCKING PIN	3	PZ																																																																																									
Code	Description	Qty	UOM																																																																																									
0H2213A1		1	PZ																																																																																									
EL1440A0	WATER SELF CLEANING VALVE	2	PZ																																																																																									



COMPONENT			SPARE PART																																																																																						
Code	Description	Image	Code	Description	Components list																																																																																				
VL1191A	ONE WASHING DISTRIBUTOR OUTLETS KIT		KVL1198A	MM EU HOOD CLEANING SYSTEM KIT	<table border="1"> <thead> <tr> <th>Code</th> <th>Description</th> <th>Qty</th> <th>UOM</th> </tr> </thead> <tbody> <tr> <td>GN1526A0</td> <td>INT. D.=6.9 TH=1.8 O-RIN</td> <td>5</td> <td>PZ</td> </tr> <tr> <td>RC1018A0</td> <td>ZINC PLATED D12 ELASTIC CLAMP</td> <td>6</td> <td>PZ</td> </tr> <tr> <td>RC1019A0</td> <td>D=10 ELASTIC CLAMP</td> <td>16</td> <td>PZ</td> </tr> <tr> <td>RC1131A0</td> <td>200X2.6 BLACK CLAMP</td> <td>1</td> <td>PZ</td> </tr> <tr> <td>RC1242A0</td> <td>D=10 CLOSED CAP</td> <td>2</td> <td>PZ</td> </tr> <tr> <td>TB2820A0</td> <td>6X10 EPDM PIPE FOR WASHING SYSTEM</td> <td>2.240</td> <td>M</td> </tr> <tr> <td>TB3132A0</td> <td>WHITE-BLUE EPDM TEXTILE BRAID HOSE 6X12</td> <td>0.440</td> <td>M</td> </tr> <tr> <td>V11220A1</td> <td>4,2X12 TCB SELF-TAPPING SCREW</td> <td>3</td> <td>PZ</td> </tr> <tr> <td>VL1019A0</td> <td>VIBRATION PUMP</td> <td>1</td> <td>PZ</td> </tr> <tr> <td>VL1047A1</td> <td>D6 PIPE HOLDER - D8 J.G. TERMINAL</td> <td>2</td> <td>PZ</td> </tr> <tr> <td>VL1054B0</td> <td>ONE WASHING SYS INLET DISTRIBUTOR</td> <td>1</td> <td>PZ</td> </tr> <tr> <td>VL1102A1</td> <td>DETERGENT LINE FILTER + BARBED VNR 6 MM</td> <td>1</td> <td>PZ</td> </tr> <tr> <td>VL1127A1</td> <td>6MM BARBED T-SHAPED FITTING</td> <td>1</td> <td>PZ</td> </tr> <tr> <td>VL1128A1</td> <td>D6 BARBED CHECK VALVE</td> <td>2</td> <td>PZ</td> </tr> <tr> <td>VL1165A0</td> <td>BB6-AR6 STRAIGHT FITTING</td> <td>2</td> <td>PZ</td> </tr> <tr> <td>VL1166A0</td> <td>BB6-AR6 L FITTING</td> <td>2</td> <td>PZ</td> </tr> <tr> <td>VL1174C0</td> <td>D1.2 MM CALIBRATED NOZZLE</td> <td>1</td> <td>PZ</td> </tr> <tr> <td>VL1191A0</td> <td>ONE WASHING DISTRIBUTOR OUTLETS KIT</td> <td>1</td> <td>PZ</td> </tr> <tr> <td>VM1605A0</td> <td>CLIP TWIST LOCK DIAM. 10,2-12,7 MM</td> <td>4</td> <td>PZ</td> </tr> <tr> <td>VM2172A0</td> <td>PUMP-WITH-CI RCUIT LOCKING PIN</td> <td>5</td> <td>PZ</td> </tr> </tbody> </table>	Code	Description	Qty	UOM	GN1526A0	INT. D.=6.9 TH=1.8 O-RIN	5	PZ	RC1018A0	ZINC PLATED D12 ELASTIC CLAMP	6	PZ	RC1019A0	D=10 ELASTIC CLAMP	16	PZ	RC1131A0	200X2.6 BLACK CLAMP	1	PZ	RC1242A0	D=10 CLOSED CAP	2	PZ	TB2820A0	6X10 EPDM PIPE FOR WASHING SYSTEM	2.240	M	TB3132A0	WHITE-BLUE EPDM TEXTILE BRAID HOSE 6X12	0.440	M	V11220A1	4,2X12 TCB SELF-TAPPING SCREW	3	PZ	VL1019A0	VIBRATION PUMP	1	PZ	VL1047A1	D6 PIPE HOLDER - D8 J.G. TERMINAL	2	PZ	VL1054B0	ONE WASHING SYS INLET DISTRIBUTOR	1	PZ	VL1102A1	DETERGENT LINE FILTER + BARBED VNR 6 MM	1	PZ	VL1127A1	6MM BARBED T-SHAPED FITTING	1	PZ	VL1128A1	D6 BARBED CHECK VALVE	2	PZ	VL1165A0	BB6-AR6 STRAIGHT FITTING	2	PZ	VL1166A0	BB6-AR6 L FITTING	2	PZ	VL1174C0	D1.2 MM CALIBRATED NOZZLE	1	PZ	VL1191A0	ONE WASHING DISTRIBUTOR OUTLETS KIT	1	PZ	VM1605A0	CLIP TWIST LOCK DIAM. 10,2-12,7 MM	4	PZ	VM2172A0	PUMP-WITH-CI RCUIT LOCKING PIN	5	PZ
Code	Description	Qty	UOM																																																																																						
GN1526A0	INT. D.=6.9 TH=1.8 O-RIN	5	PZ																																																																																						
RC1018A0	ZINC PLATED D12 ELASTIC CLAMP	6	PZ																																																																																						
RC1019A0	D=10 ELASTIC CLAMP	16	PZ																																																																																						
RC1131A0	200X2.6 BLACK CLAMP	1	PZ																																																																																						
RC1242A0	D=10 CLOSED CAP	2	PZ																																																																																						
TB2820A0	6X10 EPDM PIPE FOR WASHING SYSTEM	2.240	M																																																																																						
TB3132A0	WHITE-BLUE EPDM TEXTILE BRAID HOSE 6X12	0.440	M																																																																																						
V11220A1	4,2X12 TCB SELF-TAPPING SCREW	3	PZ																																																																																						
VL1019A0	VIBRATION PUMP	1	PZ																																																																																						
VL1047A1	D6 PIPE HOLDER - D8 J.G. TERMINAL	2	PZ																																																																																						
VL1054B0	ONE WASHING SYS INLET DISTRIBUTOR	1	PZ																																																																																						
VL1102A1	DETERGENT LINE FILTER + BARBED VNR 6 MM	1	PZ																																																																																						
VL1127A1	6MM BARBED T-SHAPED FITTING	1	PZ																																																																																						
VL1128A1	D6 BARBED CHECK VALVE	2	PZ																																																																																						
VL1165A0	BB6-AR6 STRAIGHT FITTING	2	PZ																																																																																						
VL1166A0	BB6-AR6 L FITTING	2	PZ																																																																																						
VL1174C0	D1.2 MM CALIBRATED NOZZLE	1	PZ																																																																																						
VL1191A0	ONE WASHING DISTRIBUTOR OUTLETS KIT	1	PZ																																																																																						
VM1605A0	CLIP TWIST LOCK DIAM. 10,2-12,7 MM	4	PZ																																																																																						
VM2172A0	PUMP-WITH-CI RCUIT LOCKING PIN	5	PZ																																																																																						

COMPONENT			SPARE PART																																																																																		
Code	Description	Image	Code	Description	Components list																																																																																
VL1191A	ONE WASHING DISTRIBUTOR OUTLETS KIT		KVL1182A	ONE CLEANING SYSTEM KIT (0311 EXC.)	<table border="1"> <thead> <tr> <th>Code</th> <th>Description</th> <th>Qty</th> <th>UOM</th> </tr> </thead> <tbody> <tr> <td>0H2143A0</td> <td>LAMIERA BLOCCA VNR VL1128</td> <td>2</td> <td>PZ</td> </tr> <tr> <td>0H2202A1</td> <td>ONE WASHING WITH STEAM VALVE SUPPORT</td> <td>1</td> <td>PZ</td> </tr> <tr> <td>EL1440A0</td> <td>WATER SELF CLEANING VALVE</td> <td>1</td> <td>PZ</td> </tr> <tr> <td>GN1526A0</td> <td>INT. D.=6.9 TH=1.8 O-RIN</td> <td>3</td> <td>PZ</td> </tr> <tr> <td>RC1018A0</td> <td>ZINC PLATED D12 ELASTIC CLAMP</td> <td>1</td> <td>PZ</td> </tr> <tr> <td>RC1019A0</td> <td>D=10 ELASTIC CLAMP</td> <td>14</td> <td>PZ</td> </tr> <tr> <td>RC1130A0</td> <td>130X2,6 CLAM</td> <td>2</td> <td>PZ</td> </tr> <tr> <td>RC1242A0</td> <td>D=10 CLOSED CAP</td> <td>2</td> <td>PZ</td> </tr> <tr> <td>TB2820A0</td> <td>6X10 EPDM PIPE FOR WASHING SYSTEM</td> <td>1.410</td> <td>M</td> </tr> <tr> <td>TB3132A0</td> <td>WHITE-BLUE EPDM TEXTILE BRAID HOSE 6X12</td> <td>0.670</td> <td>M</td> </tr> <tr> <td>VI1220A1</td> <td>4,2X12 TCB SELF-TAPPIN G SCREW</td> <td>1</td> <td>PZ</td> </tr> <tr> <td>VL1019A0</td> <td>VIBRATION PUMP</td> <td>1</td> <td>PZ</td> </tr> <tr> <td>VL1047A1</td> <td>D6 PIPE HOLDER - D8 J.G. TERMINAL</td> <td>1</td> <td>PZ</td> </tr> <tr> <td>VL1054B0</td> <td>ONE WASHING SYS INLET DISTRIBUTOR</td> <td>1</td> <td>PZ</td> </tr> <tr> <td>VL1102A1</td> <td>DETERGENT LINE FILTER + BARBED VNR 6 MM</td> <td>1</td> <td>PZ</td> </tr> <tr> <td>VL1128A0</td> <td>D6 BARBED CHECK VALVE</td> <td>2</td> <td>PZ</td> </tr> <tr> <td>VL1128A1</td> <td>D6 BARBED CHECK VALVE</td> <td>2</td> <td>PZ</td> </tr> <tr> <td>VL1165A0</td> <td>BB6-AR6 STRAIGHT FITTING</td> <td>1</td> <td>PZ</td> </tr> <tr> <td>VL1166A0</td> <td>BB6-AR6 L FITTING</td> <td>1</td> <td>PZ</td> </tr> </tbody> </table>	Code	Description	Qty	UOM	0H2143A0	LAMIERA BLOCCA VNR VL1128	2	PZ	0H2202A1	ONE WASHING WITH STEAM VALVE SUPPORT	1	PZ	EL1440A0	WATER SELF CLEANING VALVE	1	PZ	GN1526A0	INT. D.=6.9 TH=1.8 O-RIN	3	PZ	RC1018A0	ZINC PLATED D12 ELASTIC CLAMP	1	PZ	RC1019A0	D=10 ELASTIC CLAMP	14	PZ	RC1130A0	130X2,6 CLAM	2	PZ	RC1242A0	D=10 CLOSED CAP	2	PZ	TB2820A0	6X10 EPDM PIPE FOR WASHING SYSTEM	1.410	M	TB3132A0	WHITE-BLUE EPDM TEXTILE BRAID HOSE 6X12	0.670	M	VI1220A1	4,2X12 TCB SELF-TAPPIN G SCREW	1	PZ	VL1019A0	VIBRATION PUMP	1	PZ	VL1047A1	D6 PIPE HOLDER - D8 J.G. TERMINAL	1	PZ	VL1054B0	ONE WASHING SYS INLET DISTRIBUTOR	1	PZ	VL1102A1	DETERGENT LINE FILTER + BARBED VNR 6 MM	1	PZ	VL1128A0	D6 BARBED CHECK VALVE	2	PZ	VL1128A1	D6 BARBED CHECK VALVE	2	PZ	VL1165A0	BB6-AR6 STRAIGHT FITTING	1	PZ	VL1166A0	BB6-AR6 L FITTING	1	PZ
Code	Description	Qty	UOM																																																																																		
0H2143A0	LAMIERA BLOCCA VNR VL1128	2	PZ																																																																																		
0H2202A1	ONE WASHING WITH STEAM VALVE SUPPORT	1	PZ																																																																																		
EL1440A0	WATER SELF CLEANING VALVE	1	PZ																																																																																		
GN1526A0	INT. D.=6.9 TH=1.8 O-RIN	3	PZ																																																																																		
RC1018A0	ZINC PLATED D12 ELASTIC CLAMP	1	PZ																																																																																		
RC1019A0	D=10 ELASTIC CLAMP	14	PZ																																																																																		
RC1130A0	130X2,6 CLAM	2	PZ																																																																																		
RC1242A0	D=10 CLOSED CAP	2	PZ																																																																																		
TB2820A0	6X10 EPDM PIPE FOR WASHING SYSTEM	1.410	M																																																																																		
TB3132A0	WHITE-BLUE EPDM TEXTILE BRAID HOSE 6X12	0.670	M																																																																																		
VI1220A1	4,2X12 TCB SELF-TAPPIN G SCREW	1	PZ																																																																																		
VL1019A0	VIBRATION PUMP	1	PZ																																																																																		
VL1047A1	D6 PIPE HOLDER - D8 J.G. TERMINAL	1	PZ																																																																																		
VL1054B0	ONE WASHING SYS INLET DISTRIBUTOR	1	PZ																																																																																		
VL1102A1	DETERGENT LINE FILTER + BARBED VNR 6 MM	1	PZ																																																																																		
VL1128A0	D6 BARBED CHECK VALVE	2	PZ																																																																																		
VL1128A1	D6 BARBED CHECK VALVE	2	PZ																																																																																		
VL1165A0	BB6-AR6 STRAIGHT FITTING	1	PZ																																																																																		
VL1166A0	BB6-AR6 L FITTING	1	PZ																																																																																		

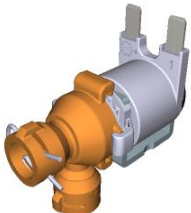
COMPONENT			SPARE PART																																											
Code	Description	Image	Code	Description	Components list																																									
VL1191A	ONE WASHING DISTRIBUTOR OUTLETS KIT		KVL1182A	ONE CLEANING SYSTEM KIT (0311 EXC.)	<table border="1"> <thead> <tr> <th>Code</th> <th>Description</th> <th>Qty</th> <th>UOM</th> </tr> </thead> <tbody> <tr> <td>VL1174C0</td> <td>D1.2 MM CALIBRATED NOZZLE</td> <td>1</td> <td>PZ</td> </tr> <tr> <td>VL1191A0</td> <td>ONE WASHING DISTRIBUTOR OUTLETS KIT</td> <td>1</td> <td>PZ</td> </tr> <tr> <td>VM1605A0</td> <td>CLIP TWIST LOCK DIAM. 10,2-12,7 MM</td> <td>3</td> <td>PZ</td> </tr> <tr> <td>VM2172A0</td> <td>PUMP-WITH-CI RCUIT LOCKING PIN</td> <td>2</td> <td>PZ</td> </tr> </tbody> </table>	Code	Description	Qty	UOM	VL1174C0	D1.2 MM CALIBRATED NOZZLE	1	PZ	VL1191A0	ONE WASHING DISTRIBUTOR OUTLETS KIT	1	PZ	VM1605A0	CLIP TWIST LOCK DIAM. 10,2-12,7 MM	3	PZ	VM2172A0	PUMP-WITH-CI RCUIT LOCKING PIN	2	PZ																					
			Code	Description	Qty	UOM																																								
VL1174C0	D1.2 MM CALIBRATED NOZZLE	1	PZ																																											
VL1191A0	ONE WASHING DISTRIBUTOR OUTLETS KIT	1	PZ																																											
VM1605A0	CLIP TWIST LOCK DIAM. 10,2-12,7 MM	3	PZ																																											
VM2172A0	PUMP-WITH-CI RCUIT LOCKING PIN	2	PZ																																											
KVL0682A	ONE+HOODS WASHING SYSTEM PUMP+NOZZLE KIT	<table border="1"> <thead> <tr> <th>Code</th> <th>Description</th> <th>Qty</th> <th>UOM</th> </tr> </thead> <tbody> <tr> <td>GN1526A0</td> <td>INT. D.=6.9 TH=1.8 O-RIN</td> <td>1</td> <td>PZ</td> </tr> <tr> <td>RC1019A0</td> <td>D=10 ELASTIC CLAMP</td> <td>3</td> <td>PZ</td> </tr> <tr> <td>RC1242A0</td> <td>D=10 CLOSED CAP</td> <td>2</td> <td>PZ</td> </tr> <tr> <td>TB2820A0</td> <td>6X10 EPDM PIPE FOR WASHING SYSTEM</td> <td>0.120</td> <td>M</td> </tr> <tr> <td>VL1019A0</td> <td>VIBRATION PUMP</td> <td>1</td> <td>PZ</td> </tr> <tr> <td>VL1054B0</td> <td>ONE WASHING SYS INLET DISTRIBUTOR</td> <td>1</td> <td>PZ</td> </tr> <tr> <td>VL1128A1</td> <td>D6 BARBED CHECK VALVE</td> <td>2</td> <td>PZ</td> </tr> <tr> <td>VL1174C0</td> <td>D1.2 MM CALIBRATED NOZZLE</td> <td>1</td> <td>PZ</td> </tr> <tr> <td>VL1191A0</td> <td>ONE WASHING DISTRIBUTOR OUTLETS KIT</td> <td>1</td> <td>PZ</td> </tr> <tr> <td>VM2172A0</td> <td>PUMP-WITH-CI RCUIT LOCKING PIN</td> <td>1</td> <td>PZ</td> </tr> </tbody> </table>	Code	Description	Qty	UOM	GN1526A0	INT. D.=6.9 TH=1.8 O-RIN	1	PZ	RC1019A0	D=10 ELASTIC CLAMP	3	PZ	RC1242A0	D=10 CLOSED CAP	2	PZ	TB2820A0	6X10 EPDM PIPE FOR WASHING SYSTEM	0.120	M	VL1019A0	VIBRATION PUMP	1	PZ	VL1054B0	ONE WASHING SYS INLET DISTRIBUTOR	1	PZ	VL1128A1	D6 BARBED CHECK VALVE	2	PZ	VL1174C0	D1.2 MM CALIBRATED NOZZLE	1	PZ	VL1191A0	ONE WASHING DISTRIBUTOR OUTLETS KIT	1	PZ	VM2172A0	PUMP-WITH-CI RCUIT LOCKING PIN	1	PZ
Code	Description	Qty	UOM																																											
GN1526A0	INT. D.=6.9 TH=1.8 O-RIN	1	PZ																																											
RC1019A0	D=10 ELASTIC CLAMP	3	PZ																																											
RC1242A0	D=10 CLOSED CAP	2	PZ																																											
TB2820A0	6X10 EPDM PIPE FOR WASHING SYSTEM	0.120	M																																											
VL1019A0	VIBRATION PUMP	1	PZ																																											
VL1054B0	ONE WASHING SYS INLET DISTRIBUTOR	1	PZ																																											
VL1128A1	D6 BARBED CHECK VALVE	2	PZ																																											
VL1174C0	D1.2 MM CALIBRATED NOZZLE	1	PZ																																											
VL1191A0	ONE WASHING DISTRIBUTOR OUTLETS KIT	1	PZ																																											
VM2172A0	PUMP-WITH-CI RCUIT LOCKING PIN	1	PZ																																											
EL1440A	WATER SELF CLEANING VALVE		KVL1187A	3 ROTOR ARMS PLUS EU CLEANING SYSTEM KIT	<table border="1"> <thead> <tr> <th>Code</th> <th>Description</th> <th>Qty</th> <th>UOM</th> </tr> </thead> <tbody> <tr> <td>0H2143A0</td> <td>LAMIERA BLOCCA VNR VL1128</td> <td>3</td> <td>PZ</td> </tr> <tr> <td>0H2168A0</td> <td></td> <td>1</td> <td>PZ</td> </tr> <tr> <td>0H2354A0</td> <td>XEVC-XEVL WASHING CIRCUIT PLAT</td> <td>1</td> <td>PZ</td> </tr> </tbody> </table>	Code	Description	Qty	UOM	0H2143A0	LAMIERA BLOCCA VNR VL1128	3	PZ	0H2168A0		1	PZ	0H2354A0	XEVC-XEVL WASHING CIRCUIT PLAT	1	PZ																									
Code	Description	Qty	UOM																																											
0H2143A0	LAMIERA BLOCCA VNR VL1128	3	PZ																																											
0H2168A0		1	PZ																																											
0H2354A0	XEVC-XEVL WASHING CIRCUIT PLAT	1	PZ																																											

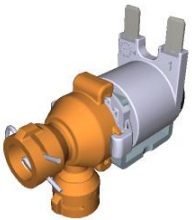
COMPONENT			SPARE PART																																																																																		
Code	Description	Image	Code	Description	Components list																																																																																
EL1440A	WATER SELF CLEANING VALVE		KVL1187A	3 ROTOR ARMS PLUS EU CLEANING SYSTEM KIT	<table border="1"> <thead> <tr> <th>Code</th> <th>Description</th> <th>Qty</th> <th>UOM</th> </tr> </thead> <tbody> <tr> <td>EL1120A0</td> <td>D8-D6 FEMALE STRAIGHT INTERM. CONNECTION</td> <td>1</td> <td>PZ</td> </tr> <tr> <td>EL1220A0</td> <td>JG STRAIGHT CONNECTION Ø8F-Ø8F</td> <td>2</td> <td>PZ</td> </tr> <tr> <td>EL1440A0</td> <td>WATER SELF CLEANING VALVE</td> <td>4</td> <td>PZ</td> </tr> <tr> <td>GN1526A0</td> <td>INT. D.=6.9 TH=1.8 O-RIN</td> <td>9</td> <td>PZ</td> </tr> <tr> <td>RC1018A0</td> <td>ZINC PLATED D12 ELASTIC CLAMP</td> <td>10</td> <td>PZ</td> </tr> <tr> <td>RC1019A0</td> <td>D=10 ELASTIC CLAMP</td> <td>22</td> <td>PZ</td> </tr> <tr> <td>RC1130A0</td> <td>130X2,6 CLAM</td> <td>4</td> <td>PZ</td> </tr> <tr> <td>RC1131A0</td> <td>200X2.6 BLACK CLAMP</td> <td>3</td> <td>PZ</td> </tr> <tr> <td>RC1242A0</td> <td>D=10 CLOSED CAP</td> <td>2</td> <td>PZ</td> </tr> <tr> <td>RC1310A0</td> <td>140X4 CLAMP WITH CLIP</td> <td>1</td> <td>PZ</td> </tr> <tr> <td>RC1356A0</td> <td>"STRAIGHT THREADED FEMALE END 8X1/4" BS</td> <td>1</td> <td>PZ</td> </tr> <tr> <td>TB2820A0</td> <td>6X10 EPDM PIPE FOR WASHING SYSTEM</td> <td>1.510</td> <td>M</td> </tr> <tr> <td>TB3132A0</td> <td>WHITE-BLUE EPDM TEXTILE BRAID HOSE 6X12</td> <td>1.210</td> <td>M</td> </tr> <tr> <td>VI1220A1</td> <td>4,2X12 TCB SELF-TAPPIN G SCREW</td> <td>3</td> <td>PZ</td> </tr> <tr> <td>VL1019A0</td> <td>VIBRATION PUMP</td> <td>1</td> <td>PZ</td> </tr> <tr> <td>VL1046A1</td> <td>D6 PIPE HOLDER - D6 J.G. TERMINAL</td> <td>3</td> <td>PZ</td> </tr> <tr> <td>VL1047A1</td> <td>D6 PIPE HOLDER - D8 J.G. TERMINAL</td> <td>1</td> <td>PZ</td> </tr> <tr> <td>VL1064A0</td> <td>WASHING SYSTEM OUTLETS DISTRIBUTOR</td> <td>1</td> <td>PZ</td> </tr> <tr> <td>VL1065A1</td> <td>1/4 MALE N.O. PRESSURE SWITCH</td> <td>1</td> <td>PZ</td> </tr> </tbody> </table>	Code	Description	Qty	UOM	EL1120A0	D8-D6 FEMALE STRAIGHT INTERM. CONNECTION	1	PZ	EL1220A0	JG STRAIGHT CONNECTION Ø8F-Ø8F	2	PZ	EL1440A0	WATER SELF CLEANING VALVE	4	PZ	GN1526A0	INT. D.=6.9 TH=1.8 O-RIN	9	PZ	RC1018A0	ZINC PLATED D12 ELASTIC CLAMP	10	PZ	RC1019A0	D=10 ELASTIC CLAMP	22	PZ	RC1130A0	130X2,6 CLAM	4	PZ	RC1131A0	200X2.6 BLACK CLAMP	3	PZ	RC1242A0	D=10 CLOSED CAP	2	PZ	RC1310A0	140X4 CLAMP WITH CLIP	1	PZ	RC1356A0	"STRAIGHT THREADED FEMALE END 8X1/4" BS	1	PZ	TB2820A0	6X10 EPDM PIPE FOR WASHING SYSTEM	1.510	M	TB3132A0	WHITE-BLUE EPDM TEXTILE BRAID HOSE 6X12	1.210	M	VI1220A1	4,2X12 TCB SELF-TAPPIN G SCREW	3	PZ	VL1019A0	VIBRATION PUMP	1	PZ	VL1046A1	D6 PIPE HOLDER - D6 J.G. TERMINAL	3	PZ	VL1047A1	D6 PIPE HOLDER - D8 J.G. TERMINAL	1	PZ	VL1064A0	WASHING SYSTEM OUTLETS DISTRIBUTOR	1	PZ	VL1065A1	1/4 MALE N.O. PRESSURE SWITCH	1	PZ
Code	Description	Qty	UOM																																																																																		
EL1120A0	D8-D6 FEMALE STRAIGHT INTERM. CONNECTION	1	PZ																																																																																		
EL1220A0	JG STRAIGHT CONNECTION Ø8F-Ø8F	2	PZ																																																																																		
EL1440A0	WATER SELF CLEANING VALVE	4	PZ																																																																																		
GN1526A0	INT. D.=6.9 TH=1.8 O-RIN	9	PZ																																																																																		
RC1018A0	ZINC PLATED D12 ELASTIC CLAMP	10	PZ																																																																																		
RC1019A0	D=10 ELASTIC CLAMP	22	PZ																																																																																		
RC1130A0	130X2,6 CLAM	4	PZ																																																																																		
RC1131A0	200X2.6 BLACK CLAMP	3	PZ																																																																																		
RC1242A0	D=10 CLOSED CAP	2	PZ																																																																																		
RC1310A0	140X4 CLAMP WITH CLIP	1	PZ																																																																																		
RC1356A0	"STRAIGHT THREADED FEMALE END 8X1/4" BS	1	PZ																																																																																		
TB2820A0	6X10 EPDM PIPE FOR WASHING SYSTEM	1.510	M																																																																																		
TB3132A0	WHITE-BLUE EPDM TEXTILE BRAID HOSE 6X12	1.210	M																																																																																		
VI1220A1	4,2X12 TCB SELF-TAPPIN G SCREW	3	PZ																																																																																		
VL1019A0	VIBRATION PUMP	1	PZ																																																																																		
VL1046A1	D6 PIPE HOLDER - D6 J.G. TERMINAL	3	PZ																																																																																		
VL1047A1	D6 PIPE HOLDER - D8 J.G. TERMINAL	1	PZ																																																																																		
VL1064A0	WASHING SYSTEM OUTLETS DISTRIBUTOR	1	PZ																																																																																		
VL1065A1	1/4 MALE N.O. PRESSURE SWITCH	1	PZ																																																																																		

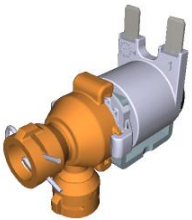
COMPONENT			SPARE PART																																																																										
Code	Description	Image	Code	Description	Components list																																																																								
EL1440A	WATER SELF CLEANING VALVE		KVL1187A	3 ROTOR ARMS PLUS EU CLEANING SYSTEM KIT	<table border="1"> <thead> <tr> <th>Code</th> <th>Description</th> <th>Qty</th> <th>UOM</th> </tr> </thead> <tbody> <tr> <td>VL1067A0</td> <td>WASHING SYSTEM INLETS DISTRIBUTOR</td> <td>1</td> <td>PZ</td> </tr> <tr> <td>VL1092A0</td> <td>WASHING SYSTEM OUTLET DOUBLE DISTRIBUTOR</td> <td>1</td> <td>PZ</td> </tr> <tr> <td>VL1102A1</td> <td>DETERGENT LINE FILTER + BARBED VNR 6 MM</td> <td>1</td> <td>PZ</td> </tr> <tr> <td>VL1127A1</td> <td>6MM BARBED T-SHAPED FITTING</td> <td>2</td> <td>PZ</td> </tr> <tr> <td>VL1128A0</td> <td>D6 BARBED CHECK VALVE</td> <td>3</td> <td>PZ</td> </tr> <tr> <td>VL1128A1</td> <td>D6 BARBED CHECK VALVE</td> <td>3</td> <td>PZ</td> </tr> <tr> <td>VL1165A0</td> <td>BB6-AR6 STRAIGHT FITTING</td> <td>4</td> <td>PZ</td> </tr> <tr> <td>VL1166A0</td> <td>BB6-AR6 L FITTING</td> <td>4</td> <td>PZ</td> </tr> <tr> <td>VL1167A0</td> <td></td> <td>1</td> <td>PZ</td> </tr> <tr> <td>VL1167A1</td> <td></td> <td>1</td> <td>PZ</td> </tr> <tr> <td>VL1167A2</td> <td>GN21 3 ROTOR ARMS B-B FLOW RESTRICTOR</td> <td>1</td> <td>PZ</td> </tr> <tr> <td>VL1174C0</td> <td>D1.2 MM CALIBRATED NOZZLE</td> <td>1</td> <td>PZ</td> </tr> <tr> <td>VL1185A0</td> <td>2 WAYS PLUS WASHING DISTRIBUTOR</td> <td>1</td> <td>PZ</td> </tr> <tr> <td>VL1186A0</td> <td>3 WAYS PLUS WASHING DISTRIBUTOR</td> <td>1</td> <td>PZ</td> </tr> <tr> <td>VL1190A0</td> <td>PLUS WASHING SYSTEM INLET DISTRIBUTOR</td> <td>1</td> <td>PZ</td> </tr> <tr> <td>VM1605A0</td> <td>CLIP TWIST LOCK DIAM. 10,2-12,7 MM</td> <td>3</td> <td>PZ</td> </tr> <tr> <td>VM2172A0</td> <td>PUMP-WITH-CI RCUIT LOCKING PIN</td> <td>9</td> <td>PZ</td> </tr> </tbody> </table>	Code	Description	Qty	UOM	VL1067A0	WASHING SYSTEM INLETS DISTRIBUTOR	1	PZ	VL1092A0	WASHING SYSTEM OUTLET DOUBLE DISTRIBUTOR	1	PZ	VL1102A1	DETERGENT LINE FILTER + BARBED VNR 6 MM	1	PZ	VL1127A1	6MM BARBED T-SHAPED FITTING	2	PZ	VL1128A0	D6 BARBED CHECK VALVE	3	PZ	VL1128A1	D6 BARBED CHECK VALVE	3	PZ	VL1165A0	BB6-AR6 STRAIGHT FITTING	4	PZ	VL1166A0	BB6-AR6 L FITTING	4	PZ	VL1167A0		1	PZ	VL1167A1		1	PZ	VL1167A2	GN21 3 ROTOR ARMS B-B FLOW RESTRICTOR	1	PZ	VL1174C0	D1.2 MM CALIBRATED NOZZLE	1	PZ	VL1185A0	2 WAYS PLUS WASHING DISTRIBUTOR	1	PZ	VL1186A0	3 WAYS PLUS WASHING DISTRIBUTOR	1	PZ	VL1190A0	PLUS WASHING SYSTEM INLET DISTRIBUTOR	1	PZ	VM1605A0	CLIP TWIST LOCK DIAM. 10,2-12,7 MM	3	PZ	VM2172A0	PUMP-WITH-CI RCUIT LOCKING PIN	9	PZ
Code	Description	Qty	UOM																																																																										
VL1067A0	WASHING SYSTEM INLETS DISTRIBUTOR	1	PZ																																																																										
VL1092A0	WASHING SYSTEM OUTLET DOUBLE DISTRIBUTOR	1	PZ																																																																										
VL1102A1	DETERGENT LINE FILTER + BARBED VNR 6 MM	1	PZ																																																																										
VL1127A1	6MM BARBED T-SHAPED FITTING	2	PZ																																																																										
VL1128A0	D6 BARBED CHECK VALVE	3	PZ																																																																										
VL1128A1	D6 BARBED CHECK VALVE	3	PZ																																																																										
VL1165A0	BB6-AR6 STRAIGHT FITTING	4	PZ																																																																										
VL1166A0	BB6-AR6 L FITTING	4	PZ																																																																										
VL1167A0		1	PZ																																																																										
VL1167A1		1	PZ																																																																										
VL1167A2	GN21 3 ROTOR ARMS B-B FLOW RESTRICTOR	1	PZ																																																																										
VL1174C0	D1.2 MM CALIBRATED NOZZLE	1	PZ																																																																										
VL1185A0	2 WAYS PLUS WASHING DISTRIBUTOR	1	PZ																																																																										
VL1186A0	3 WAYS PLUS WASHING DISTRIBUTOR	1	PZ																																																																										
VL1190A0	PLUS WASHING SYSTEM INLET DISTRIBUTOR	1	PZ																																																																										
VM1605A0	CLIP TWIST LOCK DIAM. 10,2-12,7 MM	3	PZ																																																																										
VM2172A0	PUMP-WITH-CI RCUIT LOCKING PIN	9	PZ																																																																										



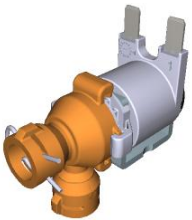

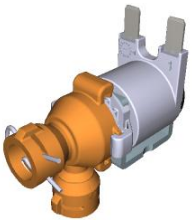
COMPONENT			SPARE PART																																																																																		
Code	Description	Image	Code	Description	Components list																																																																																
EL1440A	WATER SELF CLEANING VALVE		KVL1184A	2 ROTOR ARMS PLUS EU CLEANING SYSTEM KIT	<table border="1"> <thead> <tr> <th>Code</th> <th>Description</th> <th>Qty</th> <th>UOM</th> </tr> </thead> <tbody> <tr> <td>0H2143A0</td> <td>LAMIERA BLOCCA VNR VL1128</td> <td>2</td> <td>PZ</td> </tr> <tr> <td>0H2168A0</td> <td></td> <td>1</td> <td>PZ</td> </tr> <tr> <td>0H2354A0</td> <td>XEVC-XEVL WASHING CIRCUIT PLAT</td> <td>1</td> <td>PZ</td> </tr> <tr> <td>EL1220A0</td> <td>JG STRAIGHT CONNECTION Ø8F-Ø8F</td> <td>3</td> <td>PZ</td> </tr> <tr> <td>EL1440A0</td> <td>WATER SELF CLEANING VALVE</td> <td>4</td> <td>PZ</td> </tr> <tr> <td>GN1526A0</td> <td>INT. D.=6.9 TH=1.8 O-RIN</td> <td>9</td> <td>PZ</td> </tr> <tr> <td>RC1018A0</td> <td>ZINC PLATED D12 ELASTIC CLAMP</td> <td>2</td> <td>PZ</td> </tr> <tr> <td>RC1019A0</td> <td>D=10 ELASTIC CLAMP</td> <td>21</td> <td>PZ</td> </tr> <tr> <td>RC1130A0</td> <td>130X2,6 CLAM</td> <td>7</td> <td>PZ</td> </tr> <tr> <td>RC1131A0</td> <td>200X2.6 BLACK CLAMP</td> <td>3</td> <td>PZ</td> </tr> <tr> <td>RC1242A0</td> <td>D=10 CLOSED CAP</td> <td>2</td> <td>PZ</td> </tr> <tr> <td>RC1356A0</td> <td>"STRAIGHT THREADED FEMALE END 8X1/4" BS</td> <td>1</td> <td>PZ</td> </tr> <tr> <td>TB2820A0</td> <td>6X10 EPDM PIPE FOR WASHING SYSTEM</td> <td>2.400</td> <td>M</td> </tr> <tr> <td>TB3132A0</td> <td>WHITE-BLUE EPDM TEXTILE BRAID HOSE 6X12</td> <td>1.220</td> <td>M</td> </tr> <tr> <td>VL1019A0</td> <td>VIBRATION PUMP</td> <td>1</td> <td>PZ</td> </tr> <tr> <td>VL1046A1</td> <td>D6 PIPE HOLDER - D6 J.G. TERMINAL</td> <td>3</td> <td>PZ</td> </tr> <tr> <td>VL1047A1</td> <td>D6 PIPE HOLDER - D8 J.G. TERMINAL</td> <td>1</td> <td>PZ</td> </tr> <tr> <td>VL1065A1</td> <td>1/4 MALE N.O. PRESSURE SWITCH</td> <td>1</td> <td>PZ</td> </tr> <tr> <td>VL1067A0</td> <td>WASHING SYSTEM INLETS DISTRIBUTOR</td> <td>1</td> <td>PZ</td> </tr> </tbody> </table>	Code	Description	Qty	UOM	0H2143A0	LAMIERA BLOCCA VNR VL1128	2	PZ	0H2168A0		1	PZ	0H2354A0	XEVC-XEVL WASHING CIRCUIT PLAT	1	PZ	EL1220A0	JG STRAIGHT CONNECTION Ø8F-Ø8F	3	PZ	EL1440A0	WATER SELF CLEANING VALVE	4	PZ	GN1526A0	INT. D.=6.9 TH=1.8 O-RIN	9	PZ	RC1018A0	ZINC PLATED D12 ELASTIC CLAMP	2	PZ	RC1019A0	D=10 ELASTIC CLAMP	21	PZ	RC1130A0	130X2,6 CLAM	7	PZ	RC1131A0	200X2.6 BLACK CLAMP	3	PZ	RC1242A0	D=10 CLOSED CAP	2	PZ	RC1356A0	"STRAIGHT THREADED FEMALE END 8X1/4" BS	1	PZ	TB2820A0	6X10 EPDM PIPE FOR WASHING SYSTEM	2.400	M	TB3132A0	WHITE-BLUE EPDM TEXTILE BRAID HOSE 6X12	1.220	M	VL1019A0	VIBRATION PUMP	1	PZ	VL1046A1	D6 PIPE HOLDER - D6 J.G. TERMINAL	3	PZ	VL1047A1	D6 PIPE HOLDER - D8 J.G. TERMINAL	1	PZ	VL1065A1	1/4 MALE N.O. PRESSURE SWITCH	1	PZ	VL1067A0	WASHING SYSTEM INLETS DISTRIBUTOR	1	PZ
Code	Description	Qty	UOM																																																																																		
0H2143A0	LAMIERA BLOCCA VNR VL1128	2	PZ																																																																																		
0H2168A0		1	PZ																																																																																		
0H2354A0	XEVC-XEVL WASHING CIRCUIT PLAT	1	PZ																																																																																		
EL1220A0	JG STRAIGHT CONNECTION Ø8F-Ø8F	3	PZ																																																																																		
EL1440A0	WATER SELF CLEANING VALVE	4	PZ																																																																																		
GN1526A0	INT. D.=6.9 TH=1.8 O-RIN	9	PZ																																																																																		
RC1018A0	ZINC PLATED D12 ELASTIC CLAMP	2	PZ																																																																																		
RC1019A0	D=10 ELASTIC CLAMP	21	PZ																																																																																		
RC1130A0	130X2,6 CLAM	7	PZ																																																																																		
RC1131A0	200X2.6 BLACK CLAMP	3	PZ																																																																																		
RC1242A0	D=10 CLOSED CAP	2	PZ																																																																																		
RC1356A0	"STRAIGHT THREADED FEMALE END 8X1/4" BS	1	PZ																																																																																		
TB2820A0	6X10 EPDM PIPE FOR WASHING SYSTEM	2.400	M																																																																																		
TB3132A0	WHITE-BLUE EPDM TEXTILE BRAID HOSE 6X12	1.220	M																																																																																		
VL1019A0	VIBRATION PUMP	1	PZ																																																																																		
VL1046A1	D6 PIPE HOLDER - D6 J.G. TERMINAL	3	PZ																																																																																		
VL1047A1	D6 PIPE HOLDER - D8 J.G. TERMINAL	1	PZ																																																																																		
VL1065A1	1/4 MALE N.O. PRESSURE SWITCH	1	PZ																																																																																		
VL1067A0	WASHING SYSTEM INLETS DISTRIBUTOR	1	PZ																																																																																		

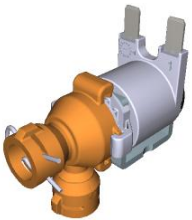

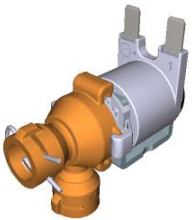
COMPONENT			SPARE PART																																																																																					
Code	Description	Image	Code	Description	Components list																																																																																			
EL1440A	WATER SELF CLEANING VALVE		KVL1184A	2 ROTOR ARMS PLUS EU CLEANING SYSTEM KIT	<table border="1"> <thead> <tr> <th>Code</th> <th>Description</th> <th>Qty</th> <th>UOM</th> </tr> </thead> <tbody> <tr> <td>VL1092A0</td> <td>WASHING SYSTEM OUTLET DOUBLE DISTRIBUTOR</td> <td>1</td> <td>PZ</td> </tr> <tr> <td>VL1102A1</td> <td>DETERGENT LINE FILTER + BARBED VNR 6 MM</td> <td>1</td> <td>PZ</td> </tr> <tr> <td>VL1128A0</td> <td>D6 BARBED CHECK VALVE</td> <td>2</td> <td>PZ</td> </tr> <tr> <td>VL1128A1</td> <td>D6 BARBED CHECK VALVE</td> <td>2</td> <td>PZ</td> </tr> <tr> <td>VL1141A1</td> <td>STRAIGHT CONNECT BB6-BB6</td> <td>1</td> <td>PZ</td> </tr> <tr> <td>VL1165A0</td> <td>BB6-AR6 STRAIGHT FITTING</td> <td>4</td> <td>PZ</td> </tr> <tr> <td>VL1166A0</td> <td>BB6-AR6 L FITTING</td> <td>4</td> <td>PZ</td> </tr> <tr> <td>VL1174C0</td> <td>D1.2 MM CALIBRATED NOZZLE</td> <td>1</td> <td>PZ</td> </tr> <tr> <td>VL1186A0</td> <td>3 WAYS PLUS WASHING DISTRIBUTOR</td> <td>1</td> <td>PZ</td> </tr> <tr> <td>VL1190A0</td> <td>PLUS WASHING SYSTEM INLET DISTRIBUTOR</td> <td>1</td> <td>PZ</td> </tr> <tr> <td>VM1605A0</td> <td>CLIP TWIST LOCK DIAM. 10,2-12,7 MM</td> <td>4</td> <td>PZ</td> </tr> <tr> <td>VM2172A0</td> <td>PUMP-WITH-CI RCUIT LOCKING PIN</td> <td>9</td> <td>PZ</td> </tr> </tbody> </table>	Code	Description	Qty	UOM	VL1092A0	WASHING SYSTEM OUTLET DOUBLE DISTRIBUTOR	1	PZ	VL1102A1	DETERGENT LINE FILTER + BARBED VNR 6 MM	1	PZ	VL1128A0	D6 BARBED CHECK VALVE	2	PZ	VL1128A1	D6 BARBED CHECK VALVE	2	PZ	VL1141A1	STRAIGHT CONNECT BB6-BB6	1	PZ	VL1165A0	BB6-AR6 STRAIGHT FITTING	4	PZ	VL1166A0	BB6-AR6 L FITTING	4	PZ	VL1174C0	D1.2 MM CALIBRATED NOZZLE	1	PZ	VL1186A0	3 WAYS PLUS WASHING DISTRIBUTOR	1	PZ	VL1190A0	PLUS WASHING SYSTEM INLET DISTRIBUTOR	1	PZ	VM1605A0	CLIP TWIST LOCK DIAM. 10,2-12,7 MM	4	PZ	VM2172A0	PUMP-WITH-CI RCUIT LOCKING PIN	9	PZ	KVL1183A	1 ROTOR ARM PLUS CLEANING SYSTEM KIT	<table border="1"> <thead> <tr> <th>Code</th> <th>Description</th> <th>Qty</th> <th>UOM</th> </tr> </thead> <tbody> <tr> <td>0H2143A0</td> <td>LAMIERA BLOCCA VNR VL1128</td> <td>2</td> <td>PZ</td> </tr> <tr> <td>0H2168A1</td> <td></td> <td>1</td> <td>PZ</td> </tr> <tr> <td>0H2354A0</td> <td>XEVC-XEVL WASHING CIRCUIT PLAT</td> <td>1</td> <td>PZ</td> </tr> <tr> <td>EL1440A0</td> <td>WATER SELF CLEANING VALVE</td> <td>3</td> <td>PZ</td> </tr> <tr> <td>GN1526A0</td> <td>INT. D.=6.9 TH=1.8 O-RIN</td> <td>7</td> <td>PZ</td> </tr> <tr> <td>RC1018A0</td> <td>ZINC PLATED D12 ELASTIC CLAMP</td> <td>2</td> <td>PZ</td> </tr> </tbody> </table>	Code	Description	Qty	UOM	0H2143A0	LAMIERA BLOCCA VNR VL1128	2	PZ	0H2168A1		1	PZ	0H2354A0	XEVC-XEVL WASHING CIRCUIT PLAT	1	PZ	EL1440A0	WATER SELF CLEANING VALVE	3	PZ	GN1526A0	INT. D.=6.9 TH=1.8 O-RIN	7	PZ	RC1018A0	ZINC PLATED D12 ELASTIC CLAMP	2	PZ
			Code	Description	Qty	UOM																																																																																		
VL1092A0	WASHING SYSTEM OUTLET DOUBLE DISTRIBUTOR	1	PZ																																																																																					
VL1102A1	DETERGENT LINE FILTER + BARBED VNR 6 MM	1	PZ																																																																																					
VL1128A0	D6 BARBED CHECK VALVE	2	PZ																																																																																					
VL1128A1	D6 BARBED CHECK VALVE	2	PZ																																																																																					
VL1141A1	STRAIGHT CONNECT BB6-BB6	1	PZ																																																																																					
VL1165A0	BB6-AR6 STRAIGHT FITTING	4	PZ																																																																																					
VL1166A0	BB6-AR6 L FITTING	4	PZ																																																																																					
VL1174C0	D1.2 MM CALIBRATED NOZZLE	1	PZ																																																																																					
VL1186A0	3 WAYS PLUS WASHING DISTRIBUTOR	1	PZ																																																																																					
VL1190A0	PLUS WASHING SYSTEM INLET DISTRIBUTOR	1	PZ																																																																																					
VM1605A0	CLIP TWIST LOCK DIAM. 10,2-12,7 MM	4	PZ																																																																																					
VM2172A0	PUMP-WITH-CI RCUIT LOCKING PIN	9	PZ																																																																																					
Code	Description	Qty	UOM																																																																																					
0H2143A0	LAMIERA BLOCCA VNR VL1128	2	PZ																																																																																					
0H2168A1		1	PZ																																																																																					
0H2354A0	XEVC-XEVL WASHING CIRCUIT PLAT	1	PZ																																																																																					
EL1440A0	WATER SELF CLEANING VALVE	3	PZ																																																																																					
GN1526A0	INT. D.=6.9 TH=1.8 O-RIN	7	PZ																																																																																					
RC1018A0	ZINC PLATED D12 ELASTIC CLAMP	2	PZ																																																																																					

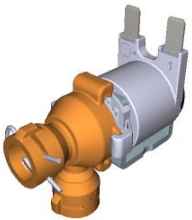
COMPONENT			SPARE PART																																																																																		
Code	Description	Image	Code	Description	Components list																																																																																
EL1440A	WATER SELF CLEANING VALVE		KVL1183A	1 ROTOR ARM PLUS CLEANING SYSTEM KIT	<table border="1"> <thead> <tr> <th>Code</th> <th>Description</th> <th>Qty</th> <th>UOM</th> </tr> </thead> <tbody> <tr> <td>RC1019A0</td> <td>D=10 ELASTIC CLAMP</td> <td>14</td> <td>PZ</td> </tr> <tr> <td>RC1130A0</td> <td>130X2,6 CLAM</td> <td>5</td> <td>PZ</td> </tr> <tr> <td>RC1131A0</td> <td>200X2.6 BLACK CLAMP</td> <td>2</td> <td>PZ</td> </tr> <tr> <td>RC1242A0</td> <td>D=10 CLOSED CAP</td> <td>2</td> <td>PZ</td> </tr> <tr> <td>RC1356A0</td> <td>"STRAIGHT THREADED FEMALE END 8X1/4" BS</td> <td>1</td> <td>PZ</td> </tr> <tr> <td>TB2820A0</td> <td>6X10 EPDM PIPE FOR WASHING SYSTEM</td> <td>1.410</td> <td>M</td> </tr> <tr> <td>TB3132A0</td> <td>WHITE-BLUE EPDM TEXTILE BRAID HOSE 6X12</td> <td>0.770</td> <td>M</td> </tr> <tr> <td>VI1220A1</td> <td>4,2X12 TCB SELF-TAPPIN G SCREW</td> <td>3</td> <td>PZ</td> </tr> <tr> <td>VL1019A0</td> <td>VIBRATION PUMP</td> <td>1</td> <td>PZ</td> </tr> <tr> <td>VL1047A1</td> <td>D6 PIPE HOLDER - D8 J.G. TERMINAL</td> <td>1</td> <td>PZ</td> </tr> <tr> <td>VL1065A1</td> <td>1/4 MALE N.O. PRESSURE SWITCH</td> <td>1</td> <td>PZ</td> </tr> <tr> <td>VL1102A1</td> <td>DETERGENT LINE FILTER + BARBED VNR 6 MM</td> <td>1</td> <td>PZ</td> </tr> <tr> <td>VL1128A0</td> <td>D6 BARBED CHECK VALVE</td> <td>2</td> <td>PZ</td> </tr> <tr> <td>VL1128A1</td> <td>D6 BARBED CHECK VALVE</td> <td>2</td> <td>PZ</td> </tr> <tr> <td>VL1165A0</td> <td>BB6-AR6 STRAIGHT FITTING</td> <td>1</td> <td>PZ</td> </tr> <tr> <td>VL1166A0</td> <td>BB6-AR6 L FITTING</td> <td>3</td> <td>PZ</td> </tr> <tr> <td>VL1174C0</td> <td>D1.2 MM CALIBRATED NOZZLE</td> <td>1</td> <td>PZ</td> </tr> <tr> <td>VL1185A0</td> <td>2 WAYS PLUS WASHING DISTRIBUTOR</td> <td>1</td> <td>PZ</td> </tr> <tr> <td>VL1190A0</td> <td>PLUS WASHING SYSTEM INLET DISTRIBUTOR</td> <td>1</td> <td>PZ</td> </tr> </tbody> </table>	Code	Description	Qty	UOM	RC1019A0	D=10 ELASTIC CLAMP	14	PZ	RC1130A0	130X2,6 CLAM	5	PZ	RC1131A0	200X2.6 BLACK CLAMP	2	PZ	RC1242A0	D=10 CLOSED CAP	2	PZ	RC1356A0	"STRAIGHT THREADED FEMALE END 8X1/4" BS	1	PZ	TB2820A0	6X10 EPDM PIPE FOR WASHING SYSTEM	1.410	M	TB3132A0	WHITE-BLUE EPDM TEXTILE BRAID HOSE 6X12	0.770	M	VI1220A1	4,2X12 TCB SELF-TAPPIN G SCREW	3	PZ	VL1019A0	VIBRATION PUMP	1	PZ	VL1047A1	D6 PIPE HOLDER - D8 J.G. TERMINAL	1	PZ	VL1065A1	1/4 MALE N.O. PRESSURE SWITCH	1	PZ	VL1102A1	DETERGENT LINE FILTER + BARBED VNR 6 MM	1	PZ	VL1128A0	D6 BARBED CHECK VALVE	2	PZ	VL1128A1	D6 BARBED CHECK VALVE	2	PZ	VL1165A0	BB6-AR6 STRAIGHT FITTING	1	PZ	VL1166A0	BB6-AR6 L FITTING	3	PZ	VL1174C0	D1.2 MM CALIBRATED NOZZLE	1	PZ	VL1185A0	2 WAYS PLUS WASHING DISTRIBUTOR	1	PZ	VL1190A0	PLUS WASHING SYSTEM INLET DISTRIBUTOR	1	PZ
Code	Description	Qty	UOM																																																																																		
RC1019A0	D=10 ELASTIC CLAMP	14	PZ																																																																																		
RC1130A0	130X2,6 CLAM	5	PZ																																																																																		
RC1131A0	200X2.6 BLACK CLAMP	2	PZ																																																																																		
RC1242A0	D=10 CLOSED CAP	2	PZ																																																																																		
RC1356A0	"STRAIGHT THREADED FEMALE END 8X1/4" BS	1	PZ																																																																																		
TB2820A0	6X10 EPDM PIPE FOR WASHING SYSTEM	1.410	M																																																																																		
TB3132A0	WHITE-BLUE EPDM TEXTILE BRAID HOSE 6X12	0.770	M																																																																																		
VI1220A1	4,2X12 TCB SELF-TAPPIN G SCREW	3	PZ																																																																																		
VL1019A0	VIBRATION PUMP	1	PZ																																																																																		
VL1047A1	D6 PIPE HOLDER - D8 J.G. TERMINAL	1	PZ																																																																																		
VL1065A1	1/4 MALE N.O. PRESSURE SWITCH	1	PZ																																																																																		
VL1102A1	DETERGENT LINE FILTER + BARBED VNR 6 MM	1	PZ																																																																																		
VL1128A0	D6 BARBED CHECK VALVE	2	PZ																																																																																		
VL1128A1	D6 BARBED CHECK VALVE	2	PZ																																																																																		
VL1165A0	BB6-AR6 STRAIGHT FITTING	1	PZ																																																																																		
VL1166A0	BB6-AR6 L FITTING	3	PZ																																																																																		
VL1174C0	D1.2 MM CALIBRATED NOZZLE	1	PZ																																																																																		
VL1185A0	2 WAYS PLUS WASHING DISTRIBUTOR	1	PZ																																																																																		
VL1190A0	PLUS WASHING SYSTEM INLET DISTRIBUTOR	1	PZ																																																																																		

COMPONENT			SPARE PART																																																																			
Code	Description	Image	Code	Description	Components list																																																																	
EL1440A	WATER SELF CLEANING VALVE		KVL1183A	1 ROTOR ARM PLUS CLEANING SYSTEM KIT	<table border="1"> <thead> <tr> <th>Code</th> <th>Description</th> <th>Qty</th> <th>UOM</th> </tr> </thead> <tbody> <tr> <td>VM1605A0</td> <td>CLIP TWIST LOCK DIAM. 10,2-12,7 MM</td> <td>3</td> <td>PZ</td> </tr> <tr> <td>VM2172A0</td> <td>PUMP-WITH-RCUIT LOCKING PIN</td> <td>7</td> <td>PZ</td> </tr> </tbody> </table>	Code	Description	Qty	UOM	VM1605A0	CLIP TWIST LOCK DIAM. 10,2-12,7 MM	3	PZ	VM2172A0	PUMP-WITH-RCUIT LOCKING PIN	7	PZ																																																					
			Code	Description	Qty	UOM																																																																
VM1605A0	CLIP TWIST LOCK DIAM. 10,2-12,7 MM	3	PZ																																																																			
VM2172A0	PUMP-WITH-RCUIT LOCKING PIN	7	PZ																																																																			
KVL1182A	ONE CLEANING SYSTEM KIT (0311 EXC.)	<table border="1"> <thead> <tr> <th>Code</th> <th>Description</th> <th>Qty</th> <th>UOM</th> </tr> </thead> <tbody> <tr> <td>0H2143A0</td> <td>LAMIERA BLOCCA VNR VL1128</td> <td>2</td> <td>PZ</td> </tr> <tr> <td>0H2202A1</td> <td>ONE WASHING WITH STEAM VALVE SUPPORT</td> <td>1</td> <td>PZ</td> </tr> <tr> <td>EL1440A0</td> <td>WATER SELF CLEANING VALVE</td> <td>1</td> <td>PZ</td> </tr> <tr> <td>GN1526A0</td> <td>INT. D.=6.9 TH=1.8 O-RIN</td> <td>3</td> <td>PZ</td> </tr> <tr> <td>RC1018A0</td> <td>ZINC PLATED D12 ELASTIC CLAMP</td> <td>1</td> <td>PZ</td> </tr> <tr> <td>RC1019A0</td> <td>D=10 ELASTIC CLAMP</td> <td>14</td> <td>PZ</td> </tr> <tr> <td>RC1130A0</td> <td>130X2,6 CLAM</td> <td>2</td> <td>PZ</td> </tr> <tr> <td>RC1242A0</td> <td>D=10 CLOSED CAP</td> <td>2</td> <td>PZ</td> </tr> <tr> <td>TB2820A0</td> <td>6X10 EPDM PIPE FOR WASHING SYSTEM</td> <td>1.410</td> <td>M</td> </tr> <tr> <td>TB3132A0</td> <td>WHITE-BLUE EPDM TEXTILE BRAID HOSE 6X12</td> <td>0.670</td> <td>M</td> </tr> <tr> <td>VI1220A1</td> <td>4,2X12 TCB SELF-TAPPIN G SCREW</td> <td>1</td> <td>PZ</td> </tr> <tr> <td>VL1019A0</td> <td>VIBRATION PUMP</td> <td>1</td> <td>PZ</td> </tr> <tr> <td>VL1047A1</td> <td>D6 PIPE HOLDER - D8 J.G. TERMINAL</td> <td>1</td> <td>PZ</td> </tr> <tr> <td>VL1054B0</td> <td>ONE WASHING SYS INLET DISTRIBUTOR</td> <td>1</td> <td>PZ</td> </tr> <tr> <td>VL1102A1</td> <td>DETERGENT LINE FILTER + BARBED VNR 6 MM</td> <td>1</td> <td>PZ</td> </tr> <tr> <td>VL1128A0</td> <td>D6 BARBED CHECK VALVE</td> <td>2</td> <td>PZ</td> </tr> </tbody> </table>	Code	Description	Qty	UOM	0H2143A0	LAMIERA BLOCCA VNR VL1128	2	PZ	0H2202A1	ONE WASHING WITH STEAM VALVE SUPPORT	1	PZ	EL1440A0	WATER SELF CLEANING VALVE	1	PZ	GN1526A0	INT. D.=6.9 TH=1.8 O-RIN	3	PZ	RC1018A0	ZINC PLATED D12 ELASTIC CLAMP	1	PZ	RC1019A0	D=10 ELASTIC CLAMP	14	PZ	RC1130A0	130X2,6 CLAM	2	PZ	RC1242A0	D=10 CLOSED CAP	2	PZ	TB2820A0	6X10 EPDM PIPE FOR WASHING SYSTEM	1.410	M	TB3132A0	WHITE-BLUE EPDM TEXTILE BRAID HOSE 6X12	0.670	M	VI1220A1	4,2X12 TCB SELF-TAPPIN G SCREW	1	PZ	VL1019A0	VIBRATION PUMP	1	PZ	VL1047A1	D6 PIPE HOLDER - D8 J.G. TERMINAL	1	PZ	VL1054B0	ONE WASHING SYS INLET DISTRIBUTOR	1	PZ	VL1102A1	DETERGENT LINE FILTER + BARBED VNR 6 MM	1	PZ	VL1128A0	D6 BARBED CHECK VALVE	2	PZ
Code	Description	Qty	UOM																																																																			
0H2143A0	LAMIERA BLOCCA VNR VL1128	2	PZ																																																																			
0H2202A1	ONE WASHING WITH STEAM VALVE SUPPORT	1	PZ																																																																			
EL1440A0	WATER SELF CLEANING VALVE	1	PZ																																																																			
GN1526A0	INT. D.=6.9 TH=1.8 O-RIN	3	PZ																																																																			
RC1018A0	ZINC PLATED D12 ELASTIC CLAMP	1	PZ																																																																			
RC1019A0	D=10 ELASTIC CLAMP	14	PZ																																																																			
RC1130A0	130X2,6 CLAM	2	PZ																																																																			
RC1242A0	D=10 CLOSED CAP	2	PZ																																																																			
TB2820A0	6X10 EPDM PIPE FOR WASHING SYSTEM	1.410	M																																																																			
TB3132A0	WHITE-BLUE EPDM TEXTILE BRAID HOSE 6X12	0.670	M																																																																			
VI1220A1	4,2X12 TCB SELF-TAPPIN G SCREW	1	PZ																																																																			
VL1019A0	VIBRATION PUMP	1	PZ																																																																			
VL1047A1	D6 PIPE HOLDER - D8 J.G. TERMINAL	1	PZ																																																																			
VL1054B0	ONE WASHING SYS INLET DISTRIBUTOR	1	PZ																																																																			
VL1102A1	DETERGENT LINE FILTER + BARBED VNR 6 MM	1	PZ																																																																			
VL1128A0	D6 BARBED CHECK VALVE	2	PZ																																																																			

COMPONENT			SPARE PART																																		
Code	Description	Image	Code	Description	Components list																																
EL1440A	WATER SELF CLEANING VALVE		KVL1182A	ONE CLEANING SYSTEM KIT (0311 EXC.)	<table border="1"> <thead> <tr> <th>Code</th> <th>Description</th> <th>Qty</th> <th>UOM</th> </tr> </thead> <tbody> <tr> <td>VL1128A1</td> <td>D6 BARBED CHECK VALVE</td> <td>2</td> <td>PZ</td> </tr> <tr> <td>VL1165A0</td> <td>BB6-AR6 STRAIGHT FITTING</td> <td>1</td> <td>PZ</td> </tr> <tr> <td>VL1166A0</td> <td>BB6-AR6 L FITTING</td> <td>1</td> <td>PZ</td> </tr> <tr> <td>VL1174C0</td> <td>D1.2 MM CALIBRATED NOZZLE</td> <td>1</td> <td>PZ</td> </tr> <tr> <td>VL1191A0</td> <td>ONE WASHING DISTRIBUTOR OUTLETS KIT</td> <td>1</td> <td>PZ</td> </tr> <tr> <td>VM1605A0</td> <td>CLIP TWIST LOCK DIAM. 10,2-12,7 MM</td> <td>3</td> <td>PZ</td> </tr> <tr> <td>VM2172A0</td> <td>PUMP-WITH-CL RCUIT LOCKING PIN</td> <td>2</td> <td>PZ</td> </tr> </tbody> </table>	Code	Description	Qty	UOM	VL1128A1	D6 BARBED CHECK VALVE	2	PZ	VL1165A0	BB6-AR6 STRAIGHT FITTING	1	PZ	VL1166A0	BB6-AR6 L FITTING	1	PZ	VL1174C0	D1.2 MM CALIBRATED NOZZLE	1	PZ	VL1191A0	ONE WASHING DISTRIBUTOR OUTLETS KIT	1	PZ	VM1605A0	CLIP TWIST LOCK DIAM. 10,2-12,7 MM	3	PZ	VM2172A0	PUMP-WITH-CL RCUIT LOCKING PIN	2	PZ
			Code	Description	Qty	UOM																															
VL1128A1	D6 BARBED CHECK VALVE	2	PZ																																		
VL1165A0	BB6-AR6 STRAIGHT FITTING	1	PZ																																		
VL1166A0	BB6-AR6 L FITTING	1	PZ																																		
VL1174C0	D1.2 MM CALIBRATED NOZZLE	1	PZ																																		
VL1191A0	ONE WASHING DISTRIBUTOR OUTLETS KIT	1	PZ																																		
VM1605A0	CLIP TWIST LOCK DIAM. 10,2-12,7 MM	3	PZ																																		
VM2172A0	PUMP-WITH-CL RCUIT LOCKING PIN	2	PZ																																		
KEL1440A	SELF CLEANING WATER VALVE KIT	<table border="1"> <thead> <tr> <th>Code</th> <th>Description</th> <th>Qty</th> <th>UOM</th> </tr> </thead> <tbody> <tr> <td>EL1440A0</td> <td>WATER SELF CLEANING VALVE</td> <td>1</td> <td>PZ</td> </tr> <tr> <td>GN1526A0</td> <td>INT. D.=6.9 TH=1.8 O-RIN</td> <td>2</td> <td>PZ</td> </tr> <tr> <td>RC1131A0</td> <td>200X2.6 BLACK CLAMP</td> <td>1</td> <td>PZ</td> </tr> <tr> <td>VM1224A0</td> <td>65MY 220MM 2 COLOURS SHRINK TUBE</td> <td>0.250</td> <td>M</td> </tr> </tbody> </table>	Code	Description	Qty	UOM	EL1440A0	WATER SELF CLEANING VALVE	1	PZ	GN1526A0	INT. D.=6.9 TH=1.8 O-RIN	2	PZ	RC1131A0	200X2.6 BLACK CLAMP	1	PZ	VM1224A0	65MY 220MM 2 COLOURS SHRINK TUBE	0.250	M															
Code	Description	Qty	UOM																																		
EL1440A0	WATER SELF CLEANING VALVE	1	PZ																																		
GN1526A0	INT. D.=6.9 TH=1.8 O-RIN	2	PZ																																		
RC1131A0	200X2.6 BLACK CLAMP	1	PZ																																		
VM1224A0	65MY 220MM 2 COLOURS SHRINK TUBE	0.250	M																																		
TR1162A			KTR1136A	330 °C SAFETY THERMOSTAT KIT	<table border="1"> <thead> <tr> <th>Code</th> <th>Description</th> <th>Qty</th> <th>UOM</th> </tr> </thead> <tbody> <tr> <td>0H7030A0</td> <td>THERMOSTAT BULB INLET COVER</td> <td>1</td> <td>PZ</td> </tr> <tr> <td>GN1531A0</td> <td>THERMOSTAT BULB INLET SEALING</td> <td>1</td> <td>PZ</td> </tr> <tr> <td>MOV0011A0</td> <td>HOOD RING GASKET GN1110A2</td> <td>0.100</td> <td>PZ</td> </tr> <tr> <td>SL1045A0</td> <td>S57 BLACK SILICONE - 80ML CARTRIDGE</td> <td>1</td> <td>PZ</td> </tr> <tr> <td>TR1136A0</td> <td>330 °C 1 POLE SAFETY THERMOSTAT</td> <td>1</td> <td>PZ</td> </tr> <tr> <td>VH1220A1</td> <td>4,2X12 TCB SELF-TAPPIN G SCREW</td> <td>3</td> <td>PZ</td> </tr> </tbody> </table>	Code	Description	Qty	UOM	0H7030A0	THERMOSTAT BULB INLET COVER	1	PZ	GN1531A0	THERMOSTAT BULB INLET SEALING	1	PZ	MOV0011A0	HOOD RING GASKET GN1110A2	0.100	PZ	SL1045A0	S57 BLACK SILICONE - 80ML CARTRIDGE	1	PZ	TR1136A0	330 °C 1 POLE SAFETY THERMOSTAT	1	PZ	VH1220A1	4,2X12 TCB SELF-TAPPIN G SCREW	3	PZ				
			Code	Description	Qty	UOM																															
			0H7030A0	THERMOSTAT BULB INLET COVER	1	PZ																															
			GN1531A0	THERMOSTAT BULB INLET SEALING	1	PZ																															
			MOV0011A0	HOOD RING GASKET GN1110A2	0.100	PZ																															
			SL1045A0	S57 BLACK SILICONE - 80ML CARTRIDGE	1	PZ																															
			TR1136A0	330 °C 1 POLE SAFETY THERMOSTAT	1	PZ																															
VH1220A1	4,2X12 TCB SELF-TAPPIN G SCREW	3	PZ																																		



COMPONENT			SPARE PART		
<i>Code</i>	<i>Description</i>	<i>Image</i>	<i>Code</i>	<i>Description</i>	<i>Components list</i>
0D2309A	XEBC-06EU-E EXTERNAL RIGHT SIDE		0D2309A3	XEBC-06EU-E EXTERNAL RIGHT SIDE	
0F1504A	XEBC-06EU-E BACK PANEL		0F1504A0	XEBC-06EU-E BACK PANEL	

**ASM1745B/0.D05 - Cooking chamber**

**FRONT**

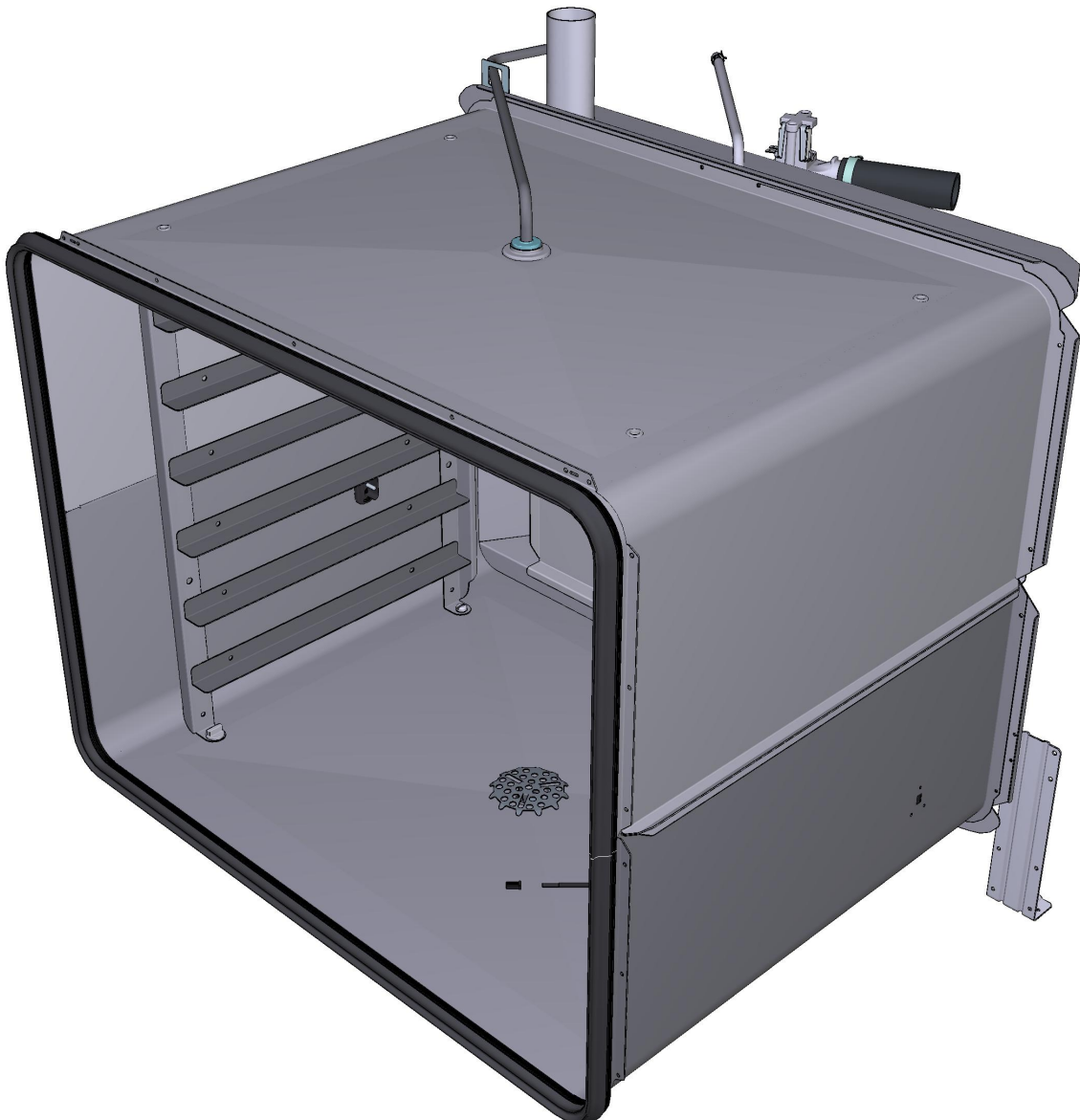



**ASM1745B/0.D05 - Cooking chamber**

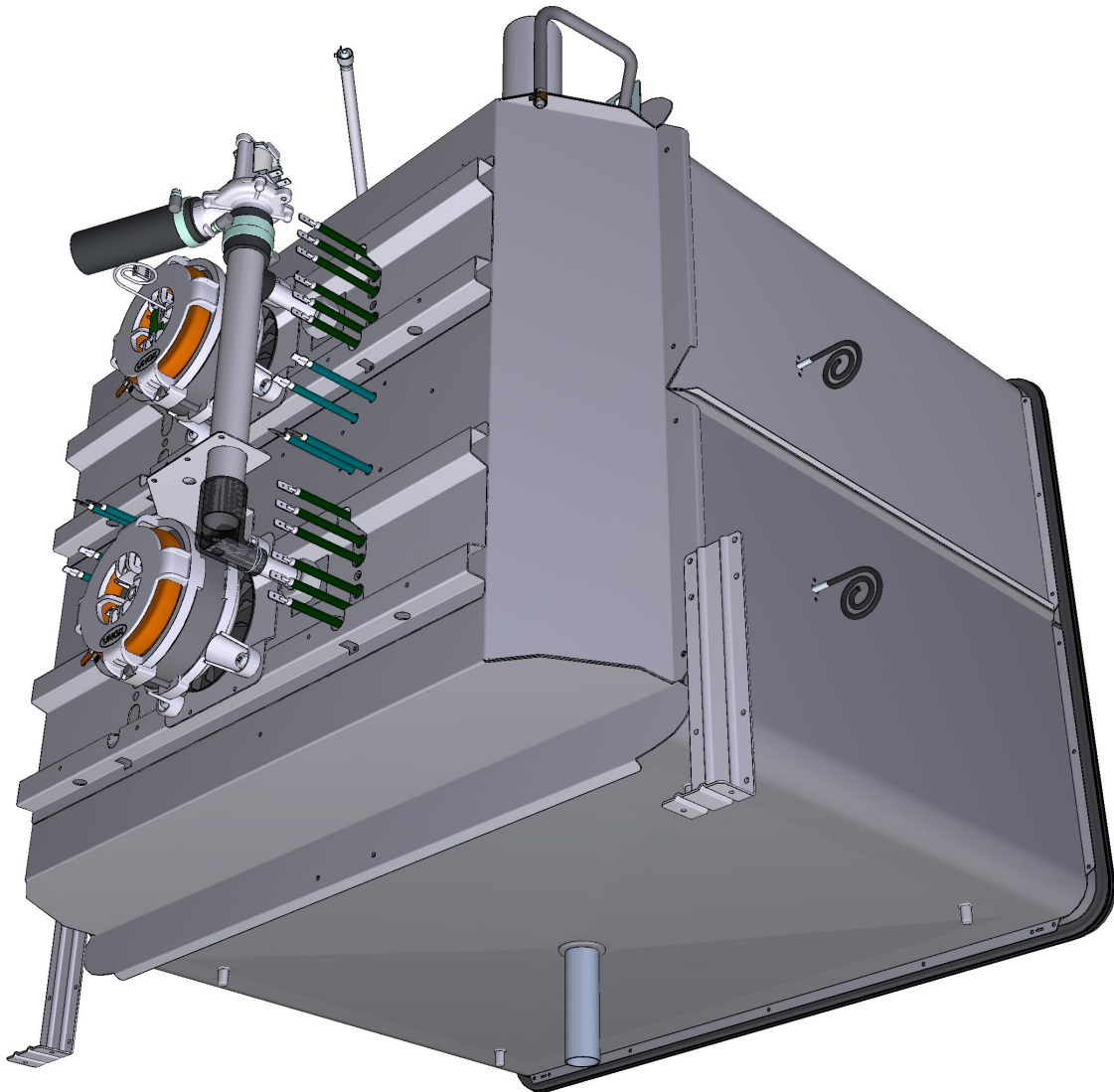

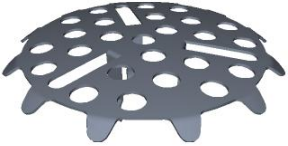

**REAR**





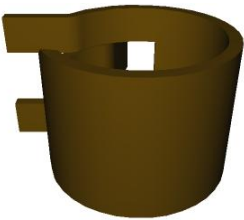



COMPONENT			SPARE PART																																																		
Code	Description	Image	Code	Description	Components list																																																
VL1037A	WASHING SYSTEM ROTOR		KVL1037A	WASHING SYSTEM ROTOR KIT	<table border="1"> <thead> <tr> <th>Code</th> <th>Description</th> <th>Qty</th> <th>UOM</th> </tr> </thead> <tbody> <tr> <td>GN1416B0</td> <td>WASHING SYSTEM ROTOR BEARING</td> <td>1</td> <td>PZ</td> </tr> <tr> <td>MOV0015A0</td> <td>HOOD RING GASKET GN1110A2</td> <td>0.100</td> <td>PZ</td> </tr> <tr> <td>TF1065B0</td> <td>WASHING SYSTEM ROTOR PIVOT</td> <td>1</td> <td>PZ</td> </tr> <tr> <td>TF1066A1</td> <td>WASHING SYSTEM ROTOR BUSH</td> <td>1</td> <td>PZ</td> </tr> <tr> <td>UG1005B1</td> <td>LONG RAY ROTOR WATER NOZZL</td> <td>1</td> <td>PZ</td> </tr> <tr> <td>UG1006B3</td> <td>LONG RAY ROTOR WATER NOZZL</td> <td>1</td> <td>PZ</td> </tr> <tr> <td>VI1220A1</td> <td>4,2X12 TCB SELF-TAPPIN G SCREW</td> <td>8</td> <td>PZ</td> </tr> <tr> <td>VM1224A0</td> <td>65MY 220MM 2 COLOURS SHRINK TUBE</td> <td>0.250</td> <td>M</td> </tr> <tr> <td>VM1955C0</td> <td>WASHING SYSTEM ROTOR</td> <td>1</td> <td>PZ</td> </tr> <tr> <td>VM1985C1</td> <td>WASHING SYSTEM ROTOR COVE</td> <td>1</td> <td>PZ</td> </tr> <tr> <td>VM1986A0</td> <td>NOZZLE COVE</td> <td>2</td> <td>PZ</td> </tr> </tbody> </table>	Code	Description	Qty	UOM	GN1416B0	WASHING SYSTEM ROTOR BEARING	1	PZ	MOV0015A0	HOOD RING GASKET GN1110A2	0.100	PZ	TF1065B0	WASHING SYSTEM ROTOR PIVOT	1	PZ	TF1066A1	WASHING SYSTEM ROTOR BUSH	1	PZ	UG1005B1	LONG RAY ROTOR WATER NOZZL	1	PZ	UG1006B3	LONG RAY ROTOR WATER NOZZL	1	PZ	VI1220A1	4,2X12 TCB SELF-TAPPIN G SCREW	8	PZ	VM1224A0	65MY 220MM 2 COLOURS SHRINK TUBE	0.250	M	VM1955C0	WASHING SYSTEM ROTOR	1	PZ	VM1985C1	WASHING SYSTEM ROTOR COVE	1	PZ	VM1986A0	NOZZLE COVE	2	PZ
					Code	Description	Qty	UOM																																													
					GN1416B0	WASHING SYSTEM ROTOR BEARING	1	PZ																																													
					MOV0015A0	HOOD RING GASKET GN1110A2	0.100	PZ																																													
					TF1065B0	WASHING SYSTEM ROTOR PIVOT	1	PZ																																													
					TF1066A1	WASHING SYSTEM ROTOR BUSH	1	PZ																																													
					UG1005B1	LONG RAY ROTOR WATER NOZZL	1	PZ																																													
					UG1006B3	LONG RAY ROTOR WATER NOZZL	1	PZ																																													
					VI1220A1	4,2X12 TCB SELF-TAPPIN G SCREW	8	PZ																																													
					VM1224A0	65MY 220MM 2 COLOURS SHRINK TUBE	0.250	M																																													
					VM1955C0	WASHING SYSTEM ROTOR	1	PZ																																													
					VM1985C1	WASHING SYSTEM ROTOR COVE	1	PZ																																													
VM1986A0	NOZZLE COVE	2	PZ																																																		
0H2551A	XBC/XVC ST.STEEL DRAIN COVER		K0H2551A	DRAIN COVER KIT	<table border="1"> <thead> <tr> <th>Code</th> <th>Description</th> <th>Qty</th> <th>UOM</th> </tr> </thead> <tbody> <tr> <td>0H2551A0</td> <td>XBC/XVC ST.STEEL DRAIN COVER</td> <td>1</td> <td>PZ</td> </tr> <tr> <td>VM1224A0</td> <td>65MY 220MM 2 COLOURS SHRINK TUBE</td> <td>0.200</td> <td>M</td> </tr> </tbody> </table>	Code	Description	Qty	UOM	0H2551A0	XBC/XVC ST.STEEL DRAIN COVER	1	PZ	VM1224A0	65MY 220MM 2 COLOURS SHRINK TUBE	0.200	M																																				
					Code	Description	Qty	UOM																																													
0H2551A0	XBC/XVC ST.STEEL DRAIN COVER	1	PZ																																																		
VM1224A0	65MY 220MM 2 COLOURS SHRINK TUBE	0.200	M																																																		
VM1820A	LATERAL SUPPORTS M6 FIXING BOLT		KVM1820A	THUMB SCREW 10PCS KIT	<table border="1"> <thead> <tr> <th>Code</th> <th>Description</th> <th>Qty</th> <th>UOM</th> </tr> </thead> <tbody> <tr> <td>VM1224A0</td> <td>65MY 220MM 2 COLOURS SHRINK TUBE</td> <td>0.200</td> <td>M</td> </tr> <tr> <td>VM1820A0</td> <td>LATERAL SUPPORTS M6 FIXING BOLT</td> <td>10</td> <td>PZ</td> </tr> </tbody> </table>	Code	Description	Qty	UOM	VM1224A0	65MY 220MM 2 COLOURS SHRINK TUBE	0.200	M	VM1820A0	LATERAL SUPPORTS M6 FIXING BOLT	10	PZ																																				
Code	Description	Qty	UOM																																																		
VM1224A0	65MY 220MM 2 COLOURS SHRINK TUBE	0.200	M																																																		
VM1820A0	LATERAL SUPPORTS M6 FIXING BOLT	10	PZ																																																		



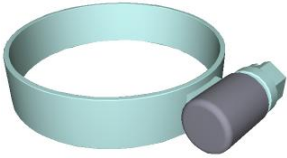

COMPONENT			SPARE PART																						
Code	Description	Image	Code	Description	Components list																				
RC1019A	D=10 ELASTIC CLAM		KRC1019A	Ø10 ZINC PLATED ELASTIC CLAMP 15 PCS KIT	<table border="1"> <thead> <tr> <th>Code</th> <th>Description</th> <th>Qty</th> <th>UOM</th> </tr> </thead> <tbody> <tr> <td>RC1019A0</td> <td>D=10 ELASTIC CLAMP</td> <td>17</td> <td>PZ</td> </tr> <tr> <td>VM1224A0</td> <td>65MY 220MM 2 COLOURS SHRINK TUBE</td> <td>0.200</td> <td>M</td> </tr> </tbody> </table>	Code	Description	Qty	UOM	RC1019A0	D=10 ELASTIC CLAMP	17	PZ	VM1224A0	65MY 220MM 2 COLOURS SHRINK TUBE	0.200	M								
Code	Description	Qty	UOM																						
RC1019A0	D=10 ELASTIC CLAMP	17	PZ																						
VM1224A0	65MY 220MM 2 COLOURS SHRINK TUBE	0.200	M																						
VM2331A	FAN GUARD-TRAYS HOLDER PIN		KVM2331A	KIT FAN GUARD-TRAYS HOLDER PIN	<table border="1"> <thead> <tr> <th>Code</th> <th>Description</th> <th>Qty</th> <th>UOM</th> </tr> </thead> <tbody> <tr> <td>VM1224A0</td> <td>65MY 220MM 2 COLOURS SHRINK TUBE</td> <td>0.200</td> <td>M</td> </tr> <tr> <td>VM2331A0</td> <td>FAN GUARD-TRAY S HOLDER PIN</td> <td>4</td> <td>PZ</td> </tr> </tbody> </table>	Code	Description	Qty	UOM	VM1224A0	65MY 220MM 2 COLOURS SHRINK TUBE	0.200	M	VM2331A0	FAN GUARD-TRAY S HOLDER PIN	4	PZ								
Code	Description	Qty	UOM																						
VM1224A0	65MY 220MM 2 COLOURS SHRINK TUBE	0.200	M																						
VM2331A0	FAN GUARD-TRAY S HOLDER PIN	4	PZ																						
TB2902A	CHAMBER CHIMNEY PIPE D50		TB2902A0	CHAMBER CHIMNEY PIPE D50																					
0H2730A	ZINC PLATED MUFFLE SUPPORT BRACKET		0H2730A1	ZINC PLATED MUFFLE SUPPORT BRACKET																					
GRL1405A	6X600X400 LEFT LATERAL SUPPORT		KGRL1405A	MIND.MAPS 6 600X400 LATERAL SUPPORTS KIT	<table border="1"> <thead> <tr> <th>Code</th> <th>Description</th> <th>Qty</th> <th>UOM</th> </tr> </thead> <tbody> <tr> <td>0H4215A0</td> <td>TRAYS GUIDE PROFILE L372.5 BT</td> <td>12</td> <td>PZ</td> </tr> <tr> <td>0H4420A0</td> <td>STAINLESS STEEL CORE TEMPERATUR</td> <td>1</td> <td>PZ</td> </tr> <tr> <td>0H7302A0</td> <td>0H7312+0H731 3 FLAT SUPPORTING PROFILE</td> <td>2</td> <td>PZ</td> </tr> <tr> <td>0H7303A0</td> <td>0H7314+0H731 5 FLAT SUPPORTING PROFILE</td> <td>2</td> <td>PZ</td> </tr> </tbody> </table>	Code	Description	Qty	UOM	0H4215A0	TRAYS GUIDE PROFILE L372.5 BT	12	PZ	0H4420A0	STAINLESS STEEL CORE TEMPERATUR	1	PZ	0H7302A0	0H7312+0H731 3 FLAT SUPPORTING PROFILE	2	PZ	0H7303A0	0H7314+0H731 5 FLAT SUPPORTING PROFILE	2	PZ
Code	Description	Qty	UOM																						
0H4215A0	TRAYS GUIDE PROFILE L372.5 BT	12	PZ																						
0H4420A0	STAINLESS STEEL CORE TEMPERATUR	1	PZ																						
0H7302A0	0H7312+0H731 3 FLAT SUPPORTING PROFILE	2	PZ																						
0H7303A0	0H7314+0H731 5 FLAT SUPPORTING PROFILE	2	PZ																						

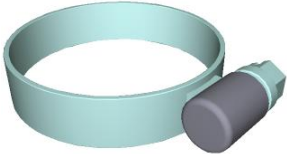
COMPONENT			SPARE PART																																						
Code	Description	Image	Code	Description	Components list																																				
GRL1405A	6X600X400 LEFT LATERAL SUPPORT		KGRL1405A	MIND.MAPS 6 600X400 LATERAL SUPPORTS KIT	<table border="1"> <thead> <tr> <th>Code</th> <th>Description</th> <th>Qty</th> <th>UOM</th> </tr> </thead> <tbody> <tr> <td>IP1508A1</td> <td>POLYSTYREN E U SHAPED PROFILE 2000X60X60</td> <td>1.200</td> <td>M</td> </tr> <tr> <td>VM1059A1</td> <td>HEAT SHRINK FILM H800</td> <td>1.500</td> <td>M</td> </tr> </tbody> </table>	Code	Description	Qty	UOM	IP1508A1	POLYSTYREN E U SHAPED PROFILE 2000X60X60	1.200	M	VM1059A1	HEAT SHRINK FILM H800	1.500	M																								
Code	Description	Qty	UOM																																						
IP1508A1	POLYSTYREN E U SHAPED PROFILE 2000X60X60	1.200	M																																						
VM1059A1	HEAT SHRINK FILM H800	1.500	M																																						
GRL1406A	6X600X400 RIGHT LATERAL SUPPORT		KGRL1405A	MIND.MAPS 6 600X400 LATERAL SUPPORTS KIT	<table border="1"> <thead> <tr> <th>Code</th> <th>Description</th> <th>Qty</th> <th>UOM</th> </tr> </thead> <tbody> <tr> <td>0H4215A0</td> <td>TRAYS GUIDE PROFILE L372.5 BT</td> <td>12</td> <td>PZ</td> </tr> <tr> <td>0H4420A0</td> <td>STAINLESS STEEL CORE TEMPERATUR</td> <td>1</td> <td>PZ</td> </tr> <tr> <td>0H7302A0</td> <td>0H7312+0H731 3 FLAT SUPPORTING PROFILE</td> <td>2</td> <td>PZ</td> </tr> <tr> <td>0H7303A0</td> <td>0H7314+0H731 5 FLAT SUPPORTING PROFILE</td> <td>2</td> <td>PZ</td> </tr> <tr> <td>IP1508A1</td> <td>POLYSTYREN E U SHAPED PROFILE 2000X60X60</td> <td>1.200</td> <td>M</td> </tr> <tr> <td>VM1059A1</td> <td>HEAT SHRINK FILM H800</td> <td>1.500</td> <td>M</td> </tr> </tbody> </table>	Code	Description	Qty	UOM	0H4215A0	TRAYS GUIDE PROFILE L372.5 BT	12	PZ	0H4420A0	STAINLESS STEEL CORE TEMPERATUR	1	PZ	0H7302A0	0H7312+0H731 3 FLAT SUPPORTING PROFILE	2	PZ	0H7303A0	0H7314+0H731 5 FLAT SUPPORTING PROFILE	2	PZ	IP1508A1	POLYSTYREN E U SHAPED PROFILE 2000X60X60	1.200	M	VM1059A1	HEAT SHRINK FILM H800	1.500	M								
Code	Description	Qty	UOM																																						
0H4215A0	TRAYS GUIDE PROFILE L372.5 BT	12	PZ																																						
0H4420A0	STAINLESS STEEL CORE TEMPERATUR	1	PZ																																						
0H7302A0	0H7312+0H731 3 FLAT SUPPORTING PROFILE	2	PZ																																						
0H7303A0	0H7314+0H731 5 FLAT SUPPORTING PROFILE	2	PZ																																						
IP1508A1	POLYSTYREN E U SHAPED PROFILE 2000X60X60	1.200	M																																						
VM1059A1	HEAT SHRINK FILM H800	1.500	M																																						
RC1378A	HOSE CLAMP		KVE1135A	SERIES 5/5E VENTURI KIT	<table border="1"> <thead> <tr> <th>Code</th> <th>Description</th> <th>Qty</th> <th>UOM</th> </tr> </thead> <tbody> <tr> <td>GN1556A0</td> <td>MM VENTURI SEAL</td> <td>1</td> <td>PZ</td> </tr> <tr> <td>RC1378A0</td> <td>HOSE CLAMP</td> <td>2</td> <td>PZ</td> </tr> <tr> <td>TB1520A0</td> <td>INT. Ø=38 TH=4 DRAIN BLACK RUBBER PIPE</td> <td>0.050</td> <td>M</td> </tr> <tr> <td>VE1135A0</td> <td>220 V 50/60 HZ VENTURI ACTUATOR</td> <td>1</td> <td>PZ</td> </tr> <tr> <td>VI1032A0</td> <td>SCREW M4X16 TCB+ INOX</td> <td>1</td> <td>PZ</td> </tr> <tr> <td>VI1511A0</td> <td>STAINLESS STEEL WASHER 4.2X12X1</td> <td>2</td> <td>PZ</td> </tr> <tr> <td>VI1850A0</td> <td>M4X6 NICKEL PLATED FIXING SCRE</td> <td>2</td> <td>PZ</td> </tr> <tr> <td>VI1865A0</td> <td>5X10 TCB+ SELF-THREADI NG SCREW</td> <td>3</td> <td>PZ</td> </tr> </tbody> </table>	Code	Description	Qty	UOM	GN1556A0	MM VENTURI SEAL	1	PZ	RC1378A0	HOSE CLAMP	2	PZ	TB1520A0	INT. Ø=38 TH=4 DRAIN BLACK RUBBER PIPE	0.050	M	VE1135A0	220 V 50/60 HZ VENTURI ACTUATOR	1	PZ	VI1032A0	SCREW M4X16 TCB+ INOX	1	PZ	VI1511A0	STAINLESS STEEL WASHER 4.2X12X1	2	PZ	VI1850A0	M4X6 NICKEL PLATED FIXING SCRE	2	PZ	VI1865A0	5X10 TCB+ SELF-THREADI NG SCREW	3	PZ
Code	Description	Qty	UOM																																						
GN1556A0	MM VENTURI SEAL	1	PZ																																						
RC1378A0	HOSE CLAMP	2	PZ																																						
TB1520A0	INT. Ø=38 TH=4 DRAIN BLACK RUBBER PIPE	0.050	M																																						
VE1135A0	220 V 50/60 HZ VENTURI ACTUATOR	1	PZ																																						
VI1032A0	SCREW M4X16 TCB+ INOX	1	PZ																																						
VI1511A0	STAINLESS STEEL WASHER 4.2X12X1	2	PZ																																						
VI1850A0	M4X6 NICKEL PLATED FIXING SCRE	2	PZ																																						
VI1865A0	5X10 TCB+ SELF-THREADI NG SCREW	3	PZ																																						





COMPONENT			SPARE PART																														
Code	Description	Image	Code	Description	Components list																												
RC1378A	HOSE CLAMP		KVE1135A	SERIES 5/5E VENTURI KIT	<table border="1"> <thead> <tr> <th>Code</th> <th>Description</th> <th>Qty</th> <th>UOM</th> </tr> </thead> <tbody> <tr> <td>VI1965A0</td> <td>M4X6 CROSS-HEAD ST. STEEL SCREW</td> <td>2</td> <td>PZ</td> </tr> <tr> <td>VM1224A0</td> <td>65MY 220MM 2 0.250 COLOURS SHRINK TUBE</td> <td>M</td> <td></td> </tr> <tr> <td>VM1565B0</td> <td>VENTURI LOWER COIL SUPPORT</td> <td>1</td> <td>PZ</td> </tr> <tr> <td>VM1566A0</td> <td>VENTURI UPPER COIL SUPPORT</td> <td>1</td> <td>PZ</td> </tr> <tr> <td>VM1567A0</td> <td>VENTURI LOWER BUSHING</td> <td>1</td> <td>PZ</td> </tr> <tr> <td>VM1568A0</td> <td>VENTURI PLATE SPACE</td> <td>1</td> <td>PZ</td> </tr> </tbody> </table>	Code	Description	Qty	UOM	VI1965A0	M4X6 CROSS-HEAD ST. STEEL SCREW	2	PZ	VM1224A0	65MY 220MM 2 0.250 COLOURS SHRINK TUBE	M		VM1565B0	VENTURI LOWER COIL SUPPORT	1	PZ	VM1566A0	VENTURI UPPER COIL SUPPORT	1	PZ	VM1567A0	VENTURI LOWER BUSHING	1	PZ	VM1568A0	VENTURI PLATE SPACE	1	PZ
					Code	Description	Qty	UOM																									
					VI1965A0	M4X6 CROSS-HEAD ST. STEEL SCREW	2	PZ																									
					VM1224A0	65MY 220MM 2 0.250 COLOURS SHRINK TUBE	M																										
					VM1565B0	VENTURI LOWER COIL SUPPORT	1	PZ																									
					VM1566A0	VENTURI UPPER COIL SUPPORT	1	PZ																									
					VM1567A0	VENTURI LOWER BUSHING	1	PZ																									
VM1568A0	VENTURI PLATE SPACE	1	PZ																														
GN1544A	AIR INLET GASKET		KTB3128A	XECC-1013-E VENTURI COLLECTOR PIPE KI	<table border="1"> <thead> <tr> <th>Code</th> <th>Description</th> <th>Qty</th> <th>UOM</th> </tr> </thead> <tbody> <tr> <td>GN1544A0</td> <td>AIR INLET GASKET</td> <td>1</td> <td>PZ</td> </tr> <tr> <td>GN1584A0</td> <td>CORNER FITTING D30-D16</td> <td>1</td> <td>PZ</td> </tr> <tr> <td>TB3128A0</td> <td>XECC-10 VENTURI AIR EXIT PIPE</td> <td>1</td> <td>PZ</td> </tr> </tbody> </table>	Code	Description	Qty	UOM	GN1544A0	AIR INLET GASKET	1	PZ	GN1584A0	CORNER FITTING D30-D16	1	PZ	TB3128A0	XECC-10 VENTURI AIR EXIT PIPE	1	PZ												
					Code	Description	Qty	UOM																									
					GN1544A0	AIR INLET GASKET	1	PZ																									
			GN1584A0	CORNER FITTING D30-D16	1	PZ																											
			TB3128A0	XECC-10 VENTURI AIR EXIT PIPE	1	PZ																											
			KTB3074B	XEVC-0711-G VENTURI COLLECTOR PIPE KI	<table border="1"> <thead> <tr> <th>Code</th> <th>Description</th> <th>Qty</th> <th>UOM</th> </tr> </thead> <tbody> <tr> <td>GN1544A0</td> <td>AIR INLET GASKET</td> <td>1</td> <td>PZ</td> </tr> <tr> <td>GN1584A0</td> <td>CORNER FITTING D30-D16</td> <td>1</td> <td>PZ</td> </tr> <tr> <td>RC1042A0</td> <td>DOUBLE WIRE SPRING CLAMP D21.5-22.6</td> <td>1</td> <td>PZ</td> </tr> <tr> <td>TB3074B0</td> <td>XEVC-07EU-G VENTURI COLLECTOR PIPE D30</td> <td>1</td> <td>PZ</td> </tr> <tr> <td>VM1794A0</td> <td>250X4.8 PA66 BLACK CLAMP</td> <td>1</td> <td>PZ</td> </tr> </tbody> </table>	Code	Description	Qty	UOM	GN1544A0	AIR INLET GASKET	1	PZ	GN1584A0	CORNER FITTING D30-D16	1	PZ	RC1042A0	DOUBLE WIRE SPRING CLAMP D21.5-22.6	1	PZ	TB3074B0	XEVC-07EU-G VENTURI COLLECTOR PIPE D30	1	PZ	VM1794A0	250X4.8 PA66 BLACK CLAMP	1	PZ				
					Code	Description	Qty	UOM																									
					GN1544A0	AIR INLET GASKET	1	PZ																									
					GN1584A0	CORNER FITTING D30-D16	1	PZ																									
					RC1042A0	DOUBLE WIRE SPRING CLAMP D21.5-22.6	1	PZ																									
TB3074B0	XEVC-07EU-G VENTURI COLLECTOR PIPE D30	1			PZ																												
VM1794A0	250X4.8 PA66 BLACK CLAMP	1			PZ																												
KTB3068B	10FS/EU/2-G VENTURI COLLECTOR PIPE KI	<table border="1"> <thead> <tr> <th>Code</th> <th>Description</th> <th>Qty</th> <th>UOM</th> </tr> </thead> <tbody> <tr> <td>GN1544A0</td> <td>AIR INLET GASKET</td> <td>2</td> <td>PZ</td> </tr> <tr> <td>GN1584A0</td> <td>CORNER FITTING D30-D16</td> <td>1</td> <td>PZ</td> </tr> </tbody> </table>	Code	Description	Qty	UOM	GN1544A0	AIR INLET GASKET	2	PZ	GN1584A0	CORNER FITTING D30-D16	1	PZ																			
		Code	Description	Qty	UOM																												
GN1544A0	AIR INLET GASKET	2	PZ																														
GN1584A0	CORNER FITTING D30-D16	1	PZ																														

COMPONENT			SPARE PART										
Code	Description	Image	Code	Description	Components list								
GN1544A	AIR INLET GASKET		KTB3068B	10FS/EU/2-G VENTURI COLLECTOR PIPE KI	<table border="1"> <thead> <tr> <th>Code</th> <th>Description</th> <th>Qty</th> <th>UOM</th> </tr> </thead> <tbody> <tr> <td>RC1042A0</td> <td>DOUBLE WIRE SPRING CLAMP D21.5-22.6</td> <td>1</td> <td>PZ</td> </tr> </tbody> </table>	Code	Description	Qty	UOM	RC1042A0	DOUBLE WIRE SPRING CLAMP D21.5-22.6	1	PZ
					Code	Description	Qty	UOM					
					RC1042A0	DOUBLE WIRE SPRING CLAMP D21.5-22.6	1	PZ					
			<table border="1"> <tbody> <tr> <td>TB3068B0</td> <td>XEBC-10 VENTURI AIR COLLECTOR PIPE D30</td> <td>1</td> <td>PZ</td> </tr> </tbody> </table>	TB3068B0	XEBC-10 VENTURI AIR COLLECTOR PIPE D30	1	PZ						
			TB3068B0	XEBC-10 VENTURI AIR COLLECTOR PIPE D30	1	PZ							
			<table border="1"> <tbody> <tr> <td>VM1794A0</td> <td>250X4.8 PA66 BLACK CLAMP</td> <td>1</td> <td>PZ</td> </tr> </tbody> </table>	VM1794A0	250X4.8 PA66 BLACK CLAMP	1	PZ						
			VM1794A0	250X4.8 PA66 BLACK CLAMP	1	PZ							
			KTB3019A	20XX/16XX UPPER VENTURI COLLECT PIPE KIT	<table border="1"> <thead> <tr> <th>Code</th> <th>Description</th> <th>Qty</th> <th>UOM</th> </tr> </thead> <tbody> <tr> <td>GN1544A0</td> <td>AIR INLET GASKET</td> <td>1</td> <td>PZ</td> </tr> </tbody> </table>	Code	Description	Qty	UOM	GN1544A0	AIR INLET GASKET	1	PZ
					Code	Description	Qty	UOM					
					GN1544A0	AIR INLET GASKET	1	PZ					
					<table border="1"> <tbody> <tr> <td>GN1584A0</td> <td>CORNER FITTING D30-D16</td> <td>1</td> <td>PZ</td> </tr> </tbody> </table>	GN1584A0	CORNER FITTING D30-D16	1	PZ				
					GN1584A0	CORNER FITTING D30-D16	1	PZ					
<table border="1"> <tbody> <tr> <td>RC1042A0</td> <td>DOUBLE WIRE SPRING CLAMP D21.5-22.6</td> <td>1</td> <td>PZ</td> </tr> </tbody> </table>	RC1042A0	DOUBLE WIRE SPRING CLAMP D21.5-22.6			1	PZ							
RC1042A0	DOUBLE WIRE SPRING CLAMP D21.5-22.6	1	PZ										
<table border="1"> <tbody> <tr> <td>TB3019A1</td> <td>XEVC-2011 UPPER AIR INLET PIPE D3</td> <td>1</td> <td>PZ</td> </tr> </tbody> </table>	TB3019A1	XEVC-2011 UPPER AIR INLET PIPE D3	1	PZ									
TB3019A1	XEVC-2011 UPPER AIR INLET PIPE D3	1	PZ										
<table border="1"> <tbody> <tr> <td>VM1794A0</td> <td>250X4.8 PA66 BLACK CLAMP</td> <td>1</td> <td>PZ</td> </tr> </tbody> </table>	VM1794A0	250X4.8 PA66 BLACK CLAMP	1	PZ									
VM1794A0	250X4.8 PA66 BLACK CLAMP	1	PZ										
KTB2979C	XEBC-10XX-E VENTURI COLLECTOR PIPE KI	<table border="1"> <thead> <tr> <th>Code</th> <th>Description</th> <th>Qty</th> <th>UOM</th> </tr> </thead> <tbody> <tr> <td>GN1544A0</td> <td>AIR INLET GASKET</td> <td>2</td> <td>PZ</td> </tr> </tbody> </table>	Code	Description	Qty	UOM	GN1544A0	AIR INLET GASKET	2	PZ			
		Code	Description	Qty	UOM								
		GN1544A0	AIR INLET GASKET	2	PZ								
		<table border="1"> <tbody> <tr> <td>GN1584A0</td> <td>CORNER FITTING D30-D16</td> <td>1</td> <td>PZ</td> </tr> </tbody> </table>	GN1584A0	CORNER FITTING D30-D16	1	PZ							
		GN1584A0	CORNER FITTING D30-D16	1	PZ								
		<table border="1"> <tbody> <tr> <td>RC1042A0</td> <td>DOUBLE WIRE SPRING CLAMP D21.5-22.6</td> <td>1</td> <td>PZ</td> </tr> </tbody> </table>	RC1042A0	DOUBLE WIRE SPRING CLAMP D21.5-22.6	1	PZ							
RC1042A0	DOUBLE WIRE SPRING CLAMP D21.5-22.6	1	PZ										
<table border="1"> <tbody> <tr> <td>TB2979C0</td> <td>XEBC-10 VENTURI AIR COLLECTOR PIPE D30</td> <td>1</td> <td>PZ</td> </tr> </tbody> </table>	TB2979C0	XEBC-10 VENTURI AIR COLLECTOR PIPE D30	1	PZ									
TB2979C0	XEBC-10 VENTURI AIR COLLECTOR PIPE D30	1	PZ										
<table border="1"> <tbody> <tr> <td>VM1794A0</td> <td>250X4.8 PA66 BLACK CLAMP</td> <td>1</td> <td>PZ</td> </tr> </tbody> </table>	VM1794A0	250X4.8 PA66 BLACK CLAMP	1	PZ									
VM1794A0	250X4.8 PA66 BLACK CLAMP	1	PZ										
KTB2978B	XEBC-06 VENTURI COLLECTOR PIPE KI	<table border="1"> <thead> <tr> <th>Code</th> <th>Description</th> <th>Qty</th> <th>UOM</th> </tr> </thead> <tbody> <tr> <td>GN1544A0</td> <td>AIR INLET GASKET</td> <td>1</td> <td>PZ</td> </tr> </tbody> </table>	Code	Description	Qty	UOM	GN1544A0	AIR INLET GASKET	1	PZ			
		Code	Description	Qty	UOM								
		GN1544A0	AIR INLET GASKET	1	PZ								
		<table border="1"> <tbody> <tr> <td>GN1584A0</td> <td>CORNER FITTING D30-D16</td> <td>1</td> <td>PZ</td> </tr> </tbody> </table>	GN1584A0	CORNER FITTING D30-D16	1	PZ							
GN1584A0	CORNER FITTING D30-D16	1	PZ										
<table border="1"> <tbody> <tr> <td>RC1042A0</td> <td>DOUBLE WIRE SPRING CLAMP D21.5-22.6</td> <td>1</td> <td>PZ</td> </tr> </tbody> </table>	RC1042A0	DOUBLE WIRE SPRING CLAMP D21.5-22.6	1	PZ									
RC1042A0	DOUBLE WIRE SPRING CLAMP D21.5-22.6	1	PZ										



COMPONENT			SPARE PART																										
Code	Description	Image	Code	Description	Components list																								
GN1544A	AIR INLET GASKET		KTB2978B	XEBC-06 VENTURI COLLECTOR PIPE KI	<table border="1"> <thead> <tr> <th>Code</th> <th>Description</th> <th>Qty</th> <th>UOM</th> </tr> </thead> <tbody> <tr> <td>TB2978B0</td> <td>XEBC-06 VENTURI AIR COLLECTOR PIPE D30</td> <td>1</td> <td>PZ</td> </tr> <tr> <td>VM1794A0</td> <td>250X4.8 PA66 BLACK CLAMP</td> <td>1</td> <td>PZ</td> </tr> </tbody> </table>	Code	Description	Qty	UOM	TB2978B0	XEBC-06 VENTURI AIR COLLECTOR PIPE D30	1	PZ	VM1794A0	250X4.8 PA66 BLACK CLAMP	1	PZ												
					Code	Description	Qty	UOM																					
			TB2978B0	XEBC-06 VENTURI AIR COLLECTOR PIPE D30	1	PZ																							
			VM1794A0	250X4.8 PA66 BLACK CLAMP	1	PZ																							
			KTB2959B	XEVC-1011-E VENTURI COLLECTOR PIPE KI	<table border="1"> <thead> <tr> <th>Code</th> <th>Description</th> <th>Qty</th> <th>UOM</th> </tr> </thead> <tbody> <tr> <td>GN1544A0</td> <td>AIR INLET GASKET</td> <td>2</td> <td>PZ</td> </tr> <tr> <td>GN1584A0</td> <td>CORNER FITTING D30-D16</td> <td>1</td> <td>PZ</td> </tr> <tr> <td>RC1042A0</td> <td>DOUBLE WIRE SPRING CLAMP D21.5-22.6</td> <td>1</td> <td>PZ</td> </tr> <tr> <td>TB2959B0</td> <td>XEVC-1011-E VENTURI PIPE</td> <td>1</td> <td>PZ</td> </tr> <tr> <td>VM1794A0</td> <td>250X4.8 PA66 BLACK CLAMP</td> <td>1</td> <td>PZ</td> </tr> </tbody> </table>	Code	Description	Qty	UOM	GN1544A0	AIR INLET GASKET	2	PZ	GN1584A0	CORNER FITTING D30-D16	1	PZ	RC1042A0	DOUBLE WIRE SPRING CLAMP D21.5-22.6	1	PZ	TB2959B0	XEVC-1011-E VENTURI PIPE	1	PZ	VM1794A0	250X4.8 PA66 BLACK CLAMP	1	PZ
					Code	Description	Qty	UOM																					
					GN1544A0	AIR INLET GASKET	2	PZ																					
					GN1584A0	CORNER FITTING D30-D16	1	PZ																					
					RC1042A0	DOUBLE WIRE SPRING CLAMP D21.5-22.6	1	PZ																					
					TB2959B0	XEVC-1011-E VENTURI PIPE	1	PZ																					
			VM1794A0	250X4.8 PA66 BLACK CLAMP	1	PZ																							
			KTB2958B	XEVC-0711-E VENTURI COLLECTOR PIPE KI	<table border="1"> <thead> <tr> <th>Code</th> <th>Description</th> <th>Qty</th> <th>UOM</th> </tr> </thead> <tbody> <tr> <td>GN1544A0</td> <td>AIR INLET GASKET</td> <td>1</td> <td>PZ</td> </tr> <tr> <td>GN1584A0</td> <td>CORNER FITTING D30-D16</td> <td>1</td> <td>PZ</td> </tr> <tr> <td>RC1042A0</td> <td>DOUBLE WIRE SPRING CLAMP D21.5-22.6</td> <td>1</td> <td>PZ</td> </tr> <tr> <td>TB2958B0</td> <td>XEVC-0711-E VENTURI PIPE</td> <td>1</td> <td>PZ</td> </tr> <tr> <td>VM1794A0</td> <td>250X4.8 PA66 BLACK CLAMP</td> <td>1</td> <td>PZ</td> </tr> </tbody> </table>	Code	Description	Qty	UOM	GN1544A0	AIR INLET GASKET	1	PZ	GN1584A0	CORNER FITTING D30-D16	1	PZ	RC1042A0	DOUBLE WIRE SPRING CLAMP D21.5-22.6	1	PZ	TB2958B0	XEVC-0711-E VENTURI PIPE	1	PZ	VM1794A0	250X4.8 PA66 BLACK CLAMP	1	PZ
					Code	Description	Qty	UOM																					
					GN1544A0	AIR INLET GASKET	1	PZ																					
					GN1584A0	CORNER FITTING D30-D16	1	PZ																					
					RC1042A0	DOUBLE WIRE SPRING CLAMP D21.5-22.6	1	PZ																					
TB2958B0	XEVC-0711-E VENTURI PIPE	1			PZ																								
VM1794A0	250X4.8 PA66 BLACK CLAMP	1	PZ																										
KTB2957B	0511/04EU-E VENTURI COLLECTOR PIPE KI	<table border="1"> <thead> <tr> <th>Code</th> <th>Description</th> <th>Qty</th> <th>UOM</th> </tr> </thead> <tbody> <tr> <td>GN1544A0</td> <td>AIR INLET GASKET</td> <td>1</td> <td>PZ</td> </tr> <tr> <td>GN1584A0</td> <td>CORNER FITTING D30-D16</td> <td>1</td> <td>PZ</td> </tr> <tr> <td>RC1042A0</td> <td>DOUBLE WIRE SPRING CLAMP D21.5-22.6</td> <td>1</td> <td>PZ</td> </tr> <tr> <td>TB2957B0</td> <td>XEVC-0511-E VENTURI PIPE</td> <td>1</td> <td>PZ</td> </tr> <tr> <td>VM1794A0</td> <td>250X4.8 PA66 BLACK CLAMP</td> <td>1</td> <td>PZ</td> </tr> </tbody> </table>	Code	Description	Qty	UOM	GN1544A0	AIR INLET GASKET	1	PZ	GN1584A0	CORNER FITTING D30-D16	1	PZ	RC1042A0	DOUBLE WIRE SPRING CLAMP D21.5-22.6	1	PZ	TB2957B0	XEVC-0511-E VENTURI PIPE	1	PZ	VM1794A0	250X4.8 PA66 BLACK CLAMP	1	PZ			
		Code	Description	Qty	UOM																								
		GN1544A0	AIR INLET GASKET	1	PZ																								
		GN1584A0	CORNER FITTING D30-D16	1	PZ																								
		RC1042A0	DOUBLE WIRE SPRING CLAMP D21.5-22.6	1	PZ																								
		TB2957B0	XEVC-0511-E VENTURI PIPE	1	PZ																								
VM1794A0	250X4.8 PA66 BLACK CLAMP	1	PZ																										

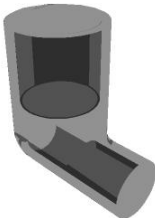

COMPONENT			SPARE PART																		
Code	Description	Image	Code	Description	Components list																
GN1544A	AIR INLET GASKET		KTB2956A	XEVC-0311-E VENTURI COLLECTOR PIPE KI	<table border="1"> <thead> <tr> <th>Code</th> <th>Description</th> <th>Qty</th> <th>UOM</th> </tr> </thead> <tbody> <tr> <td>GN1544A0</td> <td>AIR INLET GASKET</td> <td>1</td> <td>PZ</td> </tr> <tr> <td>RC1042A0</td> <td>DOUBLE WIRE SPRING CLAMP D21.5-22.6</td> <td>1</td> <td>PZ</td> </tr> <tr> <td>TB2956A0</td> <td>XEVC-0311-E VENTURI PIPE</td> <td>1</td> <td>PZ</td> </tr> </tbody> </table>	Code	Description	Qty	UOM	GN1544A0	AIR INLET GASKET	1	PZ	RC1042A0	DOUBLE WIRE SPRING CLAMP D21.5-22.6	1	PZ	TB2956A0	XEVC-0311-E VENTURI PIPE	1	PZ
					Code	Description	Qty	UOM													
					GN1544A0	AIR INLET GASKET	1	PZ													
					RC1042A0	DOUBLE WIRE SPRING CLAMP D21.5-22.6	1	PZ													
			TB2956A0	XEVC-0311-E VENTURI PIPE	1	PZ															
			KTB2944A	20XX/16XX LOWER VENTURI COLLECT PIPE KIT	<table border="1"> <thead> <tr> <th>Code</th> <th>Description</th> <th>Qty</th> <th>UOM</th> </tr> </thead> <tbody> <tr> <td>GN1544A0</td> <td>AIR INLET GASKET</td> <td>2</td> <td>PZ</td> </tr> <tr> <td>GN1584A0</td> <td>CORNER FITTING D30-D16</td> <td>1</td> <td>PZ</td> </tr> <tr> <td>RC1042A0</td> <td>DOUBLE WIRE SPRING CLAMP D21.5-22.6</td> <td>1</td> <td>PZ</td> </tr> </tbody> </table>	Code	Description	Qty	UOM	GN1544A0	AIR INLET GASKET	2	PZ	GN1584A0	CORNER FITTING D30-D16	1	PZ	RC1042A0	DOUBLE WIRE SPRING CLAMP D21.5-22.6	1	PZ
					Code	Description	Qty	UOM													
					GN1544A0	AIR INLET GASKET	2	PZ													
					GN1584A0	CORNER FITTING D30-D16	1	PZ													
			RC1042A0	DOUBLE WIRE SPRING CLAMP D21.5-22.6	1	PZ															
			TB2944A1	XEVC-2011 AIR INLET PIPE D3	1	PZ															
			VM1794A0	250X4.8 PA66 BLACK CLAMP	1	PZ															
KTB1323A	XECC-05XX-E VENTURI COLLECTOR PIPE KI	<table border="1"> <thead> <tr> <th>Code</th> <th>Description</th> <th>Qty</th> <th>UOM</th> </tr> </thead> <tbody> <tr> <td>GN1544A0</td> <td>AIR INLET GASKET</td> <td>1</td> <td>PZ</td> </tr> <tr> <td>GN1584A0</td> <td>CORNER FITTING D30-D16</td> <td>1</td> <td>PZ</td> </tr> <tr> <td>RC1042A0</td> <td>DOUBLE WIRE SPRING CLAMP D21.5-22.6</td> <td>1</td> <td>PZ</td> </tr> </tbody> </table>	Code	Description	Qty	UOM	GN1544A0	AIR INLET GASKET	1	PZ	GN1584A0	CORNER FITTING D30-D16	1	PZ	RC1042A0	DOUBLE WIRE SPRING CLAMP D21.5-22.6	1	PZ			
		Code	Description	Qty	UOM																
		GN1544A0	AIR INLET GASKET	1	PZ																
		GN1584A0	CORNER FITTING D30-D16	1	PZ																
RC1042A0	DOUBLE WIRE SPRING CLAMP D21.5-22.6	1	PZ																		
TB1323A1	XECC-05XX VENTURI AIR EXIT PIPE	1	PZ																		
KGN1544A	5 PCS AIR INLET GASKET KIT	<table border="1"> <thead> <tr> <th>Code</th> <th>Description</th> <th>Qty</th> <th>UOM</th> </tr> </thead> <tbody> <tr> <td>GN1544A0</td> <td>AIR INLET GASKET</td> <td>5</td> <td>PZ</td> </tr> <tr> <td>VM1224A0</td> <td>65MY 220MM 2 COLOURS SHRINK TUBE</td> <td>0.200</td> <td>M</td> </tr> </tbody> </table>	Code	Description	Qty	UOM	GN1544A0	AIR INLET GASKET	5	PZ	VM1224A0	65MY 220MM 2 COLOURS SHRINK TUBE	0.200	M							
		Code	Description	Qty	UOM																
GN1544A0	AIR INLET GASKET	5	PZ																		
VM1224A0	65MY 220MM 2 COLOURS SHRINK TUBE	0.200	M																		

COMPONENT			SPARE PART																																																																														
Code	Description	Image	Code	Description	Components list																																																																												
VM2377A	220 V 50/60 HZ VENTURI KIT		KVM2377A	MM 220 V VENTURI ACTUATOR SYSTEM KIT	<table border="1"> <thead> <tr> <th>Code</th> <th>Description</th> <th>Qty</th> <th>UOM</th> </tr> </thead> <tbody> <tr> <td>GN1556A0</td> <td>MM VENTURI SEAL</td> <td>1</td> <td>PZ</td> </tr> <tr> <td>MOV0016A0</td> <td>HOOD RING GASKET GN1110A2</td> <td>0.100</td> <td>PZ</td> </tr> <tr> <td>RC1378A0</td> <td>HOSE CLAMP</td> <td>3</td> <td>PZ</td> </tr> <tr> <td>TB1520A0</td> <td>INT. Ø=38 TH=4 DRAIN BLACK RUBBER PIPE</td> <td>0.170</td> <td>M</td> </tr> <tr> <td>VE1135A0</td> <td>220 V 50/60 HZ VENTURI ACTUATOR</td> <td>1</td> <td>PZ</td> </tr> <tr> <td>VI1032A0</td> <td>SCREW M4X16 TCB+ INOX</td> <td>1</td> <td>PZ</td> </tr> <tr> <td>VI1220A1</td> <td>4,2X12 TCB SELF-TAPPIN G SCREW</td> <td>6</td> <td>PZ</td> </tr> <tr> <td>VM2345A0</td> <td>MM VENTURI UPPER BODY</td> <td>1</td> <td>PZ</td> </tr> <tr> <td>VM2345A0</td> <td>MM VENTURI UPPER BODY</td> <td>1</td> <td>PZ</td> </tr> <tr> <td>VM2346A0</td> <td>MM VENTURI LOWER BODY</td> <td>1</td> <td>PZ</td> </tr> <tr> <td>VM2346A0</td> <td>MM VENTURI LOWER BODY</td> <td>1</td> <td>PZ</td> </tr> <tr> <td>VM2346A1</td> <td>S6 VENTURI LOWER HALF</td> <td>1</td> <td>PZ</td> </tr> <tr> <td>VM2347A0</td> <td>VENTURI MIND.MAPS COVER</td> <td>1</td> <td>PZ</td> </tr> <tr> <td>VM2347A0</td> <td>VENTURI MIND.MAPS COVER</td> <td>1</td> <td>PZ</td> </tr> <tr> <td>VM2348A0</td> <td>VENTURI PLATE SPACE</td> <td>1</td> <td>PZ</td> </tr> <tr> <td>VM2348A0</td> <td>VENTURI PLATE SPACE</td> <td>1</td> <td>PZ</td> </tr> <tr> <td>VM2349A0</td> <td>VENTURI LOWER BUSHING</td> <td>1</td> <td>PZ</td> </tr> <tr> <td>VM2349A0</td> <td>VENTURI LOWER BUSHING</td> <td>1</td> <td>PZ</td> </tr> </tbody> </table>	Code	Description	Qty	UOM	GN1556A0	MM VENTURI SEAL	1	PZ	MOV0016A0	HOOD RING GASKET GN1110A2	0.100	PZ	RC1378A0	HOSE CLAMP	3	PZ	TB1520A0	INT. Ø=38 TH=4 DRAIN BLACK RUBBER PIPE	0.170	M	VE1135A0	220 V 50/60 HZ VENTURI ACTUATOR	1	PZ	VI1032A0	SCREW M4X16 TCB+ INOX	1	PZ	VI1220A1	4,2X12 TCB SELF-TAPPIN G SCREW	6	PZ	VM2345A0	MM VENTURI UPPER BODY	1	PZ	VM2345A0	MM VENTURI UPPER BODY	1	PZ	VM2346A0	MM VENTURI LOWER BODY	1	PZ	VM2346A0	MM VENTURI LOWER BODY	1	PZ	VM2346A1	S6 VENTURI LOWER HALF	1	PZ	VM2347A0	VENTURI MIND.MAPS COVER	1	PZ	VM2347A0	VENTURI MIND.MAPS COVER	1	PZ	VM2348A0	VENTURI PLATE SPACE	1	PZ	VM2348A0	VENTURI PLATE SPACE	1	PZ	VM2349A0	VENTURI LOWER BUSHING	1	PZ	VM2349A0	VENTURI LOWER BUSHING	1	PZ
					Code	Description	Qty	UOM																																																																									
					GN1556A0	MM VENTURI SEAL	1	PZ																																																																									
					MOV0016A0	HOOD RING GASKET GN1110A2	0.100	PZ																																																																									
					RC1378A0	HOSE CLAMP	3	PZ																																																																									
					TB1520A0	INT. Ø=38 TH=4 DRAIN BLACK RUBBER PIPE	0.170	M																																																																									
					VE1135A0	220 V 50/60 HZ VENTURI ACTUATOR	1	PZ																																																																									
					VI1032A0	SCREW M4X16 TCB+ INOX	1	PZ																																																																									
					VI1220A1	4,2X12 TCB SELF-TAPPIN G SCREW	6	PZ																																																																									
					VM2345A0	MM VENTURI UPPER BODY	1	PZ																																																																									
					VM2345A0	MM VENTURI UPPER BODY	1	PZ																																																																									
					VM2346A0	MM VENTURI LOWER BODY	1	PZ																																																																									
					VM2346A0	MM VENTURI LOWER BODY	1	PZ																																																																									
					VM2346A1	S6 VENTURI LOWER HALF	1	PZ																																																																									
					VM2347A0	VENTURI MIND.MAPS COVER	1	PZ																																																																									
					VM2347A0	VENTURI MIND.MAPS COVER	1	PZ																																																																									
					VM2348A0	VENTURI PLATE SPACE	1	PZ																																																																									
					VM2348A0	VENTURI PLATE SPACE	1	PZ																																																																									
					VM2349A0	VENTURI LOWER BUSHING	1	PZ																																																																									
					VM2349A0	VENTURI LOWER BUSHING	1	PZ																																																																									
GN1584A	CORNER FITTING D30-D16		KGN1584A	D30-D16 CORNER FITTING KIT	<table border="1"> <thead> <tr> <th>Code</th> <th>Description</th> <th>Qty</th> <th>UOM</th> </tr> </thead> <tbody> <tr> <td>GN1584A0</td> <td>CORNER FITTING D30-D16</td> <td>1</td> <td>PZ</td> </tr> <tr> <td>VM1224A0</td> <td>65MY 220MM 2 COLOURS SHRINK TUBE</td> <td>0.150</td> <td>M</td> </tr> </tbody> </table>	Code	Description	Qty	UOM	GN1584A0	CORNER FITTING D30-D16	1	PZ	VM1224A0	65MY 220MM 2 COLOURS SHRINK TUBE	0.150	M																																																																
					Code	Description	Qty	UOM																																																																									
GN1584A0	CORNER FITTING D30-D16	1	PZ																																																																														
VM1224A0	65MY 220MM 2 COLOURS SHRINK TUBE	0.150	M																																																																														



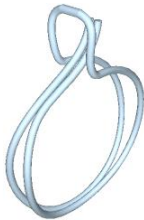

COMPONENT			SPARE PART																																						
Code	Description	Image	Code	Description	Components list																																				
TB2603A	TB1520A0- VENTURI FAN 0,12M		KTB2603A	VENTURI-COOLING FAN CONNECT. KIT TB1520A	<table border="1"> <thead> <tr> <th>Code</th> <th>Description</th> <th>Qty</th> <th>UOM</th> </tr> </thead> <tbody> <tr> <td>TB1520A0</td> <td>INT. Ø=38 TH=4 DRAIN BLACK RUBBER PIPE</td> <td>0.120</td> <td>M</td> </tr> <tr> <td>VM1224A0</td> <td>65MY 220MM 2 COLOURS SHRINK TUBE</td> <td>0.200</td> <td>M</td> </tr> </tbody> </table>	Code	Description	Qty	UOM	TB1520A0	INT. Ø=38 TH=4 DRAIN BLACK RUBBER PIPE	0.120	M	VM1224A0	65MY 220MM 2 COLOURS SHRINK TUBE	0.200	M																								
Code	Description	Qty	UOM																																						
TB1520A0	INT. Ø=38 TH=4 DRAIN BLACK RUBBER PIPE	0.120	M																																						
VM1224A0	65MY 220MM 2 COLOURS SHRINK TUBE	0.200	M																																						
TB1956A	TB1520A-GREY SILICONE PIPE L=0,04M		<p>KTB1002A</p> <p>KTB1001A</p> <p>KTB1000A</p>	<p>BLACK TUBE KIT EPDM 60MT TB1520</p> <p>BLACK TUBE KIT EPDM 10MT TB1520</p> <p>EPDM BLACK TUBE TB1520A 2MT KIT</p>	<table border="1"> <thead> <tr> <th>Code</th> <th>Description</th> <th>Qty</th> <th>UOM</th> </tr> </thead> <tbody> <tr> <td>IL1206C0</td> <td>968X1053 H126 XBC WOOD PALLE</td> <td>1</td> <td>PZ</td> </tr> <tr> <td>IL1206D0</td> <td></td> <td>1</td> <td>PZ</td> </tr> <tr> <td>TB1520A0</td> <td>INT. Ø=38 TH=4 DRAIN BLACK RUBBER PIPE</td> <td>60</td> <td>M</td> </tr> <tr> <td>TB1520A0</td> <td>INT. Ø=38 TH=4 DRAIN BLACK RUBBER PIPE</td> <td>10</td> <td>M</td> </tr> <tr> <td>VM1794A0</td> <td>250X4.8 PA66 BLACK CLAMP</td> <td>3</td> <td>PZ</td> </tr> <tr> <td>RC1055A0</td> <td>Ø25-40 H12 STAINLESS STEEL PIPE CLIP</td> <td>2</td> <td>PZ</td> </tr> <tr> <td>TB1520A0</td> <td>INT. Ø=38 TH=4 DRAIN BLACK RUBBER PIPE</td> <td>2</td> <td>M</td> </tr> <tr> <td>VM1059A1</td> <td>HEAT SHRINK FILM H800</td> <td>1.500</td> <td>M</td> </tr> </tbody> </table>	Code	Description	Qty	UOM	IL1206C0	968X1053 H126 XBC WOOD PALLE	1	PZ	IL1206D0		1	PZ	TB1520A0	INT. Ø=38 TH=4 DRAIN BLACK RUBBER PIPE	60	M	TB1520A0	INT. Ø=38 TH=4 DRAIN BLACK RUBBER PIPE	10	M	VM1794A0	250X4.8 PA66 BLACK CLAMP	3	PZ	RC1055A0	Ø25-40 H12 STAINLESS STEEL PIPE CLIP	2	PZ	TB1520A0	INT. Ø=38 TH=4 DRAIN BLACK RUBBER PIPE	2	M	VM1059A1	HEAT SHRINK FILM H800	1.500	M
Code	Description	Qty	UOM																																						
IL1206C0	968X1053 H126 XBC WOOD PALLE	1	PZ																																						
IL1206D0		1	PZ																																						
TB1520A0	INT. Ø=38 TH=4 DRAIN BLACK RUBBER PIPE	60	M																																						
TB1520A0	INT. Ø=38 TH=4 DRAIN BLACK RUBBER PIPE	10	M																																						
VM1794A0	250X4.8 PA66 BLACK CLAMP	3	PZ																																						
RC1055A0	Ø25-40 H12 STAINLESS STEEL PIPE CLIP	2	PZ																																						
TB1520A0	INT. Ø=38 TH=4 DRAIN BLACK RUBBER PIPE	2	M																																						
VM1059A1	HEAT SHRINK FILM H800	1.500	M																																						
RC1042A	DOUBLE WIRE SPRING CLAMP D21.5-22.6		KTB3074B	XEVC-0711-G VENTURI COLLECTOR PIPE KI	<table border="1"> <thead> <tr> <th>Code</th> <th>Description</th> <th>Qty</th> <th>UOM</th> </tr> </thead> <tbody> <tr> <td>GN1544A0</td> <td>AIR INLET GASKET</td> <td>1</td> <td>PZ</td> </tr> <tr> <td>GN1584A0</td> <td>CORNER FITTING D30-D16</td> <td>1</td> <td>PZ</td> </tr> <tr> <td>RC1042A0</td> <td>DOUBLE WIRE SPRING CLAMP D21.5-22.6</td> <td>1</td> <td>PZ</td> </tr> <tr> <td>TB3074B0</td> <td>XEVC-07EU-G VENTURI COLLECTOR PIPE D30</td> <td>1</td> <td>PZ</td> </tr> <tr> <td>VM1794A0</td> <td>250X4.8 PA66 BLACK CLAMP</td> <td>1</td> <td>PZ</td> </tr> </tbody> </table>	Code	Description	Qty	UOM	GN1544A0	AIR INLET GASKET	1	PZ	GN1584A0	CORNER FITTING D30-D16	1	PZ	RC1042A0	DOUBLE WIRE SPRING CLAMP D21.5-22.6	1	PZ	TB3074B0	XEVC-07EU-G VENTURI COLLECTOR PIPE D30	1	PZ	VM1794A0	250X4.8 PA66 BLACK CLAMP	1	PZ												
Code	Description	Qty	UOM																																						
GN1544A0	AIR INLET GASKET	1	PZ																																						
GN1584A0	CORNER FITTING D30-D16	1	PZ																																						
RC1042A0	DOUBLE WIRE SPRING CLAMP D21.5-22.6	1	PZ																																						
TB3074B0	XEVC-07EU-G VENTURI COLLECTOR PIPE D30	1	PZ																																						
VM1794A0	250X4.8 PA66 BLACK CLAMP	1	PZ																																						

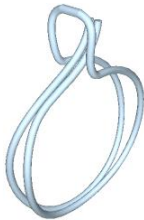

COMPONENT			SPARE PART																										
Code	Description	Image	Code	Description	Components list																								
RC1042A	DOUBLE WIRE SPRING CLAMP D21.5-22.6		KTB3068B	10FS/EU/2-G VENTURI COLLECTOR PIPE KI	<table border="1"> <thead> <tr> <th>Code</th> <th>Description</th> <th>Qty</th> <th>UOM</th> </tr> </thead> <tbody> <tr> <td>GN1544A0</td> <td>AIR INLET GASKET</td> <td>2</td> <td>PZ</td> </tr> <tr> <td>GN1584A0</td> <td>CORNER FITTING D30-D16</td> <td>1</td> <td>PZ</td> </tr> <tr> <td>RC1042A0</td> <td>DOUBLE WIRE SPRING CLAMP D21.5-22.6</td> <td>1</td> <td>PZ</td> </tr> <tr> <td>TB3068B0</td> <td>XEBC-10 VENTURI AIR COLLECTOR PIPE D30</td> <td>1</td> <td>PZ</td> </tr> <tr> <td>VM1794A0</td> <td>250X4.8 PA66 BLACK CLAMP</td> <td>1</td> <td>PZ</td> </tr> </tbody> </table>	Code	Description	Qty	UOM	GN1544A0	AIR INLET GASKET	2	PZ	GN1584A0	CORNER FITTING D30-D16	1	PZ	RC1042A0	DOUBLE WIRE SPRING CLAMP D21.5-22.6	1	PZ	TB3068B0	XEBC-10 VENTURI AIR COLLECTOR PIPE D30	1	PZ	VM1794A0	250X4.8 PA66 BLACK CLAMP	1	PZ
					Code	Description	Qty	UOM																					
					GN1544A0	AIR INLET GASKET	2	PZ																					
					GN1584A0	CORNER FITTING D30-D16	1	PZ																					
			RC1042A0	DOUBLE WIRE SPRING CLAMP D21.5-22.6	1	PZ																							
			TB3068B0	XEBC-10 VENTURI AIR COLLECTOR PIPE D30	1	PZ																							
			VM1794A0	250X4.8 PA66 BLACK CLAMP	1	PZ																							
			KTB3019A	20XX/16XX UPPER VENTURI COLLECT PIPE KIT	<table border="1"> <thead> <tr> <th>Code</th> <th>Description</th> <th>Qty</th> <th>UOM</th> </tr> </thead> <tbody> <tr> <td>GN1544A0</td> <td>AIR INLET GASKET</td> <td>1</td> <td>PZ</td> </tr> <tr> <td>GN1584A0</td> <td>CORNER FITTING D30-D16</td> <td>1</td> <td>PZ</td> </tr> <tr> <td>RC1042A0</td> <td>DOUBLE WIRE SPRING CLAMP D21.5-22.6</td> <td>1</td> <td>PZ</td> </tr> <tr> <td>TB3019A1</td> <td>XEVC-2011 UPPER AIR INLET PIPE D3</td> <td>1</td> <td>PZ</td> </tr> <tr> <td>VM1794A0</td> <td>250X4.8 PA66 BLACK CLAMP</td> <td>1</td> <td>PZ</td> </tr> </tbody> </table>	Code	Description	Qty	UOM	GN1544A0	AIR INLET GASKET	1	PZ	GN1584A0	CORNER FITTING D30-D16	1	PZ	RC1042A0	DOUBLE WIRE SPRING CLAMP D21.5-22.6	1	PZ	TB3019A1	XEVC-2011 UPPER AIR INLET PIPE D3	1	PZ	VM1794A0	250X4.8 PA66 BLACK CLAMP	1	PZ
					Code	Description	Qty	UOM																					
					GN1544A0	AIR INLET GASKET	1	PZ																					
					GN1584A0	CORNER FITTING D30-D16	1	PZ																					
			RC1042A0	DOUBLE WIRE SPRING CLAMP D21.5-22.6	1	PZ																							
TB3019A1	XEVC-2011 UPPER AIR INLET PIPE D3	1	PZ																										
VM1794A0	250X4.8 PA66 BLACK CLAMP	1	PZ																										
KTB2979C	XEBC-10XX-E VENTURI COLLECTOR PIPE KI	<table border="1"> <thead> <tr> <th>Code</th> <th>Description</th> <th>Qty</th> <th>UOM</th> </tr> </thead> <tbody> <tr> <td>GN1544A0</td> <td>AIR INLET GASKET</td> <td>2</td> <td>PZ</td> </tr> <tr> <td>GN1584A0</td> <td>CORNER FITTING D30-D16</td> <td>1</td> <td>PZ</td> </tr> <tr> <td>RC1042A0</td> <td>DOUBLE WIRE SPRING CLAMP D21.5-22.6</td> <td>1</td> <td>PZ</td> </tr> <tr> <td>TB2979C0</td> <td>XEBC-10 VENTURI AIR COLLECTOR PIPE D30</td> <td>1</td> <td>PZ</td> </tr> <tr> <td>VM1794A0</td> <td>250X4.8 PA66 BLACK CLAMP</td> <td>1</td> <td>PZ</td> </tr> </tbody> </table>	Code	Description	Qty	UOM	GN1544A0	AIR INLET GASKET	2	PZ	GN1584A0	CORNER FITTING D30-D16	1	PZ	RC1042A0	DOUBLE WIRE SPRING CLAMP D21.5-22.6	1	PZ	TB2979C0	XEBC-10 VENTURI AIR COLLECTOR PIPE D30	1	PZ	VM1794A0	250X4.8 PA66 BLACK CLAMP	1	PZ			
		Code	Description	Qty	UOM																								
		GN1544A0	AIR INLET GASKET	2	PZ																								
		GN1584A0	CORNER FITTING D30-D16	1	PZ																								
RC1042A0	DOUBLE WIRE SPRING CLAMP D21.5-22.6	1	PZ																										
TB2979C0	XEBC-10 VENTURI AIR COLLECTOR PIPE D30	1	PZ																										
VM1794A0	250X4.8 PA66 BLACK CLAMP	1	PZ																										
KTB2978B	XEBC-06 VENTURI COLLECTOR PIPE KI	<table border="1"> <thead> <tr> <th>Code</th> <th>Description</th> <th>Qty</th> <th>UOM</th> </tr> </thead> <tbody> <tr> <td>GN1544A0</td> <td>AIR INLET GASKET</td> <td>1</td> <td>PZ</td> </tr> </tbody> </table>	Code	Description	Qty	UOM	GN1544A0	AIR INLET GASKET	1	PZ																			
Code	Description	Qty	UOM																										
GN1544A0	AIR INLET GASKET	1	PZ																										



COMPONENT			SPARE PART																										
Code	Description	Image	Code	Description	Components list																								
RC1042A	DOUBLE WIRE SPRING CLAMP D21.5-22.6		KTB2978B	XEBC-06 VENTURI COLLECTOR PIPE KI	<table border="1"> <thead> <tr> <th>Code</th> <th>Description</th> <th>Qty</th> <th>UOM</th> </tr> </thead> <tbody> <tr> <td>GN1584A0</td> <td>CORNER FITTING D30-D16</td> <td>1</td> <td>PZ</td> </tr> <tr> <td>RC1042A0</td> <td>DOUBLE WIRE SPRING CLAMP D21.5-22.6</td> <td>1</td> <td>PZ</td> </tr> <tr> <td>TB2978B0</td> <td>XEBC-06 VENTURI AIR COLLECTOR PIPE D30</td> <td>1</td> <td>PZ</td> </tr> <tr> <td>VM1794A0</td> <td>250X4.8 PA66 BLACK CLAMP</td> <td>1</td> <td>PZ</td> </tr> </tbody> </table>	Code	Description	Qty	UOM	GN1584A0	CORNER FITTING D30-D16	1	PZ	RC1042A0	DOUBLE WIRE SPRING CLAMP D21.5-22.6	1	PZ	TB2978B0	XEBC-06 VENTURI AIR COLLECTOR PIPE D30	1	PZ	VM1794A0	250X4.8 PA66 BLACK CLAMP	1	PZ				
					Code	Description	Qty	UOM																					
					GN1584A0	CORNER FITTING D30-D16	1	PZ																					
					RC1042A0	DOUBLE WIRE SPRING CLAMP D21.5-22.6	1	PZ																					
			TB2978B0	XEBC-06 VENTURI AIR COLLECTOR PIPE D30	1	PZ																							
			VM1794A0	250X4.8 PA66 BLACK CLAMP	1	PZ																							
			KTB2959B	XEVC-1011-E VENTURI COLLECTOR PIPE KI	<table border="1"> <thead> <tr> <th>Code</th> <th>Description</th> <th>Qty</th> <th>UOM</th> </tr> </thead> <tbody> <tr> <td>GN1544A0</td> <td>AIR INLET GASKET</td> <td>2</td> <td>PZ</td> </tr> <tr> <td>GN1584A0</td> <td>CORNER FITTING D30-D16</td> <td>1</td> <td>PZ</td> </tr> <tr> <td>RC1042A0</td> <td>DOUBLE WIRE SPRING CLAMP D21.5-22.6</td> <td>1</td> <td>PZ</td> </tr> <tr> <td>TB2959B0</td> <td>XEVC-1011-E VENTURI PIPE</td> <td>1</td> <td>PZ</td> </tr> <tr> <td>VM1794A0</td> <td>250X4.8 PA66 BLACK CLAMP</td> <td>1</td> <td>PZ</td> </tr> </tbody> </table>	Code	Description	Qty	UOM	GN1544A0	AIR INLET GASKET	2	PZ	GN1584A0	CORNER FITTING D30-D16	1	PZ	RC1042A0	DOUBLE WIRE SPRING CLAMP D21.5-22.6	1	PZ	TB2959B0	XEVC-1011-E VENTURI PIPE	1	PZ	VM1794A0	250X4.8 PA66 BLACK CLAMP	1	PZ
					Code	Description	Qty	UOM																					
					GN1544A0	AIR INLET GASKET	2	PZ																					
					GN1584A0	CORNER FITTING D30-D16	1	PZ																					
			RC1042A0	DOUBLE WIRE SPRING CLAMP D21.5-22.6	1	PZ																							
			TB2959B0	XEVC-1011-E VENTURI PIPE	1	PZ																							
VM1794A0	250X4.8 PA66 BLACK CLAMP	1	PZ																										
KTB2958B	XEVC-0711-E VENTURI COLLECTOR PIPE KI	<table border="1"> <thead> <tr> <th>Code</th> <th>Description</th> <th>Qty</th> <th>UOM</th> </tr> </thead> <tbody> <tr> <td>GN1544A0</td> <td>AIR INLET GASKET</td> <td>1</td> <td>PZ</td> </tr> <tr> <td>GN1584A0</td> <td>CORNER FITTING D30-D16</td> <td>1</td> <td>PZ</td> </tr> <tr> <td>RC1042A0</td> <td>DOUBLE WIRE SPRING CLAMP D21.5-22.6</td> <td>1</td> <td>PZ</td> </tr> <tr> <td>TB2958B0</td> <td>XEVC-0711-E VENTURI PIPE</td> <td>1</td> <td>PZ</td> </tr> <tr> <td>VM1794A0</td> <td>250X4.8 PA66 BLACK CLAMP</td> <td>1</td> <td>PZ</td> </tr> </tbody> </table>	Code	Description	Qty	UOM	GN1544A0	AIR INLET GASKET	1	PZ	GN1584A0	CORNER FITTING D30-D16	1	PZ	RC1042A0	DOUBLE WIRE SPRING CLAMP D21.5-22.6	1	PZ	TB2958B0	XEVC-0711-E VENTURI PIPE	1	PZ	VM1794A0	250X4.8 PA66 BLACK CLAMP	1	PZ			
		Code	Description	Qty	UOM																								
		GN1544A0	AIR INLET GASKET	1	PZ																								
		GN1584A0	CORNER FITTING D30-D16	1	PZ																								
RC1042A0	DOUBLE WIRE SPRING CLAMP D21.5-22.6	1	PZ																										
TB2958B0	XEVC-0711-E VENTURI PIPE	1	PZ																										
VM1794A0	250X4.8 PA66 BLACK CLAMP	1	PZ																										
KTB2957B	0511/04EU-E VENTURI COLLECTOR PIPE KI	<table border="1"> <thead> <tr> <th>Code</th> <th>Description</th> <th>Qty</th> <th>UOM</th> </tr> </thead> <tbody> <tr> <td>GN1544A0</td> <td>AIR INLET GASKET</td> <td>1</td> <td>PZ</td> </tr> <tr> <td>GN1584A0</td> <td>CORNER FITTING D30-D16</td> <td>1</td> <td>PZ</td> </tr> <tr> <td>RC1042A0</td> <td>DOUBLE WIRE SPRING CLAMP D21.5-22.6</td> <td>1</td> <td>PZ</td> </tr> </tbody> </table>	Code	Description	Qty	UOM	GN1544A0	AIR INLET GASKET	1	PZ	GN1584A0	CORNER FITTING D30-D16	1	PZ	RC1042A0	DOUBLE WIRE SPRING CLAMP D21.5-22.6	1	PZ											
		Code	Description	Qty	UOM																								
		GN1544A0	AIR INLET GASKET	1	PZ																								
		GN1584A0	CORNER FITTING D30-D16	1	PZ																								
RC1042A0	DOUBLE WIRE SPRING CLAMP D21.5-22.6	1	PZ																										



COMPONENT			SPARE PART																							
Code	Description	Image	Code	Description	Components list																					
RC1042A	DOUBLE WIRE SPRING CLAMP D21.5-22.6		KTB2957B	0511/04EU-E VENTURI COLLECTOR PIPE KI	<table border="1"> <thead> <tr> <th>Code</th> <th>Description</th> <th>Qty</th> <th>UOM</th> </tr> </thead> <tbody> <tr> <td>TB2957B0</td> <td>XEVC-0511-E VENTURI PIPE</td> <td>1</td> <td>PZ</td> </tr> <tr> <td>VM1794A0</td> <td>250X4.8 PA66 BLACK CLAMP</td> <td>1</td> <td>PZ</td> </tr> </tbody> </table>	Code	Description	Qty	UOM	TB2957B0	XEVC-0511-E VENTURI PIPE	1	PZ	VM1794A0	250X4.8 PA66 BLACK CLAMP	1	PZ									
			Code	Description	Qty	UOM																				
			TB2957B0	XEVC-0511-E VENTURI PIPE	1	PZ																				
VM1794A0	250X4.8 PA66 BLACK CLAMP	1	PZ																							
KTB2956A	XEVC-0311-E VENTURI COLLECTOR PIPE KI	<table border="1"> <thead> <tr> <th>Code</th> <th>Description</th> <th>Qty</th> <th>UOM</th> </tr> </thead> <tbody> <tr> <td>GN1544A0</td> <td>AIR INLET GASKET</td> <td>1</td> <td>PZ</td> </tr> <tr> <td>RC1042A0</td> <td>DOUBLE WIRE SPRING CLAMP D21.5-22.6</td> <td>1</td> <td>PZ</td> </tr> <tr> <td>TB2956A0</td> <td>XEVC-0311-E VENTURI PIPE</td> <td>1</td> <td>PZ</td> </tr> </tbody> </table>	Code	Description	Qty	UOM	GN1544A0	AIR INLET GASKET	1	PZ	RC1042A0	DOUBLE WIRE SPRING CLAMP D21.5-22.6	1	PZ	TB2956A0	XEVC-0311-E VENTURI PIPE	1	PZ								
Code	Description	Qty	UOM																							
GN1544A0	AIR INLET GASKET	1	PZ																							
RC1042A0	DOUBLE WIRE SPRING CLAMP D21.5-22.6	1	PZ																							
TB2956A0	XEVC-0311-E VENTURI PIPE	1	PZ																							
KTB2944A	20XX/16XX LOWER VENTURI COLLECT PIPE KIT	<table border="1"> <thead> <tr> <th>Code</th> <th>Description</th> <th>Qty</th> <th>UOM</th> </tr> </thead> <tbody> <tr> <td>GN1544A0</td> <td>AIR INLET GASKET</td> <td>2</td> <td>PZ</td> </tr> <tr> <td>GN1584A0</td> <td>CORNER FITTING D30-D16</td> <td>1</td> <td>PZ</td> </tr> <tr> <td>RC1042A0</td> <td>DOUBLE WIRE SPRING CLAMP D21.5-22.6</td> <td>1</td> <td>PZ</td> </tr> <tr> <td>TB2944A1</td> <td>XEVC-2011 AIR INLET PIPE D3</td> <td>1</td> <td>PZ</td> </tr> <tr> <td>VM1794A0</td> <td>250X4.8 PA66 BLACK CLAMP</td> <td>1</td> <td>PZ</td> </tr> </tbody> </table>	Code	Description	Qty	UOM	GN1544A0	AIR INLET GASKET	2	PZ	GN1584A0	CORNER FITTING D30-D16	1	PZ	RC1042A0	DOUBLE WIRE SPRING CLAMP D21.5-22.6	1	PZ	TB2944A1	XEVC-2011 AIR INLET PIPE D3	1	PZ	VM1794A0	250X4.8 PA66 BLACK CLAMP	1	PZ
Code	Description	Qty	UOM																							
GN1544A0	AIR INLET GASKET	2	PZ																							
GN1584A0	CORNER FITTING D30-D16	1	PZ																							
RC1042A0	DOUBLE WIRE SPRING CLAMP D21.5-22.6	1	PZ																							
TB2944A1	XEVC-2011 AIR INLET PIPE D3	1	PZ																							
VM1794A0	250X4.8 PA66 BLACK CLAMP	1	PZ																							
TB2978B	XEBC-06 VENTURI AIR COLLECTOR PIPE D30		KTB1323A	XECC-05XX-E VENTURI COLLECTOR PIPE KI	<table border="1"> <thead> <tr> <th>Code</th> <th>Description</th> <th>Qty</th> <th>UOM</th> </tr> </thead> <tbody> <tr> <td>GN1544A0</td> <td>AIR INLET GASKET</td> <td>1</td> <td>PZ</td> </tr> <tr> <td>GN1584A0</td> <td>CORNER FITTING D30-D16</td> <td>1</td> <td>PZ</td> </tr> <tr> <td>RC1042A0</td> <td>DOUBLE WIRE SPRING CLAMP D21.5-22.6</td> <td>1</td> <td>PZ</td> </tr> <tr> <td>TB1323A1</td> <td>XECC-05XX VENTURI AIR EXIT PIPE</td> <td>1</td> <td>PZ</td> </tr> </tbody> </table>	Code	Description	Qty	UOM	GN1544A0	AIR INLET GASKET	1	PZ	GN1584A0	CORNER FITTING D30-D16	1	PZ	RC1042A0	DOUBLE WIRE SPRING CLAMP D21.5-22.6	1	PZ	TB1323A1	XECC-05XX VENTURI AIR EXIT PIPE	1	PZ	
			Code	Description	Qty	UOM																				
			GN1544A0	AIR INLET GASKET	1	PZ																				
			GN1584A0	CORNER FITTING D30-D16	1	PZ																				
RC1042A0	DOUBLE WIRE SPRING CLAMP D21.5-22.6	1	PZ																							
TB1323A1	XECC-05XX VENTURI AIR EXIT PIPE	1	PZ																							
KTB2978B	XEBC-06 VENTURI COLLECTOR PIPE KI	<table border="1"> <thead> <tr> <th>Code</th> <th>Description</th> <th>Qty</th> <th>UOM</th> </tr> </thead> <tbody> <tr> <td>GN1544A0</td> <td>AIR INLET GASKET</td> <td>1</td> <td>PZ</td> </tr> <tr> <td>GN1584A0</td> <td>CORNER FITTING D30-D16</td> <td>1</td> <td>PZ</td> </tr> <tr> <td>RC1042A0</td> <td>DOUBLE WIRE SPRING CLAMP D21.5-22.6</td> <td>1</td> <td>PZ</td> </tr> </tbody> </table>	Code	Description	Qty	UOM	GN1544A0	AIR INLET GASKET	1	PZ	GN1584A0	CORNER FITTING D30-D16	1	PZ	RC1042A0	DOUBLE WIRE SPRING CLAMP D21.5-22.6	1	PZ								
Code	Description	Qty	UOM																							
GN1544A0	AIR INLET GASKET	1	PZ																							
GN1584A0	CORNER FITTING D30-D16	1	PZ																							
RC1042A0	DOUBLE WIRE SPRING CLAMP D21.5-22.6	1	PZ																							





COMPONENT			SPARE PART																																		
Code	Description	Image	Code	Description	Components list																																
TB2978B	XEBC-06 VENTURI AIR COLLECTOR PIPE D30		KTB2978B	XEBC-06 VENTURI COLLECTOR PIPE KI	<table border="1"> <thead> <tr> <th>Code</th> <th>Description</th> <th>Qty</th> <th>UOM</th> </tr> </thead> <tbody> <tr> <td>TB2978B0</td> <td>XEBC-06 VENTURI AIR COLLECTOR PIPE D30</td> <td>1</td> <td>PZ</td> </tr> <tr> <td>VM1794A0</td> <td>250X4.8 PA66 BLACK CLAMP</td> <td>1</td> <td>PZ</td> </tr> </tbody> </table>	Code	Description	Qty	UOM	TB2978B0	XEBC-06 VENTURI AIR COLLECTOR PIPE D30	1	PZ	VM1794A0	250X4.8 PA66 BLACK CLAMP	1	PZ																				
					Code	Description	Qty	UOM																													
TB2978B0	XEBC-06 VENTURI AIR COLLECTOR PIPE D30	1	PZ																																		
VM1794A0	250X4.8 PA66 BLACK CLAMP	1	PZ																																		
GN1285A	NTC TEMPERATURE PROBE SEALING		KTR1106B	MIND.MAPS L2000 CHAMBER TEMP. PROBE KIT	<table border="1"> <thead> <tr> <th>Code</th> <th>Description</th> <th>Qty</th> <th>UOM</th> </tr> </thead> <tbody> <tr> <td>GN1285A0</td> <td>NTC TEMPERATUR E PROBE SEALING</td> <td>1</td> <td>PZ</td> </tr> <tr> <td>SL1045A0</td> <td>S57 BLACK SILICONE - 80ML CARTRIDGE</td> <td>1</td> <td>PZ</td> </tr> <tr> <td>TR1106B0</td> <td></td> <td>1</td> <td>PZ</td> </tr> <tr> <td>VI1220A1</td> <td>4,2X12 TCB SELF-TAPPIN G SCREW</td> <td>2</td> <td>PZ</td> </tr> <tr> <td>VM1464A1</td> <td>CT BT TEMPERATUR E PROBE COVER</td> <td>1</td> <td>PZ</td> </tr> <tr> <td>VM1465A0</td> <td>CHEFTOP TEMPERATUR E PROBE COVER</td> <td>1</td> <td>PZ</td> </tr> <tr> <td>VM1465A1</td> <td>CT BT TEMPERATUR E PROBE COVER</td> <td>1</td> <td>PZ</td> </tr> </tbody> </table>	Code	Description	Qty	UOM	GN1285A0	NTC TEMPERATUR E PROBE SEALING	1	PZ	SL1045A0	S57 BLACK SILICONE - 80ML CARTRIDGE	1	PZ	TR1106B0		1	PZ	VI1220A1	4,2X12 TCB SELF-TAPPIN G SCREW	2	PZ	VM1464A1	CT BT TEMPERATUR E PROBE COVER	1	PZ	VM1465A0	CHEFTOP TEMPERATUR E PROBE COVER	1	PZ	VM1465A1	CT BT TEMPERATUR E PROBE COVER	1	PZ
Code	Description	Qty	UOM																																		
GN1285A0	NTC TEMPERATUR E PROBE SEALING	1	PZ																																		
SL1045A0	S57 BLACK SILICONE - 80ML CARTRIDGE	1	PZ																																		
TR1106B0		1	PZ																																		
VI1220A1	4,2X12 TCB SELF-TAPPIN G SCREW	2	PZ																																		
VM1464A1	CT BT TEMPERATUR E PROBE COVER	1	PZ																																		
VM1465A0	CHEFTOP TEMPERATUR E PROBE COVER	1	PZ																																		
VM1465A1	CT BT TEMPERATUR E PROBE COVER	1	PZ																																		
			KTR1106A	5-5E S. L2000 CHAMBER TEMP. PROBE KIT	<table border="1"> <thead> <tr> <th>Code</th> <th>Description</th> <th>Qty</th> <th>UOM</th> </tr> </thead> <tbody> <tr> <td>GN1285A0</td> <td>NTC TEMPERATUR E PROBE SEALING</td> <td>1</td> <td>PZ</td> </tr> <tr> <td>SL1045A0</td> <td>S57 BLACK SILICONE - 80ML CARTRIDGE</td> <td>1</td> <td>PZ</td> </tr> <tr> <td>TR1106A3</td> <td>PT100 L=2000 TEMPERATUR E PROBE</td> <td>1</td> <td>PZ</td> </tr> <tr> <td>VI1220A1</td> <td>4,2X12 TCB SELF-TAPPIN G SCREW</td> <td>2</td> <td>PZ</td> </tr> <tr> <td>VM1465A0</td> <td>CHEFTOP TEMPERATUR E PROBE COVER</td> <td>1</td> <td>PZ</td> </tr> <tr> <td>VM1465A1</td> <td>CT BT TEMPERATUR E PROBE COVER</td> <td>1</td> <td>PZ</td> </tr> </tbody> </table>	Code	Description	Qty	UOM	GN1285A0	NTC TEMPERATUR E PROBE SEALING	1	PZ	SL1045A0	S57 BLACK SILICONE - 80ML CARTRIDGE	1	PZ	TR1106A3	PT100 L=2000 TEMPERATUR E PROBE	1	PZ	VI1220A1	4,2X12 TCB SELF-TAPPIN G SCREW	2	PZ	VM1465A0	CHEFTOP TEMPERATUR E PROBE COVER	1	PZ	VM1465A1	CT BT TEMPERATUR E PROBE COVER	1	PZ				
Code	Description	Qty	UOM																																		
GN1285A0	NTC TEMPERATUR E PROBE SEALING	1	PZ																																		
SL1045A0	S57 BLACK SILICONE - 80ML CARTRIDGE	1	PZ																																		
TR1106A3	PT100 L=2000 TEMPERATUR E PROBE	1	PZ																																		
VI1220A1	4,2X12 TCB SELF-TAPPIN G SCREW	2	PZ																																		
VM1465A0	CHEFTOP TEMPERATUR E PROBE COVER	1	PZ																																		
VM1465A1	CT BT TEMPERATUR E PROBE COVER	1	PZ																																		





COMPONENT			SPARE PART																																														
Code	Description	Image	Code	Description	Components list																																												
GN1285A	NTC TEMPERATURE PROBE SEALING		KTR1105A	PT100 L1000 TEMPERATURE PROBE KIT	<table border="1"> <thead> <tr> <th>Code</th> <th>Description</th> <th>Qty</th> <th>UOM</th> </tr> </thead> <tbody> <tr> <td>GN1120A0</td> <td>NTC TEMPERATUR E PROBE SEAL</td> <td>1</td> <td>PZ</td> </tr> <tr> <td>GN1120A1</td> <td>NTC TEMPERATUR E PROBE SEAL</td> <td>1</td> <td>PZ</td> </tr> <tr> <td>GN1285A0</td> <td>NTC TEMPERATUR E PROBE SEALING</td> <td>1</td> <td>PZ</td> </tr> <tr> <td>MOV0010A0</td> <td>HOOD RING GASKET GN1110A2</td> <td>0.100</td> <td>PZ</td> </tr> <tr> <td>SL1045A0</td> <td>S57 BLACK SILICONE - 80ML CARTRIDGE</td> <td>1</td> <td>PZ</td> </tr> <tr> <td>TR1105A4</td> <td>L1000 PT100 TEMPERATUR E PROBE</td> <td>1</td> <td>PZ</td> </tr> <tr> <td>VI1220A1</td> <td>4,2X12 TCB SELF-TAPPIN G SCREW</td> <td>2</td> <td>PZ</td> </tr> <tr> <td>VM1464A1</td> <td>CT BT TEMPERATUR E PROBE COVER</td> <td>1</td> <td>PZ</td> </tr> <tr> <td>VM1465A1</td> <td>CT BT TEMPERATUR E PROBE COVER</td> <td>1</td> <td>PZ</td> </tr> <tr> <td>VM2052A0</td> <td>LM CORE PROBE COVE</td> <td>1</td> <td>PZ</td> </tr> </tbody> </table>	Code	Description	Qty	UOM	GN1120A0	NTC TEMPERATUR E PROBE SEAL	1	PZ	GN1120A1	NTC TEMPERATUR E PROBE SEAL	1	PZ	GN1285A0	NTC TEMPERATUR E PROBE SEALING	1	PZ	MOV0010A0	HOOD RING GASKET GN1110A2	0.100	PZ	SL1045A0	S57 BLACK SILICONE - 80ML CARTRIDGE	1	PZ	TR1105A4	L1000 PT100 TEMPERATUR E PROBE	1	PZ	VI1220A1	4,2X12 TCB SELF-TAPPIN G SCREW	2	PZ	VM1464A1	CT BT TEMPERATUR E PROBE COVER	1	PZ	VM1465A1	CT BT TEMPERATUR E PROBE COVER	1	PZ	VM2052A0	LM CORE PROBE COVE	1	PZ
			Code	Description	Qty	UOM																																											
GN1120A0	NTC TEMPERATUR E PROBE SEAL	1	PZ																																														
GN1120A1	NTC TEMPERATUR E PROBE SEAL	1	PZ																																														
GN1285A0	NTC TEMPERATUR E PROBE SEALING	1	PZ																																														
MOV0010A0	HOOD RING GASKET GN1110A2	0.100	PZ																																														
SL1045A0	S57 BLACK SILICONE - 80ML CARTRIDGE	1	PZ																																														
TR1105A4	L1000 PT100 TEMPERATUR E PROBE	1	PZ																																														
VI1220A1	4,2X12 TCB SELF-TAPPIN G SCREW	2	PZ																																														
VM1464A1	CT BT TEMPERATUR E PROBE COVER	1	PZ																																														
VM1465A1	CT BT TEMPERATUR E PROBE COVER	1	PZ																																														
VM2052A0	LM CORE PROBE COVE	1	PZ																																														
KTR1096A	NTC 150 L=1500 TEMPERATURE PROBE KIT	<table border="1"> <thead> <tr> <th>Code</th> <th>Description</th> <th>Qty</th> <th>UOM</th> </tr> </thead> <tbody> <tr> <td>GN1120A0</td> <td>NTC TEMPERATUR E PROBE SEAL</td> <td>1</td> <td>PZ</td> </tr> <tr> <td>GN1120A1</td> <td>NTC TEMPERATUR E PROBE SEAL</td> <td>1</td> <td>PZ</td> </tr> <tr> <td>GN1285A0</td> <td>NTC TEMPERATUR E PROBE SEALING</td> <td>2</td> <td>PZ</td> </tr> <tr> <td>SL1045A0</td> <td>S57 BLACK SILICONE - 80ML CARTRIDGE</td> <td>1</td> <td>PZ</td> </tr> <tr> <td>TR1096A0</td> <td>TEMPERATUR E PROBE NTC 150 L=1500</td> <td>1</td> <td>PZ</td> </tr> <tr> <td>VI1220A1</td> <td>4,2X12 TCB SELF-TAPPIN G SCREW</td> <td>2</td> <td>PZ</td> </tr> </tbody> </table>	Code	Description	Qty	UOM	GN1120A0	NTC TEMPERATUR E PROBE SEAL	1	PZ	GN1120A1	NTC TEMPERATUR E PROBE SEAL	1	PZ	GN1285A0	NTC TEMPERATUR E PROBE SEALING	2	PZ	SL1045A0	S57 BLACK SILICONE - 80ML CARTRIDGE	1	PZ	TR1096A0	TEMPERATUR E PROBE NTC 150 L=1500	1	PZ	VI1220A1	4,2X12 TCB SELF-TAPPIN G SCREW	2	PZ																			
Code	Description	Qty	UOM																																														
GN1120A0	NTC TEMPERATUR E PROBE SEAL	1	PZ																																														
GN1120A1	NTC TEMPERATUR E PROBE SEAL	1	PZ																																														
GN1285A0	NTC TEMPERATUR E PROBE SEALING	2	PZ																																														
SL1045A0	S57 BLACK SILICONE - 80ML CARTRIDGE	1	PZ																																														
TR1096A0	TEMPERATUR E PROBE NTC 150 L=1500	1	PZ																																														
VI1220A1	4,2X12 TCB SELF-TAPPIN G SCREW	2	PZ																																														



COMPONENT			SPARE PART																																			
Code	Description	Image	Code	Description	Components list																																	
GN1285A	NTC TEMPERATURE PROBE SEALING		KTR1096A	NTC 150 L=1500 TEMPERATURE PROBE KIT	<table border="1"> <thead> <tr> <th>Code</th> <th>Description</th> <th>Qty</th> <th>UOM</th> </tr> </thead> <tbody> <tr> <td>VM1465A0</td> <td>CHEFTOP TEMPERATUR E PROBE COVER</td> <td>1</td> <td>PZ</td> </tr> <tr> <td>VM1465A1</td> <td>CT BT TEMPERATUR E PROBE COVER</td> <td>1</td> <td>PZ</td> </tr> </tbody> </table>	Code	Description	Qty	UOM	VM1465A0	CHEFTOP TEMPERATUR E PROBE COVER	1	PZ	VM1465A1	CT BT TEMPERATUR E PROBE COVER	1	PZ																					
			Code	Description	Qty	UOM																																
			VM1465A0	CHEFTOP TEMPERATUR E PROBE COVER	1	PZ																																
VM1465A1	CT BT TEMPERATUR E PROBE COVER	1	PZ																																			
KTR1095A	NTC 150 L=1050 TEMPERATURE PROBE KIT	<table border="1"> <thead> <tr> <th>Code</th> <th>Description</th> <th>Qty</th> <th>UOM</th> </tr> </thead> <tbody> <tr> <td>GN1120A0</td> <td>NTC TEMPERATUR E PROBE SEAL</td> <td>1</td> <td>PZ</td> </tr> <tr> <td>GN1120A1</td> <td>NTC TEMPERATUR E PROBE SEAL</td> <td>1</td> <td>PZ</td> </tr> <tr> <td>GN1285A0</td> <td>NTC TEMPERATUR E PROBE SEALING</td> <td>1</td> <td>PZ</td> </tr> <tr> <td>SL1045A0</td> <td>S57 BLACK SILICONE - 80ML CARTRIDGE</td> <td>1</td> <td>PZ</td> </tr> <tr> <td>TR1095A0</td> <td>TEMPERATUR E PROBE NTC 150 L=1050</td> <td>1</td> <td>PZ</td> </tr> <tr> <td>VI1220A1</td> <td>4,2X12 TCB SELF-TAPPIN G SCREW</td> <td>2</td> <td>PZ</td> </tr> <tr> <td>VM1465A0</td> <td>CHEFTOP TEMPERATUR E PROBE COVER</td> <td>1</td> <td>PZ</td> </tr> <tr> <td>VM1465A1</td> <td>CT BT TEMPERATUR E PROBE COVER</td> <td>1</td> <td>PZ</td> </tr> </tbody> </table>	Code	Description	Qty	UOM	GN1120A0	NTC TEMPERATUR E PROBE SEAL	1	PZ	GN1120A1	NTC TEMPERATUR E PROBE SEAL	1	PZ	GN1285A0	NTC TEMPERATUR E PROBE SEALING	1	PZ	SL1045A0	S57 BLACK SILICONE - 80ML CARTRIDGE	1	PZ	TR1095A0	TEMPERATUR E PROBE NTC 150 L=1050	1	PZ	VI1220A1	4,2X12 TCB SELF-TAPPIN G SCREW	2	PZ	VM1465A0	CHEFTOP TEMPERATUR E PROBE COVER	1	PZ	VM1465A1	CT BT TEMPERATUR E PROBE COVER	1	PZ
Code	Description	Qty	UOM																																			
GN1120A0	NTC TEMPERATUR E PROBE SEAL	1	PZ																																			
GN1120A1	NTC TEMPERATUR E PROBE SEAL	1	PZ																																			
GN1285A0	NTC TEMPERATUR E PROBE SEALING	1	PZ																																			
SL1045A0	S57 BLACK SILICONE - 80ML CARTRIDGE	1	PZ																																			
TR1095A0	TEMPERATUR E PROBE NTC 150 L=1050	1	PZ																																			
VI1220A1	4,2X12 TCB SELF-TAPPIN G SCREW	2	PZ																																			
VM1465A0	CHEFTOP TEMPERATUR E PROBE COVER	1	PZ																																			
VM1465A1	CT BT TEMPERATUR E PROBE COVER	1	PZ																																			
KTR1002A	PT100 L1000 UL TEMPERATURE PROBE KIT	<table border="1"> <thead> <tr> <th>Code</th> <th>Description</th> <th>Qty</th> <th>UOM</th> </tr> </thead> <tbody> <tr> <td>GN1285A0</td> <td>NTC TEMPERATUR E PROBE SEALING</td> <td>2</td> <td>PZ</td> </tr> <tr> <td>SL1045A0</td> <td>S57 BLACK SILICONE - 80ML CARTRIDGE</td> <td>1</td> <td>PZ</td> </tr> <tr> <td>TR1002A1</td> <td></td> <td>1</td> <td>PZ</td> </tr> <tr> <td>VI1220A1</td> <td>4,2X12 TCB SELF-TAPPIN G SCREW</td> <td>2</td> <td>PZ</td> </tr> </tbody> </table>	Code	Description	Qty	UOM	GN1285A0	NTC TEMPERATUR E PROBE SEALING	2	PZ	SL1045A0	S57 BLACK SILICONE - 80ML CARTRIDGE	1	PZ	TR1002A1		1	PZ	VI1220A1	4,2X12 TCB SELF-TAPPIN G SCREW	2	PZ																
Code	Description	Qty	UOM																																			
GN1285A0	NTC TEMPERATUR E PROBE SEALING	2	PZ																																			
SL1045A0	S57 BLACK SILICONE - 80ML CARTRIDGE	1	PZ																																			
TR1002A1		1	PZ																																			
VI1220A1	4,2X12 TCB SELF-TAPPIN G SCREW	2	PZ																																			



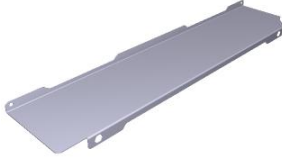





COMPONENT			SPARE PART																																		
Code	Description	Image	Code	Description	Components list																																
GN1285A	NTC TEMPERATURE PROBE SEALING		KTR1002A	PT100 L1000 UL TEMPERATURE PROBE KIT	<table border="1"> <thead> <tr> <th>Code</th> <th>Description</th> <th>Qty</th> <th>UOM</th> </tr> </thead> <tbody> <tr> <td>VM1465A0</td> <td>CHEFTOP TEMPERATUR E PROBE COVER</td> <td>1</td> <td>PZ</td> </tr> <tr> <td>VM1465A1</td> <td>CT BT TEMPERATUR E PROBE COVER</td> <td>1</td> <td>PZ</td> </tr> </tbody> </table>	Code	Description	Qty	UOM	VM1465A0	CHEFTOP TEMPERATUR E PROBE COVER	1	PZ	VM1465A1	CT BT TEMPERATUR E PROBE COVER	1	PZ																				
Code	Description	Qty	UOM																																		
VM1465A0	CHEFTOP TEMPERATUR E PROBE COVER	1	PZ																																		
VM1465A1	CT BT TEMPERATUR E PROBE COVER	1	PZ																																		
VM1464A	CT BT TEMPERATURE PROBE COVER		KVM1464A	CT BT TEMPERATURE PROBE COVER KIT	<table border="1"> <thead> <tr> <th>Code</th> <th>Description</th> <th>Qty</th> <th>UOM</th> </tr> </thead> <tbody> <tr> <td>VM1224A0</td> <td>65MY 220MM 2 COLOURS SHRINK TUBE</td> <td>0.150</td> <td>M</td> </tr> <tr> <td>VM1464A1</td> <td>CT BT TEMPERATUR E PROBE COVER</td> <td>1</td> <td>PZ</td> </tr> </tbody> </table>	Code	Description	Qty	UOM	VM1224A0	65MY 220MM 2 COLOURS SHRINK TUBE	0.150	M	VM1464A1	CT BT TEMPERATUR E PROBE COVER	1	PZ																				
Code	Description	Qty	UOM																																		
VM1224A0	65MY 220MM 2 COLOURS SHRINK TUBE	0.150	M																																		
VM1464A1	CT BT TEMPERATUR E PROBE COVER	1	PZ																																		
TR1106B			KTR1106B	MIND.MAPS L2000 CHAMBER TEMP. PROBE KIT	<table border="1"> <thead> <tr> <th>Code</th> <th>Description</th> <th>Qty</th> <th>UOM</th> </tr> </thead> <tbody> <tr> <td>GN1285A0</td> <td>NTC TEMPERATUR E PROBE SEALING</td> <td>1</td> <td>PZ</td> </tr> <tr> <td>SL1045A0</td> <td>S57 BLACK SILICONE - 80ML CARTRIDGE</td> <td>1</td> <td>PZ</td> </tr> <tr> <td>TR1106B0</td> <td></td> <td>1</td> <td>PZ</td> </tr> <tr> <td>VI1220A1</td> <td>4,2X12 TCB SELF-TAPPIN G SCREW</td> <td>2</td> <td>PZ</td> </tr> <tr> <td>VM1464A1</td> <td>CT BT TEMPERATUR E PROBE COVER</td> <td>1</td> <td>PZ</td> </tr> <tr> <td>VM1465A0</td> <td>CHEFTOP TEMPERATUR E PROBE COVER</td> <td>1</td> <td>PZ</td> </tr> <tr> <td>VM1465A1</td> <td>CT BT TEMPERATUR E PROBE COVER</td> <td>1</td> <td>PZ</td> </tr> </tbody> </table>	Code	Description	Qty	UOM	GN1285A0	NTC TEMPERATUR E PROBE SEALING	1	PZ	SL1045A0	S57 BLACK SILICONE - 80ML CARTRIDGE	1	PZ	TR1106B0		1	PZ	VI1220A1	4,2X12 TCB SELF-TAPPIN G SCREW	2	PZ	VM1464A1	CT BT TEMPERATUR E PROBE COVER	1	PZ	VM1465A0	CHEFTOP TEMPERATUR E PROBE COVER	1	PZ	VM1465A1	CT BT TEMPERATUR E PROBE COVER	1	PZ
Code	Description	Qty	UOM																																		
GN1285A0	NTC TEMPERATUR E PROBE SEALING	1	PZ																																		
SL1045A0	S57 BLACK SILICONE - 80ML CARTRIDGE	1	PZ																																		
TR1106B0		1	PZ																																		
VI1220A1	4,2X12 TCB SELF-TAPPIN G SCREW	2	PZ																																		
VM1464A1	CT BT TEMPERATUR E PROBE COVER	1	PZ																																		
VM1465A0	CHEFTOP TEMPERATUR E PROBE COVER	1	PZ																																		
VM1465A1	CT BT TEMPERATUR E PROBE COVER	1	PZ																																		
0H7320A	6 S. VENTURI PIPE SUPPORT		0H7320A0	6 S. VENTURI PIPE SUPPORT																																	



COMPONENT			SPARE PART																														
Code	Description	Image	Code	Description	Components list																												
SN1031A			KSN1031A	SINGLE POINT CORE PROBE KIT L2000	<table border="1"> <thead> <tr> <th>Code</th> <th>Description</th> <th>Qty</th> <th>UOM</th> </tr> </thead> <tbody> <tr> <td>0H7030A0</td> <td>THERMOSTAT BULB INLET COVER</td> <td>1</td> <td>PZ</td> </tr> <tr> <td>GN1632A0</td> <td>CORE PROBE INLET HOLDING GASKET</td> <td>1</td> <td>PZ</td> </tr> <tr> <td>SL1045A0</td> <td>S57 BLACK SILICONE - 80ML CARTRIDGE</td> <td>1</td> <td>PZ</td> </tr> <tr> <td>SN1031A0</td> <td></td> <td>1</td> <td>PZ</td> </tr> <tr> <td>VI1220A1</td> <td>4,2X12 TCB SELF-TAPPIN G SCREW</td> <td>3</td> <td>PZ</td> </tr> </tbody> </table>	Code	Description	Qty	UOM	0H7030A0	THERMOSTAT BULB INLET COVER	1	PZ	GN1632A0	CORE PROBE INLET HOLDING GASKET	1	PZ	SL1045A0	S57 BLACK SILICONE - 80ML CARTRIDGE	1	PZ	SN1031A0		1	PZ	VI1220A1	4,2X12 TCB SELF-TAPPIN G SCREW	3	PZ				
Code	Description	Qty	UOM																														
0H7030A0	THERMOSTAT BULB INLET COVER	1	PZ																														
GN1632A0	CORE PROBE INLET HOLDING GASKET	1	PZ																														
SL1045A0	S57 BLACK SILICONE - 80ML CARTRIDGE	1	PZ																														
SN1031A0		1	PZ																														
VI1220A1	4,2X12 TCB SELF-TAPPIN G SCREW	3	PZ																														
0G1593A			OUTOFPRODUCTIO	ITEM OUT OF PRODUCTION																													
VE1550A	5X3 MM NEODYMIUM MAGNET		KPE1710B	MOTOR REVOLUTIONS SENSOR KIT	<table border="1"> <thead> <tr> <th>Code</th> <th>Description</th> <th>Qty</th> <th>UOM</th> </tr> </thead> <tbody> <tr> <td>CE1119A0</td> <td>AMPMODU2 4P 4XAWG22 L1500 RAST 4P CABLE</td> <td>1</td> <td>PZ</td> </tr> <tr> <td>PE1040A0</td> <td>RAST MOTOR SENSOR</td> <td>1</td> <td>PZ</td> </tr> <tr> <td>PE1710B0</td> <td>MOTOR REVOLUTION AND DIRECTION SENSOR</td> <td>1</td> <td>PZ</td> </tr> <tr> <td>VE1550A0</td> <td>5X3 MM NEODYMIUM MAGNET</td> <td>1</td> <td>PZ</td> </tr> <tr> <td>VI1966A0</td> <td>M4X14 FLATHEAD SCREW</td> <td>1</td> <td>PZ</td> </tr> <tr> <td>VM1635A0</td> <td>MAGNET HOLDING DIS</td> <td>1</td> <td>PZ</td> </tr> </tbody> </table>	Code	Description	Qty	UOM	CE1119A0	AMPMODU2 4P 4XAWG22 L1500 RAST 4P CABLE	1	PZ	PE1040A0	RAST MOTOR SENSOR	1	PZ	PE1710B0	MOTOR REVOLUTION AND DIRECTION SENSOR	1	PZ	VE1550A0	5X3 MM NEODYMIUM MAGNET	1	PZ	VI1966A0	M4X14 FLATHEAD SCREW	1	PZ	VM1635A0	MAGNET HOLDING DIS	1	PZ
Code	Description	Qty	UOM																														
CE1119A0	AMPMODU2 4P 4XAWG22 L1500 RAST 4P CABLE	1	PZ																														
PE1040A0	RAST MOTOR SENSOR	1	PZ																														
PE1710B0	MOTOR REVOLUTION AND DIRECTION SENSOR	1	PZ																														
VE1550A0	5X3 MM NEODYMIUM MAGNET	1	PZ																														
VI1966A0	M4X14 FLATHEAD SCREW	1	PZ																														
VM1635A0	MAGNET HOLDING DIS	1	PZ																														

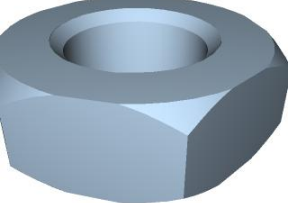

COMPONENT			SPARE PART																														
Code	Description	Image	Code	Description	Components list																												
PE1710B	MOTOR REVOLUTION AND DIRECTION SENSO		KPE1710B	MOTOR REVOLUTIONS SENSOR KIT	<table border="1"> <thead> <tr> <th>Code</th> <th>Description</th> <th>Qty</th> <th>UOM</th> </tr> </thead> <tbody> <tr> <td>CE1119A0</td> <td>AMPMODU2 4P 4XAWG22 L1500 RAST 4P CABLE</td> <td>1</td> <td>PZ</td> </tr> <tr> <td>PE1040A0</td> <td>RAST MOTOR SENSOR</td> <td>1</td> <td>PZ</td> </tr> <tr> <td>PE1710B0</td> <td>MOTOR REVOLUTION AND DIRECTION SENSOR</td> <td>1</td> <td>PZ</td> </tr> <tr> <td>VE1550A0</td> <td>5X3 MM NEODYMIUM MAGNET</td> <td>1</td> <td>PZ</td> </tr> <tr> <td>VI1966A0</td> <td>M4X14 FLATHEAD SCREW</td> <td>1</td> <td>PZ</td> </tr> <tr> <td>VM1635A0</td> <td>MAGNET HOLDING DIS</td> <td>1</td> <td>PZ</td> </tr> </tbody> </table>	Code	Description	Qty	UOM	CE1119A0	AMPMODU2 4P 4XAWG22 L1500 RAST 4P CABLE	1	PZ	PE1040A0	RAST MOTOR SENSOR	1	PZ	PE1710B0	MOTOR REVOLUTION AND DIRECTION SENSOR	1	PZ	VE1550A0	5X3 MM NEODYMIUM MAGNET	1	PZ	VI1966A0	M4X14 FLATHEAD SCREW	1	PZ	VM1635A0	MAGNET HOLDING DIS	1	PZ
Code	Description	Qty	UOM																														
CE1119A0	AMPMODU2 4P 4XAWG22 L1500 RAST 4P CABLE	1	PZ																														
PE1040A0	RAST MOTOR SENSOR	1	PZ																														
PE1710B0	MOTOR REVOLUTION AND DIRECTION SENSOR	1	PZ																														
VE1550A0	5X3 MM NEODYMIUM MAGNET	1	PZ																														
VI1966A0	M4X14 FLATHEAD SCREW	1	PZ																														
VM1635A0	MAGNET HOLDING DIS	1	PZ																														
GN1531A	THERMOSTAT BULB INLET SEALING		KTR1136A	330 °C SAFETY THERMOSTAT KIT	<table border="1"> <thead> <tr> <th>Code</th> <th>Description</th> <th>Qty</th> <th>UOM</th> </tr> </thead> <tbody> <tr> <td>0H7030A0</td> <td>THERMOSTAT BULB INLET COVER</td> <td>1</td> <td>PZ</td> </tr> <tr> <td>GN1531A0</td> <td>THERMOSTAT BULB INLET SEALING</td> <td>1</td> <td>PZ</td> </tr> <tr> <td>MOV0011A0</td> <td>HOOD RING GASKET GN1110A2</td> <td>0.100</td> <td>PZ</td> </tr> <tr> <td>SL1045A0</td> <td>S57 BLACK SILICONE - 80ML CARTRIDGE</td> <td>1</td> <td>PZ</td> </tr> <tr> <td>TR1136A0</td> <td>330 °C 1 POLE SAFETY THERMOSTAT</td> <td>1</td> <td>PZ</td> </tr> <tr> <td>VI1220A1</td> <td>4,2X12 TCB SELF-TAPPIN G SCREW</td> <td>3</td> <td>PZ</td> </tr> </tbody> </table>	Code	Description	Qty	UOM	0H7030A0	THERMOSTAT BULB INLET COVER	1	PZ	GN1531A0	THERMOSTAT BULB INLET SEALING	1	PZ	MOV0011A0	HOOD RING GASKET GN1110A2	0.100	PZ	SL1045A0	S57 BLACK SILICONE - 80ML CARTRIDGE	1	PZ	TR1136A0	330 °C 1 POLE SAFETY THERMOSTAT	1	PZ	VI1220A1	4,2X12 TCB SELF-TAPPIN G SCREW	3	PZ
Code	Description	Qty	UOM																														
0H7030A0	THERMOSTAT BULB INLET COVER	1	PZ																														
GN1531A0	THERMOSTAT BULB INLET SEALING	1	PZ																														
MOV0011A0	HOOD RING GASKET GN1110A2	0.100	PZ																														
SL1045A0	S57 BLACK SILICONE - 80ML CARTRIDGE	1	PZ																														
TR1136A0	330 °C 1 POLE SAFETY THERMOSTAT	1	PZ																														
VI1220A1	4,2X12 TCB SELF-TAPPIN G SCREW	3	PZ																														
0H7030A	THERMOSTAT BULB INLET COVER		K0H7030A	THERMOSTAT BULB INLET COVER KIT	<table border="1"> <thead> <tr> <th>Code</th> <th>Description</th> <th>Qty</th> <th>UOM</th> </tr> </thead> <tbody> <tr> <td>0H7030A0</td> <td>THERMOSTAT BULB INLET COVER</td> <td>1</td> <td>PZ</td> </tr> <tr> <td>VM1224A0</td> <td>65MY 220MM 2 COLOURS SHRINK TUBE</td> <td>0.200</td> <td>M</td> </tr> </tbody> </table>	Code	Description	Qty	UOM	0H7030A0	THERMOSTAT BULB INLET COVER	1	PZ	VM1224A0	65MY 220MM 2 COLOURS SHRINK TUBE	0.200	M																
Code	Description	Qty	UOM																														
0H7030A0	THERMOSTAT BULB INLET COVER	1	PZ																														
VM1224A0	65MY 220MM 2 COLOURS SHRINK TUBE	0.200	M																														



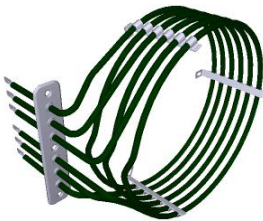

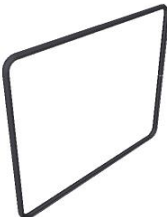
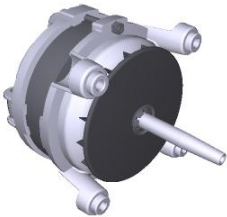
COMPONENT			SPARE PART																										
Code	Description	Image	Code	Description	Components list																								
RS1215B	1 TURN 147W 105V FLAT ELEMENT		KRS1215B	147W MOTOR BRAKING ELEMENT KIT	<table border="1"> <thead> <tr> <th>Code</th> <th>Description</th> <th>Qty</th> <th>UOM</th> </tr> </thead> <tbody> <tr> <td>GN1672A1</td> <td>RS1274A ELEMENT GASKET</td> <td>1</td> <td>PZ</td> </tr> <tr> <td>MOV0009A0</td> <td>HOOD RING GASKET GN1110A2</td> <td>0.100</td> <td>PZ</td> </tr> <tr> <td>RS1215B0</td> <td>1 TURN 147W 105V FLAT ELEMENT</td> <td>1</td> <td>PZ</td> </tr> <tr> <td>SL1045A0</td> <td>S57 BLACK SILICONE - 80ML CARTRIDGE</td> <td>1</td> <td>PZ</td> </tr> <tr> <td>VI1220A1</td> <td>4,2X12 TCB SELF-TAPPIN G SCREW</td> <td>2</td> <td>PZ</td> </tr> </tbody> </table>	Code	Description	Qty	UOM	GN1672A1	RS1274A ELEMENT GASKET	1	PZ	MOV0009A0	HOOD RING GASKET GN1110A2	0.100	PZ	RS1215B0	1 TURN 147W 105V FLAT ELEMENT	1	PZ	SL1045A0	S57 BLACK SILICONE - 80ML CARTRIDGE	1	PZ	VI1220A1	4,2X12 TCB SELF-TAPPIN G SCREW	2	PZ
			Code	Description	Qty	UOM																							
GN1672A1	RS1274A ELEMENT GASKET	1	PZ																										
MOV0009A0	HOOD RING GASKET GN1110A2	0.100	PZ																										
RS1215B0	1 TURN 147W 105V FLAT ELEMENT	1	PZ																										
SL1045A0	S57 BLACK SILICONE - 80ML CARTRIDGE	1	PZ																										
VI1220A1	4,2X12 TCB SELF-TAPPIN G SCREW	2	PZ																										
KRS0026A	BIG-L 147W MOTOR BRAKING ELEMENT KIT	<table border="1"> <thead> <tr> <th>Code</th> <th>Description</th> <th>Qty</th> <th>UOM</th> </tr> </thead> <tbody> <tr> <td>GN1672A0</td> <td></td> <td>1</td> <td>PZ</td> </tr> <tr> <td>GN1672A1</td> <td>RS1274A ELEMENT GASKET</td> <td>1</td> <td>PZ</td> </tr> <tr> <td>RS1215A1</td> <td>147W 105V BRAKING ELEMENT</td> <td>1</td> <td>PZ</td> </tr> <tr> <td>SL1045A0</td> <td>S57 BLACK SILICONE - 80ML CARTRIDGE</td> <td>1</td> <td>PZ</td> </tr> <tr> <td>VI1220A1</td> <td>4,2X12 TCB SELF-TAPPIN G SCREW</td> <td>2</td> <td>PZ</td> </tr> </tbody> </table>	Code	Description	Qty	UOM	GN1672A0		1	PZ	GN1672A1	RS1274A ELEMENT GASKET	1	PZ	RS1215A1	147W 105V BRAKING ELEMENT	1	PZ	SL1045A0	S57 BLACK SILICONE - 80ML CARTRIDGE	1	PZ	VI1220A1	4,2X12 TCB SELF-TAPPIN G SCREW	2	PZ			
Code	Description	Qty	UOM																										
GN1672A0		1	PZ																										
GN1672A1	RS1274A ELEMENT GASKET	1	PZ																										
RS1215A1	147W 105V BRAKING ELEMENT	1	PZ																										
SL1045A0	S57 BLACK SILICONE - 80ML CARTRIDGE	1	PZ																										
VI1220A1	4,2X12 TCB SELF-TAPPIN G SCREW	2	PZ																										
GN1672A	RS1274A ELEMENT GASKET		KG1672A	71X19 HEATING ELEMENT GASKET 5 PCS KIT	<table border="1"> <thead> <tr> <th>Code</th> <th>Description</th> <th>Qty</th> <th>UOM</th> </tr> </thead> <tbody> <tr> <td>GN1672A0</td> <td></td> <td>5</td> <td>PZ</td> </tr> <tr> <td>GN1672A1</td> <td>RS1274A ELEMENT GASKET</td> <td>5</td> <td>PZ</td> </tr> <tr> <td>VM1224A0</td> <td>65MY 220MM 2 COLOURS SHRINK TUBE</td> <td>0.250</td> <td>M</td> </tr> </tbody> </table>	Code	Description	Qty	UOM	GN1672A0		5	PZ	GN1672A1	RS1274A ELEMENT GASKET	5	PZ	VM1224A0	65MY 220MM 2 COLOURS SHRINK TUBE	0.250	M								
Code	Description	Qty	UOM																										
GN1672A0		5	PZ																										
GN1672A1	RS1274A ELEMENT GASKET	5	PZ																										
VM1224A0	65MY 220MM 2 COLOURS SHRINK TUBE	0.250	M																										
RS1274B	1 TURN 100W 60V FLAT ELEMENT		KRS1274B	100W MOTOR BRAKING ELEMENT KIT	<table border="1"> <thead> <tr> <th>Code</th> <th>Description</th> <th>Qty</th> <th>UOM</th> </tr> </thead> <tbody> <tr> <td>GN1672A1</td> <td>RS1274A ELEMENT GASKET</td> <td>1</td> <td>PZ</td> </tr> <tr> <td>MOV0009A0</td> <td>HOOD RING GASKET GN1110A2</td> <td>0.100</td> <td>PZ</td> </tr> <tr> <td>RS1274B0</td> <td>1 TURN 100W 60V FLAT ELEMENT</td> <td>1</td> <td>PZ</td> </tr> </tbody> </table>	Code	Description	Qty	UOM	GN1672A1	RS1274A ELEMENT GASKET	1	PZ	MOV0009A0	HOOD RING GASKET GN1110A2	0.100	PZ	RS1274B0	1 TURN 100W 60V FLAT ELEMENT	1	PZ								
			Code	Description	Qty	UOM																							
GN1672A1	RS1274A ELEMENT GASKET	1	PZ																										
MOV0009A0	HOOD RING GASKET GN1110A2	0.100	PZ																										
RS1274B0	1 TURN 100W 60V FLAT ELEMENT	1	PZ																										

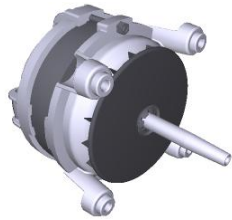
COMPONENT			SPARE PART																		
Code	Description	Image	Code	Description	Components list																
RS1274B	1 TURN 100W 60V FLAT ELEMENT		KRS1274B	100W MOTOR BRAKING ELEMENT KIT	<table border="1"> <thead> <tr> <th>Code</th> <th>Description</th> <th>Qty</th> <th>UOM</th> </tr> </thead> <tbody> <tr> <td>SL1045A0</td> <td>S57 BLACK SILICONE - 80ML CARTRIDGE</td> <td>1</td> <td>PZ</td> </tr> <tr> <td>V11220A1</td> <td>4,2X12 TCB SELF-TAPPIN G SCREW</td> <td>2</td> <td>PZ</td> </tr> </tbody> </table>	Code	Description	Qty	UOM	SL1045A0	S57 BLACK SILICONE - 80ML CARTRIDGE	1	PZ	V11220A1	4,2X12 TCB SELF-TAPPIN G SCREW	2	PZ				
Code	Description	Qty	UOM																		
SL1045A0	S57 BLACK SILICONE - 80ML CARTRIDGE	1	PZ																		
V11220A1	4,2X12 TCB SELF-TAPPIN G SCREW	2	PZ																		
GN1672A	RS1274A ELEMENT GASKET		KG1672A	71X19 HEATING ELEMENT GASKET 5 PCS KIT	<table border="1"> <thead> <tr> <th>Code</th> <th>Description</th> <th>Qty</th> <th>UOM</th> </tr> </thead> <tbody> <tr> <td>GN1672A0</td> <td></td> <td>5</td> <td>PZ</td> </tr> <tr> <td>GN1672A1</td> <td>RS1274A ELEMENT GASKET</td> <td>5</td> <td>PZ</td> </tr> <tr> <td>VM1224A0</td> <td>65MY 220MM 2 COLOURS SHRINK TUBE</td> <td>0.250</td> <td>M</td> </tr> </tbody> </table>	Code	Description	Qty	UOM	GN1672A0		5	PZ	GN1672A1	RS1274A ELEMENT GASKET	5	PZ	VM1224A0	65MY 220MM 2 COLOURS SHRINK TUBE	0.250	M
Code	Description	Qty	UOM																		
GN1672A0		5	PZ																		
GN1672A1	RS1274A ELEMENT GASKET	5	PZ																		
VM1224A0	65MY 220MM 2 COLOURS SHRINK TUBE	0.250	M																		
RC1170A	STAINLESS STEEL NUT M14 H=8 CH=22		KRC1170A	M14 H8 CH22 NUT - 10 PCS. KIT	<table border="1"> <thead> <tr> <th>Code</th> <th>Description</th> <th>Qty</th> <th>UOM</th> </tr> </thead> <tbody> <tr> <td>RC1170A1</td> <td>STAINLESS STEEL NUT M14 H=8 CH=2</td> <td>10</td> <td>PZ</td> </tr> <tr> <td>VM1224A0</td> <td>65MY 220MM 2 COLOURS SHRINK TUBE</td> <td>0.200</td> <td>M</td> </tr> </tbody> </table>	Code	Description	Qty	UOM	RC1170A1	STAINLESS STEEL NUT M14 H=8 CH=2	10	PZ	VM1224A0	65MY 220MM 2 COLOURS SHRINK TUBE	0.200	M				
Code	Description	Qty	UOM																		
RC1170A1	STAINLESS STEEL NUT M14 H=8 CH=2	10	PZ																		
VM1224A0	65MY 220MM 2 COLOURS SHRINK TUBE	0.200	M																		
TB2937B	XEBC EXTERNAL WATER PIPE D10+CONNECTION		TB2937B0	XEBC EXTERNAL WATER PIPE D10+CONNECTION																	
0H7030A	THERMOSTAT BULB INLET COVER		K0H7030A	THERMOSTAT BULB INLET COVER KIT	<table border="1"> <thead> <tr> <th>Code</th> <th>Description</th> <th>Qty</th> <th>UOM</th> </tr> </thead> <tbody> <tr> <td>0H7030A0</td> <td>THERMOSTAT BULB INLET COVER</td> <td>1</td> <td>PZ</td> </tr> <tr> <td>VM1224A0</td> <td>65MY 220MM 2 COLOURS SHRINK TUBE</td> <td>0.200</td> <td>M</td> </tr> </tbody> </table>	Code	Description	Qty	UOM	0H7030A0	THERMOSTAT BULB INLET COVER	1	PZ	VM1224A0	65MY 220MM 2 COLOURS SHRINK TUBE	0.200	M				
Code	Description	Qty	UOM																		
0H7030A0	THERMOSTAT BULB INLET COVER	1	PZ																		
VM1224A0	65MY 220MM 2 COLOURS SHRINK TUBE	0.200	M																		

COMPONENT			SPARE PART																																																						
Code	Description	Image	Code	Description	Components list																																																				
GN1632A	CORE PROBE INLET HOLDING GASKET		GN1632A0	CORE PROBE INLET HOLDING GASKET																																																					
RS1225A	4700W 230V D230 6 TURNS HEATING ELEMENT		KRS1225A	4.7KW HEATING ELEMENT KIT	<table border="1"> <thead> <tr> <th>Code</th> <th>Description</th> <th>Qty</th> <th>UOM</th> </tr> </thead> <tbody> <tr> <td>GN1085A2</td> <td>141X24 HEATING ELEMENT GASKET</td> <td>1</td> <td>PZ</td> </tr> <tr> <td>GN1086A0</td> <td>ELEMENT SEALING</td> <td>1</td> <td>PZ</td> </tr> <tr> <td>GN1671A0</td> <td>141X22 G8.5 ELEMENT ARMED GASKET</td> <td>1</td> <td>PZ</td> </tr> <tr> <td>MOV0008A0</td> <td>HOOD RING GASKET GN1110A2</td> <td>0.100</td> <td>PZ</td> </tr> <tr> <td>RS1225A1</td> <td>4700W 230V D230 6 TURNS HEATING ELEMENT</td> <td>1</td> <td>PZ</td> </tr> <tr> <td>SL1045A0</td> <td>S57 BLACK SILICONE - 80ML CARTRIDGE</td> <td>1</td> <td>PZ</td> </tr> <tr> <td>VI1032A0</td> <td>SCREW M4X16 TCB+ INOX</td> <td>1</td> <td>PZ</td> </tr> <tr> <td>VI1075A0</td> <td>NUT M4 H=4 UNI5587 INOX</td> <td>1</td> <td>PZ</td> </tr> <tr> <td>VI1220A1</td> <td>4,2X12 TCB SELF-TAPPING SCREW</td> <td>6</td> <td>PZ</td> </tr> <tr> <td>VI1511A0</td> <td>STAINLESS STEEL WASHER 4.2X12X1</td> <td>1</td> <td>PZ</td> </tr> <tr> <td>VM1794A0</td> <td>250X4.8 PA66 BLACK CLAMP</td> <td>2</td> <td>PZ</td> </tr> <tr> <td>VM2103A0</td> <td>CLAMP LOCK</td> <td>2</td> <td>PZ</td> </tr> </tbody> </table>	Code	Description	Qty	UOM	GN1085A2	141X24 HEATING ELEMENT GASKET	1	PZ	GN1086A0	ELEMENT SEALING	1	PZ	GN1671A0	141X22 G8.5 ELEMENT ARMED GASKET	1	PZ	MOV0008A0	HOOD RING GASKET GN1110A2	0.100	PZ	RS1225A1	4700W 230V D230 6 TURNS HEATING ELEMENT	1	PZ	SL1045A0	S57 BLACK SILICONE - 80ML CARTRIDGE	1	PZ	VI1032A0	SCREW M4X16 TCB+ INOX	1	PZ	VI1075A0	NUT M4 H=4 UNI5587 INOX	1	PZ	VI1220A1	4,2X12 TCB SELF-TAPPING SCREW	6	PZ	VI1511A0	STAINLESS STEEL WASHER 4.2X12X1	1	PZ	VM1794A0	250X4.8 PA66 BLACK CLAMP	2	PZ	VM2103A0	CLAMP LOCK	2	PZ
Code	Description	Qty	UOM																																																						
GN1085A2	141X24 HEATING ELEMENT GASKET	1	PZ																																																						
GN1086A0	ELEMENT SEALING	1	PZ																																																						
GN1671A0	141X22 G8.5 ELEMENT ARMED GASKET	1	PZ																																																						
MOV0008A0	HOOD RING GASKET GN1110A2	0.100	PZ																																																						
RS1225A1	4700W 230V D230 6 TURNS HEATING ELEMENT	1	PZ																																																						
SL1045A0	S57 BLACK SILICONE - 80ML CARTRIDGE	1	PZ																																																						
VI1032A0	SCREW M4X16 TCB+ INOX	1	PZ																																																						
VI1075A0	NUT M4 H=4 UNI5587 INOX	1	PZ																																																						
VI1220A1	4,2X12 TCB SELF-TAPPING SCREW	6	PZ																																																						
VI1511A0	STAINLESS STEEL WASHER 4.2X12X1	1	PZ																																																						
VM1794A0	250X4.8 PA66 BLACK CLAMP	2	PZ																																																						
VM2103A0	CLAMP LOCK	2	PZ																																																						

COMPONENT			SPARE PART																																														
Code	Description	Image	Code	Description	Components list																																												
GN1659A			KGN1659A	06EU-FS/0621 DOOR GASKET KIT	<table border="1"> <thead> <tr> <th>Code</th> <th>Description</th> <th>Qty</th> <th>UOM</th> </tr> </thead> <tbody> <tr> <td>GN1626A0</td> <td>DOUBLE LIP-TYPE FRONT GASKE</td> <td>2.420</td> <td>M</td> </tr> <tr> <td>SL1025A0</td> <td>CLEAR SILICON DOW CORNING 734</td> <td>0.012</td> <td>PZ</td> </tr> <tr> <td>VM1224A0</td> <td>65MY 220MM 2 COLOURS SHRINK TUBE</td> <td>0.450</td> <td>M</td> </tr> <tr> <td>VM2277A0</td> <td>DOOR SEAL KIT INTERNAL CONNECTION</td> <td>1</td> <td>PZ</td> </tr> </tbody> </table>	Code	Description	Qty	UOM	GN1626A0	DOUBLE LIP-TYPE FRONT GASKE	2.420	M	SL1025A0	CLEAR SILICON DOW CORNING 734	0.012	PZ	VM1224A0	65MY 220MM 2 COLOURS SHRINK TUBE	0.450	M	VM2277A0	DOOR SEAL KIT INTERNAL CONNECTION	1	PZ																								
Code	Description	Qty	UOM																																														
GN1626A0	DOUBLE LIP-TYPE FRONT GASKE	2.420	M																																														
SL1025A0	CLEAR SILICON DOW CORNING 734	0.012	PZ																																														
VM1224A0	65MY 220MM 2 COLOURS SHRINK TUBE	0.450	M																																														
VM2277A0	DOOR SEAL KIT INTERNAL CONNECTION	1	PZ																																														
MT1012A	330W 230V MOTOR		KVN1130A	LUX =08.2017/S.5/S.5E 330W MOTOR KIT	<table border="1"> <thead> <tr> <th>Code</th> <th>Description</th> <th>Qty</th> <th>UOM</th> </tr> </thead> <tbody> <tr> <td>0H4305A1</td> <td>ST. STEEL MOTOR SHAFT SEALING DISC</td> <td>1</td> <td>PZ</td> </tr> <tr> <td>GN1140A2</td> <td>MOTOR HOLDER GASKET</td> <td>1</td> <td>PZ</td> </tr> <tr> <td>GN1140A3</td> <td>MOLDED MOTOR HOLDER GASKET</td> <td>1</td> <td>PZ</td> </tr> <tr> <td>VI1045A0</td> <td>16X8,4 TH=1,6 ST.STEEL WASHER</td> <td>1</td> <td>PZ</td> </tr> <tr> <td>VI1256A0</td> <td>M8 DIN 980M ST. STEEL SELF LOCKING NUT</td> <td>1</td> <td>PZ</td> </tr> <tr> <td>VM1794A0</td> <td>250X4.8 PA66 BLACK CLAMP</td> <td>4</td> <td>PZ</td> </tr> <tr> <td>VM2103A0</td> <td>CLAMP LOCK</td> <td>4</td> <td>PZ</td> </tr> <tr> <td>VM2196A0</td> <td>MOTOR NUT FASTENING BUSHING</td> <td>1</td> <td>PZ</td> </tr> <tr> <td>VN1130A1</td> <td>330W 230V 50/60HZ MOTO</td> <td>1</td> <td>PZ</td> </tr> <tr> <td>VN1130A1</td> <td>330W 230V 50/60HZ MOTO</td> <td>1</td> <td>PZ</td> </tr> </tbody> </table>	Code	Description	Qty	UOM	0H4305A1	ST. STEEL MOTOR SHAFT SEALING DISC	1	PZ	GN1140A2	MOTOR HOLDER GASKET	1	PZ	GN1140A3	MOLDED MOTOR HOLDER GASKET	1	PZ	VI1045A0	16X8,4 TH=1,6 ST.STEEL WASHER	1	PZ	VI1256A0	M8 DIN 980M ST. STEEL SELF LOCKING NUT	1	PZ	VM1794A0	250X4.8 PA66 BLACK CLAMP	4	PZ	VM2103A0	CLAMP LOCK	4	PZ	VM2196A0	MOTOR NUT FASTENING BUSHING	1	PZ	VN1130A1	330W 230V 50/60HZ MOTO	1	PZ	VN1130A1	330W 230V 50/60HZ MOTO	1	PZ
Code	Description	Qty	UOM																																														
0H4305A1	ST. STEEL MOTOR SHAFT SEALING DISC	1	PZ																																														
GN1140A2	MOTOR HOLDER GASKET	1	PZ																																														
GN1140A3	MOLDED MOTOR HOLDER GASKET	1	PZ																																														
VI1045A0	16X8,4 TH=1,6 ST.STEEL WASHER	1	PZ																																														
VI1256A0	M8 DIN 980M ST. STEEL SELF LOCKING NUT	1	PZ																																														
VM1794A0	250X4.8 PA66 BLACK CLAMP	4	PZ																																														
VM2103A0	CLAMP LOCK	4	PZ																																														
VM2196A0	MOTOR NUT FASTENING BUSHING	1	PZ																																														
VN1130A1	330W 230V 50/60HZ MOTO	1	PZ																																														
VN1130A1	330W 230V 50/60HZ MOTO	1	PZ																																														
			KMT1012A	MIND.MAPS 330W 230V MOTOR KIT	<table border="1"> <thead> <tr> <th>Code</th> <th>Description</th> <th>Qty</th> <th>UOM</th> </tr> </thead> <tbody> <tr> <td>0H2842A0</td> <td></td> <td>1</td> <td>PZ</td> </tr> <tr> <td>0H4305A1</td> <td>ST. STEEL MOTOR SHAFT SEALING DISC</td> <td>1</td> <td>PZ</td> </tr> <tr> <td>GN1140A2</td> <td>MOTOR HOLDER GASKET</td> <td>1</td> <td>PZ</td> </tr> </tbody> </table>	Code	Description	Qty	UOM	0H2842A0		1	PZ	0H4305A1	ST. STEEL MOTOR SHAFT SEALING DISC	1	PZ	GN1140A2	MOTOR HOLDER GASKET	1	PZ																												
Code	Description	Qty	UOM																																														
0H2842A0		1	PZ																																														
0H4305A1	ST. STEEL MOTOR SHAFT SEALING DISC	1	PZ																																														
GN1140A2	MOTOR HOLDER GASKET	1	PZ																																														

COMPONENT			SPARE PART																																														
Code	Description	Image	Code	Description	Components list																																												
MT1012A	330W 230V MOTOR		KMT1012A	MIND.MAPS 330W 230V MOTOR KIT	<table border="1"> <thead> <tr> <th>Code</th> <th>Description</th> <th>Qty</th> <th>UOM</th> </tr> </thead> <tbody> <tr> <td>GN1140A3</td> <td>MOLDED MOTOR HOLDER GASKET</td> <td>1</td> <td>PZ</td> </tr> <tr> <td>MOV0007A0</td> <td>HOOD RING GASKET GN1110A2</td> <td>0.100</td> <td>PZ</td> </tr> <tr> <td>MT1012A0</td> <td>330W 230V MOTOR</td> <td>1</td> <td>PZ</td> </tr> <tr> <td>VE1550A0</td> <td>5X3 MM NEODYMIUM MAGNET</td> <td>1</td> <td>PZ</td> </tr> <tr> <td>VI1077A1</td> <td>SCREW M6X12 TE INOX</td> <td>1</td> <td>PZ</td> </tr> <tr> <td>VI1521A0</td> <td>STAINLESS STEEL WASHER D=6 6592</td> <td>1</td> <td>PZ</td> </tr> <tr> <td>VI1966A0</td> <td>M4X14 FLATHEAD SCREW</td> <td>1</td> <td>PZ</td> </tr> <tr> <td>VM1635A0</td> <td>MAGNET HOLDING DIS</td> <td>1</td> <td>PZ</td> </tr> <tr> <td>VM1794A0</td> <td>250X4.8 PA66 BLACK CLAMP</td> <td>4</td> <td>PZ</td> </tr> <tr> <td>VM2103A0</td> <td>CLAMP LOCK</td> <td>4</td> <td>PZ</td> </tr> </tbody> </table>	Code	Description	Qty	UOM	GN1140A3	MOLDED MOTOR HOLDER GASKET	1	PZ	MOV0007A0	HOOD RING GASKET GN1110A2	0.100	PZ	MT1012A0	330W 230V MOTOR	1	PZ	VE1550A0	5X3 MM NEODYMIUM MAGNET	1	PZ	VI1077A1	SCREW M6X12 TE INOX	1	PZ	VI1521A0	STAINLESS STEEL WASHER D=6 6592	1	PZ	VI1966A0	M4X14 FLATHEAD SCREW	1	PZ	VM1635A0	MAGNET HOLDING DIS	1	PZ	VM1794A0	250X4.8 PA66 BLACK CLAMP	4	PZ	VM2103A0	CLAMP LOCK	4	PZ
					Code	Description	Qty	UOM																																									
					GN1140A3	MOLDED MOTOR HOLDER GASKET	1	PZ																																									
					MOV0007A0	HOOD RING GASKET GN1110A2	0.100	PZ																																									
					MT1012A0	330W 230V MOTOR	1	PZ																																									
					VE1550A0	5X3 MM NEODYMIUM MAGNET	1	PZ																																									
					VI1077A1	SCREW M6X12 TE INOX	1	PZ																																									
					VI1521A0	STAINLESS STEEL WASHER D=6 6592	1	PZ																																									
					VI1966A0	M4X14 FLATHEAD SCREW	1	PZ																																									
					VM1635A0	MAGNET HOLDING DIS	1	PZ																																									
					VM1794A0	250X4.8 PA66 BLACK CLAMP	4	PZ																																									
					VM2103A0	CLAMP LOCK	4	PZ																																									
					0H4305A	ST. STEEL MOTOR SHAFT SEALING DIS		K0H4305A	SEALING DISC FOR MOTOR SHAFT KIT	<table border="1"> <thead> <tr> <th>Code</th> <th>Description</th> <th>Qty</th> <th>UOM</th> </tr> </thead> <tbody> <tr> <td>0H4305A1</td> <td>ST. STEEL MOTOR SHAFT SEALING DISC</td> <td>1</td> <td>PZ</td> </tr> <tr> <td>GN1140A2</td> <td>MOTOR HOLDER GASKET</td> <td>1</td> <td>PZ</td> </tr> <tr> <td>GN1140A3</td> <td>MOLDED MOTOR HOLDER GASKET</td> <td>1</td> <td>PZ</td> </tr> <tr> <td>SL1045A0</td> <td>S57 BLACK SILICONE - 80ML CARTRIDGE</td> <td>1</td> <td>PZ</td> </tr> <tr> <td>VI1220A1</td> <td>4,2X12 TCB SELF-TAPPIN G SCREW</td> <td>3</td> <td>PZ</td> </tr> </tbody> </table>	Code	Description	Qty	UOM	0H4305A1	ST. STEEL MOTOR SHAFT SEALING DISC	1	PZ	GN1140A2	MOTOR HOLDER GASKET	1	PZ	GN1140A3	MOLDED MOTOR HOLDER GASKET	1	PZ	SL1045A0	S57 BLACK SILICONE - 80ML CARTRIDGE	1	PZ	VI1220A1	4,2X12 TCB SELF-TAPPIN G SCREW	3	PZ															
Code	Description	Qty	UOM																																														
0H4305A1	ST. STEEL MOTOR SHAFT SEALING DISC	1	PZ																																														
GN1140A2	MOTOR HOLDER GASKET	1	PZ																																														
GN1140A3	MOLDED MOTOR HOLDER GASKET	1	PZ																																														
SL1045A0	S57 BLACK SILICONE - 80ML CARTRIDGE	1	PZ																																														
VI1220A1	4,2X12 TCB SELF-TAPPIN G SCREW	3	PZ																																														

COMPONENT			SPARE PART																						
Code	Description	Image	Code	Description	Components list																				
VN1170B	D195 H80 8 BLADES FAN+RING		KVN1170B	D195 H80 8 BLADES FAN + RING KIT	<table border="1"> <thead> <tr> <th>Code</th> <th>Description</th> <th>Qty</th> <th>UOM</th> </tr> </thead> <tbody> <tr> <td>VI1077A1</td> <td>SCREW M6X12 TE INOX</td> <td>1</td> <td>PZ</td> </tr> <tr> <td>VI1521A0</td> <td>STAINLESS STEEL WASHER D=6 6592</td> <td>1</td> <td>PZ</td> </tr> <tr> <td>VN1170B0</td> <td>D195 H80 8 BLADES FAN+RING</td> <td>1</td> <td>PZ</td> </tr> <tr> <td>VN1170B0</td> <td>D195 H80 8 BLADES FAN+RING</td> <td>1</td> <td>PZ</td> </tr> </tbody> </table>	Code	Description	Qty	UOM	VI1077A1	SCREW M6X12 TE INOX	1	PZ	VI1521A0	STAINLESS STEEL WASHER D=6 6592	1	PZ	VN1170B0	D195 H80 8 BLADES FAN+RING	1	PZ	VN1170B0	D195 H80 8 BLADES FAN+RING	1	PZ
					Code	Description	Qty	UOM																	
					VI1077A1	SCREW M6X12 TE INOX	1	PZ																	
					VI1521A0	STAINLESS STEEL WASHER D=6 6592	1	PZ																	
VN1170B0	D195 H80 8 BLADES FAN+RING	1	PZ																						
VN1170B0	D195 H80 8 BLADES FAN+RING	1	PZ																						
<table border="1"> <thead> <tr> <th>Code</th> <th>Description</th> <th>Qty</th> <th>UOM</th> </tr> </thead> <tbody> <tr> <td>GN1140A2</td> <td>MOTOR HOLDER GASKET</td> <td>5</td> <td>PZ</td> </tr> <tr> <td>GN1140A3</td> <td>MOLDED MOTOR HOLDER GASKET</td> <td>5</td> <td>PZ</td> </tr> <tr> <td>VM1224A0</td> <td>65MY 220MM 2 COLOURS SHRINK TUBE</td> <td>0.200</td> <td>M</td> </tr> </tbody> </table>	Code	Description	Qty	UOM	GN1140A2	MOTOR HOLDER GASKET	5	PZ	GN1140A3	MOLDED MOTOR HOLDER GASKET	5	PZ	VM1224A0	65MY 220MM 2 COLOURS SHRINK TUBE	0.200	M									
Code	Description	Qty	UOM																						
GN1140A2	MOTOR HOLDER GASKET	5	PZ																						
GN1140A3	MOLDED MOTOR HOLDER GASKET	5	PZ																						
VM1224A0	65MY 220MM 2 COLOURS SHRINK TUBE	0.200	M																						
GN1140A	MOLDED MOTOR HOLDER GASKET		KGN1140A	5 PCS. MOTOR HOLDER GASKET KI																					
0H7170A	MM MOTOR GLASS WOOL PLATE		0H7170A0	MM MOTOR GLASS WOOL PLATE																					
0G1586A	XEBC-06EU-E COMPLETE FAN GUARD		K0G1586A	XEBC-06EU-E ONE COMPLETE FAN GUARD KIT	<table border="1"> <thead> <tr> <th>Code</th> <th>Description</th> <th>Qty</th> <th>UOM</th> </tr> </thead> <tbody> <tr> <td>0G1586A0</td> <td>XEBC-06EU-E COMPLETE FAN GUARD</td> <td>1</td> <td>PZ</td> </tr> <tr> <td>IP1385A1</td> <td>CORNER POLYSTYREN E PACKING 110X80X2000</td> <td>2</td> <td>M</td> </tr> </tbody> </table>	Code	Description	Qty	UOM	0G1586A0	XEBC-06EU-E COMPLETE FAN GUARD	1	PZ	IP1385A1	CORNER POLYSTYREN E PACKING 110X80X2000	2	M								
Code	Description	Qty	UOM																						
0G1586A0	XEBC-06EU-E COMPLETE FAN GUARD	1	PZ																						
IP1385A1	CORNER POLYSTYREN E PACKING 110X80X2000	2	M																						



COMPONENT			SPARE PART																		
Code	Description	Image	Code	Description	Components list																
TB2982A	XEBC-06EU-E LOWER HUMIDITY PIPE		TB2982A0	XEBC-06EU-E LOWER HUMIDITY PIPE																	
VM2251A	STEAM WATER INLET UPPER DISTRIBUTOR		KVM2251A	STEAM WATER INLET UP+LO DISTRIBUTORS KIT	<table border="1"> <thead> <tr> <th>Code</th> <th>Description</th> <th>Qty</th> <th>UOM</th> </tr> </thead> <tbody> <tr> <td>VM1224A0</td> <td>65MY 220MM 2 COLOURS SHRINK TUBE</td> <td>0.150</td> <td>M</td> </tr> <tr> <td>VM2251A0</td> <td>STEAM WATER INLET UPPER DISTRIBUTOR</td> <td>1</td> <td>PZ</td> </tr> <tr> <td>VM2252A0</td> <td>STEAM WATER INLET LOWER DISTRIBUTOR</td> <td>1</td> <td>PZ</td> </tr> </tbody> </table>	Code	Description	Qty	UOM	VM1224A0	65MY 220MM 2 COLOURS SHRINK TUBE	0.150	M	VM2251A0	STEAM WATER INLET UPPER DISTRIBUTOR	1	PZ	VM2252A0	STEAM WATER INLET LOWER DISTRIBUTOR	1	PZ
Code	Description	Qty	UOM																		
VM1224A0	65MY 220MM 2 COLOURS SHRINK TUBE	0.150	M																		
VM2251A0	STEAM WATER INLET UPPER DISTRIBUTOR	1	PZ																		
VM2252A0	STEAM WATER INLET LOWER DISTRIBUTOR	1	PZ																		
VM2252A	STEAM WATER INLET LOWER DISTRIBUTOR		KVM2251A	STEAM WATER INLET UP+LO DISTRIBUTORS KIT	<table border="1"> <thead> <tr> <th>Code</th> <th>Description</th> <th>Qty</th> <th>UOM</th> </tr> </thead> <tbody> <tr> <td>VM1224A0</td> <td>65MY 220MM 2 COLOURS SHRINK TUBE</td> <td>0.150</td> <td>M</td> </tr> <tr> <td>VM2251A0</td> <td>STEAM WATER INLET UPPER DISTRIBUTOR</td> <td>1</td> <td>PZ</td> </tr> <tr> <td>VM2252A0</td> <td>STEAM WATER INLET LOWER DISTRIBUTOR</td> <td>1</td> <td>PZ</td> </tr> </tbody> </table>	Code	Description	Qty	UOM	VM1224A0	65MY 220MM 2 COLOURS SHRINK TUBE	0.150	M	VM2251A0	STEAM WATER INLET UPPER DISTRIBUTOR	1	PZ	VM2252A0	STEAM WATER INLET LOWER DISTRIBUTOR	1	PZ
Code	Description	Qty	UOM																		
VM1224A0	65MY 220MM 2 COLOURS SHRINK TUBE	0.150	M																		
VM2251A0	STEAM WATER INLET UPPER DISTRIBUTOR	1	PZ																		
VM2252A0	STEAM WATER INLET LOWER DISTRIBUTOR	1	PZ																		
TB2980A	XEBC-06EU-E 2 WAYS WATER PIPE		TB2980A0	XEBC-06EU-E 2 WAYS WATER PIPE																	



COMPONENT			SPARE PART																						
Code	Description	Image	Code	Description	Components list																				
VM2332A	HUMIDITY PIPES WASHER		KVM2332A	WATER PIPE BUSHING KIT VM2332A0	<table border="1"> <thead> <tr> <th>Code</th> <th>Description</th> <th>Qty</th> <th>UOM</th> </tr> </thead> <tbody> <tr> <td>VM1224A0</td> <td>65MY 220MM 2 COLOURS SHRINK TUBE</td> <td>0.200</td> <td>M</td> </tr> <tr> <td>VM2332A0</td> <td>WATER PIPE BUSHING</td> <td>1</td> <td>PZ</td> </tr> <tr> <td>VM2332A0</td> <td>WATER PIPE BUSHING</td> <td>1</td> <td>PZ</td> </tr> <tr> <td>VM2332A1</td> <td>HUMIDITY PIPES WASHE</td> <td>1</td> <td>PZ</td> </tr> </tbody> </table>	Code	Description	Qty	UOM	VM1224A0	65MY 220MM 2 COLOURS SHRINK TUBE	0.200	M	VM2332A0	WATER PIPE BUSHING	1	PZ	VM2332A0	WATER PIPE BUSHING	1	PZ	VM2332A1	HUMIDITY PIPES WASHE	1	PZ
Code	Description	Qty	UOM																						
VM1224A0	65MY 220MM 2 COLOURS SHRINK TUBE	0.200	M																						
VM2332A0	WATER PIPE BUSHING	1	PZ																						
VM2332A0	WATER PIPE BUSHING	1	PZ																						
VM2332A1	HUMIDITY PIPES WASHE	1	PZ																						

ASM3007B/0.D01 - Door

FRONT

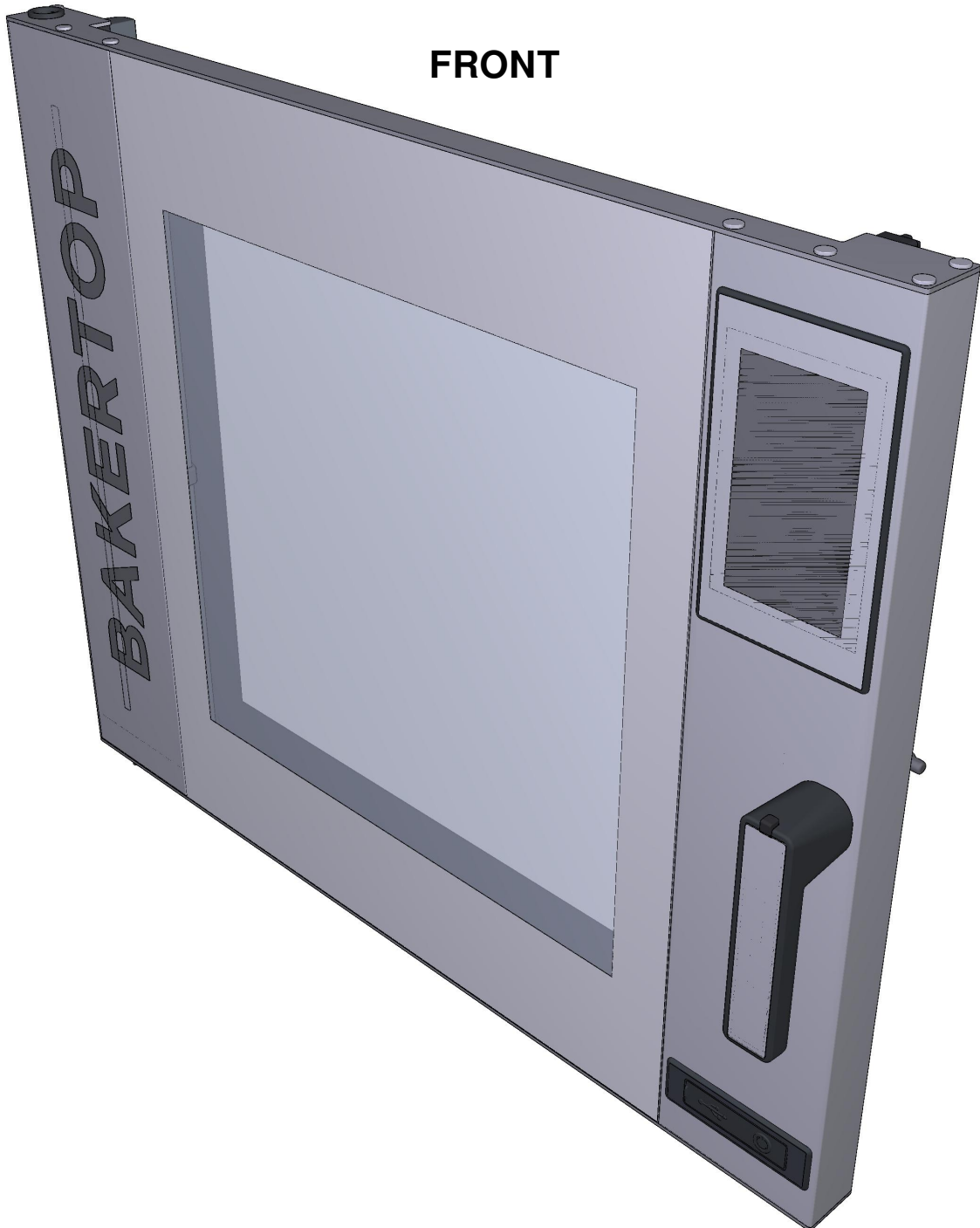





ASM3007B/0.D01 - Door

REAR





COMPONENT			SPARE PART																																						
Code	Description	Image	Code	Description	Components list																																				
LP1020A	6 SERIES L400 LED LIGHT BAR - E583		KLP1020A	L400 E583 LED LIGHT BAR KIT	<table border="1"> <thead> <tr> <th>Code</th> <th>Description</th> <th>Qty</th> <th>UOM</th> </tr> </thead> <tbody> <tr> <td>IP1385A1</td> <td>CORNER POLYSTYREN E PACKING 110X80X2000</td> <td>1.240</td> <td>M</td> </tr> <tr> <td>LP1020A0</td> <td>6 SERIES L400 LED LIGHT BAR - E583</td> <td>1</td> <td>PZ</td> </tr> <tr> <td>VM1059A1</td> <td>HEAT SHRINK FILM H800</td> <td>1.240</td> <td>M</td> </tr> </tbody> </table>	Code	Description	Qty	UOM	IP1385A1	CORNER POLYSTYREN E PACKING 110X80X2000	1.240	M	LP1020A0	6 SERIES L400 LED LIGHT BAR - E583	1	PZ	VM1059A1	HEAT SHRINK FILM H800	1.240	M																				
Code	Description	Qty	UOM																																						
IP1385A1	CORNER POLYSTYREN E PACKING 110X80X2000	1.240	M																																						
LP1020A0	6 SERIES L400 LED LIGHT BAR - E583	1	PZ																																						
VM1059A1	HEAT SHRINK FILM H800	1.240	M																																						
LP1026A	L=583 S6 NO LED LIGHT BAR COVER		KLP1026A	L583 MM NO LED LIGHT HOLDER KIT	<table border="1"> <thead> <tr> <th>Code</th> <th>Description</th> <th>Qty</th> <th>UOM</th> </tr> </thead> <tbody> <tr> <td>IP1385A1</td> <td>CORNER POLYSTYREN E PACKING 110X80X2000</td> <td>1.240</td> <td>M</td> </tr> <tr> <td>LP1026A0</td> <td>L=583 S6 NO LED LIGHT BAR COVER</td> <td>1</td> <td>PZ</td> </tr> <tr> <td>VM1059A1</td> <td>HEAT SHRINK FILM H800</td> <td>1.240</td> <td>M</td> </tr> <tr> <td>VM1794A0</td> <td>250X4.8 PA66 BLACK CLAMP</td> <td>2</td> <td>PZ</td> </tr> <tr> <td>VM2103A0</td> <td>CLAMP LOCK</td> <td>2</td> <td>PZ</td> </tr> </tbody> </table>	Code	Description	Qty	UOM	IP1385A1	CORNER POLYSTYREN E PACKING 110X80X2000	1.240	M	LP1026A0	L=583 S6 NO LED LIGHT BAR COVER	1	PZ	VM1059A1	HEAT SHRINK FILM H800	1.240	M	VM1794A0	250X4.8 PA66 BLACK CLAMP	2	PZ	VM2103A0	CLAMP LOCK	2	PZ												
Code	Description	Qty	UOM																																						
IP1385A1	CORNER POLYSTYREN E PACKING 110X80X2000	1.240	M																																						
LP1026A0	L=583 S6 NO LED LIGHT BAR COVER	1	PZ																																						
VM1059A1	HEAT SHRINK FILM H800	1.240	M																																						
VM1794A0	250X4.8 PA66 BLACK CLAMP	2	PZ																																						
VM2103A0	CLAMP LOCK	2	PZ																																						
CE1053B	MM MICROFIT LED BAR POWER SUPPLY CABLE		KCE1053B	LED BAR EXTENSION CABLE KIT	<table border="1"> <thead> <tr> <th>Code</th> <th>Description</th> <th>Qty</th> <th>UOM</th> </tr> </thead> <tbody> <tr> <td>CE1053B0</td> <td>MM MICROFIT LED BAR POWER SUPPLY CABL</td> <td>1</td> <td>PZ</td> </tr> </tbody> </table>	Code	Description	Qty	UOM	CE1053B0	MM MICROFIT LED BAR POWER SUPPLY CABL	1	PZ																												
Code	Description	Qty	UOM																																						
CE1053B0	MM MICROFIT LED BAR POWER SUPPLY CABL	1	PZ																																						
VT1291A	XEBC-06EU-E EXTERNAL GLASS		KVT1291A	06EU EXTERNAL GLASS KIT	<table border="1"> <thead> <tr> <th>Code</th> <th>Description</th> <th>Qty</th> <th>UOM</th> </tr> </thead> <tbody> <tr> <td>0B1167A0</td> <td>EXT. GLASS SUPPORT PROFILE</td> <td>2</td> <td>PZ</td> </tr> <tr> <td>IP1508A1</td> <td>POLYSTYREN E U SHAPED PROFILE 2000X60X60</td> <td>1</td> <td>M</td> </tr> <tr> <td>MOV0020A0</td> <td>HOOD RING GASKET GN1110A2</td> <td>0.100</td> <td>PZ</td> </tr> <tr> <td>SL1155A1</td> <td>LOCTITE BICOMPONENT SILICON</td> <td>150</td> <td>ML</td> </tr> <tr> <td>SL1156A0</td> <td>NOZZLE FOR SILICON GUN</td> <td>1</td> <td>PZ</td> </tr> <tr> <td>VM1059A1</td> <td>HEAT SHRINK FILM H800</td> <td>1.500</td> <td>M</td> </tr> <tr> <td>VT1291A0</td> <td>XEBC-06EU-E EXTERNAL GLASS</td> <td>1</td> <td>PZ</td> </tr> <tr> <td>VT1291A0</td> <td>XEBC-06EU-E EXTERNAL GLASS</td> <td>1</td> <td>PZ</td> </tr> </tbody> </table>	Code	Description	Qty	UOM	0B1167A0	EXT. GLASS SUPPORT PROFILE	2	PZ	IP1508A1	POLYSTYREN E U SHAPED PROFILE 2000X60X60	1	M	MOV0020A0	HOOD RING GASKET GN1110A2	0.100	PZ	SL1155A1	LOCTITE BICOMPONENT SILICON	150	ML	SL1156A0	NOZZLE FOR SILICON GUN	1	PZ	VM1059A1	HEAT SHRINK FILM H800	1.500	M	VT1291A0	XEBC-06EU-E EXTERNAL GLASS	1	PZ	VT1291A0	XEBC-06EU-E EXTERNAL GLASS	1	PZ
Code	Description	Qty	UOM																																						
0B1167A0	EXT. GLASS SUPPORT PROFILE	2	PZ																																						
IP1508A1	POLYSTYREN E U SHAPED PROFILE 2000X60X60	1	M																																						
MOV0020A0	HOOD RING GASKET GN1110A2	0.100	PZ																																						
SL1155A1	LOCTITE BICOMPONENT SILICON	150	ML																																						
SL1156A0	NOZZLE FOR SILICON GUN	1	PZ																																						
VM1059A1	HEAT SHRINK FILM H800	1.500	M																																						
VT1291A0	XEBC-06EU-E EXTERNAL GLASS	1	PZ																																						
VT1291A0	XEBC-06EU-E EXTERNAL GLASS	1	PZ																																						



COMPONENT			SPARE PART																																																																																		
Code	Description	Image	Code	Description	Components list																																																																																
VT1291A	XEBC-06EU-E EXTERNAL GLASS		KDR1307B	CHEFTOP 06FS-2/1 -M LEFT EXTERNAL DOOR	<table border="1"> <thead> <tr> <th>Code</th> <th>Description</th> <th>Qty</th> <th>UOM</th> </tr> </thead> <tbody> <tr> <td>0B1126B0</td> <td></td> <td>1</td> <td>PZ</td> </tr> <tr> <td>0B1167A0</td> <td>EXT. GLASS SUPPORT PROFILE</td> <td>2</td> <td>PZ</td> </tr> <tr> <td>0B1198B0</td> <td></td> <td>1</td> <td>PZ</td> </tr> <tr> <td>0B1198B1</td> <td></td> <td>1</td> <td>PZ</td> </tr> <tr> <td>0B1199A2</td> <td>0711 LEFT - DOOR RIGHT INT COLUMN</td> <td>1</td> <td>PZ</td> </tr> <tr> <td>0B1200A2</td> <td>0711 LEFT - DOOR LEFT INT COLUMN</td> <td>1</td> <td>PZ</td> </tr> <tr> <td>0B1207A0</td> <td>0711 LEFT - DOOR RIGHT EXT COLUMN</td> <td>1</td> <td>PZ</td> </tr> <tr> <td>0B1218B0</td> <td></td> <td>1</td> <td>PZ</td> </tr> <tr> <td>0B1219A1</td> <td>MM DOUBLE GLASS DOOR INT UPPER BEAM 860</td> <td>1</td> <td>PZ</td> </tr> <tr> <td>0H7321A0</td> <td>MM STAINLESS STEEL HANDLE COVE</td> <td>1</td> <td>PZ</td> </tr> <tr> <td>CE1052A1</td> <td>CABLE CONNECTION CONTROL - USB MM 750M</td> <td>1</td> <td>PZ</td> </tr> <tr> <td>CE1053B0</td> <td>MM MICROFIT LED BAR POWER SUPPLY CABL</td> <td>1</td> <td>PZ</td> </tr> <tr> <td>CE1097A0</td> <td>4M SIHF 4 POLES MICROFIT CANBUS</td> <td>1</td> <td>PZ</td> </tr> <tr> <td>CE1285A0</td> <td>EMI ROUND FERRITE MOD.26438015 02</td> <td>1</td> <td>PZ</td> </tr> <tr> <td>IP1508A1</td> <td>POLYSTYREN E U SHAPED PROFILE 2000X60X60</td> <td>2</td> <td>M</td> </tr> <tr> <td>LP1020A0</td> <td>6 SERIES L400 LED LIGHT BAR - E583</td> <td>1</td> <td>PZ</td> </tr> <tr> <td>LP1026A0</td> <td>L=583 S6 NO LED LIGHT BAR COVER</td> <td>1</td> <td>PZ</td> </tr> <tr> <td>MG1099A1</td> <td></td> <td>1</td> <td>PZ</td> </tr> <tr> <td>RC1200A0</td> <td>ED=4 WIRE D.=0.5 COMPRESSIO N SPRING</td> <td>8</td> <td>PZ</td> </tr> </tbody> </table>	Code	Description	Qty	UOM	0B1126B0		1	PZ	0B1167A0	EXT. GLASS SUPPORT PROFILE	2	PZ	0B1198B0		1	PZ	0B1198B1		1	PZ	0B1199A2	0711 LEFT - DOOR RIGHT INT COLUMN	1	PZ	0B1200A2	0711 LEFT - DOOR LEFT INT COLUMN	1	PZ	0B1207A0	0711 LEFT - DOOR RIGHT EXT COLUMN	1	PZ	0B1218B0		1	PZ	0B1219A1	MM DOUBLE GLASS DOOR INT UPPER BEAM 860	1	PZ	0H7321A0	MM STAINLESS STEEL HANDLE COVE	1	PZ	CE1052A1	CABLE CONNECTION CONTROL - USB MM 750M	1	PZ	CE1053B0	MM MICROFIT LED BAR POWER SUPPLY CABL	1	PZ	CE1097A0	4M SIHF 4 POLES MICROFIT CANBUS	1	PZ	CE1285A0	EMI ROUND FERRITE MOD.26438015 02	1	PZ	IP1508A1	POLYSTYREN E U SHAPED PROFILE 2000X60X60	2	M	LP1020A0	6 SERIES L400 LED LIGHT BAR - E583	1	PZ	LP1026A0	L=583 S6 NO LED LIGHT BAR COVER	1	PZ	MG1099A1		1	PZ	RC1200A0	ED=4 WIRE D.=0.5 COMPRESSIO N SPRING	8	PZ
Code	Description	Qty	UOM																																																																																		
0B1126B0		1	PZ																																																																																		
0B1167A0	EXT. GLASS SUPPORT PROFILE	2	PZ																																																																																		
0B1198B0		1	PZ																																																																																		
0B1198B1		1	PZ																																																																																		
0B1199A2	0711 LEFT - DOOR RIGHT INT COLUMN	1	PZ																																																																																		
0B1200A2	0711 LEFT - DOOR LEFT INT COLUMN	1	PZ																																																																																		
0B1207A0	0711 LEFT - DOOR RIGHT EXT COLUMN	1	PZ																																																																																		
0B1218B0		1	PZ																																																																																		
0B1219A1	MM DOUBLE GLASS DOOR INT UPPER BEAM 860	1	PZ																																																																																		
0H7321A0	MM STAINLESS STEEL HANDLE COVE	1	PZ																																																																																		
CE1052A1	CABLE CONNECTION CONTROL - USB MM 750M	1	PZ																																																																																		
CE1053B0	MM MICROFIT LED BAR POWER SUPPLY CABL	1	PZ																																																																																		
CE1097A0	4M SIHF 4 POLES MICROFIT CANBUS	1	PZ																																																																																		
CE1285A0	EMI ROUND FERRITE MOD.26438015 02	1	PZ																																																																																		
IP1508A1	POLYSTYREN E U SHAPED PROFILE 2000X60X60	2	M																																																																																		
LP1020A0	6 SERIES L400 LED LIGHT BAR - E583	1	PZ																																																																																		
LP1026A0	L=583 S6 NO LED LIGHT BAR COVER	1	PZ																																																																																		
MG1099A1		1	PZ																																																																																		
RC1200A0	ED=4 WIRE D.=0.5 COMPRESSIO N SPRING	8	PZ																																																																																		



COMPONENT			SPARE PART																																																																										
Code	Description	Image	Code	Description	Components list																																																																								
VT1291A	XEBC-06EU-E EXTERNAL GLASS		KDR1307B	CHEFTOP 06FS-2/1 -M LEFT EXTERNAL DOOR	<table border="1"> <thead> <tr> <th>Code</th> <th>Description</th> <th>Qty</th> <th>UOM</th> </tr> </thead> <tbody> <tr> <td>SL1155A1</td> <td>LOCTITE BICOMPONEN T SILICON</td> <td>80</td> <td>ML</td> </tr> <tr> <td>SL1170A1</td> <td>S57 BLACK SILICON - 310ML CARTRIDGE</td> <td>42</td> <td>ML</td> </tr> <tr> <td>VE1030A1</td> <td>MAGNET FOR DOOR MICROSWITC H D=22,9MM</td> <td>2</td> <td>PZ</td> </tr> <tr> <td>VI0239A1</td> <td>SELF-TAPPIN G SCREW 4.2X25 TCB+ INOX</td> <td>4</td> <td>PZ</td> </tr> <tr> <td>VI1103A0</td> <td>40X12 TBSP SCREW FOR PLASTIC</td> <td>2</td> <td>PZ</td> </tr> <tr> <td>VI1220A1</td> <td>4,2X12 TCB SELF-TAPPIN G SCREW</td> <td>26</td> <td>PZ</td> </tr> <tr> <td>VI1930A1</td> <td>ST. STEEL 5X20 CHIP SCREW</td> <td>16</td> <td>PZ</td> </tr> <tr> <td>VI1996A0</td> <td>M5X35 SCREW</td> <td>13</td> <td>PZ</td> </tr> <tr> <td>VM1059A1</td> <td>HEAT SHRINK FILM H800</td> <td>1</td> <td>M</td> </tr> <tr> <td>VM1182B1</td> <td>E. S. CT BT HANDLE JUNCTION + PIN GUIDE</td> <td>1</td> <td>PZ</td> </tr> <tr> <td>VM1490A0</td> <td>CHEFTOP/BAK ERTOP HANDLE SCREWS COVER</td> <td>2</td> <td>PZ</td> </tr> <tr> <td>VM1630A1</td> <td>INTERNAL GLASS PUSHING CAP</td> <td>2</td> <td>PZ</td> </tr> <tr> <td>VM1631A0</td> <td>PLUS INNER GLASS PUSHING CAP</td> <td>2</td> <td>PZ</td> </tr> <tr> <td>VM1695A0</td> <td>HANDLE POSITION PIN</td> <td>4</td> <td>PZ</td> </tr> <tr> <td>VM2245A0</td> <td>HANDLE SHAFT WITH LATCH</td> <td>1</td> <td>PZ</td> </tr> <tr> <td>VM2247B0</td> <td>HANDLE SHAFT COVER VM2245-2246</td> <td>1</td> <td>PZ</td> </tr> <tr> <td>VM2248B0</td> <td>HANDLE WITH LATCH CLOSING KEY</td> <td>1</td> <td>PZ</td> </tr> </tbody> </table>	Code	Description	Qty	UOM	SL1155A1	LOCTITE BICOMPONEN T SILICON	80	ML	SL1170A1	S57 BLACK SILICON - 310ML CARTRIDGE	42	ML	VE1030A1	MAGNET FOR DOOR MICROSWITC H D=22,9MM	2	PZ	VI0239A1	SELF-TAPPIN G SCREW 4.2X25 TCB+ INOX	4	PZ	VI1103A0	40X12 TBSP SCREW FOR PLASTIC	2	PZ	VI1220A1	4,2X12 TCB SELF-TAPPIN G SCREW	26	PZ	VI1930A1	ST. STEEL 5X20 CHIP SCREW	16	PZ	VI1996A0	M5X35 SCREW	13	PZ	VM1059A1	HEAT SHRINK FILM H800	1	M	VM1182B1	E. S. CT BT HANDLE JUNCTION + PIN GUIDE	1	PZ	VM1490A0	CHEFTOP/BAK ERTOP HANDLE SCREWS COVER	2	PZ	VM1630A1	INTERNAL GLASS PUSHING CAP	2	PZ	VM1631A0	PLUS INNER GLASS PUSHING CAP	2	PZ	VM1695A0	HANDLE POSITION PIN	4	PZ	VM2245A0	HANDLE SHAFT WITH LATCH	1	PZ	VM2247B0	HANDLE SHAFT COVER VM2245-2246	1	PZ	VM2248B0	HANDLE WITH LATCH CLOSING KEY	1	PZ
Code	Description	Qty	UOM																																																																										
SL1155A1	LOCTITE BICOMPONEN T SILICON	80	ML																																																																										
SL1170A1	S57 BLACK SILICON - 310ML CARTRIDGE	42	ML																																																																										
VE1030A1	MAGNET FOR DOOR MICROSWITC H D=22,9MM	2	PZ																																																																										
VI0239A1	SELF-TAPPIN G SCREW 4.2X25 TCB+ INOX	4	PZ																																																																										
VI1103A0	40X12 TBSP SCREW FOR PLASTIC	2	PZ																																																																										
VI1220A1	4,2X12 TCB SELF-TAPPIN G SCREW	26	PZ																																																																										
VI1930A1	ST. STEEL 5X20 CHIP SCREW	16	PZ																																																																										
VI1996A0	M5X35 SCREW	13	PZ																																																																										
VM1059A1	HEAT SHRINK FILM H800	1	M																																																																										
VM1182B1	E. S. CT BT HANDLE JUNCTION + PIN GUIDE	1	PZ																																																																										
VM1490A0	CHEFTOP/BAK ERTOP HANDLE SCREWS COVER	2	PZ																																																																										
VM1630A1	INTERNAL GLASS PUSHING CAP	2	PZ																																																																										
VM1631A0	PLUS INNER GLASS PUSHING CAP	2	PZ																																																																										
VM1695A0	HANDLE POSITION PIN	4	PZ																																																																										
VM2245A0	HANDLE SHAFT WITH LATCH	1	PZ																																																																										
VM2247B0	HANDLE SHAFT COVER VM2245-2246	1	PZ																																																																										
VM2248B0	HANDLE WITH LATCH CLOSING KEY	1	PZ																																																																										



COMPONENT			SPARE PART																																																																														
Code	Description	Image	Code	Description	Components list																																																																												
VT1291A	XEBC-06EU-E EXTERNAL GLASS		KDR1307B	CHEFTOP 06FS-2/1 -M LEFT EXTERNAL DOOR	<table border="1"> <thead> <tr> <th>Code</th> <th>Description</th> <th>Qty</th> <th>UOM</th> </tr> </thead> <tbody> <tr> <td>VM2267A0</td> <td>INTERNAL GLASS LOCKING SYSTEM SLIDER</td> <td>2</td> <td>PZ</td> </tr> <tr> <td>VM2268A0</td> <td>DOOR MAGNET COVER</td> <td>2</td> <td>PZ</td> </tr> <tr> <td>VM2269B0</td> <td>INNER GLASS FIXING CAP</td> <td>2</td> <td>PZ</td> </tr> <tr> <td>VM2274A0</td> <td>GROOVED BUSHING</td> <td>1</td> <td>PZ</td> </tr> <tr> <td>VM2275A0</td> <td>SMOOTH BUSHING</td> <td>1</td> <td>PZ</td> </tr> <tr> <td>VM2285B0</td> <td>860 SERIES DRIP PROFILE KIT</td> <td>1</td> <td>PZ</td> </tr> <tr> <td>VM2295A1</td> <td>MIND.MAPS TOUCH CONTROL STYLUS KIT</td> <td>1</td> <td>PZ</td> </tr> <tr> <td>VM2305A0</td> <td>6 SERIES DOOR CAP FIXING PAWL</td> <td>14</td> <td>PZ</td> </tr> <tr> <td>VM2313A0</td> <td>TUBE DX DISCHARGE DRIP MM</td> <td>1</td> <td>PZ</td> </tr> <tr> <td>VM2314A0</td> <td>6 S. DRIP PROFILE CAP</td> <td>1</td> <td>PZ</td> </tr> <tr> <td>VM2315B0</td> <td>S6 INTERNAL GLASS SUPPORT</td> <td>2</td> <td>PZ</td> </tr> <tr> <td>VM2383B0</td> <td>S6 LEFT OVENS UPPER RIGHT CAP</td> <td>1</td> <td>PZ</td> </tr> <tr> <td>VM2384B0</td> <td></td> <td>1</td> <td>PZ</td> </tr> <tr> <td>VM2385B0</td> <td>S6 LEFT OVENS UPPER LEFT CAP</td> <td>1</td> <td>PZ</td> </tr> <tr> <td>VM2386B0</td> <td>MM -M LEFT DOOR LEFT LOWER CAP KI</td> <td>1</td> <td>PZ</td> </tr> <tr> <td>VM2410A0</td> <td>PLATE TO STOP EXTRUDED LED BAR</td> <td>2</td> <td>PZ</td> </tr> <tr> <td>VM2505B0</td> <td>MM PLUS INTERNAL GLASS SUPPORT</td> <td>2</td> <td>PZ</td> </tr> <tr> <td>VM2518A0</td> <td>BOARD COOLING FAN SUPPORT</td> <td>1</td> <td>PZ</td> </tr> </tbody> </table>	Code	Description	Qty	UOM	VM2267A0	INTERNAL GLASS LOCKING SYSTEM SLIDER	2	PZ	VM2268A0	DOOR MAGNET COVER	2	PZ	VM2269B0	INNER GLASS FIXING CAP	2	PZ	VM2274A0	GROOVED BUSHING	1	PZ	VM2275A0	SMOOTH BUSHING	1	PZ	VM2285B0	860 SERIES DRIP PROFILE KIT	1	PZ	VM2295A1	MIND.MAPS TOUCH CONTROL STYLUS KIT	1	PZ	VM2305A0	6 SERIES DOOR CAP FIXING PAWL	14	PZ	VM2313A0	TUBE DX DISCHARGE DRIP MM	1	PZ	VM2314A0	6 S. DRIP PROFILE CAP	1	PZ	VM2315B0	S6 INTERNAL GLASS SUPPORT	2	PZ	VM2383B0	S6 LEFT OVENS UPPER RIGHT CAP	1	PZ	VM2384B0		1	PZ	VM2385B0	S6 LEFT OVENS UPPER LEFT CAP	1	PZ	VM2386B0	MM -M LEFT DOOR LEFT LOWER CAP KI	1	PZ	VM2410A0	PLATE TO STOP EXTRUDED LED BAR	2	PZ	VM2505B0	MM PLUS INTERNAL GLASS SUPPORT	2	PZ	VM2518A0	BOARD COOLING FAN SUPPORT	1	PZ
Code	Description	Qty	UOM																																																																														
VM2267A0	INTERNAL GLASS LOCKING SYSTEM SLIDER	2	PZ																																																																														
VM2268A0	DOOR MAGNET COVER	2	PZ																																																																														
VM2269B0	INNER GLASS FIXING CAP	2	PZ																																																																														
VM2274A0	GROOVED BUSHING	1	PZ																																																																														
VM2275A0	SMOOTH BUSHING	1	PZ																																																																														
VM2285B0	860 SERIES DRIP PROFILE KIT	1	PZ																																																																														
VM2295A1	MIND.MAPS TOUCH CONTROL STYLUS KIT	1	PZ																																																																														
VM2305A0	6 SERIES DOOR CAP FIXING PAWL	14	PZ																																																																														
VM2313A0	TUBE DX DISCHARGE DRIP MM	1	PZ																																																																														
VM2314A0	6 S. DRIP PROFILE CAP	1	PZ																																																																														
VM2315B0	S6 INTERNAL GLASS SUPPORT	2	PZ																																																																														
VM2383B0	S6 LEFT OVENS UPPER RIGHT CAP	1	PZ																																																																														
VM2384B0		1	PZ																																																																														
VM2385B0	S6 LEFT OVENS UPPER LEFT CAP	1	PZ																																																																														
VM2386B0	MM -M LEFT DOOR LEFT LOWER CAP KI	1	PZ																																																																														
VM2410A0	PLATE TO STOP EXTRUDED LED BAR	2	PZ																																																																														
VM2505B0	MM PLUS INTERNAL GLASS SUPPORT	2	PZ																																																																														
VM2518A0	BOARD COOLING FAN SUPPORT	1	PZ																																																																														





COMPONENT			SPARE PART																																																							
Code	Description	Image	Code	Description	Components list																																																					
VT1291A	XEBC-06EU-E EXTERNAL GLASS		KDR1307B	CHEFTOP 06FS-2/1 -M LEFT EXTERNAL DOOR	<table border="1"> <thead> <tr> <th>Code</th> <th>Description</th> <th>Qty</th> <th>UOM</th> </tr> </thead> <tbody> <tr> <td>VN1179A1</td> <td>CONTROL BOARD 40X40X20MM 12V COOLING FAN</td> <td>1</td> <td>PZ</td> </tr> <tr> <td>VP1076A0</td> <td>PLUS ONE ZERO HANDLE PIN</td> <td>1</td> <td>PZ</td> </tr> <tr> <td>VP1080A0</td> <td>UPPER HINGE CAP FOR LOWER INNER GLASS</td> <td>1</td> <td>PZ</td> </tr> <tr> <td>VP1081A0</td> <td>UPPER HINGE CAP FOR UPPER INNER GLASS</td> <td>1</td> <td>PZ</td> </tr> <tr> <td>VT1291A0</td> <td>XEBC-06EU-E EXTERNAL GLASS</td> <td>1</td> <td>PZ</td> </tr> </tbody> </table>	Code	Description	Qty	UOM	VN1179A1	CONTROL BOARD 40X40X20MM 12V COOLING FAN	1	PZ	VP1076A0	PLUS ONE ZERO HANDLE PIN	1	PZ	VP1080A0	UPPER HINGE CAP FOR LOWER INNER GLASS	1	PZ	VP1081A0	UPPER HINGE CAP FOR UPPER INNER GLASS	1	PZ	VT1291A0	XEBC-06EU-E EXTERNAL GLASS	1	PZ																													
			Code	Description	Qty	UOM																																																				
VN1179A1	CONTROL BOARD 40X40X20MM 12V COOLING FAN	1	PZ																																																							
VP1076A0	PLUS ONE ZERO HANDLE PIN	1	PZ																																																							
VP1080A0	UPPER HINGE CAP FOR LOWER INNER GLASS	1	PZ																																																							
VP1081A0	UPPER HINGE CAP FOR UPPER INNER GLASS	1	PZ																																																							
VT1291A0	XEBC-06EU-E EXTERNAL GLASS	1	PZ																																																							
KDR1307A	CHEFTOP 06FS-2/1 LEFT EXTERNAL DOOR	<table border="1"> <thead> <tr> <th>Code</th> <th>Description</th> <th>Qty</th> <th>UOM</th> </tr> </thead> <tbody> <tr> <td>0B1126A1</td> <td></td> <td>1</td> <td>PZ</td> </tr> <tr> <td>0B1167A0</td> <td>EXT. GLASS SUPPORT PROFILE</td> <td>2</td> <td>PZ</td> </tr> <tr> <td>0B1198A0</td> <td>0711 LEFT - DOOR LEFT EXT COLUMN</td> <td>1</td> <td>PZ</td> </tr> <tr> <td>0B1198B0</td> <td></td> <td>1</td> <td>PZ</td> </tr> <tr> <td>0B1198B1</td> <td></td> <td>1</td> <td>PZ</td> </tr> <tr> <td>0B1199A2</td> <td>0711 LEFT - DOOR RIGHT INT COLUMN</td> <td>1</td> <td>PZ</td> </tr> <tr> <td>0B1200A2</td> <td>0711 LEFT - DOOR LEFT INT COLUMN</td> <td>1</td> <td>PZ</td> </tr> <tr> <td>0B1207A0</td> <td>0711 LEFT - DOOR RIGHT EXT COLUMN</td> <td>1</td> <td>PZ</td> </tr> <tr> <td>0B1218A1</td> <td></td> <td>1</td> <td>PZ</td> </tr> <tr> <td>0B1219A1</td> <td>MM DOUBLE GLASS DOOR INT UPPER BEAM 860</td> <td>1</td> <td>PZ</td> </tr> <tr> <td>0H7321A0</td> <td>MM STAINLESS STEEL HANDLE COVE</td> <td>1</td> <td>PZ</td> </tr> <tr> <td>CE1052A1</td> <td>CABLE CONNECTION CONTROL - USB MM 750M</td> <td>1</td> <td>PZ</td> </tr> <tr> <td>CE1053B0</td> <td>MM MICROFIT LED BAR POWER SUPPLY CABL</td> <td>1</td> <td>PZ</td> </tr> </tbody> </table>	Code	Description	Qty	UOM	0B1126A1		1	PZ	0B1167A0	EXT. GLASS SUPPORT PROFILE	2	PZ	0B1198A0	0711 LEFT - DOOR LEFT EXT COLUMN	1	PZ	0B1198B0		1	PZ	0B1198B1		1	PZ	0B1199A2	0711 LEFT - DOOR RIGHT INT COLUMN	1	PZ	0B1200A2	0711 LEFT - DOOR LEFT INT COLUMN	1	PZ	0B1207A0	0711 LEFT - DOOR RIGHT EXT COLUMN	1	PZ	0B1218A1		1	PZ	0B1219A1	MM DOUBLE GLASS DOOR INT UPPER BEAM 860	1	PZ	0H7321A0	MM STAINLESS STEEL HANDLE COVE	1	PZ	CE1052A1	CABLE CONNECTION CONTROL - USB MM 750M	1	PZ	CE1053B0	MM MICROFIT LED BAR POWER SUPPLY CABL	1	PZ
Code	Description	Qty	UOM																																																							
0B1126A1		1	PZ																																																							
0B1167A0	EXT. GLASS SUPPORT PROFILE	2	PZ																																																							
0B1198A0	0711 LEFT - DOOR LEFT EXT COLUMN	1	PZ																																																							
0B1198B0		1	PZ																																																							
0B1198B1		1	PZ																																																							
0B1199A2	0711 LEFT - DOOR RIGHT INT COLUMN	1	PZ																																																							
0B1200A2	0711 LEFT - DOOR LEFT INT COLUMN	1	PZ																																																							
0B1207A0	0711 LEFT - DOOR RIGHT EXT COLUMN	1	PZ																																																							
0B1218A1		1	PZ																																																							
0B1219A1	MM DOUBLE GLASS DOOR INT UPPER BEAM 860	1	PZ																																																							
0H7321A0	MM STAINLESS STEEL HANDLE COVE	1	PZ																																																							
CE1052A1	CABLE CONNECTION CONTROL - USB MM 750M	1	PZ																																																							
CE1053B0	MM MICROFIT LED BAR POWER SUPPLY CABL	1	PZ																																																							



COMPONENT			SPARE PART																																																																														
Code	Description	Image	Code	Description	Components list																																																																												
VT1291A	XEBC-06EU-E EXTERNAL GLASS		KDR1307A	CHEFTOP 06FS-2/1 LEFT EXTERNAL DOOR	<table border="1"> <thead> <tr> <th>Code</th> <th>Description</th> <th>Qty</th> <th>UOM</th> </tr> </thead> <tbody> <tr> <td>CE1285A0</td> <td>EMI ROUND FERRITE MOD.26438015 02</td> <td>1</td> <td>PZ</td> </tr> <tr> <td>CE1290A0</td> <td>EXTRACTABL E FEMALE TERMINAL CPF 5/4</td> <td>1</td> <td>PZ</td> </tr> <tr> <td>CE1455A0</td> <td>TIP END FITTING</td> <td>4</td> <td>PZ</td> </tr> <tr> <td>CE1725A0</td> <td>ROBOTICS SILICON PIPE 4X0,5 MMQ</td> <td>4</td> <td>M</td> </tr> <tr> <td>CE1735A0</td> <td>MINIFIT FEMALE END FITTING</td> <td>4</td> <td>PZ</td> </tr> <tr> <td>CE1755A0</td> <td>4 WAYS MALE MINIFIT CONNECTOR</td> <td>1</td> <td>PZ</td> </tr> <tr> <td>IP1508A1</td> <td>POLYSTYREN E U SHAPED PROFILE 2000X60X60</td> <td>2</td> <td>M</td> </tr> <tr> <td>LP1020A0</td> <td>6 SERIES L400 LED LIGHT BAR - E583</td> <td>1</td> <td>PZ</td> </tr> <tr> <td>LP1026A0</td> <td>L=583 S6 NO LED LIGHT BAR COVER</td> <td>1</td> <td>PZ</td> </tr> <tr> <td>MG1083A2</td> <td></td> <td>1</td> <td>PZ</td> </tr> <tr> <td>RC1200A0</td> <td>ED=4 WIRE D.=0.5 COMPRESSIO N SPRING</td> <td>4</td> <td>PZ</td> </tr> <tr> <td>SL1170A1</td> <td>S57 BLACK SILICON - 310ML CARTRIDGE</td> <td>42</td> <td>ML</td> </tr> <tr> <td>VE1030A1</td> <td>MAGNET FOR DOOR MICROSWITC H D=22,9MM</td> <td>2</td> <td>PZ</td> </tr> <tr> <td>VI1220A1</td> <td>4,2X12 TCB SELF-TAPPIN G SCREW</td> <td>26</td> <td>PZ</td> </tr> <tr> <td>VI1930A1</td> <td>ST. STEEL 5X20 CHIP SCREW</td> <td>16</td> <td>PZ</td> </tr> <tr> <td>VI1996A0</td> <td>M5X35 SCREW</td> <td>13</td> <td>PZ</td> </tr> <tr> <td>VM1059A1</td> <td>HEAT SHRINK FILM H800</td> <td>1</td> <td>M</td> </tr> <tr> <td>VM1182B1</td> <td>E.S. CT BT HANDLE JUNCTION + PIN GUIDE</td> <td>1</td> <td>PZ</td> </tr> </tbody> </table>	Code	Description	Qty	UOM	CE1285A0	EMI ROUND FERRITE MOD.26438015 02	1	PZ	CE1290A0	EXTRACTABL E FEMALE TERMINAL CPF 5/4	1	PZ	CE1455A0	TIP END FITTING	4	PZ	CE1725A0	ROBOTICS SILICON PIPE 4X0,5 MMQ	4	M	CE1735A0	MINIFIT FEMALE END FITTING	4	PZ	CE1755A0	4 WAYS MALE MINIFIT CONNECTOR	1	PZ	IP1508A1	POLYSTYREN E U SHAPED PROFILE 2000X60X60	2	M	LP1020A0	6 SERIES L400 LED LIGHT BAR - E583	1	PZ	LP1026A0	L=583 S6 NO LED LIGHT BAR COVER	1	PZ	MG1083A2		1	PZ	RC1200A0	ED=4 WIRE D.=0.5 COMPRESSIO N SPRING	4	PZ	SL1170A1	S57 BLACK SILICON - 310ML CARTRIDGE	42	ML	VE1030A1	MAGNET FOR DOOR MICROSWITC H D=22,9MM	2	PZ	VI1220A1	4,2X12 TCB SELF-TAPPIN G SCREW	26	PZ	VI1930A1	ST. STEEL 5X20 CHIP SCREW	16	PZ	VI1996A0	M5X35 SCREW	13	PZ	VM1059A1	HEAT SHRINK FILM H800	1	M	VM1182B1	E.S. CT BT HANDLE JUNCTION + PIN GUIDE	1	PZ
Code	Description	Qty	UOM																																																																														
CE1285A0	EMI ROUND FERRITE MOD.26438015 02	1	PZ																																																																														
CE1290A0	EXTRACTABL E FEMALE TERMINAL CPF 5/4	1	PZ																																																																														
CE1455A0	TIP END FITTING	4	PZ																																																																														
CE1725A0	ROBOTICS SILICON PIPE 4X0,5 MMQ	4	M																																																																														
CE1735A0	MINIFIT FEMALE END FITTING	4	PZ																																																																														
CE1755A0	4 WAYS MALE MINIFIT CONNECTOR	1	PZ																																																																														
IP1508A1	POLYSTYREN E U SHAPED PROFILE 2000X60X60	2	M																																																																														
LP1020A0	6 SERIES L400 LED LIGHT BAR - E583	1	PZ																																																																														
LP1026A0	L=583 S6 NO LED LIGHT BAR COVER	1	PZ																																																																														
MG1083A2		1	PZ																																																																														
RC1200A0	ED=4 WIRE D.=0.5 COMPRESSIO N SPRING	4	PZ																																																																														
SL1170A1	S57 BLACK SILICON - 310ML CARTRIDGE	42	ML																																																																														
VE1030A1	MAGNET FOR DOOR MICROSWITC H D=22,9MM	2	PZ																																																																														
VI1220A1	4,2X12 TCB SELF-TAPPIN G SCREW	26	PZ																																																																														
VI1930A1	ST. STEEL 5X20 CHIP SCREW	16	PZ																																																																														
VI1996A0	M5X35 SCREW	13	PZ																																																																														
VM1059A1	HEAT SHRINK FILM H800	1	M																																																																														
VM1182B1	E.S. CT BT HANDLE JUNCTION + PIN GUIDE	1	PZ																																																																														



COMPONENT			SPARE PART																																																																														
Code	Description	Image	Code	Description	Components list																																																																												
VT1291A	XEBC-06EU-E EXTERNAL GLASS		KDR1307A	CHEFTOP 06FS-2/1 LEFT EXTERNAL DOOR	<table border="1"> <thead> <tr> <th>Code</th> <th>Description</th> <th>Qty</th> <th>UOM</th> </tr> </thead> <tbody> <tr> <td>VM1183C0</td> <td>CT BT HANDLE T-SHAPED PIN KIT</td> <td>1</td> <td>PZ</td> </tr> <tr> <td>VM1183C1</td> <td>CT BT HANDLE T-SHAPED PIN KIT</td> <td>1</td> <td>PZ</td> </tr> <tr> <td>VM1630A1</td> <td>INTERNAL GLASS PUSHING CAP</td> <td>2</td> <td>PZ</td> </tr> <tr> <td>VM1631A0</td> <td>PLUS INNER GLASS PUSHING CAP</td> <td>2</td> <td>PZ</td> </tr> <tr> <td>VM1695A0</td> <td>HANDLE POSITION PIN</td> <td>4</td> <td>PZ</td> </tr> <tr> <td>VM2245A0</td> <td>HANDLE SHAFT WITH LATCH</td> <td>1</td> <td>PZ</td> </tr> <tr> <td>VM2247B0</td> <td>HANDLE SHAFT COVER VM2245-2246</td> <td>1</td> <td>PZ</td> </tr> <tr> <td>VM2248B0</td> <td>HANDLE WITH LATCH CLOSING KEY</td> <td>1</td> <td>PZ</td> </tr> <tr> <td>VM2267A0</td> <td>INTERNAL GLASS LOCKING SYSTEM SLIDER</td> <td>2</td> <td>PZ</td> </tr> <tr> <td>VM2268A0</td> <td>DOOR MAGNET COVER</td> <td>2</td> <td>PZ</td> </tr> <tr> <td>VM2269A0</td> <td>INTERNAL GLASS LOCKING SYSTEM CAP</td> <td>2</td> <td>PZ</td> </tr> <tr> <td>VM2274A0</td> <td>GROOVED BUSHING</td> <td>1</td> <td>PZ</td> </tr> <tr> <td>VM2275A0</td> <td>SMOOTH BUSHING</td> <td>1</td> <td>PZ</td> </tr> <tr> <td>VM2285A0</td> <td>860 SERIES DRIP PROFILE</td> <td>1</td> <td>PZ</td> </tr> <tr> <td>VM2295A0</td> <td>STYLUS PEN FOR MM</td> <td>1</td> <td>PZ</td> </tr> <tr> <td>VM2305A0</td> <td>6 SERIES DOOR CAP FIXING PAWL</td> <td>14</td> <td>PZ</td> </tr> <tr> <td>VM2312A0</td> <td>6 S. DRIP PROFILE DRAIN LEFT PIPE</td> <td>1</td> <td>PZ</td> </tr> <tr> <td>VM2313A0</td> <td>TUBE DX DISCHARGE DRIP MM</td> <td>1</td> <td>PZ</td> </tr> </tbody> </table>	Code	Description	Qty	UOM	VM1183C0	CT BT HANDLE T-SHAPED PIN KIT	1	PZ	VM1183C1	CT BT HANDLE T-SHAPED PIN KIT	1	PZ	VM1630A1	INTERNAL GLASS PUSHING CAP	2	PZ	VM1631A0	PLUS INNER GLASS PUSHING CAP	2	PZ	VM1695A0	HANDLE POSITION PIN	4	PZ	VM2245A0	HANDLE SHAFT WITH LATCH	1	PZ	VM2247B0	HANDLE SHAFT COVER VM2245-2246	1	PZ	VM2248B0	HANDLE WITH LATCH CLOSING KEY	1	PZ	VM2267A0	INTERNAL GLASS LOCKING SYSTEM SLIDER	2	PZ	VM2268A0	DOOR MAGNET COVER	2	PZ	VM2269A0	INTERNAL GLASS LOCKING SYSTEM CAP	2	PZ	VM2274A0	GROOVED BUSHING	1	PZ	VM2275A0	SMOOTH BUSHING	1	PZ	VM2285A0	860 SERIES DRIP PROFILE	1	PZ	VM2295A0	STYLUS PEN FOR MM	1	PZ	VM2305A0	6 SERIES DOOR CAP FIXING PAWL	14	PZ	VM2312A0	6 S. DRIP PROFILE DRAIN LEFT PIPE	1	PZ	VM2313A0	TUBE DX DISCHARGE DRIP MM	1	PZ
Code	Description	Qty	UOM																																																																														
VM1183C0	CT BT HANDLE T-SHAPED PIN KIT	1	PZ																																																																														
VM1183C1	CT BT HANDLE T-SHAPED PIN KIT	1	PZ																																																																														
VM1630A1	INTERNAL GLASS PUSHING CAP	2	PZ																																																																														
VM1631A0	PLUS INNER GLASS PUSHING CAP	2	PZ																																																																														
VM1695A0	HANDLE POSITION PIN	4	PZ																																																																														
VM2245A0	HANDLE SHAFT WITH LATCH	1	PZ																																																																														
VM2247B0	HANDLE SHAFT COVER VM2245-2246	1	PZ																																																																														
VM2248B0	HANDLE WITH LATCH CLOSING KEY	1	PZ																																																																														
VM2267A0	INTERNAL GLASS LOCKING SYSTEM SLIDER	2	PZ																																																																														
VM2268A0	DOOR MAGNET COVER	2	PZ																																																																														
VM2269A0	INTERNAL GLASS LOCKING SYSTEM CAP	2	PZ																																																																														
VM2274A0	GROOVED BUSHING	1	PZ																																																																														
VM2275A0	SMOOTH BUSHING	1	PZ																																																																														
VM2285A0	860 SERIES DRIP PROFILE	1	PZ																																																																														
VM2295A0	STYLUS PEN FOR MM	1	PZ																																																																														
VM2305A0	6 SERIES DOOR CAP FIXING PAWL	14	PZ																																																																														
VM2312A0	6 S. DRIP PROFILE DRAIN LEFT PIPE	1	PZ																																																																														
VM2313A0	TUBE DX DISCHARGE DRIP MM	1	PZ																																																																														



COMPONENT			SPARE PART																																																						
Code	Description	Image	Code	Description	Components list																																																				
VT1291A	XEBC-06EU-E EXTERNAL GLASS		KDR1307A	CHEFTOP 06FS-2/1 LEFT EXTERNAL DOOR	<table border="1"> <thead> <tr> <th>Code</th> <th>Description</th> <th>Qty</th> <th>UOM</th> </tr> </thead> <tbody> <tr> <td>VM2314A0</td> <td>6 S. DRIP PROFILE CAP</td> <td>1</td> <td>PZ</td> </tr> <tr> <td>VM2315A0</td> <td>MIND.MAPS INTERNAL GLASS CAP SUPPORT</td> <td>2</td> <td>PZ</td> </tr> <tr> <td>VM2371A0</td> <td>DOUBLE GLASS DOOR PUSHING BRACKET</td> <td>2</td> <td>PZ</td> </tr> <tr> <td>VM2383A0</td> <td>MM LEFT DOOR RIGHT UPPER CAP</td> <td>1</td> <td>PZ</td> </tr> <tr> <td>VM2384A0</td> <td>MM LEFT DOOR RIGHT LOWER CAP</td> <td>1</td> <td>PZ</td> </tr> <tr> <td>VM2385A1</td> <td>LEFT MM DOOR UPPER LEFT CAP</td> <td>1</td> <td>PZ</td> </tr> <tr> <td>VM2386A1</td> <td>LEFT MM DOOR LOWER LEFT CAP</td> <td>1</td> <td>PZ</td> </tr> <tr> <td>VM2410A0</td> <td>PLATE TO STOP EXTRUDED LED BAR</td> <td>2</td> <td>PZ</td> </tr> <tr> <td>VM2505A0</td> <td>MM PLUS INTERNAL GLASS SUPPORT</td> <td>2</td> <td>PZ</td> </tr> <tr> <td>VM2518A0</td> <td>BOARD COOLING FAN SUPPORT</td> <td>1</td> <td>PZ</td> </tr> <tr> <td>VN1179A1</td> <td>CONTROL BOARD 40X40X20MM 12V COOLING FAN</td> <td>1</td> <td>PZ</td> </tr> <tr> <td>VT1291A0</td> <td>XEBC-06EU-E EXTERNAL GLASS</td> <td>1</td> <td>PZ</td> </tr> </tbody> </table>	Code	Description	Qty	UOM	VM2314A0	6 S. DRIP PROFILE CAP	1	PZ	VM2315A0	MIND.MAPS INTERNAL GLASS CAP SUPPORT	2	PZ	VM2371A0	DOUBLE GLASS DOOR PUSHING BRACKET	2	PZ	VM2383A0	MM LEFT DOOR RIGHT UPPER CAP	1	PZ	VM2384A0	MM LEFT DOOR RIGHT LOWER CAP	1	PZ	VM2385A1	LEFT MM DOOR UPPER LEFT CAP	1	PZ	VM2386A1	LEFT MM DOOR LOWER LEFT CAP	1	PZ	VM2410A0	PLATE TO STOP EXTRUDED LED BAR	2	PZ	VM2505A0	MM PLUS INTERNAL GLASS SUPPORT	2	PZ	VM2518A0	BOARD COOLING FAN SUPPORT	1	PZ	VN1179A1	CONTROL BOARD 40X40X20MM 12V COOLING FAN	1	PZ	VT1291A0	XEBC-06EU-E EXTERNAL GLASS	1	PZ
			Code	Description	Qty	UOM																																																			
VM2314A0	6 S. DRIP PROFILE CAP	1	PZ																																																						
VM2315A0	MIND.MAPS INTERNAL GLASS CAP SUPPORT	2	PZ																																																						
VM2371A0	DOUBLE GLASS DOOR PUSHING BRACKET	2	PZ																																																						
VM2383A0	MM LEFT DOOR RIGHT UPPER CAP	1	PZ																																																						
VM2384A0	MM LEFT DOOR RIGHT LOWER CAP	1	PZ																																																						
VM2385A1	LEFT MM DOOR UPPER LEFT CAP	1	PZ																																																						
VM2386A1	LEFT MM DOOR LOWER LEFT CAP	1	PZ																																																						
VM2410A0	PLATE TO STOP EXTRUDED LED BAR	2	PZ																																																						
VM2505A0	MM PLUS INTERNAL GLASS SUPPORT	2	PZ																																																						
VM2518A0	BOARD COOLING FAN SUPPORT	1	PZ																																																						
VN1179A1	CONTROL BOARD 40X40X20MM 12V COOLING FAN	1	PZ																																																						
VT1291A0	XEBC-06EU-E EXTERNAL GLASS	1	PZ																																																						
KDR1306B	CHEFTOP 06FS-2/1 -M RIGHT EXTERNAL DOOR	<table border="1"> <thead> <tr> <th>Code</th> <th>Description</th> <th>Qty</th> <th>UOM</th> </tr> </thead> <tbody> <tr> <td>0B1111A0</td> <td>XEVC-0711-E LEFT EXT DOOR COLUM</td> <td>1</td> <td>PZ</td> </tr> <tr> <td>0B1112A2</td> <td>0711 RIGHT - DOOR LEFT INT COLUMN</td> <td>1</td> <td>PZ</td> </tr> <tr> <td>0B1113B0</td> <td></td> <td>1</td> <td>PZ</td> </tr> <tr> <td>0B1113B1</td> <td></td> <td>1</td> <td>PZ</td> </tr> <tr> <td>0B1114A2</td> <td>0711 RIGHT - DOOR RIGHT INT COLUMN</td> <td>1</td> <td>PZ</td> </tr> <tr> <td>0B1126B0</td> <td></td> <td>1</td> <td>PZ</td> </tr> </tbody> </table>	Code	Description	Qty	UOM	0B1111A0	XEVC-0711-E LEFT EXT DOOR COLUM	1	PZ	0B1112A2	0711 RIGHT - DOOR LEFT INT COLUMN	1	PZ	0B1113B0		1	PZ	0B1113B1		1	PZ	0B1114A2	0711 RIGHT - DOOR RIGHT INT COLUMN	1	PZ	0B1126B0		1	PZ																											
Code	Description	Qty	UOM																																																						
0B1111A0	XEVC-0711-E LEFT EXT DOOR COLUM	1	PZ																																																						
0B1112A2	0711 RIGHT - DOOR LEFT INT COLUMN	1	PZ																																																						
0B1113B0		1	PZ																																																						
0B1113B1		1	PZ																																																						
0B1114A2	0711 RIGHT - DOOR RIGHT INT COLUMN	1	PZ																																																						
0B1126B0		1	PZ																																																						



COMPONENT			SPARE PART																																																																						
Code	Description	Image	Code	Description	Components list																																																																				
VT1291A	XEBC-06EU-E EXTERNAL GLASS		KDR1306B	CHEFTOP 06FS-2/1 -M RIGHT EXTERNAL DOOR	<table border="1"> <thead> <tr> <th>Code</th> <th>Description</th> <th>Qty</th> <th>UOM</th> </tr> </thead> <tbody> <tr> <td>0B1167A0</td> <td>EXT. GLASS SUPPORT PROFILE</td> <td>2</td> <td>PZ</td> </tr> <tr> <td>0B1218B0</td> <td></td> <td>1</td> <td>PZ</td> </tr> <tr> <td>0B1219A1</td> <td>MM DOUBLE GLASS DOOR INT UPPER BEAM 860</td> <td>1</td> <td>PZ</td> </tr> <tr> <td>0H7321A0</td> <td>MM STAINLESS STEEL HANDLE COVE</td> <td>1</td> <td>PZ</td> </tr> <tr> <td>CE1052A1</td> <td>CABLE CONNECTION CONTROL - USB MM 750M</td> <td>1</td> <td>PZ</td> </tr> <tr> <td>CE1053B0</td> <td>MM MICROFIT LED BAR POWER SUPPLY CABL</td> <td>1</td> <td>PZ</td> </tr> <tr> <td>CE1097A0</td> <td>4M SIHF 4 POLES MICROFIT CANBUS</td> <td>1</td> <td>PZ</td> </tr> <tr> <td>CE1285A0</td> <td>EMI ROUND FERRITE MOD.26438015 02</td> <td>1</td> <td>PZ</td> </tr> <tr> <td>IP1508A1</td> <td>POLYSTYREN E U SHAPED PROFILE 2000X60X60</td> <td>2</td> <td>M</td> </tr> <tr> <td>LP1020A0</td> <td>6 SERIES L400 LED LIGHT BAR - E583</td> <td>1</td> <td>PZ</td> </tr> <tr> <td>LP1026A0</td> <td>L=583 S6 NO LED LIGHT BAR COVER</td> <td>1</td> <td>PZ</td> </tr> <tr> <td>MG1099A1</td> <td></td> <td>1</td> <td>PZ</td> </tr> <tr> <td>RC1200A0</td> <td>ED=4 WIRE D.=0.5 COMPRESSIO N SPRING</td> <td>8</td> <td>PZ</td> </tr> <tr> <td>SL1155A1</td> <td>LOCTITE BICOMPONEN T SILICON</td> <td>80</td> <td>ML</td> </tr> <tr> <td>SL1170A1</td> <td>S57 BLACK SILICON - 310ML CARTRIDGE</td> <td>42</td> <td>ML</td> </tr> <tr> <td>VE1030A1</td> <td>MAGNET FOR DOOR MICROSWITC H D=22,9MM</td> <td>2</td> <td>PZ</td> </tr> </tbody> </table>	Code	Description	Qty	UOM	0B1167A0	EXT. GLASS SUPPORT PROFILE	2	PZ	0B1218B0		1	PZ	0B1219A1	MM DOUBLE GLASS DOOR INT UPPER BEAM 860	1	PZ	0H7321A0	MM STAINLESS STEEL HANDLE COVE	1	PZ	CE1052A1	CABLE CONNECTION CONTROL - USB MM 750M	1	PZ	CE1053B0	MM MICROFIT LED BAR POWER SUPPLY CABL	1	PZ	CE1097A0	4M SIHF 4 POLES MICROFIT CANBUS	1	PZ	CE1285A0	EMI ROUND FERRITE MOD.26438015 02	1	PZ	IP1508A1	POLYSTYREN E U SHAPED PROFILE 2000X60X60	2	M	LP1020A0	6 SERIES L400 LED LIGHT BAR - E583	1	PZ	LP1026A0	L=583 S6 NO LED LIGHT BAR COVER	1	PZ	MG1099A1		1	PZ	RC1200A0	ED=4 WIRE D.=0.5 COMPRESSIO N SPRING	8	PZ	SL1155A1	LOCTITE BICOMPONEN T SILICON	80	ML	SL1170A1	S57 BLACK SILICON - 310ML CARTRIDGE	42	ML	VE1030A1	MAGNET FOR DOOR MICROSWITC H D=22,9MM	2	PZ
					Code	Description	Qty	UOM																																																																	
					0B1167A0	EXT. GLASS SUPPORT PROFILE	2	PZ																																																																	
					0B1218B0		1	PZ																																																																	
					0B1219A1	MM DOUBLE GLASS DOOR INT UPPER BEAM 860	1	PZ																																																																	
					0H7321A0	MM STAINLESS STEEL HANDLE COVE	1	PZ																																																																	
					CE1052A1	CABLE CONNECTION CONTROL - USB MM 750M	1	PZ																																																																	
					CE1053B0	MM MICROFIT LED BAR POWER SUPPLY CABL	1	PZ																																																																	
					CE1097A0	4M SIHF 4 POLES MICROFIT CANBUS	1	PZ																																																																	
					CE1285A0	EMI ROUND FERRITE MOD.26438015 02	1	PZ																																																																	
					IP1508A1	POLYSTYREN E U SHAPED PROFILE 2000X60X60	2	M																																																																	
					LP1020A0	6 SERIES L400 LED LIGHT BAR - E583	1	PZ																																																																	
					LP1026A0	L=583 S6 NO LED LIGHT BAR COVER	1	PZ																																																																	
					MG1099A1		1	PZ																																																																	
					RC1200A0	ED=4 WIRE D.=0.5 COMPRESSIO N SPRING	8	PZ																																																																	
					SL1155A1	LOCTITE BICOMPONEN T SILICON	80	ML																																																																	
					SL1170A1	S57 BLACK SILICON - 310ML CARTRIDGE	42	ML																																																																	
					VE1030A1	MAGNET FOR DOOR MICROSWITC H D=22,9MM	2	PZ																																																																	



COMPONENT			SPARE PART																																																																																						
Code	Description	Image	Code	Description	Components list																																																																																				
VT1291A	XEBC-06EU-E EXTERNAL GLASS		KDR1306B	CHEFTOP 06FS-2/1 -M RIGHT EXTERNAL DOOR	<table border="1"> <thead> <tr> <th>Code</th> <th>Description</th> <th>Qty</th> <th>UOM</th> </tr> </thead> <tbody> <tr> <td>VI0239A1</td> <td>SELF-TAPPIN G SCREW 4.2X25 TCB+ INOX</td> <td>4</td> <td>PZ</td> </tr> <tr> <td>VI1103A0</td> <td>40X12 TBSP SCREW FOR PLASTIC</td> <td>2</td> <td>PZ</td> </tr> <tr> <td>VI1220A1</td> <td>4,2X12 TCB SELF-TAPPIN G SCREW</td> <td>26</td> <td>PZ</td> </tr> <tr> <td>VI1930A1</td> <td>ST. STEEL 5X20 CHIP SCREW</td> <td>16</td> <td>PZ</td> </tr> <tr> <td>VI1996A0</td> <td>M5X35 SCREW</td> <td>13</td> <td>PZ</td> </tr> <tr> <td>VM1059A1</td> <td>HEAT SHRINK FILM H800</td> <td>1</td> <td>M</td> </tr> <tr> <td>VM1182B1</td> <td>E. S. CT BT HANDLE JUNCTION + PIN GUIDE</td> <td>1</td> <td>PZ</td> </tr> <tr> <td>VM1490A0</td> <td>CHEFTOP/BAK ERTOP HANDLE SCREWS COVER</td> <td>2</td> <td>PZ</td> </tr> <tr> <td>VM1630A1</td> <td>INTERNAL GLASS PUSHING CAP</td> <td>3</td> <td>PZ</td> </tr> <tr> <td>VM1631A0</td> <td>PLUS INNER GLASS PUSHING CAP</td> <td>3</td> <td>PZ</td> </tr> <tr> <td>VM1695A0</td> <td>HANDLE POSITION PIN</td> <td>4</td> <td>PZ</td> </tr> <tr> <td>VM2245A0</td> <td>HANDLE SHAFT WITH LATCH</td> <td>1</td> <td>PZ</td> </tr> <tr> <td>VM2247B0</td> <td>HANDLE SHAFT COVER VM2245-2246</td> <td>1</td> <td>PZ</td> </tr> <tr> <td>VM2248B0</td> <td>HANDLE WITH LATCH CLOSING KEY</td> <td>1</td> <td>PZ</td> </tr> <tr> <td>VM2259B0</td> <td></td> <td>1</td> <td>PZ</td> </tr> <tr> <td>VM2260B0</td> <td>S6 LEFT UPPER CAP</td> <td>1</td> <td>PZ</td> </tr> <tr> <td>VM2261B0</td> <td></td> <td>1</td> <td>PZ</td> </tr> <tr> <td>VM2262B0</td> <td></td> <td>1</td> <td>PZ</td> </tr> <tr> <td>VM2267A0</td> <td>INTERNAL GLASS LOCKING SYSTEM SLIDER</td> <td>2</td> <td>PZ</td> </tr> <tr> <td>VM2268A0</td> <td>DOOR MAGNET COVER</td> <td>2</td> <td>PZ</td> </tr> </tbody> </table>	Code	Description	Qty	UOM	VI0239A1	SELF-TAPPIN G SCREW 4.2X25 TCB+ INOX	4	PZ	VI1103A0	40X12 TBSP SCREW FOR PLASTIC	2	PZ	VI1220A1	4,2X12 TCB SELF-TAPPIN G SCREW	26	PZ	VI1930A1	ST. STEEL 5X20 CHIP SCREW	16	PZ	VI1996A0	M5X35 SCREW	13	PZ	VM1059A1	HEAT SHRINK FILM H800	1	M	VM1182B1	E. S. CT BT HANDLE JUNCTION + PIN GUIDE	1	PZ	VM1490A0	CHEFTOP/BAK ERTOP HANDLE SCREWS COVER	2	PZ	VM1630A1	INTERNAL GLASS PUSHING CAP	3	PZ	VM1631A0	PLUS INNER GLASS PUSHING CAP	3	PZ	VM1695A0	HANDLE POSITION PIN	4	PZ	VM2245A0	HANDLE SHAFT WITH LATCH	1	PZ	VM2247B0	HANDLE SHAFT COVER VM2245-2246	1	PZ	VM2248B0	HANDLE WITH LATCH CLOSING KEY	1	PZ	VM2259B0		1	PZ	VM2260B0	S6 LEFT UPPER CAP	1	PZ	VM2261B0		1	PZ	VM2262B0		1	PZ	VM2267A0	INTERNAL GLASS LOCKING SYSTEM SLIDER	2	PZ	VM2268A0	DOOR MAGNET COVER	2	PZ
Code	Description	Qty	UOM																																																																																						
VI0239A1	SELF-TAPPIN G SCREW 4.2X25 TCB+ INOX	4	PZ																																																																																						
VI1103A0	40X12 TBSP SCREW FOR PLASTIC	2	PZ																																																																																						
VI1220A1	4,2X12 TCB SELF-TAPPIN G SCREW	26	PZ																																																																																						
VI1930A1	ST. STEEL 5X20 CHIP SCREW	16	PZ																																																																																						
VI1996A0	M5X35 SCREW	13	PZ																																																																																						
VM1059A1	HEAT SHRINK FILM H800	1	M																																																																																						
VM1182B1	E. S. CT BT HANDLE JUNCTION + PIN GUIDE	1	PZ																																																																																						
VM1490A0	CHEFTOP/BAK ERTOP HANDLE SCREWS COVER	2	PZ																																																																																						
VM1630A1	INTERNAL GLASS PUSHING CAP	3	PZ																																																																																						
VM1631A0	PLUS INNER GLASS PUSHING CAP	3	PZ																																																																																						
VM1695A0	HANDLE POSITION PIN	4	PZ																																																																																						
VM2245A0	HANDLE SHAFT WITH LATCH	1	PZ																																																																																						
VM2247B0	HANDLE SHAFT COVER VM2245-2246	1	PZ																																																																																						
VM2248B0	HANDLE WITH LATCH CLOSING KEY	1	PZ																																																																																						
VM2259B0		1	PZ																																																																																						
VM2260B0	S6 LEFT UPPER CAP	1	PZ																																																																																						
VM2261B0		1	PZ																																																																																						
VM2262B0		1	PZ																																																																																						
VM2267A0	INTERNAL GLASS LOCKING SYSTEM SLIDER	2	PZ																																																																																						
VM2268A0	DOOR MAGNET COVER	2	PZ																																																																																						



COMPONENT			SPARE PART																																																																												
Code	Description	Image	Code	Description	Components list																																																																										
VT1291A	XEBC-06EU-E EXTERNAL GLASS		KDR1306B	CHEFTOP 06FS-2/1 -M RIGHT EXTERNAL DOOR	<table border="1"> <thead> <tr> <th>Code</th> <th>Description</th> <th>Qty</th> <th>UOM</th> </tr> </thead> <tbody> <tr> <td>VM2269B0</td> <td>INNER GLASS FIXING CAP</td> <td>2</td> <td>PZ</td> </tr> <tr> <td>VM2274A0</td> <td>GROOVED BUSHING</td> <td>1</td> <td>PZ</td> </tr> <tr> <td>VM2275A0</td> <td>SMOOTH BUSHING</td> <td>1</td> <td>PZ</td> </tr> <tr> <td>VM2285B0</td> <td>860 SERIES DRIP PROFILE KIT</td> <td>1</td> <td>PZ</td> </tr> <tr> <td>VM2295A1</td> <td>MIND.MAPS TOUCH CONTROL STYLUS KIT</td> <td>1</td> <td>PZ</td> </tr> <tr> <td>VM2305A0</td> <td>6 SERIES DOOR CAP FIXING PAWL</td> <td>14</td> <td>PZ</td> </tr> <tr> <td>VM2312A0</td> <td>6 S. DRIP PROFILE DRAIN LEFT PIPE</td> <td>1</td> <td>PZ</td> </tr> <tr> <td>VM2314A0</td> <td>6 S. DRIP PROFILE CAP</td> <td>1</td> <td>PZ</td> </tr> <tr> <td>VM2315B0</td> <td>S6 INTERNAL GLASS SUPPORT</td> <td>3</td> <td>PZ</td> </tr> <tr> <td>VM2410A0</td> <td>PLATE TO STOP EXTRUDED LED BAR</td> <td>2</td> <td>PZ</td> </tr> <tr> <td>VM2505B0</td> <td>MM PLUS INTERNAL GLASS SUPPORT</td> <td>3</td> <td>PZ</td> </tr> <tr> <td>VM2518A0</td> <td>BOARD COOLING FAN SUPPORT</td> <td>1</td> <td>PZ</td> </tr> <tr> <td>VN1179A1</td> <td>CONTROL BOARD 40X40X20MM 12V COOLING FAN</td> <td>1</td> <td>PZ</td> </tr> <tr> <td>VP1076A0</td> <td>PLUS ONE ZERO HANDLE PIN</td> <td>1</td> <td>PZ</td> </tr> <tr> <td>VP1080A0</td> <td>UPPER HINGE CAP FOR LOWER INNER GLASS</td> <td>1</td> <td>PZ</td> </tr> <tr> <td>VP1081A0</td> <td>UPPER HINGE CAP FOR UPPER INNER GLASS</td> <td>1</td> <td>PZ</td> </tr> <tr> <td>VT1291A0</td> <td>XEBC-06EU-E EXTERNAL GLASS</td> <td></td> <td></td> <td>1</td> <td>PZ</td> </tr> </tbody> </table>	Code	Description	Qty	UOM	VM2269B0	INNER GLASS FIXING CAP	2	PZ	VM2274A0	GROOVED BUSHING	1	PZ	VM2275A0	SMOOTH BUSHING	1	PZ	VM2285B0	860 SERIES DRIP PROFILE KIT	1	PZ	VM2295A1	MIND.MAPS TOUCH CONTROL STYLUS KIT	1	PZ	VM2305A0	6 SERIES DOOR CAP FIXING PAWL	14	PZ	VM2312A0	6 S. DRIP PROFILE DRAIN LEFT PIPE	1	PZ	VM2314A0	6 S. DRIP PROFILE CAP	1	PZ	VM2315B0	S6 INTERNAL GLASS SUPPORT	3	PZ	VM2410A0	PLATE TO STOP EXTRUDED LED BAR	2	PZ	VM2505B0	MM PLUS INTERNAL GLASS SUPPORT	3	PZ	VM2518A0	BOARD COOLING FAN SUPPORT	1	PZ	VN1179A1	CONTROL BOARD 40X40X20MM 12V COOLING FAN	1	PZ	VP1076A0	PLUS ONE ZERO HANDLE PIN	1	PZ	VP1080A0	UPPER HINGE CAP FOR LOWER INNER GLASS	1	PZ	VP1081A0	UPPER HINGE CAP FOR UPPER INNER GLASS	1	PZ	VT1291A0	XEBC-06EU-E EXTERNAL GLASS			1	PZ
Code	Description	Qty	UOM																																																																												
VM2269B0	INNER GLASS FIXING CAP	2	PZ																																																																												
VM2274A0	GROOVED BUSHING	1	PZ																																																																												
VM2275A0	SMOOTH BUSHING	1	PZ																																																																												
VM2285B0	860 SERIES DRIP PROFILE KIT	1	PZ																																																																												
VM2295A1	MIND.MAPS TOUCH CONTROL STYLUS KIT	1	PZ																																																																												
VM2305A0	6 SERIES DOOR CAP FIXING PAWL	14	PZ																																																																												
VM2312A0	6 S. DRIP PROFILE DRAIN LEFT PIPE	1	PZ																																																																												
VM2314A0	6 S. DRIP PROFILE CAP	1	PZ																																																																												
VM2315B0	S6 INTERNAL GLASS SUPPORT	3	PZ																																																																												
VM2410A0	PLATE TO STOP EXTRUDED LED BAR	2	PZ																																																																												
VM2505B0	MM PLUS INTERNAL GLASS SUPPORT	3	PZ																																																																												
VM2518A0	BOARD COOLING FAN SUPPORT	1	PZ																																																																												
VN1179A1	CONTROL BOARD 40X40X20MM 12V COOLING FAN	1	PZ																																																																												
VP1076A0	PLUS ONE ZERO HANDLE PIN	1	PZ																																																																												
VP1080A0	UPPER HINGE CAP FOR LOWER INNER GLASS	1	PZ																																																																												
VP1081A0	UPPER HINGE CAP FOR UPPER INNER GLASS	1	PZ																																																																												
VT1291A0	XEBC-06EU-E EXTERNAL GLASS			1	PZ																																																																										



COMPONENT			SPARE PART																																																																																		
Code	Description	Image	Code	Description	Components list																																																																																
VT1291A	XEBC-06EU-E EXTERNAL GLASS		KDR1306A	CHEFTOP 06FS-2/1 RIGHT EXTERNAL DOOR	<table border="1"> <thead> <tr> <th>Code</th> <th>Description</th> <th>Qty</th> <th>UOM</th> </tr> </thead> <tbody> <tr> <td>0B1111A0</td> <td>XEVC-0711-E LEFT EXT DOOR COLUM</td> <td>1</td> <td>PZ</td> </tr> <tr> <td>0B1112A2</td> <td>0711 RIGHT - DOOR LEFT INT COLUMN</td> <td>1</td> <td>PZ</td> </tr> <tr> <td>0B1113A0</td> <td>XEVC-0711-E RIGHT EXT DOOR COLUM</td> <td>1</td> <td>PZ</td> </tr> <tr> <td>0B1113B0</td> <td></td> <td>1</td> <td>PZ</td> </tr> <tr> <td>0B1113B1</td> <td></td> <td>1</td> <td>PZ</td> </tr> <tr> <td>0B1114A2</td> <td>0711 RIGHT - DOOR RIGHT INT COLUMN</td> <td>1</td> <td>PZ</td> </tr> <tr> <td>0B1126A1</td> <td></td> <td>1</td> <td>PZ</td> </tr> <tr> <td>0B1167A0</td> <td>EXT. GLASS SUPPORT PROFILE</td> <td>2</td> <td>PZ</td> </tr> <tr> <td>0B1218A1</td> <td></td> <td>1</td> <td>PZ</td> </tr> <tr> <td>0B1219A1</td> <td>MM DOUBLE GLASS DOOR INT UPPER BEAM 860</td> <td>1</td> <td>PZ</td> </tr> <tr> <td>0H7321A0</td> <td>MM STAINLESS STEEL HANDLE COVE</td> <td>1</td> <td>PZ</td> </tr> <tr> <td>CE1052A1</td> <td>CABLE CONNECTION CONTROL - USB MM 750M</td> <td>1</td> <td>PZ</td> </tr> <tr> <td>CE1053B0</td> <td>MM MICROFIT LED BAR POWER SUPPLY CABL</td> <td>1</td> <td>PZ</td> </tr> <tr> <td>CE1285A0</td> <td>EMI ROUND FERRITE MOD.26438015 02</td> <td>1</td> <td>PZ</td> </tr> <tr> <td>CE1290A0</td> <td>EXTRACTABL E FEMALE TERMINAL CPF 5/4</td> <td>1</td> <td>PZ</td> </tr> <tr> <td>CE1455A0</td> <td>TIP END FITTING</td> <td>4</td> <td>PZ</td> </tr> <tr> <td>CE1725A0</td> <td>ROBOTICS SILICON PIPE 4X0,5 MMQ</td> <td>4</td> <td>M</td> </tr> <tr> <td>CE1735A0</td> <td>MINIFIT FEMALE END FITTING</td> <td>4</td> <td>PZ</td> </tr> <tr> <td>CE1755A0</td> <td>4 WAYS MALE MINIFIT CONNECTOR</td> <td>1</td> <td>PZ</td> </tr> </tbody> </table>	Code	Description	Qty	UOM	0B1111A0	XEVC-0711-E LEFT EXT DOOR COLUM	1	PZ	0B1112A2	0711 RIGHT - DOOR LEFT INT COLUMN	1	PZ	0B1113A0	XEVC-0711-E RIGHT EXT DOOR COLUM	1	PZ	0B1113B0		1	PZ	0B1113B1		1	PZ	0B1114A2	0711 RIGHT - DOOR RIGHT INT COLUMN	1	PZ	0B1126A1		1	PZ	0B1167A0	EXT. GLASS SUPPORT PROFILE	2	PZ	0B1218A1		1	PZ	0B1219A1	MM DOUBLE GLASS DOOR INT UPPER BEAM 860	1	PZ	0H7321A0	MM STAINLESS STEEL HANDLE COVE	1	PZ	CE1052A1	CABLE CONNECTION CONTROL - USB MM 750M	1	PZ	CE1053B0	MM MICROFIT LED BAR POWER SUPPLY CABL	1	PZ	CE1285A0	EMI ROUND FERRITE MOD.26438015 02	1	PZ	CE1290A0	EXTRACTABL E FEMALE TERMINAL CPF 5/4	1	PZ	CE1455A0	TIP END FITTING	4	PZ	CE1725A0	ROBOTICS SILICON PIPE 4X0,5 MMQ	4	M	CE1735A0	MINIFIT FEMALE END FITTING	4	PZ	CE1755A0	4 WAYS MALE MINIFIT CONNECTOR	1	PZ
Code	Description	Qty	UOM																																																																																		
0B1111A0	XEVC-0711-E LEFT EXT DOOR COLUM	1	PZ																																																																																		
0B1112A2	0711 RIGHT - DOOR LEFT INT COLUMN	1	PZ																																																																																		
0B1113A0	XEVC-0711-E RIGHT EXT DOOR COLUM	1	PZ																																																																																		
0B1113B0		1	PZ																																																																																		
0B1113B1		1	PZ																																																																																		
0B1114A2	0711 RIGHT - DOOR RIGHT INT COLUMN	1	PZ																																																																																		
0B1126A1		1	PZ																																																																																		
0B1167A0	EXT. GLASS SUPPORT PROFILE	2	PZ																																																																																		
0B1218A1		1	PZ																																																																																		
0B1219A1	MM DOUBLE GLASS DOOR INT UPPER BEAM 860	1	PZ																																																																																		
0H7321A0	MM STAINLESS STEEL HANDLE COVE	1	PZ																																																																																		
CE1052A1	CABLE CONNECTION CONTROL - USB MM 750M	1	PZ																																																																																		
CE1053B0	MM MICROFIT LED BAR POWER SUPPLY CABL	1	PZ																																																																																		
CE1285A0	EMI ROUND FERRITE MOD.26438015 02	1	PZ																																																																																		
CE1290A0	EXTRACTABL E FEMALE TERMINAL CPF 5/4	1	PZ																																																																																		
CE1455A0	TIP END FITTING	4	PZ																																																																																		
CE1725A0	ROBOTICS SILICON PIPE 4X0,5 MMQ	4	M																																																																																		
CE1735A0	MINIFIT FEMALE END FITTING	4	PZ																																																																																		
CE1755A0	4 WAYS MALE MINIFIT CONNECTOR	1	PZ																																																																																		



COMPONENT			SPARE PART																																																																														
Code	Description	Image	Code	Description	Components list																																																																												
VT1291A	XEBC-06EU-E EXTERNAL GLASS		KDR1306A	CHEFTOP 06FS-2/1 RIGHT EXTERNAL DOOR	<table border="1"> <thead> <tr> <th>Code</th> <th>Description</th> <th>Qty</th> <th>UOM</th> </tr> </thead> <tbody> <tr> <td>IP1508A1</td> <td>POLYSTYREN E U SHAPED PROFILE 2000X60X60</td> <td>2</td> <td>M</td> </tr> <tr> <td>LP1020A0</td> <td>6 SERIES L400 LED LIGHT BAR - E583</td> <td>1</td> <td>PZ</td> </tr> <tr> <td>LP1026A0</td> <td>L=583 S6 NO LED LIGHT BAR COVER</td> <td>1</td> <td>PZ</td> </tr> <tr> <td>MG1083A2</td> <td></td> <td>1</td> <td>PZ</td> </tr> <tr> <td>RC1200A0</td> <td>ED=4 WIRE D.=0.5 COMPRESSIO N SPRING</td> <td>4</td> <td>PZ</td> </tr> <tr> <td>SL1170A1</td> <td>S57 BLACK SILICON - 310ML CARTRIDGE</td> <td>42</td> <td>ML</td> </tr> <tr> <td>VE1030A1</td> <td>MAGNET FOR DOOR MICROSWITC H D=22.9MM</td> <td>2</td> <td>PZ</td> </tr> <tr> <td>VI1220A1</td> <td>4,2X12 TCB SELF-TAPPIN G SCREW</td> <td>26</td> <td>PZ</td> </tr> <tr> <td>VI1930A1</td> <td>ST. STEEL 5X20 CHIP SCREW</td> <td>16</td> <td>PZ</td> </tr> <tr> <td>VI1996A0</td> <td>M5X35 SCREW</td> <td>13</td> <td>PZ</td> </tr> <tr> <td>VM1059A1</td> <td>HEAT SHRINK FILM H800</td> <td>1</td> <td>M</td> </tr> <tr> <td>VM1182B1</td> <td>E S. CT BT HANDLE JUNCTION + PIN GUIDE</td> <td>1</td> <td>PZ</td> </tr> <tr> <td>VM1183C0</td> <td>CT BT HANDLE T-SHAPED PIN KIT</td> <td>1</td> <td>PZ</td> </tr> <tr> <td>VM1183C1</td> <td>CT BT HANDLE T-SHAPED PIN KIT</td> <td>1</td> <td>PZ</td> </tr> <tr> <td>VM1630A1</td> <td>INTERNAL GLASS PUSHING CAP</td> <td>2</td> <td>PZ</td> </tr> <tr> <td>VM1695A0</td> <td>HANDLE POSITION PIN</td> <td>4</td> <td>PZ</td> </tr> <tr> <td>VM2245A0</td> <td>HANDLE SHAFT WITH LATCH</td> <td>1</td> <td>PZ</td> </tr> <tr> <td>VM2247B0</td> <td>HANDLE SHAFT COVER VM2245-2246</td> <td>1</td> <td>PZ</td> </tr> </tbody> </table>	Code	Description	Qty	UOM	IP1508A1	POLYSTYREN E U SHAPED PROFILE 2000X60X60	2	M	LP1020A0	6 SERIES L400 LED LIGHT BAR - E583	1	PZ	LP1026A0	L=583 S6 NO LED LIGHT BAR COVER	1	PZ	MG1083A2		1	PZ	RC1200A0	ED=4 WIRE D.=0.5 COMPRESSIO N SPRING	4	PZ	SL1170A1	S57 BLACK SILICON - 310ML CARTRIDGE	42	ML	VE1030A1	MAGNET FOR DOOR MICROSWITC H D=22.9MM	2	PZ	VI1220A1	4,2X12 TCB SELF-TAPPIN G SCREW	26	PZ	VI1930A1	ST. STEEL 5X20 CHIP SCREW	16	PZ	VI1996A0	M5X35 SCREW	13	PZ	VM1059A1	HEAT SHRINK FILM H800	1	M	VM1182B1	E S. CT BT HANDLE JUNCTION + PIN GUIDE	1	PZ	VM1183C0	CT BT HANDLE T-SHAPED PIN KIT	1	PZ	VM1183C1	CT BT HANDLE T-SHAPED PIN KIT	1	PZ	VM1630A1	INTERNAL GLASS PUSHING CAP	2	PZ	VM1695A0	HANDLE POSITION PIN	4	PZ	VM2245A0	HANDLE SHAFT WITH LATCH	1	PZ	VM2247B0	HANDLE SHAFT COVER VM2245-2246	1	PZ
Code	Description	Qty	UOM																																																																														
IP1508A1	POLYSTYREN E U SHAPED PROFILE 2000X60X60	2	M																																																																														
LP1020A0	6 SERIES L400 LED LIGHT BAR - E583	1	PZ																																																																														
LP1026A0	L=583 S6 NO LED LIGHT BAR COVER	1	PZ																																																																														
MG1083A2		1	PZ																																																																														
RC1200A0	ED=4 WIRE D.=0.5 COMPRESSIO N SPRING	4	PZ																																																																														
SL1170A1	S57 BLACK SILICON - 310ML CARTRIDGE	42	ML																																																																														
VE1030A1	MAGNET FOR DOOR MICROSWITC H D=22.9MM	2	PZ																																																																														
VI1220A1	4,2X12 TCB SELF-TAPPIN G SCREW	26	PZ																																																																														
VI1930A1	ST. STEEL 5X20 CHIP SCREW	16	PZ																																																																														
VI1996A0	M5X35 SCREW	13	PZ																																																																														
VM1059A1	HEAT SHRINK FILM H800	1	M																																																																														
VM1182B1	E S. CT BT HANDLE JUNCTION + PIN GUIDE	1	PZ																																																																														
VM1183C0	CT BT HANDLE T-SHAPED PIN KIT	1	PZ																																																																														
VM1183C1	CT BT HANDLE T-SHAPED PIN KIT	1	PZ																																																																														
VM1630A1	INTERNAL GLASS PUSHING CAP	2	PZ																																																																														
VM1695A0	HANDLE POSITION PIN	4	PZ																																																																														
VM2245A0	HANDLE SHAFT WITH LATCH	1	PZ																																																																														
VM2247B0	HANDLE SHAFT COVER VM2245-2246	1	PZ																																																																														



COMPONENT			SPARE PART																																																																														
Code	Description	Image	Code	Description	Components list																																																																												
VT1291A	XEBC-06EU-E EXTERNAL GLASS		KDR1306A	CHEFTOP 06FS-2/1 RIGHT EXTERNAL DOOR	<table border="1"> <thead> <tr> <th>Code</th> <th>Description</th> <th>Qty</th> <th>UOM</th> </tr> </thead> <tbody> <tr> <td>VM2248B0</td> <td>HANDLE WITH LATCH CLOSING KEY</td> <td>1</td> <td>PZ</td> </tr> <tr> <td>VM2259A1</td> <td>6 SERIES DOOR LOWER LEFT CAP</td> <td>1</td> <td>PZ</td> </tr> <tr> <td>VM2260A1</td> <td>6 SERIES DOOR UPPER LEFT CAP</td> <td>1</td> <td>PZ</td> </tr> <tr> <td>VM2261A1</td> <td>6 SERIES DOOR LOWER RIGHT CAP</td> <td>1</td> <td>PZ</td> </tr> <tr> <td>VM2262A1</td> <td>6 SERIES DOOR UPPER RIGHT CAP</td> <td>1</td> <td>PZ</td> </tr> <tr> <td>VM2267A0</td> <td>INTERNAL GLASS LOCKING SYSTEM SLIDER</td> <td>2</td> <td>PZ</td> </tr> <tr> <td>VM2268A0</td> <td>DOOR MAGNET COVER</td> <td>2</td> <td>PZ</td> </tr> <tr> <td>VM2269A0</td> <td>INTERNAL GLASS LOCKING SYSTEM CAP</td> <td>2</td> <td>PZ</td> </tr> <tr> <td>VM2274A0</td> <td>GROOVED BUSHING</td> <td>1</td> <td>PZ</td> </tr> <tr> <td>VM2275A0</td> <td>SMOOTH BUSHING</td> <td>1</td> <td>PZ</td> </tr> <tr> <td>VM2285A0</td> <td>860 SERIES DRIP PROFILE</td> <td>1</td> <td>PZ</td> </tr> <tr> <td>VM2295A0</td> <td>STYLUS PEN FOR MM</td> <td>1</td> <td>PZ</td> </tr> <tr> <td>VM2305A0</td> <td>6 SERIES DOOR CAP FIXING PAWL</td> <td>14</td> <td>PZ</td> </tr> <tr> <td>VM2312A0</td> <td>6 S. DRIP PROFILE DRAIN LEFT PIPE</td> <td>1</td> <td>PZ</td> </tr> <tr> <td>VM2313A0</td> <td>TUBE DX DISCHARGE DRIP MM</td> <td>1</td> <td>PZ</td> </tr> <tr> <td>VM2314A0</td> <td>6 S. DRIP PROFILE CAP</td> <td>2</td> <td>PZ</td> </tr> <tr> <td>VM2315A0</td> <td>MIND.MAPS INTERNAL GLASS CAP SUPPORT</td> <td>2</td> <td>PZ</td> </tr> <tr> <td>VM2371A0</td> <td>DOUBLE GLASS DOOR PUSHING BRACKET</td> <td>2</td> <td>PZ</td> </tr> </tbody> </table>	Code	Description	Qty	UOM	VM2248B0	HANDLE WITH LATCH CLOSING KEY	1	PZ	VM2259A1	6 SERIES DOOR LOWER LEFT CAP	1	PZ	VM2260A1	6 SERIES DOOR UPPER LEFT CAP	1	PZ	VM2261A1	6 SERIES DOOR LOWER RIGHT CAP	1	PZ	VM2262A1	6 SERIES DOOR UPPER RIGHT CAP	1	PZ	VM2267A0	INTERNAL GLASS LOCKING SYSTEM SLIDER	2	PZ	VM2268A0	DOOR MAGNET COVER	2	PZ	VM2269A0	INTERNAL GLASS LOCKING SYSTEM CAP	2	PZ	VM2274A0	GROOVED BUSHING	1	PZ	VM2275A0	SMOOTH BUSHING	1	PZ	VM2285A0	860 SERIES DRIP PROFILE	1	PZ	VM2295A0	STYLUS PEN FOR MM	1	PZ	VM2305A0	6 SERIES DOOR CAP FIXING PAWL	14	PZ	VM2312A0	6 S. DRIP PROFILE DRAIN LEFT PIPE	1	PZ	VM2313A0	TUBE DX DISCHARGE DRIP MM	1	PZ	VM2314A0	6 S. DRIP PROFILE CAP	2	PZ	VM2315A0	MIND.MAPS INTERNAL GLASS CAP SUPPORT	2	PZ	VM2371A0	DOUBLE GLASS DOOR PUSHING BRACKET	2	PZ
Code	Description	Qty	UOM																																																																														
VM2248B0	HANDLE WITH LATCH CLOSING KEY	1	PZ																																																																														
VM2259A1	6 SERIES DOOR LOWER LEFT CAP	1	PZ																																																																														
VM2260A1	6 SERIES DOOR UPPER LEFT CAP	1	PZ																																																																														
VM2261A1	6 SERIES DOOR LOWER RIGHT CAP	1	PZ																																																																														
VM2262A1	6 SERIES DOOR UPPER RIGHT CAP	1	PZ																																																																														
VM2267A0	INTERNAL GLASS LOCKING SYSTEM SLIDER	2	PZ																																																																														
VM2268A0	DOOR MAGNET COVER	2	PZ																																																																														
VM2269A0	INTERNAL GLASS LOCKING SYSTEM CAP	2	PZ																																																																														
VM2274A0	GROOVED BUSHING	1	PZ																																																																														
VM2275A0	SMOOTH BUSHING	1	PZ																																																																														
VM2285A0	860 SERIES DRIP PROFILE	1	PZ																																																																														
VM2295A0	STYLUS PEN FOR MM	1	PZ																																																																														
VM2305A0	6 SERIES DOOR CAP FIXING PAWL	14	PZ																																																																														
VM2312A0	6 S. DRIP PROFILE DRAIN LEFT PIPE	1	PZ																																																																														
VM2313A0	TUBE DX DISCHARGE DRIP MM	1	PZ																																																																														
VM2314A0	6 S. DRIP PROFILE CAP	2	PZ																																																																														
VM2315A0	MIND.MAPS INTERNAL GLASS CAP SUPPORT	2	PZ																																																																														
VM2371A0	DOUBLE GLASS DOOR PUSHING BRACKET	2	PZ																																																																														



COMPONENT			SPARE PART																																																							
Code	Description	Image	Code	Description	Components list																																																					
VT1291A	XEBC-06EU-E EXTERNAL GLASS		KDR1306A	CHEFTOP 06FS-2/1 RIGHT EXTERNAL DOOR	<table border="1"> <thead> <tr> <th>Code</th> <th>Description</th> <th>Qty</th> <th>UOM</th> </tr> </thead> <tbody> <tr> <td>VM2410A0</td> <td>PLATE TO STOP EXTRUDED LED BAR</td> <td>2</td> <td>PZ</td> </tr> <tr> <td>VM2518A0</td> <td>BOARD COOLING FAN SUPPORT</td> <td>1</td> <td>PZ</td> </tr> <tr> <td>VN1179A1</td> <td>CONTROL BOARD 40X40X20MM 12V COOLING FAN</td> <td>1</td> <td>PZ</td> </tr> <tr> <td>VT1291A0</td> <td>XEBC-06EU-E EXTERNAL GLASS</td> <td>1</td> <td>PZ</td> </tr> </tbody> </table>	Code	Description	Qty	UOM	VM2410A0	PLATE TO STOP EXTRUDED LED BAR	2	PZ	VM2518A0	BOARD COOLING FAN SUPPORT	1	PZ	VN1179A1	CONTROL BOARD 40X40X20MM 12V COOLING FAN	1	PZ	VT1291A0	XEBC-06EU-E EXTERNAL GLASS	1	PZ																																	
			Code	Description	Qty	UOM																																																				
VM2410A0	PLATE TO STOP EXTRUDED LED BAR	2	PZ																																																							
VM2518A0	BOARD COOLING FAN SUPPORT	1	PZ																																																							
VN1179A1	CONTROL BOARD 40X40X20MM 12V COOLING FAN	1	PZ																																																							
VT1291A0	XEBC-06EU-E EXTERNAL GLASS	1	PZ																																																							
KDR1273B	BT-06 -M EXTERNAL LEFT DOOR	<table border="1"> <thead> <tr> <th>Code</th> <th>Description</th> <th>Qty</th> <th>UOM</th> </tr> </thead> <tbody> <tr> <td>0B1126B0</td> <td></td> <td>1</td> <td>PZ</td> </tr> <tr> <td>0B1167A0</td> <td>EXT. GLASS SUPPORT PROFILE</td> <td>2</td> <td>PZ</td> </tr> <tr> <td>0B1198B0</td> <td></td> <td>1</td> <td>PZ</td> </tr> <tr> <td>0B1198B1</td> <td></td> <td>1</td> <td>PZ</td> </tr> <tr> <td>0B1199A2</td> <td>0711 LEFT - DOOR RIGHT INT COLUMN</td> <td>1</td> <td>PZ</td> </tr> <tr> <td>0B1200A2</td> <td>0711 LEFT - DOOR LEFT INT COLUMN</td> <td>1</td> <td>PZ</td> </tr> <tr> <td>0B1218B0</td> <td></td> <td>1</td> <td>PZ</td> </tr> <tr> <td>0B1219A1</td> <td>MM DOUBLE GLASS DOOR INT UPPER BEAM 860</td> <td>1</td> <td>PZ</td> </tr> <tr> <td>0B1231A0</td> <td>06EU LEFT - DOOR RIGHT EXT COLUMN</td> <td>1</td> <td>PZ</td> </tr> <tr> <td>0H7321A0</td> <td>MM STAINLESS STEEL HANDLE COVE</td> <td>1</td> <td>PZ</td> </tr> <tr> <td>CE1052A1</td> <td>CABLE CONNECTION CONTROL - USB MM 750M</td> <td>1</td> <td>PZ</td> </tr> <tr> <td>CE1053B0</td> <td>MM MICROFIT LED BAR POWER SUPPLY CABL</td> <td>1</td> <td>PZ</td> </tr> <tr> <td>CE1097A0</td> <td>4M SIHF 4 POLES MICROFIT CANBUS</td> <td>1</td> <td>PZ</td> </tr> </tbody> </table>	Code	Description	Qty	UOM	0B1126B0		1	PZ	0B1167A0	EXT. GLASS SUPPORT PROFILE	2	PZ	0B1198B0		1	PZ	0B1198B1		1	PZ	0B1199A2	0711 LEFT - DOOR RIGHT INT COLUMN	1	PZ	0B1200A2	0711 LEFT - DOOR LEFT INT COLUMN	1	PZ	0B1218B0		1	PZ	0B1219A1	MM DOUBLE GLASS DOOR INT UPPER BEAM 860	1	PZ	0B1231A0	06EU LEFT - DOOR RIGHT EXT COLUMN	1	PZ	0H7321A0	MM STAINLESS STEEL HANDLE COVE	1	PZ	CE1052A1	CABLE CONNECTION CONTROL - USB MM 750M	1	PZ	CE1053B0	MM MICROFIT LED BAR POWER SUPPLY CABL	1	PZ	CE1097A0	4M SIHF 4 POLES MICROFIT CANBUS	1	PZ
Code	Description	Qty	UOM																																																							
0B1126B0		1	PZ																																																							
0B1167A0	EXT. GLASS SUPPORT PROFILE	2	PZ																																																							
0B1198B0		1	PZ																																																							
0B1198B1		1	PZ																																																							
0B1199A2	0711 LEFT - DOOR RIGHT INT COLUMN	1	PZ																																																							
0B1200A2	0711 LEFT - DOOR LEFT INT COLUMN	1	PZ																																																							
0B1218B0		1	PZ																																																							
0B1219A1	MM DOUBLE GLASS DOOR INT UPPER BEAM 860	1	PZ																																																							
0B1231A0	06EU LEFT - DOOR RIGHT EXT COLUMN	1	PZ																																																							
0H7321A0	MM STAINLESS STEEL HANDLE COVE	1	PZ																																																							
CE1052A1	CABLE CONNECTION CONTROL - USB MM 750M	1	PZ																																																							
CE1053B0	MM MICROFIT LED BAR POWER SUPPLY CABL	1	PZ																																																							
CE1097A0	4M SIHF 4 POLES MICROFIT CANBUS	1	PZ																																																							





COMPONENT			SPARE PART																																																																										
Code	Description	Image	Code	Description	Components list																																																																								
VT1291A	XEBC-06EU-E EXTERNAL GLASS		KDR1273B	BT-06 -M EXTERNAL LEFT DOOR	<table border="1"> <thead> <tr> <th>Code</th> <th>Description</th> <th>Qty</th> <th>UOM</th> </tr> </thead> <tbody> <tr> <td>CE1285A0</td> <td>EMI ROUND FERRITE MOD.26438015 02</td> <td>1</td> <td>PZ</td> </tr> <tr> <td>IP1508A1</td> <td>POLYSTYREN E U SHAPED PROFILE 2000X60X60</td> <td>2</td> <td>M</td> </tr> <tr> <td>LP1020A0</td> <td>6 SERIES L400 LED LIGHT BAR - E583</td> <td>1</td> <td>PZ</td> </tr> <tr> <td>LP1026A0</td> <td>L=583 S6 NO LED LIGHT BAR COVER</td> <td>1</td> <td>PZ</td> </tr> <tr> <td>MG1099A1</td> <td></td> <td>1</td> <td>PZ</td> </tr> <tr> <td>RC1200A0</td> <td>ED=4 WIRE D.=0.5 COMPRESSIO N SPRING</td> <td>8</td> <td>PZ</td> </tr> <tr> <td>SL1155A1</td> <td>LOCTITE BICOMPONEN T SILICON</td> <td>80</td> <td>ML</td> </tr> <tr> <td>SL1170A1</td> <td>S57 BLACK SILICON - 310ML CARTRIDGE</td> <td>42</td> <td>ML</td> </tr> <tr> <td>VE1030A1</td> <td>MAGNET FOR DOOR MICROSWITC H D=22.9MM</td> <td>2</td> <td>PZ</td> </tr> <tr> <td>VI0239A1</td> <td>SELF-TAPPIN G SCREW 4.2X25 TCB+ INOX</td> <td>4</td> <td>PZ</td> </tr> <tr> <td>VH1103A0</td> <td>40X12 TBSP SCREW FOR PLASTIC</td> <td>2</td> <td>PZ</td> </tr> <tr> <td>VH1220A1</td> <td>4,2X12 TCB SELF-TAPPIN G SCREW</td> <td>27</td> <td>PZ</td> </tr> <tr> <td>VH1930A1</td> <td>ST. STEEL 5X20 CHIP SCREW</td> <td>16</td> <td>PZ</td> </tr> <tr> <td>VH1996A0</td> <td>M5X35 SCREW</td> <td>13</td> <td>PZ</td> </tr> <tr> <td>VM1059A1</td> <td>HEAT SHRINK FILM H800</td> <td>1</td> <td>M</td> </tr> <tr> <td>VM1182B1</td> <td>E.S. CT BT HANDLE JUNCTION + PIN GUIDE</td> <td>1</td> <td>PZ</td> </tr> <tr> <td>VM1490A0</td> <td>CHEFTOP/BAK ERTOP HANDLE SCREWS COVER</td> <td>2</td> <td>PZ</td> </tr> </tbody> </table>	Code	Description	Qty	UOM	CE1285A0	EMI ROUND FERRITE MOD.26438015 02	1	PZ	IP1508A1	POLYSTYREN E U SHAPED PROFILE 2000X60X60	2	M	LP1020A0	6 SERIES L400 LED LIGHT BAR - E583	1	PZ	LP1026A0	L=583 S6 NO LED LIGHT BAR COVER	1	PZ	MG1099A1		1	PZ	RC1200A0	ED=4 WIRE D.=0.5 COMPRESSIO N SPRING	8	PZ	SL1155A1	LOCTITE BICOMPONEN T SILICON	80	ML	SL1170A1	S57 BLACK SILICON - 310ML CARTRIDGE	42	ML	VE1030A1	MAGNET FOR DOOR MICROSWITC H D=22.9MM	2	PZ	VI0239A1	SELF-TAPPIN G SCREW 4.2X25 TCB+ INOX	4	PZ	VH1103A0	40X12 TBSP SCREW FOR PLASTIC	2	PZ	VH1220A1	4,2X12 TCB SELF-TAPPIN G SCREW	27	PZ	VH1930A1	ST. STEEL 5X20 CHIP SCREW	16	PZ	VH1996A0	M5X35 SCREW	13	PZ	VM1059A1	HEAT SHRINK FILM H800	1	M	VM1182B1	E.S. CT BT HANDLE JUNCTION + PIN GUIDE	1	PZ	VM1490A0	CHEFTOP/BAK ERTOP HANDLE SCREWS COVER	2	PZ
					Code	Description	Qty	UOM																																																																					
					CE1285A0	EMI ROUND FERRITE MOD.26438015 02	1	PZ																																																																					
					IP1508A1	POLYSTYREN E U SHAPED PROFILE 2000X60X60	2	M																																																																					
					LP1020A0	6 SERIES L400 LED LIGHT BAR - E583	1	PZ																																																																					
					LP1026A0	L=583 S6 NO LED LIGHT BAR COVER	1	PZ																																																																					
					MG1099A1		1	PZ																																																																					
					RC1200A0	ED=4 WIRE D.=0.5 COMPRESSIO N SPRING	8	PZ																																																																					
					SL1155A1	LOCTITE BICOMPONEN T SILICON	80	ML																																																																					
					SL1170A1	S57 BLACK SILICON - 310ML CARTRIDGE	42	ML																																																																					
					VE1030A1	MAGNET FOR DOOR MICROSWITC H D=22.9MM	2	PZ																																																																					
					VI0239A1	SELF-TAPPIN G SCREW 4.2X25 TCB+ INOX	4	PZ																																																																					
					VH1103A0	40X12 TBSP SCREW FOR PLASTIC	2	PZ																																																																					
					VH1220A1	4,2X12 TCB SELF-TAPPIN G SCREW	27	PZ																																																																					
					VH1930A1	ST. STEEL 5X20 CHIP SCREW	16	PZ																																																																					
					VH1996A0	M5X35 SCREW	13	PZ																																																																					
					VM1059A1	HEAT SHRINK FILM H800	1	M																																																																					
VM1182B1	E.S. CT BT HANDLE JUNCTION + PIN GUIDE	1	PZ																																																																										
VM1490A0	CHEFTOP/BAK ERTOP HANDLE SCREWS COVER	2	PZ																																																																										



COMPONENT			SPARE PART																																																																																		
Code	Description	Image	Code	Description	Components list																																																																																
VT1291A	XEBC-06EU-E EXTERNAL GLASS		KDR1273B	BT-06 -M EXTERNAL LEFT DOOR	<table border="1"> <thead> <tr> <th>Code</th> <th>Description</th> <th>Qty</th> <th>UOM</th> </tr> </thead> <tbody> <tr> <td>VM1630A1</td> <td>INTERNAL GLASS PUSHING CAP</td> <td>3</td> <td>PZ</td> </tr> <tr> <td>VM1631A0</td> <td>PLUS INNER GLASS PUSHING CAP</td> <td>2</td> <td>PZ</td> </tr> <tr> <td>VM1695A0</td> <td>HANDLE POSITION PIN</td> <td>4</td> <td>PZ</td> </tr> <tr> <td>VM2245A0</td> <td>HANDLE SHAFT WITH LATCH</td> <td>1</td> <td>PZ</td> </tr> <tr> <td>VM2247B0</td> <td>HANDLE SHAFT COVER VM2245-2246</td> <td>1</td> <td>PZ</td> </tr> <tr> <td>VM2248B0</td> <td>HANDLE WITH LATCH CLOSING KEY</td> <td>1</td> <td>PZ</td> </tr> <tr> <td>VM2267A0</td> <td>INTERNAL GLASS LOCKING SYSTEM SLIDER</td> <td>2</td> <td>PZ</td> </tr> <tr> <td>VM2268A0</td> <td>DOOR MAGNET COVER</td> <td>2</td> <td>PZ</td> </tr> <tr> <td>VM2269B0</td> <td>INNER GLASS FIXING CAP</td> <td>2</td> <td>PZ</td> </tr> <tr> <td>VM2274A0</td> <td>GROOVED BUSHING</td> <td>1</td> <td>PZ</td> </tr> <tr> <td>VM2275A0</td> <td>SMOOTH BUSHING</td> <td>1</td> <td>PZ</td> </tr> <tr> <td>VM2285B0</td> <td>860 SERIES DRIP PROFILE KIT</td> <td>1</td> <td>PZ</td> </tr> <tr> <td>VM2295A1</td> <td>MIND.MAPS TOUCH CONTROL STYLUS KIT</td> <td>1</td> <td>PZ</td> </tr> <tr> <td>VM2305A0</td> <td>6 SERIES DOOR CAP FIXING PAWL</td> <td>14</td> <td>PZ</td> </tr> <tr> <td>VM2313A0</td> <td>TUBE DX DISCHARGE DRIP MM</td> <td>1</td> <td>PZ</td> </tr> <tr> <td>VM2314A0</td> <td>6 S. DRIP PROFILE CAP</td> <td>1</td> <td>PZ</td> </tr> <tr> <td>VM2315B0</td> <td>S6 INTERNAL GLASS SUPPORT</td> <td>3</td> <td>PZ</td> </tr> <tr> <td>VM2383B0</td> <td>S6 LEFT OVENS UPPER RIGHT CAP</td> <td>1</td> <td>PZ</td> </tr> <tr> <td>VM2384B0</td> <td></td> <td>1</td> <td>PZ</td> </tr> </tbody> </table>	Code	Description	Qty	UOM	VM1630A1	INTERNAL GLASS PUSHING CAP	3	PZ	VM1631A0	PLUS INNER GLASS PUSHING CAP	2	PZ	VM1695A0	HANDLE POSITION PIN	4	PZ	VM2245A0	HANDLE SHAFT WITH LATCH	1	PZ	VM2247B0	HANDLE SHAFT COVER VM2245-2246	1	PZ	VM2248B0	HANDLE WITH LATCH CLOSING KEY	1	PZ	VM2267A0	INTERNAL GLASS LOCKING SYSTEM SLIDER	2	PZ	VM2268A0	DOOR MAGNET COVER	2	PZ	VM2269B0	INNER GLASS FIXING CAP	2	PZ	VM2274A0	GROOVED BUSHING	1	PZ	VM2275A0	SMOOTH BUSHING	1	PZ	VM2285B0	860 SERIES DRIP PROFILE KIT	1	PZ	VM2295A1	MIND.MAPS TOUCH CONTROL STYLUS KIT	1	PZ	VM2305A0	6 SERIES DOOR CAP FIXING PAWL	14	PZ	VM2313A0	TUBE DX DISCHARGE DRIP MM	1	PZ	VM2314A0	6 S. DRIP PROFILE CAP	1	PZ	VM2315B0	S6 INTERNAL GLASS SUPPORT	3	PZ	VM2383B0	S6 LEFT OVENS UPPER RIGHT CAP	1	PZ	VM2384B0		1	PZ
Code	Description	Qty	UOM																																																																																		
VM1630A1	INTERNAL GLASS PUSHING CAP	3	PZ																																																																																		
VM1631A0	PLUS INNER GLASS PUSHING CAP	2	PZ																																																																																		
VM1695A0	HANDLE POSITION PIN	4	PZ																																																																																		
VM2245A0	HANDLE SHAFT WITH LATCH	1	PZ																																																																																		
VM2247B0	HANDLE SHAFT COVER VM2245-2246	1	PZ																																																																																		
VM2248B0	HANDLE WITH LATCH CLOSING KEY	1	PZ																																																																																		
VM2267A0	INTERNAL GLASS LOCKING SYSTEM SLIDER	2	PZ																																																																																		
VM2268A0	DOOR MAGNET COVER	2	PZ																																																																																		
VM2269B0	INNER GLASS FIXING CAP	2	PZ																																																																																		
VM2274A0	GROOVED BUSHING	1	PZ																																																																																		
VM2275A0	SMOOTH BUSHING	1	PZ																																																																																		
VM2285B0	860 SERIES DRIP PROFILE KIT	1	PZ																																																																																		
VM2295A1	MIND.MAPS TOUCH CONTROL STYLUS KIT	1	PZ																																																																																		
VM2305A0	6 SERIES DOOR CAP FIXING PAWL	14	PZ																																																																																		
VM2313A0	TUBE DX DISCHARGE DRIP MM	1	PZ																																																																																		
VM2314A0	6 S. DRIP PROFILE CAP	1	PZ																																																																																		
VM2315B0	S6 INTERNAL GLASS SUPPORT	3	PZ																																																																																		
VM2383B0	S6 LEFT OVENS UPPER RIGHT CAP	1	PZ																																																																																		
VM2384B0		1	PZ																																																																																		



COMPONENT			SPARE PART																																														
Code	Description	Image	Code	Description	Components list																																												
VT1291A	XEBC-06EU-E EXTERNAL GLASS		KDR1273B	BT-06 -M EXTERNAL LEFT DOOR	<table border="1"> <thead> <tr> <th>Code</th> <th>Description</th> <th>Qty</th> <th>UOM</th> </tr> </thead> <tbody> <tr> <td>VM2385B0</td> <td>S6 LEFT OVENS UPPER LEFT CAP</td> <td>1</td> <td>PZ</td> </tr> <tr> <td>VM2386B0</td> <td>MM -M LEFT DOOR LEFT LOWER CAP KI</td> <td>1</td> <td>PZ</td> </tr> <tr> <td>VM2410A0</td> <td>PLATE TO STOP EXTRUDED LED BAR</td> <td>2</td> <td>PZ</td> </tr> <tr> <td>VM2505B0</td> <td>MM PLUS INTERNAL GLASS SUPPORT</td> <td>2</td> <td>PZ</td> </tr> <tr> <td>VM2518A0</td> <td>BOARD COOLING FAN SUPPORT</td> <td>1</td> <td>PZ</td> </tr> <tr> <td>VN1179A1</td> <td>CONTROL BOARD 40X40X20MM 12V COOLING FAN</td> <td>1</td> <td>PZ</td> </tr> <tr> <td>VP1076A0</td> <td>PLUS ONE ZERO HANDLE PIN</td> <td>1</td> <td>PZ</td> </tr> <tr> <td>VP1080A0</td> <td>UPPER HINGE CAP FOR LOWER INNER GLASS</td> <td>1</td> <td>PZ</td> </tr> <tr> <td>VP1081A0</td> <td>UPPER HINGE CAP FOR UPPER INNER GLASS</td> <td>1</td> <td>PZ</td> </tr> <tr> <td>VT1291A0</td> <td>XEBC-06EU-E EXTERNAL GLASS</td> <td>1</td> <td>PZ</td> </tr> </tbody> </table>	Code	Description	Qty	UOM	VM2385B0	S6 LEFT OVENS UPPER LEFT CAP	1	PZ	VM2386B0	MM -M LEFT DOOR LEFT LOWER CAP KI	1	PZ	VM2410A0	PLATE TO STOP EXTRUDED LED BAR	2	PZ	VM2505B0	MM PLUS INTERNAL GLASS SUPPORT	2	PZ	VM2518A0	BOARD COOLING FAN SUPPORT	1	PZ	VN1179A1	CONTROL BOARD 40X40X20MM 12V COOLING FAN	1	PZ	VP1076A0	PLUS ONE ZERO HANDLE PIN	1	PZ	VP1080A0	UPPER HINGE CAP FOR LOWER INNER GLASS	1	PZ	VP1081A0	UPPER HINGE CAP FOR UPPER INNER GLASS	1	PZ	VT1291A0	XEBC-06EU-E EXTERNAL GLASS	1	PZ
			Code	Description	Qty	UOM																																											
VM2385B0	S6 LEFT OVENS UPPER LEFT CAP	1	PZ																																														
VM2386B0	MM -M LEFT DOOR LEFT LOWER CAP KI	1	PZ																																														
VM2410A0	PLATE TO STOP EXTRUDED LED BAR	2	PZ																																														
VM2505B0	MM PLUS INTERNAL GLASS SUPPORT	2	PZ																																														
VM2518A0	BOARD COOLING FAN SUPPORT	1	PZ																																														
VN1179A1	CONTROL BOARD 40X40X20MM 12V COOLING FAN	1	PZ																																														
VP1076A0	PLUS ONE ZERO HANDLE PIN	1	PZ																																														
VP1080A0	UPPER HINGE CAP FOR LOWER INNER GLASS	1	PZ																																														
VP1081A0	UPPER HINGE CAP FOR UPPER INNER GLASS	1	PZ																																														
VT1291A0	XEBC-06EU-E EXTERNAL GLASS	1	PZ																																														
KDR1273A	BT-06 EXTERNAL LEFT DOOR	<table border="1"> <thead> <tr> <th>Code</th> <th>Description</th> <th>Qty</th> <th>UOM</th> </tr> </thead> <tbody> <tr> <td>0B1126A0</td> <td>DOOR LOWER FRAME SHAPE 860 MM</td> <td>1</td> <td>PZ</td> </tr> <tr> <td>0B1126A1</td> <td></td> <td>1</td> <td>PZ</td> </tr> <tr> <td>0B1167A0</td> <td>EXT. GLASS SUPPORT PROFILE</td> <td>2</td> <td>PZ</td> </tr> <tr> <td>0B1198A0</td> <td>0711 LEFT - DOOR LEFT EXT COLUMN</td> <td>1</td> <td>PZ</td> </tr> <tr> <td>0B1198B0</td> <td></td> <td>1</td> <td>PZ</td> </tr> <tr> <td>0B1198B1</td> <td></td> <td>1</td> <td>PZ</td> </tr> <tr> <td>0B1199A2</td> <td>0711 LEFT - DOOR RIGHT INT COLUMN</td> <td>1</td> <td>PZ</td> </tr> </tbody> </table>	Code	Description	Qty	UOM	0B1126A0	DOOR LOWER FRAME SHAPE 860 MM	1	PZ	0B1126A1		1	PZ	0B1167A0	EXT. GLASS SUPPORT PROFILE	2	PZ	0B1198A0	0711 LEFT - DOOR LEFT EXT COLUMN	1	PZ	0B1198B0		1	PZ	0B1198B1		1	PZ	0B1199A2	0711 LEFT - DOOR RIGHT INT COLUMN	1	PZ															
Code	Description	Qty	UOM																																														
0B1126A0	DOOR LOWER FRAME SHAPE 860 MM	1	PZ																																														
0B1126A1		1	PZ																																														
0B1167A0	EXT. GLASS SUPPORT PROFILE	2	PZ																																														
0B1198A0	0711 LEFT - DOOR LEFT EXT COLUMN	1	PZ																																														
0B1198B0		1	PZ																																														
0B1198B1		1	PZ																																														
0B1199A2	0711 LEFT - DOOR RIGHT INT COLUMN	1	PZ																																														

COMPONENT			SPARE PART			
Code	Description	Image	Code	Description	Components list	
VT1291A	XEBC-06EU-E EXTERNAL GLASS		KDR1273A	BT-06 EXTERNAL LEFT DOOR	Code	Description Qty UOM
					0B1200A2	0711 LEFT - 1 PZ DOOR LEFT INT COLUMN
					0B1218A0	MM DOUBLE 1 PZ GLASS DOOR UPPER BEAM 860
					0B1218A1	1 PZ
					0B1219A1	MM DOUBLE 1 PZ GLASS DOOR INT UPPER BEAM 860
					0B1231A0	06EU LEFT - 1 PZ DOOR RIGHT EXT COLUMN
					0H7321A0	MM 1 PZ STAINLESS STEEL HANDLE COVE
					CE1052A1	CABLE 1 PZ CONNECTION CONTROL - USB MM 750M
					CE1053B0	MM MICROFIT 1 PZ LED BAR POWER SUPPLY CABL
					CE1285A0	EMI ROUND 1 PZ FERRITE MOD.26438015 02
					CE1290A0	EXTRACTABL 1 PZ E FEMALE TERMINAL CPF 5/4
					CE1455A0	TIP END 4 PZ FITTING
					CE1725A0	ROBOTICS 4 M SILICON PIPE 4X0,5 MMQ
					CE1735A0	MINIFIT 4 PZ FEMALE END FITTING
					CE1755A0	4 WAYS MALE 1 PZ MINIFIT CONNECTOR
					IP1508A1	POLYSTYREN 2 M E U SHAPED PROFILE 2000X60X60
					LP1020A0	6 SERIES L400 1 PZ LED LIGHT BAR - E583



COMPONENT			SPARE PART																																																																										
Code	Description	Image	Code	Description	Components list																																																																								
VT1291A	XEBC-06EU-E EXTERNAL GLASS		KDR1273A	BT-06 EXTERNAL LEFT DOOR	<table border="1"> <thead> <tr> <th>Code</th> <th>Description</th> <th>Qty</th> <th>UOM</th> </tr> </thead> <tbody> <tr> <td>LP1026A0</td> <td>L=583 S6 NO LED LIGHT BAR COVER</td> <td>1</td> <td>PZ</td> </tr> <tr> <td>MG1083A2</td> <td></td> <td>1</td> <td>PZ</td> </tr> <tr> <td>RC1200A0</td> <td>ED=4 WIRE D.=0.5 COMPRESSIO N SPRING</td> <td>4</td> <td>PZ</td> </tr> <tr> <td>SL1170A1</td> <td>S57 BLACK SILICON - 310ML CARTRIDGE</td> <td>39</td> <td>ML</td> </tr> <tr> <td>VE1030A1</td> <td>MAGNET FOR DOOR MICROSWITC H D=22.9MM</td> <td>2</td> <td>PZ</td> </tr> <tr> <td>VI0239A1</td> <td>SELF-TAPPIN G SCREW 4.2X25 TCB+ INOX</td> <td>4</td> <td>PZ</td> </tr> <tr> <td>VI1220A1</td> <td>4.2X12 TCB SELF-TAPPIN G SCREW</td> <td>16</td> <td>PZ</td> </tr> <tr> <td>VI1930A0</td> <td>5X25 ST. STEEL SCREW CHIP</td> <td>16</td> <td>PZ</td> </tr> <tr> <td>VI1960A0</td> <td>SELF-TAPPIN G SCREW 4.2X11 TCBS+ AISI410</td> <td>10</td> <td>PZ</td> </tr> <tr> <td>VI1996A0</td> <td>M5X35 SCREW</td> <td>13</td> <td>PZ</td> </tr> <tr> <td>VM1059A1</td> <td>HEAT SHRINK FILM H800</td> <td>1.500</td> <td>M</td> </tr> <tr> <td>VM1182B1</td> <td>E. S. CT BT HANDLE JUNCTION + PIN GUIDE</td> <td>1</td> <td>PZ</td> </tr> <tr> <td>VM1183B0</td> <td>CHEFTOP/BAK ERTOP HANDLE PIN</td> <td>1</td> <td>PZ</td> </tr> <tr> <td>VM1183B1</td> <td>CT BT HANDLE PIN</td> <td>1</td> <td>PZ</td> </tr> <tr> <td>VM1183C0</td> <td>CT BT HANDLE T-SHAPED PIN KIT</td> <td>1</td> <td>PZ</td> </tr> <tr> <td>VM1183C1</td> <td>CT BT HANDLE T-SHAPED PIN KIT</td> <td>1</td> <td>PZ</td> </tr> <tr> <td>VM1490A0</td> <td>CHEFTOP/BAK ERTOP HANDLE SCREWS COVER</td> <td>2</td> <td>PZ</td> </tr> </tbody> </table>	Code	Description	Qty	UOM	LP1026A0	L=583 S6 NO LED LIGHT BAR COVER	1	PZ	MG1083A2		1	PZ	RC1200A0	ED=4 WIRE D.=0.5 COMPRESSIO N SPRING	4	PZ	SL1170A1	S57 BLACK SILICON - 310ML CARTRIDGE	39	ML	VE1030A1	MAGNET FOR DOOR MICROSWITC H D=22.9MM	2	PZ	VI0239A1	SELF-TAPPIN G SCREW 4.2X25 TCB+ INOX	4	PZ	VI1220A1	4.2X12 TCB SELF-TAPPIN G SCREW	16	PZ	VI1930A0	5X25 ST. STEEL SCREW CHIP	16	PZ	VI1960A0	SELF-TAPPIN G SCREW 4.2X11 TCBS+ AISI410	10	PZ	VI1996A0	M5X35 SCREW	13	PZ	VM1059A1	HEAT SHRINK FILM H800	1.500	M	VM1182B1	E. S. CT BT HANDLE JUNCTION + PIN GUIDE	1	PZ	VM1183B0	CHEFTOP/BAK ERTOP HANDLE PIN	1	PZ	VM1183B1	CT BT HANDLE PIN	1	PZ	VM1183C0	CT BT HANDLE T-SHAPED PIN KIT	1	PZ	VM1183C1	CT BT HANDLE T-SHAPED PIN KIT	1	PZ	VM1490A0	CHEFTOP/BAK ERTOP HANDLE SCREWS COVER	2	PZ
Code	Description	Qty	UOM																																																																										
LP1026A0	L=583 S6 NO LED LIGHT BAR COVER	1	PZ																																																																										
MG1083A2		1	PZ																																																																										
RC1200A0	ED=4 WIRE D.=0.5 COMPRESSIO N SPRING	4	PZ																																																																										
SL1170A1	S57 BLACK SILICON - 310ML CARTRIDGE	39	ML																																																																										
VE1030A1	MAGNET FOR DOOR MICROSWITC H D=22.9MM	2	PZ																																																																										
VI0239A1	SELF-TAPPIN G SCREW 4.2X25 TCB+ INOX	4	PZ																																																																										
VI1220A1	4.2X12 TCB SELF-TAPPIN G SCREW	16	PZ																																																																										
VI1930A0	5X25 ST. STEEL SCREW CHIP	16	PZ																																																																										
VI1960A0	SELF-TAPPIN G SCREW 4.2X11 TCBS+ AISI410	10	PZ																																																																										
VI1996A0	M5X35 SCREW	13	PZ																																																																										
VM1059A1	HEAT SHRINK FILM H800	1.500	M																																																																										
VM1182B1	E. S. CT BT HANDLE JUNCTION + PIN GUIDE	1	PZ																																																																										
VM1183B0	CHEFTOP/BAK ERTOP HANDLE PIN	1	PZ																																																																										
VM1183B1	CT BT HANDLE PIN	1	PZ																																																																										
VM1183C0	CT BT HANDLE T-SHAPED PIN KIT	1	PZ																																																																										
VM1183C1	CT BT HANDLE T-SHAPED PIN KIT	1	PZ																																																																										
VM1490A0	CHEFTOP/BAK ERTOP HANDLE SCREWS COVER	2	PZ																																																																										





COMPONENT			SPARE PART																																																																																		
Code	Description	Image	Code	Description	Components list																																																																																
VT1291A	XEBC-06EU-E EXTERNAL GLASS		KDR1273A	BT-06 EXTERNAL LEFT DOOR	<table border="1"> <thead> <tr> <th>Code</th> <th>Description</th> <th>Qty</th> <th>UOM</th> </tr> </thead> <tbody> <tr> <td>VM1630A0</td> <td>INTERNAL GLASS PUSHING CAP</td> <td>2</td> <td>PZ</td> </tr> <tr> <td>VM1630A1</td> <td>INTERNAL GLASS PUSHING CAP</td> <td>2</td> <td>PZ</td> </tr> <tr> <td>VM1631A0</td> <td>PLUS INNER GLASS PUSHING CAP</td> <td>2</td> <td>PZ</td> </tr> <tr> <td>VM1695A0</td> <td>HANDLE POSITION PIN</td> <td>4</td> <td>PZ</td> </tr> <tr> <td>VM2245A0</td> <td>HANDLE SHAFT WITH LATCH</td> <td>1</td> <td>PZ</td> </tr> <tr> <td>VM2247A0</td> <td>HANDLE SHAFT COVER VM2245-2246</td> <td>1</td> <td>PZ</td> </tr> <tr> <td>VM2247B0</td> <td>HANDLE SHAFT COVER VM2245-2246</td> <td>1</td> <td>PZ</td> </tr> <tr> <td>VM2248B0</td> <td>HANDLE WITH LATCH CLOSING KEY</td> <td>1</td> <td>PZ</td> </tr> <tr> <td>VM2267A0</td> <td>INTERNAL GLASS LOCKING SYSTEM SLIDER</td> <td>2</td> <td>PZ</td> </tr> <tr> <td>VM2268A0</td> <td>DOOR MAGNET COVER</td> <td>2</td> <td>PZ</td> </tr> <tr> <td>VM2269A0</td> <td>INTERNAL GLASS LOCKING SYSTEM CAP</td> <td>2</td> <td>PZ</td> </tr> <tr> <td>VM2274A0</td> <td>GROOVED BUSHING</td> <td>1</td> <td>PZ</td> </tr> <tr> <td>VM2275A0</td> <td>SMOOTH BUSHING</td> <td>1</td> <td>PZ</td> </tr> <tr> <td>VM2285A0</td> <td>860 SERIES DRIP PROFILE</td> <td>1</td> <td>PZ</td> </tr> <tr> <td>VM2295A0</td> <td>STYLUS PEN FOR MM</td> <td>1</td> <td>PZ</td> </tr> <tr> <td>VM2305A0</td> <td>6 SERIES DOOR CAP FIXING PAWL</td> <td>14</td> <td>PZ</td> </tr> <tr> <td>VM2312A0</td> <td>6 S. DRIP PROFILE DRAIN LEFT PIPE</td> <td>1</td> <td>PZ</td> </tr> <tr> <td>VM2313A0</td> <td>TUBE DX DISCHARGE DRIP MM</td> <td>1</td> <td>PZ</td> </tr> <tr> <td>VM2314A0</td> <td>6 S. DRIP PROFILE CAP</td> <td>1</td> <td>PZ</td> </tr> </tbody> </table>	Code	Description	Qty	UOM	VM1630A0	INTERNAL GLASS PUSHING CAP	2	PZ	VM1630A1	INTERNAL GLASS PUSHING CAP	2	PZ	VM1631A0	PLUS INNER GLASS PUSHING CAP	2	PZ	VM1695A0	HANDLE POSITION PIN	4	PZ	VM2245A0	HANDLE SHAFT WITH LATCH	1	PZ	VM2247A0	HANDLE SHAFT COVER VM2245-2246	1	PZ	VM2247B0	HANDLE SHAFT COVER VM2245-2246	1	PZ	VM2248B0	HANDLE WITH LATCH CLOSING KEY	1	PZ	VM2267A0	INTERNAL GLASS LOCKING SYSTEM SLIDER	2	PZ	VM2268A0	DOOR MAGNET COVER	2	PZ	VM2269A0	INTERNAL GLASS LOCKING SYSTEM CAP	2	PZ	VM2274A0	GROOVED BUSHING	1	PZ	VM2275A0	SMOOTH BUSHING	1	PZ	VM2285A0	860 SERIES DRIP PROFILE	1	PZ	VM2295A0	STYLUS PEN FOR MM	1	PZ	VM2305A0	6 SERIES DOOR CAP FIXING PAWL	14	PZ	VM2312A0	6 S. DRIP PROFILE DRAIN LEFT PIPE	1	PZ	VM2313A0	TUBE DX DISCHARGE DRIP MM	1	PZ	VM2314A0	6 S. DRIP PROFILE CAP	1	PZ
Code	Description	Qty	UOM																																																																																		
VM1630A0	INTERNAL GLASS PUSHING CAP	2	PZ																																																																																		
VM1630A1	INTERNAL GLASS PUSHING CAP	2	PZ																																																																																		
VM1631A0	PLUS INNER GLASS PUSHING CAP	2	PZ																																																																																		
VM1695A0	HANDLE POSITION PIN	4	PZ																																																																																		
VM2245A0	HANDLE SHAFT WITH LATCH	1	PZ																																																																																		
VM2247A0	HANDLE SHAFT COVER VM2245-2246	1	PZ																																																																																		
VM2247B0	HANDLE SHAFT COVER VM2245-2246	1	PZ																																																																																		
VM2248B0	HANDLE WITH LATCH CLOSING KEY	1	PZ																																																																																		
VM2267A0	INTERNAL GLASS LOCKING SYSTEM SLIDER	2	PZ																																																																																		
VM2268A0	DOOR MAGNET COVER	2	PZ																																																																																		
VM2269A0	INTERNAL GLASS LOCKING SYSTEM CAP	2	PZ																																																																																		
VM2274A0	GROOVED BUSHING	1	PZ																																																																																		
VM2275A0	SMOOTH BUSHING	1	PZ																																																																																		
VM2285A0	860 SERIES DRIP PROFILE	1	PZ																																																																																		
VM2295A0	STYLUS PEN FOR MM	1	PZ																																																																																		
VM2305A0	6 SERIES DOOR CAP FIXING PAWL	14	PZ																																																																																		
VM2312A0	6 S. DRIP PROFILE DRAIN LEFT PIPE	1	PZ																																																																																		
VM2313A0	TUBE DX DISCHARGE DRIP MM	1	PZ																																																																																		
VM2314A0	6 S. DRIP PROFILE CAP	1	PZ																																																																																		



COMPONENT			SPARE PART					
Code	Description	Image	Code	Description	Components list			
VT1291A	XEBC-06EU-E EXTERNAL GLASS		KDR1273A	BT-06 EXTERNAL LEFT DOOR	<b>Code</b>	<b>Description</b>	<b>Qty</b>	<b>UOM</b>
					VM2315A0	MIND.MAPS INTERNAL GLASS CAP SUPPORT	2	PZ
					VM2371A0	DOUBLE GLASS DOOR PUSHING BRACKET	2	PZ
					VM2371A0	DOUBLE GLASS DOOR PUSHING BRACKET	2	PZ
					VM2383A0	MM LEFT DOOR RIGHT UPPER CAP	1	PZ
					VM2383A0	MM LEFT DOOR RIGHT UPPER CAP	1	PZ
					VM2384A0	MM LEFT DOOR RIGHT LOWER CAP	1	PZ
					VM2384A0	MM LEFT DOOR RIGHT LOWER CAP	1	PZ
					VM2385A1	LEFT MM DOOR UPPER LEFT CAP	1	PZ
					VM2385A1	LEFT MM DOOR UPPER LEFT CAP	1	PZ
					VM2386A1	LEFT MM DOOR LOWER LEFT CAP	1	PZ
					VM2386A1	LEFT MM DOOR LOWER LEFT CAP	1	PZ
					VM2410A0	PLATE TO STOP EXTRUDED LED BAR	2	PZ
					VM2410A0	PLATE TO STOP EXTRUDED LED BAR	2	PZ
					VM2505A0	MM PLUS INTERNAL GLASS SUPPORT	2	PZ
					VM2518A0	BOARD COOLING FAN SUPPORT	1	PZ
					VM2518A0	BOARD COOLING FAN SUPPORT	1	PZ



COMPONENT			SPARE PART																																																			
Code	Description	Image	Code	Description	Components list																																																	
VT1291A	XEBC-06EU-E EXTERNAL GLASS		KDR1273A	BT-06 EXTERNAL LEFT DOOR	<table border="1"> <thead> <tr> <th>Code</th> <th>Description</th> <th>Qty</th> <th>UOM</th> </tr> </thead> <tbody> <tr> <td>VN1179A0</td> <td>CONTROL BOARD 40X40X20MM 12V COOLING FAN</td> <td>1</td> <td>PZ</td> </tr> <tr> <td>VN1179A0</td> <td>CONTROL BOARD 40X40X20MM 12V COOLING FAN</td> <td>1</td> <td>PZ</td> </tr> <tr> <td>VN1179A1</td> <td>CONTROL BOARD 40X40X20MM 12V COOLING FAN</td> <td>1</td> <td>PZ</td> </tr> <tr> <td>VT1291A0</td> <td>XEBC-06EU-E EXTERNAL GLASS</td> <td>1</td> <td>PZ</td> </tr> <tr> <td>VT1291A0</td> <td>XEBC-06EU-E EXTERNAL GLASS</td> <td>1</td> <td>PZ</td> </tr> </tbody> </table>	Code	Description	Qty	UOM	VN1179A0	CONTROL BOARD 40X40X20MM 12V COOLING FAN	1	PZ	VN1179A0	CONTROL BOARD 40X40X20MM 12V COOLING FAN	1	PZ	VN1179A1	CONTROL BOARD 40X40X20MM 12V COOLING FAN	1	PZ	VT1291A0	XEBC-06EU-E EXTERNAL GLASS	1	PZ	VT1291A0	XEBC-06EU-E EXTERNAL GLASS	1	PZ																									
			Code	Description	Qty	UOM																																																
VN1179A0	CONTROL BOARD 40X40X20MM 12V COOLING FAN	1	PZ																																																			
VN1179A0	CONTROL BOARD 40X40X20MM 12V COOLING FAN	1	PZ																																																			
VN1179A1	CONTROL BOARD 40X40X20MM 12V COOLING FAN	1	PZ																																																			
VT1291A0	XEBC-06EU-E EXTERNAL GLASS	1	PZ																																																			
VT1291A0	XEBC-06EU-E EXTERNAL GLASS	1	PZ																																																			
KDR1270B	BT-06 -M RIGHT EXTERNAL DOOR	<table border="1"> <thead> <tr> <th>Code</th> <th>Description</th> <th>Qty</th> <th>UOM</th> </tr> </thead> <tbody> <tr> <td>0B1112A2</td> <td>0711 RIGHT - DOOR LEFT INT COLUMN</td> <td>1</td> <td>PZ</td> </tr> <tr> <td>0B1113B0</td> <td></td> <td>1</td> <td>PZ</td> </tr> <tr> <td>0B1113B1</td> <td></td> <td>1</td> <td>PZ</td> </tr> <tr> <td>0B1114A2</td> <td>0711 RIGHT - DOOR RIGHT INT COLUMN</td> <td>1</td> <td>PZ</td> </tr> <tr> <td>0B1126B0</td> <td></td> <td>1</td> <td>PZ</td> </tr> <tr> <td>0B1167A0</td> <td>EXT. GLASS SUPPORT PROFILE</td> <td>2</td> <td>PZ</td> </tr> <tr> <td>0B1175A0</td> <td>XEBC-06EU-E LEFT EXT DOOR COLUM</td> <td>1</td> <td>PZ</td> </tr> <tr> <td>0B1218B0</td> <td></td> <td>1</td> <td>PZ</td> </tr> <tr> <td>0B1219A1</td> <td>MM DOUBLE GLASS DOOR INT UPPER BEAM 860</td> <td>1</td> <td>PZ</td> </tr> <tr> <td>0H7321A0</td> <td>MM STAINLESS STEEL HANDLE COVE</td> <td>1</td> <td>PZ</td> </tr> <tr> <td>CE1052A1</td> <td>CABLE CONNECTION CONTROL - USB MM 750M</td> <td>1</td> <td>PZ</td> </tr> <tr> <td>CE1053B0</td> <td>MM MICROFIT LED BAR POWER SUPPLY CABL</td> <td>1</td> <td>PZ</td> </tr> </tbody> </table>	Code	Description	Qty	UOM	0B1112A2	0711 RIGHT - DOOR LEFT INT COLUMN	1	PZ	0B1113B0		1	PZ	0B1113B1		1	PZ	0B1114A2	0711 RIGHT - DOOR RIGHT INT COLUMN	1	PZ	0B1126B0		1	PZ	0B1167A0	EXT. GLASS SUPPORT PROFILE	2	PZ	0B1175A0	XEBC-06EU-E LEFT EXT DOOR COLUM	1	PZ	0B1218B0		1	PZ	0B1219A1	MM DOUBLE GLASS DOOR INT UPPER BEAM 860	1	PZ	0H7321A0	MM STAINLESS STEEL HANDLE COVE	1	PZ	CE1052A1	CABLE CONNECTION CONTROL - USB MM 750M	1	PZ	CE1053B0	MM MICROFIT LED BAR POWER SUPPLY CABL	1	PZ
Code	Description	Qty	UOM																																																			
0B1112A2	0711 RIGHT - DOOR LEFT INT COLUMN	1	PZ																																																			
0B1113B0		1	PZ																																																			
0B1113B1		1	PZ																																																			
0B1114A2	0711 RIGHT - DOOR RIGHT INT COLUMN	1	PZ																																																			
0B1126B0		1	PZ																																																			
0B1167A0	EXT. GLASS SUPPORT PROFILE	2	PZ																																																			
0B1175A0	XEBC-06EU-E LEFT EXT DOOR COLUM	1	PZ																																																			
0B1218B0		1	PZ																																																			
0B1219A1	MM DOUBLE GLASS DOOR INT UPPER BEAM 860	1	PZ																																																			
0H7321A0	MM STAINLESS STEEL HANDLE COVE	1	PZ																																																			
CE1052A1	CABLE CONNECTION CONTROL - USB MM 750M	1	PZ																																																			
CE1053B0	MM MICROFIT LED BAR POWER SUPPLY CABL	1	PZ																																																			



COMPONENT			SPARE PART																																																																										
Code	Description	Image	Code	Description	Components list																																																																								
VT1291A	XEBC-06EU-E EXTERNAL GLASS		KDR1270B	BT-06 -M RIGHT EXTERNAL DOOR	<table border="1"> <thead> <tr> <th>Code</th> <th>Description</th> <th>Qty</th> <th>UOM</th> </tr> </thead> <tbody> <tr> <td>CE1097A0</td> <td>4M SIHF 4 POLES MICROFIT CANBUS</td> <td>1</td> <td>PZ</td> </tr> <tr> <td>CE1285A0</td> <td>EMI ROUND FERRITE MOD.26438015 02</td> <td>1</td> <td>PZ</td> </tr> <tr> <td>IP1508A1</td> <td>POLYSTYREN E U SHAPED PROFILE 2000X60X60</td> <td>2</td> <td>M</td> </tr> <tr> <td>LP1020A0</td> <td>6 SERIES L400 LED LIGHT BAR - E583</td> <td>1</td> <td>PZ</td> </tr> <tr> <td>LP1026A0</td> <td>L=583 S6 NO LED LIGHT BAR COVER</td> <td>1</td> <td>PZ</td> </tr> <tr> <td>MG1099A1</td> <td></td> <td>1</td> <td>PZ</td> </tr> <tr> <td>RC1200A0</td> <td>ED=4 WIRE D.=0.5 COMPRESSIO N SPRING</td> <td>8</td> <td>PZ</td> </tr> <tr> <td>SL1155A1</td> <td>LOCTITE BICOMPONEN T SILICON</td> <td>80</td> <td>ML</td> </tr> <tr> <td>SL1170A1</td> <td>S57 BLACK SILICON - 310ML CARTRIDGE</td> <td>42</td> <td>ML</td> </tr> <tr> <td>VE1030A1</td> <td>MAGNET FOR DOOR MICROSWITC H D=22,9MM</td> <td>2</td> <td>PZ</td> </tr> <tr> <td>VI0239A1</td> <td>SELF-TAPPIN G SCREW 4.2X25 TCB+ INOX</td> <td>4</td> <td>PZ</td> </tr> <tr> <td>VI1103A0</td> <td>40X12 TBSP SCREW FOR PLASTIC</td> <td>2</td> <td>PZ</td> </tr> <tr> <td>VI1220A1</td> <td>4,2X12 TCB SELF-TAPPIN G SCREW</td> <td>26</td> <td>PZ</td> </tr> <tr> <td>VI1930A1</td> <td>ST. STEEL 5X20 CHIP SCREW</td> <td>16</td> <td>PZ</td> </tr> <tr> <td>VI1996A0</td> <td>M5X35 SCREW</td> <td>13</td> <td>PZ</td> </tr> <tr> <td>VM1059A1</td> <td>HEAT SHRINK FILM H800</td> <td>1</td> <td>M</td> </tr> <tr> <td>VM1182B1</td> <td>E.S. CT BT HANDLE JUNCTION + PIN GUIDE</td> <td>1</td> <td>PZ</td> </tr> </tbody> </table>	Code	Description	Qty	UOM	CE1097A0	4M SIHF 4 POLES MICROFIT CANBUS	1	PZ	CE1285A0	EMI ROUND FERRITE MOD.26438015 02	1	PZ	IP1508A1	POLYSTYREN E U SHAPED PROFILE 2000X60X60	2	M	LP1020A0	6 SERIES L400 LED LIGHT BAR - E583	1	PZ	LP1026A0	L=583 S6 NO LED LIGHT BAR COVER	1	PZ	MG1099A1		1	PZ	RC1200A0	ED=4 WIRE D.=0.5 COMPRESSIO N SPRING	8	PZ	SL1155A1	LOCTITE BICOMPONEN T SILICON	80	ML	SL1170A1	S57 BLACK SILICON - 310ML CARTRIDGE	42	ML	VE1030A1	MAGNET FOR DOOR MICROSWITC H D=22,9MM	2	PZ	VI0239A1	SELF-TAPPIN G SCREW 4.2X25 TCB+ INOX	4	PZ	VI1103A0	40X12 TBSP SCREW FOR PLASTIC	2	PZ	VI1220A1	4,2X12 TCB SELF-TAPPIN G SCREW	26	PZ	VI1930A1	ST. STEEL 5X20 CHIP SCREW	16	PZ	VI1996A0	M5X35 SCREW	13	PZ	VM1059A1	HEAT SHRINK FILM H800	1	M	VM1182B1	E.S. CT BT HANDLE JUNCTION + PIN GUIDE	1	PZ
Code	Description	Qty	UOM																																																																										
CE1097A0	4M SIHF 4 POLES MICROFIT CANBUS	1	PZ																																																																										
CE1285A0	EMI ROUND FERRITE MOD.26438015 02	1	PZ																																																																										
IP1508A1	POLYSTYREN E U SHAPED PROFILE 2000X60X60	2	M																																																																										
LP1020A0	6 SERIES L400 LED LIGHT BAR - E583	1	PZ																																																																										
LP1026A0	L=583 S6 NO LED LIGHT BAR COVER	1	PZ																																																																										
MG1099A1		1	PZ																																																																										
RC1200A0	ED=4 WIRE D.=0.5 COMPRESSIO N SPRING	8	PZ																																																																										
SL1155A1	LOCTITE BICOMPONEN T SILICON	80	ML																																																																										
SL1170A1	S57 BLACK SILICON - 310ML CARTRIDGE	42	ML																																																																										
VE1030A1	MAGNET FOR DOOR MICROSWITC H D=22,9MM	2	PZ																																																																										
VI0239A1	SELF-TAPPIN G SCREW 4.2X25 TCB+ INOX	4	PZ																																																																										
VI1103A0	40X12 TBSP SCREW FOR PLASTIC	2	PZ																																																																										
VI1220A1	4,2X12 TCB SELF-TAPPIN G SCREW	26	PZ																																																																										
VI1930A1	ST. STEEL 5X20 CHIP SCREW	16	PZ																																																																										
VI1996A0	M5X35 SCREW	13	PZ																																																																										
VM1059A1	HEAT SHRINK FILM H800	1	M																																																																										
VM1182B1	E.S. CT BT HANDLE JUNCTION + PIN GUIDE	1	PZ																																																																										



COMPONENT			SPARE PART																																																																																						
Code	Description	Image	Code	Description	Components list																																																																																				
VT1291A	XEBC-06EU-E EXTERNAL GLASS		KDR1270B	BT-06 -M RIGHT EXTERNAL DOOR	<table border="1"> <thead> <tr> <th>Code</th> <th>Description</th> <th>Qty</th> <th>UOM</th> </tr> </thead> <tbody> <tr> <td>VM1490A0</td> <td>CHEFTOP/BAK ERTOP HANDLE SCREWS COVER</td> <td>2</td> <td>PZ</td> </tr> <tr> <td>VM1630A1</td> <td>INTERNAL GLASS PUSHING CAP</td> <td>3</td> <td>PZ</td> </tr> <tr> <td>VM1631A0</td> <td>PLUS INNER GLASS PUSHING CAP</td> <td>2</td> <td>PZ</td> </tr> <tr> <td>VM1695A0</td> <td>HANDLE POSITION PIN</td> <td>4</td> <td>PZ</td> </tr> <tr> <td>VM2245A0</td> <td>HANDLE SHAFT WITH LATCH</td> <td>1</td> <td>PZ</td> </tr> <tr> <td>VM2247B0</td> <td>HANDLE SHAFT COVER VM2245-2246</td> <td>1</td> <td>PZ</td> </tr> <tr> <td>VM2248B0</td> <td>HANDLE WITH LATCH CLOSING KEY</td> <td>1</td> <td>PZ</td> </tr> <tr> <td>VM2259B0</td> <td></td> <td>1</td> <td>PZ</td> </tr> <tr> <td>VM2260B0</td> <td>S6 LEFT UPPER CAP</td> <td>1</td> <td>PZ</td> </tr> <tr> <td>VM2261B0</td> <td></td> <td>1</td> <td>PZ</td> </tr> <tr> <td>VM2262B0</td> <td></td> <td>1</td> <td>PZ</td> </tr> <tr> <td>VM2267A0</td> <td>INTERNAL GLASS LOCKING SYSTEM SLIDER</td> <td>2</td> <td>PZ</td> </tr> <tr> <td>VM2268A0</td> <td>DOOR MAGNET COVER</td> <td>2</td> <td>PZ</td> </tr> <tr> <td>VM2269B0</td> <td>INNER GLASS FIXING CAP</td> <td>2</td> <td>PZ</td> </tr> <tr> <td>VM2274A0</td> <td>GROOVED BUSHING</td> <td>1</td> <td>PZ</td> </tr> <tr> <td>VM2275A0</td> <td>SMOOTH BUSHING</td> <td>1</td> <td>PZ</td> </tr> <tr> <td>VM2285B0</td> <td>860 SERIES DRIP PROFILE KIT</td> <td>1</td> <td>PZ</td> </tr> <tr> <td>VM2295A1</td> <td>MIND.MAPS TOUCH CONTROL STYLUS KIT</td> <td>1</td> <td>PZ</td> </tr> <tr> <td>VM2305A0</td> <td>6 SERIES DOOR CAP FIXING PAWL</td> <td>14</td> <td>PZ</td> </tr> <tr> <td>VM2312A0</td> <td>6 S. DRIP PROFILE DRAIN LEFT PIPE</td> <td>1</td> <td>PZ</td> </tr> </tbody> </table>	Code	Description	Qty	UOM	VM1490A0	CHEFTOP/BAK ERTOP HANDLE SCREWS COVER	2	PZ	VM1630A1	INTERNAL GLASS PUSHING CAP	3	PZ	VM1631A0	PLUS INNER GLASS PUSHING CAP	2	PZ	VM1695A0	HANDLE POSITION PIN	4	PZ	VM2245A0	HANDLE SHAFT WITH LATCH	1	PZ	VM2247B0	HANDLE SHAFT COVER VM2245-2246	1	PZ	VM2248B0	HANDLE WITH LATCH CLOSING KEY	1	PZ	VM2259B0		1	PZ	VM2260B0	S6 LEFT UPPER CAP	1	PZ	VM2261B0		1	PZ	VM2262B0		1	PZ	VM2267A0	INTERNAL GLASS LOCKING SYSTEM SLIDER	2	PZ	VM2268A0	DOOR MAGNET COVER	2	PZ	VM2269B0	INNER GLASS FIXING CAP	2	PZ	VM2274A0	GROOVED BUSHING	1	PZ	VM2275A0	SMOOTH BUSHING	1	PZ	VM2285B0	860 SERIES DRIP PROFILE KIT	1	PZ	VM2295A1	MIND.MAPS TOUCH CONTROL STYLUS KIT	1	PZ	VM2305A0	6 SERIES DOOR CAP FIXING PAWL	14	PZ	VM2312A0	6 S. DRIP PROFILE DRAIN LEFT PIPE	1	PZ
Code	Description	Qty	UOM																																																																																						
VM1490A0	CHEFTOP/BAK ERTOP HANDLE SCREWS COVER	2	PZ																																																																																						
VM1630A1	INTERNAL GLASS PUSHING CAP	3	PZ																																																																																						
VM1631A0	PLUS INNER GLASS PUSHING CAP	2	PZ																																																																																						
VM1695A0	HANDLE POSITION PIN	4	PZ																																																																																						
VM2245A0	HANDLE SHAFT WITH LATCH	1	PZ																																																																																						
VM2247B0	HANDLE SHAFT COVER VM2245-2246	1	PZ																																																																																						
VM2248B0	HANDLE WITH LATCH CLOSING KEY	1	PZ																																																																																						
VM2259B0		1	PZ																																																																																						
VM2260B0	S6 LEFT UPPER CAP	1	PZ																																																																																						
VM2261B0		1	PZ																																																																																						
VM2262B0		1	PZ																																																																																						
VM2267A0	INTERNAL GLASS LOCKING SYSTEM SLIDER	2	PZ																																																																																						
VM2268A0	DOOR MAGNET COVER	2	PZ																																																																																						
VM2269B0	INNER GLASS FIXING CAP	2	PZ																																																																																						
VM2274A0	GROOVED BUSHING	1	PZ																																																																																						
VM2275A0	SMOOTH BUSHING	1	PZ																																																																																						
VM2285B0	860 SERIES DRIP PROFILE KIT	1	PZ																																																																																						
VM2295A1	MIND.MAPS TOUCH CONTROL STYLUS KIT	1	PZ																																																																																						
VM2305A0	6 SERIES DOOR CAP FIXING PAWL	14	PZ																																																																																						
VM2312A0	6 S. DRIP PROFILE DRAIN LEFT PIPE	1	PZ																																																																																						



COMPONENT			SPARE PART																																														
Code	Description	Image	Code	Description	Components list																																												
VT1291A	XEBC-06EU-E EXTERNAL GLASS		KDR1270B	BT-06 -M RIGHT EXTERNAL DOOR	<table border="1"> <thead> <tr> <th>Code</th> <th>Description</th> <th>Qty</th> <th>UOM</th> </tr> </thead> <tbody> <tr> <td>VM2314A0</td> <td>6 S. DRIP PROFILE CAP</td> <td>1</td> <td>PZ</td> </tr> <tr> <td>VM2315B0</td> <td>S6 INTERNAL GLASS SUPPORT</td> <td>3</td> <td>PZ</td> </tr> <tr> <td>VM2410A0</td> <td>PLATE TO STOP EXTRUDED LED BAR</td> <td>2</td> <td>PZ</td> </tr> <tr> <td>VM2505B0</td> <td>MM PLUS INTERNAL GLASS SUPPORT</td> <td>2</td> <td>PZ</td> </tr> <tr> <td>VM2518A0</td> <td>BOARD COOLING FAN SUPPORT</td> <td>1</td> <td>PZ</td> </tr> <tr> <td>VN1179A1</td> <td>CONTROL BOARD 40X40X20MM 12V COOLING FAN</td> <td>1</td> <td>PZ</td> </tr> <tr> <td>VP1076A0</td> <td>PLUS ONE ZERO HANDLE PIN</td> <td>1</td> <td>PZ</td> </tr> <tr> <td>VP1080A0</td> <td>UPPER HINGE CAP FOR LOWER INNER GLASS</td> <td>1</td> <td>PZ</td> </tr> <tr> <td>VP1081A0</td> <td>UPPER HINGE CAP FOR UPPER INNER GLASS</td> <td>1</td> <td>PZ</td> </tr> <tr> <td>VT1291A0</td> <td>XEBC-06EU-E EXTERNAL GLASS</td> <td>1</td> <td>PZ</td> </tr> </tbody> </table>	Code	Description	Qty	UOM	VM2314A0	6 S. DRIP PROFILE CAP	1	PZ	VM2315B0	S6 INTERNAL GLASS SUPPORT	3	PZ	VM2410A0	PLATE TO STOP EXTRUDED LED BAR	2	PZ	VM2505B0	MM PLUS INTERNAL GLASS SUPPORT	2	PZ	VM2518A0	BOARD COOLING FAN SUPPORT	1	PZ	VN1179A1	CONTROL BOARD 40X40X20MM 12V COOLING FAN	1	PZ	VP1076A0	PLUS ONE ZERO HANDLE PIN	1	PZ	VP1080A0	UPPER HINGE CAP FOR LOWER INNER GLASS	1	PZ	VP1081A0	UPPER HINGE CAP FOR UPPER INNER GLASS	1	PZ	VT1291A0	XEBC-06EU-E EXTERNAL GLASS	1	PZ
			Code	Description	Qty	UOM																																											
VM2314A0	6 S. DRIP PROFILE CAP	1	PZ																																														
VM2315B0	S6 INTERNAL GLASS SUPPORT	3	PZ																																														
VM2410A0	PLATE TO STOP EXTRUDED LED BAR	2	PZ																																														
VM2505B0	MM PLUS INTERNAL GLASS SUPPORT	2	PZ																																														
VM2518A0	BOARD COOLING FAN SUPPORT	1	PZ																																														
VN1179A1	CONTROL BOARD 40X40X20MM 12V COOLING FAN	1	PZ																																														
VP1076A0	PLUS ONE ZERO HANDLE PIN	1	PZ																																														
VP1080A0	UPPER HINGE CAP FOR LOWER INNER GLASS	1	PZ																																														
VP1081A0	UPPER HINGE CAP FOR UPPER INNER GLASS	1	PZ																																														
VT1291A0	XEBC-06EU-E EXTERNAL GLASS	1	PZ																																														
KDR1270A	BT-06 RIGHT EXTERNAL DOOR	<table border="1"> <thead> <tr> <th>Code</th> <th>Description</th> <th>Qty</th> <th>UOM</th> </tr> </thead> <tbody> <tr> <td>0B1112A2</td> <td>0711 RIGHT - DOOR LEFT INT COLUMN</td> <td>1</td> <td>PZ</td> </tr> <tr> <td>0B1113A0</td> <td>XEVC-0711-E RIGHT EXT DOOR COLUM</td> <td>1</td> <td>PZ</td> </tr> <tr> <td>0B1113B0</td> <td></td> <td>1</td> <td>PZ</td> </tr> <tr> <td>0B1113B1</td> <td></td> <td>1</td> <td>PZ</td> </tr> <tr> <td>0B1114A2</td> <td>0711 RIGHT - DOOR RIGHT INT COLUMN</td> <td>1</td> <td>PZ</td> </tr> <tr> <td>0B1126A0</td> <td>DOOR LOWER FRAME SHAPE 860 MM</td> <td>1</td> <td>PZ</td> </tr> <tr> <td>0B1126A1</td> <td></td> <td>1</td> <td>PZ</td> </tr> <tr> <td>0B1167A0</td> <td>EXT. GLASS SUPPORT PROFILE</td> <td>2</td> <td>PZ</td> </tr> </tbody> </table>	Code	Description	Qty	UOM	0B1112A2	0711 RIGHT - DOOR LEFT INT COLUMN	1	PZ	0B1113A0	XEVC-0711-E RIGHT EXT DOOR COLUM	1	PZ	0B1113B0		1	PZ	0B1113B1		1	PZ	0B1114A2	0711 RIGHT - DOOR RIGHT INT COLUMN	1	PZ	0B1126A0	DOOR LOWER FRAME SHAPE 860 MM	1	PZ	0B1126A1		1	PZ	0B1167A0	EXT. GLASS SUPPORT PROFILE	2	PZ											
Code	Description	Qty	UOM																																														
0B1112A2	0711 RIGHT - DOOR LEFT INT COLUMN	1	PZ																																														
0B1113A0	XEVC-0711-E RIGHT EXT DOOR COLUM	1	PZ																																														
0B1113B0		1	PZ																																														
0B1113B1		1	PZ																																														
0B1114A2	0711 RIGHT - DOOR RIGHT INT COLUMN	1	PZ																																														
0B1126A0	DOOR LOWER FRAME SHAPE 860 MM	1	PZ																																														
0B1126A1		1	PZ																																														
0B1167A0	EXT. GLASS SUPPORT PROFILE	2	PZ																																														



COMPONENT			SPARE PART																																																																											
Code	Description	Image	Code	Description	Components list																																																																									
VT1291A	XEBC-06EU-E EXTERNAL GLASS		KDR1270A	BT-06 RIGHT EXTERNAL DOOR	<table border="1"> <thead> <tr> <th>Code</th> <th>Description</th> <th>Qty</th> <th>UOM</th> </tr> </thead> <tbody> <tr> <td>0B1175A0</td> <td>XEBC-06EU-E LEFT EXT DOOR COLUM</td> <td>1</td> <td>PZ</td> </tr> <tr> <td>0B1218A0</td> <td>MM DOUBLE GLASS DOOR UPPER BEAM 860</td> <td>1</td> <td>PZ</td> </tr> <tr> <td>0B1218A1</td> <td></td> <td>1</td> <td>PZ</td> </tr> <tr> <td>0B1219A1</td> <td>MM DOUBLE GLASS DOOR INT UPPER BEAM 860</td> <td>1</td> <td>PZ</td> </tr> <tr> <td>0H7321A0</td> <td>MM STAINLESS STEEL HANDLE COVE</td> <td>1</td> <td>PZ</td> </tr> <tr> <td>CE1052A1</td> <td>CABLE CONNECTION CONTROL - USB MM 750M</td> <td>1</td> <td>PZ</td> </tr> <tr> <td>CE1053B0</td> <td>MM MICROFIT LED BAR POWER SUPPLY CABL</td> <td>1</td> <td>PZ</td> </tr> <tr> <td>CE1285A0</td> <td>EMI ROUND FERRITE MOD.26438015 02</td> <td>1</td> <td>PZ</td> </tr> <tr> <td>CE1290A0</td> <td>EXTRACTABL E FEMALE TERMINAL CPF 5/4</td> <td>1</td> <td>PZ</td> </tr> <tr> <td>CE1455A0</td> <td>TIP END FITTING</td> <td>4</td> <td>PZ</td> </tr> <tr> <td>CE1725A0</td> <td>ROBOTICS SILICON PIPE 4X0,5 MMQ</td> <td>4</td> <td>M</td> </tr> <tr> <td>CE1735A0</td> <td>MINIFIT FEMALE END FITTING</td> <td>4</td> <td>PZ</td> </tr> <tr> <td>CE1755A0</td> <td>4 WAYS MALE MINIFIT CONNECTOR</td> <td>1</td> <td>PZ</td> </tr> <tr> <td>IP1508A1</td> <td>POLYSTYREN E U SHAPED PROFILE 2000X60X60</td> <td>2</td> <td>M</td> </tr> <tr> <td>LP1020A0</td> <td>6 SERIES L400 LED LIGHT BAR - E583</td> <td>1</td> <td>PZ</td> </tr> <tr> <td>LP1026A0</td> <td>L=583 S6 NO LED LIGHT BAR COVER</td> <td>1</td> <td>PZ</td> </tr> <tr> <td>MG1083A2</td> <td></td> <td>1</td> <td>PZ</td> </tr> </tbody> </table>	Code	Description	Qty	UOM	0B1175A0	XEBC-06EU-E LEFT EXT DOOR COLUM	1	PZ	0B1218A0	MM DOUBLE GLASS DOOR UPPER BEAM 860	1	PZ	0B1218A1		1	PZ	0B1219A1	MM DOUBLE GLASS DOOR INT UPPER BEAM 860	1	PZ	0H7321A0	MM STAINLESS STEEL HANDLE COVE	1	PZ	CE1052A1	CABLE CONNECTION CONTROL - USB MM 750M	1	PZ	CE1053B0	MM MICROFIT LED BAR POWER SUPPLY CABL	1	PZ	CE1285A0	EMI ROUND FERRITE MOD.26438015 02	1	PZ	CE1290A0	EXTRACTABL E FEMALE TERMINAL CPF 5/4	1	PZ	CE1455A0	TIP END FITTING	4	PZ	CE1725A0	ROBOTICS SILICON PIPE 4X0,5 MMQ	4	M	CE1735A0	MINIFIT FEMALE END FITTING	4	PZ	CE1755A0	4 WAYS MALE MINIFIT CONNECTOR	1	PZ	IP1508A1	POLYSTYREN E U SHAPED PROFILE 2000X60X60	2	M	LP1020A0	6 SERIES L400 LED LIGHT BAR - E583	1	PZ	LP1026A0	L=583 S6 NO LED LIGHT BAR COVER	1	PZ	MG1083A2		1	PZ	
Code	Description	Qty	UOM																																																																											
0B1175A0	XEBC-06EU-E LEFT EXT DOOR COLUM	1	PZ																																																																											
0B1218A0	MM DOUBLE GLASS DOOR UPPER BEAM 860	1	PZ																																																																											
0B1218A1		1	PZ																																																																											
0B1219A1	MM DOUBLE GLASS DOOR INT UPPER BEAM 860	1	PZ																																																																											
0H7321A0	MM STAINLESS STEEL HANDLE COVE	1	PZ																																																																											
CE1052A1	CABLE CONNECTION CONTROL - USB MM 750M	1	PZ																																																																											
CE1053B0	MM MICROFIT LED BAR POWER SUPPLY CABL	1	PZ																																																																											
CE1285A0	EMI ROUND FERRITE MOD.26438015 02	1	PZ																																																																											
CE1290A0	EXTRACTABL E FEMALE TERMINAL CPF 5/4	1	PZ																																																																											
CE1455A0	TIP END FITTING	4	PZ																																																																											
CE1725A0	ROBOTICS SILICON PIPE 4X0,5 MMQ	4	M																																																																											
CE1735A0	MINIFIT FEMALE END FITTING	4	PZ																																																																											
CE1755A0	4 WAYS MALE MINIFIT CONNECTOR	1	PZ																																																																											
IP1508A1	POLYSTYREN E U SHAPED PROFILE 2000X60X60	2	M																																																																											
LP1020A0	6 SERIES L400 LED LIGHT BAR - E583	1	PZ																																																																											
LP1026A0	L=583 S6 NO LED LIGHT BAR COVER	1	PZ																																																																											
MG1083A2		1	PZ																																																																											



COMPONENT			SPARE PART																																																																						
Code	Description	Image	Code	Description	Components list																																																																				
VT1291A	XEBC-06EU-E EXTERNAL GLASS		KDR1270A	BT-06 RIGHT EXTERNAL DOOR	<table border="1"> <thead> <tr> <th>Code</th> <th>Description</th> <th>Qty</th> <th>UOM</th> </tr> </thead> <tbody> <tr> <td>RC1200A0</td> <td>ED=4 WIRE D.=0.5 COMPRESSIO N SPRING</td> <td>4</td> <td>PZ</td> </tr> <tr> <td>SL1170A1</td> <td>S57 BLACK SILICON - 310ML CARTRIDGE</td> <td>14</td> <td>ML</td> </tr> <tr> <td>VE1030A1</td> <td>MAGNET FOR DOOR MICROSWITC H D=22,9MM</td> <td>2</td> <td>PZ</td> </tr> <tr> <td>VI0239A1</td> <td>SELF-TAPPIN G SCREW 4.2X25 TCB+ INOX</td> <td>4</td> <td>PZ</td> </tr> <tr> <td>VI1220A1</td> <td>4.2X12 TCB SELF-TAPPIN G SCREW</td> <td>16</td> <td>PZ</td> </tr> <tr> <td>VI1930A0</td> <td>5X25 ST. STEEL SCREW CHIP</td> <td>16</td> <td>PZ</td> </tr> <tr> <td>VI1960A0</td> <td>SELF-TAPPIN G SCREW 4.2X11 TCBS+ AISI410</td> <td>10</td> <td>PZ</td> </tr> <tr> <td>VI1996A0</td> <td>M5X35 SCREW</td> <td>13</td> <td>PZ</td> </tr> <tr> <td>VM1059A1</td> <td>HEAT SHRINK FILM H800</td> <td>1.500</td> <td>M</td> </tr> <tr> <td>VM1182B1</td> <td>E S. CT BT HANDLE JUNCTION + PIN GUIDE</td> <td>1</td> <td>PZ</td> </tr> <tr> <td>VM1183B0</td> <td>CHEFTOP/BAK ERTOP HANDLE PIN</td> <td>1</td> <td>PZ</td> </tr> <tr> <td>VM1183B1</td> <td>CT BT HANDLE PIN</td> <td>1</td> <td>PZ</td> </tr> <tr> <td>VM1183C0</td> <td>CT BT HANDLE T-SHAPED PIN KIT</td> <td>1</td> <td>PZ</td> </tr> <tr> <td>VM1183C1</td> <td>CT BT HANDLE T-SHAPED PIN KIT</td> <td>1</td> <td>PZ</td> </tr> <tr> <td>VM1490A0</td> <td>CHEFTOP/BAK ERTOP HANDLE SCREWS COVER</td> <td>2</td> <td>PZ</td> </tr> <tr> <td>VM1630A0</td> <td>INTERNAL GLASS PUSHING CAP</td> <td>2</td> <td>PZ</td> </tr> </tbody> </table>	Code	Description	Qty	UOM	RC1200A0	ED=4 WIRE D.=0.5 COMPRESSIO N SPRING	4	PZ	SL1170A1	S57 BLACK SILICON - 310ML CARTRIDGE	14	ML	VE1030A1	MAGNET FOR DOOR MICROSWITC H D=22,9MM	2	PZ	VI0239A1	SELF-TAPPIN G SCREW 4.2X25 TCB+ INOX	4	PZ	VI1220A1	4.2X12 TCB SELF-TAPPIN G SCREW	16	PZ	VI1930A0	5X25 ST. STEEL SCREW CHIP	16	PZ	VI1960A0	SELF-TAPPIN G SCREW 4.2X11 TCBS+ AISI410	10	PZ	VI1996A0	M5X35 SCREW	13	PZ	VM1059A1	HEAT SHRINK FILM H800	1.500	M	VM1182B1	E S. CT BT HANDLE JUNCTION + PIN GUIDE	1	PZ	VM1183B0	CHEFTOP/BAK ERTOP HANDLE PIN	1	PZ	VM1183B1	CT BT HANDLE PIN	1	PZ	VM1183C0	CT BT HANDLE T-SHAPED PIN KIT	1	PZ	VM1183C1	CT BT HANDLE T-SHAPED PIN KIT	1	PZ	VM1490A0	CHEFTOP/BAK ERTOP HANDLE SCREWS COVER	2	PZ	VM1630A0	INTERNAL GLASS PUSHING CAP	2	PZ
Code	Description	Qty	UOM																																																																						
RC1200A0	ED=4 WIRE D.=0.5 COMPRESSIO N SPRING	4	PZ																																																																						
SL1170A1	S57 BLACK SILICON - 310ML CARTRIDGE	14	ML																																																																						
VE1030A1	MAGNET FOR DOOR MICROSWITC H D=22,9MM	2	PZ																																																																						
VI0239A1	SELF-TAPPIN G SCREW 4.2X25 TCB+ INOX	4	PZ																																																																						
VI1220A1	4.2X12 TCB SELF-TAPPIN G SCREW	16	PZ																																																																						
VI1930A0	5X25 ST. STEEL SCREW CHIP	16	PZ																																																																						
VI1960A0	SELF-TAPPIN G SCREW 4.2X11 TCBS+ AISI410	10	PZ																																																																						
VI1996A0	M5X35 SCREW	13	PZ																																																																						
VM1059A1	HEAT SHRINK FILM H800	1.500	M																																																																						
VM1182B1	E S. CT BT HANDLE JUNCTION + PIN GUIDE	1	PZ																																																																						
VM1183B0	CHEFTOP/BAK ERTOP HANDLE PIN	1	PZ																																																																						
VM1183B1	CT BT HANDLE PIN	1	PZ																																																																						
VM1183C0	CT BT HANDLE T-SHAPED PIN KIT	1	PZ																																																																						
VM1183C1	CT BT HANDLE T-SHAPED PIN KIT	1	PZ																																																																						
VM1490A0	CHEFTOP/BAK ERTOP HANDLE SCREWS COVER	2	PZ																																																																						
VM1630A0	INTERNAL GLASS PUSHING CAP	2	PZ																																																																						











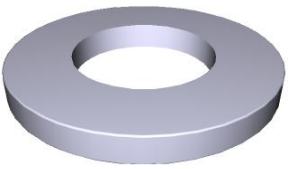



COMPONENT			SPARE PART																																																																																		
Code	Description	Image	Code	Description	Components list																																																																																
VT1291A	XEBC-06EU-E EXTERNAL GLASS		KDR1270A	BT-06 RIGHT EXTERNAL DOOR	<table border="1"> <thead> <tr> <th>Code</th> <th>Description</th> <th>Qty</th> <th>UOM</th> </tr> </thead> <tbody> <tr> <td>VM1630A1</td> <td>INTERNAL GLASS PUSHING CAP</td> <td>2</td> <td>PZ</td> </tr> <tr> <td>VM1631A0</td> <td>PLUS INNER GLASS PUSHING CAP</td> <td>2</td> <td>PZ</td> </tr> <tr> <td>VM1695A0</td> <td>HANDLE POSITION PIN</td> <td>4</td> <td>PZ</td> </tr> <tr> <td>VM2245A0</td> <td>HANDLE SHAFT WITH LATCH</td> <td>1</td> <td>PZ</td> </tr> <tr> <td>VM2247A0</td> <td>HANDLE SHAFT COVER VM2245-2246</td> <td>1</td> <td>PZ</td> </tr> <tr> <td>VM2247B0</td> <td>HANDLE SHAFT COVER VM2245-2246</td> <td>1</td> <td>PZ</td> </tr> <tr> <td>VM2248B0</td> <td>HANDLE WITH LATCH CLOSING KEY</td> <td>1</td> <td>PZ</td> </tr> <tr> <td>VM2259A1</td> <td>6 SERIES DOOR LOWER LEFT CAP</td> <td>1</td> <td>PZ</td> </tr> <tr> <td>VM2260A1</td> <td>6 SERIES DOOR UPPER LEFT CAP</td> <td>1</td> <td>PZ</td> </tr> <tr> <td>VM2261A1</td> <td>6 SERIES DOOR LOWER RIGHT CAP</td> <td>1</td> <td>PZ</td> </tr> <tr> <td>VM2262A1</td> <td>6 SERIES DOOR UPPER RIGHT CAP</td> <td>1</td> <td>PZ</td> </tr> <tr> <td>VM2267A0</td> <td>INTERNAL GLASS LOCKING SYSTEM SLIDER</td> <td>2</td> <td>PZ</td> </tr> <tr> <td>VM2268A0</td> <td>DOOR MAGNET COVER</td> <td>2</td> <td>PZ</td> </tr> <tr> <td>VM2269A0</td> <td>INTERNAL GLASS LOCKING SYSTEM CAP</td> <td>2</td> <td>PZ</td> </tr> <tr> <td>VM2274A0</td> <td>GROOVED BUSHING</td> <td>1</td> <td>PZ</td> </tr> <tr> <td>VM2275A0</td> <td>SMOOTH BUSHING</td> <td>1</td> <td>PZ</td> </tr> <tr> <td>VM2285A0</td> <td>860 SERIES DRIP PROFILE</td> <td>1</td> <td>PZ</td> </tr> <tr> <td>VM2295A0</td> <td>STYLUS PEN FOR MM</td> <td>1</td> <td>PZ</td> </tr> <tr> <td>VM2305A0</td> <td>6 SERIES DOOR CAP FIXING PAWL</td> <td>14</td> <td>PZ</td> </tr> </tbody> </table>	Code	Description	Qty	UOM	VM1630A1	INTERNAL GLASS PUSHING CAP	2	PZ	VM1631A0	PLUS INNER GLASS PUSHING CAP	2	PZ	VM1695A0	HANDLE POSITION PIN	4	PZ	VM2245A0	HANDLE SHAFT WITH LATCH	1	PZ	VM2247A0	HANDLE SHAFT COVER VM2245-2246	1	PZ	VM2247B0	HANDLE SHAFT COVER VM2245-2246	1	PZ	VM2248B0	HANDLE WITH LATCH CLOSING KEY	1	PZ	VM2259A1	6 SERIES DOOR LOWER LEFT CAP	1	PZ	VM2260A1	6 SERIES DOOR UPPER LEFT CAP	1	PZ	VM2261A1	6 SERIES DOOR LOWER RIGHT CAP	1	PZ	VM2262A1	6 SERIES DOOR UPPER RIGHT CAP	1	PZ	VM2267A0	INTERNAL GLASS LOCKING SYSTEM SLIDER	2	PZ	VM2268A0	DOOR MAGNET COVER	2	PZ	VM2269A0	INTERNAL GLASS LOCKING SYSTEM CAP	2	PZ	VM2274A0	GROOVED BUSHING	1	PZ	VM2275A0	SMOOTH BUSHING	1	PZ	VM2285A0	860 SERIES DRIP PROFILE	1	PZ	VM2295A0	STYLUS PEN FOR MM	1	PZ	VM2305A0	6 SERIES DOOR CAP FIXING PAWL	14	PZ
Code	Description	Qty	UOM																																																																																		
VM1630A1	INTERNAL GLASS PUSHING CAP	2	PZ																																																																																		
VM1631A0	PLUS INNER GLASS PUSHING CAP	2	PZ																																																																																		
VM1695A0	HANDLE POSITION PIN	4	PZ																																																																																		
VM2245A0	HANDLE SHAFT WITH LATCH	1	PZ																																																																																		
VM2247A0	HANDLE SHAFT COVER VM2245-2246	1	PZ																																																																																		
VM2247B0	HANDLE SHAFT COVER VM2245-2246	1	PZ																																																																																		
VM2248B0	HANDLE WITH LATCH CLOSING KEY	1	PZ																																																																																		
VM2259A1	6 SERIES DOOR LOWER LEFT CAP	1	PZ																																																																																		
VM2260A1	6 SERIES DOOR UPPER LEFT CAP	1	PZ																																																																																		
VM2261A1	6 SERIES DOOR LOWER RIGHT CAP	1	PZ																																																																																		
VM2262A1	6 SERIES DOOR UPPER RIGHT CAP	1	PZ																																																																																		
VM2267A0	INTERNAL GLASS LOCKING SYSTEM SLIDER	2	PZ																																																																																		
VM2268A0	DOOR MAGNET COVER	2	PZ																																																																																		
VM2269A0	INTERNAL GLASS LOCKING SYSTEM CAP	2	PZ																																																																																		
VM2274A0	GROOVED BUSHING	1	PZ																																																																																		
VM2275A0	SMOOTH BUSHING	1	PZ																																																																																		
VM2285A0	860 SERIES DRIP PROFILE	1	PZ																																																																																		
VM2295A0	STYLUS PEN FOR MM	1	PZ																																																																																		
VM2305A0	6 SERIES DOOR CAP FIXING PAWL	14	PZ																																																																																		

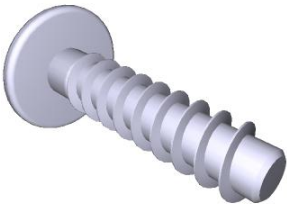

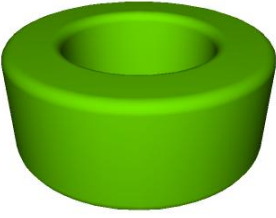

COMPONENT			SPARE PART																																																														
Code	Description	Image	Code	Description	Components list																																																												
VT1291A	XEBC-06EU-E EXTERNAL GLASS		KDR1270A	BT-06 RIGHT EXTERNAL DOOR	<table border="1"> <thead> <tr> <th>Code</th> <th>Description</th> <th>Qty</th> <th>UOM</th> </tr> </thead> <tbody> <tr> <td>VM2312A0</td> <td>6 S. DRIP PROFILE DRAIN LEFT PIPE</td> <td>1</td> <td>PZ</td> </tr> <tr> <td>VM2313A0</td> <td>TUBE DX DISCHARGE DRIP MM</td> <td>1</td> <td>PZ</td> </tr> <tr> <td>VM2314A0</td> <td>6 S. DRIP PROFILE CAP</td> <td>1</td> <td>PZ</td> </tr> <tr> <td>VM2315A0</td> <td>MIND.MAPS INTERNAL GLASS CAP SUPPORT</td> <td>2</td> <td>PZ</td> </tr> <tr> <td>VM2371A0</td> <td>DOUBLE GLASS DOOR PUSHING BRACKET</td> <td>2</td> <td>PZ</td> </tr> <tr> <td>VM2371A0</td> <td>DOUBLE GLASS DOOR PUSHING BRACKET</td> <td>2</td> <td>PZ</td> </tr> <tr> <td>VM2410A0</td> <td>PLATE TO STOP EXTRUDED LED BAR</td> <td>2</td> <td>PZ</td> </tr> <tr> <td>VM2410A0</td> <td>PLATE TO STOP EXTRUDED LED BAR</td> <td>2</td> <td>PZ</td> </tr> <tr> <td>VM2505A0</td> <td>MM PLUS INTERNAL GLASS SUPPORT</td> <td>2</td> <td>PZ</td> </tr> <tr> <td>VM2518A0</td> <td>BOARD COOLING FAN SUPPORT</td> <td>1</td> <td>PZ</td> </tr> <tr> <td>VM2518A0</td> <td>BOARD COOLING FAN SUPPORT</td> <td>1</td> <td>PZ</td> </tr> <tr> <td>VN1179A0</td> <td>CONTROL BOARD 40X40X20MM 12V COOLING FAN</td> <td>1</td> <td>PZ</td> </tr> <tr> <td>VN1179A0</td> <td>CONTROL BOARD 40X40X20MM 12V COOLING FAN</td> <td>1</td> <td>PZ</td> </tr> <tr> <td>VN1179A1</td> <td>CONTROL BOARD 40X40X20MM 12V COOLING FAN</td> <td>1</td> <td>PZ</td> </tr> </tbody> </table>	Code	Description	Qty	UOM	VM2312A0	6 S. DRIP PROFILE DRAIN LEFT PIPE	1	PZ	VM2313A0	TUBE DX DISCHARGE DRIP MM	1	PZ	VM2314A0	6 S. DRIP PROFILE CAP	1	PZ	VM2315A0	MIND.MAPS INTERNAL GLASS CAP SUPPORT	2	PZ	VM2371A0	DOUBLE GLASS DOOR PUSHING BRACKET	2	PZ	VM2371A0	DOUBLE GLASS DOOR PUSHING BRACKET	2	PZ	VM2410A0	PLATE TO STOP EXTRUDED LED BAR	2	PZ	VM2410A0	PLATE TO STOP EXTRUDED LED BAR	2	PZ	VM2505A0	MM PLUS INTERNAL GLASS SUPPORT	2	PZ	VM2518A0	BOARD COOLING FAN SUPPORT	1	PZ	VM2518A0	BOARD COOLING FAN SUPPORT	1	PZ	VN1179A0	CONTROL BOARD 40X40X20MM 12V COOLING FAN	1	PZ	VN1179A0	CONTROL BOARD 40X40X20MM 12V COOLING FAN	1	PZ	VN1179A1	CONTROL BOARD 40X40X20MM 12V COOLING FAN	1	PZ
Code	Description	Qty	UOM																																																														
VM2312A0	6 S. DRIP PROFILE DRAIN LEFT PIPE	1	PZ																																																														
VM2313A0	TUBE DX DISCHARGE DRIP MM	1	PZ																																																														
VM2314A0	6 S. DRIP PROFILE CAP	1	PZ																																																														
VM2315A0	MIND.MAPS INTERNAL GLASS CAP SUPPORT	2	PZ																																																														
VM2371A0	DOUBLE GLASS DOOR PUSHING BRACKET	2	PZ																																																														
VM2371A0	DOUBLE GLASS DOOR PUSHING BRACKET	2	PZ																																																														
VM2410A0	PLATE TO STOP EXTRUDED LED BAR	2	PZ																																																														
VM2410A0	PLATE TO STOP EXTRUDED LED BAR	2	PZ																																																														
VM2505A0	MM PLUS INTERNAL GLASS SUPPORT	2	PZ																																																														
VM2518A0	BOARD COOLING FAN SUPPORT	1	PZ																																																														
VM2518A0	BOARD COOLING FAN SUPPORT	1	PZ																																																														
VN1179A0	CONTROL BOARD 40X40X20MM 12V COOLING FAN	1	PZ																																																														
VN1179A0	CONTROL BOARD 40X40X20MM 12V COOLING FAN	1	PZ																																																														
VN1179A1	CONTROL BOARD 40X40X20MM 12V COOLING FAN	1	PZ																																																														

COMPONENT			SPARE PART																						
Code	Description	Image	Code	Description	Components list																				
VT1291A	XEBC-06EU-E EXTERNAL GLASS		KDR1270A	BT-06 RIGHT EXTERNAL DOOR	<table border="1"> <thead> <tr> <th>Code</th> <th>Description</th> <th>Qty</th> <th>UOM</th> </tr> </thead> <tbody> <tr> <td>VT1291A0</td> <td>XEBC-06EU-E EXTERNAL GLASS</td> <td>1</td> <td>PZ</td> </tr> <tr> <td>VT1291A0</td> <td>XEBC-06EU-E EXTERNAL GLASS</td> <td>1</td> <td>PZ</td> </tr> </tbody> </table>	Code	Description	Qty	UOM	VT1291A0	XEBC-06EU-E EXTERNAL GLASS	1	PZ	VT1291A0	XEBC-06EU-E EXTERNAL GLASS	1	PZ								
Code	Description	Qty	UOM																						
VT1291A0	XEBC-06EU-E EXTERNAL GLASS	1	PZ																						
VT1291A0	XEBC-06EU-E EXTERNAL GLASS	1	PZ																						
VI1034A	STAINLESS STEEL WASHER 8.4X16X1		VI1034A0	STAINLESS STEEL WASHER 8.4X16X1																					
CE1052A	CABLE CONNECTION CONTROL - USB MM 750MM		KCE1052A	CONTROL BOARD-USB 650 CONN. CABLE KIT	<table border="1"> <thead> <tr> <th>Code</th> <th>Description</th> <th>Qty</th> <th>UOM</th> </tr> </thead> <tbody> <tr> <td>CE1052A1</td> <td>CABLE CONNECTION CONTROL - USB MM 750M</td> <td>1</td> <td>PZ</td> </tr> <tr> <td>VM1224A0</td> <td>65MY 220MM 2 COLOURS SHRINK TUBE</td> <td>0.350</td> <td>M</td> </tr> </tbody> </table>	Code	Description	Qty	UOM	CE1052A1	CABLE CONNECTION CONTROL - USB MM 750M	1	PZ	VM1224A0	65MY 220MM 2 COLOURS SHRINK TUBE	0.350	M								
Code	Description	Qty	UOM																						
CE1052A1	CABLE CONNECTION CONTROL - USB MM 750M	1	PZ																						
VM1224A0	65MY 220MM 2 COLOURS SHRINK TUBE	0.350	M																						
VM2410A	PLATE TO STOP EXTRUDED LED BAR		KVM2410A	PLATE TO STOP EXTRUDED LED BAR 2P KIT	<table border="1"> <thead> <tr> <th>Code</th> <th>Description</th> <th>Qty</th> <th>UOM</th> </tr> </thead> <tbody> <tr> <td>0B1190A0</td> <td>PLATE TO STOP EXTRUDED LED BAR</td> <td>2</td> <td>PZ</td> </tr> <tr> <td>VM1224A0</td> <td>65MY 220MM 2 COLOURS SHRINK TUBE</td> <td>0.200</td> <td>M</td> </tr> <tr> <td>VM2410A0</td> <td>PLATE TO STOP EXTRUDED LED BAR</td> <td>2</td> <td>PZ</td> </tr> <tr> <td>VM2410A0</td> <td>PLATE TO STOP EXTRUDED LED BAR</td> <td>2</td> <td>PZ</td> </tr> </tbody> </table>	Code	Description	Qty	UOM	0B1190A0	PLATE TO STOP EXTRUDED LED BAR	2	PZ	VM1224A0	65MY 220MM 2 COLOURS SHRINK TUBE	0.200	M	VM2410A0	PLATE TO STOP EXTRUDED LED BAR	2	PZ	VM2410A0	PLATE TO STOP EXTRUDED LED BAR	2	PZ
Code	Description	Qty	UOM																						
0B1190A0	PLATE TO STOP EXTRUDED LED BAR	2	PZ																						
VM1224A0	65MY 220MM 2 COLOURS SHRINK TUBE	0.200	M																						
VM2410A0	PLATE TO STOP EXTRUDED LED BAR	2	PZ																						
VM2410A0	PLATE TO STOP EXTRUDED LED BAR	2	PZ																						



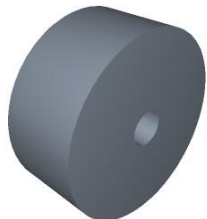

COMPONENT			SPARE PART																						
Code	Description	Image	Code	Description	Components list																				
VN1179A	CONTROL BOARD 40X40X20MM 12V COOLING FAN		KVN1179A	CONTROL BOARD COOLING FAN KIT	<table border="1"> <thead> <tr> <th>Code</th> <th>Description</th> <th>Qty</th> <th>UOM</th> </tr> </thead> <tbody> <tr> <td>VM1224A0</td> <td>65MY 220MM 2 COLOURS SHRINK TUBE</td> <td>0.150</td> <td>M</td> </tr> <tr> <td>VN1179A0</td> <td>CONTROL BOARD 40X40X20MM 12V COOLING FAN</td> <td>1</td> <td>PZ</td> </tr> <tr> <td>VN1179A0</td> <td>CONTROL BOARD 40X40X20MM 12V COOLING FAN</td> <td>1</td> <td>PZ</td> </tr> <tr> <td>VN1179A1</td> <td>CONTROL BOARD 40X40X20MM 12V COOLING FAN</td> <td>1</td> <td>PZ</td> </tr> </tbody> </table>	Code	Description	Qty	UOM	VM1224A0	65MY 220MM 2 COLOURS SHRINK TUBE	0.150	M	VN1179A0	CONTROL BOARD 40X40X20MM 12V COOLING FAN	1	PZ	VN1179A0	CONTROL BOARD 40X40X20MM 12V COOLING FAN	1	PZ	VN1179A1	CONTROL BOARD 40X40X20MM 12V COOLING FAN	1	PZ
Code	Description	Qty	UOM																						
VM1224A0	65MY 220MM 2 COLOURS SHRINK TUBE	0.150	M																						
VN1179A0	CONTROL BOARD 40X40X20MM 12V COOLING FAN	1	PZ																						
VN1179A0	CONTROL BOARD 40X40X20MM 12V COOLING FAN	1	PZ																						
VN1179A1	CONTROL BOARD 40X40X20MM 12V COOLING FAN	1	PZ																						
VM2518A	BOARD COOLING FAN SUPPORT		KVM2518A	PANEL COOLING FAN SUPPORT KIT	<table border="1"> <thead> <tr> <th>Code</th> <th>Description</th> <th>Qty</th> <th>UOM</th> </tr> </thead> <tbody> <tr> <td>VM1224A0</td> <td>65MY 220MM 2 COLOURS SHRINK TUBE</td> <td>0.150</td> <td>M</td> </tr> <tr> <td>VM2518A0</td> <td>BOARD COOLING FAN SUPPORT</td> <td>1</td> <td>PZ</td> </tr> <tr> <td>VM2518A0</td> <td>BOARD COOLING FAN SUPPORT</td> <td>1</td> <td>PZ</td> </tr> </tbody> </table>	Code	Description	Qty	UOM	VM1224A0	65MY 220MM 2 COLOURS SHRINK TUBE	0.150	M	VM2518A0	BOARD COOLING FAN SUPPORT	1	PZ	VM2518A0	BOARD COOLING FAN SUPPORT	1	PZ				
Code	Description	Qty	UOM																						
VM1224A0	65MY 220MM 2 COLOURS SHRINK TUBE	0.150	M																						
VM2518A0	BOARD COOLING FAN SUPPORT	1	PZ																						
VM2518A0	BOARD COOLING FAN SUPPORT	1	PZ																						
VI1074A	4X16 SCREW FOR PLASTIC		VI1074A0	4X16 SCREW FOR PLASTIC																					
0B1219A	MM DOUBLE GLASS DOOR INT UPPER BEAM 860		0B1219A1	MM DOUBLE GLASS DOOR INT UPPER BEAM 860																					

COMPONENT			SPARE PART																		
Code	Description	Image	Code	Description	Components list																
OB1175A	XEBC-06EU-E LEFT EXT DOOR COLUMN		OB1175A0	XEBC-06EU-E LEFT EXT DOOR COLUMN																	
OB1167A	EXT. GLASS SUPPORT PROFILE		OUTOFPRODUCTIO	ITEM OUT OF PRODUCTION																	
PE1059A	MM USB-RESET SUPPORT		KPE1059A	MM USB-RESET SUPPORT KIT	<table border="1"> <thead> <tr> <th>Code</th> <th>Description</th> <th>Qty</th> <th>UOM</th> </tr> </thead> <tbody> <tr> <td>PE1059A0</td> <td>MM USB-RESET SUPPORT</td> <td>1</td> <td>PZ</td> </tr> <tr> <td>VI1220A1</td> <td>4,2X12 TCB SELF-TAPPIN G SCREW</td> <td>2</td> <td>PZ</td> </tr> <tr> <td>VM2147A0</td> <td>410X343X15 MM PINK SMOOTH ESD SPONGE</td> <td>0.250</td> <td>PZ</td> </tr> </tbody> </table>	Code	Description	Qty	UOM	PE1059A0	MM USB-RESET SUPPORT	1	PZ	VI1220A1	4,2X12 TCB SELF-TAPPIN G SCREW	2	PZ	VM2147A0	410X343X15 MM PINK SMOOTH ESD SPONGE	0.250	PZ
Code	Description	Qty	UOM																		
PE1059A0	MM USB-RESET SUPPORT	1	PZ																		
VI1220A1	4,2X12 TCB SELF-TAPPIN G SCREW	2	PZ																		
VM2147A0	410X343X15 MM PINK SMOOTH ESD SPONGE	0.250	PZ																		
CE1285A	EMI ROUND FERRITE MOD.2643801502		CE1285A0	EMI ROUND FERRITE MOD.2643801502																	
CE1097A	4M SIHF 4 POLES MICROFIT CANBUS		KCE1097A	4 POLES MICROFIT 4 METRES BUS CABLE KIT	<table border="1"> <thead> <tr> <th>Code</th> <th>Description</th> <th>Qty</th> <th>UOM</th> </tr> </thead> <tbody> <tr> <td>CE1097A0</td> <td>4M SIHF 4 POLES MICROFIT CANBUS</td> <td>1</td> <td>PZ</td> </tr> <tr> <td>CE1285A0</td> <td>EMI ROUND FERRITE MOD.26438015 02</td> <td>1</td> <td>PZ</td> </tr> <tr> <td>VM1224A0</td> <td>65MY 220MM 2 COLOURS SHRINK TUBE</td> <td>0.300</td> <td>M</td> </tr> </tbody> </table>	Code	Description	Qty	UOM	CE1097A0	4M SIHF 4 POLES MICROFIT CANBUS	1	PZ	CE1285A0	EMI ROUND FERRITE MOD.26438015 02	1	PZ	VM1224A0	65MY 220MM 2 COLOURS SHRINK TUBE	0.300	M
Code	Description	Qty	UOM																		
CE1097A0	4M SIHF 4 POLES MICROFIT CANBUS	1	PZ																		
CE1285A0	EMI ROUND FERRITE MOD.26438015 02	1	PZ																		
VM1224A0	65MY 220MM 2 COLOURS SHRINK TUBE	0.300	M																		



COMPONENT			SPARE PART																		
Code	Description	Image	Code	Description	Components list																
VM2305A	6 SERIES DOOR CAP FIXING PAWL		KVM2305A	MM FIXING DOOR THUB SCREWS 10 PCS KIT	<table border="1"> <thead> <tr> <th>Code</th> <th>Description</th> <th>Qty</th> <th>UOM</th> </tr> </thead> <tbody> <tr> <td>VM1224A0</td> <td>65MY 220MM 2 COLOURS SHRINK TUBE</td> <td>0.200</td> <td>M</td> </tr> <tr> <td>VM2305A0</td> <td>6 SERIES DOOR CAP FIXING PAWL</td> <td>10</td> <td>PZ</td> </tr> </tbody> </table>	Code	Description	Qty	UOM	VM1224A0	65MY 220MM 2 COLOURS SHRINK TUBE	0.200	M	VM2305A0	6 SERIES DOOR CAP FIXING PAWL	10	PZ				
Code	Description	Qty	UOM																		
VM1224A0	65MY 220MM 2 COLOURS SHRINK TUBE	0.200	M																		
VM2305A0	6 SERIES DOOR CAP FIXING PAWL	10	PZ																		
VE1030A	MAGNET FOR DOOR MICROSWITCH D=22,9MM		KVE1030A	2 PCS MAGNET KIT FOR DOOR SWITCH	<table border="1"> <thead> <tr> <th>Code</th> <th>Description</th> <th>Qty</th> <th>UOM</th> </tr> </thead> <tbody> <tr> <td>VE1030A1</td> <td>MAGNET FOR DOOR MICROSWITC H D=22,9MM</td> <td>2</td> <td>PZ</td> </tr> <tr> <td>VM1224A0</td> <td>65MY 220MM 2 COLOURS SHRINK TUBE</td> <td>0.150</td> <td>M</td> </tr> </tbody> </table>	Code	Description	Qty	UOM	VE1030A1	MAGNET FOR DOOR MICROSWITC H D=22,9MM	2	PZ	VM1224A0	65MY 220MM 2 COLOURS SHRINK TUBE	0.150	M				
Code	Description	Qty	UOM																		
VE1030A1	MAGNET FOR DOOR MICROSWITC H D=22,9MM	2	PZ																		
VM1224A0	65MY 220MM 2 COLOURS SHRINK TUBE	0.150	M																		
			KVE1020A	MICROSWITCH KIT	<table border="1"> <thead> <tr> <th>Code</th> <th>Description</th> <th>Qty</th> <th>UOM</th> </tr> </thead> <tbody> <tr> <td>VE1020A2</td> <td>MAGNETIC DOOR MICROSWITC</td> <td>1</td> <td>PZ</td> </tr> <tr> <td>VE1030A1</td> <td>MAGNET FOR DOOR MICROSWITC H D=22,9MM</td> <td>4</td> <td>PZ</td> </tr> <tr> <td>VM1224A0</td> <td>65MY 220MM 2 COLOURS SHRINK TUBE</td> <td>0.250</td> <td>M</td> </tr> </tbody> </table>	Code	Description	Qty	UOM	VE1020A2	MAGNETIC DOOR MICROSWITC	1	PZ	VE1030A1	MAGNET FOR DOOR MICROSWITC H D=22,9MM	4	PZ	VM1224A0	65MY 220MM 2 COLOURS SHRINK TUBE	0.250	M
Code	Description	Qty	UOM																		
VE1020A2	MAGNETIC DOOR MICROSWITC	1	PZ																		
VE1030A1	MAGNET FOR DOOR MICROSWITC H D=22,9MM	4	PZ																		
VM1224A0	65MY 220MM 2 COLOURS SHRINK TUBE	0.250	M																		
VM2268A	DOOR MAGNET COVER		KVM2268A	DOOR MAGNET COVER KIT	<table border="1"> <thead> <tr> <th>Code</th> <th>Description</th> <th>Qty</th> <th>UOM</th> </tr> </thead> <tbody> <tr> <td>VM1224A0</td> <td>65MY 220MM 2 COLOURS SHRINK TUBE</td> <td>0.200</td> <td>M</td> </tr> <tr> <td>VM2268A0</td> <td>DOOR MAGNET COVER</td> <td>1</td> <td>PZ</td> </tr> </tbody> </table>	Code	Description	Qty	UOM	VM1224A0	65MY 220MM 2 COLOURS SHRINK TUBE	0.200	M	VM2268A0	DOOR MAGNET COVER	1	PZ				
Code	Description	Qty	UOM																		
VM1224A0	65MY 220MM 2 COLOURS SHRINK TUBE	0.200	M																		
VM2268A0	DOOR MAGNET COVER	1	PZ																		
VI1996A	M5X35 SCREW		VI1996A0	M5X35 SCREW																	

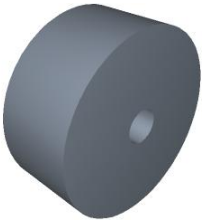





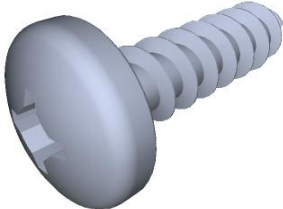
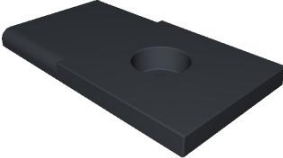
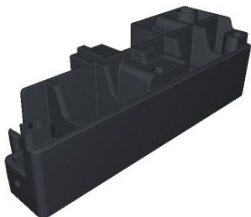

COMPONENT			SPARE PART																																						
Code	Description	Image	Code	Description	Components list																																				
VM2267A	INTERNAL GLASS LOCKING SYSTEM SLIDER		VM2267A0	INTERNAL GLASS LOCKING SYSTEM SLIDER																																					
VI1930A	ST. STEEL 5X20 CHIP SCREW		VI1930A1	ST. STEEL 5X20 CHIP SCREW																																					
VM2269B	INNER GLASS FIXING CAP		KVM2269B	INNER GLASS FIXING CAP KIT -M	<table border="1"> <thead> <tr> <th>Code</th> <th>Description</th> <th>Qty</th> <th>UOM</th> </tr> </thead> <tbody> <tr> <td>VM2269B0</td> <td>INNER GLASS FIXING CAP</td> <td>2</td> <td>PZ</td> </tr> </tbody> </table>	Code	Description	Qty	UOM	VM2269B0	INNER GLASS FIXING CAP	2	PZ																												
Code	Description	Qty	UOM																																						
VM2269B0	INNER GLASS FIXING CAP	2	PZ																																						
VM2262B			KVM2262B	MIND.MAPS -M DOOR RIGHT UPPER CAP KIT	<table border="1"> <thead> <tr> <th>Code</th> <th>Description</th> <th>Qty</th> <th>UOM</th> </tr> </thead> <tbody> <tr> <td>RC1200A0</td> <td>ED=4 WIRE D.=0.5 COMPRESSIO N SPRING</td> <td>2</td> <td>PZ</td> </tr> <tr> <td>VE1030A1</td> <td>MAGNET FOR DOOR MICROSWITC H D=22.9MM</td> <td>1</td> <td>PZ</td> </tr> <tr> <td>VI1220A1</td> <td>4,2X12 TCB SELF-TAPPIN G SCREW</td> <td>1</td> <td>PZ</td> </tr> <tr> <td>VI1930A1</td> <td>ST. STEEL 5X20 CHIP SCREW</td> <td>4</td> <td>PZ</td> </tr> <tr> <td>VI1996A0</td> <td>M5X35 SCREW</td> <td>4</td> <td>PZ</td> </tr> <tr> <td>VM1224A0</td> <td>65MY 220MM 2 COLOURS SHRINK TUBE</td> <td>0.300</td> <td>M</td> </tr> <tr> <td>VM2262B0</td> <td></td> <td>1</td> <td>PZ</td> </tr> <tr> <td>VM2267A0</td> <td>INTERNAL GLASS LOCKING SYSTEM SLIDER</td> <td>1</td> <td>PZ</td> </tr> </tbody> </table>	Code	Description	Qty	UOM	RC1200A0	ED=4 WIRE D.=0.5 COMPRESSIO N SPRING	2	PZ	VE1030A1	MAGNET FOR DOOR MICROSWITC H D=22.9MM	1	PZ	VI1220A1	4,2X12 TCB SELF-TAPPIN G SCREW	1	PZ	VI1930A1	ST. STEEL 5X20 CHIP SCREW	4	PZ	VI1996A0	M5X35 SCREW	4	PZ	VM1224A0	65MY 220MM 2 COLOURS SHRINK TUBE	0.300	M	VM2262B0		1	PZ	VM2267A0	INTERNAL GLASS LOCKING SYSTEM SLIDER	1	PZ
Code	Description	Qty	UOM																																						
RC1200A0	ED=4 WIRE D.=0.5 COMPRESSIO N SPRING	2	PZ																																						
VE1030A1	MAGNET FOR DOOR MICROSWITC H D=22.9MM	1	PZ																																						
VI1220A1	4,2X12 TCB SELF-TAPPIN G SCREW	1	PZ																																						
VI1930A1	ST. STEEL 5X20 CHIP SCREW	4	PZ																																						
VI1996A0	M5X35 SCREW	4	PZ																																						
VM1224A0	65MY 220MM 2 COLOURS SHRINK TUBE	0.300	M																																						
VM2262B0		1	PZ																																						
VM2267A0	INTERNAL GLASS LOCKING SYSTEM SLIDER	1	PZ																																						

COMPONENT			SPARE PART																		
Code	Description	Image	Code	Description	Components list																
VM2262B			KVM2262B	MIND.MAPS -M DOOR RIGHT UPPER CAP KIT	<table border="1"> <thead> <tr> <th>Code</th> <th>Description</th> <th>Qty</th> <th>UOM</th> </tr> </thead> <tbody> <tr> <td>VM2268A0</td> <td>DOOR MAGNET COVER</td> <td>1</td> <td>PZ</td> </tr> <tr> <td>VM2269B0</td> <td>INNER GLASS FIXING CAP</td> <td>1</td> <td>PZ</td> </tr> <tr> <td>VM2305A0</td> <td>6 SERIES DOOR CAP FIXING PAWL</td> <td>4</td> <td>PZ</td> </tr> </tbody> </table>	Code	Description	Qty	UOM	VM2268A0	DOOR MAGNET COVER	1	PZ	VM2269B0	INNER GLASS FIXING CAP	1	PZ	VM2305A0	6 SERIES DOOR CAP FIXING PAWL	4	PZ
Code	Description	Qty	UOM																		
VM2268A0	DOOR MAGNET COVER	1	PZ																		
VM2269B0	INNER GLASS FIXING CAP	1	PZ																		
VM2305A0	6 SERIES DOOR CAP FIXING PAWL	4	PZ																		
VM2305A	6 SERIES DOOR CAP FIXING PAWL		KVM2305A	MM FIXING DOOR THUB SCREWS 10 PCS KIT	<table border="1"> <thead> <tr> <th>Code</th> <th>Description</th> <th>Qty</th> <th>UOM</th> </tr> </thead> <tbody> <tr> <td>VM1224A0</td> <td>65MY 220MM 2 COLOURS SHRINK TUBE</td> <td>0.200</td> <td>M</td> </tr> <tr> <td>VM2305A0</td> <td>6 SERIES DOOR CAP FIXING PAWL</td> <td>10</td> <td>PZ</td> </tr> </tbody> </table>	Code	Description	Qty	UOM	VM1224A0	65MY 220MM 2 COLOURS SHRINK TUBE	0.200	M	VM2305A0	6 SERIES DOOR CAP FIXING PAWL	10	PZ				
Code	Description	Qty	UOM																		
VM1224A0	65MY 220MM 2 COLOURS SHRINK TUBE	0.200	M																		
VM2305A0	6 SERIES DOOR CAP FIXING PAWL	10	PZ																		
VE1030A	MAGNET FOR DOOR MICROSWITCH D=22,9MM		KVE1030A	2 PCS MAGNET KIT FOR DOOR SWITCH	<table border="1"> <thead> <tr> <th>Code</th> <th>Description</th> <th>Qty</th> <th>UOM</th> </tr> </thead> <tbody> <tr> <td>VE1030A1</td> <td>MAGNET FOR DOOR MICROSWITC H D=22,9MM</td> <td>2</td> <td>PZ</td> </tr> <tr> <td>VM1224A0</td> <td>65MY 220MM 2 COLOURS SHRINK TUBE</td> <td>0.150</td> <td>M</td> </tr> </tbody> </table>	Code	Description	Qty	UOM	VE1030A1	MAGNET FOR DOOR MICROSWITC H D=22,9MM	2	PZ	VM1224A0	65MY 220MM 2 COLOURS SHRINK TUBE	0.150	M				
Code	Description	Qty	UOM																		
VE1030A1	MAGNET FOR DOOR MICROSWITC H D=22,9MM	2	PZ																		
VM1224A0	65MY 220MM 2 COLOURS SHRINK TUBE	0.150	M																		
			KVE1020A	MICROSWITCH KIT	<table border="1"> <thead> <tr> <th>Code</th> <th>Description</th> <th>Qty</th> <th>UOM</th> </tr> </thead> <tbody> <tr> <td>VE1020A2</td> <td>MAGNETIC DOOR MICROSWITC</td> <td>1</td> <td>PZ</td> </tr> <tr> <td>VE1030A1</td> <td>MAGNET FOR DOOR MICROSWITC H D=22,9MM</td> <td>4</td> <td>PZ</td> </tr> <tr> <td>VM1224A0</td> <td>65MY 220MM 2 COLOURS SHRINK TUBE</td> <td>0.250</td> <td>M</td> </tr> </tbody> </table>	Code	Description	Qty	UOM	VE1020A2	MAGNETIC DOOR MICROSWITC	1	PZ	VE1030A1	MAGNET FOR DOOR MICROSWITC H D=22,9MM	4	PZ	VM1224A0	65MY 220MM 2 COLOURS SHRINK TUBE	0.250	M
Code	Description	Qty	UOM																		
VE1020A2	MAGNETIC DOOR MICROSWITC	1	PZ																		
VE1030A1	MAGNET FOR DOOR MICROSWITC H D=22,9MM	4	PZ																		
VM1224A0	65MY 220MM 2 COLOURS SHRINK TUBE	0.250	M																		
VM2268A	DOOR MAGNET COVER		KVM2268A	DOOR MAGNET COVER KIT	<table border="1"> <thead> <tr> <th>Code</th> <th>Description</th> <th>Qty</th> <th>UOM</th> </tr> </thead> <tbody> <tr> <td>VM1224A0</td> <td>65MY 220MM 2 COLOURS SHRINK TUBE</td> <td>0.200</td> <td>M</td> </tr> <tr> <td>VM2268A0</td> <td>DOOR MAGNET COVER</td> <td>1</td> <td>PZ</td> </tr> </tbody> </table>	Code	Description	Qty	UOM	VM1224A0	65MY 220MM 2 COLOURS SHRINK TUBE	0.200	M	VM2268A0	DOOR MAGNET COVER	1	PZ				
Code	Description	Qty	UOM																		
VM1224A0	65MY 220MM 2 COLOURS SHRINK TUBE	0.200	M																		
VM2268A0	DOOR MAGNET COVER	1	PZ																		

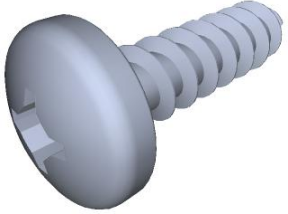

COMPONENT			SPARE PART																										
Code	Description	Image	Code	Description	Components list																								
VI1996A	M5X35 SCREW		VI1996A0	M5X35 SCREW																									
VM2267A	INTERNAL GLASS LOCKING SYSTEM SLIDER		VM2267A0	INTERNAL GLASS LOCKING SYSTEM SLIDER																									
VI1930A	ST. STEEL 5X20 CHIP SCREW		VI1930A1	ST. STEEL 5X20 CHIP SCREW																									
VM2269B	INNER GLASS FIXING CAP		KVM2269B	INNER GLASS FIXING CAP KIT -M	<table border="1"> <thead> <tr> <th>Code</th> <th>Description</th> <th>Qty</th> <th>UOM</th> </tr> </thead> <tbody> <tr> <td>VM2269B0</td> <td>INNER GLASS FIXING CAP</td> <td>2</td> <td>PZ</td> </tr> </tbody> </table>	Code	Description	Qty	UOM	VM2269B0	INNER GLASS FIXING CAP	2	PZ																
Code	Description	Qty	UOM																										
VM2269B0	INNER GLASS FIXING CAP	2	PZ																										
VM2261B			KVM2261B	MIND.MAPS -M DOOR RIGHT LOWER CAP KIT	<table border="1"> <thead> <tr> <th>Code</th> <th>Description</th> <th>Qty</th> <th>UOM</th> </tr> </thead> <tbody> <tr> <td>RC1200A0</td> <td>ED=4 WIRE D.=0.5 COMPRESSIO N SPRING</td> <td>2</td> <td>PZ</td> </tr> <tr> <td>VE1030A1</td> <td>MAGNET FOR DOOR MICROSWITC H D=22,9MM</td> <td>1</td> <td>PZ</td> </tr> <tr> <td>VI1220A1</td> <td>4,2X12 TCB SELF-TAPPIN G SCREW</td> <td>1</td> <td>PZ</td> </tr> <tr> <td>VI1930A1</td> <td>ST. STEEL 5X20 CHIP SCREW</td> <td>4</td> <td>PZ</td> </tr> <tr> <td>VI1996A0</td> <td>M5X35 SCREW</td> <td>4</td> <td>PZ</td> </tr> </tbody> </table>	Code	Description	Qty	UOM	RC1200A0	ED=4 WIRE D.=0.5 COMPRESSIO N SPRING	2	PZ	VE1030A1	MAGNET FOR DOOR MICROSWITC H D=22,9MM	1	PZ	VI1220A1	4,2X12 TCB SELF-TAPPIN G SCREW	1	PZ	VI1930A1	ST. STEEL 5X20 CHIP SCREW	4	PZ	VI1996A0	M5X35 SCREW	4	PZ
Code	Description	Qty	UOM																										
RC1200A0	ED=4 WIRE D.=0.5 COMPRESSIO N SPRING	2	PZ																										
VE1030A1	MAGNET FOR DOOR MICROSWITC H D=22,9MM	1	PZ																										
VI1220A1	4,2X12 TCB SELF-TAPPIN G SCREW	1	PZ																										
VI1930A1	ST. STEEL 5X20 CHIP SCREW	4	PZ																										
VI1996A0	M5X35 SCREW	4	PZ																										

COMPONENT			SPARE PART																														
Code	Description	Image	Code	Description	Components list																												
VM2261B			KVM2261B	MIND.MAPS -M DOOR RIGHT LOWER CAP KIT	<table border="1"> <thead> <tr> <th>Code</th> <th>Description</th> <th>Qty</th> <th>UOM</th> </tr> </thead> <tbody> <tr> <td>VM1224A0</td> <td>65MY 220MM 2 COLOURS SHRINK TUBE</td> <td>0.300</td> <td>M</td> </tr> <tr> <td>VM2261B0</td> <td></td> <td>1</td> <td>PZ</td> </tr> <tr> <td>VM2267A0</td> <td>INTERNAL GLASS LOCKING SYSTEM SLIDER</td> <td>1</td> <td>PZ</td> </tr> <tr> <td>VM2268A0</td> <td>DOOR MAGNET COVER</td> <td>1</td> <td>PZ</td> </tr> <tr> <td>VM2269B0</td> <td>INNER GLASS FIXING CAP</td> <td>1</td> <td>PZ</td> </tr> <tr> <td>VM2305A0</td> <td>6 SERIES DOOR CAP FIXING PAWL</td> <td>4</td> <td>PZ</td> </tr> </tbody> </table>	Code	Description	Qty	UOM	VM1224A0	65MY 220MM 2 COLOURS SHRINK TUBE	0.300	M	VM2261B0		1	PZ	VM2267A0	INTERNAL GLASS LOCKING SYSTEM SLIDER	1	PZ	VM2268A0	DOOR MAGNET COVER	1	PZ	VM2269B0	INNER GLASS FIXING CAP	1	PZ	VM2305A0	6 SERIES DOOR CAP FIXING PAWL	4	PZ
Code	Description	Qty	UOM																														
VM1224A0	65MY 220MM 2 COLOURS SHRINK TUBE	0.300	M																														
VM2261B0		1	PZ																														
VM2267A0	INTERNAL GLASS LOCKING SYSTEM SLIDER	1	PZ																														
VM2268A0	DOOR MAGNET COVER	1	PZ																														
VM2269B0	INNER GLASS FIXING CAP	1	PZ																														
VM2305A0	6 SERIES DOOR CAP FIXING PAWL	4	PZ																														
VM2305A	6 SERIES DOOR CAP FIXING PAWL		KVM2305A	MM FIXING DOOR THUB SCREWS 10 PCS KIT	<table border="1"> <thead> <tr> <th>Code</th> <th>Description</th> <th>Qty</th> <th>UOM</th> </tr> </thead> <tbody> <tr> <td>VM1224A0</td> <td>65MY 220MM 2 COLOURS SHRINK TUBE</td> <td>0.200</td> <td>M</td> </tr> <tr> <td>VM2305A0</td> <td>6 SERIES DOOR CAP FIXING PAWL</td> <td>10</td> <td>PZ</td> </tr> </tbody> </table>	Code	Description	Qty	UOM	VM1224A0	65MY 220MM 2 COLOURS SHRINK TUBE	0.200	M	VM2305A0	6 SERIES DOOR CAP FIXING PAWL	10	PZ																
Code	Description	Qty	UOM																														
VM1224A0	65MY 220MM 2 COLOURS SHRINK TUBE	0.200	M																														
VM2305A0	6 SERIES DOOR CAP FIXING PAWL	10	PZ																														
VM2275A	SMOOTH BUSHING		KVM2275A	SMOOTH PIN BUSHING KIT	<table border="1"> <thead> <tr> <th>Code</th> <th>Description</th> <th>Qty</th> <th>UOM</th> </tr> </thead> <tbody> <tr> <td>VM1224A0</td> <td>65MY 220MM 2 COLOURS SHRINK TUBE</td> <td>0.150</td> <td>M</td> </tr> <tr> <td>VM2275A0</td> <td>SMOOTH BUSHING</td> <td>1</td> <td>PZ</td> </tr> </tbody> </table>	Code	Description	Qty	UOM	VM1224A0	65MY 220MM 2 COLOURS SHRINK TUBE	0.150	M	VM2275A0	SMOOTH BUSHING	1	PZ																
Code	Description	Qty	UOM																														
VM1224A0	65MY 220MM 2 COLOURS SHRINK TUBE	0.150	M																														
VM2275A0	SMOOTH BUSHING	1	PZ																														
VI1996A	M5X35 SCREW		VI1996A0	M5X35 SCREW																													

COMPONENT			SPARE PART																																						
Code	Description	Image	Code	Description	Components list																																				
VI1930A	ST. STEEL 5X20 CHIP SCREW		VI1930A1	ST. STEEL 5X20 CHIP SCREW																																					
VP1081A	UPPER HINGE CAP FOR UPPER INNER GLASS		KVM2384B	MM- M LEFT DOOR RIGHT LOWER CAP KIT	<table border="1"> <thead> <tr> <th>Code</th> <th>Description</th> <th>Qty</th> <th>UOM</th> </tr> </thead> <tbody> <tr> <td>VI1074A0</td> <td>4X16 SCREW FOR PLASTIC</td> <td>1</td> <td>PZ</td> </tr> <tr> <td>VI1930A1</td> <td>ST. STEEL 5X20 CHIP SCREW</td> <td>4</td> <td>PZ</td> </tr> <tr> <td>VI1996A0</td> <td>M5X35 SCREW</td> <td>2</td> <td>PZ</td> </tr> <tr> <td>VM2274A0</td> <td>GROOVED BUSHING</td> <td>1</td> <td>PZ</td> </tr> <tr> <td>VM2305A0</td> <td>6 SERIES DOOR CAP FIXING PAWL</td> <td>3</td> <td>PZ</td> </tr> <tr> <td>VM2384B0</td> <td></td> <td>1</td> <td>PZ</td> </tr> <tr> <td>VP1081A0</td> <td>UPPER HINGE CAP FOR UPPER INNER GLASS</td> <td>1</td> <td>PZ</td> </tr> </tbody> </table>	Code	Description	Qty	UOM	VI1074A0	4X16 SCREW FOR PLASTIC	1	PZ	VI1930A1	ST. STEEL 5X20 CHIP SCREW	4	PZ	VI1996A0	M5X35 SCREW	2	PZ	VM2274A0	GROOVED BUSHING	1	PZ	VM2305A0	6 SERIES DOOR CAP FIXING PAWL	3	PZ	VM2384B0		1	PZ	VP1081A0	UPPER HINGE CAP FOR UPPER INNER GLASS	1	PZ				
Code	Description	Qty	UOM																																						
VI1074A0	4X16 SCREW FOR PLASTIC	1	PZ																																						
VI1930A1	ST. STEEL 5X20 CHIP SCREW	4	PZ																																						
VI1996A0	M5X35 SCREW	2	PZ																																						
VM2274A0	GROOVED BUSHING	1	PZ																																						
VM2305A0	6 SERIES DOOR CAP FIXING PAWL	3	PZ																																						
VM2384B0		1	PZ																																						
VP1081A0	UPPER HINGE CAP FOR UPPER INNER GLASS	1	PZ																																						
			KVM2260B	MM M RIGHT DOOR -LEFT UPPER CAP KI	<table border="1"> <thead> <tr> <th>Code</th> <th>Description</th> <th>Qty</th> <th>UOM</th> </tr> </thead> <tbody> <tr> <td>VI1103A0</td> <td>40X12 TBSP SCREW FOR PLASTIC</td> <td>1</td> <td>PZ</td> </tr> <tr> <td>VI1930A1</td> <td>ST. STEEL 5X20 CHIP SCREW</td> <td>4</td> <td>PZ</td> </tr> <tr> <td>VI1996A0</td> <td>M5X35 SCREW</td> <td>2</td> <td>PZ</td> </tr> <tr> <td>VM1224A0</td> <td>65MY 220MM 2 COLOURS SHRINK TUBE</td> <td>0.300</td> <td>M</td> </tr> <tr> <td>VM2260B0</td> <td>S6 LEFT UPPER CAP</td> <td>1</td> <td>PZ</td> </tr> <tr> <td>VM2275A0</td> <td>SMOOTH BUSHING</td> <td>1</td> <td>PZ</td> </tr> <tr> <td>VM2305A0</td> <td>6 SERIES DOOR CAP FIXING PAWL</td> <td>3</td> <td>PZ</td> </tr> <tr> <td>VP1081A0</td> <td>UPPER HINGE CAP FOR UPPER INNER GLASS</td> <td>1</td> <td>PZ</td> </tr> </tbody> </table>	Code	Description	Qty	UOM	VI1103A0	40X12 TBSP SCREW FOR PLASTIC	1	PZ	VI1930A1	ST. STEEL 5X20 CHIP SCREW	4	PZ	VI1996A0	M5X35 SCREW	2	PZ	VM1224A0	65MY 220MM 2 COLOURS SHRINK TUBE	0.300	M	VM2260B0	S6 LEFT UPPER CAP	1	PZ	VM2275A0	SMOOTH BUSHING	1	PZ	VM2305A0	6 SERIES DOOR CAP FIXING PAWL	3	PZ	VP1081A0	UPPER HINGE CAP FOR UPPER INNER GLASS	1	PZ
Code	Description	Qty	UOM																																						
VI1103A0	40X12 TBSP SCREW FOR PLASTIC	1	PZ																																						
VI1930A1	ST. STEEL 5X20 CHIP SCREW	4	PZ																																						
VI1996A0	M5X35 SCREW	2	PZ																																						
VM1224A0	65MY 220MM 2 COLOURS SHRINK TUBE	0.300	M																																						
VM2260B0	S6 LEFT UPPER CAP	1	PZ																																						
VM2275A0	SMOOTH BUSHING	1	PZ																																						
VM2305A0	6 SERIES DOOR CAP FIXING PAWL	3	PZ																																						
VP1081A0	UPPER HINGE CAP FOR UPPER INNER GLASS	1	PZ																																						

COMPONENT			SPARE PART																																												
Code	Description	Image	Code	Description	Components list																																										
VM2260B	S6 LEFT UPPER CAP		KVM2260B	MM M RIGHT DOOR -LEFT UPPER CAP KI	<table border="1"> <thead> <tr> <th>Code</th> <th>Description</th> <th>Qty</th> <th>UOM</th> </tr> </thead> <tbody> <tr> <td>VI1103A0</td> <td>40X12 TBSP SCREW FOR PLASTIC</td> <td>1</td> <td>PZ</td> </tr> <tr> <td>VI1930A1</td> <td>ST. STEEL 5X20 CHIP SCREW</td> <td>4</td> <td>PZ</td> </tr> <tr> <td>VI1996A0</td> <td>M5X35 SCREW</td> <td>2</td> <td>PZ</td> </tr> <tr> <td>VM1224A0</td> <td>65MY 220MM 2 COLOURS SHRINK TUBE</td> <td>0.300</td> <td>M</td> </tr> <tr> <td>VM2260B0</td> <td>S6 LEFT UPPER CAP</td> <td>1</td> <td>PZ</td> </tr> <tr> <td>VM2275A0</td> <td>SMOOTH BUSHING</td> <td>1</td> <td>PZ</td> </tr> <tr> <td>VM2305A0</td> <td>6 SERIES DOOR CAP FIXING PAWL</td> <td>3</td> <td>PZ</td> </tr> <tr> <td>VP1081A0</td> <td>UPPER HINGE CAP FOR UPPER INNER GLASS</td> <td>1</td> <td>PZ</td> </tr> </tbody> </table>	Code	Description	Qty	UOM	VI1103A0	40X12 TBSP SCREW FOR PLASTIC	1	PZ	VI1930A1	ST. STEEL 5X20 CHIP SCREW	4	PZ	VI1996A0	M5X35 SCREW	2	PZ	VM1224A0	65MY 220MM 2 COLOURS SHRINK TUBE	0.300	M	VM2260B0	S6 LEFT UPPER CAP	1	PZ	VM2275A0	SMOOTH BUSHING	1	PZ	VM2305A0	6 SERIES DOOR CAP FIXING PAWL	3	PZ	VP1081A0	UPPER HINGE CAP FOR UPPER INNER GLASS	1	PZ						
					Code	Description	Qty	UOM																																							
					VI1103A0	40X12 TBSP SCREW FOR PLASTIC	1	PZ																																							
					VI1930A1	ST. STEEL 5X20 CHIP SCREW	4	PZ																																							
					VI1996A0	M5X35 SCREW	2	PZ																																							
					VM1224A0	65MY 220MM 2 COLOURS SHRINK TUBE	0.300	M																																							
					VM2260B0	S6 LEFT UPPER CAP	1	PZ																																							
					VM2275A0	SMOOTH BUSHING	1	PZ																																							
					VM2305A0	6 SERIES DOOR CAP FIXING PAWL	3	PZ																																							
					VP1081A0	UPPER HINGE CAP FOR UPPER INNER GLASS	1	PZ																																							
VM2274A	GROOVED BUSHING		KVM2274A	GROOVED PIN BUSHING KIT	<table border="1"> <thead> <tr> <th>Code</th> <th>Description</th> <th>Qty</th> <th>UOM</th> </tr> </thead> <tbody> <tr> <td>VM1224A0</td> <td>65MY 220MM 2 COLOURS SHRINK TUBE</td> <td>0.150</td> <td>M</td> </tr> <tr> <td>VM2274A0</td> <td>GROOVED BUSHING</td> <td>1</td> <td>PZ</td> </tr> </tbody> </table>	Code	Description	Qty	UOM	VM1224A0	65MY 220MM 2 COLOURS SHRINK TUBE	0.150	M	VM2274A0	GROOVED BUSHING	1	PZ																														
					Code	Description	Qty	UOM																																							
					VM1224A0	65MY 220MM 2 COLOURS SHRINK TUBE	0.150	M																																							
					VM2274A0	GROOVED BUSHING	1	PZ																																							
					K0B1126AR	BAKERTOP MM RIGHT DOOR LOWER BEAM KIT	<table border="1"> <thead> <tr> <th>Code</th> <th>Description</th> <th>Qty</th> <th>UOM</th> </tr> </thead> <tbody> <tr> <td>0B1126A0</td> <td>DOOR LOWER FRAME SHAPE 860 MM</td> <td>1</td> <td>PZ</td> </tr> <tr> <td>0B1126A1</td> <td></td> <td>1</td> <td>PZ</td> </tr> <tr> <td>RC1200A0</td> <td>ED=4 WIRE D.=0.5 COMPRESSIO N SPRING</td> <td>2</td> <td>PZ</td> </tr> <tr> <td>VI1220A1</td> <td>4,2X12 TCB SELF-TAPPIN G SCREW</td> <td>1</td> <td>PZ</td> </tr> <tr> <td>VI1996A0</td> <td>M5X35 SCREW</td> <td>7</td> <td>PZ</td> </tr> <tr> <td>VM1794A0</td> <td>250X4.8 PA66 BLACK CLAMP</td> <td>2</td> <td>PZ</td> </tr> <tr> <td>VM2103A0</td> <td>CLAMP LOCK</td> <td>2</td> <td>PZ</td> </tr> <tr> <td>VM2259A1</td> <td>6 SERIES DOOR LOWER LEFT CAP</td> <td>1</td> <td>PZ</td> </tr> <tr> <td>VM2261A1</td> <td>6 SERIES DOOR LOWER RIGHT CAP</td> <td>1</td> <td>PZ</td> </tr> </tbody> </table>	Code	Description	Qty	UOM	0B1126A0	DOOR LOWER FRAME SHAPE 860 MM	1	PZ	0B1126A1		1	PZ	RC1200A0	ED=4 WIRE D.=0.5 COMPRESSIO N SPRING	2	PZ	VI1220A1	4,2X12 TCB SELF-TAPPIN G SCREW	1	PZ	VI1996A0	M5X35 SCREW	7	PZ	VM1794A0	250X4.8 PA66 BLACK CLAMP	2	PZ	VM2103A0	CLAMP LOCK	2	PZ	VM2259A1	6 SERIES DOOR LOWER LEFT CAP	1	PZ	VM2261A1	6 SERIES DOOR LOWER RIGHT CAP	1	PZ
							Code	Description	Qty	UOM																																					
							0B1126A0	DOOR LOWER FRAME SHAPE 860 MM	1	PZ																																					
							0B1126A1		1	PZ																																					
							RC1200A0	ED=4 WIRE D.=0.5 COMPRESSIO N SPRING	2	PZ																																					
							VI1220A1	4,2X12 TCB SELF-TAPPIN G SCREW	1	PZ																																					
VI1996A0	M5X35 SCREW	7	PZ																																												
VM1794A0	250X4.8 PA66 BLACK CLAMP	2	PZ																																												
VM2103A0	CLAMP LOCK	2	PZ																																												
VM2259A1	6 SERIES DOOR LOWER LEFT CAP	1	PZ																																												
VM2261A1	6 SERIES DOOR LOWER RIGHT CAP	1	PZ																																												







COMPONENT			SPARE PART																																																															
Code	Description	Image	Code	Description	Components list																																																													
VM2274A	GROOVED BUSHING		K0B1126AR	BAKERTOP MM RIGHT DOOR LOWER BEAM KIT	<table border="1"> <thead> <tr> <th>Code</th> <th>Description</th> <th>Qty</th> <th>UOM</th> </tr> </thead> <tbody> <tr> <td>VM2267A0</td> <td>INTERNAL GLASS LOCKING SYSTEM SLIDER</td> <td>1</td> <td>PZ</td> </tr> <tr> <td>VM2269A0</td> <td>INTERNAL GLASS LOCKING SYSTEM CAP</td> <td>1</td> <td>PZ</td> </tr> <tr> <td>VM2274A0</td> <td>GROOVED BUSHING</td> <td>1</td> <td>PZ</td> </tr> <tr> <td>VM2305A0</td> <td>6 SERIES DOOR CAP FIXING PAWL</td> <td>7</td> <td>PZ</td> </tr> </tbody> </table>	Code	Description	Qty	UOM	VM2267A0	INTERNAL GLASS LOCKING SYSTEM SLIDER	1	PZ	VM2269A0	INTERNAL GLASS LOCKING SYSTEM CAP	1	PZ	VM2274A0	GROOVED BUSHING	1	PZ	VM2305A0	6 SERIES DOOR CAP FIXING PAWL	7	PZ																																									
			Code	Description	Qty	UOM																																																												
VM2267A0	INTERNAL GLASS LOCKING SYSTEM SLIDER	1	PZ																																																															
VM2269A0	INTERNAL GLASS LOCKING SYSTEM CAP	1	PZ																																																															
VM2274A0	GROOVED BUSHING	1	PZ																																																															
VM2305A0	6 SERIES DOOR CAP FIXING PAWL	7	PZ																																																															
K0B1126AL	EU AND 2/1 MM LEFT DOOR LOWER BEAM KIT	<table border="1"> <thead> <tr> <th>Code</th> <th>Description</th> <th>Qty</th> <th>UOM</th> </tr> </thead> <tbody> <tr> <td>0B1126A0</td> <td>DOOR LOWER FRAME SHAPE 860 MM</td> <td>1</td> <td>PZ</td> </tr> <tr> <td>0B1126A1</td> <td></td> <td>1</td> <td>PZ</td> </tr> <tr> <td>RC1200A0</td> <td>ED=4 WIRE D.=0.5 COMPRESSIO N SPRING</td> <td>2</td> <td>PZ</td> </tr> <tr> <td>VI1220A1</td> <td>4,2X12 TCB SELF-TAPPIN G SCREW</td> <td>1</td> <td>PZ</td> </tr> <tr> <td>VI1996A0</td> <td>M5X35 SCREW</td> <td>7</td> <td>PZ</td> </tr> <tr> <td>VM1794A0</td> <td>250X4.8 PA66 BLACK CLAMP</td> <td>2</td> <td>PZ</td> </tr> <tr> <td>VM2103A0</td> <td>CLAMP LOCK</td> <td>2</td> <td>PZ</td> </tr> <tr> <td>VM2267A0</td> <td>INTERNAL GLASS LOCKING SYSTEM SLIDER</td> <td>1</td> <td>PZ</td> </tr> <tr> <td>VM2269A0</td> <td>INTERNAL GLASS LOCKING SYSTEM CAP</td> <td>1</td> <td>PZ</td> </tr> <tr> <td>VM2274A0</td> <td>GROOVED BUSHING</td> <td>1</td> <td>PZ</td> </tr> <tr> <td>VM2305A0</td> <td>6 SERIES DOOR CAP FIXING PAWL</td> <td>7</td> <td>PZ</td> </tr> <tr> <td>VM2384A0</td> <td>MM LEFT DOOR RIGHT LOWER CAP</td> <td>1</td> <td>PZ</td> </tr> <tr> <td>VM2384A0</td> <td>MM LEFT DOOR RIGHT LOWER CAP</td> <td>1</td> <td>PZ</td> </tr> <tr> <td>VM2386A1</td> <td>LEFT MM DOOR LOWER LEFT CAP</td> <td>1</td> <td>PZ</td> </tr> <tr> <td>VM2386A1</td> <td>LEFT MM DOOR LOWER LEFT CAP</td> <td>1</td> <td>PZ</td> </tr> </tbody> </table>	Code	Description	Qty	UOM	0B1126A0	DOOR LOWER FRAME SHAPE 860 MM	1	PZ	0B1126A1		1	PZ	RC1200A0	ED=4 WIRE D.=0.5 COMPRESSIO N SPRING	2	PZ	VI1220A1	4,2X12 TCB SELF-TAPPIN G SCREW	1	PZ	VI1996A0	M5X35 SCREW	7	PZ	VM1794A0	250X4.8 PA66 BLACK CLAMP	2	PZ	VM2103A0	CLAMP LOCK	2	PZ	VM2267A0	INTERNAL GLASS LOCKING SYSTEM SLIDER	1	PZ	VM2269A0	INTERNAL GLASS LOCKING SYSTEM CAP	1	PZ	VM2274A0	GROOVED BUSHING	1	PZ	VM2305A0	6 SERIES DOOR CAP FIXING PAWL	7	PZ	VM2384A0	MM LEFT DOOR RIGHT LOWER CAP	1	PZ	VM2384A0	MM LEFT DOOR RIGHT LOWER CAP	1	PZ	VM2386A1	LEFT MM DOOR LOWER LEFT CAP	1	PZ	VM2386A1	LEFT MM DOOR LOWER LEFT CAP	1	PZ
Code	Description	Qty	UOM																																																															
0B1126A0	DOOR LOWER FRAME SHAPE 860 MM	1	PZ																																																															
0B1126A1		1	PZ																																																															
RC1200A0	ED=4 WIRE D.=0.5 COMPRESSIO N SPRING	2	PZ																																																															
VI1220A1	4,2X12 TCB SELF-TAPPIN G SCREW	1	PZ																																																															
VI1996A0	M5X35 SCREW	7	PZ																																																															
VM1794A0	250X4.8 PA66 BLACK CLAMP	2	PZ																																																															
VM2103A0	CLAMP LOCK	2	PZ																																																															
VM2267A0	INTERNAL GLASS LOCKING SYSTEM SLIDER	1	PZ																																																															
VM2269A0	INTERNAL GLASS LOCKING SYSTEM CAP	1	PZ																																																															
VM2274A0	GROOVED BUSHING	1	PZ																																																															
VM2305A0	6 SERIES DOOR CAP FIXING PAWL	7	PZ																																																															
VM2384A0	MM LEFT DOOR RIGHT LOWER CAP	1	PZ																																																															
VM2384A0	MM LEFT DOOR RIGHT LOWER CAP	1	PZ																																																															
VM2386A1	LEFT MM DOOR LOWER LEFT CAP	1	PZ																																																															
VM2386A1	LEFT MM DOOR LOWER LEFT CAP	1	PZ																																																															



COMPONENT			SPARE PART																																																																																									
Code	Description	Image	Code	Description	Components list																																																																																							
VM2274A	GROOVED BUSHING		K0B1122AR	CHEFTOP MM RIGHT DOOR LOWER BEAM KIT	<table border="1"> <thead> <tr> <th>Code</th> <th>Description</th> <th>Qty</th> <th>UOM</th> </tr> </thead> <tbody> <tr> <td>0B1122A0</td> <td>750MM DOOR LOWER FRAME SHAPE</td> <td>1</td> <td>PZ</td> </tr> <tr> <td>0B1122A1</td> <td>750MM DOOR LOWER FRAME SHAPE</td> <td>1</td> <td>PZ</td> </tr> <tr> <td>RC1200A0</td> <td>ED=4 WIRE D.=0.5 COMPRESSIO N SPRING</td> <td>2</td> <td>PZ</td> </tr> <tr> <td>VI1220A1</td> <td>4,2X12 TCB SELF-TAPPIN G SCREW</td> <td>1</td> <td>PZ</td> </tr> <tr> <td>VI1996A0</td> <td>M5X35 SCREW</td> <td>7</td> <td>PZ</td> </tr> <tr> <td>VM1794A0</td> <td>250X4.8 PA66 BLACK CLAMP</td> <td>2</td> <td>PZ</td> </tr> <tr> <td>VM2103A0</td> <td>CLAMP LOCK</td> <td>2</td> <td>PZ</td> </tr> <tr> <td>VM2259A1</td> <td>6 SERIES DOOR LOWER LEFT CAP</td> <td>1</td> <td>PZ</td> </tr> <tr> <td>VM2261A1</td> <td>6 SERIES DOOR LOWER RIGHT CAP</td> <td>1</td> <td>PZ</td> </tr> <tr> <td>VM2267A0</td> <td>INTERNAL GLASS LOCKING SYSTEM SLIDER</td> <td>1</td> <td>PZ</td> </tr> <tr> <td>VM2269A0</td> <td>INTERNAL GLASS LOCKING SYSTEM CAP</td> <td>1</td> <td>PZ</td> </tr> <tr> <td>VM2274A0</td> <td>GROOVED BUSHING</td> <td>1</td> <td>PZ</td> </tr> <tr> <td>VM2305A0</td> <td>6 SERIES DOOR CAP FIXING PAWL</td> <td>7</td> <td>PZ</td> </tr> </tbody> </table>	Code	Description	Qty	UOM	0B1122A0	750MM DOOR LOWER FRAME SHAPE	1	PZ	0B1122A1	750MM DOOR LOWER FRAME SHAPE	1	PZ	RC1200A0	ED=4 WIRE D.=0.5 COMPRESSIO N SPRING	2	PZ	VI1220A1	4,2X12 TCB SELF-TAPPIN G SCREW	1	PZ	VI1996A0	M5X35 SCREW	7	PZ	VM1794A0	250X4.8 PA66 BLACK CLAMP	2	PZ	VM2103A0	CLAMP LOCK	2	PZ	VM2259A1	6 SERIES DOOR LOWER LEFT CAP	1	PZ	VM2261A1	6 SERIES DOOR LOWER RIGHT CAP	1	PZ	VM2267A0	INTERNAL GLASS LOCKING SYSTEM SLIDER	1	PZ	VM2269A0	INTERNAL GLASS LOCKING SYSTEM CAP	1	PZ	VM2274A0	GROOVED BUSHING	1	PZ	VM2305A0	6 SERIES DOOR CAP FIXING PAWL	7	PZ	K0B1122AL	CHEFTOP MM LEFT DOOR LOWER BEAM KIT	<table border="1"> <thead> <tr> <th>Code</th> <th>Description</th> <th>Qty</th> <th>UOM</th> </tr> </thead> <tbody> <tr> <td>0B1122A0</td> <td>750MM DOOR LOWER FRAME SHAPE</td> <td>1</td> <td>PZ</td> </tr> <tr> <td>0B1122A1</td> <td>750MM DOOR LOWER FRAME SHAPE</td> <td>1</td> <td>PZ</td> </tr> <tr> <td>RC1200A0</td> <td>ED=4 WIRE D.=0.5 COMPRESSIO N SPRING</td> <td>2</td> <td>PZ</td> </tr> <tr> <td>VI1220A1</td> <td>4,2X12 TCB SELF-TAPPIN G SCREW</td> <td>1</td> <td>PZ</td> </tr> <tr> <td>VI1996A0</td> <td>M5X35 SCREW</td> <td>7</td> <td>PZ</td> </tr> <tr> <td>VM1794A0</td> <td>250X4.8 PA66 BLACK CLAMP</td> <td>2</td> <td>PZ</td> </tr> </tbody> </table>	Code	Description	Qty	UOM	0B1122A0	750MM DOOR LOWER FRAME SHAPE	1	PZ	0B1122A1	750MM DOOR LOWER FRAME SHAPE	1	PZ	RC1200A0	ED=4 WIRE D.=0.5 COMPRESSIO N SPRING	2	PZ	VI1220A1	4,2X12 TCB SELF-TAPPIN G SCREW	1	PZ	VI1996A0	M5X35 SCREW	7	PZ	VM1794A0	250X4.8 PA66 BLACK CLAMP	2	PZ
			Code	Description	Qty	UOM																																																																																						
0B1122A0	750MM DOOR LOWER FRAME SHAPE	1	PZ																																																																																									
0B1122A1	750MM DOOR LOWER FRAME SHAPE	1	PZ																																																																																									
RC1200A0	ED=4 WIRE D.=0.5 COMPRESSIO N SPRING	2	PZ																																																																																									
VI1220A1	4,2X12 TCB SELF-TAPPIN G SCREW	1	PZ																																																																																									
VI1996A0	M5X35 SCREW	7	PZ																																																																																									
VM1794A0	250X4.8 PA66 BLACK CLAMP	2	PZ																																																																																									
VM2103A0	CLAMP LOCK	2	PZ																																																																																									
VM2259A1	6 SERIES DOOR LOWER LEFT CAP	1	PZ																																																																																									
VM2261A1	6 SERIES DOOR LOWER RIGHT CAP	1	PZ																																																																																									
VM2267A0	INTERNAL GLASS LOCKING SYSTEM SLIDER	1	PZ																																																																																									
VM2269A0	INTERNAL GLASS LOCKING SYSTEM CAP	1	PZ																																																																																									
VM2274A0	GROOVED BUSHING	1	PZ																																																																																									
VM2305A0	6 SERIES DOOR CAP FIXING PAWL	7	PZ																																																																																									
Code	Description	Qty	UOM																																																																																									
0B1122A0	750MM DOOR LOWER FRAME SHAPE	1	PZ																																																																																									
0B1122A1	750MM DOOR LOWER FRAME SHAPE	1	PZ																																																																																									
RC1200A0	ED=4 WIRE D.=0.5 COMPRESSIO N SPRING	2	PZ																																																																																									
VI1220A1	4,2X12 TCB SELF-TAPPIN G SCREW	1	PZ																																																																																									
VI1996A0	M5X35 SCREW	7	PZ																																																																																									
VM1794A0	250X4.8 PA66 BLACK CLAMP	2	PZ																																																																																									

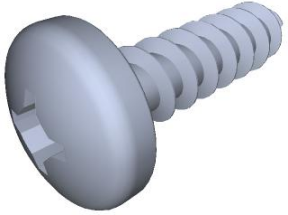

COMPONENT			SPARE PART																																										
Code	Description	Image	Code	Description	Components list																																								
VM2274A	GROOVED BUSHING		K0B1122AL	CHEFTOP MM LEFT DOOR LOWER BEAM KIT	<table border="1"> <thead> <tr> <th>Code</th> <th>Description</th> <th>Qty</th> <th>UOM</th> </tr> </thead> <tbody> <tr> <td>VM2103A0</td> <td>CLAMP LOCK</td> <td>2</td> <td>PZ</td> </tr> <tr> <td>VM2267A0</td> <td>INTERNAL GLASS LOCKING SYSTEM SLIDER</td> <td>1</td> <td>PZ</td> </tr> <tr> <td>VM2269A0</td> <td>INTERNAL GLASS LOCKING SYSTEM CAP</td> <td>1</td> <td>PZ</td> </tr> <tr> <td>VM2274A0</td> <td>GROOVED BUSHING</td> <td>1</td> <td>PZ</td> </tr> <tr> <td>VM2305A0</td> <td>6 SERIES DOOR CAP FIXING PAWL</td> <td>7</td> <td>PZ</td> </tr> <tr> <td>VM2384A0</td> <td>MM LEFT DOOR RIGHT LOWER CAP</td> <td>1</td> <td>PZ</td> </tr> <tr> <td>VM2384A0</td> <td>MM LEFT DOOR RIGHT LOWER CAP</td> <td>1</td> <td>PZ</td> </tr> <tr> <td>VM2386A1</td> <td>LEFT MM DOOR LOWER LEFT CAP</td> <td>1</td> <td>PZ</td> </tr> <tr> <td>VM2386A1</td> <td>LEFT MM DOOR LOWER LEFT CAP</td> <td>1</td> <td>PZ</td> </tr> </tbody> </table>	Code	Description	Qty	UOM	VM2103A0	CLAMP LOCK	2	PZ	VM2267A0	INTERNAL GLASS LOCKING SYSTEM SLIDER	1	PZ	VM2269A0	INTERNAL GLASS LOCKING SYSTEM CAP	1	PZ	VM2274A0	GROOVED BUSHING	1	PZ	VM2305A0	6 SERIES DOOR CAP FIXING PAWL	7	PZ	VM2384A0	MM LEFT DOOR RIGHT LOWER CAP	1	PZ	VM2384A0	MM LEFT DOOR RIGHT LOWER CAP	1	PZ	VM2386A1	LEFT MM DOOR LOWER LEFT CAP	1	PZ	VM2386A1	LEFT MM DOOR LOWER LEFT CAP	1	PZ
Code	Description	Qty	UOM																																										
VM2103A0	CLAMP LOCK	2	PZ																																										
VM2267A0	INTERNAL GLASS LOCKING SYSTEM SLIDER	1	PZ																																										
VM2269A0	INTERNAL GLASS LOCKING SYSTEM CAP	1	PZ																																										
VM2274A0	GROOVED BUSHING	1	PZ																																										
VM2305A0	6 SERIES DOOR CAP FIXING PAWL	7	PZ																																										
VM2384A0	MM LEFT DOOR RIGHT LOWER CAP	1	PZ																																										
VM2384A0	MM LEFT DOOR RIGHT LOWER CAP	1	PZ																																										
VM2386A1	LEFT MM DOOR LOWER LEFT CAP	1	PZ																																										
VM2386A1	LEFT MM DOOR LOWER LEFT CAP	1	PZ																																										
VM2305A	6 SERIES DOOR CAP FIXING PAWL		KVM2305A	MM FIXING DOOR THUB SCREWS 10 PCS KIT	<table border="1"> <thead> <tr> <th>Code</th> <th>Description</th> <th>Qty</th> <th>UOM</th> </tr> </thead> <tbody> <tr> <td>VM1224A0</td> <td>65MY 220MM 2 COLOURS SHRINK TUBE</td> <td>0.200</td> <td>M</td> </tr> <tr> <td>VM2305A0</td> <td>6 SERIES DOOR CAP FIXING PAWL</td> <td>10</td> <td>PZ</td> </tr> </tbody> </table>	Code	Description	Qty	UOM	VM1224A0	65MY 220MM 2 COLOURS SHRINK TUBE	0.200	M	VM2305A0	6 SERIES DOOR CAP FIXING PAWL	10	PZ																												
Code	Description	Qty	UOM																																										
VM1224A0	65MY 220MM 2 COLOURS SHRINK TUBE	0.200	M																																										
VM2305A0	6 SERIES DOOR CAP FIXING PAWL	10	PZ																																										
VI1996A	M5X35 SCREW		VI1996A0	M5X35 SCREW																																									



COMPONENT			SPARE PART																																						
Code	Description	Image	Code	Description	Components list																																				
VI1930A	ST. STEEL 5X20 CHIP SCREW		VI1930A1	ST. STEEL 5X20 CHIP SCREW																																					
VP1080A	UPPER HINGE CAP FOR LOWER INNER GLASS		KVM2383B	MM -M LEFT DOOR RIGHT UPPER CAP KIT	<table border="1"> <thead> <tr> <th>Code</th> <th>Description</th> <th>Qty</th> <th>UOM</th> </tr> </thead> <tbody> <tr> <td>VI1074A0</td> <td>4X16 SCREW FOR PLASTIC</td> <td>1</td> <td>PZ</td> </tr> <tr> <td>VI1930A1</td> <td>ST. STEEL 5X20 CHIP SCREW</td> <td>4</td> <td>PZ</td> </tr> <tr> <td>VI1996A0</td> <td>M5X35 SCREW</td> <td>3</td> <td>PZ</td> </tr> <tr> <td>VM2275A0</td> <td>SMOOTH BUSHING</td> <td>1</td> <td>PZ</td> </tr> <tr> <td>VM2305A0</td> <td>6 SERIES DOOR CAP FIXING PAWL</td> <td>3</td> <td>PZ</td> </tr> <tr> <td>VM2383B0</td> <td>S6 LEFT OVENS UPPER RIGHT CAP</td> <td>1</td> <td>PZ</td> </tr> <tr> <td>VP1080A0</td> <td>UPPER HINGE CAP FOR LOWER INNER GLASS</td> <td>1</td> <td>PZ</td> </tr> </tbody> </table>	Code	Description	Qty	UOM	VI1074A0	4X16 SCREW FOR PLASTIC	1	PZ	VI1930A1	ST. STEEL 5X20 CHIP SCREW	4	PZ	VI1996A0	M5X35 SCREW	3	PZ	VM2275A0	SMOOTH BUSHING	1	PZ	VM2305A0	6 SERIES DOOR CAP FIXING PAWL	3	PZ	VM2383B0	S6 LEFT OVENS UPPER RIGHT CAP	1	PZ	VP1080A0	UPPER HINGE CAP FOR LOWER INNER GLASS	1	PZ				
Code	Description	Qty	UOM																																						
VI1074A0	4X16 SCREW FOR PLASTIC	1	PZ																																						
VI1930A1	ST. STEEL 5X20 CHIP SCREW	4	PZ																																						
VI1996A0	M5X35 SCREW	3	PZ																																						
VM2275A0	SMOOTH BUSHING	1	PZ																																						
VM2305A0	6 SERIES DOOR CAP FIXING PAWL	3	PZ																																						
VM2383B0	S6 LEFT OVENS UPPER RIGHT CAP	1	PZ																																						
VP1080A0	UPPER HINGE CAP FOR LOWER INNER GLASS	1	PZ																																						
			KVM2259B	MM -M RIGHT DOOR LEFT LOWER CAP KI	<table border="1"> <thead> <tr> <th>Code</th> <th>Description</th> <th>Qty</th> <th>UOM</th> </tr> </thead> <tbody> <tr> <td>VI1103A0</td> <td>40X12 TBSP SCREW FOR PLASTIC</td> <td>1</td> <td>PZ</td> </tr> <tr> <td>VI1930A1</td> <td>ST. STEEL 5X20 CHIP SCREW</td> <td>4</td> <td>PZ</td> </tr> <tr> <td>VI1996A0</td> <td>M5X35 SCREW</td> <td>3</td> <td>PZ</td> </tr> <tr> <td>VM1224A0</td> <td>65MY 220MM 2 COLOURS SHRINK TUBE</td> <td>0.300</td> <td>M</td> </tr> <tr> <td>VM2259B0</td> <td></td> <td>1</td> <td>PZ</td> </tr> <tr> <td>VM2274A0</td> <td>GROOVED BUSHING</td> <td>1</td> <td>PZ</td> </tr> <tr> <td>VM2305A0</td> <td>6 SERIES DOOR CAP FIXING PAWL</td> <td>3</td> <td>PZ</td> </tr> <tr> <td>VP1080A0</td> <td>UPPER HINGE CAP FOR LOWER INNER GLASS</td> <td>1</td> <td>PZ</td> </tr> </tbody> </table>	Code	Description	Qty	UOM	VI1103A0	40X12 TBSP SCREW FOR PLASTIC	1	PZ	VI1930A1	ST. STEEL 5X20 CHIP SCREW	4	PZ	VI1996A0	M5X35 SCREW	3	PZ	VM1224A0	65MY 220MM 2 COLOURS SHRINK TUBE	0.300	M	VM2259B0		1	PZ	VM2274A0	GROOVED BUSHING	1	PZ	VM2305A0	6 SERIES DOOR CAP FIXING PAWL	3	PZ	VP1080A0	UPPER HINGE CAP FOR LOWER INNER GLASS	1	PZ
Code	Description	Qty	UOM																																						
VI1103A0	40X12 TBSP SCREW FOR PLASTIC	1	PZ																																						
VI1930A1	ST. STEEL 5X20 CHIP SCREW	4	PZ																																						
VI1996A0	M5X35 SCREW	3	PZ																																						
VM1224A0	65MY 220MM 2 COLOURS SHRINK TUBE	0.300	M																																						
VM2259B0		1	PZ																																						
VM2274A0	GROOVED BUSHING	1	PZ																																						
VM2305A0	6 SERIES DOOR CAP FIXING PAWL	3	PZ																																						
VP1080A0	UPPER HINGE CAP FOR LOWER INNER GLASS	1	PZ																																						





COMPONENT			SPARE PART																																						
Code	Description	Image	Code	Description	Components list																																				
VM2259B			KVM2259B	MM -M RIGHT DOOR LEFT LOWER CAP KI	<table border="1"> <thead> <tr> <th>Code</th> <th>Description</th> <th>Qty</th> <th>UOM</th> </tr> </thead> <tbody> <tr> <td>VI1103A0</td> <td>40X12 TBSP SCREW FOR PLASTIC</td> <td>1</td> <td>PZ</td> </tr> <tr> <td>VI1930A1</td> <td>ST. STEEL 5X20 CHIP SCREW</td> <td>4</td> <td>PZ</td> </tr> <tr> <td>VI1996A0</td> <td>M5X35 SCREW</td> <td>3</td> <td>PZ</td> </tr> <tr> <td>VM1224A0</td> <td>65MY 220MM 2 COLOURS SHRINK TUBE</td> <td>0.300</td> <td>M</td> </tr> <tr> <td>VM2259B0</td> <td></td> <td>1</td> <td>PZ</td> </tr> <tr> <td>VM2274A0</td> <td>GROOVED BUSHING</td> <td>1</td> <td>PZ</td> </tr> <tr> <td>VM2305A0</td> <td>6 SERIES DOOR CAP FIXING PAWL</td> <td>3</td> <td>PZ</td> </tr> <tr> <td>VP1080A0</td> <td>UPPER HINGE CAP FOR LOWER INNER GLASS</td> <td>1</td> <td>PZ</td> </tr> </tbody> </table>	Code	Description	Qty	UOM	VI1103A0	40X12 TBSP SCREW FOR PLASTIC	1	PZ	VI1930A1	ST. STEEL 5X20 CHIP SCREW	4	PZ	VI1996A0	M5X35 SCREW	3	PZ	VM1224A0	65MY 220MM 2 COLOURS SHRINK TUBE	0.300	M	VM2259B0		1	PZ	VM2274A0	GROOVED BUSHING	1	PZ	VM2305A0	6 SERIES DOOR CAP FIXING PAWL	3	PZ	VP1080A0	UPPER HINGE CAP FOR LOWER INNER GLASS	1	PZ
Code	Description	Qty	UOM																																						
VI1103A0	40X12 TBSP SCREW FOR PLASTIC	1	PZ																																						
VI1930A1	ST. STEEL 5X20 CHIP SCREW	4	PZ																																						
VI1996A0	M5X35 SCREW	3	PZ																																						
VM1224A0	65MY 220MM 2 COLOURS SHRINK TUBE	0.300	M																																						
VM2259B0		1	PZ																																						
VM2274A0	GROOVED BUSHING	1	PZ																																						
VM2305A0	6 SERIES DOOR CAP FIXING PAWL	3	PZ																																						
VP1080A0	UPPER HINGE CAP FOR LOWER INNER GLASS	1	PZ																																						
0B1113B			0B1113B0																																						
PE1058A	MM ONE CONTROL BOARD		KPE1058A	MM ONE CONTROL BOARD KIT	<table border="1"> <thead> <tr> <th>Code</th> <th>Description</th> <th>Qty</th> <th>UOM</th> </tr> </thead> <tbody> <tr> <td>CE2007A0</td> <td></td> <td>1</td> <td>PZ</td> </tr> <tr> <td>PE1058A0</td> <td>MM ONE CONTROL BOARD</td> <td>1</td> <td>PZ</td> </tr> <tr> <td>VI1074A0</td> <td>4X16 SCREW FOR PLASTIC</td> <td>2</td> <td>PZ</td> </tr> <tr> <td>VM2147A0</td> <td>410X343X15 MM PINK SMOOTH ESD SPONGE</td> <td>1</td> <td>PZ</td> </tr> <tr> <td>VP1005A0</td> <td>BIG-L DOOR CONTROL BOARD SUPPPORT</td> <td>1</td> <td>PZ</td> </tr> <tr> <td>VP1005B0</td> <td>70 MM BIG-L DOOR CONTROL SUPPORT</td> <td>1</td> <td>PZ</td> </tr> <tr> <td>VP1067A0</td> <td>CONTROL BOARD PARTITION RETROFIT MM</td> <td>1</td> <td>PZ</td> </tr> <tr> <td>VP1078A0</td> <td>MM CONTROL BOARD PARTITION FRAME</td> <td>1</td> <td>PZ</td> </tr> </tbody> </table>	Code	Description	Qty	UOM	CE2007A0		1	PZ	PE1058A0	MM ONE CONTROL BOARD	1	PZ	VI1074A0	4X16 SCREW FOR PLASTIC	2	PZ	VM2147A0	410X343X15 MM PINK SMOOTH ESD SPONGE	1	PZ	VP1005A0	BIG-L DOOR CONTROL BOARD SUPPPORT	1	PZ	VP1005B0	70 MM BIG-L DOOR CONTROL SUPPORT	1	PZ	VP1067A0	CONTROL BOARD PARTITION RETROFIT MM	1	PZ	VP1078A0	MM CONTROL BOARD PARTITION FRAME	1	PZ
Code	Description	Qty	UOM																																						
CE2007A0		1	PZ																																						
PE1058A0	MM ONE CONTROL BOARD	1	PZ																																						
VI1074A0	4X16 SCREW FOR PLASTIC	2	PZ																																						
VM2147A0	410X343X15 MM PINK SMOOTH ESD SPONGE	1	PZ																																						
VP1005A0	BIG-L DOOR CONTROL BOARD SUPPPORT	1	PZ																																						
VP1005B0	70 MM BIG-L DOOR CONTROL SUPPORT	1	PZ																																						
VP1067A0	CONTROL BOARD PARTITION RETROFIT MM	1	PZ																																						
VP1078A0	MM CONTROL BOARD PARTITION FRAME	1	PZ																																						



COMPONENT			SPARE PART																																																																																									
Code	Description	Image	Code	Description	Components list																																																																																							
OB1126B			K0B1126BR	BAKERTOP MM -M RIGHT DOOR LOWER BEAM KIT	<table border="1"> <thead> <tr> <th>Code</th> <th>Description</th> <th>Qty</th> <th>UOM</th> </tr> </thead> <tbody> <tr> <td>OB1126B0</td> <td></td> <td>1</td> <td>PZ</td> </tr> <tr> <td>RC1200A0</td> <td>ED=4 WIRE D.=0.5 COMPRESSIO N SPRING</td> <td>2</td> <td>PZ</td> </tr> <tr> <td>VE1030A1</td> <td>MAGNET FOR DOOR MICROSWITC H D=22,9MM</td> <td>1</td> <td>PZ</td> </tr> <tr> <td>VI1103A0</td> <td>40X12 TBSP SCREW FOR PLASTIC</td> <td>1</td> <td>PZ</td> </tr> <tr> <td>VI1220A1</td> <td>4,2X12 TCB SELF-TAPPIN G SCREW</td> <td>1</td> <td>PZ</td> </tr> <tr> <td>VI1930A1</td> <td>ST. STEEL 5X20 CHIP SCREW</td> <td>8</td> <td>PZ</td> </tr> <tr> <td>VI1996A0</td> <td>M5X35 SCREW</td> <td>6</td> <td>PZ</td> </tr> <tr> <td>VM1794A0</td> <td>250X4.8 PA66 BLACK CLAMP</td> <td>2</td> <td>PZ</td> </tr> <tr> <td>VM2103A0</td> <td>CLAMP LOCK</td> <td>2</td> <td>PZ</td> </tr> <tr> <td>VM2267A0</td> <td>INTERNAL GLASS LOCKING SYSTEM SLIDER</td> <td>1</td> <td>PZ</td> </tr> <tr> <td>VM2268A0</td> <td>DOOR MAGNET COVER</td> <td>1</td> <td>PZ</td> </tr> <tr> <td>VM2269B0</td> <td>INNER GLASS FIXING CAP</td> <td>1</td> <td>PZ</td> </tr> <tr> <td>VM2274A0</td> <td>GROOVED BUSHING</td> <td>1</td> <td>PZ</td> </tr> <tr> <td>VM2305A0</td> <td>6 SERIES DOOR CAP FIXING PAWL</td> <td>7</td> <td>PZ</td> </tr> <tr> <td>VM2384B0</td> <td></td> <td>1</td> <td>PZ</td> </tr> <tr> <td>VM2386B0</td> <td>MM -M LEFT DOOR LEFT LOWER CAP KI</td> <td>1</td> <td>PZ</td> </tr> <tr> <td>VP1081A0</td> <td>UPPER HINGE CAP FOR UPPER INNER GLASS</td> <td>1</td> <td>PZ</td> </tr> </tbody> </table>	Code	Description	Qty	UOM	OB1126B0		1	PZ	RC1200A0	ED=4 WIRE D.=0.5 COMPRESSIO N SPRING	2	PZ	VE1030A1	MAGNET FOR DOOR MICROSWITC H D=22,9MM	1	PZ	VI1103A0	40X12 TBSP SCREW FOR PLASTIC	1	PZ	VI1220A1	4,2X12 TCB SELF-TAPPIN G SCREW	1	PZ	VI1930A1	ST. STEEL 5X20 CHIP SCREW	8	PZ	VI1996A0	M5X35 SCREW	6	PZ	VM1794A0	250X4.8 PA66 BLACK CLAMP	2	PZ	VM2103A0	CLAMP LOCK	2	PZ	VM2267A0	INTERNAL GLASS LOCKING SYSTEM SLIDER	1	PZ	VM2268A0	DOOR MAGNET COVER	1	PZ	VM2269B0	INNER GLASS FIXING CAP	1	PZ	VM2274A0	GROOVED BUSHING	1	PZ	VM2305A0	6 SERIES DOOR CAP FIXING PAWL	7	PZ	VM2384B0		1	PZ	VM2386B0	MM -M LEFT DOOR LEFT LOWER CAP KI	1	PZ	VP1081A0	UPPER HINGE CAP FOR UPPER INNER GLASS	1	PZ	K0B1126BL	EU+2/1 MM -MLEFT DOOR LOWER BEAM KIT	<table border="1"> <thead> <tr> <th>Code</th> <th>Description</th> <th>Qty</th> <th>UOM</th> </tr> </thead> <tbody> <tr> <td>OB1126B0</td> <td></td> <td>1</td> <td>PZ</td> </tr> <tr> <td>RC1200A0</td> <td>ED=4 WIRE D.=0.5 COMPRESSIO N SPRING</td> <td>2</td> <td>PZ</td> </tr> </tbody> </table>	Code	Description	Qty	UOM	OB1126B0		1	PZ	RC1200A0	ED=4 WIRE D.=0.5 COMPRESSIO N SPRING	2	PZ
			Code	Description	Qty	UOM																																																																																						
OB1126B0		1	PZ																																																																																									
RC1200A0	ED=4 WIRE D.=0.5 COMPRESSIO N SPRING	2	PZ																																																																																									
VE1030A1	MAGNET FOR DOOR MICROSWITC H D=22,9MM	1	PZ																																																																																									
VI1103A0	40X12 TBSP SCREW FOR PLASTIC	1	PZ																																																																																									
VI1220A1	4,2X12 TCB SELF-TAPPIN G SCREW	1	PZ																																																																																									
VI1930A1	ST. STEEL 5X20 CHIP SCREW	8	PZ																																																																																									
VI1996A0	M5X35 SCREW	6	PZ																																																																																									
VM1794A0	250X4.8 PA66 BLACK CLAMP	2	PZ																																																																																									
VM2103A0	CLAMP LOCK	2	PZ																																																																																									
VM2267A0	INTERNAL GLASS LOCKING SYSTEM SLIDER	1	PZ																																																																																									
VM2268A0	DOOR MAGNET COVER	1	PZ																																																																																									
VM2269B0	INNER GLASS FIXING CAP	1	PZ																																																																																									
VM2274A0	GROOVED BUSHING	1	PZ																																																																																									
VM2305A0	6 SERIES DOOR CAP FIXING PAWL	7	PZ																																																																																									
VM2384B0		1	PZ																																																																																									
VM2386B0	MM -M LEFT DOOR LEFT LOWER CAP KI	1	PZ																																																																																									
VP1081A0	UPPER HINGE CAP FOR UPPER INNER GLASS	1	PZ																																																																																									
Code	Description	Qty	UOM																																																																																									
OB1126B0		1	PZ																																																																																									
RC1200A0	ED=4 WIRE D.=0.5 COMPRESSIO N SPRING	2	PZ																																																																																									

COMPONENT			SPARE PART																																																																		
Code	Description	Image	Code	Description	Components list																																																																
0B1126B			K0B1126BL	EU+2/1 MM -MLEFT DOOR LOWER BEAM KIT	<table border="1"> <thead> <tr> <th>Code</th> <th>Description</th> <th>Qty</th> <th>UOM</th> </tr> </thead> <tbody> <tr> <td>VE1030A1</td> <td>MAGNET FOR DOOR MICROSWITC H D=22.9MM</td> <td>1</td> <td>PZ</td> </tr> <tr> <td>VI1103A0</td> <td>40X12 TBSP SCREW FOR PLASTIC</td> <td>1</td> <td>PZ</td> </tr> <tr> <td>VI1220A1</td> <td>4,2X12 TCB SELF-TAPPIN G SCREW</td> <td>1</td> <td>PZ</td> </tr> <tr> <td>VI1930A1</td> <td>ST. STEEL 5X20 CHIP SCREW</td> <td>8</td> <td>PZ</td> </tr> <tr> <td>VI1996A0</td> <td>M5X35 SCREW</td> <td>6</td> <td>PZ</td> </tr> <tr> <td>VM1794A0</td> <td>250X4.8 PA66 BLACK CLAMP</td> <td>2</td> <td>PZ</td> </tr> <tr> <td>VM2103A0</td> <td>CLAMP LOCK</td> <td>2</td> <td>PZ</td> </tr> <tr> <td>VM2267A0</td> <td>INTERNAL GLASS LOCKING SYSTEM SLIDER</td> <td>1</td> <td>PZ</td> </tr> <tr> <td>VM2268A0</td> <td>DOOR MAGNET COVER</td> <td>1</td> <td>PZ</td> </tr> <tr> <td>VM2269B0</td> <td>INNER GLASS FIXING CAP</td> <td>1</td> <td>PZ</td> </tr> <tr> <td>VM2274A0</td> <td>GROOVED BUSHING</td> <td>1</td> <td>PZ</td> </tr> <tr> <td>VM2305A0</td> <td>6 SERIES DOOR CAP FIXING PAWL</td> <td>7</td> <td>PZ</td> </tr> <tr> <td>VM2384B0</td> <td></td> <td>1</td> <td>PZ</td> </tr> <tr> <td>VM2386B0</td> <td>MM -M LEFT DOOR LEFT LOWER CAP KI</td> <td>1</td> <td>PZ</td> </tr> <tr> <td>VP1081A0</td> <td>UPPER HINGE CAP FOR UPPER INNER GLASS</td> <td>1</td> <td>PZ</td> </tr> </tbody> </table>	Code	Description	Qty	UOM	VE1030A1	MAGNET FOR DOOR MICROSWITC H D=22.9MM	1	PZ	VI1103A0	40X12 TBSP SCREW FOR PLASTIC	1	PZ	VI1220A1	4,2X12 TCB SELF-TAPPIN G SCREW	1	PZ	VI1930A1	ST. STEEL 5X20 CHIP SCREW	8	PZ	VI1996A0	M5X35 SCREW	6	PZ	VM1794A0	250X4.8 PA66 BLACK CLAMP	2	PZ	VM2103A0	CLAMP LOCK	2	PZ	VM2267A0	INTERNAL GLASS LOCKING SYSTEM SLIDER	1	PZ	VM2268A0	DOOR MAGNET COVER	1	PZ	VM2269B0	INNER GLASS FIXING CAP	1	PZ	VM2274A0	GROOVED BUSHING	1	PZ	VM2305A0	6 SERIES DOOR CAP FIXING PAWL	7	PZ	VM2384B0		1	PZ	VM2386B0	MM -M LEFT DOOR LEFT LOWER CAP KI	1	PZ	VP1081A0	UPPER HINGE CAP FOR UPPER INNER GLASS	1	PZ
Code	Description	Qty	UOM																																																																		
VE1030A1	MAGNET FOR DOOR MICROSWITC H D=22.9MM	1	PZ																																																																		
VI1103A0	40X12 TBSP SCREW FOR PLASTIC	1	PZ																																																																		
VI1220A1	4,2X12 TCB SELF-TAPPIN G SCREW	1	PZ																																																																		
VI1930A1	ST. STEEL 5X20 CHIP SCREW	8	PZ																																																																		
VI1996A0	M5X35 SCREW	6	PZ																																																																		
VM1794A0	250X4.8 PA66 BLACK CLAMP	2	PZ																																																																		
VM2103A0	CLAMP LOCK	2	PZ																																																																		
VM2267A0	INTERNAL GLASS LOCKING SYSTEM SLIDER	1	PZ																																																																		
VM2268A0	DOOR MAGNET COVER	1	PZ																																																																		
VM2269B0	INNER GLASS FIXING CAP	1	PZ																																																																		
VM2274A0	GROOVED BUSHING	1	PZ																																																																		
VM2305A0	6 SERIES DOOR CAP FIXING PAWL	7	PZ																																																																		
VM2384B0		1	PZ																																																																		
VM2386B0	MM -M LEFT DOOR LEFT LOWER CAP KI	1	PZ																																																																		
VP1081A0	UPPER HINGE CAP FOR UPPER INNER GLASS	1	PZ																																																																		
0B1218B			0B1218B0																																																																		

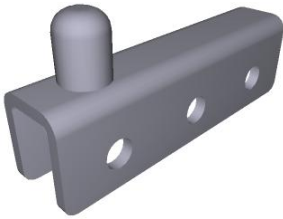

COMPONENT			SPARE PART																						
Code	Description	Image	Code	Description	Components list																				
VM2312A	6 S. DRIP PROFILE DRAIN LEFT PIPE		KVM2312A	M.M. DRIP TRAY LEFT DRAIN PIPE KI	<table border="1"> <thead> <tr> <th>Code</th> <th>Description</th> <th>Qty</th> <th>UOM</th> </tr> </thead> <tbody> <tr> <td>VM1224A0</td> <td>65MY 220MM 2 COLOURS SHRINK TUBE</td> <td>0.150</td> <td>M</td> </tr> <tr> <td>VM2312A0</td> <td>6 S. DRIP PROFILE DRAIN LEFT PIPE</td> <td>1</td> <td>PZ</td> </tr> </tbody> </table>	Code	Description	Qty	UOM	VM1224A0	65MY 220MM 2 COLOURS SHRINK TUBE	0.150	M	VM2312A0	6 S. DRIP PROFILE DRAIN LEFT PIPE	1	PZ								
Code	Description	Qty	UOM																						
VM1224A0	65MY 220MM 2 COLOURS SHRINK TUBE	0.150	M																						
VM2312A0	6 S. DRIP PROFILE DRAIN LEFT PIPE	1	PZ																						
VM2314A	6 S. DRIP PROFILE CAP		KVM2314A	MIND.MAPS DRIP TRAY CAP	<table border="1"> <thead> <tr> <th>Code</th> <th>Description</th> <th>Qty</th> <th>UOM</th> </tr> </thead> <tbody> <tr> <td>VM1224A0</td> <td>65MY 220MM 2 COLOURS SHRINK TUBE</td> <td>0.200</td> <td>M</td> </tr> <tr> <td>VM2314A0</td> <td>6 S. DRIP PROFILE CAP</td> <td>1</td> <td>PZ</td> </tr> </tbody> </table>	Code	Description	Qty	UOM	VM1224A0	65MY 220MM 2 COLOURS SHRINK TUBE	0.200	M	VM2314A0	6 S. DRIP PROFILE CAP	1	PZ								
Code	Description	Qty	UOM																						
VM1224A0	65MY 220MM 2 COLOURS SHRINK TUBE	0.200	M																						
VM2314A0	6 S. DRIP PROFILE CAP	1	PZ																						
VM2285B	860 SERIES DRIP PROFILE KIT		KVM2285B	860 -M SERIES DRIP PROFILE KIT	<table border="1"> <thead> <tr> <th>Code</th> <th>Description</th> <th>Qty</th> <th>UOM</th> </tr> </thead> <tbody> <tr> <td>VM2285B0</td> <td>860 SERIES DRIP PROFILE KIT</td> <td>1</td> <td>PZ</td> </tr> </tbody> </table>	Code	Description	Qty	UOM	VM2285B0	860 SERIES DRIP PROFILE KIT	1	PZ												
Code	Description	Qty	UOM																						
VM2285B0	860 SERIES DRIP PROFILE KIT	1	PZ																						
VT1294B	XEBC-06EU-E INNER GLASS		KVT1294B	06EU INTERNAL SINGLE GLASS KIT	<table border="1"> <thead> <tr> <th>Code</th> <th>Description</th> <th>Qty</th> <th>UOM</th> </tr> </thead> <tbody> <tr> <td>IP1508A1</td> <td>POLYSTYREN E U SHAPED PROFILE 2000X60X60</td> <td>1</td> <td>M</td> </tr> <tr> <td>VM1059A1</td> <td>HEAT SHRINK FILM H800</td> <td>1.500</td> <td>M</td> </tr> <tr> <td>VT1294B0</td> <td>XEBC-06EU-E INNER GLASS</td> <td>1</td> <td>PZ</td> </tr> </tbody> </table>	Code	Description	Qty	UOM	IP1508A1	POLYSTYREN E U SHAPED PROFILE 2000X60X60	1	M	VM1059A1	HEAT SHRINK FILM H800	1.500	M	VT1294B0	XEBC-06EU-E INNER GLASS	1	PZ				
Code	Description	Qty	UOM																						
IP1508A1	POLYSTYREN E U SHAPED PROFILE 2000X60X60	1	M																						
VM1059A1	HEAT SHRINK FILM H800	1.500	M																						
VT1294B0	XEBC-06EU-E INNER GLASS	1	PZ																						
CR1103A	INTERNAL GLASS ST. STEEL UPPER HINGE		XRF033	MM ONE INT GLASS HINGES RETROFIT KIT	<table border="1"> <thead> <tr> <th>Code</th> <th>Description</th> <th>Qty</th> <th>UOM</th> </tr> </thead> <tbody> <tr> <td>0H1928A0</td> <td></td> <td>1</td> <td>PZ</td> </tr> <tr> <td>CR1103A0</td> <td>INTERNAL GLASS ST. STEEL UPPER HINGE</td> <td>1</td> <td>PZ</td> </tr> <tr> <td>CR1104A0</td> <td>INTERNAL GLASS ST. STEEL LOWER HINGE</td> <td>1</td> <td>PZ</td> </tr> <tr> <td>GN1182A1</td> <td>INTERNAL GLASS HINGE CR1103-1104 SEAL</td> <td>2</td> <td>PZ</td> </tr> </tbody> </table>	Code	Description	Qty	UOM	0H1928A0		1	PZ	CR1103A0	INTERNAL GLASS ST. STEEL UPPER HINGE	1	PZ	CR1104A0	INTERNAL GLASS ST. STEEL LOWER HINGE	1	PZ	GN1182A1	INTERNAL GLASS HINGE CR1103-1104 SEAL	2	PZ
Code	Description	Qty	UOM																						
0H1928A0		1	PZ																						
CR1103A0	INTERNAL GLASS ST. STEEL UPPER HINGE	1	PZ																						
CR1104A0	INTERNAL GLASS ST. STEEL LOWER HINGE	1	PZ																						
GN1182A1	INTERNAL GLASS HINGE CR1103-1104 SEAL	2	PZ																						

COMPONENT			SPARE PART																																		
Code	Description	Image	Code	Description	Components list																																
CR1103A	INTERNAL GLASS ST. STEEL UPPER HINGE		XRF033	MM ONE INT GLASS HINGES RETROFIT KIT	<table border="1"> <thead> <tr> <th>Code</th> <th>Description</th> <th>Qty</th> <th>UOM</th> </tr> </thead> <tbody> <tr> <td>VI1810A0</td> <td>M6X6 STAINLESS STEEL FLATHEAD SCREW</td> <td>6</td> <td>PZ</td> </tr> <tr> <td>VM1224A0</td> <td>65MY 220MM 2 COLOURS SHRINK TUBE</td> <td>0.300</td> <td>M</td> </tr> <tr> <td>VM2399A0</td> <td>DOOR HINGES HEADLESS SCREWS COVER</td> <td>2</td> <td>PZ</td> </tr> </tbody> </table>	Code	Description	Qty	UOM	VI1810A0	M6X6 STAINLESS STEEL FLATHEAD SCREW	6	PZ	VM1224A0	65MY 220MM 2 COLOURS SHRINK TUBE	0.300	M	VM2399A0	DOOR HINGES HEADLESS SCREWS COVER	2	PZ																
Code	Description	Qty	UOM																																		
VI1810A0	M6X6 STAINLESS STEEL FLATHEAD SCREW	6	PZ																																		
VM1224A0	65MY 220MM 2 COLOURS SHRINK TUBE	0.300	M																																		
VM2399A0	DOOR HINGES HEADLESS SCREWS COVER	2	PZ																																		
VM2399A	DOOR HINGES HEADLESS SCREWS COVER		VM2399A0	DOOR HINGES HEADLESS SCREWS COVER																																	
GN1182A	INTERNAL GLASS HINGE CR1103-1104 SEAL		XRF033	MM ONE INT GLASS HINGES RETROFIT KIT	<table border="1"> <thead> <tr> <th>Code</th> <th>Description</th> <th>Qty</th> <th>UOM</th> </tr> </thead> <tbody> <tr> <td>0H1928A0</td> <td></td> <td>1</td> <td>PZ</td> </tr> <tr> <td>CR1103A0</td> <td>INTERNAL GLASS ST. STEEL UPPER HINGE</td> <td>1</td> <td>PZ</td> </tr> <tr> <td>CR1104A0</td> <td>INTERNAL GLASS ST. STEEL LOWER HINGE</td> <td>1</td> <td>PZ</td> </tr> <tr> <td>GN1182A1</td> <td>INTERNAL GLASS HINGE CR1103-1104 SEAL</td> <td>2</td> <td>PZ</td> </tr> <tr> <td>VI1810A0</td> <td>M6X6 STAINLESS STEEL FLATHEAD SCREW</td> <td>6</td> <td>PZ</td> </tr> <tr> <td>VM1224A0</td> <td>65MY 220MM 2 COLOURS SHRINK TUBE</td> <td>0.300</td> <td>M</td> </tr> <tr> <td>VM2399A0</td> <td>DOOR HINGES HEADLESS SCREWS COVER</td> <td>2</td> <td>PZ</td> </tr> </tbody> </table>	Code	Description	Qty	UOM	0H1928A0		1	PZ	CR1103A0	INTERNAL GLASS ST. STEEL UPPER HINGE	1	PZ	CR1104A0	INTERNAL GLASS ST. STEEL LOWER HINGE	1	PZ	GN1182A1	INTERNAL GLASS HINGE CR1103-1104 SEAL	2	PZ	VI1810A0	M6X6 STAINLESS STEEL FLATHEAD SCREW	6	PZ	VM1224A0	65MY 220MM 2 COLOURS SHRINK TUBE	0.300	M	VM2399A0	DOOR HINGES HEADLESS SCREWS COVER	2	PZ
Code	Description	Qty	UOM																																		
0H1928A0		1	PZ																																		
CR1103A0	INTERNAL GLASS ST. STEEL UPPER HINGE	1	PZ																																		
CR1104A0	INTERNAL GLASS ST. STEEL LOWER HINGE	1	PZ																																		
GN1182A1	INTERNAL GLASS HINGE CR1103-1104 SEAL	2	PZ																																		
VI1810A0	M6X6 STAINLESS STEEL FLATHEAD SCREW	6	PZ																																		
VM1224A0	65MY 220MM 2 COLOURS SHRINK TUBE	0.300	M																																		
VM2399A0	DOOR HINGES HEADLESS SCREWS COVER	2	PZ																																		

COMPONENT			SPARE PART																																		
Code	Description	Image	Code	Description	Components list																																
CR1104A	INTERNAL GLASS ST. STEEL LOWER HINGE		XRF033	MM ONE INT GLASS HINGES RETROFIT KIT	<table border="1"> <thead> <tr> <th>Code</th> <th>Description</th> <th>Qty</th> <th>UOM</th> </tr> </thead> <tbody> <tr> <td>0H1928A0</td> <td></td> <td>1</td> <td>PZ</td> </tr> <tr> <td>CR1103A0</td> <td>INTERNAL GLASS ST. STEEL UPPER HINGE</td> <td>1</td> <td>PZ</td> </tr> <tr> <td>CR1104A0</td> <td>INTERNAL GLASS ST. STEEL LOWER HINGE</td> <td>1</td> <td>PZ</td> </tr> <tr> <td>GN1182A1</td> <td>INTERNAL GLASS HINGE CR1103-1104 SEAL</td> <td>2</td> <td>PZ</td> </tr> <tr> <td>VI1810A0</td> <td>M6X6 STAINLESS STEEL FLATHEAD SCREW</td> <td>6</td> <td>PZ</td> </tr> <tr> <td>VM1224A0</td> <td>65MY 220MM 2 COLOURS SHRINK TUBE</td> <td>0.300</td> <td>M</td> </tr> <tr> <td>VM2399A0</td> <td>DOOR HINGES HEADLESS SCREWS COVER</td> <td>2</td> <td>PZ</td> </tr> </tbody> </table>	Code	Description	Qty	UOM	0H1928A0		1	PZ	CR1103A0	INTERNAL GLASS ST. STEEL UPPER HINGE	1	PZ	CR1104A0	INTERNAL GLASS ST. STEEL LOWER HINGE	1	PZ	GN1182A1	INTERNAL GLASS HINGE CR1103-1104 SEAL	2	PZ	VI1810A0	M6X6 STAINLESS STEEL FLATHEAD SCREW	6	PZ	VM1224A0	65MY 220MM 2 COLOURS SHRINK TUBE	0.300	M	VM2399A0	DOOR HINGES HEADLESS SCREWS COVER	2	PZ
Code	Description	Qty	UOM																																		
0H1928A0		1	PZ																																		
CR1103A0	INTERNAL GLASS ST. STEEL UPPER HINGE	1	PZ																																		
CR1104A0	INTERNAL GLASS ST. STEEL LOWER HINGE	1	PZ																																		
GN1182A1	INTERNAL GLASS HINGE CR1103-1104 SEAL	2	PZ																																		
VI1810A0	M6X6 STAINLESS STEEL FLATHEAD SCREW	6	PZ																																		
VM1224A0	65MY 220MM 2 COLOURS SHRINK TUBE	0.300	M																																		
VM2399A0	DOOR HINGES HEADLESS SCREWS COVER	2	PZ																																		
VM2399A	DOOR HINGES HEADLESS SCREWS COVER		VM2399A0	DOOR HINGES HEADLESS SCREWS COVER																																	
GN1182A	INTERNAL GLASS HINGE CR1103-1104 SEAL		XRF033	MM ONE INT GLASS HINGES RETROFIT KIT	<table border="1"> <thead> <tr> <th>Code</th> <th>Description</th> <th>Qty</th> <th>UOM</th> </tr> </thead> <tbody> <tr> <td>0H1928A0</td> <td></td> <td>1</td> <td>PZ</td> </tr> <tr> <td>CR1103A0</td> <td>INTERNAL GLASS ST. STEEL UPPER HINGE</td> <td>1</td> <td>PZ</td> </tr> <tr> <td>CR1104A0</td> <td>INTERNAL GLASS ST. STEEL LOWER HINGE</td> <td>1</td> <td>PZ</td> </tr> <tr> <td>GN1182A1</td> <td>INTERNAL GLASS HINGE CR1103-1104 SEAL</td> <td>2</td> <td>PZ</td> </tr> <tr> <td>VI1810A0</td> <td>M6X6 STAINLESS STEEL FLATHEAD SCREW</td> <td>6</td> <td>PZ</td> </tr> </tbody> </table>	Code	Description	Qty	UOM	0H1928A0		1	PZ	CR1103A0	INTERNAL GLASS ST. STEEL UPPER HINGE	1	PZ	CR1104A0	INTERNAL GLASS ST. STEEL LOWER HINGE	1	PZ	GN1182A1	INTERNAL GLASS HINGE CR1103-1104 SEAL	2	PZ	VI1810A0	M6X6 STAINLESS STEEL FLATHEAD SCREW	6	PZ								
Code	Description	Qty	UOM																																		
0H1928A0		1	PZ																																		
CR1103A0	INTERNAL GLASS ST. STEEL UPPER HINGE	1	PZ																																		
CR1104A0	INTERNAL GLASS ST. STEEL LOWER HINGE	1	PZ																																		
GN1182A1	INTERNAL GLASS HINGE CR1103-1104 SEAL	2	PZ																																		
VI1810A0	M6X6 STAINLESS STEEL FLATHEAD SCREW	6	PZ																																		

COMPONENT			SPARE PART																										
Code	Description	Image	Code	Description	Components list																								
GN1182A	INTERNAL GLASS HINGE CR1103-1104 SEAL		XRF033	MM ONE INT GLASS HINGES RETROFIT KIT	<table border="1"> <thead> <tr> <th>Code</th> <th>Description</th> <th>Qty</th> <th>UOM</th> </tr> </thead> <tbody> <tr> <td>VM1224A0</td> <td>65MY 220MM 2 COLOURS SHRINK TUBE</td> <td>0.300</td> <td>M</td> </tr> <tr> <td>VM2399A0</td> <td>DOOR HINGES HEADLESS SCREWS COVER</td> <td>2</td> <td>PZ</td> </tr> </tbody> </table>	Code	Description	Qty	UOM	VM1224A0	65MY 220MM 2 COLOURS SHRINK TUBE	0.300	M	VM2399A0	DOOR HINGES HEADLESS SCREWS COVER	2	PZ												
Code	Description	Qty	UOM																										
VM1224A0	65MY 220MM 2 COLOURS SHRINK TUBE	0.300	M																										
VM2399A0	DOOR HINGES HEADLESS SCREWS COVER	2	PZ																										
VM1630A	INTERNAL GLASS PUSHING CAP		KVM1630A	CAP FOR INTERNAL GLASS 10 PCS KIT	<table border="1"> <thead> <tr> <th>Code</th> <th>Description</th> <th>Qty</th> <th>UOM</th> </tr> </thead> <tbody> <tr> <td>VM1224A0</td> <td>65MY 220MM 2 COLOURS SHRINK TUBE</td> <td>0.200</td> <td>M</td> </tr> <tr> <td>VM1630A0</td> <td>INTERNAL GLASS PUSHING CAP</td> <td>10</td> <td>PZ</td> </tr> <tr> <td>VM1630A1</td> <td>INTERNAL GLASS PUSHING CAP</td> <td>10</td> <td>PZ</td> </tr> </tbody> </table>	Code	Description	Qty	UOM	VM1224A0	65MY 220MM 2 COLOURS SHRINK TUBE	0.200	M	VM1630A0	INTERNAL GLASS PUSHING CAP	10	PZ	VM1630A1	INTERNAL GLASS PUSHING CAP	10	PZ								
Code	Description	Qty	UOM																										
VM1224A0	65MY 220MM 2 COLOURS SHRINK TUBE	0.200	M																										
VM1630A0	INTERNAL GLASS PUSHING CAP	10	PZ																										
VM1630A1	INTERNAL GLASS PUSHING CAP	10	PZ																										
VM2315B	S6 INTERNAL GLASS SUPPORT		KVM2315B	3 PCS MM -M INTERNAL GLASS SUPPORT KIT	<table border="1"> <thead> <tr> <th>Code</th> <th>Description</th> <th>Qty</th> <th>UOM</th> </tr> </thead> <tbody> <tr> <td>VI1220A1</td> <td>4,2X12 TCB SELF-TAPPIN G SCREW</td> <td>3</td> <td>PZ</td> </tr> <tr> <td>VM1224A0</td> <td>65MY 220MM 2 COLOURS SHRINK TUBE</td> <td>0.200</td> <td>M</td> </tr> <tr> <td>VM1630A1</td> <td>INTERNAL GLASS PUSHING CAP</td> <td>3</td> <td>PZ</td> </tr> <tr> <td>VM2315B0</td> <td>S6 INTERNAL GLASS SUPPORT</td> <td>3</td> <td>PZ</td> </tr> </tbody> </table>	Code	Description	Qty	UOM	VI1220A1	4,2X12 TCB SELF-TAPPIN G SCREW	3	PZ	VM1224A0	65MY 220MM 2 COLOURS SHRINK TUBE	0.200	M	VM1630A1	INTERNAL GLASS PUSHING CAP	3	PZ	VM2315B0	S6 INTERNAL GLASS SUPPORT	3	PZ				
Code	Description	Qty	UOM																										
VI1220A1	4,2X12 TCB SELF-TAPPIN G SCREW	3	PZ																										
VM1224A0	65MY 220MM 2 COLOURS SHRINK TUBE	0.200	M																										
VM1630A1	INTERNAL GLASS PUSHING CAP	3	PZ																										
VM2315B0	S6 INTERNAL GLASS SUPPORT	3	PZ																										
MG1099A	MIND.MAPS -M COMPLETE HANDLE		KMG1099A	MIND.MAPS SERIES HANDLE KIT -M	<table border="1"> <thead> <tr> <th>Code</th> <th>Description</th> <th>Qty</th> <th>UOM</th> </tr> </thead> <tbody> <tr> <td>0H7321A0</td> <td>MM STAINLESS STEEL HANDLE COVE</td> <td>1</td> <td>PZ</td> </tr> <tr> <td>MG1099A1</td> <td></td> <td>1</td> <td>PZ</td> </tr> <tr> <td>RC1200A0</td> <td>ED=4 WIRE D.=0.5 COMPRESSIO N SPRING</td> <td>4</td> <td>PZ</td> </tr> <tr> <td>VI0239A1</td> <td>SELF-TAPPIN G SCREW 4.2X25 TCB+ INOX</td> <td>8</td> <td>PZ</td> </tr> <tr> <td>VI1220A1</td> <td>4,2X12 TCB SELF-TAPPIN G SCREW</td> <td>2</td> <td>PZ</td> </tr> </tbody> </table>	Code	Description	Qty	UOM	0H7321A0	MM STAINLESS STEEL HANDLE COVE	1	PZ	MG1099A1		1	PZ	RC1200A0	ED=4 WIRE D.=0.5 COMPRESSIO N SPRING	4	PZ	VI0239A1	SELF-TAPPIN G SCREW 4.2X25 TCB+ INOX	8	PZ	VI1220A1	4,2X12 TCB SELF-TAPPIN G SCREW	2	PZ
Code	Description	Qty	UOM																										
0H7321A0	MM STAINLESS STEEL HANDLE COVE	1	PZ																										
MG1099A1		1	PZ																										
RC1200A0	ED=4 WIRE D.=0.5 COMPRESSIO N SPRING	4	PZ																										
VI0239A1	SELF-TAPPIN G SCREW 4.2X25 TCB+ INOX	8	PZ																										
VI1220A1	4,2X12 TCB SELF-TAPPIN G SCREW	2	PZ																										



COMPONENT			SPARE PART																																						
Code	Description	Image	Code	Description	Components list																																				
MG1099A	MIND.MAPS -M COMPLETE HANDLE		KMG1099A	MIND.MAPS SERIES HANDLE KIT -M	<table border="1"> <thead> <tr> <th>Code</th> <th>Description</th> <th>Qty</th> <th>UOM</th> </tr> </thead> <tbody> <tr> <td>VM1182B1</td> <td>E.S. CT BT HANDLE JUNCTION + PIN GUIDE</td> <td>1</td> <td>PZ</td> </tr> <tr> <td>VM1490A0</td> <td>CHEFTOP/BAK ERTOP HANDLE SCREWS COVER</td> <td>4</td> <td>PZ</td> </tr> <tr> <td>VM1695A0</td> <td>HANDLE POSITION PIN</td> <td>4</td> <td>PZ</td> </tr> <tr> <td>VM2245A0</td> <td>HANDLE SHAFT WITH LATCH</td> <td>1</td> <td>PZ</td> </tr> <tr> <td>VM2247B0</td> <td>HANDLE SHAFT COVER VM2245-2246</td> <td>1</td> <td>PZ</td> </tr> <tr> <td>VM2248B0</td> <td>HANDLE WITH LATCH CLOSING KEY</td> <td>1</td> <td>PZ</td> </tr> <tr> <td>VM2295A1</td> <td>MIND.MAPS TOUCH CONTROL STYLUS KIT</td> <td>1</td> <td>PZ</td> </tr> <tr> <td>VP1076A0</td> <td>PLUS ONE ZERO HANDLE PIN</td> <td>1</td> <td>PZ</td> </tr> </tbody> </table>	Code	Description	Qty	UOM	VM1182B1	E.S. CT BT HANDLE JUNCTION + PIN GUIDE	1	PZ	VM1490A0	CHEFTOP/BAK ERTOP HANDLE SCREWS COVER	4	PZ	VM1695A0	HANDLE POSITION PIN	4	PZ	VM2245A0	HANDLE SHAFT WITH LATCH	1	PZ	VM2247B0	HANDLE SHAFT COVER VM2245-2246	1	PZ	VM2248B0	HANDLE WITH LATCH CLOSING KEY	1	PZ	VM2295A1	MIND.MAPS TOUCH CONTROL STYLUS KIT	1	PZ	VP1076A0	PLUS ONE ZERO HANDLE PIN	1	PZ
Code	Description	Qty	UOM																																						
VM1182B1	E.S. CT BT HANDLE JUNCTION + PIN GUIDE	1	PZ																																						
VM1490A0	CHEFTOP/BAK ERTOP HANDLE SCREWS COVER	4	PZ																																						
VM1695A0	HANDLE POSITION PIN	4	PZ																																						
VM2245A0	HANDLE SHAFT WITH LATCH	1	PZ																																						
VM2247B0	HANDLE SHAFT COVER VM2245-2246	1	PZ																																						
VM2248B0	HANDLE WITH LATCH CLOSING KEY	1	PZ																																						
VM2295A1	MIND.MAPS TOUCH CONTROL STYLUS KIT	1	PZ																																						
VP1076A0	PLUS ONE ZERO HANDLE PIN	1	PZ																																						
0B1112A	0711 RIGHT - DOOR LEFT INT COLUMN		0B1112A2	0711 RIGHT - DOOR LEFT INT COLUMN																																					
0B1114A	0711 RIGHT - DOOR RIGHT INT COLUMN		OUTOFPRODUCTIO	ITEM OUT OF PRODUCTION																																					