

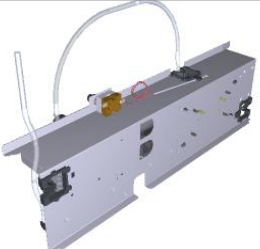



| Assembly code | Assembly revision | Assembly image |
|----------------|-------------------|---|
| ASM3419A/0.D00 | Door |  |
| ASM3438A/0.D01 | Electrical system |  |
| ASM3401A/0.D01 | Cooking chamber |  |
| ASM3407A/0.D01 | External cover |  |

ASM3419A/0.D00 - Door



FRONT



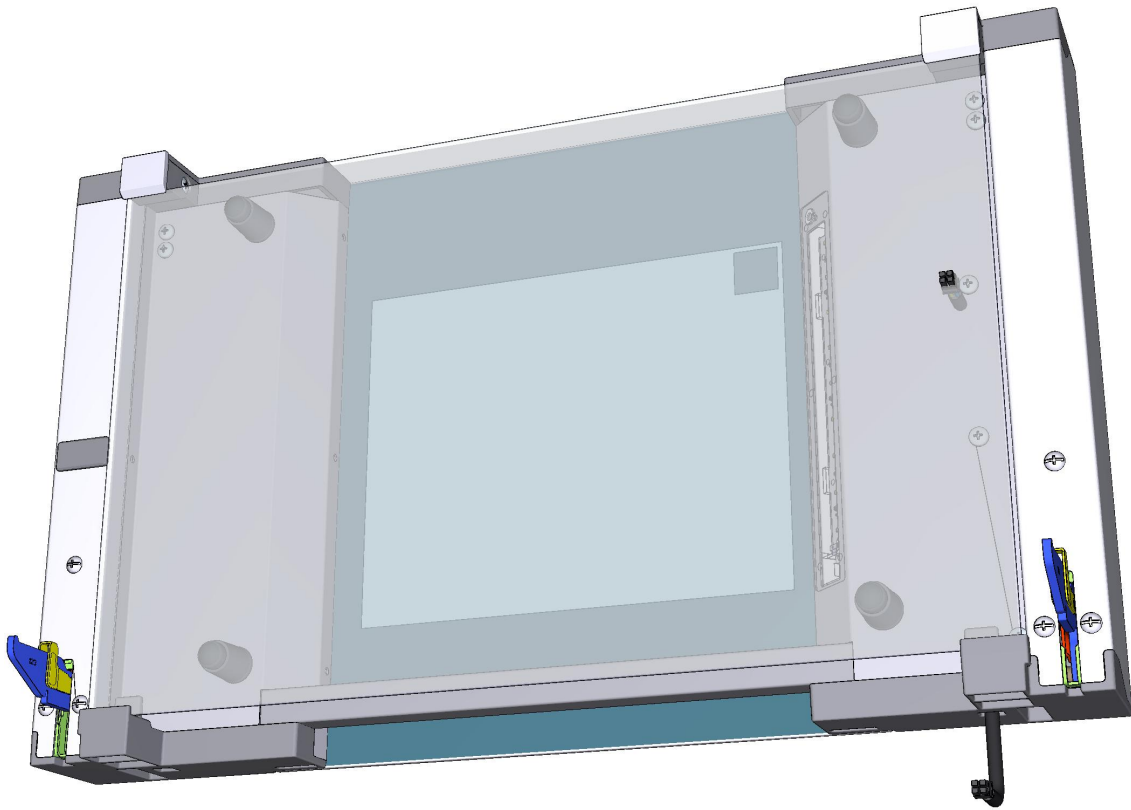

ASM3419A/0.D00 - Door

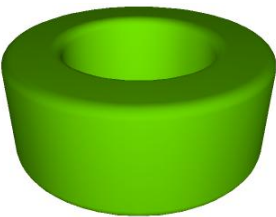

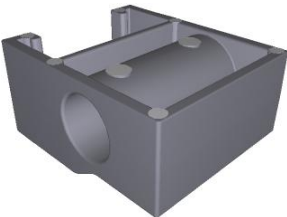
REAR

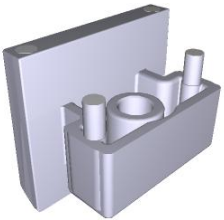
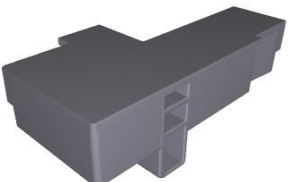
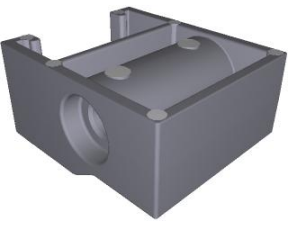

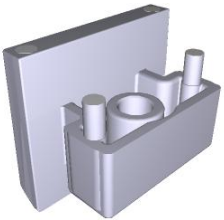

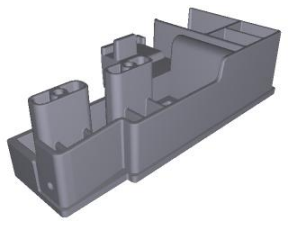
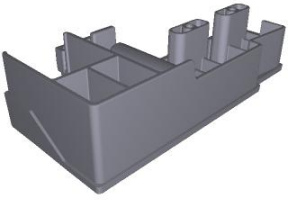

| COMPONENT | | | SPARE PART | | | | | | | | | | | | | | | | | | | | | | | | | | | | | | | | | | |
|-----------|--|---|------------|--|---|------|-------------|-----|-----|----------|--|-------|----|----------|--|---|----|----------|---|-------|----|----------|--|---|----|----------|--|-------|----|----------|--|---|----|----------|--|---|----|
| Code | Description | Image | Code | Description | Components list | | | | | | | | | | | | | | | | | | | | | | | | | | | | | | | | |
| CE1285A | EMI ROUND FERRITE MOD.2643801502 |  | CE1285A0 | EMI ROUND FERRITE MOD.2643801502 | | | | | | | | | | | | | | | | | | | | | | | | | | | | | | | | | |
| LP1050A | BL SHOP.PRO L180 COMPLETE LED BA |  | KLP1050A | BAKERLUX SHOP.PRO L180 LED BAR KIT | <table border="1"> <thead> <tr> <th>Code</th> <th>Description</th> <th>Qty</th> <th>UOM</th> </tr> </thead> <tbody> <tr> <td>IP1385A1</td> <td>CORNER POLYSTYREN E PACKING 110X80X2000</td> <td>0.300</td> <td>M</td> </tr> <tr> <td>LP1050A0</td> <td>BL SHOP.PRO L180 COMPLETE LED BAR</td> <td>1</td> <td>PZ</td> </tr> <tr> <td>VI1014A0</td> <td>STAINLESS STEEL WASHER 4.5X9X0.8</td> <td>1</td> <td>PZ</td> </tr> <tr> <td>VI1220A1</td> <td>4,2X12 TCB SELF-TAPPIN G SCREW</td> <td>1</td> <td>PZ</td> </tr> <tr> <td>VM1059A1</td> <td>HEAT SHRINK FILM H800</td> <td>0.300</td> <td>M</td> </tr> </tbody> </table> | Code | Description | Qty | UOM | IP1385A1 | CORNER POLYSTYREN E PACKING 110X80X2000 | 0.300 | M | LP1050A0 | BL SHOP.PRO L180 COMPLETE LED BAR | 1 | PZ | VI1014A0 | STAINLESS STEEL WASHER 4.5X9X0.8 | 1 | PZ | VI1220A1 | 4,2X12 TCB SELF-TAPPIN G SCREW | 1 | PZ | VM1059A1 | HEAT SHRINK FILM H800 | 0.300 | M | | | | | | | | |
| Code | Description | Qty | UOM | | | | | | | | | | | | | | | | | | | | | | | | | | | | | | | | | | |
| IP1385A1 | CORNER POLYSTYREN E PACKING 110X80X2000 | 0.300 | M | | | | | | | | | | | | | | | | | | | | | | | | | | | | | | | | | | |
| LP1050A0 | BL SHOP.PRO L180 COMPLETE LED BAR | 1 | PZ | | | | | | | | | | | | | | | | | | | | | | | | | | | | | | | | | | |
| VI1014A0 | STAINLESS STEEL WASHER 4.5X9X0.8 | 1 | PZ | | | | | | | | | | | | | | | | | | | | | | | | | | | | | | | | | | |
| VI1220A1 | 4,2X12 TCB SELF-TAPPIN G SCREW | 1 | PZ | | | | | | | | | | | | | | | | | | | | | | | | | | | | | | | | | | |
| VM1059A1 | HEAT SHRINK FILM H800 | 0.300 | M | | | | | | | | | | | | | | | | | | | | | | | | | | | | | | | | | | |
| VM2471A | BL SP LOWER CLAMP INT LOCK GLASS SLIDER |  | KVM2471A | BL SP INTERNAL GLASS LOCK HOLDER KIT | <table border="1"> <thead> <tr> <th>Code</th> <th>Description</th> <th>Qty</th> <th>UOM</th> </tr> </thead> <tbody> <tr> <td>VI1930A0</td> <td>5X25 ST. STEEL SCREW CHIP</td> <td>2</td> <td>PZ</td> </tr> <tr> <td>VI1998A0</td> <td>ZINC PLATED SCREW 5X30 TCB</td> <td>2</td> <td>PZ</td> </tr> <tr> <td>VM1224A0</td> <td>65MY 220MM 2 COLOURS SHRINK TUBE</td> <td>0.150</td> <td>M</td> </tr> <tr> <td>VM2471A0</td> <td>BL SP LOWER CLAMP INT LOCK GLASS SLIDER</td> <td>1</td> <td>PZ</td> </tr> <tr> <td>VM2471A0</td> <td>BL SP LOWER CLAMP INT LOCK GLASS SLIDER</td> <td>1</td> <td>PZ</td> </tr> <tr> <td>VM2472A0</td> <td>BL SP UPPER CLAMP INT LOCK GLASS SLIDER</td> <td>1</td> <td>PZ</td> </tr> <tr> <td>VM2472A0</td> <td>BL SP UPPER CLAMP INT LOCK GLASS SLIDER</td> <td>1</td> <td>PZ</td> </tr> </tbody> </table> | Code | Description | Qty | UOM | VI1930A0 | 5X25 ST. STEEL SCREW CHIP | 2 | PZ | VI1998A0 | ZINC PLATED SCREW 5X30 TCB | 2 | PZ | VM1224A0 | 65MY 220MM 2 COLOURS SHRINK TUBE | 0.150 | M | VM2471A0 | BL SP LOWER CLAMP INT LOCK GLASS SLIDER | 1 | PZ | VM2471A0 | BL SP LOWER CLAMP INT LOCK GLASS SLIDER | 1 | PZ | VM2472A0 | BL SP UPPER CLAMP INT LOCK GLASS SLIDER | 1 | PZ | VM2472A0 | BL SP UPPER CLAMP INT LOCK GLASS SLIDER | 1 | PZ |
| Code | Description | Qty | UOM | | | | | | | | | | | | | | | | | | | | | | | | | | | | | | | | | | |
| VI1930A0 | 5X25 ST. STEEL SCREW CHIP | 2 | PZ | | | | | | | | | | | | | | | | | | | | | | | | | | | | | | | | | | |
| VI1998A0 | ZINC PLATED SCREW 5X30 TCB | 2 | PZ | | | | | | | | | | | | | | | | | | | | | | | | | | | | | | | | | | |
| VM1224A0 | 65MY 220MM 2 COLOURS SHRINK TUBE | 0.150 | M | | | | | | | | | | | | | | | | | | | | | | | | | | | | | | | | | | |
| VM2471A0 | BL SP LOWER CLAMP INT LOCK GLASS SLIDER | 1 | PZ | | | | | | | | | | | | | | | | | | | | | | | | | | | | | | | | | | |
| VM2471A0 | BL SP LOWER CLAMP INT LOCK GLASS SLIDER | 1 | PZ | | | | | | | | | | | | | | | | | | | | | | | | | | | | | | | | | | |
| VM2472A0 | BL SP UPPER CLAMP INT LOCK GLASS SLIDER | 1 | PZ | | | | | | | | | | | | | | | | | | | | | | | | | | | | | | | | | | |
| VM2472A0 | BL SP UPPER CLAMP INT LOCK GLASS SLIDER | 1 | PZ | | | | | | | | | | | | | | | | | | | | | | | | | | | | | | | | | | |

| COMPONENT | | | SPARE PART | | | | | | | | | | | | | | | | | | | | | | | | | | | | | | | | | | |
|-----------|---|---|------------|--|---|------|-------------|-----|-----|----------|--|-------|----|----------|---|---|----|----------|---|-------|----|----------|--|---|----|----------|--|---|----|----------|--|---|----|----------|--|---|----|
| Code | Description | Image | Code | Description | Components list | | | | | | | | | | | | | | | | | | | | | | | | | | | | | | | | |
| VM2503A | SLIDE TO FIX INTERNAL NON REMOV GLASS SP |  | KVM2503A | BL SP INT FIXED GLASS LOCK 2 PCS KIT | <table border="1"> <thead> <tr> <th>Code</th> <th>Description</th> <th>Qty</th> <th>UOM</th> </tr> </thead> <tbody> <tr> <td>VM1224A0</td> <td>65MY 220MM 2 COLOURS SHRINK TUBE</td> <td>0.150</td> <td>M</td> </tr> <tr> <td>VM2503A0</td> <td>SLIDE TO FIX INTERNAL NON REMOV GLASS SP</td> <td>2</td> <td>PZ</td> </tr> <tr> <td>VM2503A0</td> <td>SLIDE TO FIX INTERNAL NON REMOV GLASS SP</td> <td>2</td> <td>PZ</td> </tr> </tbody> </table> | Code | Description | Qty | UOM | VM1224A0 | 65MY 220MM 2 COLOURS SHRINK TUBE | 0.150 | M | VM2503A0 | SLIDE TO FIX INTERNAL NON REMOV GLASS SP | 2 | PZ | VM2503A0 | SLIDE TO FIX INTERNAL NON REMOV GLASS SP | 2 | PZ | | | | | | | | | | | | | | | | |
| Code | Description | Qty | UOM | | | | | | | | | | | | | | | | | | | | | | | | | | | | | | | | | | |
| VM1224A0 | 65MY 220MM 2 COLOURS SHRINK TUBE | 0.150 | M | | | | | | | | | | | | | | | | | | | | | | | | | | | | | | | | | | |
| VM2503A0 | SLIDE TO FIX INTERNAL NON REMOV GLASS SP | 2 | PZ | | | | | | | | | | | | | | | | | | | | | | | | | | | | | | | | | | |
| VM2503A0 | SLIDE TO FIX INTERNAL NON REMOV GLASS SP | 2 | PZ | | | | | | | | | | | | | | | | | | | | | | | | | | | | | | | | | | |
| VM2464A | SHOP.PRO LEFT UPPER CAP DROP DOWN DOOR |  | KVM2464A | BL SP LEFT UPPER DROPDOWN DOOR CAP KIT | <table border="1"> <thead> <tr> <th>Code</th> <th>Description</th> <th>Qty</th> <th>UOM</th> </tr> </thead> <tbody> <tr> <td>VM1224A0</td> <td>65MY 220MM 2 COLOURS SHRINK TUBE</td> <td>0.300</td> <td>M</td> </tr> <tr> <td>VM2464A0</td> <td>SHOP.PRO LEFT UPPER CAP DROP DOWN DOOR</td> <td>1</td> <td>PZ</td> </tr> <tr> <td>VM2464A0</td> <td>SHOP.PRO LEFT UPPER CAP DROP DOWN DOOR</td> <td>1</td> <td>PZ</td> </tr> </tbody> </table> | Code | Description | Qty | UOM | VM1224A0 | 65MY 220MM 2 COLOURS SHRINK TUBE | 0.300 | M | VM2464A0 | SHOP.PRO LEFT UPPER CAP DROP DOWN DOOR | 1 | PZ | VM2464A0 | SHOP.PRO LEFT UPPER CAP DROP DOWN DOOR | 1 | PZ | | | | | | | | | | | | | | | | |
| Code | Description | Qty | UOM | | | | | | | | | | | | | | | | | | | | | | | | | | | | | | | | | | |
| VM1224A0 | 65MY 220MM 2 COLOURS SHRINK TUBE | 0.300 | M | | | | | | | | | | | | | | | | | | | | | | | | | | | | | | | | | | |
| VM2464A0 | SHOP.PRO LEFT UPPER CAP DROP DOWN DOOR | 1 | PZ | | | | | | | | | | | | | | | | | | | | | | | | | | | | | | | | | | |
| VM2464A0 | SHOP.PRO LEFT UPPER CAP DROP DOWN DOOR | 1 | PZ | | | | | | | | | | | | | | | | | | | | | | | | | | | | | | | | | | |
| VM2472A | BL SP UPPER CLAMP INT LOCK GLASS SLIDER |  | KVM2471A | BL SP INTERNAL GLASS LOCK HOLDER KIT | <table border="1"> <thead> <tr> <th>Code</th> <th>Description</th> <th>Qty</th> <th>UOM</th> </tr> </thead> <tbody> <tr> <td>VH1930A0</td> <td>5X25 ST. STEEL SCREW CHIP</td> <td>2</td> <td>PZ</td> </tr> <tr> <td>VH1998A0</td> <td>ZINC PLATED SCREW 5X30 TCB</td> <td>2</td> <td>PZ</td> </tr> <tr> <td>VM1224A0</td> <td>65MY 220MM 2 COLOURS SHRINK TUBE</td> <td>0.150</td> <td>M</td> </tr> <tr> <td>VM2471A0</td> <td>BL SP LOWER CLAMP INT LOCK GLASS SLIDER</td> <td>1</td> <td>PZ</td> </tr> <tr> <td>VM2471A0</td> <td>BL SP LOWER CLAMP INT LOCK GLASS SLIDER</td> <td>1</td> <td>PZ</td> </tr> <tr> <td>VM2472A0</td> <td>BL SP UPPER CLAMP INT LOCK GLASS SLIDER</td> <td>1</td> <td>PZ</td> </tr> <tr> <td>VM2472A0</td> <td>BL SP UPPER CLAMP INT LOCK GLASS SLIDER</td> <td>1</td> <td>PZ</td> </tr> </tbody> </table> | Code | Description | Qty | UOM | VH1930A0 | 5X25 ST. STEEL SCREW CHIP | 2 | PZ | VH1998A0 | ZINC PLATED SCREW 5X30 TCB | 2 | PZ | VM1224A0 | 65MY 220MM 2 COLOURS SHRINK TUBE | 0.150 | M | VM2471A0 | BL SP LOWER CLAMP INT LOCK GLASS SLIDER | 1 | PZ | VM2471A0 | BL SP LOWER CLAMP INT LOCK GLASS SLIDER | 1 | PZ | VM2472A0 | BL SP UPPER CLAMP INT LOCK GLASS SLIDER | 1 | PZ | VM2472A0 | BL SP UPPER CLAMP INT LOCK GLASS SLIDER | 1 | PZ |
| Code | Description | Qty | UOM | | | | | | | | | | | | | | | | | | | | | | | | | | | | | | | | | | |
| VH1930A0 | 5X25 ST. STEEL SCREW CHIP | 2 | PZ | | | | | | | | | | | | | | | | | | | | | | | | | | | | | | | | | | |
| VH1998A0 | ZINC PLATED SCREW 5X30 TCB | 2 | PZ | | | | | | | | | | | | | | | | | | | | | | | | | | | | | | | | | | |
| VM1224A0 | 65MY 220MM 2 COLOURS SHRINK TUBE | 0.150 | M | | | | | | | | | | | | | | | | | | | | | | | | | | | | | | | | | | |
| VM2471A0 | BL SP LOWER CLAMP INT LOCK GLASS SLIDER | 1 | PZ | | | | | | | | | | | | | | | | | | | | | | | | | | | | | | | | | | |
| VM2471A0 | BL SP LOWER CLAMP INT LOCK GLASS SLIDER | 1 | PZ | | | | | | | | | | | | | | | | | | | | | | | | | | | | | | | | | | |
| VM2472A0 | BL SP UPPER CLAMP INT LOCK GLASS SLIDER | 1 | PZ | | | | | | | | | | | | | | | | | | | | | | | | | | | | | | | | | | |
| VM2472A0 | BL SP UPPER CLAMP INT LOCK GLASS SLIDER | 1 | PZ | | | | | | | | | | | | | | | | | | | | | | | | | | | | | | | | | | |

| COMPONENT | | | SPARE PART | | | | | | | | | | | | | | | | | | |
|-----------|---|---|------------|---|--|------|-------------|-----|-----|----------|--|-------|---|----------|---|---|----|----------|---|---|----|
| Code | Description | Image | Code | Description | Components list | | | | | | | | | | | | | | | | |
| VM2503A | SLIDE TO FIX INTERNAL NON REMOV GLASS SP |  | KVM2503A | BL SP INT FIXED GLASS LOCK 2 PCS KIT | <table border="1"> <thead> <tr> <th>Code</th> <th>Description</th> <th>Qty</th> <th>UOM</th> </tr> </thead> <tbody> <tr> <td>VM1224A0</td> <td>65MY 220MM 2 COLOURS SHRINK TUBE</td> <td>0.150</td> <td>M</td> </tr> <tr> <td>VM2503A0</td> <td>SLIDE TO FIX INTERNAL NON REMOV GLASS SP</td> <td>2</td> <td>PZ</td> </tr> <tr> <td>VM2503A0</td> <td>SLIDE TO FIX INTERNAL NON REMOV GLASS SP</td> <td>2</td> <td>PZ</td> </tr> </tbody> </table> | Code | Description | Qty | UOM | VM1224A0 | 65MY 220MM 2 COLOURS SHRINK TUBE | 0.150 | M | VM2503A0 | SLIDE TO FIX INTERNAL NON REMOV GLASS SP | 2 | PZ | VM2503A0 | SLIDE TO FIX INTERNAL NON REMOV GLASS SP | 2 | PZ |
| Code | Description | Qty | UOM | | | | | | | | | | | | | | | | | | |
| VM1224A0 | 65MY 220MM 2 COLOURS SHRINK TUBE | 0.150 | M | | | | | | | | | | | | | | | | | | |
| VM2503A0 | SLIDE TO FIX INTERNAL NON REMOV GLASS SP | 2 | PZ | | | | | | | | | | | | | | | | | | |
| VM2503A0 | SLIDE TO FIX INTERNAL NON REMOV GLASS SP | 2 | PZ | | | | | | | | | | | | | | | | | | |
| VM2463A | SHOP.PRO RIGHT UPPER CAP DROP DOWN DOOR |  | KVM2463A | BL SP RIGHT UPPER DROPDOWN DOOR CAP KIT | <table border="1"> <thead> <tr> <th>Code</th> <th>Description</th> <th>Qty</th> <th>UOM</th> </tr> </thead> <tbody> <tr> <td>VM1224A0</td> <td>65MY 220MM 2 COLOURS SHRINK TUBE</td> <td>0.300</td> <td>M</td> </tr> <tr> <td>VM2463A0</td> <td>SHOP.PRO RIGHT UPPER CAP DROP DOWN DOOR</td> <td>1</td> <td>PZ</td> </tr> <tr> <td>VM2463A0</td> <td>SHOP.PRO RIGHT UPPER CAP DROP DOWN DOOR</td> <td>1</td> <td>PZ</td> </tr> </tbody> </table> | Code | Description | Qty | UOM | VM1224A0 | 65MY 220MM 2 COLOURS SHRINK TUBE | 0.300 | M | VM2463A0 | SHOP.PRO RIGHT UPPER CAP DROP DOWN DOOR | 1 | PZ | VM2463A0 | SHOP.PRO RIGHT UPPER CAP DROP DOWN DOOR | 1 | PZ |
| Code | Description | Qty | UOM | | | | | | | | | | | | | | | | | | |
| VM1224A0 | 65MY 220MM 2 COLOURS SHRINK TUBE | 0.300 | M | | | | | | | | | | | | | | | | | | |
| VM2463A0 | SHOP.PRO RIGHT UPPER CAP DROP DOWN DOOR | 1 | PZ | | | | | | | | | | | | | | | | | | |
| VM2463A0 | SHOP.PRO RIGHT UPPER CAP DROP DOWN DOOR | 1 | PZ | | | | | | | | | | | | | | | | | | |
| VM2461A | BL SP RIGHT LOWER DROPDOWN DOOR CAP KIT |  | KVM2461A | BL SP RIGHT LOWER DROPDOWN DOOR CAP KIT | <table border="1"> <thead> <tr> <th>Code</th> <th>Description</th> <th>Qty</th> <th>UOM</th> </tr> </thead> <tbody> <tr> <td>VM1224A0</td> <td>65MY 220MM 2 COLOURS SHRINK TUBE</td> <td>0.300</td> <td>M</td> </tr> <tr> <td>VM2461A0</td> <td>BL SP RIGHT LOWER DROPDOWN DOOR CAP KIT</td> <td>1</td> <td>PZ</td> </tr> <tr> <td>VM2461A0</td> <td>BL SP RIGHT LOWER DROPDOWN DOOR CAP KIT</td> <td>1</td> <td>PZ</td> </tr> </tbody> </table> | Code | Description | Qty | UOM | VM1224A0 | 65MY 220MM 2 COLOURS SHRINK TUBE | 0.300 | M | VM2461A0 | BL SP RIGHT LOWER DROPDOWN DOOR CAP KIT | 1 | PZ | VM2461A0 | BL SP RIGHT LOWER DROPDOWN DOOR CAP KIT | 1 | PZ |
| Code | Description | Qty | UOM | | | | | | | | | | | | | | | | | | |
| VM1224A0 | 65MY 220MM 2 COLOURS SHRINK TUBE | 0.300 | M | | | | | | | | | | | | | | | | | | |
| VM2461A0 | BL SP RIGHT LOWER DROPDOWN DOOR CAP KIT | 1 | PZ | | | | | | | | | | | | | | | | | | |
| VM2461A0 | BL SP RIGHT LOWER DROPDOWN DOOR CAP KIT | 1 | PZ | | | | | | | | | | | | | | | | | | |
| VM2462A | BL SP LEFT LOWER DROPDOWN DOOR CAP |  | KVM2462A | BL SP LEFT LOWER DROPDOWN DOOR CAP KIT | <table border="1"> <thead> <tr> <th>Code</th> <th>Description</th> <th>Qty</th> <th>UOM</th> </tr> </thead> <tbody> <tr> <td>VM1224A0</td> <td>65MY 220MM 2 COLOURS SHRINK TUBE</td> <td>0.300</td> <td>M</td> </tr> <tr> <td>VM2462A0</td> <td>BL SP LEFT LOWER DROPDOWN DOOR CAP</td> <td>1</td> <td>PZ</td> </tr> <tr> <td>VM2462A0</td> <td>BL SP LEFT LOWER DROPDOWN DOOR CAP</td> <td>1</td> <td>PZ</td> </tr> </tbody> </table> | Code | Description | Qty | UOM | VM1224A0 | 65MY 220MM 2 COLOURS SHRINK TUBE | 0.300 | M | VM2462A0 | BL SP LEFT LOWER DROPDOWN DOOR CAP | 1 | PZ | VM2462A0 | BL SP LEFT LOWER DROPDOWN DOOR CAP | 1 | PZ |
| Code | Description | Qty | UOM | | | | | | | | | | | | | | | | | | |
| VM1224A0 | 65MY 220MM 2 COLOURS SHRINK TUBE | 0.300 | M | | | | | | | | | | | | | | | | | | |
| VM2462A0 | BL SP LEFT LOWER DROPDOWN DOOR CAP | 1 | PZ | | | | | | | | | | | | | | | | | | |
| VM2462A0 | BL SP LEFT LOWER DROPDOWN DOOR CAP | 1 | PZ | | | | | | | | | | | | | | | | | | |

| COMPONENT | | | SPARE PART | | | | | | | | | | | | | | | | | | | | | | | | | | |
|-----------|---|---|------------|---|--|------|-------------|-----|-----|----------|--|-------|----|----------|---|-------|----|----------|---|----|----|----------|--------------------------------------|---|----|----------|--------------------------------------|---|----|
| Code | Description | Image | Code | Description | Components list | | | | | | | | | | | | | | | | | | | | | | | | |
| VM2478A | BL SP GLASS H4 PUSHING BRACKET |  | KVM2478A | BL SHOP.PRO H4 GLASS SUPPORT 4 PCS KIT | <table border="1"> <thead> <tr> <th>Code</th> <th>Description</th> <th>Qty</th> <th>UOM</th> </tr> </thead> <tbody> <tr> <td>VM1224A0</td> <td>65MY 220MM 2 COLOURS SHRINK TUBE</td> <td>0.200</td> <td>M</td> </tr> <tr> <td>VM1630A0</td> <td>INTERNAL GLASS PUSHING CAP</td> <td>4</td> <td>PZ</td> </tr> <tr> <td>VM1630A1</td> <td>INTERNAL GLASS PUSHING CAP</td> <td>4</td> <td>PZ</td> </tr> <tr> <td>VM2478A0</td> <td>BL SP GLASS H4 PUSHING BRACKET</td> <td>4</td> <td>PZ</td> </tr> <tr> <td>VM2478A0</td> <td>BL SP GLASS H4 PUSHING BRACKET</td> <td>4</td> <td>PZ</td> </tr> </tbody> </table> | Code | Description | Qty | UOM | VM1224A0 | 65MY 220MM 2 COLOURS SHRINK TUBE | 0.200 | M | VM1630A0 | INTERNAL GLASS PUSHING CAP | 4 | PZ | VM1630A1 | INTERNAL GLASS PUSHING CAP | 4 | PZ | VM2478A0 | BL SP GLASS H4 PUSHING BRACKET | 4 | PZ | VM2478A0 | BL SP GLASS H4 PUSHING BRACKET | 4 | PZ |
| Code | Description | Qty | UOM | | | | | | | | | | | | | | | | | | | | | | | | | | |
| VM1224A0 | 65MY 220MM 2 COLOURS SHRINK TUBE | 0.200 | M | | | | | | | | | | | | | | | | | | | | | | | | | | |
| VM1630A0 | INTERNAL GLASS PUSHING CAP | 4 | PZ | | | | | | | | | | | | | | | | | | | | | | | | | | |
| VM1630A1 | INTERNAL GLASS PUSHING CAP | 4 | PZ | | | | | | | | | | | | | | | | | | | | | | | | | | |
| VM2478A0 | BL SP GLASS H4 PUSHING BRACKET | 4 | PZ | | | | | | | | | | | | | | | | | | | | | | | | | | |
| VM2478A0 | BL SP GLASS H4 PUSHING BRACKET | 4 | PZ | | | | | | | | | | | | | | | | | | | | | | | | | | |
| VM1630A | INTERNAL GLASS PUSHING CAP |  | KVM1630A | CAP FOR INTERNAL GLASS 10 PCS KIT | <table border="1"> <thead> <tr> <th>Code</th> <th>Description</th> <th>Qty</th> <th>UOM</th> </tr> </thead> <tbody> <tr> <td>VM1224A0</td> <td>65MY 220MM 2 COLOURS SHRINK TUBE</td> <td>0.200</td> <td>M</td> </tr> <tr> <td>VM1630A0</td> <td>INTERNAL GLASS PUSHING CAP</td> <td>10</td> <td>PZ</td> </tr> <tr> <td>VM1630A1</td> <td>INTERNAL GLASS PUSHING CAP</td> <td>10</td> <td>PZ</td> </tr> </tbody> </table> | Code | Description | Qty | UOM | VM1224A0 | 65MY 220MM 2 COLOURS SHRINK TUBE | 0.200 | M | VM1630A0 | INTERNAL GLASS PUSHING CAP | 10 | PZ | VM1630A1 | INTERNAL GLASS PUSHING CAP | 10 | PZ | | | | | | | | |
| Code | Description | Qty | UOM | | | | | | | | | | | | | | | | | | | | | | | | | | |
| VM1224A0 | 65MY 220MM 2 COLOURS SHRINK TUBE | 0.200 | M | | | | | | | | | | | | | | | | | | | | | | | | | | |
| VM1630A0 | INTERNAL GLASS PUSHING CAP | 10 | PZ | | | | | | | | | | | | | | | | | | | | | | | | | | |
| VM1630A1 | INTERNAL GLASS PUSHING CAP | 10 | PZ | | | | | | | | | | | | | | | | | | | | | | | | | | |
| CE1095A | 4 POLES MICROFIT 2 M BUS CABLE |  | KCE1095A | 4POLES 2M BUS CABLE KIT POWER-CONTROL | <table border="1"> <thead> <tr> <th>Code</th> <th>Description</th> <th>Qty</th> <th>UOM</th> </tr> </thead> <tbody> <tr> <td>CE1095A0</td> <td>4 POLES MICROFIT 2 M BUS CABLE</td> <td>1</td> <td>PZ</td> </tr> <tr> <td>VM1224A0</td> <td>65MY 220MM 2 COLOURS SHRINK TUBE</td> <td>0.250</td> <td>M</td> </tr> </tbody> </table> | Code | Description | Qty | UOM | CE1095A0 | 4 POLES MICROFIT 2 M BUS CABLE | 1 | PZ | VM1224A0 | 65MY 220MM 2 COLOURS SHRINK TUBE | 0.250 | M | | | | | | | | | | | | |
| Code | Description | Qty | UOM | | | | | | | | | | | | | | | | | | | | | | | | | | |
| CE1095A0 | 4 POLES MICROFIT 2 M BUS CABLE | 1 | PZ | | | | | | | | | | | | | | | | | | | | | | | | | | |
| VM1224A0 | 65MY 220MM 2 COLOURS SHRINK TUBE | 0.250 | M | | | | | | | | | | | | | | | | | | | | | | | | | | |
| VM2512A | BL SP DOOR-MICROSWITC H SOFT CLOSING |  | KVM2512A | BL SP DOOR-MICROSWITC H SOFT CLOSING KI | <table border="1"> <thead> <tr> <th>Code</th> <th>Description</th> <th>Qty</th> <th>UOM</th> </tr> </thead> <tbody> <tr> <td>VM1224A0</td> <td>65MY 220MM 2 COLOURS SHRINK TUBE</td> <td>0.250</td> <td>M</td> </tr> <tr> <td>VM2512A0</td> <td>BL SP DOOR-MICRO SWITCH SOFT CLOSING</td> <td>1</td> <td>PZ</td> </tr> <tr> <td>VM2512A0</td> <td>BL SP DOOR-MICRO SWITCH SOFT CLOSING</td> <td>1</td> <td>PZ</td> </tr> </tbody> </table> | Code | Description | Qty | UOM | VM1224A0 | 65MY 220MM 2 COLOURS SHRINK TUBE | 0.250 | M | VM2512A0 | BL SP DOOR-MICRO SWITCH SOFT CLOSING | 1 | PZ | VM2512A0 | BL SP DOOR-MICRO SWITCH SOFT CLOSING | 1 | PZ | | | | | | | | |
| Code | Description | Qty | UOM | | | | | | | | | | | | | | | | | | | | | | | | | | |
| VM1224A0 | 65MY 220MM 2 COLOURS SHRINK TUBE | 0.250 | M | | | | | | | | | | | | | | | | | | | | | | | | | | |
| VM2512A0 | BL SP DOOR-MICRO SWITCH SOFT CLOSING | 1 | PZ | | | | | | | | | | | | | | | | | | | | | | | | | | |
| VM2512A0 | BL SP DOOR-MICRO SWITCH SOFT CLOSING | 1 | PZ | | | | | | | | | | | | | | | | | | | | | | | | | | |

| COMPONENT | | | SPARE PART | | | | | | | | | | | | | | | | | | | | | | | | | | | | | | | | | | | | | | | | | | |
|-----------|---|---|------------|--|---|------|-------------|-----|-----|----------|---|---|----|----------|----------------------------|---|----|----------|--|-------|---|----------|---|-------|---|----------|------------------------------------|----|----|----------|--------------------------------------|---|----|----------|--------------------------|-------|---|----------|---|---|----|----------|---|---|----|
| Code | Description | Image | Code | Description | Components list | | | | | | | | | | | | | | | | | | | | | | | | | | | | | | | | | | | | | | | | |
| 0B1286A | |  | 0B1286A0 | | | | | | | | | | | | | | | | | | | | | | | | | | | | | | | | | | | | | | | | | | |
| 0B1288A | |  | 0B1288A0 | | | | | | | | | | | | | | | | | | | | | | | | | | | | | | | | | | | | | | | | | | |
| CR1111A | BLSP STEFANIA DROPDOWN DOOR HINGE |  | KCR1111A | BAKERLUX SHOP.PRO STEFANIA HINGES KIT | <table border="1"> <thead> <tr> <th>Code</th> <th>Description</th> <th>Qty</th> <th>UOM</th> </tr> </thead> <tbody> <tr> <td>CR1111A0</td> <td>BLSP STEFANIA DROPDOWN DOOR HINGE</td> <td>1</td> <td>PZ</td> </tr> <tr> <td>VI1875A0</td> <td>SCREW M5X10 TC1/2T INOX</td> <td>3</td> <td>PZ</td> </tr> </tbody> </table> | Code | Description | Qty | UOM | CR1111A0 | BLSP STEFANIA DROPDOWN DOOR HINGE | 1 | PZ | VI1875A0 | SCREW M5X10 TC1/2T INOX | 3 | PZ | | | | | | | | | | | | | | | | | | | | | | | | | | | | |
| Code | Description | Qty | UOM | | | | | | | | | | | | | | | | | | | | | | | | | | | | | | | | | | | | | | | | | | |
| CR1111A0 | BLSP STEFANIA DROPDOWN DOOR HINGE | 1 | PZ | | | | | | | | | | | | | | | | | | | | | | | | | | | | | | | | | | | | | | | | | | |
| VI1875A0 | SCREW M5X10 TC1/2T INOX | 3 | PZ | | | | | | | | | | | | | | | | | | | | | | | | | | | | | | | | | | | | | | | | | | |
| VT1323A | SP STEFANIA 357X364X4 EXTERNAL GLASS |  | KVT1323A | BL SHOP.PRO STEFANIA EXTERNAL GLASS KIT | <table border="1"> <thead> <tr> <th>Code</th> <th>Description</th> <th>Qty</th> <th>UOM</th> </tr> </thead> <tbody> <tr> <td>OB0386A0</td> <td></td> <td>2</td> <td>PZ</td> </tr> <tr> <td>ED1240A0</td> <td>TECHNICAL DATA LABEL</td> <td>1</td> <td>PZ</td> </tr> <tr> <td>IP1385A1</td> <td>CORNER POLYSTYREN E PACKING 110X80X2000</td> <td>0.800</td> <td>M</td> </tr> <tr> <td>IP1508A1</td> <td>POLYSTYREN E U SHAPED PROFILE 2000X60X60</td> <td>0.800</td> <td>M</td> </tr> <tr> <td>SL1155A1</td> <td>LOCTITE BICOMPONEN T SILICON</td> <td>14</td> <td>ML</td> </tr> <tr> <td>VI1220A1</td> <td>4,2X12 TCB SELF-TAPPIN G SCREW</td> <td>6</td> <td>PZ</td> </tr> <tr> <td>VM1059A1</td> <td>HEAT SHRINK FILM H800</td> <td>1.200</td> <td>M</td> </tr> <tr> <td>VT1323A0</td> <td>SP STEFANIA 357X364X4 EXTERNAL GLASS</td> <td>1</td> <td>PZ</td> </tr> <tr> <td>VT1323A0</td> <td>SP STEFANIA 357X364X4 EXTERNAL GLASS</td> <td>1</td> <td>PZ</td> </tr> </tbody> </table> | Code | Description | Qty | UOM | OB0386A0 | | 2 | PZ | ED1240A0 | TECHNICAL DATA LABEL | 1 | PZ | IP1385A1 | CORNER POLYSTYREN E PACKING 110X80X2000 | 0.800 | M | IP1508A1 | POLYSTYREN E U SHAPED PROFILE 2000X60X60 | 0.800 | M | SL1155A1 | LOCTITE BICOMPONEN T SILICON | 14 | ML | VI1220A1 | 4,2X12 TCB SELF-TAPPIN G SCREW | 6 | PZ | VM1059A1 | HEAT SHRINK FILM H800 | 1.200 | M | VT1323A0 | SP STEFANIA 357X364X4 EXTERNAL GLASS | 1 | PZ | VT1323A0 | SP STEFANIA 357X364X4 EXTERNAL GLASS | 1 | PZ |
| Code | Description | Qty | UOM | | | | | | | | | | | | | | | | | | | | | | | | | | | | | | | | | | | | | | | | | | |
| OB0386A0 | | 2 | PZ | | | | | | | | | | | | | | | | | | | | | | | | | | | | | | | | | | | | | | | | | | |
| ED1240A0 | TECHNICAL DATA LABEL | 1 | PZ | | | | | | | | | | | | | | | | | | | | | | | | | | | | | | | | | | | | | | | | | | |
| IP1385A1 | CORNER POLYSTYREN E PACKING 110X80X2000 | 0.800 | M | | | | | | | | | | | | | | | | | | | | | | | | | | | | | | | | | | | | | | | | | | |
| IP1508A1 | POLYSTYREN E U SHAPED PROFILE 2000X60X60 | 0.800 | M | | | | | | | | | | | | | | | | | | | | | | | | | | | | | | | | | | | | | | | | | | |
| SL1155A1 | LOCTITE BICOMPONEN T SILICON | 14 | ML | | | | | | | | | | | | | | | | | | | | | | | | | | | | | | | | | | | | | | | | | | |
| VI1220A1 | 4,2X12 TCB SELF-TAPPIN G SCREW | 6 | PZ | | | | | | | | | | | | | | | | | | | | | | | | | | | | | | | | | | | | | | | | | | |
| VM1059A1 | HEAT SHRINK FILM H800 | 1.200 | M | | | | | | | | | | | | | | | | | | | | | | | | | | | | | | | | | | | | | | | | | | |
| VT1323A0 | SP STEFANIA 357X364X4 EXTERNAL GLASS | 1 | PZ | | | | | | | | | | | | | | | | | | | | | | | | | | | | | | | | | | | | | | | | | | |
| VT1323A0 | SP STEFANIA 357X364X4 EXTERNAL GLASS | 1 | PZ | | | | | | | | | | | | | | | | | | | | | | | | | | | | | | | | | | | | | | | | | | |



| COMPONENT | | | SPARE PART | | | | | | | | | | | | | | | | | | | | | | | | | | | | | | | | | | | | | | | | | | | | | | | | | | | | | | | | | | | | | | | | | | | | | | | | | | | | | | | | | | |
|-----------|--|---|------------|--|---|------|-------------|-----|-----|----------|--|---|----|----------|--|---|----|----------|--|---|----|----------|--|---|----|----------|---|---|----|----------|-------------------------|---|----|----------|---------------------------------------|-------|----|----------|--|-------|---|----------|---|-------|---|----------|---|---|----|----------|------------------------------------|----|----|----------|-------------------------------|---|----|----------|---|---|----|----------|--|---|----|----------|--------------------------------------|----|----|----------|---------------------------------|----|----|----------|----------------------------------|---|----|----------|--------------------------|-------|---|----------|--------------------------------|---|----|
| Code | Description | Image | Code | Description | Components list | | | | | | | | | | | | | | | | | | | | | | | | | | | | | | | | | | | | | | | | | | | | | | | | | | | | | | | | | | | | | | | | | | | | | | | | | | | | | | | | |
| VT1323A | SP STEFANIA 357X364X4 EXTERNAL GLASS |  | KDR1285A | BL SHOP.PRO STEFANIA EXTER DOOR KIT LEFT | <table border="1"> <thead> <tr> <th>Code</th> <th>Description</th> <th>Qty</th> <th>UOM</th> </tr> </thead> <tbody> <tr> <td>0B1293A0</td> <td></td> <td>1</td> <td>PZ</td> </tr> <tr> <td>0B1294A0</td> <td></td> <td>1</td> <td>PZ</td> </tr> <tr> <td>0B1295B0</td> <td></td> <td>1</td> <td>PZ</td> </tr> <tr> <td>0B1296B0</td> <td></td> <td>1</td> <td>PZ</td> </tr> <tr> <td>CR1040A0</td> <td>DOOR LATCH FOR EL.MECH. LOCKING SYSTEM</td> <td>1</td> <td>PZ</td> </tr> <tr> <td>ED1240A0</td> <td>TECHNICAL DATA LABEL</td> <td>1</td> <td>PZ</td> </tr> <tr> <td>IP1325B0</td> <td>POLYSTYREN E CORNER PACKING D20</td> <td>0.650</td> <td>PZ</td> </tr> <tr> <td>IP1385A1</td> <td>CORNER POLYSTYREN E PACKING 110X80X2000</td> <td>0.400</td> <td>M</td> </tr> <tr> <td>IP1508A1</td> <td>POLYSTYREN E U SHAPED PROFILE 2000X60X60</td> <td>0.800</td> <td>M</td> </tr> <tr> <td>ML1005A0</td> <td>DES DF0.6 H18 COMPRESSIO N SPRING</td> <td>2</td> <td>PZ</td> </tr> <tr> <td>SL1155A1</td> <td>LOCTITE BICOMPONEN T SILICON</td> <td>14</td> <td>ML</td> </tr> <tr> <td>TB1562A0</td> <td>DOOR LATERAL BEAM SP600</td> <td>2</td> <td>PZ</td> </tr> <tr> <td>TB3303A0</td> <td>SHOP.PRO STE-ELE FLAG DOOR HANDLE TUBE</td> <td>1</td> <td>PZ</td> </tr> <tr> <td>VI1036A0</td> <td>ST STEEL STRIPED THREAD INSERT M10 FTT/C</td> <td>1</td> <td>PZ</td> </tr> <tr> <td>VI1220A1</td> <td>4,2X12 TCB SELF-TAPPIN G SCREW</td> <td>12</td> <td>PZ</td> </tr> <tr> <td>VI1930A0</td> <td>5X25 ST. STEEL SCREW CHIP</td> <td>22</td> <td>PZ</td> </tr> <tr> <td>VI1998A0</td> <td>ZINC PLATED SCREW 5X30 TCB</td> <td>2</td> <td>PZ</td> </tr> <tr> <td>VM1059A1</td> <td>HEAT SHRINK FILM H800</td> <td>1.200</td> <td>M</td> </tr> <tr> <td>VM1209A0</td> <td>SHOP.PRO LOCK PIN WASHER</td> <td>1</td> <td>PZ</td> </tr> </tbody> </table> | Code | Description | Qty | UOM | 0B1293A0 | | 1 | PZ | 0B1294A0 | | 1 | PZ | 0B1295B0 | | 1 | PZ | 0B1296B0 | | 1 | PZ | CR1040A0 | DOOR LATCH FOR EL.MECH. LOCKING SYSTEM | 1 | PZ | ED1240A0 | TECHNICAL DATA LABEL | 1 | PZ | IP1325B0 | POLYSTYREN E CORNER PACKING D20 | 0.650 | PZ | IP1385A1 | CORNER POLYSTYREN E PACKING 110X80X2000 | 0.400 | M | IP1508A1 | POLYSTYREN E U SHAPED PROFILE 2000X60X60 | 0.800 | M | ML1005A0 | DES DF0.6 H18 COMPRESSIO N SPRING | 2 | PZ | SL1155A1 | LOCTITE BICOMPONEN T SILICON | 14 | ML | TB1562A0 | DOOR LATERAL BEAM SP600 | 2 | PZ | TB3303A0 | SHOP.PRO STE-ELE FLAG DOOR HANDLE TUBE | 1 | PZ | VI1036A0 | ST STEEL STRIPED THREAD INSERT M10 FTT/C | 1 | PZ | VI1220A1 | 4,2X12 TCB SELF-TAPPIN G SCREW | 12 | PZ | VI1930A0 | 5X25 ST. STEEL SCREW CHIP | 22 | PZ | VI1998A0 | ZINC PLATED SCREW 5X30 TCB | 2 | PZ | VM1059A1 | HEAT SHRINK FILM H800 | 1.200 | M | VM1209A0 | SHOP.PRO LOCK PIN WASHER | 1 | PZ |
| Code | Description | Qty | UOM | | | | | | | | | | | | | | | | | | | | | | | | | | | | | | | | | | | | | | | | | | | | | | | | | | | | | | | | | | | | | | | | | | | | | | | | | | | | | | | | | | |
| 0B1293A0 | | 1 | PZ | | | | | | | | | | | | | | | | | | | | | | | | | | | | | | | | | | | | | | | | | | | | | | | | | | | | | | | | | | | | | | | | | | | | | | | | | | | | | | | | | | |
| 0B1294A0 | | 1 | PZ | | | | | | | | | | | | | | | | | | | | | | | | | | | | | | | | | | | | | | | | | | | | | | | | | | | | | | | | | | | | | | | | | | | | | | | | | | | | | | | | | | |
| 0B1295B0 | | 1 | PZ | | | | | | | | | | | | | | | | | | | | | | | | | | | | | | | | | | | | | | | | | | | | | | | | | | | | | | | | | | | | | | | | | | | | | | | | | | | | | | | | | | |
| 0B1296B0 | | 1 | PZ | | | | | | | | | | | | | | | | | | | | | | | | | | | | | | | | | | | | | | | | | | | | | | | | | | | | | | | | | | | | | | | | | | | | | | | | | | | | | | | | | | |
| CR1040A0 | DOOR LATCH FOR EL.MECH. LOCKING SYSTEM | 1 | PZ | | | | | | | | | | | | | | | | | | | | | | | | | | | | | | | | | | | | | | | | | | | | | | | | | | | | | | | | | | | | | | | | | | | | | | | | | | | | | | | | | | |
| ED1240A0 | TECHNICAL DATA LABEL | 1 | PZ | | | | | | | | | | | | | | | | | | | | | | | | | | | | | | | | | | | | | | | | | | | | | | | | | | | | | | | | | | | | | | | | | | | | | | | | | | | | | | | | | | |
| IP1325B0 | POLYSTYREN E CORNER PACKING D20 | 0.650 | PZ | | | | | | | | | | | | | | | | | | | | | | | | | | | | | | | | | | | | | | | | | | | | | | | | | | | | | | | | | | | | | | | | | | | | | | | | | | | | | | | | | | |
| IP1385A1 | CORNER POLYSTYREN E PACKING 110X80X2000 | 0.400 | M | | | | | | | | | | | | | | | | | | | | | | | | | | | | | | | | | | | | | | | | | | | | | | | | | | | | | | | | | | | | | | | | | | | | | | | | | | | | | | | | | | |
| IP1508A1 | POLYSTYREN E U SHAPED PROFILE 2000X60X60 | 0.800 | M | | | | | | | | | | | | | | | | | | | | | | | | | | | | | | | | | | | | | | | | | | | | | | | | | | | | | | | | | | | | | | | | | | | | | | | | | | | | | | | | | | |
| ML1005A0 | DES DF0.6 H18 COMPRESSIO N SPRING | 2 | PZ | | | | | | | | | | | | | | | | | | | | | | | | | | | | | | | | | | | | | | | | | | | | | | | | | | | | | | | | | | | | | | | | | | | | | | | | | | | | | | | | | | |
| SL1155A1 | LOCTITE BICOMPONEN T SILICON | 14 | ML | | | | | | | | | | | | | | | | | | | | | | | | | | | | | | | | | | | | | | | | | | | | | | | | | | | | | | | | | | | | | | | | | | | | | | | | | | | | | | | | | | |
| TB1562A0 | DOOR LATERAL BEAM SP600 | 2 | PZ | | | | | | | | | | | | | | | | | | | | | | | | | | | | | | | | | | | | | | | | | | | | | | | | | | | | | | | | | | | | | | | | | | | | | | | | | | | | | | | | | | |
| TB3303A0 | SHOP.PRO STE-ELE FLAG DOOR HANDLE TUBE | 1 | PZ | | | | | | | | | | | | | | | | | | | | | | | | | | | | | | | | | | | | | | | | | | | | | | | | | | | | | | | | | | | | | | | | | | | | | | | | | | | | | | | | | | |
| VI1036A0 | ST STEEL STRIPED THREAD INSERT M10 FTT/C | 1 | PZ | | | | | | | | | | | | | | | | | | | | | | | | | | | | | | | | | | | | | | | | | | | | | | | | | | | | | | | | | | | | | | | | | | | | | | | | | | | | | | | | | | |
| VI1220A1 | 4,2X12 TCB SELF-TAPPIN G SCREW | 12 | PZ | | | | | | | | | | | | | | | | | | | | | | | | | | | | | | | | | | | | | | | | | | | | | | | | | | | | | | | | | | | | | | | | | | | | | | | | | | | | | | | | | | |
| VI1930A0 | 5X25 ST. STEEL SCREW CHIP | 22 | PZ | | | | | | | | | | | | | | | | | | | | | | | | | | | | | | | | | | | | | | | | | | | | | | | | | | | | | | | | | | | | | | | | | | | | | | | | | | | | | | | | | | |
| VI1998A0 | ZINC PLATED SCREW 5X30 TCB | 2 | PZ | | | | | | | | | | | | | | | | | | | | | | | | | | | | | | | | | | | | | | | | | | | | | | | | | | | | | | | | | | | | | | | | | | | | | | | | | | | | | | | | | | |
| VM1059A1 | HEAT SHRINK FILM H800 | 1.200 | M | | | | | | | | | | | | | | | | | | | | | | | | | | | | | | | | | | | | | | | | | | | | | | | | | | | | | | | | | | | | | | | | | | | | | | | | | | | | | | | | | | |
| VM1209A0 | SHOP.PRO LOCK PIN WASHER | 1 | PZ | | | | | | | | | | | | | | | | | | | | | | | | | | | | | | | | | | | | | | | | | | | | | | | | | | | | | | | | | | | | | | | | | | | | | | | | | | | | | | | | | | |





| COMPONENT | | | SPARE PART | | | | | | | | | | | | | | | | | | | | | | | | | | | | | | | | | | | | | | | | | | | | | | | | | | | | | | | | | | | | | | |
|-----------|---|---|------------|--|--|------|-------------|-----|-----|----------|----------------------------------|---|----|----------|----------------------------------|---|----|----------|--------------------|---|----|----------|-------------------|---|----|----------|------------------------------------|---|----|----------|------------------------------------|---|----|----------|---|---|----|----------|---|---|----|----------|--|---|----|----------|--|---|----|----------|---|---|----|----------|---|---|----|----------|--|---|----|----------|--|---|----|
| Code | Description | Image | Code | Description | Components list | | | | | | | | | | | | | | | | | | | | | | | | | | | | | | | | | | | | | | | | | | | | | | | | | | | | | | | | | | | | |
| VT1323A | SP STEFANIA 357X364X4 EXTERNAL GLASS |  | KDR1285A | BL SHOP.PRO STEFANIA EXTER DOOR KIT LEFT | <table border="1"> <thead> <tr> <th>Code</th> <th>Description</th> <th>Qty</th> <th>UOM</th> </tr> </thead> <tbody> <tr> <td>VM1630A0</td> <td>INTERNAL GLASS PUSHING CAP</td> <td>4</td> <td>PZ</td> </tr> <tr> <td>VM1630A1</td> <td>INTERNAL GLASS PUSHING CAP</td> <td>4</td> <td>PZ</td> </tr> <tr> <td>VM2274A0</td> <td>GROOVED BUSHING</td> <td>1</td> <td>PZ</td> </tr> <tr> <td>VM2275A0</td> <td>SMOOTH BUSHING</td> <td>1</td> <td>PZ</td> </tr> <tr> <td>VM2456A0</td> <td>BAKERLUX SHOP.PRO HANDLE END</td> <td>2</td> <td>PZ</td> </tr> <tr> <td>VM2456A0</td> <td>BAKERLUX SHOP.PRO HANDLE END</td> <td>2</td> <td>PZ</td> </tr> <tr> <td>VM2465A0</td> <td>SP SIDE-OPENIN G DOOR RIGHT LOWER CAP KIT</td> <td>1</td> <td>PZ</td> </tr> <tr> <td>VM2465A0</td> <td>SP SIDE-OPENIN G DOOR RIGHT LOWER CAP KIT</td> <td>1</td> <td>PZ</td> </tr> <tr> <td>VM2466A0</td> <td>BL SP LEFT LOWER LATERAL DOOR CAP</td> <td>1</td> <td>PZ</td> </tr> <tr> <td>VM2466A0</td> <td>BL SP LEFT LOWER LATERAL DOOR CAP</td> <td>1</td> <td>PZ</td> </tr> <tr> <td>VM2467A0</td> <td>SP SIDE-OPENIN G DOOR RIGHT UPPER CAP KIT</td> <td>1</td> <td>PZ</td> </tr> <tr> <td>VM2467A0</td> <td>SP SIDE-OPENIN G DOOR RIGHT UPPER CAP KIT</td> <td>1</td> <td>PZ</td> </tr> <tr> <td>VM2468A0</td> <td>BL SP LEFT UPPER LATERAL DOOR CAP</td> <td>1</td> <td>PZ</td> </tr> <tr> <td>VM2468A0</td> <td>BL SP LEFT UPPER LATERAL DOOR CAP</td> <td>1</td> <td>PZ</td> </tr> </tbody> </table> | Code | Description | Qty | UOM | VM1630A0 | INTERNAL GLASS PUSHING CAP | 4 | PZ | VM1630A1 | INTERNAL GLASS PUSHING CAP | 4 | PZ | VM2274A0 | GROOVED BUSHING | 1 | PZ | VM2275A0 | SMOOTH BUSHING | 1 | PZ | VM2456A0 | BAKERLUX SHOP.PRO HANDLE END | 2 | PZ | VM2456A0 | BAKERLUX SHOP.PRO HANDLE END | 2 | PZ | VM2465A0 | SP SIDE-OPENIN G DOOR RIGHT LOWER CAP KIT | 1 | PZ | VM2465A0 | SP SIDE-OPENIN G DOOR RIGHT LOWER CAP KIT | 1 | PZ | VM2466A0 | BL SP LEFT LOWER LATERAL DOOR CAP | 1 | PZ | VM2466A0 | BL SP LEFT LOWER LATERAL DOOR CAP | 1 | PZ | VM2467A0 | SP SIDE-OPENIN G DOOR RIGHT UPPER CAP KIT | 1 | PZ | VM2467A0 | SP SIDE-OPENIN G DOOR RIGHT UPPER CAP KIT | 1 | PZ | VM2468A0 | BL SP LEFT UPPER LATERAL DOOR CAP | 1 | PZ | VM2468A0 | BL SP LEFT UPPER LATERAL DOOR CAP | 1 | PZ |
| Code | Description | Qty | UOM | | | | | | | | | | | | | | | | | | | | | | | | | | | | | | | | | | | | | | | | | | | | | | | | | | | | | | | | | | | | | | |
| VM1630A0 | INTERNAL GLASS PUSHING CAP | 4 | PZ | | | | | | | | | | | | | | | | | | | | | | | | | | | | | | | | | | | | | | | | | | | | | | | | | | | | | | | | | | | | | | |
| VM1630A1 | INTERNAL GLASS PUSHING CAP | 4 | PZ | | | | | | | | | | | | | | | | | | | | | | | | | | | | | | | | | | | | | | | | | | | | | | | | | | | | | | | | | | | | | | |
| VM2274A0 | GROOVED BUSHING | 1 | PZ | | | | | | | | | | | | | | | | | | | | | | | | | | | | | | | | | | | | | | | | | | | | | | | | | | | | | | | | | | | | | | |
| VM2275A0 | SMOOTH BUSHING | 1 | PZ | | | | | | | | | | | | | | | | | | | | | | | | | | | | | | | | | | | | | | | | | | | | | | | | | | | | | | | | | | | | | | |
| VM2456A0 | BAKERLUX SHOP.PRO HANDLE END | 2 | PZ | | | | | | | | | | | | | | | | | | | | | | | | | | | | | | | | | | | | | | | | | | | | | | | | | | | | | | | | | | | | | | |
| VM2456A0 | BAKERLUX SHOP.PRO HANDLE END | 2 | PZ | | | | | | | | | | | | | | | | | | | | | | | | | | | | | | | | | | | | | | | | | | | | | | | | | | | | | | | | | | | | | | |
| VM2465A0 | SP SIDE-OPENIN G DOOR RIGHT LOWER CAP KIT | 1 | PZ | | | | | | | | | | | | | | | | | | | | | | | | | | | | | | | | | | | | | | | | | | | | | | | | | | | | | | | | | | | | | | |
| VM2465A0 | SP SIDE-OPENIN G DOOR RIGHT LOWER CAP KIT | 1 | PZ | | | | | | | | | | | | | | | | | | | | | | | | | | | | | | | | | | | | | | | | | | | | | | | | | | | | | | | | | | | | | | |
| VM2466A0 | BL SP LEFT LOWER LATERAL DOOR CAP | 1 | PZ | | | | | | | | | | | | | | | | | | | | | | | | | | | | | | | | | | | | | | | | | | | | | | | | | | | | | | | | | | | | | | |
| VM2466A0 | BL SP LEFT LOWER LATERAL DOOR CAP | 1 | PZ | | | | | | | | | | | | | | | | | | | | | | | | | | | | | | | | | | | | | | | | | | | | | | | | | | | | | | | | | | | | | | |
| VM2467A0 | SP SIDE-OPENIN G DOOR RIGHT UPPER CAP KIT | 1 | PZ | | | | | | | | | | | | | | | | | | | | | | | | | | | | | | | | | | | | | | | | | | | | | | | | | | | | | | | | | | | | | | |
| VM2467A0 | SP SIDE-OPENIN G DOOR RIGHT UPPER CAP KIT | 1 | PZ | | | | | | | | | | | | | | | | | | | | | | | | | | | | | | | | | | | | | | | | | | | | | | | | | | | | | | | | | | | | | | |
| VM2468A0 | BL SP LEFT UPPER LATERAL DOOR CAP | 1 | PZ | | | | | | | | | | | | | | | | | | | | | | | | | | | | | | | | | | | | | | | | | | | | | | | | | | | | | | | | | | | | | | |
| VM2468A0 | BL SP LEFT UPPER LATERAL DOOR CAP | 1 | PZ | | | | | | | | | | | | | | | | | | | | | | | | | | | | | | | | | | | | | | | | | | | | | | | | | | | | | | | | | | | | | | |

| COMPONENT | | | SPARE PART | | | | | | | | | | | | | | | | | | | | | | | | | | | | | | | | | | | | | | | | | | | | | | | | | | | | | | | | | | | | | | |
|-----------|--|---|------------|--|---|------|-------------|-----|-----|----------|---|---|----|----------|---|---|----|----------|--|---|----|----------|--|---|----|----------|--|---|----|----------|--|---|----|----------|---|---|----|----------|---|---|----|----------|---|---|----|----------|---|---|----|----------|--------------------------------------|---|----|----------|--------------------------------------|---|----|----------|--------------------------------------|---|----|----------|---|---|----|
| Code | Description | Image | Code | Description | Components list | | | | | | | | | | | | | | | | | | | | | | | | | | | | | | | | | | | | | | | | | | | | | | | | | | | | | | | | | | | | |
| VT1323A | SP STEFANIA 357X364X4 EXTERNAL GLASS |  | KDR1285A | BL SHOP.PRO STEFANIA EXTER DOOR KIT LEFT | <table border="1"> <thead> <tr> <th>Code</th> <th>Description</th> <th>Qty</th> <th>UOM</th> </tr> </thead> <tbody> <tr> <td>VM2470A0</td> <td>SLIDE TO FIX INTERNAL GLASS SHOP.PRO</td> <td>2</td> <td>PZ</td> </tr> <tr> <td>VM2470A0</td> <td>SLIDE TO FIX INTERNAL GLASS SHOP.PRO</td> <td>2</td> <td>PZ</td> </tr> <tr> <td>VM2471A0</td> <td>BL SP LOWER CLAMP INT LOCK GLASS SLIDER</td> <td>1</td> <td>PZ</td> </tr> <tr> <td>VM2471A0</td> <td>BL SP LOWER CLAMP INT LOCK GLASS SLIDER</td> <td>1</td> <td>PZ</td> </tr> <tr> <td>VM2472A0</td> <td>BL SP UPPER CLAMP INT LOCK GLASS SLIDER</td> <td>1</td> <td>PZ</td> </tr> <tr> <td>VM2472A0</td> <td>BL SP UPPER CLAMP INT LOCK GLASS SLIDER</td> <td>1</td> <td>PZ</td> </tr> <tr> <td>VM2473A0</td> <td>BL SP INT GLASS HINGE LOWER LOCK PIN</td> <td>1</td> <td>PZ</td> </tr> <tr> <td>VM2473A0</td> <td>BL SP INT GLASS HINGE LOWER LOCK PIN</td> <td>1</td> <td>PZ</td> </tr> <tr> <td>VM2474A0</td> <td>BL SP INT GLASS HINGE UPPER LOCK PIN</td> <td>1</td> <td>PZ</td> </tr> <tr> <td>VM2474A0</td> <td>BL SP INT GLASS HINGE UPPER LOCK PIN</td> <td>1</td> <td>PZ</td> </tr> <tr> <td>VM2478A0</td> <td>BL SP GLASS H4 PUSHING BRACKET</td> <td>4</td> <td>PZ</td> </tr> <tr> <td>VM2478A0</td> <td>BL SP GLASS H4 PUSHING BRACKET</td> <td>4</td> <td>PZ</td> </tr> <tr> <td>VM2489A0</td> <td>SP HANDLE END KIT + STYLUS KIT</td> <td>1</td> <td>PZ</td> </tr> <tr> <td>VM2504A0</td> <td>DOWEL TO GUIDE SLIDE SPRING SHOP.PRO</td> <td>2</td> <td>PZ</td> </tr> </tbody> </table> | Code | Description | Qty | UOM | VM2470A0 | SLIDE TO FIX INTERNAL GLASS SHOP.PRO | 2 | PZ | VM2470A0 | SLIDE TO FIX INTERNAL GLASS SHOP.PRO | 2 | PZ | VM2471A0 | BL SP LOWER CLAMP INT LOCK GLASS SLIDER | 1 | PZ | VM2471A0 | BL SP LOWER CLAMP INT LOCK GLASS SLIDER | 1 | PZ | VM2472A0 | BL SP UPPER CLAMP INT LOCK GLASS SLIDER | 1 | PZ | VM2472A0 | BL SP UPPER CLAMP INT LOCK GLASS SLIDER | 1 | PZ | VM2473A0 | BL SP INT GLASS HINGE LOWER LOCK PIN | 1 | PZ | VM2473A0 | BL SP INT GLASS HINGE LOWER LOCK PIN | 1 | PZ | VM2474A0 | BL SP INT GLASS HINGE UPPER LOCK PIN | 1 | PZ | VM2474A0 | BL SP INT GLASS HINGE UPPER LOCK PIN | 1 | PZ | VM2478A0 | BL SP GLASS H4 PUSHING BRACKET | 4 | PZ | VM2478A0 | BL SP GLASS H4 PUSHING BRACKET | 4 | PZ | VM2489A0 | SP HANDLE END KIT + STYLUS KIT | 1 | PZ | VM2504A0 | DOWEL TO GUIDE SLIDE SPRING SHOP.PRO | 2 | PZ |
| Code | Description | Qty | UOM | | | | | | | | | | | | | | | | | | | | | | | | | | | | | | | | | | | | | | | | | | | | | | | | | | | | | | | | | | | | | | |
| VM2470A0 | SLIDE TO FIX INTERNAL GLASS SHOP.PRO | 2 | PZ | | | | | | | | | | | | | | | | | | | | | | | | | | | | | | | | | | | | | | | | | | | | | | | | | | | | | | | | | | | | | | |
| VM2470A0 | SLIDE TO FIX INTERNAL GLASS SHOP.PRO | 2 | PZ | | | | | | | | | | | | | | | | | | | | | | | | | | | | | | | | | | | | | | | | | | | | | | | | | | | | | | | | | | | | | | |
| VM2471A0 | BL SP LOWER CLAMP INT LOCK GLASS SLIDER | 1 | PZ | | | | | | | | | | | | | | | | | | | | | | | | | | | | | | | | | | | | | | | | | | | | | | | | | | | | | | | | | | | | | | |
| VM2471A0 | BL SP LOWER CLAMP INT LOCK GLASS SLIDER | 1 | PZ | | | | | | | | | | | | | | | | | | | | | | | | | | | | | | | | | | | | | | | | | | | | | | | | | | | | | | | | | | | | | | |
| VM2472A0 | BL SP UPPER CLAMP INT LOCK GLASS SLIDER | 1 | PZ | | | | | | | | | | | | | | | | | | | | | | | | | | | | | | | | | | | | | | | | | | | | | | | | | | | | | | | | | | | | | | |
| VM2472A0 | BL SP UPPER CLAMP INT LOCK GLASS SLIDER | 1 | PZ | | | | | | | | | | | | | | | | | | | | | | | | | | | | | | | | | | | | | | | | | | | | | | | | | | | | | | | | | | | | | | |
| VM2473A0 | BL SP INT GLASS HINGE LOWER LOCK PIN | 1 | PZ | | | | | | | | | | | | | | | | | | | | | | | | | | | | | | | | | | | | | | | | | | | | | | | | | | | | | | | | | | | | | | |
| VM2473A0 | BL SP INT GLASS HINGE LOWER LOCK PIN | 1 | PZ | | | | | | | | | | | | | | | | | | | | | | | | | | | | | | | | | | | | | | | | | | | | | | | | | | | | | | | | | | | | | | |
| VM2474A0 | BL SP INT GLASS HINGE UPPER LOCK PIN | 1 | PZ | | | | | | | | | | | | | | | | | | | | | | | | | | | | | | | | | | | | | | | | | | | | | | | | | | | | | | | | | | | | | | |
| VM2474A0 | BL SP INT GLASS HINGE UPPER LOCK PIN | 1 | PZ | | | | | | | | | | | | | | | | | | | | | | | | | | | | | | | | | | | | | | | | | | | | | | | | | | | | | | | | | | | | | | |
| VM2478A0 | BL SP GLASS H4 PUSHING BRACKET | 4 | PZ | | | | | | | | | | | | | | | | | | | | | | | | | | | | | | | | | | | | | | | | | | | | | | | | | | | | | | | | | | | | | | |
| VM2478A0 | BL SP GLASS H4 PUSHING BRACKET | 4 | PZ | | | | | | | | | | | | | | | | | | | | | | | | | | | | | | | | | | | | | | | | | | | | | | | | | | | | | | | | | | | | | | |
| VM2489A0 | SP HANDLE END KIT + STYLUS KIT | 1 | PZ | | | | | | | | | | | | | | | | | | | | | | | | | | | | | | | | | | | | | | | | | | | | | | | | | | | | | | | | | | | | | | |
| VM2504A0 | DOWEL TO GUIDE SLIDE SPRING SHOP.PRO | 2 | PZ | | | | | | | | | | | | | | | | | | | | | | | | | | | | | | | | | | | | | | | | | | | | | | | | | | | | | | | | | | | | | | |

| COMPONENT | | | SPARE PART | | | | | | | | | | | | | | | | | | | | | | | | | | | | | | | | | | | | | | | | | | | | | | | | | | | | | | | | | | | |
|-----------|--|--|------------|--|--|------|-------------|-----|-----|----------|---|---|----|----------|----------------------|---|----|----------|---|---|----|----------|---|---|----|----|----------|-------------------------|---|----|----------|---------------------------------------|-------|----|----------|--|-------|---|----------|---|-------|---|----------|---|---|----|----------|------------------------------------|----|----|----------|-------------------------------|---|----|----------|---|---|----|----------|--|---|----|
| Code | Description | Image | Code | Description | Components list | | | | | | | | | | | | | | | | | | | | | | | | | | | | | | | | | | | | | | | | | | | | | | | | | | | | | | | | | |
| VT1323A | SP STEFANIA 357X364X4 EXTERNAL GLASS |  | KDR1285A | BL SHOP.PRO STEFANIA EXTER DOOR KIT LEFT | <table border="1"> <thead> <tr> <th>Code</th> <th>Description</th> <th>Qty</th> <th>UOM</th> </tr> </thead> <tbody> <tr> <td>VM2504A0</td> <td>DOWEL TO GUIDE SLIDE SPRING SHOP.PRO</td> <td>2</td> <td>PZ</td> </tr> <tr> <td>VM2527A0</td> <td>STYLUS PEN FOR SP</td> <td>1</td> <td>PZ</td> </tr> <tr> <td>VT1323A0</td> <td>SP STEFANIA 357X364X4 EXTERNAL GLASS</td> <td>1</td> <td>PZ</td> </tr> <tr> <td>VT1323A0</td> <td>SP STEFANIA 357X364X4 EXTERNAL GLASS</td> <td>1</td> <td>PZ</td> </tr> </tbody> </table> | Code | Description | Qty | UOM | VM2504A0 | DOWEL TO GUIDE SLIDE SPRING SHOP.PRO | 2 | PZ | VM2527A0 | STYLUS PEN FOR SP | 1 | PZ | VT1323A0 | SP STEFANIA 357X364X4 EXTERNAL GLASS | 1 | PZ | VT1323A0 | SP STEFANIA 357X364X4 EXTERNAL GLASS | 1 | PZ | | | | | | | | | | | | | | | | | | | | | | | | | | | | | | | | | | | | | |
| | | | Code | Description | Qty | UOM | | | | | | | | | | | | | | | | | | | | | | | | | | | | | | | | | | | | | | | | | | | | | | | | | | | | | | | | |
| VM2504A0 | DOWEL TO GUIDE SLIDE SPRING SHOP.PRO | 2 | PZ | | | | | | | | | | | | | | | | | | | | | | | | | | | | | | | | | | | | | | | | | | | | | | | | | | | | | | | | | | | |
| VM2527A0 | STYLUS PEN FOR SP | 1 | PZ | | | | | | | | | | | | | | | | | | | | | | | | | | | | | | | | | | | | | | | | | | | | | | | | | | | | | | | | | | | |
| VT1323A0 | SP STEFANIA 357X364X4 EXTERNAL GLASS | 1 | PZ | | | | | | | | | | | | | | | | | | | | | | | | | | | | | | | | | | | | | | | | | | | | | | | | | | | | | | | | | | | |
| VT1323A0 | SP STEFANIA 357X364X4 EXTERNAL GLASS | 1 | PZ | | | | | | | | | | | | | | | | | | | | | | | | | | | | | | | | | | | | | | | | | | | | | | | | | | | | | | | | | | | |
| KDR1284A | BL SHOP.PRO STEFANIA EXTERNAL DOOR KI | <table border="1"> <thead> <tr> <th>Code</th> <th>Description</th> <th>Qty</th> <th>UOM</th> </tr> </thead> <tbody> <tr> <td>OB1293A0</td> <td></td> <td>1</td> <td>PZ</td> </tr> <tr> <td>OB1294A0</td> <td></td> <td>1</td> <td>PZ</td> </tr> <tr> <td>OB1295B0</td> <td></td> <td>1</td> <td>PZ</td> </tr> <tr> <td>OB1296B0</td> <td></td> <td>1</td> <td>PZ</td> </tr> <tr> <td>CR1040A0</td> <td>DOOR LATCH FOR EL.MECH. LOCKING SYSTEM</td> <td>1</td> <td>PZ</td> </tr> <tr> <td>ED1240A0</td> <td>TECHNICAL DATA LABEL</td> <td>1</td> <td>PZ</td> </tr> <tr> <td>IP1325B0</td> <td>POLYSTYREN E CORNER PACKING D20</td> <td>0.650</td> <td>PZ</td> </tr> <tr> <td>IP1385A1</td> <td>CORNER POLYSTYREN E PACKING 110X80X2000</td> <td>0.400</td> <td>M</td> </tr> <tr> <td>IP1508A1</td> <td>POLYSTYREN E U SHAPED PROFILE 2000X60X60</td> <td>0.800</td> <td>M</td> </tr> <tr> <td>ML1005A0</td> <td>DES DF0.6 H18 COMPRESSIO N SPRING</td> <td>2</td> <td>PZ</td> </tr> <tr> <td>SL1155A1</td> <td>LOCTITE BICOMPONEN T SILICON</td> <td>14</td> <td>ML</td> </tr> <tr> <td>TB1562A0</td> <td>DOOR LATERAL BEAM SP600</td> <td>2</td> <td>PZ</td> </tr> <tr> <td>TB3303A0</td> <td>SHOP.PRO STE-ELE FLAG DOOR HANDLE TUBE</td> <td>1</td> <td>PZ</td> </tr> <tr> <td>VI1036A0</td> <td>ST STEEL STRIPED THREAD INSERT M10 FTT/C</td> <td>1</td> <td>PZ</td> </tr> </tbody> </table> | Code | Description | Qty | UOM | OB1293A0 | | 1 | PZ | OB1294A0 | | 1 | PZ | OB1295B0 | | 1 | PZ | OB1296B0 | | 1 | PZ | CR1040A0 | DOOR LATCH FOR EL.MECH. LOCKING SYSTEM | 1 | PZ | ED1240A0 | TECHNICAL DATA LABEL | 1 | PZ | IP1325B0 | POLYSTYREN E CORNER PACKING D20 | 0.650 | PZ | IP1385A1 | CORNER POLYSTYREN E PACKING 110X80X2000 | 0.400 | M | IP1508A1 | POLYSTYREN E U SHAPED PROFILE 2000X60X60 | 0.800 | M | ML1005A0 | DES DF0.6 H18 COMPRESSIO N SPRING | 2 | PZ | SL1155A1 | LOCTITE BICOMPONEN T SILICON | 14 | ML | TB1562A0 | DOOR LATERAL BEAM SP600 | 2 | PZ | TB3303A0 | SHOP.PRO STE-ELE FLAG DOOR HANDLE TUBE | 1 | PZ | VI1036A0 | ST STEEL STRIPED THREAD INSERT M10 FTT/C | 1 | PZ |
| Code | Description | Qty | UOM | | | | | | | | | | | | | | | | | | | | | | | | | | | | | | | | | | | | | | | | | | | | | | | | | | | | | | | | | | | |
| OB1293A0 | | 1 | PZ | | | | | | | | | | | | | | | | | | | | | | | | | | | | | | | | | | | | | | | | | | | | | | | | | | | | | | | | | | | |
| OB1294A0 | | 1 | PZ | | | | | | | | | | | | | | | | | | | | | | | | | | | | | | | | | | | | | | | | | | | | | | | | | | | | | | | | | | | |
| OB1295B0 | | 1 | PZ | | | | | | | | | | | | | | | | | | | | | | | | | | | | | | | | | | | | | | | | | | | | | | | | | | | | | | | | | | | |
| OB1296B0 | | 1 | PZ | | | | | | | | | | | | | | | | | | | | | | | | | | | | | | | | | | | | | | | | | | | | | | | | | | | | | | | | | | | |
| CR1040A0 | DOOR LATCH FOR EL.MECH. LOCKING SYSTEM | 1 | PZ | | | | | | | | | | | | | | | | | | | | | | | | | | | | | | | | | | | | | | | | | | | | | | | | | | | | | | | | | | | |
| ED1240A0 | TECHNICAL DATA LABEL | 1 | PZ | | | | | | | | | | | | | | | | | | | | | | | | | | | | | | | | | | | | | | | | | | | | | | | | | | | | | | | | | | | |
| IP1325B0 | POLYSTYREN E CORNER PACKING D20 | 0.650 | PZ | | | | | | | | | | | | | | | | | | | | | | | | | | | | | | | | | | | | | | | | | | | | | | | | | | | | | | | | | | | |
| IP1385A1 | CORNER POLYSTYREN E PACKING 110X80X2000 | 0.400 | M | | | | | | | | | | | | | | | | | | | | | | | | | | | | | | | | | | | | | | | | | | | | | | | | | | | | | | | | | | | |
| IP1508A1 | POLYSTYREN E U SHAPED PROFILE 2000X60X60 | 0.800 | M | | | | | | | | | | | | | | | | | | | | | | | | | | | | | | | | | | | | | | | | | | | | | | | | | | | | | | | | | | | |
| ML1005A0 | DES DF0.6 H18 COMPRESSIO N SPRING | 2 | PZ | | | | | | | | | | | | | | | | | | | | | | | | | | | | | | | | | | | | | | | | | | | | | | | | | | | | | | | | | | | |
| SL1155A1 | LOCTITE BICOMPONEN T SILICON | 14 | ML | | | | | | | | | | | | | | | | | | | | | | | | | | | | | | | | | | | | | | | | | | | | | | | | | | | | | | | | | | | |
| TB1562A0 | DOOR LATERAL BEAM SP600 | 2 | PZ | | | | | | | | | | | | | | | | | | | | | | | | | | | | | | | | | | | | | | | | | | | | | | | | | | | | | | | | | | | |
| TB3303A0 | SHOP.PRO STE-ELE FLAG DOOR HANDLE TUBE | 1 | PZ | | | | | | | | | | | | | | | | | | | | | | | | | | | | | | | | | | | | | | | | | | | | | | | | | | | | | | | | | | | |
| VI1036A0 | ST STEEL STRIPED THREAD INSERT M10 FTT/C | 1 | PZ | | | | | | | | | | | | | | | | | | | | | | | | | | | | | | | | | | | | | | | | | | | | | | | | | | | | | | | | | | | |





| COMPONENT | | | SPARE PART | | | | | | | | | | | | | | | | | | | | | | | | | | | | | | | | | | | | | | | | | | | | | | | | | | | | | | | | | | | | | | | | | | | | | | |
|-----------|---|---|------------|---|--|------|-------------|-----|-----|----------|--------------------------------------|----|----|----------|---------------------------------|----|----|----------|----------------------------------|---|----|----------|--------------------------|-------|---|----------|--------------------------------|---|----|----------|----------------------------------|---|----|----------|----------------------------------|---|----|----------|--------------------|---|----|----------|-------------------|---|----|----------|------------------------------------|---|----|----------|------------------------------------|---|----|----------|---|---|----|----------|---|---|----|----------|--|---|----|----------|--|---|----|----------|---|---|----|
| Code | Description | Image | Code | Description | Components list | | | | | | | | | | | | | | | | | | | | | | | | | | | | | | | | | | | | | | | | | | | | | | | | | | | | | | | | | | | | | | | | | | | | |
| VT1323A | SP STEFANIA 357X364X4 EXTERNAL GLASS |  | KDR1284A | BL SHOP.PRO STEFANIA EXTERNAL DOOR KI | <table border="1"> <thead> <tr> <th>Code</th> <th>Description</th> <th>Qty</th> <th>UOM</th> </tr> </thead> <tbody> <tr> <td>VI1220A1</td> <td>4,2X12 TCB SELF-TAPPIN G SCREW</td> <td>12</td> <td>PZ</td> </tr> <tr> <td>VI1930A0</td> <td>5X25 ST. STEEL SCREW CHIP</td> <td>22</td> <td>PZ</td> </tr> <tr> <td>VI1998A0</td> <td>ZINC PLATED SCREW 5X30 TCB</td> <td>2</td> <td>PZ</td> </tr> <tr> <td>VM1059A1</td> <td>HEAT SHRINK FILM H800</td> <td>1.200</td> <td>M</td> </tr> <tr> <td>VM1209A0</td> <td>SHOP.PRO LOCK PIN WASHER</td> <td>1</td> <td>PZ</td> </tr> <tr> <td>VM1630A0</td> <td>INTERNAL GLASS PUSHING CAP</td> <td>4</td> <td>PZ</td> </tr> <tr> <td>VM1630A1</td> <td>INTERNAL GLASS PUSHING CAP</td> <td>4</td> <td>PZ</td> </tr> <tr> <td>VM2274A0</td> <td>GROOVED BUSHING</td> <td>1</td> <td>PZ</td> </tr> <tr> <td>VM2275A0</td> <td>SMOOTH BUSHING</td> <td>1</td> <td>PZ</td> </tr> <tr> <td>VM2456A0</td> <td>BAKERLUX SHOP.PRO HANDLE END</td> <td>2</td> <td>PZ</td> </tr> <tr> <td>VM2456A0</td> <td>BAKERLUX SHOP.PRO HANDLE END</td> <td>2</td> <td>PZ</td> </tr> <tr> <td>VM2465A0</td> <td>SP SIDE-OPENIN G DOOR RIGHT LOWER CAP KIT</td> <td>1</td> <td>PZ</td> </tr> <tr> <td>VM2465A0</td> <td>SP SIDE-OPENIN G DOOR RIGHT LOWER CAP KIT</td> <td>1</td> <td>PZ</td> </tr> <tr> <td>VM2466A0</td> <td>BL SP LEFT LOWER LATERAL DOOR CAP</td> <td>1</td> <td>PZ</td> </tr> <tr> <td>VM2466A0</td> <td>BL SP LEFT LOWER LATERAL DOOR CAP</td> <td>1</td> <td>PZ</td> </tr> <tr> <td>VM2467A0</td> <td>SP SIDE-OPENIN G DOOR RIGHT UPPER CAP KIT</td> <td>1</td> <td>PZ</td> </tr> </tbody> </table> | Code | Description | Qty | UOM | VI1220A1 | 4,2X12 TCB SELF-TAPPIN G SCREW | 12 | PZ | VI1930A0 | 5X25 ST. STEEL SCREW CHIP | 22 | PZ | VI1998A0 | ZINC PLATED SCREW 5X30 TCB | 2 | PZ | VM1059A1 | HEAT SHRINK FILM H800 | 1.200 | M | VM1209A0 | SHOP.PRO LOCK PIN WASHER | 1 | PZ | VM1630A0 | INTERNAL GLASS PUSHING CAP | 4 | PZ | VM1630A1 | INTERNAL GLASS PUSHING CAP | 4 | PZ | VM2274A0 | GROOVED BUSHING | 1 | PZ | VM2275A0 | SMOOTH BUSHING | 1 | PZ | VM2456A0 | BAKERLUX SHOP.PRO HANDLE END | 2 | PZ | VM2456A0 | BAKERLUX SHOP.PRO HANDLE END | 2 | PZ | VM2465A0 | SP SIDE-OPENIN G DOOR RIGHT LOWER CAP KIT | 1 | PZ | VM2465A0 | SP SIDE-OPENIN G DOOR RIGHT LOWER CAP KIT | 1 | PZ | VM2466A0 | BL SP LEFT LOWER LATERAL DOOR CAP | 1 | PZ | VM2466A0 | BL SP LEFT LOWER LATERAL DOOR CAP | 1 | PZ | VM2467A0 | SP SIDE-OPENIN G DOOR RIGHT UPPER CAP KIT | 1 | PZ |
| Code | Description | Qty | UOM | | | | | | | | | | | | | | | | | | | | | | | | | | | | | | | | | | | | | | | | | | | | | | | | | | | | | | | | | | | | | | | | | | | | | | |
| VI1220A1 | 4,2X12 TCB SELF-TAPPIN G SCREW | 12 | PZ | | | | | | | | | | | | | | | | | | | | | | | | | | | | | | | | | | | | | | | | | | | | | | | | | | | | | | | | | | | | | | | | | | | | | | |
| VI1930A0 | 5X25 ST. STEEL SCREW CHIP | 22 | PZ | | | | | | | | | | | | | | | | | | | | | | | | | | | | | | | | | | | | | | | | | | | | | | | | | | | | | | | | | | | | | | | | | | | | | | |
| VI1998A0 | ZINC PLATED SCREW 5X30 TCB | 2 | PZ | | | | | | | | | | | | | | | | | | | | | | | | | | | | | | | | | | | | | | | | | | | | | | | | | | | | | | | | | | | | | | | | | | | | | | |
| VM1059A1 | HEAT SHRINK FILM H800 | 1.200 | M | | | | | | | | | | | | | | | | | | | | | | | | | | | | | | | | | | | | | | | | | | | | | | | | | | | | | | | | | | | | | | | | | | | | | | |
| VM1209A0 | SHOP.PRO LOCK PIN WASHER | 1 | PZ | | | | | | | | | | | | | | | | | | | | | | | | | | | | | | | | | | | | | | | | | | | | | | | | | | | | | | | | | | | | | | | | | | | | | | |
| VM1630A0 | INTERNAL GLASS PUSHING CAP | 4 | PZ | | | | | | | | | | | | | | | | | | | | | | | | | | | | | | | | | | | | | | | | | | | | | | | | | | | | | | | | | | | | | | | | | | | | | | |
| VM1630A1 | INTERNAL GLASS PUSHING CAP | 4 | PZ | | | | | | | | | | | | | | | | | | | | | | | | | | | | | | | | | | | | | | | | | | | | | | | | | | | | | | | | | | | | | | | | | | | | | | |
| VM2274A0 | GROOVED BUSHING | 1 | PZ | | | | | | | | | | | | | | | | | | | | | | | | | | | | | | | | | | | | | | | | | | | | | | | | | | | | | | | | | | | | | | | | | | | | | | |
| VM2275A0 | SMOOTH BUSHING | 1 | PZ | | | | | | | | | | | | | | | | | | | | | | | | | | | | | | | | | | | | | | | | | | | | | | | | | | | | | | | | | | | | | | | | | | | | | | |
| VM2456A0 | BAKERLUX SHOP.PRO HANDLE END | 2 | PZ | | | | | | | | | | | | | | | | | | | | | | | | | | | | | | | | | | | | | | | | | | | | | | | | | | | | | | | | | | | | | | | | | | | | | | |
| VM2456A0 | BAKERLUX SHOP.PRO HANDLE END | 2 | PZ | | | | | | | | | | | | | | | | | | | | | | | | | | | | | | | | | | | | | | | | | | | | | | | | | | | | | | | | | | | | | | | | | | | | | | |
| VM2465A0 | SP SIDE-OPENIN G DOOR RIGHT LOWER CAP KIT | 1 | PZ | | | | | | | | | | | | | | | | | | | | | | | | | | | | | | | | | | | | | | | | | | | | | | | | | | | | | | | | | | | | | | | | | | | | | | |
| VM2465A0 | SP SIDE-OPENIN G DOOR RIGHT LOWER CAP KIT | 1 | PZ | | | | | | | | | | | | | | | | | | | | | | | | | | | | | | | | | | | | | | | | | | | | | | | | | | | | | | | | | | | | | | | | | | | | | | |
| VM2466A0 | BL SP LEFT LOWER LATERAL DOOR CAP | 1 | PZ | | | | | | | | | | | | | | | | | | | | | | | | | | | | | | | | | | | | | | | | | | | | | | | | | | | | | | | | | | | | | | | | | | | | | | |
| VM2466A0 | BL SP LEFT LOWER LATERAL DOOR CAP | 1 | PZ | | | | | | | | | | | | | | | | | | | | | | | | | | | | | | | | | | | | | | | | | | | | | | | | | | | | | | | | | | | | | | | | | | | | | | |
| VM2467A0 | SP SIDE-OPENIN G DOOR RIGHT UPPER CAP KIT | 1 | PZ | | | | | | | | | | | | | | | | | | | | | | | | | | | | | | | | | | | | | | | | | | | | | | | | | | | | | | | | | | | | | | | | | | | | | | |





| COMPONENT | | | SPARE PART | | | | | | | | | | | | | | | | | | | | | | | | | | | | | | | | | | | | | | | | | | | | | | | | | | | | | | | | | | |
|-----------|---|---|------------|---|--|------|-------------|-----|-----|----------|---|---|----|----------|--|---|----|----------|--|---|----|----------|---|---|----|----------|---|---|----|----------|--|---|----|----------|--|---|----|----------|--|---|----|----------|--|---|----|----------|---|---|----|----------|---|---|----|----------|---|---|----|----------|---|---|----|
| Code | Description | Image | Code | Description | Components list | | | | | | | | | | | | | | | | | | | | | | | | | | | | | | | | | | | | | | | | | | | | | | | | | | | | | | | | |
| VT1323A | SP STEFANIA 357X364X4 EXTERNAL GLASS |  | KDR1284A | BL SHOP.PRO STEFANIA EXTERNAL DOOR KI | <table border="1"> <thead> <tr> <th>Code</th> <th>Description</th> <th>Qty</th> <th>UOM</th> </tr> </thead> <tbody> <tr> <td>VM2467A0</td> <td>SP SIDE-OPENIN G DOOR RIGHT UPPER CAP KIT</td> <td>1</td> <td>PZ</td> </tr> <tr> <td>VM2468A0</td> <td>BL SP LEFT UPPER LATERAL DOOR CAP</td> <td>1</td> <td>PZ</td> </tr> <tr> <td>VM2468A0</td> <td>BL SP LEFT UPPER LATERAL DOOR CAP</td> <td>1</td> <td>PZ</td> </tr> <tr> <td>VM2470A0</td> <td>SLIDE TO FIX INTERNAL GLASS SHOP.PRO</td> <td>2</td> <td>PZ</td> </tr> <tr> <td>VM2470A0</td> <td>SLIDE TO FIX INTERNAL GLASS SHOP.PRO</td> <td>2</td> <td>PZ</td> </tr> <tr> <td>VM2471A0</td> <td>BL SP LOWER CLAMP INT LOCK GLASS SLIDER</td> <td>1</td> <td>PZ</td> </tr> <tr> <td>VM2471A0</td> <td>BL SP LOWER CLAMP INT LOCK GLASS SLIDER</td> <td>1</td> <td>PZ</td> </tr> <tr> <td>VM2472A0</td> <td>BL SP UPPER CLAMP INT LOCK GLASS SLIDER</td> <td>1</td> <td>PZ</td> </tr> <tr> <td>VM2472A0</td> <td>BL SP UPPER CLAMP INT LOCK GLASS SLIDER</td> <td>1</td> <td>PZ</td> </tr> <tr> <td>VM2473A0</td> <td>BL SP INT GLASS HINGE LOWER LOCK PIN</td> <td>1</td> <td>PZ</td> </tr> <tr> <td>VM2473A0</td> <td>BL SP INT GLASS HINGE LOWER LOCK PIN</td> <td>1</td> <td>PZ</td> </tr> <tr> <td>VM2474A0</td> <td>BL SP INT GLASS HINGE UPPER LOCK PIN</td> <td>1</td> <td>PZ</td> </tr> <tr> <td>VM2474A0</td> <td>BL SP INT GLASS HINGE UPPER LOCK PIN</td> <td>1</td> <td>PZ</td> </tr> </tbody> </table> | Code | Description | Qty | UOM | VM2467A0 | SP SIDE-OPENIN G DOOR RIGHT UPPER CAP KIT | 1 | PZ | VM2468A0 | BL SP LEFT UPPER LATERAL DOOR CAP | 1 | PZ | VM2468A0 | BL SP LEFT UPPER LATERAL DOOR CAP | 1 | PZ | VM2470A0 | SLIDE TO FIX INTERNAL GLASS SHOP.PRO | 2 | PZ | VM2470A0 | SLIDE TO FIX INTERNAL GLASS SHOP.PRO | 2 | PZ | VM2471A0 | BL SP LOWER CLAMP INT LOCK GLASS SLIDER | 1 | PZ | VM2471A0 | BL SP LOWER CLAMP INT LOCK GLASS SLIDER | 1 | PZ | VM2472A0 | BL SP UPPER CLAMP INT LOCK GLASS SLIDER | 1 | PZ | VM2472A0 | BL SP UPPER CLAMP INT LOCK GLASS SLIDER | 1 | PZ | VM2473A0 | BL SP INT GLASS HINGE LOWER LOCK PIN | 1 | PZ | VM2473A0 | BL SP INT GLASS HINGE LOWER LOCK PIN | 1 | PZ | VM2474A0 | BL SP INT GLASS HINGE UPPER LOCK PIN | 1 | PZ | VM2474A0 | BL SP INT GLASS HINGE UPPER LOCK PIN | 1 | PZ |
| Code | Description | Qty | UOM | | | | | | | | | | | | | | | | | | | | | | | | | | | | | | | | | | | | | | | | | | | | | | | | | | | | | | | | | | |
| VM2467A0 | SP SIDE-OPENIN G DOOR RIGHT UPPER CAP KIT | 1 | PZ | | | | | | | | | | | | | | | | | | | | | | | | | | | | | | | | | | | | | | | | | | | | | | | | | | | | | | | | | | |
| VM2468A0 | BL SP LEFT UPPER LATERAL DOOR CAP | 1 | PZ | | | | | | | | | | | | | | | | | | | | | | | | | | | | | | | | | | | | | | | | | | | | | | | | | | | | | | | | | | |
| VM2468A0 | BL SP LEFT UPPER LATERAL DOOR CAP | 1 | PZ | | | | | | | | | | | | | | | | | | | | | | | | | | | | | | | | | | | | | | | | | | | | | | | | | | | | | | | | | | |
| VM2470A0 | SLIDE TO FIX INTERNAL GLASS SHOP.PRO | 2 | PZ | | | | | | | | | | | | | | | | | | | | | | | | | | | | | | | | | | | | | | | | | | | | | | | | | | | | | | | | | | |
| VM2470A0 | SLIDE TO FIX INTERNAL GLASS SHOP.PRO | 2 | PZ | | | | | | | | | | | | | | | | | | | | | | | | | | | | | | | | | | | | | | | | | | | | | | | | | | | | | | | | | | |
| VM2471A0 | BL SP LOWER CLAMP INT LOCK GLASS SLIDER | 1 | PZ | | | | | | | | | | | | | | | | | | | | | | | | | | | | | | | | | | | | | | | | | | | | | | | | | | | | | | | | | | |
| VM2471A0 | BL SP LOWER CLAMP INT LOCK GLASS SLIDER | 1 | PZ | | | | | | | | | | | | | | | | | | | | | | | | | | | | | | | | | | | | | | | | | | | | | | | | | | | | | | | | | | |
| VM2472A0 | BL SP UPPER CLAMP INT LOCK GLASS SLIDER | 1 | PZ | | | | | | | | | | | | | | | | | | | | | | | | | | | | | | | | | | | | | | | | | | | | | | | | | | | | | | | | | | |
| VM2472A0 | BL SP UPPER CLAMP INT LOCK GLASS SLIDER | 1 | PZ | | | | | | | | | | | | | | | | | | | | | | | | | | | | | | | | | | | | | | | | | | | | | | | | | | | | | | | | | | |
| VM2473A0 | BL SP INT GLASS HINGE LOWER LOCK PIN | 1 | PZ | | | | | | | | | | | | | | | | | | | | | | | | | | | | | | | | | | | | | | | | | | | | | | | | | | | | | | | | | | |
| VM2473A0 | BL SP INT GLASS HINGE LOWER LOCK PIN | 1 | PZ | | | | | | | | | | | | | | | | | | | | | | | | | | | | | | | | | | | | | | | | | | | | | | | | | | | | | | | | | | |
| VM2474A0 | BL SP INT GLASS HINGE UPPER LOCK PIN | 1 | PZ | | | | | | | | | | | | | | | | | | | | | | | | | | | | | | | | | | | | | | | | | | | | | | | | | | | | | | | | | | |
| VM2474A0 | BL SP INT GLASS HINGE UPPER LOCK PIN | 1 | PZ | | | | | | | | | | | | | | | | | | | | | | | | | | | | | | | | | | | | | | | | | | | | | | | | | | | | | | | | | | |





| COMPONENT | | | SPARE PART | | | | | | | | | | | | | | | | | | | | | | | | | | | | | | | | | | | | | | | | | | | | | | | |
|-----------|---|--|------------|---|--|------|-------------|-----|-----|----------|--------------------------------------|---|----|----------|--------------------------------------|---|----|----------|--------------------------------------|---|----|----------|---|--|----|----------|---|---|-------|----------|----------------------|--|----|----------|---|------------------------------------|----|----------|---|-------------------------------|----|----|----------|--|---|----|----------|---|---|----|
| Code | Description | Image | Code | Description | Components list | | | | | | | | | | | | | | | | | | | | | | | | | | | | | | | | | | | | | | | | | | | | | |
| VT1323A | SP STEFANIA 357X364X4 EXTERNAL GLASS |  | KDR1284A | BL SHOP.PRO STEFANIA EXTERNAL DOOR KI | <table border="1"> <thead> <tr> <th>Code</th> <th>Description</th> <th>Qty</th> <th>UOM</th> </tr> </thead> <tbody> <tr> <td>VM2478A0</td> <td>BL SP GLASS H4 PUSHING BRACKET</td> <td>4</td> <td>PZ</td> </tr> <tr> <td>VM2478A0</td> <td>BL SP GLASS H4 PUSHING BRACKET</td> <td>4</td> <td>PZ</td> </tr> <tr> <td>VM2489A0</td> <td>SP HANDLE END KIT + STYLUS KIT</td> <td>1</td> <td>PZ</td> </tr> <tr> <td>VM2504A0</td> <td>DOWEL TO GUIDE SLIDE SPRING SHOP.PRO</td> <td>2</td> <td>PZ</td> </tr> <tr> <td>VM2504A0</td> <td>DOWEL TO GUIDE SLIDE SPRING SHOP.PRO</td> <td>2</td> <td>PZ</td> </tr> <tr> <td>VM2527A0</td> <td>STYLUS PEN FOR SP</td> <td>1</td> <td>PZ</td> </tr> <tr> <td>VT1323A0</td> <td>SP STEFANIA 357X364X4 EXTERNAL GLASS</td> <td>1</td> <td>PZ</td> </tr> <tr> <td>VT1323A0</td> <td>SP STEFANIA 357X364X4 EXTERNAL GLASS</td> <td>1</td> <td>PZ</td> </tr> </tbody> </table> | Code | Description | Qty | UOM | VM2478A0 | BL SP GLASS H4 PUSHING BRACKET | 4 | PZ | VM2478A0 | BL SP GLASS H4 PUSHING BRACKET | 4 | PZ | VM2489A0 | SP HANDLE END KIT + STYLUS KIT | 1 | PZ | VM2504A0 | DOWEL TO GUIDE SLIDE SPRING SHOP.PRO | 2 | PZ | VM2504A0 | DOWEL TO GUIDE SLIDE SPRING SHOP.PRO | 2 | PZ | VM2527A0 | STYLUS PEN FOR SP | 1 | PZ | VT1323A0 | SP STEFANIA 357X364X4 EXTERNAL GLASS | 1 | PZ | VT1323A0 | SP STEFANIA 357X364X4 EXTERNAL GLASS | 1 | PZ | | | | | | | | | |
| | | | Code | Description | Qty | UOM | | | | | | | | | | | | | | | | | | | | | | | | | | | | | | | | | | | | | | | | | | | | |
| VM2478A0 | BL SP GLASS H4 PUSHING BRACKET | 4 | PZ | | | | | | | | | | | | | | | | | | | | | | | | | | | | | | | | | | | | | | | | | | | | | | | |
| VM2478A0 | BL SP GLASS H4 PUSHING BRACKET | 4 | PZ | | | | | | | | | | | | | | | | | | | | | | | | | | | | | | | | | | | | | | | | | | | | | | | |
| VM2489A0 | SP HANDLE END KIT + STYLUS KIT | 1 | PZ | | | | | | | | | | | | | | | | | | | | | | | | | | | | | | | | | | | | | | | | | | | | | | | |
| VM2504A0 | DOWEL TO GUIDE SLIDE SPRING SHOP.PRO | 2 | PZ | | | | | | | | | | | | | | | | | | | | | | | | | | | | | | | | | | | | | | | | | | | | | | | |
| VM2504A0 | DOWEL TO GUIDE SLIDE SPRING SHOP.PRO | 2 | PZ | | | | | | | | | | | | | | | | | | | | | | | | | | | | | | | | | | | | | | | | | | | | | | | |
| VM2527A0 | STYLUS PEN FOR SP | 1 | PZ | | | | | | | | | | | | | | | | | | | | | | | | | | | | | | | | | | | | | | | | | | | | | | | |
| VT1323A0 | SP STEFANIA 357X364X4 EXTERNAL GLASS | 1 | PZ | | | | | | | | | | | | | | | | | | | | | | | | | | | | | | | | | | | | | | | | | | | | | | | |
| VT1323A0 | SP STEFANIA 357X364X4 EXTERNAL GLASS | 1 | PZ | | | | | | | | | | | | | | | | | | | | | | | | | | | | | | | | | | | | | | | | | | | | | | | |
| KDR1280A | BL SHOP.PRO STEFANIA COMPLETE DOOR KIT | <table border="1"> <thead> <tr> <th>Code</th> <th>Description</th> <th>Qty</th> <th>UOM</th> </tr> </thead> <tbody> <tr> <td>0B1285A0</td> <td></td> <td>1</td> <td>PZ</td> </tr> <tr> <td>0B1286A0</td> <td></td> <td>1</td> <td>PZ</td> </tr> <tr> <td>0B1287A0</td> <td></td> <td>1</td> <td>PZ</td> </tr> <tr> <td>0B1288A0</td> <td></td> <td>1</td> <td>PZ</td> </tr> <tr> <td>CR1111A0</td> <td>BLSP STEFANIA DROPDOWN DOOR HINGE</td> <td>2</td> <td>PZ</td> </tr> <tr> <td>IP1508A1</td> <td>POLYSTYREN E U SHAPED PROFILE 2000X60X60</td> <td>1.500</td> <td>M</td> </tr> <tr> <td>LP1050A0</td> <td>BL SHOP.PRO L180 COMPLETE LED BAR</td> <td>1</td> <td>PZ</td> </tr> <tr> <td>SL1155A1</td> <td>LOCTITE BICOMPONEN T SILICON</td> <td>14</td> <td>ML</td> </tr> <tr> <td>TB1562A0</td> <td>DOOR LATERAL BEAM SP600</td> <td>1</td> <td>PZ</td> </tr> <tr> <td>TB3301A0</td> <td></td> <td>1</td> <td>PZ</td> </tr> <tr> <td>V11014A0</td> <td>STAINLESS STEEL WASHER 4.5X9X0.8</td> <td>1</td> <td>PZ</td> </tr> </tbody> </table> | Code | Description | Qty | UOM | 0B1285A0 | | 1 | PZ | 0B1286A0 | | 1 | PZ | 0B1287A0 | | 1 | PZ | 0B1288A0 | | 1 | PZ | CR1111A0 | BLSP STEFANIA DROPDOWN DOOR HINGE | 2 | PZ | IP1508A1 | POLYSTYREN E U SHAPED PROFILE 2000X60X60 | 1.500 | M | LP1050A0 | BL SHOP.PRO L180 COMPLETE LED BAR | 1 | PZ | SL1155A1 | LOCTITE BICOMPONEN T SILICON | 14 | ML | TB1562A0 | DOOR LATERAL BEAM SP600 | 1 | PZ | TB3301A0 | | 1 | PZ | V11014A0 | STAINLESS STEEL WASHER 4.5X9X0.8 | 1 | PZ |
| Code | Description | Qty | UOM | | | | | | | | | | | | | | | | | | | | | | | | | | | | | | | | | | | | | | | | | | | | | | | |
| 0B1285A0 | | 1 | PZ | | | | | | | | | | | | | | | | | | | | | | | | | | | | | | | | | | | | | | | | | | | | | | | |
| 0B1286A0 | | 1 | PZ | | | | | | | | | | | | | | | | | | | | | | | | | | | | | | | | | | | | | | | | | | | | | | | |
| 0B1287A0 | | 1 | PZ | | | | | | | | | | | | | | | | | | | | | | | | | | | | | | | | | | | | | | | | | | | | | | | |
| 0B1288A0 | | 1 | PZ | | | | | | | | | | | | | | | | | | | | | | | | | | | | | | | | | | | | | | | | | | | | | | | |
| CR1111A0 | BLSP STEFANIA DROPDOWN DOOR HINGE | 2 | PZ | | | | | | | | | | | | | | | | | | | | | | | | | | | | | | | | | | | | | | | | | | | | | | | |
| IP1508A1 | POLYSTYREN E U SHAPED PROFILE 2000X60X60 | 1.500 | M | | | | | | | | | | | | | | | | | | | | | | | | | | | | | | | | | | | | | | | | | | | | | | | |
| LP1050A0 | BL SHOP.PRO L180 COMPLETE LED BAR | 1 | PZ | | | | | | | | | | | | | | | | | | | | | | | | | | | | | | | | | | | | | | | | | | | | | | | |
| SL1155A1 | LOCTITE BICOMPONEN T SILICON | 14 | ML | | | | | | | | | | | | | | | | | | | | | | | | | | | | | | | | | | | | | | | | | | | | | | | |
| TB1562A0 | DOOR LATERAL BEAM SP600 | 1 | PZ | | | | | | | | | | | | | | | | | | | | | | | | | | | | | | | | | | | | | | | | | | | | | | | |
| TB3301A0 | | 1 | PZ | | | | | | | | | | | | | | | | | | | | | | | | | | | | | | | | | | | | | | | | | | | | | | | |
| V11014A0 | STAINLESS STEEL WASHER 4.5X9X0.8 | 1 | PZ | | | | | | | | | | | | | | | | | | | | | | | | | | | | | | | | | | | | | | | | | | | | | | | |

| COMPONENT | | | SPARE PART | | | | | | | | | | | | | | | | | | | | | | | | | | | | | | | | | | | | | | | | | | | | | | | | | | | | | | | | | | | | | | | | | | | | | | |
|-----------|--|---|------------|---|---|------|-------------|-----|-----|----------|--------------------------------------|----|----|----------|----------------------------|---|----|----------|---------------------------------|----|----|----------|----------------------------------|---|----|----------|--------------------------|-------|---|----------|----------------------------------|---|----|----------|----------------------------------|---|----|----------|------------------------------------|---|----|----------|------------------------------------|---|----|----------|--|---|----|----------|--|---|----|----------|---|---|----|----------|---|---|----|----------|--|---|----|----------|--|---|----|----------|---|---|----|
| Code | Description | Image | Code | Description | Components list | | | | | | | | | | | | | | | | | | | | | | | | | | | | | | | | | | | | | | | | | | | | | | | | | | | | | | | | | | | | | | | | | | | | |
| VT1323A | SP STEFANIA 357X364X4 EXTERNAL GLASS |  | KDR1280A | BL SHOP.PRO STEFANIA COMPLETE DOOR KIT | <table border="1"> <thead> <tr> <th>Code</th> <th>Description</th> <th>Qty</th> <th>UOM</th> </tr> </thead> <tbody> <tr> <td>VI1220A1</td> <td>4,2X12 TCB SELF-TAPPIN G SCREW</td> <td>10</td> <td>PZ</td> </tr> <tr> <td>VI1875A0</td> <td>SCREW M5X10 TC1/2T INOX</td> <td>6</td> <td>PZ</td> </tr> <tr> <td>VI1930A0</td> <td>5X25 ST. STEEL SCREW CHIP</td> <td>12</td> <td>PZ</td> </tr> <tr> <td>VI1998A0</td> <td>ZINC PLATED SCREW 5X30 TCB</td> <td>2</td> <td>PZ</td> </tr> <tr> <td>VM1059A1</td> <td>HEAT SHRINK FILM H800</td> <td>0.500</td> <td>M</td> </tr> <tr> <td>VM1630A0</td> <td>INTERNAL GLASS PUSHING CAP</td> <td>1</td> <td>PZ</td> </tr> <tr> <td>VM1630A1</td> <td>INTERNAL GLASS PUSHING CAP</td> <td>1</td> <td>PZ</td> </tr> <tr> <td>VM2456A0</td> <td>BAKERLUX SHOP.PRO HANDLE END</td> <td>2</td> <td>PZ</td> </tr> <tr> <td>VM2456A0</td> <td>BAKERLUX SHOP.PRO HANDLE END</td> <td>2</td> <td>PZ</td> </tr> <tr> <td>VM2461A0</td> <td>BL SP RIGHT LOWER DROPDOWN DOOR CAP KIT</td> <td>1</td> <td>PZ</td> </tr> <tr> <td>VM2461A0</td> <td>BL SP RIGHT LOWER DROPDOWN DOOR CAP KIT</td> <td>1</td> <td>PZ</td> </tr> <tr> <td>VM2462A0</td> <td>BL SP LEFT LOWER DROPDOWN DOOR CAP</td> <td>1</td> <td>PZ</td> </tr> <tr> <td>VM2462A0</td> <td>BL SP LEFT LOWER DROPDOWN DOOR CAP</td> <td>1</td> <td>PZ</td> </tr> <tr> <td>VM2463A0</td> <td>SHOP.PRO RIGHT UPPER CAP DROP DOWN DOOR</td> <td>1</td> <td>PZ</td> </tr> <tr> <td>VM2463A0</td> <td>SHOP.PRO RIGHT UPPER CAP DROP DOWN DOOR</td> <td>1</td> <td>PZ</td> </tr> <tr> <td>VM2464A0</td> <td>SHOP.PRO LEFT UPPER CAP DROP DOWN DOOR</td> <td>1</td> <td>PZ</td> </tr> </tbody> </table> | Code | Description | Qty | UOM | VI1220A1 | 4,2X12 TCB SELF-TAPPIN G SCREW | 10 | PZ | VI1875A0 | SCREW M5X10 TC1/2T INOX | 6 | PZ | VI1930A0 | 5X25 ST. STEEL SCREW CHIP | 12 | PZ | VI1998A0 | ZINC PLATED SCREW 5X30 TCB | 2 | PZ | VM1059A1 | HEAT SHRINK FILM H800 | 0.500 | M | VM1630A0 | INTERNAL GLASS PUSHING CAP | 1 | PZ | VM1630A1 | INTERNAL GLASS PUSHING CAP | 1 | PZ | VM2456A0 | BAKERLUX SHOP.PRO HANDLE END | 2 | PZ | VM2456A0 | BAKERLUX SHOP.PRO HANDLE END | 2 | PZ | VM2461A0 | BL SP RIGHT LOWER DROPDOWN DOOR CAP KIT | 1 | PZ | VM2461A0 | BL SP RIGHT LOWER DROPDOWN DOOR CAP KIT | 1 | PZ | VM2462A0 | BL SP LEFT LOWER DROPDOWN DOOR CAP | 1 | PZ | VM2462A0 | BL SP LEFT LOWER DROPDOWN DOOR CAP | 1 | PZ | VM2463A0 | SHOP.PRO RIGHT UPPER CAP DROP DOWN DOOR | 1 | PZ | VM2463A0 | SHOP.PRO RIGHT UPPER CAP DROP DOWN DOOR | 1 | PZ | VM2464A0 | SHOP.PRO LEFT UPPER CAP DROP DOWN DOOR | 1 | PZ |
| Code | Description | Qty | UOM | | | | | | | | | | | | | | | | | | | | | | | | | | | | | | | | | | | | | | | | | | | | | | | | | | | | | | | | | | | | | | | | | | | | | | |
| VI1220A1 | 4,2X12 TCB SELF-TAPPIN G SCREW | 10 | PZ | | | | | | | | | | | | | | | | | | | | | | | | | | | | | | | | | | | | | | | | | | | | | | | | | | | | | | | | | | | | | | | | | | | | | | |
| VI1875A0 | SCREW M5X10 TC1/2T INOX | 6 | PZ | | | | | | | | | | | | | | | | | | | | | | | | | | | | | | | | | | | | | | | | | | | | | | | | | | | | | | | | | | | | | | | | | | | | | | |
| VI1930A0 | 5X25 ST. STEEL SCREW CHIP | 12 | PZ | | | | | | | | | | | | | | | | | | | | | | | | | | | | | | | | | | | | | | | | | | | | | | | | | | | | | | | | | | | | | | | | | | | | | | |
| VI1998A0 | ZINC PLATED SCREW 5X30 TCB | 2 | PZ | | | | | | | | | | | | | | | | | | | | | | | | | | | | | | | | | | | | | | | | | | | | | | | | | | | | | | | | | | | | | | | | | | | | | | |
| VM1059A1 | HEAT SHRINK FILM H800 | 0.500 | M | | | | | | | | | | | | | | | | | | | | | | | | | | | | | | | | | | | | | | | | | | | | | | | | | | | | | | | | | | | | | | | | | | | | | | |
| VM1630A0 | INTERNAL GLASS PUSHING CAP | 1 | PZ | | | | | | | | | | | | | | | | | | | | | | | | | | | | | | | | | | | | | | | | | | | | | | | | | | | | | | | | | | | | | | | | | | | | | | |
| VM1630A1 | INTERNAL GLASS PUSHING CAP | 1 | PZ | | | | | | | | | | | | | | | | | | | | | | | | | | | | | | | | | | | | | | | | | | | | | | | | | | | | | | | | | | | | | | | | | | | | | | |
| VM2456A0 | BAKERLUX SHOP.PRO HANDLE END | 2 | PZ | | | | | | | | | | | | | | | | | | | | | | | | | | | | | | | | | | | | | | | | | | | | | | | | | | | | | | | | | | | | | | | | | | | | | | |
| VM2456A0 | BAKERLUX SHOP.PRO HANDLE END | 2 | PZ | | | | | | | | | | | | | | | | | | | | | | | | | | | | | | | | | | | | | | | | | | | | | | | | | | | | | | | | | | | | | | | | | | | | | | |
| VM2461A0 | BL SP RIGHT LOWER DROPDOWN DOOR CAP KIT | 1 | PZ | | | | | | | | | | | | | | | | | | | | | | | | | | | | | | | | | | | | | | | | | | | | | | | | | | | | | | | | | | | | | | | | | | | | | | |
| VM2461A0 | BL SP RIGHT LOWER DROPDOWN DOOR CAP KIT | 1 | PZ | | | | | | | | | | | | | | | | | | | | | | | | | | | | | | | | | | | | | | | | | | | | | | | | | | | | | | | | | | | | | | | | | | | | | | |
| VM2462A0 | BL SP LEFT LOWER DROPDOWN DOOR CAP | 1 | PZ | | | | | | | | | | | | | | | | | | | | | | | | | | | | | | | | | | | | | | | | | | | | | | | | | | | | | | | | | | | | | | | | | | | | | | |
| VM2462A0 | BL SP LEFT LOWER DROPDOWN DOOR CAP | 1 | PZ | | | | | | | | | | | | | | | | | | | | | | | | | | | | | | | | | | | | | | | | | | | | | | | | | | | | | | | | | | | | | | | | | | | | | | |
| VM2463A0 | SHOP.PRO RIGHT UPPER CAP DROP DOWN DOOR | 1 | PZ | | | | | | | | | | | | | | | | | | | | | | | | | | | | | | | | | | | | | | | | | | | | | | | | | | | | | | | | | | | | | | | | | | | | | | |
| VM2463A0 | SHOP.PRO RIGHT UPPER CAP DROP DOWN DOOR | 1 | PZ | | | | | | | | | | | | | | | | | | | | | | | | | | | | | | | | | | | | | | | | | | | | | | | | | | | | | | | | | | | | | | | | | | | | | | |
| VM2464A0 | SHOP.PRO LEFT UPPER CAP DROP DOWN DOOR | 1 | PZ | | | | | | | | | | | | | | | | | | | | | | | | | | | | | | | | | | | | | | | | | | | | | | | | | | | | | | | | | | | | | | | | | | | | | | |

| COMPONENT | | | SPARE PART | | | | | | | | | | | | | | | | | | | | | | | | | | | | | | | | | | | | | | | | | | | | | | | | | | | | | | | | | | | | | | | | | | |
|-----------|---|---|------------|---|--|------|-------------|-----|-----|----------|---|---|----|----------|--|---|----|----------|--|---|----|----------|--|---|----|----------|--|---|----|----------|--------------------------------------|---|----|----------|--------------------------------------|---|----|----------|--------------------------------------|---|----|----------|---|---|----|----------|---|---|----|----------|---|---|----|----------|---|---|----|----------|----------------------|---|----|----------|---|---|----|----------|---|---|----|
| Code | Description | Image | Code | Description | Components list | | | | | | | | | | | | | | | | | | | | | | | | | | | | | | | | | | | | | | | | | | | | | | | | | | | | | | | | | | | | | | | | |
| VT1323A | SP STEFANIA 357X364X4 EXTERNAL GLASS |  | KDR1280A | BL SHOP.PRO STEFANIA COMPLETE DOOR KIT | <table border="1"> <thead> <tr> <th>Code</th> <th>Description</th> <th>Qty</th> <th>UOM</th> </tr> </thead> <tbody> <tr> <td>VM2464A0</td> <td>SHOP.PRO LEFT UPPER CAP DROP DOWN DOOR</td> <td>1</td> <td>PZ</td> </tr> <tr> <td>VM2471A0</td> <td>BL SP LOWER CLAMP INT LOCK GLASS SLIDER</td> <td>1</td> <td>PZ</td> </tr> <tr> <td>VM2471A0</td> <td>BL SP LOWER CLAMP INT LOCK GLASS SLIDER</td> <td>1</td> <td>PZ</td> </tr> <tr> <td>VM2472A0</td> <td>BL SP UPPER CLAMP INT LOCK GLASS SLIDER</td> <td>1</td> <td>PZ</td> </tr> <tr> <td>VM2472A0</td> <td>BL SP UPPER CLAMP INT LOCK GLASS SLIDER</td> <td>1</td> <td>PZ</td> </tr> <tr> <td>VM2478A0</td> <td>BL SP GLASS H4 PUSHING BRACKET</td> <td>1</td> <td>PZ</td> </tr> <tr> <td>VM2478A0</td> <td>BL SP GLASS H4 PUSHING BRACKET</td> <td>1</td> <td>PZ</td> </tr> <tr> <td>VM2489A0</td> <td>SP HANDLE END KIT + STYLUS KIT</td> <td>1</td> <td>PZ</td> </tr> <tr> <td>VM2503A0</td> <td>SLIDE TO FIX INTERNAL NON REMOV GLASS SP</td> <td>2</td> <td>PZ</td> </tr> <tr> <td>VM2503A0</td> <td>SLIDE TO FIX INTERNAL NON REMOV GLASS SP</td> <td>2</td> <td>PZ</td> </tr> <tr> <td>VM2512A0</td> <td>BL SP DOOR-MICRO SWITCH SOFT CLOSING</td> <td>1</td> <td>PZ</td> </tr> <tr> <td>VM2512A0</td> <td>BL SP DOOR-MICRO SWITCH SOFT CLOSING</td> <td>1</td> <td>PZ</td> </tr> <tr> <td>VM2527A0</td> <td>STYLUS PEN FOR SP</td> <td>1</td> <td>PZ</td> </tr> <tr> <td>VT1323A0</td> <td>SP STEFANIA 357X364X4 EXTERNAL GLASS</td> <td>1</td> <td>PZ</td> </tr> <tr> <td>VT1323A0</td> <td>SP STEFANIA 357X364X4 EXTERNAL GLASS</td> <td>1</td> <td>PZ</td> </tr> </tbody> </table> | Code | Description | Qty | UOM | VM2464A0 | SHOP.PRO LEFT UPPER CAP DROP DOWN DOOR | 1 | PZ | VM2471A0 | BL SP LOWER CLAMP INT LOCK GLASS SLIDER | 1 | PZ | VM2471A0 | BL SP LOWER CLAMP INT LOCK GLASS SLIDER | 1 | PZ | VM2472A0 | BL SP UPPER CLAMP INT LOCK GLASS SLIDER | 1 | PZ | VM2472A0 | BL SP UPPER CLAMP INT LOCK GLASS SLIDER | 1 | PZ | VM2478A0 | BL SP GLASS H4 PUSHING BRACKET | 1 | PZ | VM2478A0 | BL SP GLASS H4 PUSHING BRACKET | 1 | PZ | VM2489A0 | SP HANDLE END KIT + STYLUS KIT | 1 | PZ | VM2503A0 | SLIDE TO FIX INTERNAL NON REMOV GLASS SP | 2 | PZ | VM2503A0 | SLIDE TO FIX INTERNAL NON REMOV GLASS SP | 2 | PZ | VM2512A0 | BL SP DOOR-MICRO SWITCH SOFT CLOSING | 1 | PZ | VM2512A0 | BL SP DOOR-MICRO SWITCH SOFT CLOSING | 1 | PZ | VM2527A0 | STYLUS PEN FOR SP | 1 | PZ | VT1323A0 | SP STEFANIA 357X364X4 EXTERNAL GLASS | 1 | PZ | VT1323A0 | SP STEFANIA 357X364X4 EXTERNAL GLASS | 1 | PZ |
| Code | Description | Qty | UOM | | | | | | | | | | | | | | | | | | | | | | | | | | | | | | | | | | | | | | | | | | | | | | | | | | | | | | | | | | | | | | | | | | |
| VM2464A0 | SHOP.PRO LEFT UPPER CAP DROP DOWN DOOR | 1 | PZ | | | | | | | | | | | | | | | | | | | | | | | | | | | | | | | | | | | | | | | | | | | | | | | | | | | | | | | | | | | | | | | | | | |
| VM2471A0 | BL SP LOWER CLAMP INT LOCK GLASS SLIDER | 1 | PZ | | | | | | | | | | | | | | | | | | | | | | | | | | | | | | | | | | | | | | | | | | | | | | | | | | | | | | | | | | | | | | | | | | |
| VM2471A0 | BL SP LOWER CLAMP INT LOCK GLASS SLIDER | 1 | PZ | | | | | | | | | | | | | | | | | | | | | | | | | | | | | | | | | | | | | | | | | | | | | | | | | | | | | | | | | | | | | | | | | | |
| VM2472A0 | BL SP UPPER CLAMP INT LOCK GLASS SLIDER | 1 | PZ | | | | | | | | | | | | | | | | | | | | | | | | | | | | | | | | | | | | | | | | | | | | | | | | | | | | | | | | | | | | | | | | | | |
| VM2472A0 | BL SP UPPER CLAMP INT LOCK GLASS SLIDER | 1 | PZ | | | | | | | | | | | | | | | | | | | | | | | | | | | | | | | | | | | | | | | | | | | | | | | | | | | | | | | | | | | | | | | | | | |
| VM2478A0 | BL SP GLASS H4 PUSHING BRACKET | 1 | PZ | | | | | | | | | | | | | | | | | | | | | | | | | | | | | | | | | | | | | | | | | | | | | | | | | | | | | | | | | | | | | | | | | | |
| VM2478A0 | BL SP GLASS H4 PUSHING BRACKET | 1 | PZ | | | | | | | | | | | | | | | | | | | | | | | | | | | | | | | | | | | | | | | | | | | | | | | | | | | | | | | | | | | | | | | | | | |
| VM2489A0 | SP HANDLE END KIT + STYLUS KIT | 1 | PZ | | | | | | | | | | | | | | | | | | | | | | | | | | | | | | | | | | | | | | | | | | | | | | | | | | | | | | | | | | | | | | | | | | |
| VM2503A0 | SLIDE TO FIX INTERNAL NON REMOV GLASS SP | 2 | PZ | | | | | | | | | | | | | | | | | | | | | | | | | | | | | | | | | | | | | | | | | | | | | | | | | | | | | | | | | | | | | | | | | | |
| VM2503A0 | SLIDE TO FIX INTERNAL NON REMOV GLASS SP | 2 | PZ | | | | | | | | | | | | | | | | | | | | | | | | | | | | | | | | | | | | | | | | | | | | | | | | | | | | | | | | | | | | | | | | | | |
| VM2512A0 | BL SP DOOR-MICRO SWITCH SOFT CLOSING | 1 | PZ | | | | | | | | | | | | | | | | | | | | | | | | | | | | | | | | | | | | | | | | | | | | | | | | | | | | | | | | | | | | | | | | | | |
| VM2512A0 | BL SP DOOR-MICRO SWITCH SOFT CLOSING | 1 | PZ | | | | | | | | | | | | | | | | | | | | | | | | | | | | | | | | | | | | | | | | | | | | | | | | | | | | | | | | | | | | | | | | | | |
| VM2527A0 | STYLUS PEN FOR SP | 1 | PZ | | | | | | | | | | | | | | | | | | | | | | | | | | | | | | | | | | | | | | | | | | | | | | | | | | | | | | | | | | | | | | | | | | |
| VT1323A0 | SP STEFANIA 357X364X4 EXTERNAL GLASS | 1 | PZ | | | | | | | | | | | | | | | | | | | | | | | | | | | | | | | | | | | | | | | | | | | | | | | | | | | | | | | | | | | | | | | | | | |
| VT1323A0 | SP STEFANIA 357X364X4 EXTERNAL GLASS | 1 | PZ | | | | | | | | | | | | | | | | | | | | | | | | | | | | | | | | | | | | | | | | | | | | | | | | | | | | | | | | | | | | | | | | | | |

| COMPONENT | | | SPARE PART | | | | | | | | | | | | | | | | | | | | | | | | | | | | | | |
|-----------|---|---|------------|---|---|------|-------------|-----|-----|----------|---|-------|----|----------|---|-------|----|----------|---|---|----|----------|---|---|----|----------|--------------------------------------|---|----|----------|----------------------|---|----|
| Code | Description | Image | Code | Description | Components list | | | | | | | | | | | | | | | | | | | | | | | | | | | | |
| VT1323A | SP STEFANIA 357X364X4 EXTERNAL GLASS |  | KDR1280A | BL SHOP.PRO STEFANIA COMPLETE DOOR KIT | <table border="1"> <thead> <tr> <th>Code</th> <th>Description</th> <th>Qty</th> <th>UOM</th> </tr> </thead> <tbody> <tr> <td>VT1329A0</td> <td>SP STEFANIA 515X318.5X4 INNER GLASS</td> <td>1</td> <td>PZ</td> </tr> <tr> <td>VT1329A0</td> <td>SP STEFANIA 515X318.5X4 INNER GLASS</td> <td>1</td> <td>PZ</td> </tr> </tbody> </table> | Code | Description | Qty | UOM | VT1329A0 | SP STEFANIA 515X318.5X4 INNER GLASS | 1 | PZ | VT1329A0 | SP STEFANIA 515X318.5X4 INNER GLASS | 1 | PZ | | | | | | | | | | | | | | | | |
| Code | Description | Qty | UOM | | | | | | | | | | | | | | | | | | | | | | | | | | | | | | |
| VT1329A0 | SP STEFANIA 515X318.5X4 INNER GLASS | 1 | PZ | | | | | | | | | | | | | | | | | | | | | | | | | | | | | | |
| VT1329A0 | SP STEFANIA 515X318.5X4 INNER GLASS | 1 | PZ | | | | | | | | | | | | | | | | | | | | | | | | | | | | | | |
| VT1329A | SP STEFANIA 515X318.5X4 INNER GLASS |  | KVT1329A | BL SP STEFANIA INTERNAL DOOR GLASS KIT | <table border="1"> <thead> <tr> <th>Code</th> <th>Description</th> <th>Qty</th> <th>UOM</th> </tr> </thead> <tbody> <tr> <td>IP1508A1</td> <td>POLYSTYREN E U SHAPED PROFILE 2000X60X60</td> <td>0.800</td> <td>M</td> </tr> <tr> <td>VM1059A1</td> <td>HEAT SHRINK FILM H800</td> <td>1.200</td> <td>M</td> </tr> <tr> <td>VT1329A0</td> <td>SP STEFANIA 515X318.5X4 INNER GLASS</td> <td>1</td> <td>PZ</td> </tr> <tr> <td>VT1329A0</td> <td>SP STEFANIA 515X318.5X4 INNER GLASS</td> <td>1</td> <td>PZ</td> </tr> </tbody> </table> | Code | Description | Qty | UOM | IP1508A1 | POLYSTYREN E U SHAPED PROFILE 2000X60X60 | 0.800 | M | VM1059A1 | HEAT SHRINK FILM H800 | 1.200 | M | VT1329A0 | SP STEFANIA 515X318.5X4 INNER GLASS | 1 | PZ | VT1329A0 | SP STEFANIA 515X318.5X4 INNER GLASS | 1 | PZ | | | | | | | | |
| Code | Description | Qty | UOM | | | | | | | | | | | | | | | | | | | | | | | | | | | | | | |
| IP1508A1 | POLYSTYREN E U SHAPED PROFILE 2000X60X60 | 0.800 | M | | | | | | | | | | | | | | | | | | | | | | | | | | | | | | |
| VM1059A1 | HEAT SHRINK FILM H800 | 1.200 | M | | | | | | | | | | | | | | | | | | | | | | | | | | | | | | |
| VT1329A0 | SP STEFANIA 515X318.5X4 INNER GLASS | 1 | PZ | | | | | | | | | | | | | | | | | | | | | | | | | | | | | | |
| VT1329A0 | SP STEFANIA 515X318.5X4 INNER GLASS | 1 | PZ | | | | | | | | | | | | | | | | | | | | | | | | | | | | | | |
| TB3301A | |  | KTB3301A | BL SP 460X330 DROPDOWN HANDLE TUBE KIT | <table border="1"> <thead> <tr> <th>Code</th> <th>Description</th> <th>Qty</th> <th>UOM</th> </tr> </thead> <tbody> <tr> <td>TB3301A0</td> <td></td> <td>1</td> <td>PZ</td> </tr> <tr> <td>V11930A0</td> <td>5X25 ST. STEEL SCREW CHIP</td> <td>4</td> <td>PZ</td> </tr> <tr> <td>VM2456A0</td> <td>BAKERLUX SHOP.PRO HANDLE END</td> <td>2</td> <td>PZ</td> </tr> <tr> <td>VM2456A0</td> <td>BAKERLUX SHOP.PRO HANDLE END</td> <td>2</td> <td>PZ</td> </tr> <tr> <td>VM2489A0</td> <td>SP HANDLE END KIT + STYLUS KIT</td> <td>1</td> <td>PZ</td> </tr> <tr> <td>VM2527A0</td> <td>STYLUS PEN FOR SP</td> <td>1</td> <td>PZ</td> </tr> </tbody> </table> | Code | Description | Qty | UOM | TB3301A0 | | 1 | PZ | V11930A0 | 5X25 ST. STEEL SCREW CHIP | 4 | PZ | VM2456A0 | BAKERLUX SHOP.PRO HANDLE END | 2 | PZ | VM2456A0 | BAKERLUX SHOP.PRO HANDLE END | 2 | PZ | VM2489A0 | SP HANDLE END KIT + STYLUS KIT | 1 | PZ | VM2527A0 | STYLUS PEN FOR SP | 1 | PZ |
| Code | Description | Qty | UOM | | | | | | | | | | | | | | | | | | | | | | | | | | | | | | |
| TB3301A0 | | 1 | PZ | | | | | | | | | | | | | | | | | | | | | | | | | | | | | | |
| V11930A0 | 5X25 ST. STEEL SCREW CHIP | 4 | PZ | | | | | | | | | | | | | | | | | | | | | | | | | | | | | | |
| VM2456A0 | BAKERLUX SHOP.PRO HANDLE END | 2 | PZ | | | | | | | | | | | | | | | | | | | | | | | | | | | | | | |
| VM2456A0 | BAKERLUX SHOP.PRO HANDLE END | 2 | PZ | | | | | | | | | | | | | | | | | | | | | | | | | | | | | | |
| VM2489A0 | SP HANDLE END KIT + STYLUS KIT | 1 | PZ | | | | | | | | | | | | | | | | | | | | | | | | | | | | | | |
| VM2527A0 | STYLUS PEN FOR SP | 1 | PZ | | | | | | | | | | | | | | | | | | | | | | | | | | | | | | |
| VM2456A | BAKERLUX SHOP.PRO HANDLE END |  | KVM2456A | 2 PCS BAKERLUX SHOP.PRO HANDLE END KIT | <table border="1"> <thead> <tr> <th>Code</th> <th>Description</th> <th>Qty</th> <th>UOM</th> </tr> </thead> <tbody> <tr> <td>V11930A0</td> <td>5X25 ST. STEEL SCREW CHIP</td> <td>4</td> <td>PZ</td> </tr> <tr> <td>VM1224A0</td> <td>65MY 220MM 2 COLOURS SHRINK TUBE</td> <td>0.300</td> <td>M</td> </tr> <tr> <td>VM2456A0</td> <td>BAKERLUX SHOP.PRO HANDLE END</td> <td>2</td> <td>PZ</td> </tr> <tr> <td>VM2456A0</td> <td>BAKERLUX SHOP.PRO HANDLE END</td> <td>2</td> <td>PZ</td> </tr> </tbody> </table> | Code | Description | Qty | UOM | V11930A0 | 5X25 ST. STEEL SCREW CHIP | 4 | PZ | VM1224A0 | 65MY 220MM 2 COLOURS SHRINK TUBE | 0.300 | M | VM2456A0 | BAKERLUX SHOP.PRO HANDLE END | 2 | PZ | VM2456A0 | BAKERLUX SHOP.PRO HANDLE END | 2 | PZ | | | | | | | | |
| Code | Description | Qty | UOM | | | | | | | | | | | | | | | | | | | | | | | | | | | | | | |
| V11930A0 | 5X25 ST. STEEL SCREW CHIP | 4 | PZ | | | | | | | | | | | | | | | | | | | | | | | | | | | | | | |
| VM1224A0 | 65MY 220MM 2 COLOURS SHRINK TUBE | 0.300 | M | | | | | | | | | | | | | | | | | | | | | | | | | | | | | | |
| VM2456A0 | BAKERLUX SHOP.PRO HANDLE END | 2 | PZ | | | | | | | | | | | | | | | | | | | | | | | | | | | | | | |
| VM2456A0 | BAKERLUX SHOP.PRO HANDLE END | 2 | PZ | | | | | | | | | | | | | | | | | | | | | | | | | | | | | | |



| COMPONENT | | | SPARE PART | | | | | | | | | | | | | | | | | | | | | | | | | | |
|-----------|--|---|------------|--|--|------|-------------|-----|-----|----------|--|---|----|----------|--------------------------------------|---|----|----------|--|---|----|----------|---------------------------------|---|----|----------|---|---|----|
| Code | Description | Image | Code | Description | Components list | | | | | | | | | | | | | | | | | | | | | | | | |
| VM2456A | BAKERLUX SHOP.PRO HANDLE END |  | KVM2456A | 2 PCS BAKERLUX SHOP.PRO HANDLE END KIT | <table border="1"> <thead> <tr> <th>Code</th> <th>Description</th> <th>Qty</th> <th>UOM</th> </tr> </thead> <tbody> <tr> <td>VM2489A0</td> <td>SP HANDLE END KIT + STYLUS KIT</td> <td>1</td> <td>PZ</td> </tr> <tr> <td>VM2527A0</td> <td>STYLUS PEN FOR SP</td> <td>1</td> <td>PZ</td> </tr> </tbody> </table> | Code | Description | Qty | UOM | VM2489A0 | SP HANDLE END KIT + STYLUS KIT | 1 | PZ | VM2527A0 | STYLUS PEN FOR SP | 1 | PZ | | | | | | | | | | | | |
| Code | Description | Qty | UOM | | | | | | | | | | | | | | | | | | | | | | | | | | |
| VM2489A0 | SP HANDLE END KIT + STYLUS KIT | 1 | PZ | | | | | | | | | | | | | | | | | | | | | | | | | | |
| VM2527A0 | STYLUS PEN FOR SP | 1 | PZ | | | | | | | | | | | | | | | | | | | | | | | | | | |
| PE2107A | BAKERLUX SHOP.PRO LED COMPLETE CONTROL |  | KPE2107A | BAKERLUX SP LED CONTROL BOARD KIT | <table border="1"> <thead> <tr> <th>Code</th> <th>Description</th> <th>Qty</th> <th>UOM</th> </tr> </thead> <tbody> <tr> <td>PE2107A0</td> <td>BAKERLUX SHOP.PRO LED COMPLETE CONTROL</td> <td>1</td> <td>PZ</td> </tr> <tr> <td>PE2107A1</td> <td>SHOP PRO LED CONTROL BOARD KIT</td> <td>1</td> <td>PZ</td> </tr> <tr> <td>PE2107A2</td> <td>BAKERLUX SHOP.PRO LED COMPLETE CONTROL</td> <td>1</td> <td>PZ</td> </tr> <tr> <td>VI1930A0</td> <td>5X25 ST. STEEL SCREW CHIP</td> <td>2</td> <td>PZ</td> </tr> <tr> <td>VM2147A0</td> <td>410X343X15 MM PINK SMOOTH ESD SPONGE</td> <td>1</td> <td>PZ</td> </tr> </tbody> </table> | Code | Description | Qty | UOM | PE2107A0 | BAKERLUX SHOP.PRO LED COMPLETE CONTROL | 1 | PZ | PE2107A1 | SHOP PRO LED CONTROL BOARD KIT | 1 | PZ | PE2107A2 | BAKERLUX SHOP.PRO LED COMPLETE CONTROL | 1 | PZ | VI1930A0 | 5X25 ST. STEEL SCREW CHIP | 2 | PZ | VM2147A0 | 410X343X15 MM PINK SMOOTH ESD SPONGE | 1 | PZ |
| Code | Description | Qty | UOM | | | | | | | | | | | | | | | | | | | | | | | | | | |
| PE2107A0 | BAKERLUX SHOP.PRO LED COMPLETE CONTROL | 1 | PZ | | | | | | | | | | | | | | | | | | | | | | | | | | |
| PE2107A1 | SHOP PRO LED CONTROL BOARD KIT | 1 | PZ | | | | | | | | | | | | | | | | | | | | | | | | | | |
| PE2107A2 | BAKERLUX SHOP.PRO LED COMPLETE CONTROL | 1 | PZ | | | | | | | | | | | | | | | | | | | | | | | | | | |
| VI1930A0 | 5X25 ST. STEEL SCREW CHIP | 2 | PZ | | | | | | | | | | | | | | | | | | | | | | | | | | |
| VM2147A0 | 410X343X15 MM PINK SMOOTH ESD SPONGE | 1 | PZ | | | | | | | | | | | | | | | | | | | | | | | | | | |

ASM3438A/0.D01 - Electrical system

FRONT

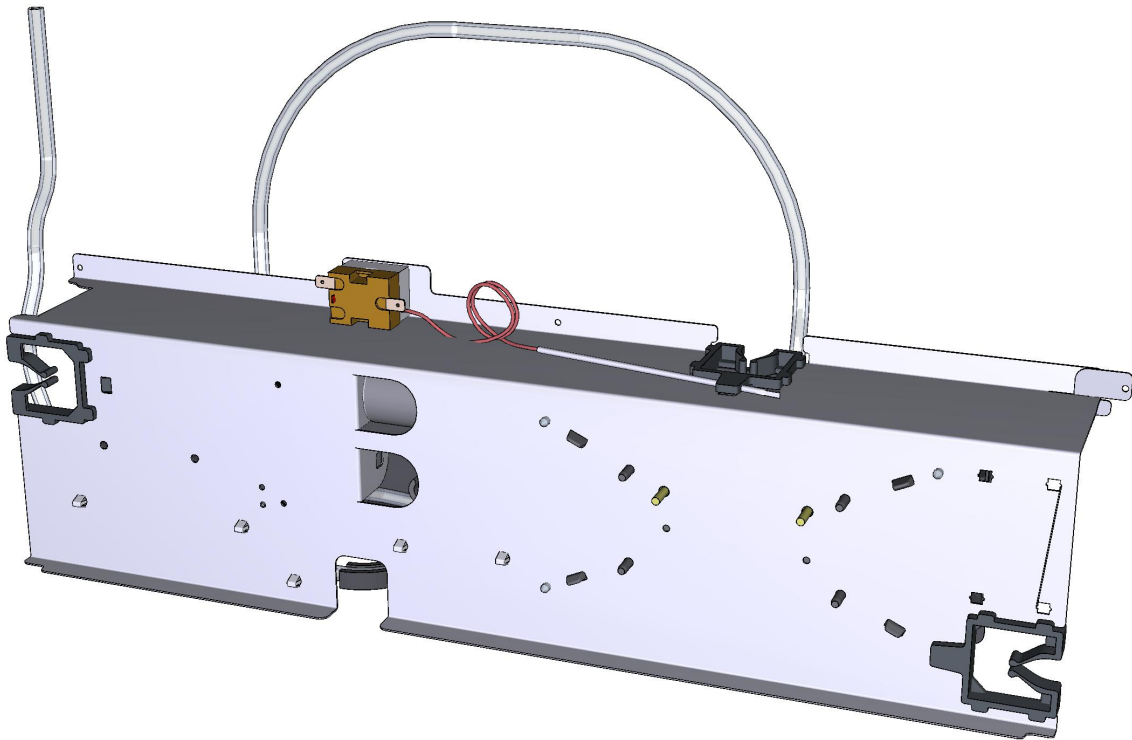



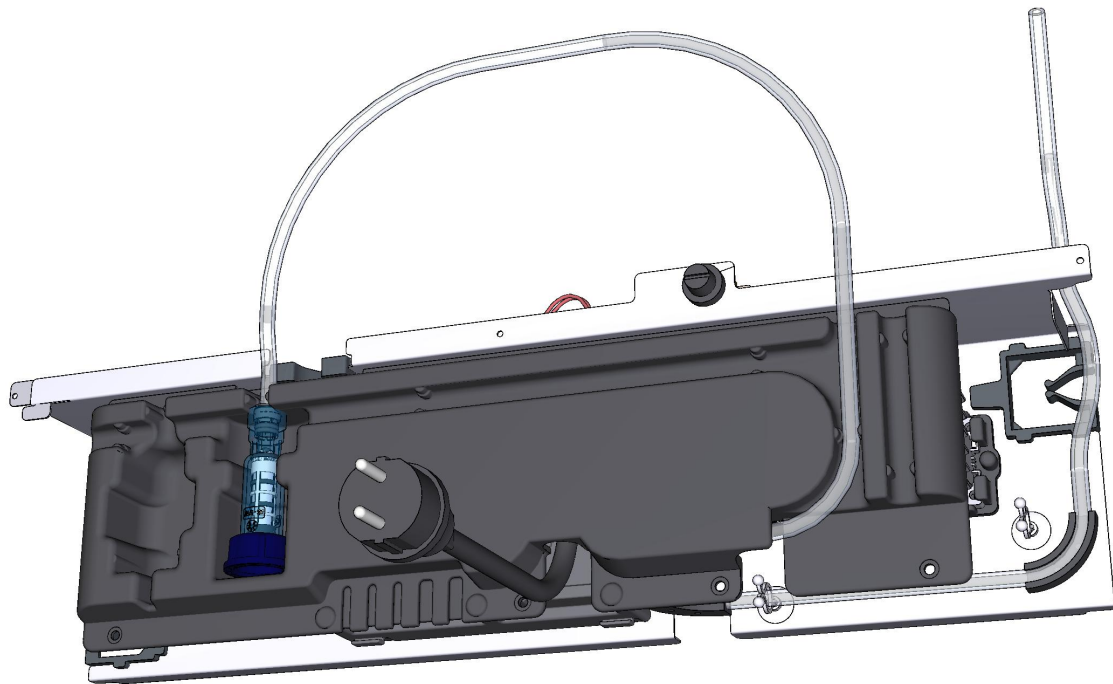

ASM3438A/0.D01 - Electrical system

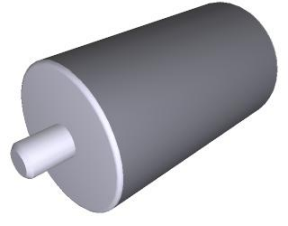
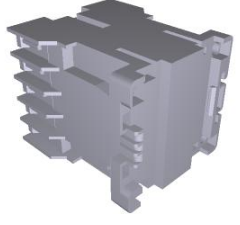



REAR

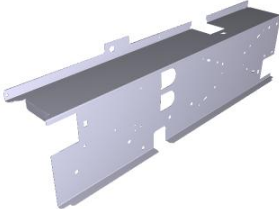



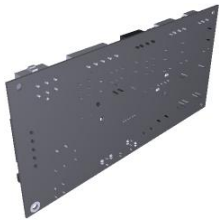

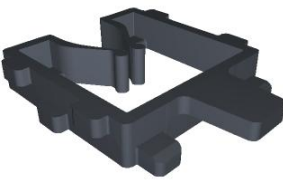

| COMPONENT | | | SPARE PART | | | | | | | | | | | | | | | | | | | | | | | | | | | | | | | | | | |
|-----------|-------------------------------------|---|------------|-----------------------------------|--|------|-------------|-----|-----|----------|---------------------------------|---|----|----------|-------------------------------------|---|----|-----------|-------------------------------------|-------|----|----------|----------------------------------|-------|---|----------|-------------------------------------|---|----|----------|---------------------------------|---|----|----------|-------------------------------|---|----|
| Code | Description | Image | Code | Description | Components list | | | | | | | | | | | | | | | | | | | | | | | | | | | | | | | | |
| TR1136A | 330 °C 1 POLE SAFETY THERMOSTAT |  | KTR1136A | 330 °C SAFETY THERMOSTAT KIT | <table border="1"> <thead> <tr> <th>Code</th> <th>Description</th> <th>Qty</th> <th>UOM</th> </tr> </thead> <tbody> <tr> <td>0H7030A0</td> <td>THERMOSTAT BULB INLET COVER</td> <td>1</td> <td>PZ</td> </tr> <tr> <td>GN1531A0</td> <td>THERMOSTAT BULB INLET SEALING</td> <td>1</td> <td>PZ</td> </tr> <tr> <td>MOV0011A0</td> <td>HOOD RING GASKET</td> <td>0.100</td> <td>PZ</td> </tr> <tr> <td>GN1110A2</td> <td></td> <td></td> <td></td> </tr> <tr> <td>SL1045A0</td> <td>S57 BLACK SILICONE - 80ML CARTRIDGE</td> <td>1</td> <td>PZ</td> </tr> <tr> <td>TR1136A0</td> <td>330 °C 1 POLE SAFETY THERMOSTAT</td> <td>1</td> <td>PZ</td> </tr> <tr> <td>VI1220A1</td> <td>4,2X12 TCB SELF-TAPPING SCREW</td> <td>3</td> <td>PZ</td> </tr> </tbody> </table> | Code | Description | Qty | UOM | 0H7030A0 | THERMOSTAT BULB INLET COVER | 1 | PZ | GN1531A0 | THERMOSTAT BULB INLET SEALING | 1 | PZ | MOV0011A0 | HOOD RING GASKET | 0.100 | PZ | GN1110A2 | | | | SL1045A0 | S57 BLACK SILICONE - 80ML CARTRIDGE | 1 | PZ | TR1136A0 | 330 °C 1 POLE SAFETY THERMOSTAT | 1 | PZ | VI1220A1 | 4,2X12 TCB SELF-TAPPING SCREW | 3 | PZ |
| Code | Description | Qty | UOM | | | | | | | | | | | | | | | | | | | | | | | | | | | | | | | | | | |
| 0H7030A0 | THERMOSTAT BULB INLET COVER | 1 | PZ | | | | | | | | | | | | | | | | | | | | | | | | | | | | | | | | | | |
| GN1531A0 | THERMOSTAT BULB INLET SEALING | 1 | PZ | | | | | | | | | | | | | | | | | | | | | | | | | | | | | | | | | | |
| MOV0011A0 | HOOD RING GASKET | 0.100 | PZ | | | | | | | | | | | | | | | | | | | | | | | | | | | | | | | | | | |
| GN1110A2 | | | | | | | | | | | | | | | | | | | | | | | | | | | | | | | | | | | | | |
| SL1045A0 | S57 BLACK SILICONE - 80ML CARTRIDGE | 1 | PZ | | | | | | | | | | | | | | | | | | | | | | | | | | | | | | | | | | |
| TR1136A0 | 330 °C 1 POLE SAFETY THERMOSTAT | 1 | PZ | | | | | | | | | | | | | | | | | | | | | | | | | | | | | | | | | | |
| VI1220A1 | 4,2X12 TCB SELF-TAPPING SCREW | 3 | PZ | | | | | | | | | | | | | | | | | | | | | | | | | | | | | | | | | | |
| CN1003A | 6,3 UF MOTOR CAPACITOR |  | KCN1003A | 6,3 UF MOTOR CAPACITOR KIT | <table border="1"> <thead> <tr> <th>Code</th> <th>Description</th> <th>Qty</th> <th>UOM</th> </tr> </thead> <tbody> <tr> <td>CN1003A0</td> <td>6,3 UF MOTOR CAPACITOR</td> <td>1</td> <td>PZ</td> </tr> <tr> <td>VI1931A0</td> <td>M8 NUT+INDENTE D WASHER D=8 X COND.</td> <td>1</td> <td>PZ</td> </tr> <tr> <td>VI1932A0</td> <td>M8 NUT+INDENTE D WASHER D=8 X COND.</td> <td>1</td> <td>PZ</td> </tr> <tr> <td>VM1224A0</td> <td>65MY 220MM 2 COLOURS SHRINK TUBE</td> <td>0.200</td> <td>M</td> </tr> </tbody> </table> | Code | Description | Qty | UOM | CN1003A0 | 6,3 UF MOTOR CAPACITOR | 1 | PZ | VI1931A0 | M8 NUT+INDENTE D WASHER D=8 X COND. | 1 | PZ | VI1932A0 | M8 NUT+INDENTE D WASHER D=8 X COND. | 1 | PZ | VM1224A0 | 65MY 220MM 2 COLOURS SHRINK TUBE | 0.200 | M | | | | | | | | | | | | |
| Code | Description | Qty | UOM | | | | | | | | | | | | | | | | | | | | | | | | | | | | | | | | | | |
| CN1003A0 | 6,3 UF MOTOR CAPACITOR | 1 | PZ | | | | | | | | | | | | | | | | | | | | | | | | | | | | | | | | | | |
| VI1931A0 | M8 NUT+INDENTE D WASHER D=8 X COND. | 1 | PZ | | | | | | | | | | | | | | | | | | | | | | | | | | | | | | | | | | |
| VI1932A0 | M8 NUT+INDENTE D WASHER D=8 X COND. | 1 | PZ | | | | | | | | | | | | | | | | | | | | | | | | | | | | | | | | | | |
| VM1224A0 | 65MY 220MM 2 COLOURS SHRINK TUBE | 0.200 | M | | | | | | | | | | | | | | | | | | | | | | | | | | | | | | | | | | |
| VE1115A | 20 A 230V 4 POLES MINICONTACTOR |  | KVE1115A | 20A 230V 4 POLES MINICONTACTOR KI | <table border="1"> <thead> <tr> <th>Code</th> <th>Description</th> <th>Qty</th> <th>UOM</th> </tr> </thead> <tbody> <tr> <td>VE1115A0</td> <td>20 A 230V 4 POLES MINICONTACTOR</td> <td>1</td> <td>PZ</td> </tr> <tr> <td>VM1075A1</td> <td>PLASTIC CLIP TO FIX CONTACTORS</td> <td>4</td> <td>PZ</td> </tr> <tr> <td>VM1224A0</td> <td>65MY 220MM 2 COLOURS SHRINK TUBE</td> <td>0.250</td> <td>M</td> </tr> </tbody> </table> | Code | Description | Qty | UOM | VE1115A0 | 20 A 230V 4 POLES MINICONTACTOR | 1 | PZ | VM1075A1 | PLASTIC CLIP TO FIX CONTACTORS | 4 | PZ | VM1224A0 | 65MY 220MM 2 COLOURS SHRINK TUBE | 0.250 | M | | | | | | | | | | | | | | | | |
| Code | Description | Qty | UOM | | | | | | | | | | | | | | | | | | | | | | | | | | | | | | | | | | |
| VE1115A0 | 20 A 230V 4 POLES MINICONTACTOR | 1 | PZ | | | | | | | | | | | | | | | | | | | | | | | | | | | | | | | | | | |
| VM1075A1 | PLASTIC CLIP TO FIX CONTACTORS | 4 | PZ | | | | | | | | | | | | | | | | | | | | | | | | | | | | | | | | | | |
| VM1224A0 | 65MY 220MM 2 COLOURS SHRINK TUBE | 0.250 | M | | | | | | | | | | | | | | | | | | | | | | | | | | | | | | | | | | |

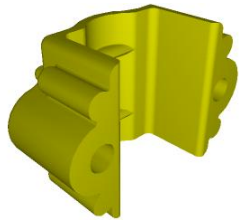

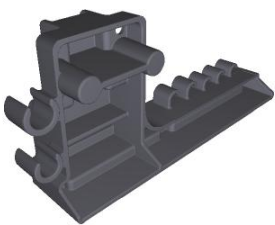
| COMPONENT | | | SPARE PART | | | | | | | | | | | | | | | | | | |
|-----------|---|---|------------|--|---|------|-------------|-----|-----|----------|---|----|----|----------|-------------------------------------|-------|----|----------|------------------------------------|---|----|
| Code | Description | Image | Code | Description | Components list | | | | | | | | | | | | | | | | |
| VM1056A | SMALL CONTACTOR BRACKET VE1115A |  | VM1056A0 | SMALL CONTACTOR BRACKET VE1115A | | | | | | | | | | | | | | | | | |
| RC1006A | D8 PET PIPE GUIDE BEND |  | KRC1006A | 20 PCS. Ø8 PET PIPE GUIDE BEND KI | <table border="1"> <thead> <tr> <th>Code</th> <th>Description</th> <th>Qty</th> <th>UOM</th> </tr> </thead> <tbody> <tr> <td>RC1006A0</td> <td>D8 PET PIPE GUIDE BEND</td> <td>20</td> <td>PZ</td> </tr> <tr> <td>VM1224A0</td> <td>65MY 220MM 2 COLOURS SHRINK TUBE</td> <td>0.200</td> <td>M</td> </tr> </tbody> </table> | Code | Description | Qty | UOM | RC1006A0 | D8 PET PIPE GUIDE BEND | 20 | PZ | VM1224A0 | 65MY 220MM 2 COLOURS SHRINK TUBE | 0.200 | M | | | | |
| Code | Description | Qty | UOM | | | | | | | | | | | | | | | | | | |
| RC1006A0 | D8 PET PIPE GUIDE BEND | 20 | PZ | | | | | | | | | | | | | | | | | | |
| VM1224A0 | 65MY 220MM 2 COLOURS SHRINK TUBE | 0.200 | M | | | | | | | | | | | | | | | | | | |
| 0P1021A | COMPONENTS HOLDING PANEL STE-ARI SP |  | 0P1021A0 | COMPONENTS HOLDING PANEL STE-ARI SP | | | | | | | | | | | | | | | | | |
| VM1187A | POWER BOARD FRAME SHOP.PRO |  | VM1187A0 | POWER BOARD FRAME SHOP.PRO | | | | | | | | | | | | | | | | | |
| PE2102A | BL LED/TOUCH/PLUS 230 V POWER CARD |  | KPE2102A | BL LED/TOUCH/MASTE R 230V POWER CARD KIT | <table border="1"> <thead> <tr> <th>Code</th> <th>Description</th> <th>Qty</th> <th>UOM</th> </tr> </thead> <tbody> <tr> <td>PE2102A0</td> <td>BL LED/TOUCH/P LUS 230V POWER BOARD KIT</td> <td>1</td> <td>PZ</td> </tr> <tr> <td>PE2102A1</td> <td>BL LED/TOUCH/P LUS 230 V POWER CARD</td> <td>1</td> <td>PZ</td> </tr> <tr> <td>PE2102A2</td> <td>BL LED/TOUCH/P LUS 230V POWER BOAR</td> <td>1</td> <td>PZ</td> </tr> </tbody> </table> | Code | Description | Qty | UOM | PE2102A0 | BL LED/TOUCH/P LUS 230V POWER BOARD KIT | 1 | PZ | PE2102A1 | BL LED/TOUCH/P LUS 230 V POWER CARD | 1 | PZ | PE2102A2 | BL LED/TOUCH/P LUS 230V POWER BOAR | 1 | PZ |
| Code | Description | Qty | UOM | | | | | | | | | | | | | | | | | | |
| PE2102A0 | BL LED/TOUCH/P LUS 230V POWER BOARD KIT | 1 | PZ | | | | | | | | | | | | | | | | | | |
| PE2102A1 | BL LED/TOUCH/P LUS 230 V POWER CARD | 1 | PZ | | | | | | | | | | | | | | | | | | |
| PE2102A2 | BL LED/TOUCH/P LUS 230V POWER BOAR | 1 | PZ | | | | | | | | | | | | | | | | | | |

| COMPONENT | | | SPARE PART | | | | | | | | | | | | | | | | | | |
|-----------|---|---|------------|---|--|------|-------------|-----|-----|----------|---|----|----|----------|--|-------|----|----------|---|---|----|
| Code | Description | Image | Code | Description | Components list | | | | | | | | | | | | | | | | |
| PE2102A | BL LED/TOUCH/PLUS 230 V POWER CARD |  | KPE2102A | BL LED/TOUCH/MASTE R 230V POWER CARD KIT | <table border="1"> <thead> <tr> <th>Code</th> <th>Description</th> <th>Qty</th> <th>UOM</th> </tr> </thead> <tbody> <tr> <td>VI1988A0</td> <td>AUTOTHREAD ING SCREW 4,2X19 TCB+ INOX</td> <td>3</td> <td>PZ</td> </tr> <tr> <td>VM1187A0</td> <td>POWER BOARD FRAME SHOP.PRO</td> <td>1</td> <td>PZ</td> </tr> <tr> <td>VM2147A0</td> <td>410X343X15 MM PINK SMOOTH ESD SPONGE</td> <td>1</td> <td>PZ</td> </tr> </tbody> </table> | Code | Description | Qty | UOM | VI1988A0 | AUTOTHREAD ING SCREW 4,2X19 TCB+ INOX | 3 | PZ | VM1187A0 | POWER BOARD FRAME SHOP.PRO | 1 | PZ | VM2147A0 | 410X343X15 MM PINK SMOOTH ESD SPONGE | 1 | PZ |
| Code | Description | Qty | UOM | | | | | | | | | | | | | | | | | | |
| VI1988A0 | AUTOTHREAD ING SCREW 4,2X19 TCB+ INOX | 3 | PZ | | | | | | | | | | | | | | | | | | |
| VM1187A0 | POWER BOARD FRAME SHOP.PRO | 1 | PZ | | | | | | | | | | | | | | | | | | |
| VM2147A0 | 410X343X15 MM PINK SMOOTH ESD SPONGE | 1 | PZ | | | | | | | | | | | | | | | | | | |
| CE1581A | CABLE H07RNF 3G1.5 L1.5MT+K1/6+SCHU KO |  | KCE1581A | H07RNF 3G1.5 L1.5 MT + SHUKO PLUG KIT | <table border="1"> <thead> <tr> <th>Code</th> <th>Description</th> <th>Qty</th> <th>UOM</th> </tr> </thead> <tbody> <tr> <td>CE1581A0</td> <td>CABLE H07RNF 3G1.5 L1.5MT+K1/6+ SCHUKO</td> <td>1</td> <td>PZ</td> </tr> <tr> <td>VM1224A0</td> <td>65MY 220MM 2 COLOURS SHRINK TUBE</td> <td>0.300</td> <td>M</td> </tr> </tbody> </table> | Code | Description | Qty | UOM | CE1581A0 | CABLE H07RNF 3G1.5 L1.5MT+K1/6+ SCHUKO | 1 | PZ | VM1224A0 | 65MY 220MM 2 COLOURS SHRINK TUBE | 0.300 | M | | | | |
| Code | Description | Qty | UOM | | | | | | | | | | | | | | | | | | |
| CE1581A0 | CABLE H07RNF 3G1.5 L1.5MT+K1/6+ SCHUKO | 1 | PZ | | | | | | | | | | | | | | | | | | |
| VM1224A0 | 65MY 220MM 2 COLOURS SHRINK TUBE | 0.300 | M | | | | | | | | | | | | | | | | | | |
| MR1025A | 3 POLES 450V 41A+GROUND TERMINAL BLOCK |  | KMR1025A | 3 POLES TERMINAL BLOCK KIT | <table border="1"> <thead> <tr> <th>Code</th> <th>Description</th> <th>Qty</th> <th>UOM</th> </tr> </thead> <tbody> <tr> <td>MR1025A1</td> <td>3 POLES 450V 41A+GROUND TERMINAL BLOCK</td> <td>1</td> <td>PZ</td> </tr> <tr> <td>VM1224A0</td> <td>65MY 220MM 2 COLOURS SHRINK TUBE</td> <td>0.150</td> <td>M</td> </tr> </tbody> </table> | Code | Description | Qty | UOM | MR1025A1 | 3 POLES 450V 41A+GROUND TERMINAL BLOCK | 1 | PZ | VM1224A0 | 65MY 220MM 2 COLOURS SHRINK TUBE | 0.150 | M | | | | |
| Code | Description | Qty | UOM | | | | | | | | | | | | | | | | | | |
| MR1025A1 | 3 POLES 450V 41A+GROUND TERMINAL BLOCK | 1 | PZ | | | | | | | | | | | | | | | | | | |
| VM1224A0 | 65MY 220MM 2 COLOURS SHRINK TUBE | 0.150 | M | | | | | | | | | | | | | | | | | | |
| VI1328A | |  | VI1328A0 | | | | | | | | | | | | | | | | | | |
| VM1188A | BL SHOP.PRO POWER BOARD WIRE PASSAGE |  | KVM1188A | BL SP POWER BOARD WIRE PASSAGE 10 PC KIT | <table border="1"> <thead> <tr> <th>Code</th> <th>Description</th> <th>Qty</th> <th>UOM</th> </tr> </thead> <tbody> <tr> <td>VM1188A0</td> <td>BL SHOP.PRO POWER BOARD WIRE PASSAGE</td> <td>10</td> <td>PZ</td> </tr> <tr> <td>VM1224A0</td> <td>65MY 220MM 2 COLOURS SHRINK TUBE</td> <td>0.200</td> <td>M</td> </tr> </tbody> </table> | Code | Description | Qty | UOM | VM1188A0 | BL SHOP.PRO POWER BOARD WIRE PASSAGE | 10 | PZ | VM1224A0 | 65MY 220MM 2 COLOURS SHRINK TUBE | 0.200 | M | | | | |
| Code | Description | Qty | UOM | | | | | | | | | | | | | | | | | | |
| VM1188A0 | BL SHOP.PRO POWER BOARD WIRE PASSAGE | 10 | PZ | | | | | | | | | | | | | | | | | | |
| VM1224A0 | 65MY 220MM 2 COLOURS SHRINK TUBE | 0.200 | M | | | | | | | | | | | | | | | | | | |

| COMPONENT | | | SPARE PART | | | | | | | | | | | | | | | | | | | | | | | |
|-----------|---|--|------------|---|--|------|-------------|----------------------------------|-------|----------|--|--|---|----------|--|--|----|----------|-----------------------------------|-----------------------------------|----|----|----------|-----------------------------------|---|----|
| Code | Description | Image | Code | Description | Components list | | | | | | | | | | | | | | | | | | | | | |
| VM2484A | ELECTRICAL CONNECTION CABLE CLAMP |  | KVM2484A | CABLE LOCKS ELECTRICAL CONNECTION KIT | <table border="1"> <thead> <tr> <th>Code</th> <th>Description</th> <th>Qty</th> <th>UOM</th> </tr> </thead> <tbody> <tr> <td>VM1224A0</td> <td>65MY 220MM 2 COLOURS SHRINK TUBE</td> <td>0.300</td> <td>M</td> </tr> <tr> <td>VM2484A0</td> <td>ELECTRICAL CONNECTION CABLE CLAMP</td> <td>1</td> <td>PZ</td> </tr> <tr> <td>VM2484A0</td> <td>ELECTRICAL CONNECTION CABLE CLAMP</td> <td>1</td> <td>PZ</td> </tr> </tbody> </table> | Code | Description | Qty | UOM | VM1224A0 | 65MY 220MM 2 COLOURS SHRINK TUBE | 0.300 | M | VM2484A0 | ELECTRICAL CONNECTION CABLE CLAMP | 1 | PZ | VM2484A0 | ELECTRICAL CONNECTION CABLE CLAMP | 1 | PZ | | | | | |
| | | | Code | Description | Qty | UOM | | | | | | | | | | | | | | | | | | | | |
| VM1224A0 | 65MY 220MM 2 COLOURS SHRINK TUBE | 0.300 | M | | | | | | | | | | | | | | | | | | | | | | | |
| VM2484A0 | ELECTRICAL CONNECTION CABLE CLAMP | 1 | PZ | | | | | | | | | | | | | | | | | | | | | | | |
| VM2484A0 | ELECTRICAL CONNECTION CABLE CLAMP | 1 | PZ | | | | | | | | | | | | | | | | | | | | | | | |
| KVM2482A | BAKERLUX SP ELECTR COMPONENTS HOLDER KIT | <table border="1"> <thead> <tr> <th>Code</th> <th>Description</th> <th>Qty</th> <th>UOM</th> </tr> </thead> <tbody> <tr> <td>VM1224A0</td> <td>65MY 220MM 2 COLOURS SHRINK TUBE</td> <td>0.300</td> <td>M</td> </tr> <tr> <td>VM2482A0</td> <td>ELECTR COMPONENT S HOLDER FRAME SHOP.PRO</td> <td>1</td> <td>PZ</td> </tr> <tr> <td>VM2482A0</td> <td>ELECTR COMPONENT S HOLDER FRAME SHOP.PRO</td> <td>1</td> <td>PZ</td> </tr> <tr> <td>VM2484A0</td> <td>ELECTRICAL CONNECTION CABLE CLAMP</td> <td>1</td> <td>PZ</td> </tr> <tr> <td>VM2484A0</td> <td>ELECTRICAL CONNECTION CABLE CLAMP</td> <td>1</td> <td>PZ</td> </tr> </tbody> </table> | Code | Description | Qty | UOM | VM1224A0 | 65MY 220MM 2 COLOURS SHRINK TUBE | 0.300 | M | VM2482A0 | ELECTR COMPONENT S HOLDER FRAME SHOP.PRO | 1 | PZ | VM2482A0 | ELECTR COMPONENT S HOLDER FRAME SHOP.PRO | 1 | PZ | VM2484A0 | ELECTRICAL CONNECTION CABLE CLAMP | 1 | PZ | VM2484A0 | ELECTRICAL CONNECTION CABLE CLAMP | 1 | PZ |
| Code | Description | Qty | UOM | | | | | | | | | | | | | | | | | | | | | | | |
| VM1224A0 | 65MY 220MM 2 COLOURS SHRINK TUBE | 0.300 | M | | | | | | | | | | | | | | | | | | | | | | | |
| VM2482A0 | ELECTR COMPONENT S HOLDER FRAME SHOP.PRO | 1 | PZ | | | | | | | | | | | | | | | | | | | | | | | |
| VM2482A0 | ELECTR COMPONENT S HOLDER FRAME SHOP.PRO | 1 | PZ | | | | | | | | | | | | | | | | | | | | | | | |
| VM2484A0 | ELECTRICAL CONNECTION CABLE CLAMP | 1 | PZ | | | | | | | | | | | | | | | | | | | | | | | |
| VM2484A0 | ELECTRICAL CONNECTION CABLE CLAMP | 1 | PZ | | | | | | | | | | | | | | | | | | | | | | | |
| TB3280A | |  | KTB2529A | Ø8 TRANSPARENT HUMIDITY PIPE 2 M KIT | <table border="1"> <thead> <tr> <th>Code</th> <th>Description</th> <th>Qty</th> <th>UOM</th> </tr> </thead> <tbody> <tr> <td>TB1815A0</td> <td>7.93X4,75 PE (JG #PE08100N) TRANSP. PIPE</td> <td>2</td> <td>M</td> </tr> </tbody> </table> | Code | Description | Qty | UOM | TB1815A0 | 7.93X4,75 PE (JG #PE08100N) TRANSP. PIPE | 2 | M | | | | | | | | | | | | | |
| Code | Description | Qty | UOM | | | | | | | | | | | | | | | | | | | | | | | |
| TB1815A0 | 7.93X4,75 PE (JG #PE08100N) TRANSP. PIPE | 2 | M | | | | | | | | | | | | | | | | | | | | | | | |
| VM2482A | ELECTR COMPONENTS HOLDER FRAME SHOP.PRO |  | KVM2482A | BAKERLUX SP ELECTR COMPONENTS HOLDER KIT | <table border="1"> <thead> <tr> <th>Code</th> <th>Description</th> <th>Qty</th> <th>UOM</th> </tr> </thead> <tbody> <tr> <td>VM1224A0</td> <td>65MY 220MM 2 COLOURS SHRINK TUBE</td> <td>0.300</td> <td>M</td> </tr> <tr> <td>VM2482A0</td> <td>ELECTR COMPONENT S HOLDER FRAME SHOP.PRO</td> <td>1</td> <td>PZ</td> </tr> </tbody> </table> | Code | Description | Qty | UOM | VM1224A0 | 65MY 220MM 2 COLOURS SHRINK TUBE | 0.300 | M | VM2482A0 | ELECTR COMPONENT S HOLDER FRAME SHOP.PRO | 1 | PZ | | | | | | | | | |
| Code | Description | Qty | UOM | | | | | | | | | | | | | | | | | | | | | | | |
| VM1224A0 | 65MY 220MM 2 COLOURS SHRINK TUBE | 0.300 | M | | | | | | | | | | | | | | | | | | | | | | | |
| VM2482A0 | ELECTR COMPONENT S HOLDER FRAME SHOP.PRO | 1 | PZ | | | | | | | | | | | | | | | | | | | | | | | |

| COMPONENT | | | SPARE PART | | | | | | | | | | | | | | | | | | | | | | |
|-----------|--|---|------------|---|---|------|-------------|-----|-----|----------|--|-------|----|----------|--|-------|----|----------|--|---|----|----------|--|---|----|
| Code | Description | Image | Code | Description | Components list | | | | | | | | | | | | | | | | | | | | |
| VM2482A | ELECTR COMPONENTS HOLDER FRAME SHOP.PRO |  | KVM2482A | BAKERLUX SP ELECTR COMPONENTS HOLDER KIT | <table border="1"> <thead> <tr> <th>Code</th> <th>Description</th> <th>Qty</th> <th>UOM</th> </tr> </thead> <tbody> <tr> <td>VM2482A0</td> <td>ELECTR COMPONENT S HOLDER FRAME SHOP.PRO</td> <td>1</td> <td>PZ</td> </tr> <tr> <td>VM2484A0</td> <td>ELECTRICAL CONNECTION CABLE CLAMP</td> <td>1</td> <td>PZ</td> </tr> <tr> <td>VM2484A0</td> <td>ELECTRICAL CONNECTION CABLE CLAMP</td> <td>1</td> <td>PZ</td> </tr> </tbody> </table> | Code | Description | Qty | UOM | VM2482A0 | ELECTR COMPONENT S HOLDER FRAME SHOP.PRO | 1 | PZ | VM2484A0 | ELECTRICAL CONNECTION CABLE CLAMP | 1 | PZ | VM2484A0 | ELECTRICAL CONNECTION CABLE CLAMP | 1 | PZ | | | | |
| Code | Description | Qty | UOM | | | | | | | | | | | | | | | | | | | | | | |
| VM2482A0 | ELECTR COMPONENT S HOLDER FRAME SHOP.PRO | 1 | PZ | | | | | | | | | | | | | | | | | | | | | | |
| VM2484A0 | ELECTRICAL CONNECTION CABLE CLAMP | 1 | PZ | | | | | | | | | | | | | | | | | | | | | | |
| VM2484A0 | ELECTRICAL CONNECTION CABLE CLAMP | 1 | PZ | | | | | | | | | | | | | | | | | | | | | | |
| VM2483A | SHOP PRO COMPONENTS HOLDER COVER |  | KVM2483A | BL SHOP.PRO COMPONENTS HOLDER COVER KIT | <table border="1"> <thead> <tr> <th>Code</th> <th>Description</th> <th>Qty</th> <th>UOM</th> </tr> </thead> <tbody> <tr> <td>VM1224A0</td> <td>65MY 220MM 2 COLOURS SHRINK TUBE</td> <td>0.300</td> <td>M</td> </tr> <tr> <td>VM2483A0</td> <td>COMPONENT S HOLDER COVER SHOP.PRO</td> <td>1</td> <td>PZ</td> </tr> <tr> <td>VM2483A0</td> <td>COMPONENT S HOLDER COVER SHOP.PRO</td> <td>1</td> <td>PZ</td> </tr> <tr> <td>VM2483A1</td> <td>SHOP PRO COMPONENT S HOLDER COVER</td> <td>1</td> <td>PZ</td> </tr> </tbody> </table> | Code | Description | Qty | UOM | VM1224A0 | 65MY 220MM 2 COLOURS SHRINK TUBE | 0.300 | M | VM2483A0 | COMPONENT S HOLDER COVER SHOP.PRO | 1 | PZ | VM2483A0 | COMPONENT S HOLDER COVER SHOP.PRO | 1 | PZ | VM2483A1 | SHOP PRO COMPONENT S HOLDER COVER | 1 | PZ |
| Code | Description | Qty | UOM | | | | | | | | | | | | | | | | | | | | | | |
| VM1224A0 | 65MY 220MM 2 COLOURS SHRINK TUBE | 0.300 | M | | | | | | | | | | | | | | | | | | | | | | |
| VM2483A0 | COMPONENT S HOLDER COVER SHOP.PRO | 1 | PZ | | | | | | | | | | | | | | | | | | | | | | |
| VM2483A0 | COMPONENT S HOLDER COVER SHOP.PRO | 1 | PZ | | | | | | | | | | | | | | | | | | | | | | |
| VM2483A1 | SHOP PRO COMPONENT S HOLDER COVER | 1 | PZ | | | | | | | | | | | | | | | | | | | | | | |
| VL1145A | |  | KVL1145A | 3/4-JG8 FITTING WITH FILTER AND VNR KIT | <table border="1"> <thead> <tr> <th>Code</th> <th>Description</th> <th>Qty</th> <th>UOM</th> </tr> </thead> <tbody> <tr> <td>VL1145A0</td> <td></td> <td>1</td> <td>PZ</td> </tr> <tr> <td>VM1224A0</td> <td>65MY 220MM 2 COLOURS SHRINK TUBE</td> <td>0.150</td> <td>M</td> </tr> </tbody> </table> | Code | Description | Qty | UOM | VL1145A0 | | 1 | PZ | VM1224A0 | 65MY 220MM 2 COLOURS SHRINK TUBE | 0.150 | M | | | | | | | | |
| Code | Description | Qty | UOM | | | | | | | | | | | | | | | | | | | | | | |
| VL1145A0 | | 1 | PZ | | | | | | | | | | | | | | | | | | | | | | |
| VM1224A0 | 65MY 220MM 2 COLOURS SHRINK TUBE | 0.150 | M | | | | | | | | | | | | | | | | | | | | | | |

ASM3401A/0.D01 - Cooking chamber

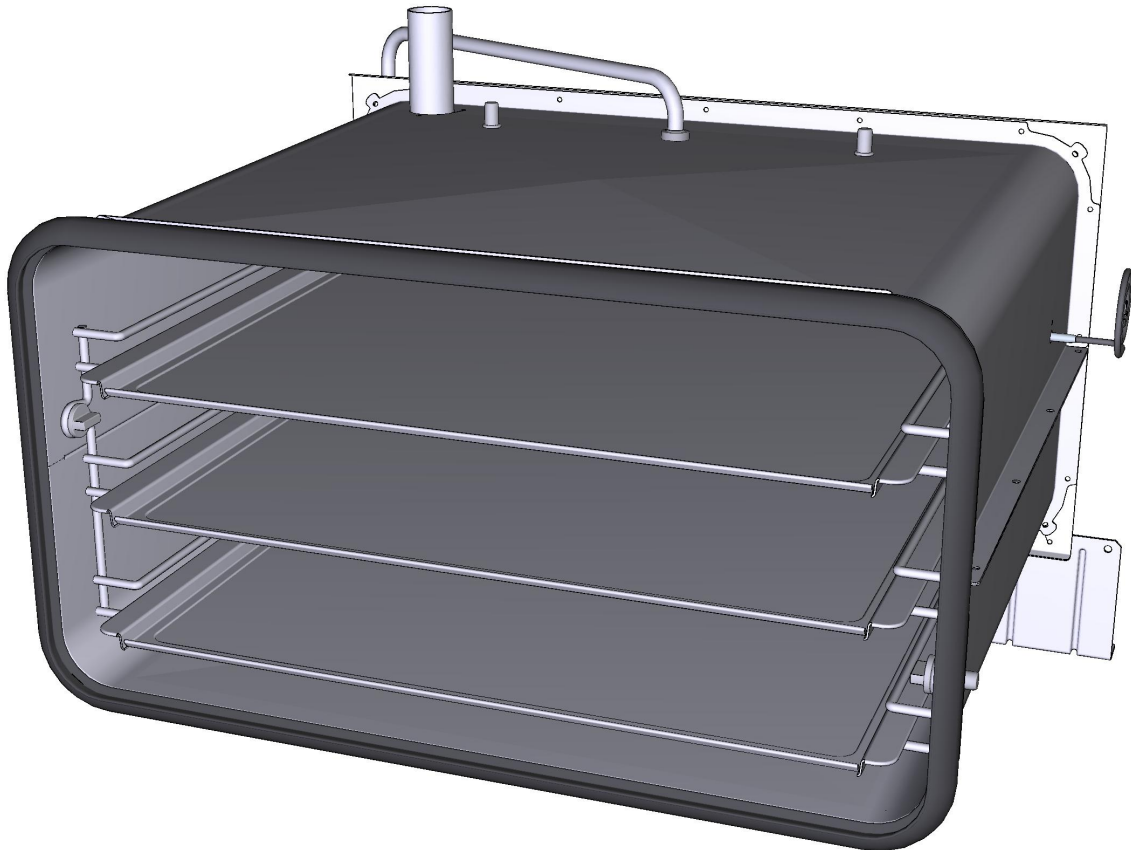

FRONT



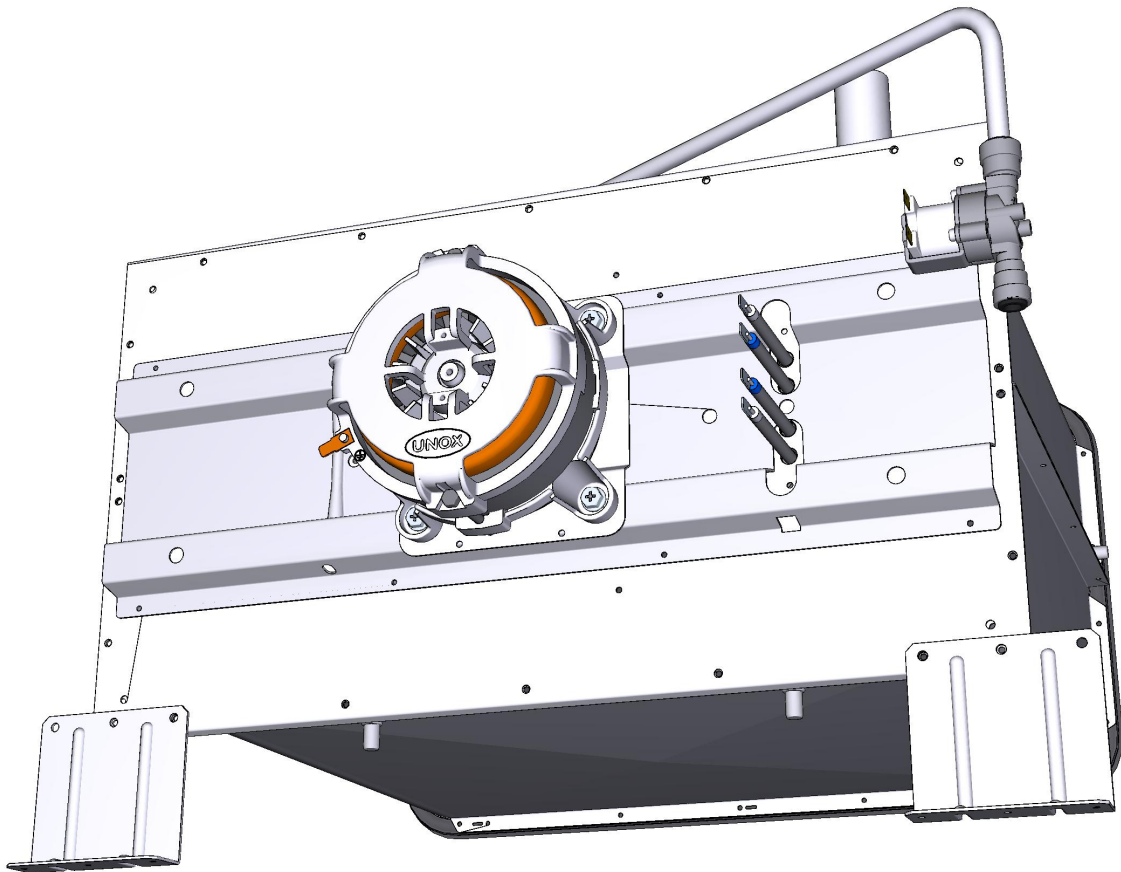

ASM3401A/0.D01 - Cooking chamber

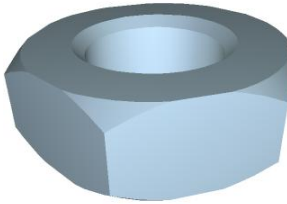
REAR







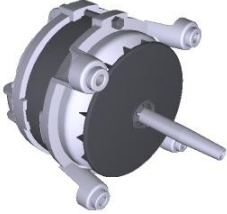

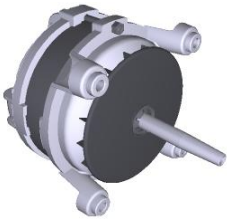
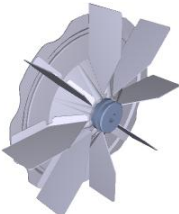
| COMPONENT | | | SPARE PART | | | | | | | | | | | | | | | | | | | | | | | | | | | | | | | | | | | | | | | | | | | | | | |
|-----------|--|---|------------|---|--|------|-------------|-----|-----|----------|--|----|----|----------|--|-------|----|----------|---|---|----|-----------|---------------------------------|-------|----|----------|--|---|----|----------|--------------------------------------|---|----|----------|--------------------------------------|---|----|----------|---|---|----|----------|---|---|----|----------|-----------------------|---|----|
| Code | Description | Image | Code | Description | Components list | | | | | | | | | | | | | | | | | | | | | | | | | | | | | | | | | | | | | | | | | | | | |
| TR1105A | L1000 PT100 TEMPERATURE PROBE |  | KTR1105A | PT100 L1000 TEMPERATURE PROBE KIT | <table border="1"> <thead> <tr> <th>Code</th> <th>Description</th> <th>Qty</th> <th>UOM</th> </tr> </thead> <tbody> <tr> <td>GN1120A0</td> <td>NTC TEMPERATUR E PROBE SEAL</td> <td>1</td> <td>PZ</td> </tr> <tr> <td>GN1120A1</td> <td>NTC TEMPERATUR E PROBE SEAL</td> <td>1</td> <td>PZ</td> </tr> <tr> <td>GN1285A0</td> <td>NTC TEMPERATUR E PROBE SEALING</td> <td>1</td> <td>PZ</td> </tr> <tr> <td>MOV0010A0</td> <td>HOOD RING GASKET GN1110A2</td> <td>0.100</td> <td>PZ</td> </tr> <tr> <td>SL1045A0</td> <td>S57 BLACK SILICONE - 80ML CARTRIDGE</td> <td>1</td> <td>PZ</td> </tr> <tr> <td>TR1105A4</td> <td>L1000 PT100 TEMPERATUR E PROBE</td> <td>1</td> <td>PZ</td> </tr> <tr> <td>VI1220A1</td> <td>4,2X12 TCB SELF-TAPPIN G SCREW</td> <td>2</td> <td>PZ</td> </tr> <tr> <td>VM1464A1</td> <td>CT BT TEMPERATUR E PROBE COVER</td> <td>1</td> <td>PZ</td> </tr> <tr> <td>VM1465A1</td> <td>CT BT TEMPERATUR E PROBE COVER</td> <td>1</td> <td>PZ</td> </tr> <tr> <td>VM2052A0</td> <td>LM CORE PROBE COVE</td> <td>1</td> <td>PZ</td> </tr> </tbody> </table> | Code | Description | Qty | UOM | GN1120A0 | NTC TEMPERATUR E PROBE SEAL | 1 | PZ | GN1120A1 | NTC TEMPERATUR E PROBE SEAL | 1 | PZ | GN1285A0 | NTC TEMPERATUR E PROBE SEALING | 1 | PZ | MOV0010A0 | HOOD RING GASKET GN1110A2 | 0.100 | PZ | SL1045A0 | S57 BLACK SILICONE - 80ML CARTRIDGE | 1 | PZ | TR1105A4 | L1000 PT100 TEMPERATUR E PROBE | 1 | PZ | VI1220A1 | 4,2X12 TCB SELF-TAPPIN G SCREW | 2 | PZ | VM1464A1 | CT BT TEMPERATUR E PROBE COVER | 1 | PZ | VM1465A1 | CT BT TEMPERATUR E PROBE COVER | 1 | PZ | VM2052A0 | LM CORE PROBE COVE | 1 | PZ |
| Code | Description | Qty | UOM | | | | | | | | | | | | | | | | | | | | | | | | | | | | | | | | | | | | | | | | | | | | | | |
| GN1120A0 | NTC TEMPERATUR E PROBE SEAL | 1 | PZ | | | | | | | | | | | | | | | | | | | | | | | | | | | | | | | | | | | | | | | | | | | | | | |
| GN1120A1 | NTC TEMPERATUR E PROBE SEAL | 1 | PZ | | | | | | | | | | | | | | | | | | | | | | | | | | | | | | | | | | | | | | | | | | | | | | |
| GN1285A0 | NTC TEMPERATUR E PROBE SEALING | 1 | PZ | | | | | | | | | | | | | | | | | | | | | | | | | | | | | | | | | | | | | | | | | | | | | | |
| MOV0010A0 | HOOD RING GASKET GN1110A2 | 0.100 | PZ | | | | | | | | | | | | | | | | | | | | | | | | | | | | | | | | | | | | | | | | | | | | | | |
| SL1045A0 | S57 BLACK SILICONE - 80ML CARTRIDGE | 1 | PZ | | | | | | | | | | | | | | | | | | | | | | | | | | | | | | | | | | | | | | | | | | | | | | |
| TR1105A4 | L1000 PT100 TEMPERATUR E PROBE | 1 | PZ | | | | | | | | | | | | | | | | | | | | | | | | | | | | | | | | | | | | | | | | | | | | | | |
| VI1220A1 | 4,2X12 TCB SELF-TAPPIN G SCREW | 2 | PZ | | | | | | | | | | | | | | | | | | | | | | | | | | | | | | | | | | | | | | | | | | | | | | |
| VM1464A1 | CT BT TEMPERATUR E PROBE COVER | 1 | PZ | | | | | | | | | | | | | | | | | | | | | | | | | | | | | | | | | | | | | | | | | | | | | | |
| VM1465A1 | CT BT TEMPERATUR E PROBE COVER | 1 | PZ | | | | | | | | | | | | | | | | | | | | | | | | | | | | | | | | | | | | | | | | | | | | | | |
| VM2052A0 | LM CORE PROBE COVE | 1 | PZ | | | | | | | | | | | | | | | | | | | | | | | | | | | | | | | | | | | | | | | | | | | | | | |
| RC1170A | STAINLESS STEEL NUT M14 H=8 CH=22 |  | KRC1170A | M14 H8 CH22 NUT - 10 PCS. KIT | <table border="1"> <thead> <tr> <th>Code</th> <th>Description</th> <th>Qty</th> <th>UOM</th> </tr> </thead> <tbody> <tr> <td>RC1170A1</td> <td>STAINLESS STEEL NUT M14 H=8 CH=2</td> <td>10</td> <td>PZ</td> </tr> <tr> <td>VM1224A0</td> <td>65MY 220MM 2 COLOURS SHRINK TUBE</td> <td>0.200</td> <td>M</td> </tr> </tbody> </table> | Code | Description | Qty | UOM | RC1170A1 | STAINLESS STEEL NUT M14 H=8 CH=2 | 10 | PZ | VM1224A0 | 65MY 220MM 2 COLOURS SHRINK TUBE | 0.200 | M | | | | | | | | | | | | | | | | | | | | | | | | | | | | | | | | |
| Code | Description | Qty | UOM | | | | | | | | | | | | | | | | | | | | | | | | | | | | | | | | | | | | | | | | | | | | | | |
| RC1170A1 | STAINLESS STEEL NUT M14 H=8 CH=2 | 10 | PZ | | | | | | | | | | | | | | | | | | | | | | | | | | | | | | | | | | | | | | | | | | | | | | |
| VM1224A0 | 65MY 220MM 2 COLOURS SHRINK TUBE | 0.200 | M | | | | | | | | | | | | | | | | | | | | | | | | | | | | | | | | | | | | | | | | | | | | | | |
| 0H7875A | MUFFLE SUPPORT BRACKET SHOP.PR |  | 0H7875A0 | MUFFLE SUPPORT BRACKET SHOP.PR | | | | | | | | | | | | | | | | | | | | | | | | | | | | | | | | | | | | | | | | | | | | | |



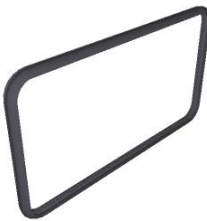

| COMPONENT | | | SPARE PART | | | | | | | | | | | | | | | | | | | | | | | | | | | | | | | | | | | | | | | | | | | | | | |
|------------------|----------------------------------|---|-------------------|--------------------------------------|--|--|-------------|---|------|-------------|------------------------------------|-----|----------|----------|----------------------------------|-------|----|----------|----------------------------|---|----|----------|-------------------------------|---|----|----------|--|---|----|----------|--------------------------|---|----|----------|------------|---|----|----------|-----------------------------|---|----|----------|------------------------|---|----|----------|------------------------|---|----|
| <i>Code</i> | <i>Description</i> | <i>Image</i> | <i>Code</i> | <i>Description</i> | <i>Components list</i> | | | | | | | | | | | | | | | | | | | | | | | | | | | | | | | | | | | | | | | | | | | | |
| EL1251A | 1-WAY WATER SOLENOID VALVE |  | KEL1251A | JG D8-D10 1 WAY SOLENOID VALVE KI | <table border="1"> <thead> <tr> <th>Code</th> <th>Description</th> <th>Qty</th> <th>UOM</th> </tr> </thead> <tbody> <tr> <td>EL1251A0</td> <td>1-WAY WATER SOLENOID VALVE</td> <td>1</td> <td>PZ</td> </tr> <tr> <td>VM1224A0</td> <td>65MY 220MM 2 COLOURS SHRINK TUBE</td> <td>0.250</td> <td>M</td> </tr> </tbody> </table> | Code | Description | Qty | UOM | EL1251A0 | 1-WAY WATER SOLENOID VALVE | 1 | PZ | VM1224A0 | 65MY 220MM 2 COLOURS SHRINK TUBE | 0.250 | M | | | | | | | | | | | | | | | | | | | | | | | | | | | | | | | | |
| | | | | | Code | Description | Qty | UOM | | | | | | | | | | | | | | | | | | | | | | | | | | | | | | | | | | | | | | | | | |
| EL1251A0 | 1-WAY WATER SOLENOID VALVE | 1 | PZ | | | | | | | | | | | | | | | | | | | | | | | | | | | | | | | | | | | | | | | | | | | | | | |
| VM1224A0 | 65MY 220MM 2 COLOURS SHRINK TUBE | 0.250 | M | | | | | | | | | | | | | | | | | | | | | | | | | | | | | | | | | | | | | | | | | | | | | | |
| OH3020A | MOTOR SHAFT SEALING DISC |  | OH3020A1 | MOTOR SHAFT SEALING DISC | | | | | | | | | | | | | | | | | | | | | | | | | | | | | | | | | | | | | | | | | | | | | |
| MT1012A | 330W 230V MOTOR |  | KVN1130A | LUX =08.2017/S.5/S.5E 330W MOTOR KIT | <table border="1"> <thead> <tr> <th>Code</th> <th>Description</th> <th>Qty</th> <th>UOM</th> </tr> </thead> <tbody> <tr> <td>OH4305A1</td> <td>ST. STEEL MOTOR SHAFT SEALING DISC</td> <td>1</td> <td>PZ</td> </tr> <tr> <td>GN1140A2</td> <td>MOTOR HOLDER GASKET</td> <td>1</td> <td>PZ</td> </tr> <tr> <td>GN1140A3</td> <td>MOLDED MOTOR HOLDER GASKET</td> <td>1</td> <td>PZ</td> </tr> <tr> <td>VI1045A0</td> <td>16X8,4 TH=1,6 ST.STEEL WASHER</td> <td>1</td> <td>PZ</td> </tr> <tr> <td>VI1256A0</td> <td>M8 DIN 980M ST. STEEL SELF LOCKING NUT</td> <td>1</td> <td>PZ</td> </tr> <tr> <td>VM1794A0</td> <td>250X4.8 PA66 BLACK CLAMP</td> <td>4</td> <td>PZ</td> </tr> <tr> <td>VM2103A0</td> <td>CLAMP LOCK</td> <td>4</td> <td>PZ</td> </tr> <tr> <td>VM2196A0</td> <td>MOTOR NUT FASTENING BUSHING</td> <td>1</td> <td>PZ</td> </tr> <tr> <td>VN1130A1</td> <td>330W 230V 50/60HZ MOTO</td> <td>1</td> <td>PZ</td> </tr> <tr> <td>VN1130A1</td> <td>330W 230V 50/60HZ MOTO</td> <td>1</td> <td>PZ</td> </tr> </tbody> </table> | Code | Description | Qty | UOM | OH4305A1 | ST. STEEL MOTOR SHAFT SEALING DISC | 1 | PZ | GN1140A2 | MOTOR HOLDER GASKET | 1 | PZ | GN1140A3 | MOLDED MOTOR HOLDER GASKET | 1 | PZ | VI1045A0 | 16X8,4 TH=1,6 ST.STEEL WASHER | 1 | PZ | VI1256A0 | M8 DIN 980M ST. STEEL SELF LOCKING NUT | 1 | PZ | VM1794A0 | 250X4.8 PA66 BLACK CLAMP | 4 | PZ | VM2103A0 | CLAMP LOCK | 4 | PZ | VM2196A0 | MOTOR NUT FASTENING BUSHING | 1 | PZ | VN1130A1 | 330W 230V 50/60HZ MOTO | 1 | PZ | VN1130A1 | 330W 230V 50/60HZ MOTO | 1 | PZ |
| | | | | | Code | Description | Qty | UOM | | | | | | | | | | | | | | | | | | | | | | | | | | | | | | | | | | | | | | | | | |
| | | | | | OH4305A1 | ST. STEEL MOTOR SHAFT SEALING DISC | 1 | PZ | | | | | | | | | | | | | | | | | | | | | | | | | | | | | | | | | | | | | | | | | |
| | | | | | GN1140A2 | MOTOR HOLDER GASKET | 1 | PZ | | | | | | | | | | | | | | | | | | | | | | | | | | | | | | | | | | | | | | | | | |
| | | | | | GN1140A3 | MOLDED MOTOR HOLDER GASKET | 1 | PZ | | | | | | | | | | | | | | | | | | | | | | | | | | | | | | | | | | | | | | | | | |
| | | | | | VI1045A0 | 16X8,4 TH=1,6 ST.STEEL WASHER | 1 | PZ | | | | | | | | | | | | | | | | | | | | | | | | | | | | | | | | | | | | | | | | | |
| | | | | | VI1256A0 | M8 DIN 980M ST. STEEL SELF LOCKING NUT | 1 | PZ | | | | | | | | | | | | | | | | | | | | | | | | | | | | | | | | | | | | | | | | | |
| | | | | | VM1794A0 | 250X4.8 PA66 BLACK CLAMP | 4 | PZ | | | | | | | | | | | | | | | | | | | | | | | | | | | | | | | | | | | | | | | | | |
| | | | | | VM2103A0 | CLAMP LOCK | 4 | PZ | | | | | | | | | | | | | | | | | | | | | | | | | | | | | | | | | | | | | | | | | |
| | | | | | VM2196A0 | MOTOR NUT FASTENING BUSHING | 1 | PZ | | | | | | | | | | | | | | | | | | | | | | | | | | | | | | | | | | | | | | | | | |
| | | | | | VN1130A1 | 330W 230V 50/60HZ MOTO | 1 | PZ | | | | | | | | | | | | | | | | | | | | | | | | | | | | | | | | | | | | | | | | | |
| | | | | | VN1130A1 | 330W 230V 50/60HZ MOTO | 1 | PZ | | | | | | | | | | | | | | | | | | | | | | | | | | | | | | | | | | | | | | | | | |
| | | | | | KMT1012A | MIND.MAPS 330W 230V MOTOR KIT | | <table border="1"> <thead> <tr> <th>Code</th> <th>Description</th> <th>Qty</th> <th>UOM</th> </tr> </thead> <tbody> <tr> <td>OH2842A0</td> <td></td> <td>1</td> <td>PZ</td> </tr> </tbody> </table> | Code | Description | Qty | UOM | OH2842A0 | | 1 | PZ | | | | | | | | | | | | | | | | | | | | | | | | | | | | | | | | | |
| | | | | | Code | Description | Qty | UOM | | | | | | | | | | | | | | | | | | | | | | | | | | | | | | | | | | | | | | | | | |
| | | | | | OH2842A0 | | 1 | PZ | | | | | | | | | | | | | | | | | | | | | | | | | | | | | | | | | | | | | | | | | |

| COMPONENT | | | SPARE PART | | | | | | | | | | | | | | | | | | | | | | | | | | | | | | | | | | | | | | | | | | | | | | | | | | | | | | |
|-----------|------------------------------------|---|------------|-------------------------------------|--|---|-------------|-----|-----|----------|---|---|----|----------|--|---|----|----------|-------------------------------------|---|----|-----------|------------------------------------|-------|----|----------|--------------------|---|----|----------|-------------------------------|---|----|----------|------------------------|---|----|----------|--|---|----|----------|----------------------------|---|----|----------|-----------------------|---|----|----------|-----------------------------|---|----|----------|------------|---|----|
| Code | Description | Image | Code | Description | Components list | | | | | | | | | | | | | | | | | | | | | | | | | | | | | | | | | | | | | | | | | | | | | | | | | | | | |
| MT1012A | 330W 230V MOTOR |  | KMT1012A | MIND.MAPS 330W 230V MOTOR KIT | <table border="1"> <thead> <tr> <th>Code</th> <th>Description</th> <th>Qty</th> <th>UOM</th> </tr> </thead> <tbody> <tr> <td>0H4305A1</td> <td>ST. STEEL MOTOR SHAFT SEALING DISC</td> <td>1</td> <td>PZ</td> </tr> <tr> <td>GN1140A2</td> <td>MOTOR HOLDER GASKET</td> <td>1</td> <td>PZ</td> </tr> <tr> <td>GN1140A3</td> <td>MOLDED MOTOR HOLDER GASKET</td> <td>1</td> <td>PZ</td> </tr> <tr> <td>MOV0007A0</td> <td>HOOD RING GASKET GN1110A2</td> <td>0.100</td> <td>PZ</td> </tr> <tr> <td>MT1012A0</td> <td>330W 230V MOTOR</td> <td>1</td> <td>PZ</td> </tr> <tr> <td>VE1550A0</td> <td>5X3 MM NEODYMIUM MAGNET</td> <td>1</td> <td>PZ</td> </tr> <tr> <td>VI1077A1</td> <td>SCREW M6X12 TE INOX</td> <td>1</td> <td>PZ</td> </tr> <tr> <td>VI1521A0</td> <td>STAINLESS STEEL WASHER D=6 6592</td> <td>1</td> <td>PZ</td> </tr> <tr> <td>VI1966A0</td> <td>M4X14 FLATHEAD SCREW</td> <td>1</td> <td>PZ</td> </tr> <tr> <td>VM1635A0</td> <td>MAGNET HOLDING DIS</td> <td>1</td> <td>PZ</td> </tr> <tr> <td>VM1794A0</td> <td>250X4.8 PA66 BLACK CLAMP</td> <td>4</td> <td>PZ</td> </tr> <tr> <td>VM2103A0</td> <td>CLAMP LOCK</td> <td>4</td> <td>PZ</td> </tr> </tbody> </table> | Code | Description | Qty | UOM | 0H4305A1 | ST. STEEL MOTOR SHAFT SEALING DISC | 1 | PZ | GN1140A2 | MOTOR HOLDER GASKET | 1 | PZ | GN1140A3 | MOLDED MOTOR HOLDER GASKET | 1 | PZ | MOV0007A0 | HOOD RING GASKET GN1110A2 | 0.100 | PZ | MT1012A0 | 330W 230V MOTOR | 1 | PZ | VE1550A0 | 5X3 MM NEODYMIUM MAGNET | 1 | PZ | VI1077A1 | SCREW M6X12 TE INOX | 1 | PZ | VI1521A0 | STAINLESS STEEL WASHER D=6 6592 | 1 | PZ | VI1966A0 | M4X14 FLATHEAD SCREW | 1 | PZ | VM1635A0 | MAGNET HOLDING DIS | 1 | PZ | VM1794A0 | 250X4.8 PA66 BLACK CLAMP | 4 | PZ | VM2103A0 | CLAMP LOCK | 4 | PZ |
| | | | | | Code | Description | Qty | UOM | | | | | | | | | | | | | | | | | | | | | | | | | | | | | | | | | | | | | | | | | | | | | | | | | |
| | | | | | 0H4305A1 | ST. STEEL MOTOR SHAFT SEALING DISC | 1 | PZ | | | | | | | | | | | | | | | | | | | | | | | | | | | | | | | | | | | | | | | | | | | | | | | | | |
| | | | | | GN1140A2 | MOTOR HOLDER GASKET | 1 | PZ | | | | | | | | | | | | | | | | | | | | | | | | | | | | | | | | | | | | | | | | | | | | | | | | | |
| | | | | | GN1140A3 | MOLDED MOTOR HOLDER GASKET | 1 | PZ | | | | | | | | | | | | | | | | | | | | | | | | | | | | | | | | | | | | | | | | | | | | | | | | | |
| | | | | | MOV0007A0 | HOOD RING GASKET GN1110A2 | 0.100 | PZ | | | | | | | | | | | | | | | | | | | | | | | | | | | | | | | | | | | | | | | | | | | | | | | | | |
| | | | | | MT1012A0 | 330W 230V MOTOR | 1 | PZ | | | | | | | | | | | | | | | | | | | | | | | | | | | | | | | | | | | | | | | | | | | | | | | | | |
| | | | | | VE1550A0 | 5X3 MM NEODYMIUM MAGNET | 1 | PZ | | | | | | | | | | | | | | | | | | | | | | | | | | | | | | | | | | | | | | | | | | | | | | | | | |
| | | | | | VI1077A1 | SCREW M6X12 TE INOX | 1 | PZ | | | | | | | | | | | | | | | | | | | | | | | | | | | | | | | | | | | | | | | | | | | | | | | | | |
| | | | | | VI1521A0 | STAINLESS STEEL WASHER D=6 6592 | 1 | PZ | | | | | | | | | | | | | | | | | | | | | | | | | | | | | | | | | | | | | | | | | | | | | | | | | |
| | | | | | VI1966A0 | M4X14 FLATHEAD SCREW | 1 | PZ | | | | | | | | | | | | | | | | | | | | | | | | | | | | | | | | | | | | | | | | | | | | | | | | | |
| | | | | | VM1635A0 | MAGNET HOLDING DIS | 1 | PZ | | | | | | | | | | | | | | | | | | | | | | | | | | | | | | | | | | | | | | | | | | | | | | | | | |
| | | | | | VM1794A0 | 250X4.8 PA66 BLACK CLAMP | 4 | PZ | | | | | | | | | | | | | | | | | | | | | | | | | | | | | | | | | | | | | | | | | | | | | | | | | |
| VM2103A0 | CLAMP LOCK | 4 | PZ | | | | | | | | | | | | | | | | | | | | | | | | | | | | | | | | | | | | | | | | | | | | | | | | | | | | | | |
| VN1172A | M8 NUT 8 BLADES H40 D195 FAN |  | KVN1172A | D195 H40 8 BLADES FAN+NUT M8 KIT | <table border="1"> <thead> <tr> <th>Code</th> <th>Description</th> <th>Qty</th> <th>UOM</th> </tr> </thead> <tbody> <tr> <td>VI1077A1</td> <td>SCREW M6X12 TE INOX</td> <td>1</td> <td>PZ</td> </tr> <tr> <td>VI1521A0</td> <td>STAINLESS STEEL WASHER D=6 6592</td> <td>1</td> <td>PZ</td> </tr> <tr> <td>VN1172A0</td> <td>M8 NUT 8 BLADES H40 D195 FAN</td> <td>1</td> <td>PZ</td> </tr> <tr> <td>VN1172A0</td> <td>M8 NUT 8 BLADES H40 D195 FAN</td> <td>1</td> <td>PZ</td> </tr> </tbody> </table> | Code | Description | Qty | UOM | VI1077A1 | SCREW M6X12 TE INOX | 1 | PZ | VI1521A0 | STAINLESS STEEL WASHER D=6 6592 | 1 | PZ | VN1172A0 | M8 NUT 8 BLADES H40 D195 FAN | 1 | PZ | VN1172A0 | M8 NUT 8 BLADES H40 D195 FAN | 1 | PZ | | | | | | | | | | | | | | | | | | | | | | | | | | | | | | | | |
| | | | | | Code | Description | Qty | UOM | | | | | | | | | | | | | | | | | | | | | | | | | | | | | | | | | | | | | | | | | | | | | | | | | |
| | | | | | VI1077A1 | SCREW M6X12 TE INOX | 1 | PZ | | | | | | | | | | | | | | | | | | | | | | | | | | | | | | | | | | | | | | | | | | | | | | | | | |
| | | | | | VI1521A0 | STAINLESS STEEL WASHER D=6 6592 | 1 | PZ | | | | | | | | | | | | | | | | | | | | | | | | | | | | | | | | | | | | | | | | | | | | | | | | | |
| VN1172A0 | M8 NUT 8 BLADES H40 D195 FAN | 1 | PZ | | | | | | | | | | | | | | | | | | | | | | | | | | | | | | | | | | | | | | | | | | | | | | | | | | | | | | |
| VN1172A0 | M8 NUT 8 BLADES H40 D195 FAN | 1 | PZ | | | | | | | | | | | | | | | | | | | | | | | | | | | | | | | | | | | | | | | | | | | | | | | | | | | | | | |

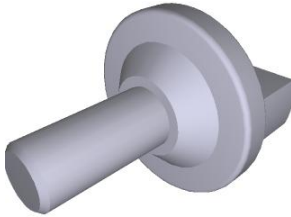
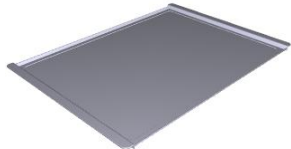
| COMPONENT | | | SPARE PART | | | | | | | | | | | | | | | | | | | | | | | | | | | | | | |
|-----------|--|---|------------|--|---|------|-------------|-----|-----|----------|------------------------------|---|----|----------|--|-------|----|----------|--|---|----|----------|--------------------------------------|---|----|----------|-----------------------------|---|----|----------|------------|---|----|
| Code | Description | Image | Code | Description | Components list | | | | | | | | | | | | | | | | | | | | | | | | | | | | |
| GN1547A | SHAFT GASKET D11.8 |  | KG1547A | D11.6 MOTOR SHAFT GASKET 3PCS KIT | <table border="1"> <thead> <tr> <th>Code</th> <th>Description</th> <th>Qty</th> <th>UOM</th> </tr> </thead> <tbody> <tr> <td>GN1547A1</td> <td>SHAFT GASKET D11.8</td> <td>3</td> <td>PZ</td> </tr> <tr> <td>VM1224A0</td> <td>65MY 220MM 2 COLOURS SHRINK TUBE</td> <td>0.200</td> <td>M</td> </tr> </tbody> </table> | Code | Description | Qty | UOM | GN1547A1 | SHAFT GASKET D11.8 | 3 | PZ | VM1224A0 | 65MY 220MM 2 COLOURS SHRINK TUBE | 0.200 | M | | | | | | | | | | | | | | | | |
| Code | Description | Qty | UOM | | | | | | | | | | | | | | | | | | | | | | | | | | | | | | |
| GN1547A1 | SHAFT GASKET D11.8 | 3 | PZ | | | | | | | | | | | | | | | | | | | | | | | | | | | | | | |
| VM1224A0 | 65MY 220MM 2 COLOURS SHRINK TUBE | 0.200 | M | | | | | | | | | | | | | | | | | | | | | | | | | | | | | | |
| 0H7170A | MM MOTOR GLASS WOOL PLATE |  | 0H7170A0 | MM MOTOR GLASS WOOL PLATE | | | | | | | | | | | | | | | | | | | | | | | | | | | | | |
| RS1282A | 2700W 230V+210W 160V 4TURNS H60 ELEMENT |  | KRS1282A | 4TURN HEAT ELEM 2700W 230V+210W 160V KIT | <table border="1"> <thead> <tr> <th>Code</th> <th>Description</th> <th>Qty</th> <th>UOM</th> </tr> </thead> <tbody> <tr> <td>GN1327A0</td> <td>HEATING ELEMENT GASKET</td> <td>1</td> <td>PZ</td> </tr> <tr> <td>RS1282A0</td> <td>2700W 230V+210W 160V 4TURNS H60 ELEMENT</td> <td>1</td> <td>PZ</td> </tr> <tr> <td>SL1045A0</td> <td>S57 BLACK SILICONE - 80ML CARTRIDGE</td> <td>1</td> <td>PZ</td> </tr> <tr> <td>VI1220A1</td> <td>4,2X12 TCB SELF-TAPPIN G SCREW</td> <td>1</td> <td>PZ</td> </tr> <tr> <td>VM1794A0</td> <td>250X4.8 PA66 BLACK CLAMP</td> <td>2</td> <td>PZ</td> </tr> <tr> <td>VM2103A0</td> <td>CLAMP LOCK</td> <td>2</td> <td>PZ</td> </tr> </tbody> </table> | Code | Description | Qty | UOM | GN1327A0 | HEATING ELEMENT GASKET | 1 | PZ | RS1282A0 | 2700W 230V+210W 160V 4TURNS H60 ELEMENT | 1 | PZ | SL1045A0 | S57 BLACK SILICONE - 80ML CARTRIDGE | 1 | PZ | VI1220A1 | 4,2X12 TCB SELF-TAPPIN G SCREW | 1 | PZ | VM1794A0 | 250X4.8 PA66 BLACK CLAMP | 2 | PZ | VM2103A0 | CLAMP LOCK | 2 | PZ |
| Code | Description | Qty | UOM | | | | | | | | | | | | | | | | | | | | | | | | | | | | | | |
| GN1327A0 | HEATING ELEMENT GASKET | 1 | PZ | | | | | | | | | | | | | | | | | | | | | | | | | | | | | | |
| RS1282A0 | 2700W 230V+210W 160V 4TURNS H60 ELEMENT | 1 | PZ | | | | | | | | | | | | | | | | | | | | | | | | | | | | | | |
| SL1045A0 | S57 BLACK SILICONE - 80ML CARTRIDGE | 1 | PZ | | | | | | | | | | | | | | | | | | | | | | | | | | | | | | |
| VI1220A1 | 4,2X12 TCB SELF-TAPPIN G SCREW | 1 | PZ | | | | | | | | | | | | | | | | | | | | | | | | | | | | | | |
| VM1794A0 | 250X4.8 PA66 BLACK CLAMP | 2 | PZ | | | | | | | | | | | | | | | | | | | | | | | | | | | | | | |
| VM2103A0 | CLAMP LOCK | 2 | PZ | | | | | | | | | | | | | | | | | | | | | | | | | | | | | | |
| TB1574A | FUME CHIMNEY D30 SHOP PRO |  | TB1574A0 | FUME CHIMNEY D30 SHOP PRO | | | | | | | | | | | | | | | | | | | | | | | | | | | | | |

| COMPONENT | | | SPARE PART | | | | | | | | | | | | | | |
|-----------|---|---|------------|---|---|------|-------------|-----|-----|----------|---|-------|---|----------|--|-------|----|
| Code | Description | Image | Code | Description | Components list | | | | | | | | | | | | |
| TB1568A | ARI-STE-ROS SP WELDED EXT HUMIDITY PIPE |  | TB1568A0 | ARI-STE-ROS SP WELDED EXT HUMIDITY PIPE | | | | | | | | | | | | | |
| GN1596A | |  | KG1596A | BL SHOP.PRO STEFANIA DOOR GASKET KIT | <table border="1"> <thead> <tr> <th>Code</th> <th>Description</th> <th>Qty</th> <th>UOM</th> </tr> </thead> <tbody> <tr> <td>GN1110A2</td> <td>LINE MISS/XVC105- 055/XK/XL DOOR GASKE</td> <td>1.500</td> <td>M</td> </tr> <tr> <td>VM1224A0</td> <td>65MY 220MM 2 COLOURS SHRINK TUBE</td> <td>0.350</td> <td>M</td> </tr> </tbody> </table> | Code | Description | Qty | UOM | GN1110A2 | LINE MISS/XVC105- 055/XK/XL DOOR GASKE | 1.500 | M | VM1224A0 | 65MY 220MM 2 COLOURS SHRINK TUBE | 0.350 | M |
| Code | Description | Qty | UOM | | | | | | | | | | | | | | |
| GN1110A2 | LINE MISS/XVC105- 055/XK/XL DOOR GASKE | 1.500 | M | | | | | | | | | | | | | | |
| VM1224A0 | 65MY 220MM 2 COLOURS SHRINK TUBE | 0.350 | M | | | | | | | | | | | | | | |
| 0G1651B | STEFANIA SP FAN GUARD |  | 0G1651B0 | STEFANIA SP FAN GUARD | | | | | | | | | | | | | |
| VM1815A | LATERAL SUPPORTS FIXING BOLT |  | KVM1815A | MISS/MICRO/S4/S3 THUMB SCREW 10 PCS KIT | <table border="1"> <thead> <tr> <th>Code</th> <th>Description</th> <th>Qty</th> <th>UOM</th> </tr> </thead> <tbody> <tr> <td>VM1224A0</td> <td>65MY 220MM 2 COLOURS SHRINK TUBE</td> <td>0.200</td> <td>M</td> </tr> <tr> <td>VM1815A0</td> <td>LATERAL SUPPORTS FIXING BOLT</td> <td>10</td> <td>PZ</td> </tr> </tbody> </table> | Code | Description | Qty | UOM | VM1224A0 | 65MY 220MM 2 COLOURS SHRINK TUBE | 0.200 | M | VM1815A0 | LATERAL SUPPORTS FIXING BOLT | 10 | PZ |
| Code | Description | Qty | UOM | | | | | | | | | | | | | | |
| VM1224A0 | 65MY 220MM 2 COLOURS SHRINK TUBE | 0.200 | M | | | | | | | | | | | | | | |
| VM1815A0 | LATERAL SUPPORTS FIXING BOLT | 10 | PZ | | | | | | | | | | | | | | |
| ATG305 | TRAY 460X330 FLAT ALUMINIUM |  | ATG3050 | TRAY 460X330 FLAT ALUMINIUM | | | | | | | | | | | | | |



| COMPONENT | | | SPARE PART | | | | | | | | | | | | | | | | | | |
|-----------|---|--|------------|--|---|------|-------------|-----|-----|-----------|---|---|----|----------|---|---|---|----------|--------------------------|-------|---|
| Code | Description | Image | Code | Description | Components list | | | | | | | | | | | | | | | | |
| GRL1005A | LINEMISS STEFANIA RIGHT/LEFT LAT. GRID |  | KGRL1005A | R/L CHROM. PLATED LATERAL SUPP KIT | <table border="1"> <thead> <tr> <th>Code</th> <th>Description</th> <th>Qty</th> <th>UOM</th> </tr> </thead> <tbody> <tr> <td>GRL1005A2</td> <td>LINEMISS STEFANIA RIGHT/LEFT LAT. GRID</td> <td>2</td> <td>PZ</td> </tr> <tr> <td>IP1508A1</td> <td>POLYSTYREN E U SHAPED PROFILE 2000X60X60</td> <td>2</td> <td>M</td> </tr> <tr> <td>VM1059A1</td> <td>HEAT SHRINK FILM H800</td> <td>1.500</td> <td>M</td> </tr> </tbody> </table> | Code | Description | Qty | UOM | GRL1005A2 | LINEMISS STEFANIA RIGHT/LEFT LAT. GRID | 2 | PZ | IP1508A1 | POLYSTYREN E U SHAPED PROFILE 2000X60X60 | 2 | M | VM1059A1 | HEAT SHRINK FILM H800 | 1.500 | M |
| Code | Description | Qty | UOM | | | | | | | | | | | | | | | | | | |
| GRL1005A2 | LINEMISS STEFANIA RIGHT/LEFT LAT. GRID | 2 | PZ | | | | | | | | | | | | | | | | | | |
| IP1508A1 | POLYSTYREN E U SHAPED PROFILE 2000X60X60 | 2 | M | | | | | | | | | | | | | | | | | | |
| VM1059A1 | HEAT SHRINK FILM H800 | 1.500 | M | | | | | | | | | | | | | | | | | | |
| TB1577B | STEFANIA SP INTERNAL HUMIDITY PIPE |  | TB1577B0 | STEFANIA SP INTERNAL HUMIDITY PIPE | | | | | | | | | | | | | | | | | |



ASM3407A/0.D01 - External cover

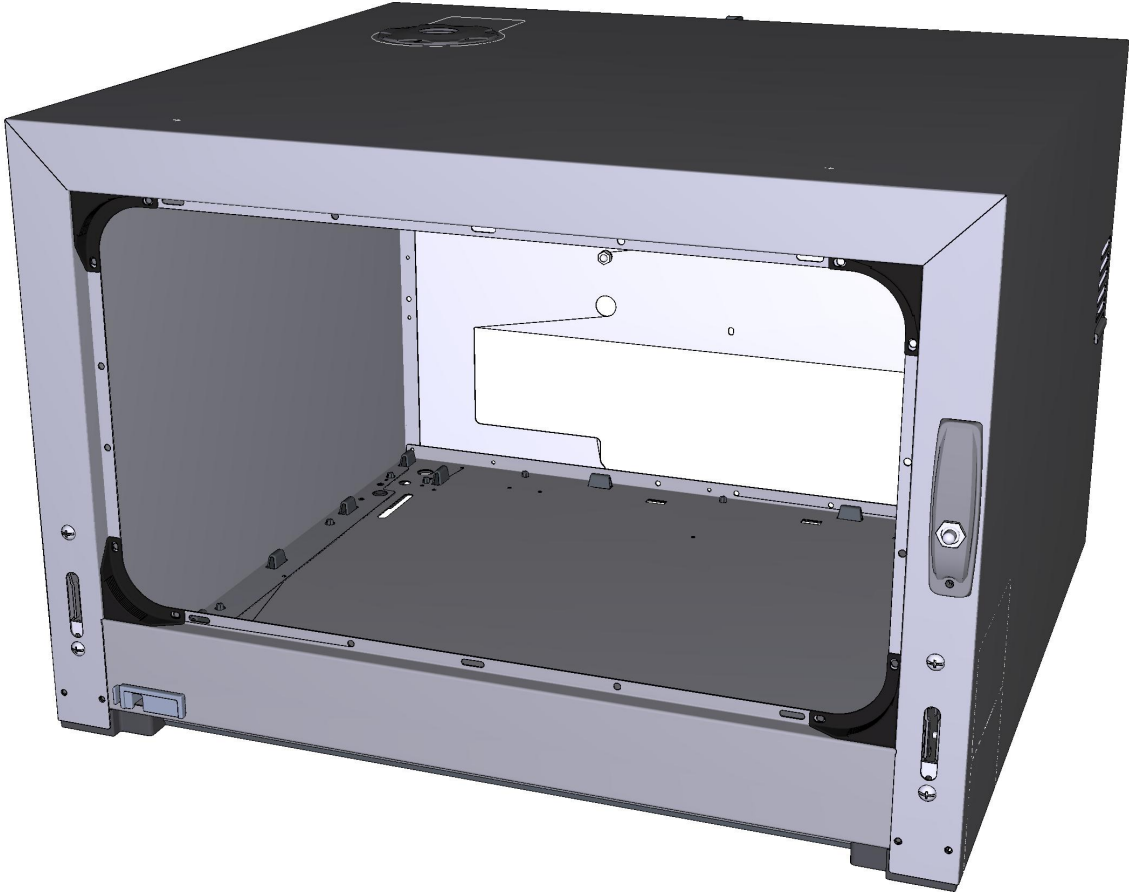

FRONT



ASM3407A/0.D01 - External cover



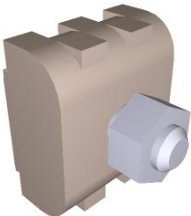

REAR



| COMPONENT | | | SPARE PART | | | | | | | | | | | | | | | | | | |
|-----------|--|---|------------|--|---|------|-------------|-----|-----|----------|----------------------------------|-------|----|----------|------------------------------|---|----|----------|----------------------------------|-------|---|
| Code | Description | Image | Code | Description | Components list | | | | | | | | | | | | | | | | |
| VM1750A | BRASS COMB CLAM |  | KVM1750A | COMB TERMINAL BLOCK KIT | <table border="1"> <thead> <tr> <th>Code</th> <th>Description</th> <th>Qty</th> <th>UOM</th> </tr> </thead> <tbody> <tr> <td>VM1224A0</td> <td>65MY 220MM 2 COLOURS SHRINK TUBE</td> <td>0.150</td> <td>M</td> </tr> <tr> <td>VM1750A0</td> <td>BRASS COMB CLAMP</td> <td>1</td> <td>PZ</td> </tr> </tbody> </table> | Code | Description | Qty | UOM | VM1224A0 | 65MY 220MM 2 COLOURS SHRINK TUBE | 0.150 | M | VM1750A0 | BRASS COMB CLAMP | 1 | PZ | | | | |
| Code | Description | Qty | UOM | | | | | | | | | | | | | | | | | | |
| VM1224A0 | 65MY 220MM 2 COLOURS SHRINK TUBE | 0.150 | M | | | | | | | | | | | | | | | | | | |
| VM1750A0 | BRASS COMB CLAMP | 1 | PZ | | | | | | | | | | | | | | | | | | |
| CR1000A | HINGE LATCH L.M. |  | KCR1000A | LM HINGES LATCH KIT | <table border="1"> <thead> <tr> <th>Code</th> <th>Description</th> <th>Qty</th> <th>UOM</th> </tr> </thead> <tbody> <tr> <td>CR1000A0</td> <td>HINGE LATCH L.M.</td> <td>1</td> <td>PZ</td> </tr> <tr> <td>VI1875A0</td> <td>SCREW M5X10 TC1/2T INOX</td> <td>2</td> <td>PZ</td> </tr> <tr> <td>VM1224A0</td> <td>65MY 220MM 2 COLOURS SHRINK TUBE</td> <td>0.200</td> <td>M</td> </tr> </tbody> </table> | Code | Description | Qty | UOM | CR1000A0 | HINGE LATCH L.M. | 1 | PZ | VI1875A0 | SCREW M5X10 TC1/2T INOX | 2 | PZ | VM1224A0 | 65MY 220MM 2 COLOURS SHRINK TUBE | 0.200 | M |
| Code | Description | Qty | UOM | | | | | | | | | | | | | | | | | | |
| CR1000A0 | HINGE LATCH L.M. | 1 | PZ | | | | | | | | | | | | | | | | | | |
| VI1875A0 | SCREW M5X10 TC1/2T INOX | 2 | PZ | | | | | | | | | | | | | | | | | | |
| VM1224A0 | 65MY 220MM 2 COLOURS SHRINK TUBE | 0.200 | M | | | | | | | | | | | | | | | | | | |
| VM2249A | COOKING CHAMBER FRONT CORNER |  | KVM2249A | CHAMBER FRONT PROFILE CORNER KIT | <table border="1"> <thead> <tr> <th>Code</th> <th>Description</th> <th>Qty</th> <th>UOM</th> </tr> </thead> <tbody> <tr> <td>VM1224A0</td> <td>65MY 220MM 2 COLOURS SHRINK TUBE</td> <td>0.150</td> <td>M</td> </tr> <tr> <td>VM2249A0</td> <td>COOKING CHAMBER FRONT CORNER</td> <td>1</td> <td>PZ</td> </tr> </tbody> </table> | Code | Description | Qty | UOM | VM1224A0 | 65MY 220MM 2 COLOURS SHRINK TUBE | 0.150 | M | VM2249A0 | COOKING CHAMBER FRONT CORNER | 1 | PZ | | | | |
| Code | Description | Qty | UOM | | | | | | | | | | | | | | | | | | |
| VM1224A0 | 65MY 220MM 2 COLOURS SHRINK TUBE | 0.150 | M | | | | | | | | | | | | | | | | | | |
| VM2249A0 | COOKING CHAMBER FRONT CORNER | 1 | PZ | | | | | | | | | | | | | | | | | | |
| 0D2409A | SP600 INF FRONT PROFILE DROP DOWN DOOR |  | 0D2409A0 | SP600 INF FRONT PROFILE DROP DOWN DOOR | | | | | | | | | | | | | | | | | |
| 0E1381A | SP600 EXTERNAL BOTTOM PANEL |  | 0E1381A0 | SP600 EXTERNAL BOTTOM PANEL | | | | | | | | | | | | | | | | | |

| COMPONENT | | | SPARE PART | | | | | | | | | | | | | | | | | | |
|-----------|---|---|------------|--|--|------|-------------|-----|-----|----------|--|-------|----|----------|---|-------|----|----------|---|---|----|
| Code | Description | Image | Code | Description | Components list | | | | | | | | | | | | | | | | |
| VM2502A | BAKERLUX SHOP.PRO CHIMNEY RING |  | KVM2502A | BAKERLUX SHOP.PRO CHIMNEY RING KIT | <table border="1"> <thead> <tr> <th>Code</th> <th>Description</th> <th>Qty</th> <th>UOM</th> </tr> </thead> <tbody> <tr> <td>VM1224A0</td> <td>65MY 220MM 2 COLOURS SHRINK TUBE</td> <td>0.300</td> <td>M</td> </tr> <tr> <td>VM2502A0</td> <td>BAKERLUX SHOP.PRO CHIMNEY RIN</td> <td>1</td> <td>PZ</td> </tr> <tr> <td>VM2502A0</td> <td>BAKERLUX SHOP.PRO CHIMNEY RIN</td> <td>1</td> <td>PZ</td> </tr> </tbody> </table> | Code | Description | Qty | UOM | VM1224A0 | 65MY 220MM 2 COLOURS SHRINK TUBE | 0.300 | M | VM2502A0 | BAKERLUX SHOP.PRO CHIMNEY RIN | 1 | PZ | VM2502A0 | BAKERLUX SHOP.PRO CHIMNEY RIN | 1 | PZ |
| Code | Description | Qty | UOM | | | | | | | | | | | | | | | | | | |
| VM1224A0 | 65MY 220MM 2 COLOURS SHRINK TUBE | 0.300 | M | | | | | | | | | | | | | | | | | | |
| VM2502A0 | BAKERLUX SHOP.PRO CHIMNEY RIN | 1 | PZ | | | | | | | | | | | | | | | | | | |
| VM2502A0 | BAKERLUX SHOP.PRO CHIMNEY RIN | 1 | PZ | | | | | | | | | | | | | | | | | | |
| VE1295A | MK 16A 230V DOOR MICROSWITCH |  | KVE1295A | 16A 230V DOOR MICROSWITCH KIT | <table border="1"> <thead> <tr> <th>Code</th> <th>Description</th> <th>Qty</th> <th>UOM</th> </tr> </thead> <tbody> <tr> <td>VE1295A0</td> <td>MK 16A 230V DOOR MICROSWITC</td> <td>1</td> <td>PZ</td> </tr> <tr> <td>VM1224A0</td> <td>65MY 220MM 2 COLOURS SHRINK TUBE</td> <td>0.300</td> <td>M</td> </tr> </tbody> </table> | Code | Description | Qty | UOM | VE1295A0 | MK 16A 230V DOOR MICROSWITC | 1 | PZ | VM1224A0 | 65MY 220MM 2 COLOURS SHRINK TUBE | 0.300 | M | | | | |
| Code | Description | Qty | UOM | | | | | | | | | | | | | | | | | | |
| VE1295A0 | MK 16A 230V DOOR MICROSWITC | 1 | PZ | | | | | | | | | | | | | | | | | | |
| VM1224A0 | 65MY 220MM 2 COLOURS SHRINK TUBE | 0.300 | M | | | | | | | | | | | | | | | | | | |
| VM2508A | BAKERLUX SHOP.PRO DOOR SWITCH COVER |  | KVM2508A | BAKERLUX SHOP.PRO MICROSWITCH COVER KIT | <table border="1"> <thead> <tr> <th>Code</th> <th>Description</th> <th>Qty</th> <th>UOM</th> </tr> </thead> <tbody> <tr> <td>VM1224A0</td> <td>65MY 220MM 2 COLOURS SHRINK TUBE</td> <td>0.300</td> <td>M</td> </tr> <tr> <td>VM2508A0</td> <td>BAKERLUX SHOP.PRO DOOR SWITCH COVE</td> <td>1</td> <td>PZ</td> </tr> <tr> <td>VM2508A0</td> <td>BAKERLUX SHOP.PRO DOOR SWITCH COVE</td> <td>1</td> <td>PZ</td> </tr> </tbody> </table> | Code | Description | Qty | UOM | VM1224A0 | 65MY 220MM 2 COLOURS SHRINK TUBE | 0.300 | M | VM2508A0 | BAKERLUX SHOP.PRO DOOR SWITCH COVE | 1 | PZ | VM2508A0 | BAKERLUX SHOP.PRO DOOR SWITCH COVE | 1 | PZ |
| Code | Description | Qty | UOM | | | | | | | | | | | | | | | | | | |
| VM1224A0 | 65MY 220MM 2 COLOURS SHRINK TUBE | 0.300 | M | | | | | | | | | | | | | | | | | | |
| VM2508A0 | BAKERLUX SHOP.PRO DOOR SWITCH COVE | 1 | PZ | | | | | | | | | | | | | | | | | | |
| VM2508A0 | BAKERLUX SHOP.PRO DOOR SWITCH COVE | 1 | PZ | | | | | | | | | | | | | | | | | | |
| VM2481A | FRONT EXTERNAL COVER LEFT CAP S |  | KVM2481A | BL SP LEFT EXT COVER FRONT PANEL CAP KIT | <table border="1"> <thead> <tr> <th>Code</th> <th>Description</th> <th>Qty</th> <th>UOM</th> </tr> </thead> <tbody> <tr> <td>VM1224A0</td> <td>65MY 220MM 2 COLOURS SHRINK TUBE</td> <td>0.150</td> <td>M</td> </tr> <tr> <td>VM2481A0</td> <td>FRONT EXTERNAL COVER LEFT CAP SP</td> <td>1</td> <td>PZ</td> </tr> <tr> <td>VM2481A0</td> <td>FRONT EXTERNAL COVER LEFT CAP SP</td> <td>1</td> <td>PZ</td> </tr> </tbody> </table> | Code | Description | Qty | UOM | VM1224A0 | 65MY 220MM 2 COLOURS SHRINK TUBE | 0.150 | M | VM2481A0 | FRONT EXTERNAL COVER LEFT CAP SP | 1 | PZ | VM2481A0 | FRONT EXTERNAL COVER LEFT CAP SP | 1 | PZ |
| Code | Description | Qty | UOM | | | | | | | | | | | | | | | | | | |
| VM1224A0 | 65MY 220MM 2 COLOURS SHRINK TUBE | 0.150 | M | | | | | | | | | | | | | | | | | | |
| VM2481A0 | FRONT EXTERNAL COVER LEFT CAP SP | 1 | PZ | | | | | | | | | | | | | | | | | | |
| VM2481A0 | FRONT EXTERNAL COVER LEFT CAP SP | 1 | PZ | | | | | | | | | | | | | | | | | | |



| COMPONENT | | | SPARE PART | | | | | | | | | | | | | | | | | | | | | | | | | | | | | | |
|-----------|---|---|------------|--|---|--|-------------|-----|-----|----------|----------------------------------|-------|----|----------|-----------------------------------|----|----|----------|------------------------------------|---|----|----------|--|---|----|----------|--|---|----|----------|----------------------------------|---|----|
| Code | Description | Image | Code | Description | Components list | | | | | | | | | | | | | | | | | | | | | | | | | | | | |
| VM2480A | FRONT EXTERNAL COVER RIGHT CAP SP |  | KVM2480A | BL SP RIGHT EXT COVER FRONT PANEL CAP | <table border="1"> <thead> <tr> <th>Code</th> <th>Description</th> <th>Qty</th> <th>UOM</th> </tr> </thead> <tbody> <tr> <td>VM1224A0</td> <td>65MY 220MM 2 COLOURS SHRINK TUBE</td> <td>0.150</td> <td>M</td> </tr> <tr> <td>VM2480A0</td> <td>FRONT EXTERNAL COVER RIGHT CAP SP</td> <td>1</td> <td>PZ</td> </tr> <tr> <td>VM2480A0</td> <td>FRONT EXTERNAL COVER RIGHT CAP SP</td> <td>1</td> <td>PZ</td> </tr> </tbody> </table> | Code | Description | Qty | UOM | VM1224A0 | 65MY 220MM 2 COLOURS SHRINK TUBE | 0.150 | M | VM2480A0 | FRONT EXTERNAL COVER RIGHT CAP SP | 1 | PZ | VM2480A0 | FRONT EXTERNAL COVER RIGHT CAP SP | 1 | PZ | | | | | | | | | | | | |
| | | | | | Code | Description | Qty | UOM | | | | | | | | | | | | | | | | | | | | | | | | | |
| | | | | | VM1224A0 | 65MY 220MM 2 COLOURS SHRINK TUBE | 0.150 | M | | | | | | | | | | | | | | | | | | | | | | | | | |
| | | | | | VM2480A0 | FRONT EXTERNAL COVER RIGHT CAP SP | 1 | PZ | | | | | | | | | | | | | | | | | | | | | | | | | |
| VM2480A0 | FRONT EXTERNAL COVER RIGHT CAP SP | 1 | PZ | | | | | | | | | | | | | | | | | | | | | | | | | | | | | | |
| VM1631A | PLUS INNER GLASS PUSHING CAP |  | KVM1631A | CAP FOR INTERNAL GLASS 10 PCS KIT | <table border="1"> <thead> <tr> <th>Code</th> <th>Description</th> <th>Qty</th> <th>UOM</th> </tr> </thead> <tbody> <tr> <td>VM1224A0</td> <td>65MY 220MM 2 COLOURS SHRINK TUBE</td> <td>0.200</td> <td>M</td> </tr> <tr> <td>VM1631A0</td> <td>PLUS INNER GLASS PUSHING CAP</td> <td>10</td> <td>PZ</td> </tr> </tbody> </table> | Code | Description | Qty | UOM | VM1224A0 | 65MY 220MM 2 COLOURS SHRINK TUBE | 0.200 | M | VM1631A0 | PLUS INNER GLASS PUSHING CAP | 10 | PZ | | | | | | | | | | | | | | | | |
| Code | Description | Qty | UOM | | | | | | | | | | | | | | | | | | | | | | | | | | | | | | |
| VM1224A0 | 65MY 220MM 2 COLOURS SHRINK TUBE | 0.200 | M | | | | | | | | | | | | | | | | | | | | | | | | | | | | | | |
| VM1631A0 | PLUS INNER GLASS PUSHING CAP | 10 | PZ | | | | | | | | | | | | | | | | | | | | | | | | | | | | | | |
| VM2490A | 460X330 SP EXT FRONT BOTTOM GASKET |  | KVM2490A | SP 460X330 EXT BOTTOM PANEL GASKET KIT | <table border="1"> <thead> <tr> <th>Code</th> <th>Description</th> <th>Qty</th> <th>UOM</th> </tr> </thead> <tbody> <tr> <td>VM1794A0</td> <td>250X4.8 PA66 BLACK CLAMP</td> <td>1</td> <td>PZ</td> </tr> <tr> <td>VM2103A0</td> <td>CLAMP LOCK</td> <td>1</td> <td>PZ</td> </tr> <tr> <td>VM2490A0</td> <td>460X330 SP EXT FRONT BOTTOM GASKET</td> <td>2</td> <td>PZ</td> </tr> <tr> <td>VM2490A0</td> <td>460X330 SP EXT FRONT BOTTOM GASKET</td> <td>2</td> <td>PZ</td> </tr> </tbody> </table> | Code | Description | Qty | UOM | VM1794A0 | 250X4.8 PA66 BLACK CLAMP | 1 | PZ | VM2103A0 | CLAMP LOCK | 1 | PZ | VM2490A0 | 460X330 SP EXT FRONT BOTTOM GASKET | 2 | PZ | VM2490A0 | 460X330 SP EXT FRONT BOTTOM GASKET | 2 | PZ | | | | | | | | |
| | | | | | Code | Description | Qty | UOM | | | | | | | | | | | | | | | | | | | | | | | | | |
| | | | | | VM1794A0 | 250X4.8 PA66 BLACK CLAMP | 1 | PZ | | | | | | | | | | | | | | | | | | | | | | | | | |
| | | | | | VM2103A0 | CLAMP LOCK | 1 | PZ | | | | | | | | | | | | | | | | | | | | | | | | | |
| VM2490A0 | 460X330 SP EXT FRONT BOTTOM GASKET | 2 | PZ | | | | | | | | | | | | | | | | | | | | | | | | | | | | | | |
| VM2490A0 | 460X330 SP EXT FRONT BOTTOM GASKET | 2 | PZ | | | | | | | | | | | | | | | | | | | | | | | | | | | | | | |
| VM2491A | 460X330 BL SP LATER BOTTOM PANEL GASKET |  | KVM2491A | SP 460X330 LAT BOTT PANEL GASKET 2PC KIT | <table border="1"> <thead> <tr> <th>Code</th> <th>Description</th> <th>Qty</th> <th>UOM</th> </tr> </thead> <tbody> <tr> <td>VM1631A0</td> <td>PLUS INNER GLASS PUSHING CAP</td> <td>4</td> <td>PZ</td> </tr> <tr> <td>VM1794A0</td> <td>250X4.8 PA66 BLACK CLAMP</td> <td>1</td> <td>PZ</td> </tr> <tr> <td>VM2103A0</td> <td>CLAMP LOCK</td> <td>1</td> <td>PZ</td> </tr> <tr> <td>VM2491A0</td> <td>460X330 BL SP LATER BOTTOM PANEL GASKE</td> <td>2</td> <td>PZ</td> </tr> <tr> <td>VM2491A0</td> <td>460X330 BL SP LATER BOTTOM PANEL GASKE</td> <td>2</td> <td>PZ</td> </tr> <tr> <td>VM2491A1</td> <td>SP600 LATERAL BOTTOM PANEL GASKE</td> <td>2</td> <td>PZ</td> </tr> </tbody> </table> | Code | Description | Qty | UOM | VM1631A0 | PLUS INNER GLASS PUSHING CAP | 4 | PZ | VM1794A0 | 250X4.8 PA66 BLACK CLAMP | 1 | PZ | VM2103A0 | CLAMP LOCK | 1 | PZ | VM2491A0 | 460X330 BL SP LATER BOTTOM PANEL GASKE | 2 | PZ | VM2491A0 | 460X330 BL SP LATER BOTTOM PANEL GASKE | 2 | PZ | VM2491A1 | SP600 LATERAL BOTTOM PANEL GASKE | 2 | PZ |
| | | | | | Code | Description | Qty | UOM | | | | | | | | | | | | | | | | | | | | | | | | | |
| | | | | | VM1631A0 | PLUS INNER GLASS PUSHING CAP | 4 | PZ | | | | | | | | | | | | | | | | | | | | | | | | | |
| | | | | | VM1794A0 | 250X4.8 PA66 BLACK CLAMP | 1 | PZ | | | | | | | | | | | | | | | | | | | | | | | | | |
| | | | | | VM2103A0 | CLAMP LOCK | 1 | PZ | | | | | | | | | | | | | | | | | | | | | | | | | |
| | | | | | VM2491A0 | 460X330 BL SP LATER BOTTOM PANEL GASKE | 2 | PZ | | | | | | | | | | | | | | | | | | | | | | | | | |
| VM2491A0 | 460X330 BL SP LATER BOTTOM PANEL GASKE | 2 | PZ | | | | | | | | | | | | | | | | | | | | | | | | | | | | | | |
| VM2491A1 | SP600 LATERAL BOTTOM PANEL GASKE | 2 | PZ | | | | | | | | | | | | | | | | | | | | | | | | | | | | | | |

| COMPONENT | | | SPARE PART | | | | | | | | | | | | | | | | | | |
|-----------|--|---|------------|--|--|------|-------------|-----|-----|----------|---------------------------------------|-------|----|----------|---------------------------------------|---|----|----------|---------------------------------------|---|----|
| Code | Description | Image | Code | Description | Components list | | | | | | | | | | | | | | | | |
| VM1222A | CABLE LOCKS SP ACCESSORIES EL CONNECTION |  | VM1222A0 | CABLE LOCKS SP ACCESSORIES EL CONNECTION | | | | | | | | | | | | | | | | | |
| VM2455A | BL SP CONTROL BOARD CABLE PASSAGE CLIP |  | KVM2455A | BL SP CONTR BOARD PASSAGE CABLE CLIP KIT | <table border="1"> <thead> <tr> <th>Code</th> <th>Description</th> <th>Qty</th> <th>UOM</th> </tr> </thead> <tbody> <tr> <td>VM1224A0</td> <td>65MY 220MM 2 COLOURS SHRINK TUBE</td> <td>0.150</td> <td>M</td> </tr> <tr> <td>VM2455A0</td> <td>BL SP CONTROL BOARD CABLE PASSAGE CLI</td> <td>1</td> <td>PZ</td> </tr> <tr> <td>VM2455A0</td> <td>BL SP CONTROL BOARD CABLE PASSAGE CLI</td> <td>1</td> <td>PZ</td> </tr> </tbody> </table> | Code | Description | Qty | UOM | VM1224A0 | 65MY 220MM 2 COLOURS SHRINK TUBE | 0.150 | M | VM2455A0 | BL SP CONTROL BOARD CABLE PASSAGE CLI | 1 | PZ | VM2455A0 | BL SP CONTROL BOARD CABLE PASSAGE CLI | 1 | PZ |
| Code | Description | Qty | UOM | | | | | | | | | | | | | | | | | | |
| VM1224A0 | 65MY 220MM 2 COLOURS SHRINK TUBE | 0.150 | M | | | | | | | | | | | | | | | | | | |
| VM2455A0 | BL SP CONTROL BOARD CABLE PASSAGE CLI | 1 | PZ | | | | | | | | | | | | | | | | | | |
| VM2455A0 | BL SP CONTROL BOARD CABLE PASSAGE CLI | 1 | PZ | | | | | | | | | | | | | | | | | | |
| VN1175A | 230V 50/60HZ 120X120 COOLING DOWN FAN |  | KVN1175A | 120X120 230V 50/60HZ COOLING FAN KIT | <table border="1"> <thead> <tr> <th>Code</th> <th>Description</th> <th>Qty</th> <th>UOM</th> </tr> </thead> <tbody> <tr> <td>VN1175A0</td> <td>230V 50/60HZ 120X120 COOLING DOWN FAN</td> <td>1</td> <td>PZ</td> </tr> <tr> <td>VN1175A0</td> <td>230V 50/60HZ 120X120 COOLING DOWN FAN</td> <td>1</td> <td>PZ</td> </tr> </tbody> </table> | Code | Description | Qty | UOM | VN1175A0 | 230V 50/60HZ 120X120 COOLING DOWN FAN | 1 | PZ | VN1175A0 | 230V 50/60HZ 120X120 COOLING DOWN FAN | 1 | PZ | | | | |
| Code | Description | Qty | UOM | | | | | | | | | | | | | | | | | | |
| VN1175A0 | 230V 50/60HZ 120X120 COOLING DOWN FAN | 1 | PZ | | | | | | | | | | | | | | | | | | |
| VN1175A0 | 230V 50/60HZ 120X120 COOLING DOWN FAN | 1 | PZ | | | | | | | | | | | | | | | | | | |
| VM2495A | SP COOLING FAN SUPPORT |  | KVM2495A | COOLING FAN SUPPORT KIT | <table border="1"> <thead> <tr> <th>Code</th> <th>Description</th> <th>Qty</th> <th>UOM</th> </tr> </thead> <tbody> <tr> <td>V11220A1</td> <td>4.2X12 TCB SELF-TAPPIN G SCREW</td> <td>2</td> <td>PZ</td> </tr> <tr> <td>VM2495A0</td> <td>SP COOLING FAN SUPPORT</td> <td>1</td> <td>PZ</td> </tr> </tbody> </table> | Code | Description | Qty | UOM | V11220A1 | 4.2X12 TCB SELF-TAPPIN G SCREW | 2 | PZ | VM2495A0 | SP COOLING FAN SUPPORT | 1 | PZ | | | | |
| Code | Description | Qty | UOM | | | | | | | | | | | | | | | | | | |
| V11220A1 | 4.2X12 TCB SELF-TAPPIN G SCREW | 2 | PZ | | | | | | | | | | | | | | | | | | |
| VM2495A0 | SP COOLING FAN SUPPORT | 1 | PZ | | | | | | | | | | | | | | | | | | |
| 0D2401B | |  | 0D2401B0 | | | | | | | | | | | | | | | | | | |



| COMPONENT | | | SPARE PART | | |
|-------------|---------------------------|---|-------------|---------------------------|------------------------|
| <i>Code</i> | <i>Description</i> | <i>Image</i> | <i>Code</i> | <i>Description</i> | <i>Components list</i> |
| 0F1541B | STEFANIA SP BACK PANEL |  | 0F1541B0 | STEFANIA SP BACK PANEL | |