

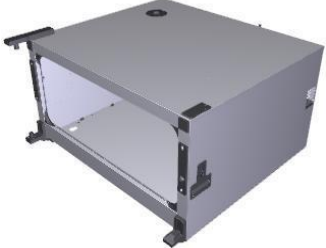



Assembly code	Assembly description	Assembly image
ASM3403A/0.D01	Cooking chamber	
ASM3415A/0.D01	External cover	
ASM3429B/0.D00	Door	
ASM8226A/0.D00	Electrical system	



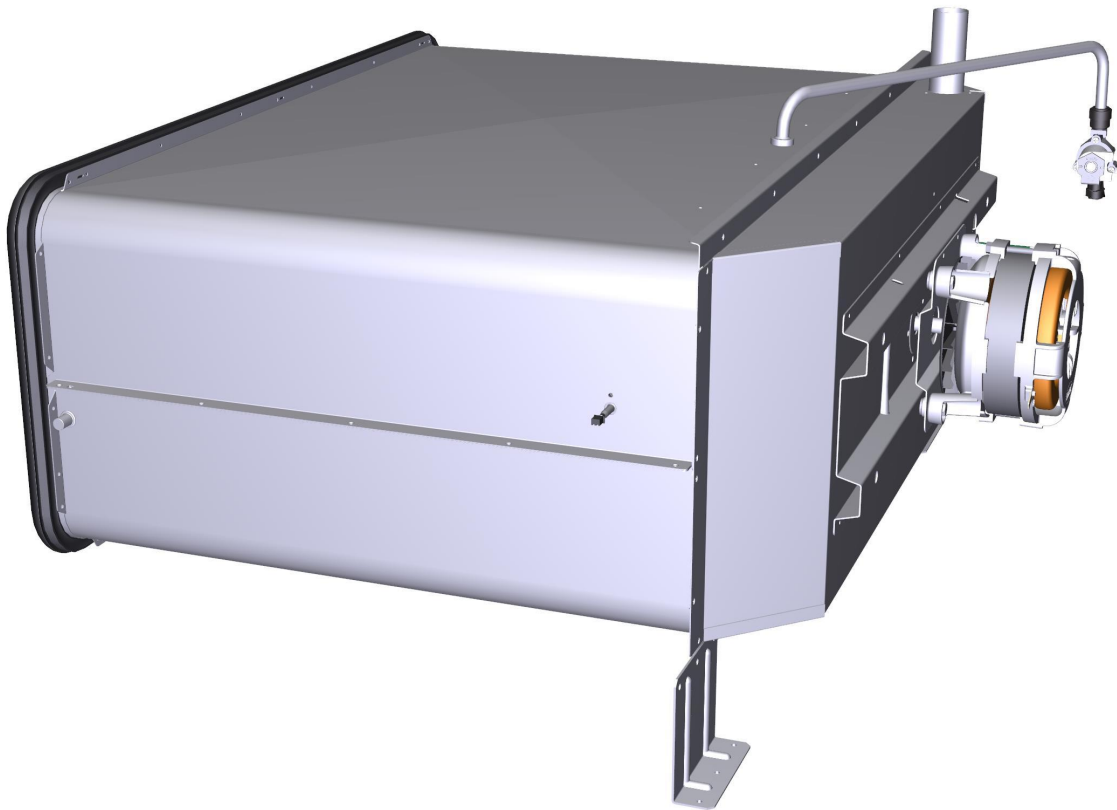

ASM3403A/0.D01 - Cooking chamber - FRONT





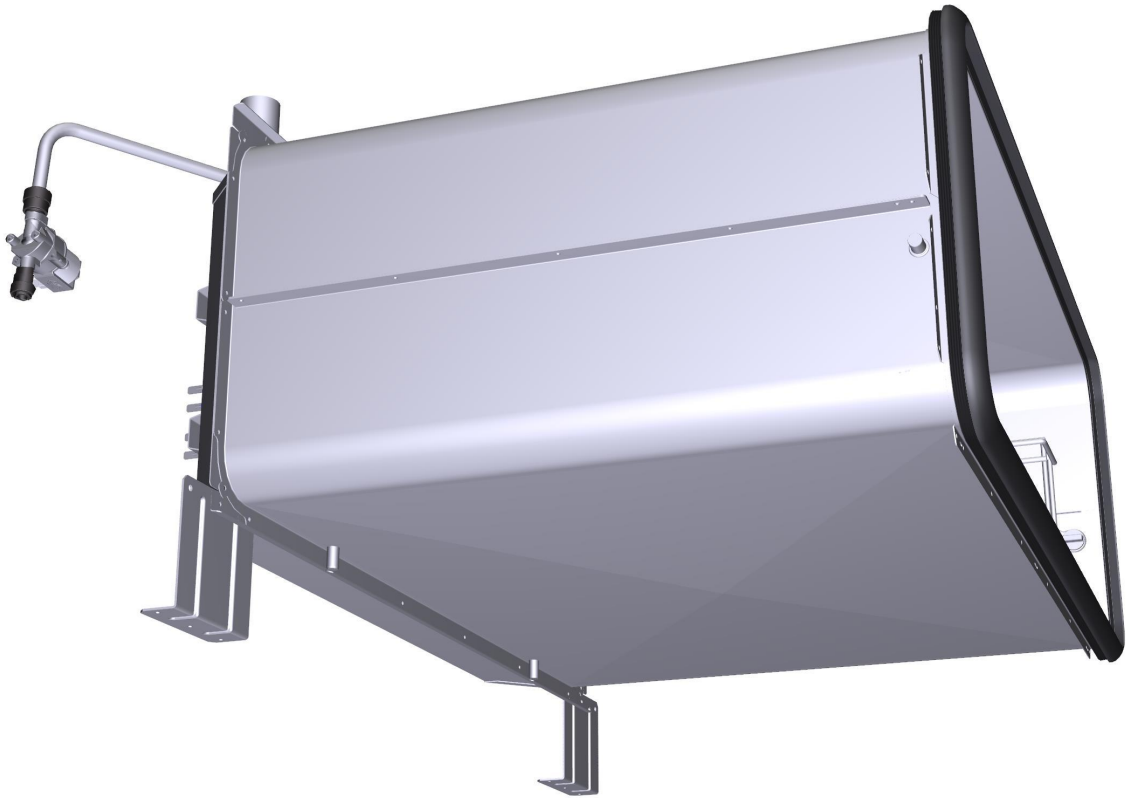



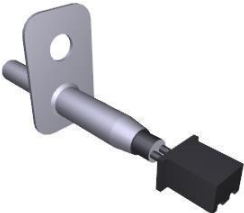



ASM3403A/0.D01 - Cooking chamber - REAR

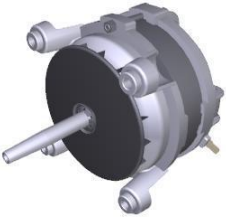



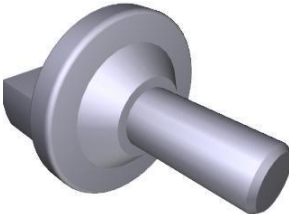

COMPONENT			SPARE PART																																										
Code	Description	Image	Code	Description	Kit components																																								
0G1653A	ELENA SHOP PRO FAN GUARD		0G1653A1	ELENA SHOP PRO FAN GUARD																																									
0H7875A	SHOP.PRO MUFFLE SUPPORT BRACKET		0H7875A1	SHOP.PRO MUFFLE SUPPORT BRACKET																																									
TR1105A	SONDA TEMPERATURA PT100 L1000		KTR1105A	PT100 L1000 TEMPERATURE PROBE KIT	<table border="1"> <thead> <tr> <th>Code</th> <th>Description</th> <th>Qty</th> <th>UOM</th> </tr> </thead> <tbody> <tr> <td>0H4302A0</td> <td>PIASTRINA SILICONE SONDE</td> <td>1.000</td> <td>PZ</td> </tr> <tr> <td>GN1120A1</td> <td>GUARNIZIONE SONDA TEMPERATUR A NTC LM</td> <td>1.000</td> <td>PZ</td> </tr> <tr> <td>GN1285A0</td> <td>GUARNIZIONE SONDA DI TEMPERATUR A NTC</td> <td>1.000</td> <td>PZ</td> </tr> <tr> <td>SL1045A0</td> <td>SILICONE ANTRACITE S57 80 ml</td> <td>1.000</td> <td>PZ</td> </tr> <tr> <td>TR1105A4</td> <td>SONDA TEMPERATUR A PT100 L1000</td> <td>1.000</td> <td>PZ</td> </tr> <tr> <td>VI1220A1</td> <td>VITE AUTOFIL. 4.2X11 TCS+ MARUTEX</td> <td>2.000</td> <td>PZ</td> </tr> <tr> <td>VM1464A1</td> <td>COPERCHIO SONDA TEMPERATUR A CT BT CON PA</td> <td>1.000</td> <td>PZ</td> </tr> <tr> <td>VM1465A1</td> <td>COPERCHIO SONDA TEMPERATUR A CT BT</td> <td>1.000</td> <td>PZ</td> </tr> <tr> <td>VM2052A0</td> <td>COPERCHIO SONDA TEMPERATUR A LM</td> <td>1.000</td> <td>PZ</td> </tr> </tbody> </table>	Code	Description	Qty	UOM	0H4302A0	PIASTRINA SILICONE SONDE	1.000	PZ	GN1120A1	GUARNIZIONE SONDA TEMPERATUR A NTC LM	1.000	PZ	GN1285A0	GUARNIZIONE SONDA DI TEMPERATUR A NTC	1.000	PZ	SL1045A0	SILICONE ANTRACITE S57 80 ml	1.000	PZ	TR1105A4	SONDA TEMPERATUR A PT100 L1000	1.000	PZ	VI1220A1	VITE AUTOFIL. 4.2X11 TCS+ MARUTEX	2.000	PZ	VM1464A1	COPERCHIO SONDA TEMPERATUR A CT BT CON PA	1.000	PZ	VM1465A1	COPERCHIO SONDA TEMPERATUR A CT BT	1.000	PZ	VM2052A0	COPERCHIO SONDA TEMPERATUR A LM	1.000	PZ
Code	Description	Qty	UOM																																										
0H4302A0	PIASTRINA SILICONE SONDE	1.000	PZ																																										
GN1120A1	GUARNIZIONE SONDA TEMPERATUR A NTC LM	1.000	PZ																																										
GN1285A0	GUARNIZIONE SONDA DI TEMPERATUR A NTC	1.000	PZ																																										
SL1045A0	SILICONE ANTRACITE S57 80 ml	1.000	PZ																																										
TR1105A4	SONDA TEMPERATUR A PT100 L1000	1.000	PZ																																										
VI1220A1	VITE AUTOFIL. 4.2X11 TCS+ MARUTEX	2.000	PZ																																										
VM1464A1	COPERCHIO SONDA TEMPERATUR A CT BT CON PA	1.000	PZ																																										
VM1465A1	COPERCHIO SONDA TEMPERATUR A CT BT	1.000	PZ																																										
VM2052A0	COPERCHIO SONDA TEMPERATUR A LM	1.000	PZ																																										

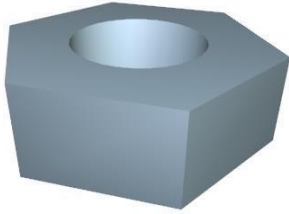
COMPONENT			SPARE PART																						
Code	Description	Image	Code	Description	Kit components																				
EL1251A	ELETTROVALVOLA H2O 1 VIA RID. MARRONE		KEL1251A	JG D8-D10 1 WAY SOLENOID VALVE KI	<table border="1"> <thead> <tr> <th>Code</th> <th>Description</th> <th>Qty</th> <th>UOM</th> </tr> </thead> <tbody> <tr> <td>EL1251A0</td> <td>ELETTROVALV OLA H2O 1 VIA RID. MARRON</td> <td>1.000</td> <td>PZ</td> </tr> </tbody> </table>	Code	Description	Qty	UOM	EL1251A0	ELETTROVALV OLA H2O 1 VIA RID. MARRON	1.000	PZ												
Code	Description	Qty	UOM																						
EL1251A0	ELETTROVALV OLA H2O 1 VIA RID. MARRON	1.000	PZ																						
0H3020A	DISCO TENUTA ALBERO MOTORE		K0H3020A	CRANKSHAFT SEAL DISC	<table border="1"> <thead> <tr> <th>Code</th> <th>Description</th> <th>Qty</th> <th>UOM</th> </tr> </thead> <tbody> <tr> <td>0H3020A1</td> <td>DISCO TENUTA ALBERO MOTORE</td> <td>1.000</td> <td>PZ</td> </tr> <tr> <td>GN1546A0</td> <td>GUARNIZIONE ALBERO MOTORE D8</td> <td>1.000</td> <td>PZ</td> </tr> </tbody> </table>	Code	Description	Qty	UOM	0H3020A1	DISCO TENUTA ALBERO MOTORE	1.000	PZ	GN1546A0	GUARNIZIONE ALBERO MOTORE D8	1.000	PZ								
Code	Description	Qty	UOM																						
0H3020A1	DISCO TENUTA ALBERO MOTORE	1.000	PZ																						
GN1546A0	GUARNIZIONE ALBERO MOTORE D8	1.000	PZ																						
0H7170A	MM MOTOR GLASS WOOL PLATE		0H7170A0	MM MOTOR GLASS WOOL PLATE																					
GN1547A	GUARNIZIONE ALBERO MOTORE D11.8		KGN1547A	D11.6 MOTOR SHAFT GASKET 3PCS KIT	<table border="1"> <thead> <tr> <th>Code</th> <th>Description</th> <th>Qty</th> <th>UOM</th> </tr> </thead> <tbody> <tr> <td>GN1547A1</td> <td>GUARNIZIONE ALBERO MOTORE D11.</td> <td>3.000</td> <td>PZ</td> </tr> </tbody> </table>	Code	Description	Qty	UOM	GN1547A1	GUARNIZIONE ALBERO MOTORE D11.	3.000	PZ												
Code	Description	Qty	UOM																						
GN1547A1	GUARNIZIONE ALBERO MOTORE D11.	3.000	PZ																						
MT1012A	MOTORE SIMMETRICO 330W 230V ALBERO D12		KVN1130A	LUX ≤08.2017/L.MISS/S.5/ 5E MOTOR KIT	<table border="1"> <thead> <tr> <th>Code</th> <th>Description</th> <th>Qty</th> <th>UOM</th> </tr> </thead> <tbody> <tr> <td>0H8118A0</td> <td>DISCO TENUTA ALBERO MOTORE XEVL</td> <td>1.000</td> <td>PZ</td> </tr> <tr> <td>GN1140A3</td> <td>GUARNIZIONE PORTAMOTO RE STAMPAT</td> <td>1.000</td> <td>PZ</td> </tr> <tr> <td>VI1034A0</td> <td>RONDELLA PIANA 8.4x16x1 INOX</td> <td>1.000</td> <td>PZ</td> </tr> <tr> <td>VI1256A0</td> <td>DADO M8 DIN 980M AUTOBLOCCA NTE INOX</td> <td>1.000</td> <td>PZ</td> </tr> </tbody> </table>	Code	Description	Qty	UOM	0H8118A0	DISCO TENUTA ALBERO MOTORE XEVL	1.000	PZ	GN1140A3	GUARNIZIONE PORTAMOTO RE STAMPAT	1.000	PZ	VI1034A0	RONDELLA PIANA 8.4x16x1 INOX	1.000	PZ	VI1256A0	DADO M8 DIN 980M AUTOBLOCCA NTE INOX	1.000	PZ
Code	Description	Qty	UOM																						
0H8118A0	DISCO TENUTA ALBERO MOTORE XEVL	1.000	PZ																						
GN1140A3	GUARNIZIONE PORTAMOTO RE STAMPAT	1.000	PZ																						
VI1034A0	RONDELLA PIANA 8.4x16x1 INOX	1.000	PZ																						
VI1256A0	DADO M8 DIN 980M AUTOBLOCCA NTE INOX	1.000	PZ																						

COMPONENT			SPARE PART																																			
Code	Description	Image	Code	Description	Kit components																																	
MT1012A	MOTORE SIMMETRICO 330W 230V ALBERO D12		KVN1130A	LUX ≤08.2017/L.MISS/S.5/ 5E MOTOR KIT	<table border="1"> <thead> <tr> <th>Code</th> <th>Description</th> <th>Qty</th> <th>UOM</th> </tr> </thead> <tbody> <tr> <td>VM2196A0</td> <td>BOCCOLA FISSAGGIO DADO MOTOR</td> <td>1.000</td> <td>PZ</td> </tr> <tr> <td>VN1130A1</td> <td>MOTORE FORNO 330W 230V 50/60Hz ALBERO M8</td> <td>1.000</td> <td>PZ</td> </tr> </tbody> </table>	Code	Description	Qty	UOM	VM2196A0	BOCCOLA FISSAGGIO DADO MOTOR	1.000	PZ	VN1130A1	MOTORE FORNO 330W 230V 50/60Hz ALBERO M8	1.000	PZ																					
			Code	Description	Qty	UOM																																
VM2196A0	BOCCOLA FISSAGGIO DADO MOTOR	1.000	PZ																																			
VN1130A1	MOTORE FORNO 330W 230V 50/60Hz ALBERO M8	1.000	PZ																																			
KMT1012A	LUX >08.2017 / MIND.MAPS 330W MOTOR KIT	<table border="1"> <thead> <tr> <th>Code</th> <th>Description</th> <th>Qty</th> <th>UOM</th> </tr> </thead> <tbody> <tr> <td>0H2842A0</td> <td>MASCHERA CENTRAGGIO MT1012</td> <td>1.000</td> <td>PZ</td> </tr> <tr> <td>0H8118A0</td> <td>DISCO TENUTA ALBERO MOTORE XEVL</td> <td>1.000</td> <td>PZ</td> </tr> <tr> <td>GN1140A3</td> <td>GUARNIZIONE PORTAMOTO RE STAMPAT</td> <td>1.000</td> <td>PZ</td> </tr> <tr> <td>MT1012A0</td> <td>MOTORE SIMMETRICO 330W 230V ALBERO D12</td> <td>1.000</td> <td>PZ</td> </tr> <tr> <td>VI1077A1</td> <td>VITE M6x12 TE INOX</td> <td>1.000</td> <td>PZ</td> </tr> <tr> <td>VI1521A0</td> <td>RONDELLA PIANA 6x12x1 INOX</td> <td>1.000</td> <td>PZ</td> </tr> <tr> <td>VI1966A1</td> <td>VITE M4X14 TSP+ ZN</td> <td>1.000</td> <td>PZ</td> </tr> <tr> <td>VM2680A0</td> <td>ASM MGT MISURA NUMERO GIRI</td> <td>1.000</td> <td>PZ</td> </tr> </tbody> </table>	Code	Description	Qty	UOM	0H2842A0	MASCHERA CENTRAGGIO MT1012	1.000	PZ	0H8118A0	DISCO TENUTA ALBERO MOTORE XEVL	1.000	PZ	GN1140A3	GUARNIZIONE PORTAMOTO RE STAMPAT	1.000	PZ	MT1012A0	MOTORE SIMMETRICO 330W 230V ALBERO D12	1.000	PZ	VI1077A1	VITE M6x12 TE INOX	1.000	PZ	VI1521A0	RONDELLA PIANA 6x12x1 INOX	1.000	PZ	VI1966A1	VITE M4X14 TSP+ ZN	1.000	PZ	VM2680A0	ASM MGT MISURA NUMERO GIRI	1.000	PZ
Code	Description	Qty	UOM																																			
0H2842A0	MASCHERA CENTRAGGIO MT1012	1.000	PZ																																			
0H8118A0	DISCO TENUTA ALBERO MOTORE XEVL	1.000	PZ																																			
GN1140A3	GUARNIZIONE PORTAMOTO RE STAMPAT	1.000	PZ																																			
MT1012A0	MOTORE SIMMETRICO 330W 230V ALBERO D12	1.000	PZ																																			
VI1077A1	VITE M6x12 TE INOX	1.000	PZ																																			
VI1521A0	RONDELLA PIANA 6x12x1 INOX	1.000	PZ																																			
VI1966A1	VITE M4X14 TSP+ ZN	1.000	PZ																																			
VM2680A0	ASM MGT MISURA NUMERO GIRI	1.000	PZ																																			
VN1181A	VENTOLA D196 H81 39 PALE VITE M6		KVN1181A	D196 H81 39 BLADES FAN+SCREW M6 KIT	<table border="1"> <thead> <tr> <th>Code</th> <th>Description</th> <th>Qty</th> <th>UOM</th> </tr> </thead> <tbody> <tr> <td>VI1077A1</td> <td>VITE M6x12 TE INOX</td> <td>1.000</td> <td>PZ</td> </tr> <tr> <td>VI1521A0</td> <td>RONDELLA PIANA 6x12x1 INOX</td> <td>1.000</td> <td>PZ</td> </tr> <tr> <td>VN1181A0</td> <td>VENTOLA D196 H81 39 PALE VITE M6</td> <td>1.000</td> <td>PZ</td> </tr> </tbody> </table>	Code	Description	Qty	UOM	VI1077A1	VITE M6x12 TE INOX	1.000	PZ	VI1521A0	RONDELLA PIANA 6x12x1 INOX	1.000	PZ	VN1181A0	VENTOLA D196 H81 39 PALE VITE M6	1.000	PZ																	
			Code	Description	Qty	UOM																																
VI1077A1	VITE M6x12 TE INOX	1.000	PZ																																			
VI1521A0	RONDELLA PIANA 6x12x1 INOX	1.000	PZ																																			
VN1181A0	VENTOLA D196 H81 39 PALE VITE M6	1.000	PZ																																			
KVN1030A	LUX ≤08.2017S.5/S.5E D196 FAN KIT	<table border="1"> <thead> <tr> <th>Code</th> <th>Description</th> <th>Qty</th> <th>UOM</th> </tr> </thead> <tbody> <tr> <td>VI1256A0</td> <td>DADO M8 DIN 980M AUTOBLOCCA NTE INOX</td> <td>1.000</td> <td>PZ</td> </tr> <tr> <td>VM2196A0</td> <td>BOCCOLA FISSAGGIO DADO MOTOR</td> <td>1.000</td> <td>PZ</td> </tr> <tr> <td>VN1030A5</td> <td>VENTOLA D196 H81 39 PALE DADO M</td> <td>1.000</td> <td>PZ</td> </tr> </tbody> </table>	Code	Description	Qty	UOM	VI1256A0	DADO M8 DIN 980M AUTOBLOCCA NTE INOX	1.000	PZ	VM2196A0	BOCCOLA FISSAGGIO DADO MOTOR	1.000	PZ	VN1030A5	VENTOLA D196 H81 39 PALE DADO M	1.000	PZ																				
Code	Description	Qty	UOM																																			
VI1256A0	DADO M8 DIN 980M AUTOBLOCCA NTE INOX	1.000	PZ																																			
VM2196A0	BOCCOLA FISSAGGIO DADO MOTOR	1.000	PZ																																			
VN1030A5	VENTOLA D196 H81 39 PALE DADO M	1.000	PZ																																			

COMPONENT			SPARE PART																						
Code	Description	Image	Code	Description	Kit components																				
RS1284A	RES. CIRC. 3200W 230V+400W 190V 4SP H80		KRS1284A	4TURN 3200W 230V+400W 190V HEAT ELEM KIT	<table border="1"> <thead> <tr> <th>Code</th> <th>Description</th> <th>Qty</th> <th>UOM</th> </tr> </thead> <tbody> <tr> <td>GN1327A0</td> <td>GUARNIZIONE RESISTENZA 100x22</td> <td>1.000</td> <td>PZ</td> </tr> <tr> <td>RS1284A0</td> <td>RES. CIRC. 3200W 230V+400W 190V 4SP H80</td> <td>1.000</td> <td>PZ</td> </tr> <tr> <td>SL1045A0</td> <td>SILICONE ANTRACITE S57 80 ml</td> <td>1.000</td> <td>PZ</td> </tr> <tr> <td>VI1220A1</td> <td>VITE AUTOFIL. 4.2X11 TCS+ MARUTEX</td> <td>2.000</td> <td>PZ</td> </tr> </tbody> </table>	Code	Description	Qty	UOM	GN1327A0	GUARNIZIONE RESISTENZA 100x22	1.000	PZ	RS1284A0	RES. CIRC. 3200W 230V+400W 190V 4SP H80	1.000	PZ	SL1045A0	SILICONE ANTRACITE S57 80 ml	1.000	PZ	VI1220A1	VITE AUTOFIL. 4.2X11 TCS+ MARUTEX	2.000	PZ
					Code	Description	Qty	UOM																	
					GN1327A0	GUARNIZIONE RESISTENZA 100x22	1.000	PZ																	
					RS1284A0	RES. CIRC. 3200W 230V+400W 190V 4SP H80	1.000	PZ																	
SL1045A0	SILICONE ANTRACITE S57 80 ml	1.000	PZ																						
VI1220A1	VITE AUTOFIL. 4.2X11 TCS+ MARUTEX	2.000	PZ																						
GRL1015A	GRIGLIA LAT DX/SX 3 600x400 LM ELENA		KGRL1015A	R/L 3 600x400 LM ELENA LATERAL SUPP KIT	<table border="1"> <thead> <tr> <th>Code</th> <th>Description</th> <th>Qty</th> <th>UOM</th> </tr> </thead> <tbody> <tr> <td>GRL1015A0</td> <td>GRIGLIA LAT DX/SX 3 600x400 LM ELENA</td> <td>2.000</td> <td>PZ</td> </tr> </tbody> </table>	Code	Description	Qty	UOM	GRL1015A0	GRIGLIA LAT DX/SX 3 600x400 LM ELENA	2.000	PZ												
					Code	Description	Qty	UOM																	
GRL1015A0	GRIGLIA LAT DX/SX 3 600x400 LM ELENA	2.000	PZ																						
VM1815A	NOTTOLINO M6 CROMATO FISS. GRIGLIE		KVM1815A	MISS/MICRO/S4/S3 THUMB SCREW 10 PCS KIT	<table border="1"> <thead> <tr> <th>Code</th> <th>Description</th> <th>Qty</th> <th>UOM</th> </tr> </thead> <tbody> <tr> <td>VM1815A0</td> <td>NOTTOLINO M6 CROMATO FISS. GRIGLIE</td> <td>10.000</td> <td>PZ</td> </tr> </tbody> </table>	Code	Description	Qty	UOM	VM1815A0	NOTTOLINO M6 CROMATO FISS. GRIGLIE	10.000	PZ												
					Code	Description	Qty	UOM																	
VM1815A0	NOTTOLINO M6 CROMATO FISS. GRIGLIE	10.000	PZ																						
GN1597A	GN1110A - SHOP.PRO ELENA DOOR GASKET		KGN1597A	BL SHOP.PRO ELENA DOOR GASKET KIT	<table border="1"> <thead> <tr> <th>Code</th> <th>Description</th> <th>Qty</th> <th>UOM</th> </tr> </thead> <tbody> <tr> <td>GN1597A1</td> <td>GN1110A-GUA RNIZIONE ELENA SP 1900MM</td> <td>1.000</td> <td>PZ</td> </tr> <tr> <td>VM2277A0</td> <td>SPINA KIT GUARNIZIONE PORTA</td> <td>1.000</td> <td>PZ</td> </tr> </tbody> </table>	Code	Description	Qty	UOM	GN1597A1	GN1110A-GUA RNIZIONE ELENA SP 1900MM	1.000	PZ	VM2277A0	SPINA KIT GUARNIZIONE PORTA	1.000	PZ								
					Code	Description	Qty	UOM																	
GN1597A1	GN1110A-GUA RNIZIONE ELENA SP 1900MM	1.000	PZ																						
VM2277A0	SPINA KIT GUARNIZIONE PORTA	1.000	PZ																						
RC1170A	DADO M14 H7 CH22 INOX DIN 439		KRC1170A	M14 H8 CH22 NUT - 10 PCS. KIT	<table border="1"> <thead> <tr> <th>Code</th> <th>Description</th> <th>Qty</th> <th>UOM</th> </tr> </thead> <tbody> <tr> <td>RC1170A1</td> <td>DADO M14 H7 CH22 INOX DIN 439</td> <td>10.000</td> <td>PZ</td> </tr> </tbody> </table>	Code	Description	Qty	UOM	RC1170A1	DADO M14 H7 CH22 INOX DIN 439	10.000	PZ												
					Code	Description	Qty	UOM																	
RC1170A1	DADO M14 H7 CH22 INOX DIN 439	10.000	PZ																						



COMPONENT			SPARE PART										
Code	Description	Image	Code	Description	Kit components								
TB1574A	FUME CHIMNEY D30 SHOP PRO		TB1574A0	FUME CHIMNEY D30 SHOP PRO									
TB1579A	ELENA SHOP PRO INTERNAL HUMIDITY PIPE		TB1579A0	ELENA SHOP PRO INTERNAL HUMIDITY PIPE									
TB1638A	ELE-VIT-CAM SP WELDED EXT HUMIDITY PIPE		TB1638A0	ELE-VIT-CAM SP WELDED EXT HUMIDITY PIPE									
VM2331A	PERNO M6 FERMA CARTER-SUPPORT O TEGLIE		KVM2331A	FAN GUARD-TRAYS HOLDER PIN 4 PCS KIT	<table border="1"> <thead> <tr> <th>Code</th> <th>Description</th> <th>Qty</th> <th>UOM</th> </tr> </thead> <tbody> <tr> <td>VM2331A0</td> <td>PERNO M6 FERMA CARTER-SUPP ORTO TEGLIE</td> <td>4.000</td> <td>PZ</td> </tr> </tbody> </table>	Code	Description	Qty	UOM	VM2331A0	PERNO M6 FERMA CARTER-SUPP ORTO TEGLIE	4.000	PZ
Code	Description	Qty	UOM										
VM2331A0	PERNO M6 FERMA CARTER-SUPP ORTO TEGLIE	4.000	PZ										



ASM3415A/0.D01 - External cover - FRONT







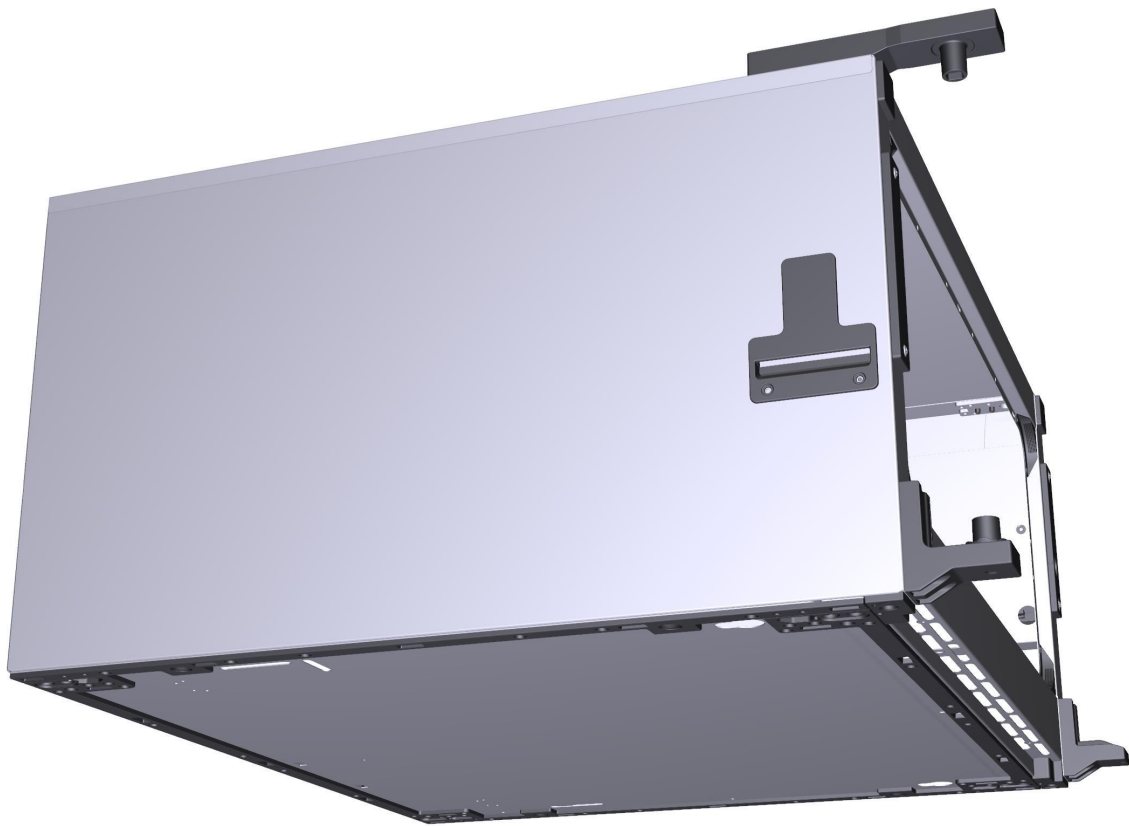



ASM3415A/0.D01 - External cover - REAR



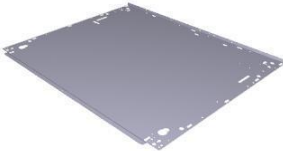











COMPONENT			SPARE PART		
Code	Description	Image	Code	Description	Kit components
0D2412A	SP800 INF FRONT PROFILE RIGHT-LEFT DOOR		0D2412A1	SP800 INF FRONT PROFILE RIGHT-LEFT DOOR	
0D2414A	SP800 COVER		0D2414A1	SP800 COVER	
0D2415B	ELENA SHOP PRO LEFT SIDE		0D2415B0	ELENA SHOP PRO LEFT SIDE	
0D2416B	ELENA SHOP PRO RIGHT SIDE		0D2416B0	ELENA SHOP PRO RIGHT SIDE	
0E1382A	SHOP.Pro800 EXTERNAL BOTTOM PANEL		0E1382A2	SHOP.Pro800 EXTERNAL BOTTOM PANEL	



COMPONENT			SPARE PART																						
Code	Description	Image	Code	Description	Kit components																				
0F1543B	ELENA SP BACK PANEL		0F1543B0	ELENA SP BACK PANEL																					
0H7991A	0H7991A1		K0H7991A	STE-ELE SP RIGHT LOCKING VENTILATION KIT	<table border="1"> <thead> <tr> <th>Code</th> <th>Description</th> <th>Qty</th> <th>UOM</th> </tr> </thead> <tbody> <tr> <td>0H7909A2</td> <td>CANALE AERAZIONE SERRATURA STE-ELE SP</td> <td>1.000</td> <td>PZ</td> </tr> <tr> <td>VI1014A0</td> <td>RONDELLA PIANA 4.5X9X0.8 INO</td> <td>2.000</td> <td>PZ</td> </tr> <tr> <td>VI1024A0</td> <td>VITE M4X12 TCB+ INOX</td> <td>2.000</td> <td>PZ</td> </tr> <tr> <td>VI1716A0</td> <td>INSERTO FILETTATO M4 FTT/C INOX</td> <td>2.000</td> <td>PZ</td> </tr> </tbody> </table>	Code	Description	Qty	UOM	0H7909A2	CANALE AERAZIONE SERRATURA STE-ELE SP	1.000	PZ	VI1014A0	RONDELLA PIANA 4.5X9X0.8 INO	2.000	PZ	VI1024A0	VITE M4X12 TCB+ INOX	2.000	PZ	VI1716A0	INSERTO FILETTATO M4 FTT/C INOX	2.000	PZ
Code	Description	Qty	UOM																						
0H7909A2	CANALE AERAZIONE SERRATURA STE-ELE SP	1.000	PZ																						
VI1014A0	RONDELLA PIANA 4.5X9X0.8 INO	2.000	PZ																						
VI1024A0	VITE M4X12 TCB+ INOX	2.000	PZ																						
VI1716A0	INSERTO FILETTATO M4 FTT/C INOX	2.000	PZ																						
0H7995A	0H7909A-LOCK VENTILATION STE-ELE SP SX		0H7995A1	0H7909A-LOCK VENTILATION STE-ELE SP SX																					
VM1750A	MORSETTO A PETTINE		KVM1750A	COMB TERMINAL BLOCK KIT	<table border="1"> <thead> <tr> <th>Code</th> <th>Description</th> <th>Qty</th> <th>UOM</th> </tr> </thead> <tbody> <tr> <td>VI1040A0</td> <td>ROSETTA DENTELLATA INTERNA ø6 Z</td> <td>2.000</td> <td>PZ</td> </tr> <tr> <td>VM1750A0</td> <td>MORSETTO A PETTINE</td> <td>1.000</td> <td>PZ</td> </tr> </tbody> </table>	Code	Description	Qty	UOM	VI1040A0	ROSETTA DENTELLATA INTERNA ø6 Z	2.000	PZ	VM1750A0	MORSETTO A PETTINE	1.000	PZ								
Code	Description	Qty	UOM																						
VI1040A0	ROSETTA DENTELLATA INTERNA ø6 Z	2.000	PZ																						
VM1750A0	MORSETTO A PETTINE	1.000	PZ																						
CE1297A	BLSP ELECTROMECHANICAL LOCK CABLE		KCE1297A	BL SHOP.PRO CABLE LOCK KIT	<table border="1"> <thead> <tr> <th>Code</th> <th>Description</th> <th>Qty</th> <th>UOM</th> </tr> </thead> <tbody> <tr> <td>CE1295A1</td> <td>CAVO SERRATURA ELETTRICITÀ 1.3M</td> <td>1.000</td> <td>PZ</td> </tr> <tr> <td>CE1735A0</td> <td>TERMINALE MINIFIT FEMMINA</td> <td>4.000</td> <td>PZ</td> </tr> <tr> <td>CE1746A0</td> <td>CONNETTORE MINIFIT MASCHIO 2 VI</td> <td>1.000</td> <td>PZ</td> </tr> <tr> <td>CE1750A0</td> <td>CONNETTORE MINIFIT MASCHIO 3 VI</td> <td>1.000</td> <td>PZ</td> </tr> </tbody> </table>	Code	Description	Qty	UOM	CE1295A1	CAVO SERRATURA ELETTRICITÀ 1.3M	1.000	PZ	CE1735A0	TERMINALE MINIFIT FEMMINA	4.000	PZ	CE1746A0	CONNETTORE MINIFIT MASCHIO 2 VI	1.000	PZ	CE1750A0	CONNETTORE MINIFIT MASCHIO 3 VI	1.000	PZ
Code	Description	Qty	UOM																						
CE1295A1	CAVO SERRATURA ELETTRICITÀ 1.3M	1.000	PZ																						
CE1735A0	TERMINALE MINIFIT FEMMINA	4.000	PZ																						
CE1746A0	CONNETTORE MINIFIT MASCHIO 2 VI	1.000	PZ																						
CE1750A0	CONNETTORE MINIFIT MASCHIO 3 VI	1.000	PZ																						

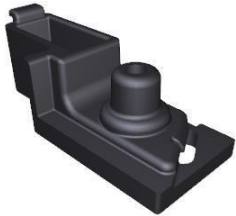

COMPONENT			SPARE PART					
Code	Description	Image	Code	Description	Kit components			
0H1234A	LAMIERA PORTA SERRATURA		K0H1234A	SHOP.PRO LOCK HOLDING PLATE KIT	Code	Description	Qty	UOM
					0H1234A2	LAMIERA PORTA SERRATURA	1.000	PZ
					VI1014A0	RONDELLA PIANA 4.5X9X0.8 INO	2.000	PZ
					VI1024A0	VITE M4X12 TCB+ INOX	2.000	PZ
					VI1850A0	VITE M4X6 TCB+ NICHELATA	2.000	PZ
CR1035A	SERRATURA ELETTROMECC. 12V L.M. MATIC		KCR1035A	LM MATIC ELECTROMECHANICAL LOCK KIT	Code	Description	Qty	UOM
					0H10283A0	DIMA REGOLAZIONE E PERNO SHOPPRO	1.000	PZ
CR1035A0	SERRATURA ELETTROMECC. C. 12V L.M. MATIC				Code	Description	Qty	UOM
					CR1035A0	SERRATURA ELETTROMECC. C. 12V L.M. MATIC	1.000	PZ
VM2154A	COVER ELETTROSERRATURA		KVM2154A	LINEMISS MATIC-TOP LOCKING COVER KIT	Code	Description	Qty	UOM
					0H1234A2	LAMIERA PORTA SERRATURA	1.000	PZ
VM2154A2	COVER ELETTROSERRATURA				Code	Description	Qty	UOM
					VM2154A2	COVER ELETTROSERRATURA	1.000	PZ
VM2290A	COVER CIECA ELETTROSERRATURA		KVM2290A	BLSP BLIND LOCKING COVER KIT	Code	Description	Qty	UOM
					VI1024A0	VITE M4X12 TCB+ INOX	2.000	PZ
VM2290A0	COVER CIECA ELETTROSERRATURA				Code	Description	Qty	UOM
					VM2290A0	COVER CIECA ELETTROSERRATURA	1.000	PZ
VM2502A	ANELLO CAMINO SP		KVM2502A	BAKERLUX SHOP.PRO CHIMNEY RING KIT	Code	Description	Qty	UOM
					VM2502A0	ANELLO CAMINO SP	1.000	PZ

COMPONENT			SPARE PART																						
Code	Description	Image	Code	Description	Kit components																				
VM2495A	SUPPORTO VENTOLA RAFFREDDAMENTO SP		KVM2495A	COOLING FAN SUPPORT KIT	<table border="1"> <thead> <tr> <th>Code</th> <th>Description</th> <th>Qty</th> <th>UOM</th> </tr> </thead> <tbody> <tr> <td>V11220A1</td> <td>VITE AUTOFIL. 4.2X11 TCS+ MARUTEX</td> <td>2.000</td> <td>PZ</td> </tr> <tr> <td>VM2495A0</td> <td>SUPPORTO VENTOLA RAFFREDDAM ENTO SP</td> <td>1.000</td> <td>PZ</td> </tr> </tbody> </table>	Code	Description	Qty	UOM	V11220A1	VITE AUTOFIL. 4.2X11 TCS+ MARUTEX	2.000	PZ	VM2495A0	SUPPORTO VENTOLA RAFFREDDAM ENTO SP	1.000	PZ								
Code	Description	Qty	UOM																						
V11220A1	VITE AUTOFIL. 4.2X11 TCS+ MARUTEX	2.000	PZ																						
VM2495A0	SUPPORTO VENTOLA RAFFREDDAM ENTO SP	1.000	PZ																						
VN1175A	VENTOLA RAFFR. 120x120 230V 50/60Hz 80°C		KVN1175A	120x120 230V 50/60Hz COOLING FAN KIT	<table border="1"> <thead> <tr> <th>Code</th> <th>Description</th> <th>Qty</th> <th>UOM</th> </tr> </thead> <tbody> <tr> <td>VN1175A0</td> <td>VENTOLA RAFFR. 120x120 230V 50/60Hz 80°C</td> <td>1.000</td> <td>PZ</td> </tr> </tbody> </table>	Code	Description	Qty	UOM	VN1175A0	VENTOLA RAFFR. 120x120 230V 50/60Hz 80°C	1.000	PZ												
Code	Description	Qty	UOM																						
VN1175A0	VENTOLA RAFFR. 120x120 230V 50/60Hz 80°C	1.000	PZ																						
VM2481A	TAPPO FACCIATA COPERTURA ESTERNA SX SP		KVM2481A	BL SP LEFT EXT COVER FRONT PANEL CAP KIT	<table border="1"> <thead> <tr> <th>Code</th> <th>Description</th> <th>Qty</th> <th>UOM</th> </tr> </thead> <tbody> <tr> <td>VM2481A0</td> <td>TAPPO FACCIATA COPERTURA ESTERNA SX SP</td> <td>1.000</td> <td>PZ</td> </tr> </tbody> </table>	Code	Description	Qty	UOM	VM2481A0	TAPPO FACCIATA COPERTURA ESTERNA SX SP	1.000	PZ												
Code	Description	Qty	UOM																						
VM2481A0	TAPPO FACCIATA COPERTURA ESTERNA SX SP	1.000	PZ																						
VM2480A	TAPPO FACCIATA COPERTURA ESTERNA DX SP		KVM2480A	BL SP RIGHT EXT COVER FRONT PANEL CAP	<table border="1"> <thead> <tr> <th>Code</th> <th>Description</th> <th>Qty</th> <th>UOM</th> </tr> </thead> <tbody> <tr> <td>VM2480A0</td> <td>TAPPO FACCIATA COPERTURA ESTERNA DX SP</td> <td>1.000</td> <td>PZ</td> </tr> </tbody> </table>	Code	Description	Qty	UOM	VM2480A0	TAPPO FACCIATA COPERTURA ESTERNA DX SP	1.000	PZ												
Code	Description	Qty	UOM																						
VM2480A0	TAPPO FACCIATA COPERTURA ESTERNA DX SP	1.000	PZ																						
VM2488A	AERAZIONE SERRATURA SP		KVM2488A	BL SHOP.PRO MANUAL UNLOCK SYSTEM KIT	<table border="1"> <thead> <tr> <th>Code</th> <th>Description</th> <th>Qty</th> <th>UOM</th> </tr> </thead> <tbody> <tr> <td>V11220A1</td> <td>VITE AUTOFIL. 4.2X11 TCS+ MARUTEX</td> <td>2.000</td> <td>PZ</td> </tr> <tr> <td>V11950A0</td> <td>VITE AUTOFORANT E 4,2X13 TCB INOX</td> <td>2.000</td> <td>PZ</td> </tr> <tr> <td>VM2488A1</td> <td>AERAZIONE SERRATURA S</td> <td>1.000</td> <td>PZ</td> </tr> <tr> <td>VM2501A0</td> <td>INSERTO SBLOCCO SERRATURA S</td> <td>1.000</td> <td>PZ</td> </tr> </tbody> </table>	Code	Description	Qty	UOM	V11220A1	VITE AUTOFIL. 4.2X11 TCS+ MARUTEX	2.000	PZ	V11950A0	VITE AUTOFORANT E 4,2X13 TCB INOX	2.000	PZ	VM2488A1	AERAZIONE SERRATURA S	1.000	PZ	VM2501A0	INSERTO SBLOCCO SERRATURA S	1.000	PZ
Code	Description	Qty	UOM																						
V11220A1	VITE AUTOFIL. 4.2X11 TCS+ MARUTEX	2.000	PZ																						
V11950A0	VITE AUTOFORANT E 4,2X13 TCB INOX	2.000	PZ																						
VM2488A1	AERAZIONE SERRATURA S	1.000	PZ																						
VM2501A0	INSERTO SBLOCCO SERRATURA S	1.000	PZ																						



COMPONENT			SPARE PART																						
Code	Description	Image	Code	Description	Kit components																				
0H7850A	SHOP PRO DOOR COUNTERBRACKET		0H7850A0	SHOP PRO DOOR COUNTERBRACKET																					
VI0515A	RONDELLA PIANA D.5 INOX		VI0515A0	RONDELLA PIANA D.5 INOX																					
VI1995A	VITE M5x25 TCEI INOX		VI1995A0	VITE M5x25 TCEI INOX																					
VM1240A	TAPPO NYLON SUPPORTO CONTROSTAFFA		KVM1240A	4 PCS COUNTER BRACKET SUPPORT CAP KIT	<table border="1"> <thead> <tr> <th>Code</th> <th>Description</th> <th>Qty</th> <th>UOM</th> </tr> </thead> <tbody> <tr> <td>VM1240A0</td> <td>TAPPO NYLON SUPPORTO CONTROSTAF FA</td> <td>4.000</td> <td>PZ</td> </tr> </tbody> </table>	Code	Description	Qty	UOM	VM1240A0	TAPPO NYLON SUPPORTO CONTROSTAF FA	4.000	PZ												
Code	Description	Qty	UOM																						
VM1240A0	TAPPO NYLON SUPPORTO CONTROSTAF FA	4.000	PZ																						
VM2459A	STAFFA SUPERIORE PORTA BANDIERA S		KVM2459A	BL SP LATERAL DOOR UPPER BRACKET KIT	<table border="1"> <thead> <tr> <th>Code</th> <th>Description</th> <th>Qty</th> <th>UOM</th> </tr> </thead> <tbody> <tr> <td>VI0515A0</td> <td>RONDELLA PIANA D.5 INO</td> <td>4.000</td> <td>PZ</td> </tr> <tr> <td>VI1995A0</td> <td>VITE M5x25 TCEI INOX</td> <td>4.000</td> <td>PZ</td> </tr> <tr> <td>VM2459A1</td> <td>STAFFA SUPERIORE PORTA BANDIERA SP</td> <td>1.000</td> <td>PZ</td> </tr> <tr> <td>VM2460A0</td> <td>COVER STAFFA SUPERIORE PORTA BANDIERA SP</td> <td>1.000</td> <td>PZ</td> </tr> </tbody> </table>	Code	Description	Qty	UOM	VI0515A0	RONDELLA PIANA D.5 INO	4.000	PZ	VI1995A0	VITE M5x25 TCEI INOX	4.000	PZ	VM2459A1	STAFFA SUPERIORE PORTA BANDIERA SP	1.000	PZ	VM2460A0	COVER STAFFA SUPERIORE PORTA BANDIERA SP	1.000	PZ
Code	Description	Qty	UOM																						
VI0515A0	RONDELLA PIANA D.5 INO	4.000	PZ																						
VI1995A0	VITE M5x25 TCEI INOX	4.000	PZ																						
VM2459A1	STAFFA SUPERIORE PORTA BANDIERA SP	1.000	PZ																						
VM2460A0	COVER STAFFA SUPERIORE PORTA BANDIERA SP	1.000	PZ																						







COMPONENT			SPARE PART																						
Code	Description	Image	Code	Description	Kit components																				
VM2460A	COVER STAFFA SUPERIORE PORTA BANDIERA SP		KVM2460A	BL SP LAT DOOR UPP BRACKET COVER 2PC KIT	<table border="1"> <thead> <tr> <th>Code</th> <th>Description</th> <th>Qty</th> <th>UOM</th> </tr> </thead> <tbody> <tr> <td>VM2460A0</td> <td>COVER STAFFA SUPERIORE PORTA BANDIERA SP</td> <td>1.000</td> <td>PZ</td> </tr> </tbody> </table>	Code	Description	Qty	UOM	VM2460A0	COVER STAFFA SUPERIORE PORTA BANDIERA SP	1.000	PZ												
Code	Description	Qty	UOM																						
VM2460A0	COVER STAFFA SUPERIORE PORTA BANDIERA SP	1.000	PZ																						
0H7850A	SHOP PRO DOOR COUNTERBRACKET		0H7850A0	SHOP PRO DOOR COUNTERBRACKET																					
VI0515A	RONDELLA PIANA D.5 INOX		VI0515A0	RONDELLA PIANA D.5 INOX																					
VM1240A	TAPPO NYLON SUPPORTO CONTROSTAFFA		KVM1240A	4 PCS COUNTER BRACKET SUPPORT CAP KIT	<table border="1"> <thead> <tr> <th>Code</th> <th>Description</th> <th>Qty</th> <th>UOM</th> </tr> </thead> <tbody> <tr> <td>VM1240A0</td> <td>TAPPO NYLON SUPPORTO CONTROSTAF FA</td> <td>4.000</td> <td>PZ</td> </tr> </tbody> </table>	Code	Description	Qty	UOM	VM1240A0	TAPPO NYLON SUPPORTO CONTROSTAF FA	4.000	PZ												
Code	Description	Qty	UOM																						
VM1240A0	TAPPO NYLON SUPPORTO CONTROSTAF FA	4.000	PZ																						
VM2457A	STAFFA INFERIORE PORTA BANDIERA S		KVM2457A	BL SP LATERAL DOOR LOWER BRACKET KIT	<table border="1"> <thead> <tr> <th>Code</th> <th>Description</th> <th>Qty</th> <th>UOM</th> </tr> </thead> <tbody> <tr> <td>VI0515A0</td> <td>RONDELLA PIANA D.5 INO</td> <td>2.000</td> <td>PZ</td> </tr> <tr> <td>VI1995A0</td> <td>VITE M5x25 TCEI INOX</td> <td>2.000</td> <td>PZ</td> </tr> <tr> <td>VM2457A0</td> <td>STAFFA INFERIORE PORTA BANDIERA SP</td> <td>1.000</td> <td>PZ</td> </tr> <tr> <td>VM2458A0</td> <td>COVER STAFFA INFERIORE PORTA BANDIERA SP</td> <td>1.000</td> <td>PZ</td> </tr> </tbody> </table>	Code	Description	Qty	UOM	VI0515A0	RONDELLA PIANA D.5 INO	2.000	PZ	VI1995A0	VITE M5x25 TCEI INOX	2.000	PZ	VM2457A0	STAFFA INFERIORE PORTA BANDIERA SP	1.000	PZ	VM2458A0	COVER STAFFA INFERIORE PORTA BANDIERA SP	1.000	PZ
Code	Description	Qty	UOM																						
VI0515A0	RONDELLA PIANA D.5 INO	2.000	PZ																						
VI1995A0	VITE M5x25 TCEI INOX	2.000	PZ																						
VM2457A0	STAFFA INFERIORE PORTA BANDIERA SP	1.000	PZ																						
VM2458A0	COVER STAFFA INFERIORE PORTA BANDIERA SP	1.000	PZ																						



COMPONENT			SPARE PART										
Code	Description	Image	Code	Description	Kit components								
VM2458A	COVER STAFFA INFERIORE PORTA BANDIERA SP		KVM2458A	BL SP LAT DOOR LOW BRACKET COVER 2PC KIT	<table border="1"> <thead> <tr> <th>Code</th> <th>Description</th> <th>Qty</th> <th>UOM</th> </tr> </thead> <tbody> <tr> <td>VM2458A0</td> <td>COVER STAFFA INFERIORE PORTA BANDIERA SP</td> <td>2.000</td> <td>PZ</td> </tr> </tbody> </table>	Code	Description	Qty	UOM	VM2458A0	COVER STAFFA INFERIORE PORTA BANDIERA SP	2.000	PZ
Code	Description	Qty	UOM										
VM2458A0	COVER STAFFA INFERIORE PORTA BANDIERA SP	2.000	PZ										
0H7850A	SHOP PRO DOOR COUNTERBRACKET		0H7850A0	SHOP PRO DOOR COUNTERBRACKET									
VI0515A	RONDELLA PIANA D.5 INOX		VI0515A0	RONDELLA PIANA D.5 INOX									
VM1240A	TAPPO NYLON SUPPORTO CONTROSTAFFA		KVM1240A	4 PCS COUNTER BRACKET SUPPORT CAP KIT	<table border="1"> <thead> <tr> <th>Code</th> <th>Description</th> <th>Qty</th> <th>UOM</th> </tr> </thead> <tbody> <tr> <td>VM1240A0</td> <td>TAPPO NYLON SUPPORTO CONTROSTAF FA</td> <td>4.000</td> <td>PZ</td> </tr> </tbody> </table>	Code	Description	Qty	UOM	VM1240A0	TAPPO NYLON SUPPORTO CONTROSTAF FA	4.000	PZ
Code	Description	Qty	UOM										
VM1240A0	TAPPO NYLON SUPPORTO CONTROSTAF FA	4.000	PZ										
VM2458A	COVER STAFFA INFERIORE PORTA BANDIERA SP		KVM2458A	BL SP LAT DOOR LOW BRACKET COVER 2PC KIT	<table border="1"> <thead> <tr> <th>Code</th> <th>Description</th> <th>Qty</th> <th>UOM</th> </tr> </thead> <tbody> <tr> <td>VM2458A0</td> <td>COVER STAFFA INFERIORE PORTA BANDIERA SP</td> <td>2.000</td> <td>PZ</td> </tr> </tbody> </table>	Code	Description	Qty	UOM	VM2458A0	COVER STAFFA INFERIORE PORTA BANDIERA SP	2.000	PZ
Code	Description	Qty	UOM										
VM2458A0	COVER STAFFA INFERIORE PORTA BANDIERA SP	2.000	PZ										



COMPONENT			SPARE PART																						
Code	Description	Image	Code	Description	Kit components																				
VM2469A	STAFFA REGGI PORTA BANDIERA S		KVM2469A	BL SP LATERAL DOOR HOLDER BRACKET KIT	<table border="1"> <thead> <tr> <th>Code</th> <th>Description</th> <th>Qty</th> <th>UOM</th> </tr> </thead> <tbody> <tr> <td>VI0515A0</td> <td>RONDELLA PIANA D.5 INO</td> <td>2.000</td> <td>PZ</td> </tr> <tr> <td>VI1995A0</td> <td>VITE M5x25 TCEI INOX</td> <td>2.000</td> <td>PZ</td> </tr> <tr> <td>VM2458A0</td> <td>COVER STAFFA INFERIORE PORTA BANDIERA SP</td> <td>1.000</td> <td>PZ</td> </tr> <tr> <td>VM2469A0</td> <td>STAFFA REGGI PORTA BANDIERA SP</td> <td>1.000</td> <td>PZ</td> </tr> </tbody> </table>	Code	Description	Qty	UOM	VI0515A0	RONDELLA PIANA D.5 INO	2.000	PZ	VI1995A0	VITE M5x25 TCEI INOX	2.000	PZ	VM2458A0	COVER STAFFA INFERIORE PORTA BANDIERA SP	1.000	PZ	VM2469A0	STAFFA REGGI PORTA BANDIERA SP	1.000	PZ
Code	Description	Qty	UOM																						
VI0515A0	RONDELLA PIANA D.5 INO	2.000	PZ																						
VI1995A0	VITE M5x25 TCEI INOX	2.000	PZ																						
VM2458A0	COVER STAFFA INFERIORE PORTA BANDIERA SP	1.000	PZ																						
VM2469A0	STAFFA REGGI PORTA BANDIERA SP	1.000	PZ																						
0H7850A	SHOP PRO DOOR COUNTERBRACKET		0H7850A0	SHOP PRO DOOR COUNTERBRACKET																					
VM1195A	HOLES BLANKING PLATE XVC204/304/504/704		VM1195A0	HOLES BLANKING PLATE XVC204/304/504/704																					
VM1240A	TAPPO NYLON SUPPORTO CONTROSTAFFA		KVM1240A	4 PCS COUNTER BRACKET SUPPORT CAP KIT	<table border="1"> <thead> <tr> <th>Code</th> <th>Description</th> <th>Qty</th> <th>UOM</th> </tr> </thead> <tbody> <tr> <td>VM1240A0</td> <td>TAPPO NYLON SUPPORTO CONTROSTAF FA</td> <td>4.000</td> <td>PZ</td> </tr> </tbody> </table>	Code	Description	Qty	UOM	VM1240A0	TAPPO NYLON SUPPORTO CONTROSTAF FA	4.000	PZ												
Code	Description	Qty	UOM																						
VM1240A0	TAPPO NYLON SUPPORTO CONTROSTAF FA	4.000	PZ																						
VM1631A	TAPPO PREMI VETRO INTERNO PLUS		KVM1631A	CAP FOR INTERNAL GLASS 10 PCS KIT	<table border="1"> <thead> <tr> <th>Code</th> <th>Description</th> <th>Qty</th> <th>UOM</th> </tr> </thead> <tbody> <tr> <td>VM1631A0</td> <td>TAPPO PREMI VETRO INTERNO PLU</td> <td>10.000</td> <td>PZ</td> </tr> </tbody> </table>	Code	Description	Qty	UOM	VM1631A0	TAPPO PREMI VETRO INTERNO PLU	10.000	PZ												
Code	Description	Qty	UOM																						
VM1631A0	TAPPO PREMI VETRO INTERNO PLU	10.000	PZ																						

COMPONENT			SPARE PART																		
Code	Description	Image	Code	Description	Kit components																
VM2492A	GUARNIZIONE FONDO EST. FRONTALE L800 SP		KVM2492A	SP 600X400 EXT BOT PANEL GASKET 2PC KIT	<table border="1"> <thead> <tr> <th>Code</th> <th>Description</th> <th>Qty</th> <th>UOM</th> </tr> </thead> <tbody> <tr> <td>VM1794A0</td> <td>FASCETTA 430X4.8 PA66 NERA</td> <td>1.000</td> <td>PZ</td> </tr> <tr> <td>VM2492A0</td> <td>GUARNIZIONE FONDO EST. FRONTALE L800 SP</td> <td>2.000</td> <td>PZ</td> </tr> </tbody> </table>	Code	Description	Qty	UOM	VM1794A0	FASCETTA 430X4.8 PA66 NERA	1.000	PZ	VM2492A0	GUARNIZIONE FONDO EST. FRONTALE L800 SP	2.000	PZ				
					Code	Description	Qty	UOM													
VM1794A0	FASCETTA 430X4.8 PA66 NERA	1.000	PZ																		
VM2492A0	GUARNIZIONE FONDO EST. FRONTALE L800 SP	2.000	PZ																		
<table border="1"> <thead> <tr> <th>Code</th> <th>Description</th> <th>Qty</th> <th>UOM</th> </tr> </thead> <tbody> <tr> <td>VM1631A0</td> <td>TAPPO PREMI VETRO INTERNO PLU</td> <td>4.000</td> <td>PZ</td> </tr> <tr> <td>VM1794A0</td> <td>FASCETTA 430X4.8 PA66 NERA</td> <td>1.000</td> <td>PZ</td> </tr> <tr> <td>VM2493A1</td> <td>GUARNIZIONE FONDO EST. LATERALE SP800</td> <td>2.000</td> <td>PZ</td> </tr> </tbody> </table>	Code	Description	Qty	UOM	VM1631A0	TAPPO PREMI VETRO INTERNO PLU	4.000	PZ	VM1794A0	FASCETTA 430X4.8 PA66 NERA	1.000	PZ	VM2493A1	GUARNIZIONE FONDO EST. LATERALE SP800	2.000	PZ					
Code	Description	Qty	UOM																		
VM1631A0	TAPPO PREMI VETRO INTERNO PLU	4.000	PZ																		
VM1794A0	FASCETTA 430X4.8 PA66 NERA	1.000	PZ																		
VM2493A1	GUARNIZIONE FONDO EST. LATERALE SP800	2.000	PZ																		
VM2493A	GUARNIZIONE FONDO EST. LATERALE SP800		KVM2493A	SP 600X400 BOT LAT PANEL GASKET 2PC KIT	<table border="1"> <thead> <tr> <th>Code</th> <th>Description</th> <th>Qty</th> <th>UOM</th> </tr> </thead> <tbody> <tr> <td>VM1631A0</td> <td>TAPPO PREMI VETRO INTERNO PLU</td> <td>4.000</td> <td>PZ</td> </tr> <tr> <td>VM1794A0</td> <td>FASCETTA 430X4.8 PA66 NERA</td> <td>1.000</td> <td>PZ</td> </tr> <tr> <td>VM2493A1</td> <td>GUARNIZIONE FONDO EST. LATERALE SP800</td> <td>2.000</td> <td>PZ</td> </tr> </tbody> </table>	Code	Description	Qty	UOM	VM1631A0	TAPPO PREMI VETRO INTERNO PLU	4.000	PZ	VM1794A0	FASCETTA 430X4.8 PA66 NERA	1.000	PZ	VM2493A1	GUARNIZIONE FONDO EST. LATERALE SP800	2.000	PZ
					Code	Description	Qty	UOM													
VM1631A0	TAPPO PREMI VETRO INTERNO PLU	4.000	PZ																		
VM1794A0	FASCETTA 430X4.8 PA66 NERA	1.000	PZ																		
VM2493A1	GUARNIZIONE FONDO EST. LATERALE SP800	2.000	PZ																		
<table border="1"> <thead> <tr> <th>Code</th> <th>Description</th> <th>Qty</th> <th>UOM</th> </tr> </thead> <tbody> <tr> <td>VM2492A0</td> <td>GUARNIZIONE FONDO EST. FRONTALE L800 SP</td> <td>2.000</td> <td>PZ</td> </tr> </tbody> </table>	Code	Description	Qty	UOM	VM2492A0	GUARNIZIONE FONDO EST. FRONTALE L800 SP	2.000	PZ													
Code	Description	Qty	UOM																		
VM2492A0	GUARNIZIONE FONDO EST. FRONTALE L800 SP	2.000	PZ																		
VM1222A	CABLE LOCKS SP ACCESSORIES EL CONNECTION		VM1222A0	CABLE LOCKS SP ACCESSORIES EL CONNECTION																	
VM2249A	ANGOLO FACCIATA MUFFOLA PPS		KVM2249A	CHAMBER FRONT PROFILE CORNER KIT	<table border="1"> <thead> <tr> <th>Code</th> <th>Description</th> <th>Qty</th> <th>UOM</th> </tr> </thead> <tbody> <tr> <td>VM2249A0</td> <td>ANGOLO FACCIATA MUFFOLA PPS</td> <td>1.000</td> <td>PZ</td> </tr> </tbody> </table>	Code	Description	Qty	UOM	VM2249A0	ANGOLO FACCIATA MUFFOLA PPS	1.000	PZ								
					Code	Description	Qty	UOM													
VM2249A0	ANGOLO FACCIATA MUFFOLA PPS	1.000	PZ																		
<table border="1"> <thead> <tr> <th>Code</th> <th>Description</th> <th>Qty</th> <th>UOM</th> </tr> </thead> <tbody> <tr> <td>VM2509A1</td> <td>AERAZIONE SERRATURA CIECA BL SP</td> <td>1.000</td> <td>PZ</td> </tr> </tbody> </table>	Code	Description	Qty	UOM	VM2509A1	AERAZIONE SERRATURA CIECA BL SP	1.000	PZ													
Code	Description	Qty	UOM																		
VM2509A1	AERAZIONE SERRATURA CIECA BL SP	1.000	PZ																		
VM2509A	AERAZIONE SERRATURA CIECA BL SP		KVM2509A	BL SHOP.PRO BLIND LOCK VENTILATION KIT	<table border="1"> <thead> <tr> <th>Code</th> <th>Description</th> <th>Qty</th> <th>UOM</th> </tr> </thead> <tbody> <tr> <td>VM2509A1</td> <td>AERAZIONE SERRATURA CIECA BL SP</td> <td>1.000</td> <td>PZ</td> </tr> </tbody> </table>	Code	Description	Qty	UOM	VM2509A1	AERAZIONE SERRATURA CIECA BL SP	1.000	PZ								
Code	Description	Qty	UOM																		
VM2509A1	AERAZIONE SERRATURA CIECA BL SP	1.000	PZ																		



COMPONENT			SPARE PART										
Code	Description	Image	Code	Description	Kit components								
VM2511A	PIASTRINA PIANA COPRI FORI FACCIATA SP		KVM2511A	SP FRONT PANEL HOLE PLATE COVER 2PCS KIT	<table border="1"> <thead> <tr> <th>Code</th> <th>Description</th> <th>Qty</th> <th>UOM</th> </tr> </thead> <tbody> <tr> <td>VM2511A0</td> <td>PIASTRINA PIANA COPRI FORI FACCIATA SP</td> <td>2.000</td> <td>PZ</td> </tr> </tbody> </table>	Code	Description	Qty	UOM	VM2511A0	PIASTRINA PIANA COPRI FORI FACCIATA SP	2.000	PZ
Code	Description	Qty	UOM										
VM2511A0	PIASTRINA PIANA COPRI FORI FACCIATA SP	2.000	PZ										

ASM3429B/0.D00 - Door - FRONT

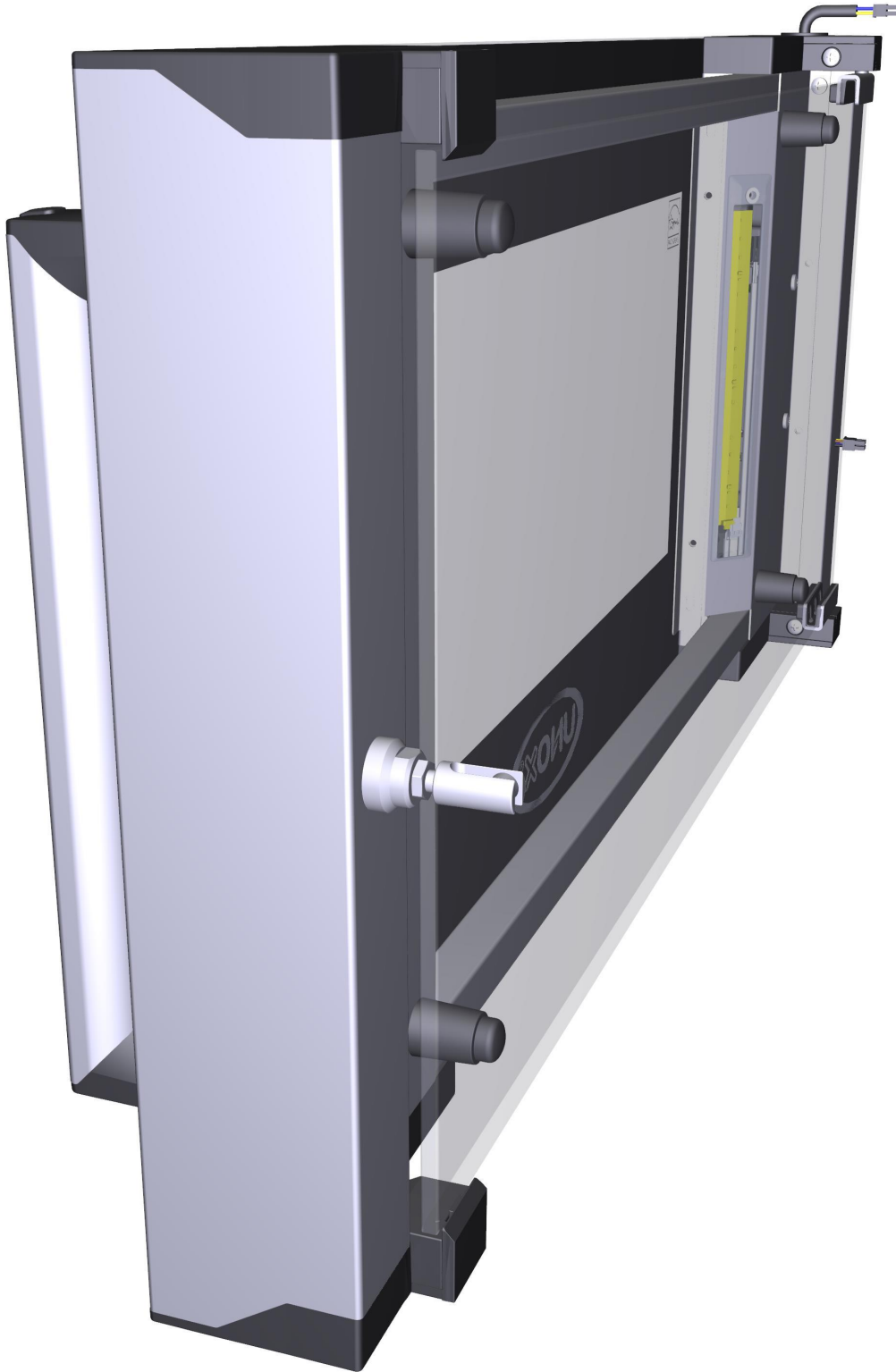





ASM3429B/0.D00 - Door - REAR







COMPONENT			SPARE PART																						
Code	Description	Image	Code	Description	Kit components																				
0B1293A	SP STE-ELE RIGHT DOOR LEFT EXT COLUMN		0B1293A0	SP STE-ELE RIGHT DOOR LEFT EXT COLUMN																					
0B1294A	SP STE-ELE RIGHT DOOR LEFT INT COLUMN		0B1294A0	SP STE-ELE RIGHT DOOR LEFT INT COLUMN																					
0B1295B	SP STE-ELE RIGHT DOOR RIGHT EXT COLUMN		0B1295B0	SP STE-ELE RIGHT DOOR RIGHT EXT COLUMN																					
0B1296B	SP STE-ELE RIGHT DOOR RIGHT INT COLUMN		0B1296B0	SP STE-ELE RIGHT DOOR RIGHT INT COLUMN																					
LP1050A	BARRA ILLUMINAZIONE LED L180 SP COMPLETA		KLP1050A	L180 COMPLETE LED LIGHT BAR KIT	<table border="1"> <thead> <tr> <th>Code</th> <th>Description</th> <th>Qty</th> <th>UOM</th> </tr> </thead> <tbody> <tr> <td>LP1050A0</td> <td>BARRA ILLUMINAZIONE E LED L180 SP COMPLETA</td> <td>1.000</td> <td>PZ</td> </tr> <tr> <td>VI1014A0</td> <td>RONDELLA PIANA 4.5X9X0.8 INO</td> <td>1.000</td> <td>PZ</td> </tr> <tr> <td>VI1220A1</td> <td>VITE AUTOFIL. 4.2X11 TCS+ MARUTEX</td> <td>1.000</td> <td>PZ</td> </tr> <tr> <td>VM1447A0</td> <td>BUSTA AIRBALL ESD ROSA 230X450 MM</td> <td>0.500</td> <td>PZ</td> </tr> </tbody> </table>	Code	Description	Qty	UOM	LP1050A0	BARRA ILLUMINAZIONE E LED L180 SP COMPLETA	1.000	PZ	VI1014A0	RONDELLA PIANA 4.5X9X0.8 INO	1.000	PZ	VI1220A1	VITE AUTOFIL. 4.2X11 TCS+ MARUTEX	1.000	PZ	VM1447A0	BUSTA AIRBALL ESD ROSA 230X450 MM	0.500	PZ
Code	Description	Qty	UOM																						
LP1050A0	BARRA ILLUMINAZIONE E LED L180 SP COMPLETA	1.000	PZ																						
VI1014A0	RONDELLA PIANA 4.5X9X0.8 INO	1.000	PZ																						
VI1220A1	VITE AUTOFIL. 4.2X11 TCS+ MARUTEX	1.000	PZ																						
VM1447A0	BUSTA AIRBALL ESD ROSA 230X450 MM	0.500	PZ																						





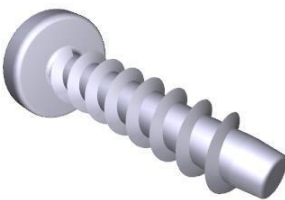
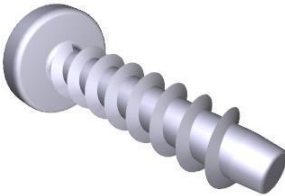

COMPONENT			SPARE PART																		
Code	Description	Image	Code	Description	Kit components																
TB3303A	TUBO MANIGLIA BANDIERA STE-ELE SP		KTB3303A	BL SP STE-ELE LATER DOOR HANDLE TUBE KIT	<table border="1"> <thead> <tr> <th>Code</th> <th>Description</th> <th>Qty</th> <th>UOM</th> </tr> </thead> <tbody> <tr> <td>TB3303A0</td> <td>TUBO MANIGLIA BANDIERA STE-ELE SP</td> <td>1.000</td> <td>PZ</td> </tr> <tr> <td>VI1147A0</td> <td>VITE 5X25 TRUCIOLARE INOX</td> <td>4.000</td> <td>PZ</td> </tr> <tr> <td>VM2456A0</td> <td>TERMINALE MANIGLIA BL SP</td> <td>2.000</td> <td>PZ</td> </tr> </tbody> </table>	Code	Description	Qty	UOM	TB3303A0	TUBO MANIGLIA BANDIERA STE-ELE SP	1.000	PZ	VI1147A0	VITE 5X25 TRUCIOLARE INOX	4.000	PZ	VM2456A0	TERMINALE MANIGLIA BL SP	2.000	PZ
					Code	Description	Qty	UOM													
					TB3303A0	TUBO MANIGLIA BANDIERA STE-ELE SP	1.000	PZ													
VI1147A0	VITE 5X25 TRUCIOLARE INOX	4.000	PZ																		
VM2456A0	TERMINALE MANIGLIA BL SP	2.000	PZ																		
<table border="1"> <thead> <tr> <th>Code</th> <th>Description</th> <th>Qty</th> <th>UOM</th> </tr> </thead> <tbody> <tr> <td>VI1147A0</td> <td>VITE 5X25 TRUCIOLARE INOX</td> <td>4.000</td> <td>PZ</td> </tr> <tr> <td>VM2456A0</td> <td>TERMINALE MANIGLIA BL SP</td> <td>2.000</td> <td>PZ</td> </tr> </tbody> </table>	Code	Description	Qty	UOM	VI1147A0	VITE 5X25 TRUCIOLARE INOX	4.000	PZ	VM2456A0	TERMINALE MANIGLIA BL SP	2.000	PZ									
Code	Description	Qty	UOM																		
VI1147A0	VITE 5X25 TRUCIOLARE INOX	4.000	PZ																		
VM2456A0	TERMINALE MANIGLIA BL SP	2.000	PZ																		
<table border="1"> <thead> <tr> <th>Code</th> <th>Description</th> <th>Qty</th> <th>UOM</th> </tr> </thead> <tbody> <tr> <td>VI1147A0</td> <td>VITE 5X25 TRUCIOLARE INOX</td> <td>4.000</td> <td>PZ</td> </tr> <tr> <td>VM2456A0</td> <td>TERMINALE MANIGLIA BL SP</td> <td>2.000</td> <td>PZ</td> </tr> </tbody> </table>	Code	Description	Qty	UOM	VI1147A0	VITE 5X25 TRUCIOLARE INOX	4.000	PZ	VM2456A0	TERMINALE MANIGLIA BL SP	2.000	PZ									
Code	Description	Qty	UOM																		
VI1147A0	VITE 5X25 TRUCIOLARE INOX	4.000	PZ																		
VM2456A0	TERMINALE MANIGLIA BL SP	2.000	PZ																		
VM2456A	TERMINALE MANIGLIA BL SP		KVM2456A	2 PCS BAKERLUX SHOP.PRO HANDLE END KIT	<table border="1"> <thead> <tr> <th>Code</th> <th>Description</th> <th>Qty</th> <th>UOM</th> </tr> </thead> <tbody> <tr> <td>VI1147A0</td> <td>VITE 5X25 TRUCIOLARE INOX</td> <td>4.000</td> <td>PZ</td> </tr> <tr> <td>VM2456A0</td> <td>TERMINALE MANIGLIA BL SP</td> <td>2.000</td> <td>PZ</td> </tr> </tbody> </table>	Code	Description	Qty	UOM	VI1147A0	VITE 5X25 TRUCIOLARE INOX	4.000	PZ	VM2456A0	TERMINALE MANIGLIA BL SP	2.000	PZ				
Code	Description	Qty	UOM																		
VI1147A0	VITE 5X25 TRUCIOLARE INOX	4.000	PZ																		
VM2456A0	TERMINALE MANIGLIA BL SP	2.000	PZ																		
VM2527A	PENNINO CONTROLLO SP		KVM2527A	EVEREO-S.Pro TOUCH STYLUS 5 PCS KIT	<table border="1"> <thead> <tr> <th>Code</th> <th>Description</th> <th>Qty</th> <th>UOM</th> </tr> </thead> <tbody> <tr> <td>VM2527A1</td> <td>PENNINO CONTROLLO SP</td> <td>5.000</td> <td>PZ</td> </tr> </tbody> </table>	Code	Description	Qty	UOM	VM2527A1	PENNINO CONTROLLO SP	5.000	PZ								
Code	Description	Qty	UOM																		
VM2527A1	PENNINO CONTROLLO SP	5.000	PZ																		
VI1174A	VI1174A0		VI1174A0	VI1174A0																	
VM2468A	TAPPO SUPERIORE SX PORTA BANDIERA SP		KVM2468A	BL SP LEFT UPPER LATERAL DOOR CAP KIT	<table border="1"> <thead> <tr> <th>Code</th> <th>Description</th> <th>Qty</th> <th>UOM</th> </tr> </thead> <tbody> <tr> <td>VM2468A0</td> <td>TAPPO SUPERIORE SX PORTA BANDIERA SP</td> <td>1.000</td> <td>PZ</td> </tr> </tbody> </table>	Code	Description	Qty	UOM	VM2468A0	TAPPO SUPERIORE SX PORTA BANDIERA SP	1.000	PZ								
Code	Description	Qty	UOM																		
VM2468A0	TAPPO SUPERIORE SX PORTA BANDIERA SP	1.000	PZ																		

COMPONENT			SPARE PART																		
Code	Description	Image	Code	Description	Kit components																
VM2474A	BLOCCA PERNO SUP CERNIERA VETRO INT SP		KVM2474A	BL SP INT GLASS HINGE UPPER LOCK PIN KIT	<table border="1"> <thead> <tr> <th>Code</th> <th>Description</th> <th>Qty</th> <th>UOM</th> </tr> </thead> <tbody> <tr> <td>VM2474A0</td> <td>BLOCCA PERNO SUP CERNIERA VETRO INT SP</td> <td>1.000</td> <td>PZ</td> </tr> </tbody> </table>	Code	Description	Qty	UOM	VM2474A0	BLOCCA PERNO SUP CERNIERA VETRO INT SP	1.000	PZ								
Code	Description	Qty	UOM																		
VM2474A0	BLOCCA PERNO SUP CERNIERA VETRO INT SP	1.000	PZ																		
ML1005A	MOLLA A COMPRESSIONE DE5 DF0.6 H18		KVM2470A	BL SHOP.PRO INTERNAL GLASS LOCK 2PCS KIT	<table border="1"> <thead> <tr> <th>Code</th> <th>Description</th> <th>Qty</th> <th>UOM</th> </tr> </thead> <tbody> <tr> <td>ML1005A0</td> <td>MOLLA A COMPRESSIO NE DE5 DF0.6 H18</td> <td>2.000</td> <td>PZ</td> </tr> <tr> <td>VM2470A0</td> <td>CORSOIO BLOCCA VETRO INTERNO SHOP.PRO</td> <td>2.000</td> <td>PZ</td> </tr> <tr> <td>VM2504A0</td> <td>PIOLINO GUIDA MOLLA CORSOIO SHOP.PRO</td> <td>2.000</td> <td>PZ</td> </tr> </tbody> </table>	Code	Description	Qty	UOM	ML1005A0	MOLLA A COMPRESSIO NE DE5 DF0.6 H18	2.000	PZ	VM2470A0	CORSOIO BLOCCA VETRO INTERNO SHOP.PRO	2.000	PZ	VM2504A0	PIOLINO GUIDA MOLLA CORSOIO SHOP.PRO	2.000	PZ
Code	Description	Qty	UOM																		
ML1005A0	MOLLA A COMPRESSIO NE DE5 DF0.6 H18	2.000	PZ																		
VM2470A0	CORSOIO BLOCCA VETRO INTERNO SHOP.PRO	2.000	PZ																		
VM2504A0	PIOLINO GUIDA MOLLA CORSOIO SHOP.PRO	2.000	PZ																		
VM2470A	CORSOIO BLOCCA VETRO INTERNO SHOP.PRO		KVM2470A	BL SHOP.PRO INTERNAL GLASS LOCK 2PCS KIT	<table border="1"> <thead> <tr> <th>Code</th> <th>Description</th> <th>Qty</th> <th>UOM</th> </tr> </thead> <tbody> <tr> <td>ML1005A0</td> <td>MOLLA A COMPRESSIO NE DE5 DF0.6 H18</td> <td>2.000</td> <td>PZ</td> </tr> <tr> <td>VM2470A0</td> <td>CORSOIO BLOCCA VETRO INTERNO SHOP.PRO</td> <td>2.000</td> <td>PZ</td> </tr> <tr> <td>VM2504A0</td> <td>PIOLINO GUIDA MOLLA CORSOIO SHOP.PRO</td> <td>2.000</td> <td>PZ</td> </tr> </tbody> </table>	Code	Description	Qty	UOM	ML1005A0	MOLLA A COMPRESSIO NE DE5 DF0.6 H18	2.000	PZ	VM2470A0	CORSOIO BLOCCA VETRO INTERNO SHOP.PRO	2.000	PZ	VM2504A0	PIOLINO GUIDA MOLLA CORSOIO SHOP.PRO	2.000	PZ
Code	Description	Qty	UOM																		
ML1005A0	MOLLA A COMPRESSIO NE DE5 DF0.6 H18	2.000	PZ																		
VM2470A0	CORSOIO BLOCCA VETRO INTERNO SHOP.PRO	2.000	PZ																		
VM2504A0	PIOLINO GUIDA MOLLA CORSOIO SHOP.PRO	2.000	PZ																		
VM2472A	SEDE SUP CORSOIO BLOCCA VETRO INTERNO SP		KVM2471A	BL SP INTERNAL GLASS LOCK HOLDER KIT	<table border="1"> <thead> <tr> <th>Code</th> <th>Description</th> <th>Qty</th> <th>UOM</th> </tr> </thead> <tbody> <tr> <td>VI1998A0</td> <td>VITE TRUCIOLARE 5X30 TCB ZINCATA</td> <td>2.000</td> <td>PZ</td> </tr> <tr> <td>VM2471A0</td> <td>SEDE INF CORSOIO BLOCCA VETRO INTERNO SP</td> <td>1.000</td> <td>PZ</td> </tr> <tr> <td>VM2472A0</td> <td>SEDE SUP CORSOIO BLOCCA VETRO INTERNO SP</td> <td>1.000</td> <td>PZ</td> </tr> </tbody> </table>	Code	Description	Qty	UOM	VI1998A0	VITE TRUCIOLARE 5X30 TCB ZINCATA	2.000	PZ	VM2471A0	SEDE INF CORSOIO BLOCCA VETRO INTERNO SP	1.000	PZ	VM2472A0	SEDE SUP CORSOIO BLOCCA VETRO INTERNO SP	1.000	PZ
Code	Description	Qty	UOM																		
VI1998A0	VITE TRUCIOLARE 5X30 TCB ZINCATA	2.000	PZ																		
VM2471A0	SEDE INF CORSOIO BLOCCA VETRO INTERNO SP	1.000	PZ																		
VM2472A0	SEDE SUP CORSOIO BLOCCA VETRO INTERNO SP	1.000	PZ																		

COMPONENT			SPARE PART																		
Code	Description	Image	Code	Description	Kit components																
VM2504A	PIOLINO GUIDA MOLLA CORSOIO SHOP.PRO		KVM2470A	BL SHOP.PRO INTERNAL GLASS LOCK 2PCS KIT	<table border="1"> <thead> <tr> <th>Code</th> <th>Description</th> <th>Qty</th> <th>UOM</th> </tr> </thead> <tbody> <tr> <td>ML1005A0</td> <td>MOLLA A COMPRESSIO NE DE5 DF0.6 H18</td> <td>2.000</td> <td>PZ</td> </tr> <tr> <td>VM2470A0</td> <td>CORSOIO BLOCCA VETRO INTERNO SHOP.PRO</td> <td>2.000</td> <td>PZ</td> </tr> <tr> <td>VM2504A0</td> <td>PIOLINO GUIDA MOLLA CORSOIO SHOP.PRO</td> <td>2.000</td> <td>PZ</td> </tr> </tbody> </table>	Code	Description	Qty	UOM	ML1005A0	MOLLA A COMPRESSIO NE DE5 DF0.6 H18	2.000	PZ	VM2470A0	CORSOIO BLOCCA VETRO INTERNO SHOP.PRO	2.000	PZ	VM2504A0	PIOLINO GUIDA MOLLA CORSOIO SHOP.PRO	2.000	PZ
Code	Description	Qty	UOM																		
ML1005A0	MOLLA A COMPRESSIO NE DE5 DF0.6 H18	2.000	PZ																		
VM2470A0	CORSOIO BLOCCA VETRO INTERNO SHOP.PRO	2.000	PZ																		
VM2504A0	PIOLINO GUIDA MOLLA CORSOIO SHOP.PRO	2.000	PZ																		
VM2467A	TAPPO SUPERIORE DX PORTA BANDIERA SP		KVM2467A	BL SP RIGHT UPPER LATERAL DOOR CAP KIT	<table border="1"> <thead> <tr> <th>Code</th> <th>Description</th> <th>Qty</th> <th>UOM</th> </tr> </thead> <tbody> <tr> <td>VM2467A0</td> <td>TAPPO SUPERIORE DX PORTA BANDIERA SP</td> <td>1.000</td> <td>PZ</td> </tr> </tbody> </table>	Code	Description	Qty	UOM	VM2467A0	TAPPO SUPERIORE DX PORTA BANDIERA SP	1.000	PZ								
Code	Description	Qty	UOM																		
VM2467A0	TAPPO SUPERIORE DX PORTA BANDIERA SP	1.000	PZ																		
TB1563A	DOOR LATERAL BEAM SP800		TB1563A0	DOOR LATERAL BEAM SP800																	
VI1174A	VI1174A0		VI1174A0	VI1174A0																	
VI1174A	VI1174A0		VI1174A0	VI1174A0																	

COMPONENT			SPARE PART																		
Code	Description	Image	Code	Description	Kit components																
VM2466A	TAPPO INFERIORE SX PORTA BANDIERA SP		KVM2466A	BL SP LEFT LOWER LATERAL DOOR CAP KIT	<table border="1"> <thead> <tr> <th>Code</th> <th>Description</th> <th>Qty</th> <th>UOM</th> </tr> </thead> <tbody> <tr> <td>VM2466A0</td> <td>TAPPO INFERIORE SX PORTA BANDIERA SP</td> <td>1.000</td> <td>PZ</td> </tr> </tbody> </table>	Code	Description	Qty	UOM	VM2466A0	TAPPO INFERIORE SX PORTA BANDIERA SP	1.000	PZ								
Code	Description	Qty	UOM																		
VM2466A0	TAPPO INFERIORE SX PORTA BANDIERA SP	1.000	PZ																		
VM2473A	BLOCCA PERNO INF CERNIERA VETRO INT SP		KVM2473A	BL SP INT GLASS HINGE LOWER LOCK PIN KIT	<table border="1"> <thead> <tr> <th>Code</th> <th>Description</th> <th>Qty</th> <th>UOM</th> </tr> </thead> <tbody> <tr> <td>VM2473A0</td> <td>BLOCCA PERNO INF CERNIERA VETRO INT SP</td> <td>1.000</td> <td>PZ</td> </tr> </tbody> </table>	Code	Description	Qty	UOM	VM2473A0	BLOCCA PERNO INF CERNIERA VETRO INT SP	1.000	PZ								
Code	Description	Qty	UOM																		
VM2473A0	BLOCCA PERNO INF CERNIERA VETRO INT SP	1.000	PZ																		
ML1005A	MOLLA A COMPRESSIONE DE5 DF0.6 H18		KVM2470A	BL SHOP.PRO INTERNAL GLASS LOCK 2PCS KIT	<table border="1"> <thead> <tr> <th>Code</th> <th>Description</th> <th>Qty</th> <th>UOM</th> </tr> </thead> <tbody> <tr> <td>ML1005A0</td> <td>MOLLA A COMPRESSIO NE DE5 DF0.6 H18</td> <td>2.000</td> <td>PZ</td> </tr> <tr> <td>VM2470A0</td> <td>CORSOIO BLOCCA VETRO INTERNO SHOP.PRO</td> <td>2.000</td> <td>PZ</td> </tr> <tr> <td>VM2504A0</td> <td>PIOLINO GUIDA MOLLA CORSOIO SHOP.PRO</td> <td>2.000</td> <td>PZ</td> </tr> </tbody> </table>	Code	Description	Qty	UOM	ML1005A0	MOLLA A COMPRESSIO NE DE5 DF0.6 H18	2.000	PZ	VM2470A0	CORSOIO BLOCCA VETRO INTERNO SHOP.PRO	2.000	PZ	VM2504A0	PIOLINO GUIDA MOLLA CORSOIO SHOP.PRO	2.000	PZ
Code	Description	Qty	UOM																		
ML1005A0	MOLLA A COMPRESSIO NE DE5 DF0.6 H18	2.000	PZ																		
VM2470A0	CORSOIO BLOCCA VETRO INTERNO SHOP.PRO	2.000	PZ																		
VM2504A0	PIOLINO GUIDA MOLLA CORSOIO SHOP.PRO	2.000	PZ																		
VM2470A	CORSOIO BLOCCA VETRO INTERNO SHOP.PRO		KVM2470A	BL SHOP.PRO INTERNAL GLASS LOCK 2PCS KIT	<table border="1"> <thead> <tr> <th>Code</th> <th>Description</th> <th>Qty</th> <th>UOM</th> </tr> </thead> <tbody> <tr> <td>ML1005A0</td> <td>MOLLA A COMPRESSIO NE DE5 DF0.6 H18</td> <td>2.000</td> <td>PZ</td> </tr> <tr> <td>VM2470A0</td> <td>CORSOIO BLOCCA VETRO INTERNO SHOP.PRO</td> <td>2.000</td> <td>PZ</td> </tr> <tr> <td>VM2504A0</td> <td>PIOLINO GUIDA MOLLA CORSOIO SHOP.PRO</td> <td>2.000</td> <td>PZ</td> </tr> </tbody> </table>	Code	Description	Qty	UOM	ML1005A0	MOLLA A COMPRESSIO NE DE5 DF0.6 H18	2.000	PZ	VM2470A0	CORSOIO BLOCCA VETRO INTERNO SHOP.PRO	2.000	PZ	VM2504A0	PIOLINO GUIDA MOLLA CORSOIO SHOP.PRO	2.000	PZ
Code	Description	Qty	UOM																		
ML1005A0	MOLLA A COMPRESSIO NE DE5 DF0.6 H18	2.000	PZ																		
VM2470A0	CORSOIO BLOCCA VETRO INTERNO SHOP.PRO	2.000	PZ																		
VM2504A0	PIOLINO GUIDA MOLLA CORSOIO SHOP.PRO	2.000	PZ																		

COMPONENT			SPARE PART																		
Code	Description	Image	Code	Description	Kit components																
VM2471A	SEDE INF CORSOIO BLOCCA VETRO INTERNO SP		KVM2471A	BL SP INTERNAL GLASS LOCK HOLDER KIT	<table border="1"> <thead> <tr> <th>Code</th> <th>Description</th> <th>Qty</th> <th>UOM</th> </tr> </thead> <tbody> <tr> <td>VI1998A0</td> <td>VITE TRUCIOLARE 5X30 TCB ZINCATA</td> <td>2.000</td> <td>PZ</td> </tr> <tr> <td>VM2471A0</td> <td>SEDE INF CORSOIO BLOCCA VETRO INTERNO SP</td> <td>1.000</td> <td>PZ</td> </tr> <tr> <td>VM2472A0</td> <td>SEDE SUP CORSOIO BLOCCA VETRO INTERNO SP</td> <td>1.000</td> <td>PZ</td> </tr> </tbody> </table>	Code	Description	Qty	UOM	VI1998A0	VITE TRUCIOLARE 5X30 TCB ZINCATA	2.000	PZ	VM2471A0	SEDE INF CORSOIO BLOCCA VETRO INTERNO SP	1.000	PZ	VM2472A0	SEDE SUP CORSOIO BLOCCA VETRO INTERNO SP	1.000	PZ
Code	Description	Qty	UOM																		
VI1998A0	VITE TRUCIOLARE 5X30 TCB ZINCATA	2.000	PZ																		
VM2471A0	SEDE INF CORSOIO BLOCCA VETRO INTERNO SP	1.000	PZ																		
VM2472A0	SEDE SUP CORSOIO BLOCCA VETRO INTERNO SP	1.000	PZ																		
VM2504A	PIOLINO GUIDA MOLLA CORSOIO SHOP.PRO		KVM2470A	BL SHOP.PRO INTERNAL GLASS LOCK 2PCS KIT	<table border="1"> <thead> <tr> <th>Code</th> <th>Description</th> <th>Qty</th> <th>UOM</th> </tr> </thead> <tbody> <tr> <td>ML1005A0</td> <td>MOLLA A COMPRESSIO NE DE5 DF0.6 H18</td> <td>2.000</td> <td>PZ</td> </tr> <tr> <td>VM2470A0</td> <td>CORSOIO BLOCCA VETRO INTERNO SHOP.PRO</td> <td>2.000</td> <td>PZ</td> </tr> <tr> <td>VM2504A0</td> <td>PIOLINO GUIDA MOLLA CORSOIO SHOP.PRO</td> <td>2.000</td> <td>PZ</td> </tr> </tbody> </table>	Code	Description	Qty	UOM	ML1005A0	MOLLA A COMPRESSIO NE DE5 DF0.6 H18	2.000	PZ	VM2470A0	CORSOIO BLOCCA VETRO INTERNO SHOP.PRO	2.000	PZ	VM2504A0	PIOLINO GUIDA MOLLA CORSOIO SHOP.PRO	2.000	PZ
Code	Description	Qty	UOM																		
ML1005A0	MOLLA A COMPRESSIO NE DE5 DF0.6 H18	2.000	PZ																		
VM2470A0	CORSOIO BLOCCA VETRO INTERNO SHOP.PRO	2.000	PZ																		
VM2504A0	PIOLINO GUIDA MOLLA CORSOIO SHOP.PRO	2.000	PZ																		
VM2465A	TAPPO INFERIORE DX PORTA BANDIERA SP		KVM2465A	BL SP RIGHT LOWER LATERAL DOOR CAP KIT	<table border="1"> <thead> <tr> <th>Code</th> <th>Description</th> <th>Qty</th> <th>UOM</th> </tr> </thead> <tbody> <tr> <td>VM2465A0</td> <td>TAPPO INFERIORE DX PORTA BANDIERA SP</td> <td>1.000</td> <td>PZ</td> </tr> </tbody> </table>	Code	Description	Qty	UOM	VM2465A0	TAPPO INFERIORE DX PORTA BANDIERA SP	1.000	PZ								
Code	Description	Qty	UOM																		
VM2465A0	TAPPO INFERIORE DX PORTA BANDIERA SP	1.000	PZ																		
TB1563A	DOOR LATERAL BEAM SP800		TB1563A0	DOOR LATERAL BEAM SP800																	

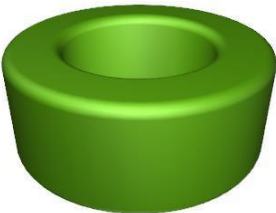

COMPONENT			SPARE PART														
Code	Description	Image	Code	Description	Kit components												
VI1174A	VI1174A0		VI1174A0	VI1174A0													
VM1630A	TAPPO PREMI VETRO INTERNO		KVM1630A	CAP FOR INTERNAL GLASS 10 PCS KIT	<table border="1"> <thead> <tr> <th>Code</th> <th>Description</th> <th>Qty</th> <th>UOM</th> </tr> </thead> <tbody> <tr> <td>VM1630A1</td> <td>TAPPO PREMI VETRO INTERNO</td> <td>10.000</td> <td>PZ</td> </tr> </tbody> </table>	Code	Description	Qty	UOM	VM1630A1	TAPPO PREMI VETRO INTERNO	10.000	PZ				
Code	Description	Qty	UOM														
VM1630A1	TAPPO PREMI VETRO INTERNO	10.000	PZ														
VM2479A	SPINGIVETRO VETRO H6 BL SP		KVM2479A	BL SHOP.PRO H6 GLASS SUPPORT 6 PCS KIT	<table border="1"> <thead> <tr> <th>Code</th> <th>Description</th> <th>Qty</th> <th>UOM</th> </tr> </thead> <tbody> <tr> <td>VM1630A1</td> <td>TAPPO PREMI VETRO INTERNO</td> <td>6.000</td> <td>PZ</td> </tr> <tr> <td>VM2479A0</td> <td>SPINGIVETRO VETRO H6 BL SP</td> <td>6.000</td> <td>PZ</td> </tr> </tbody> </table>	Code	Description	Qty	UOM	VM1630A1	TAPPO PREMI VETRO INTERNO	6.000	PZ	VM2479A0	SPINGIVETRO VETRO H6 BL SP	6.000	PZ
Code	Description	Qty	UOM														
VM1630A1	TAPPO PREMI VETRO INTERNO	6.000	PZ														
VM2479A0	SPINGIVETRO VETRO H6 BL SP	6.000	PZ														
CE1095A	CAVO BUS MICROFIT 4POLI 2M		KCE1095A	4POLES 2M BUS CABLE KIT POWER-CONTROL	<table border="1"> <thead> <tr> <th>Code</th> <th>Description</th> <th>Qty</th> <th>UOM</th> </tr> </thead> <tbody> <tr> <td>CE1095A0</td> <td>CAVO BUS MICROFIT 4POLI 2M</td> <td>1.000</td> <td>PZ</td> </tr> </tbody> </table>	Code	Description	Qty	UOM	CE1095A0	CAVO BUS MICROFIT 4POLI 2M	1.000	PZ				
Code	Description	Qty	UOM														
CE1095A0	CAVO BUS MICROFIT 4POLI 2M	1.000	PZ														
CE1285A	FERRITE EMI ROUND MOD. 2643801502		KCE1285A	ROUND FERRITE ELECTROMAGN PROT. 2PCS KIT	<table border="1"> <thead> <tr> <th>Code</th> <th>Description</th> <th>Qty</th> <th>UOM</th> </tr> </thead> <tbody> <tr> <td>CE1285A0</td> <td>FERRITE EMI ROUND MOD. 2643801502</td> <td>2.000</td> <td>PZ</td> </tr> </tbody> </table>	Code	Description	Qty	UOM	CE1285A0	FERRITE EMI ROUND MOD. 2643801502	2.000	PZ				
Code	Description	Qty	UOM														
CE1285A0	FERRITE EMI ROUND MOD. 2643801502	2.000	PZ														

COMPONENT			SPARE PART																						
Code	Description	Image	Code	Description	Kit components																				
CR1040A	PERNO CHIUSURA ELETTRMECC. L.M. MATIC		KCR1040A	LM MATIC DOOR LOCKING PIN KIT	<table border="1"> <thead> <tr> <th>Code</th> <th>Description</th> <th>Qty</th> <th>UOM</th> </tr> </thead> <tbody> <tr> <td>0H10283A0</td> <td>DIMA REGOLAZION E PERNO SHOPPRO</td> <td>1.000</td> <td>PZ</td> </tr> <tr> <td>CR1040A0</td> <td>PERNO CHIUSURA ELETTRMECC C. L.M. MATIC</td> <td>1.000</td> <td>PZ</td> </tr> </tbody> </table>	Code	Description	Qty	UOM	0H10283A0	DIMA REGOLAZION E PERNO SHOPPRO	1.000	PZ	CR1040A0	PERNO CHIUSURA ELETTRMECC C. L.M. MATIC	1.000	PZ								
Code	Description	Qty	UOM																						
0H10283A0	DIMA REGOLAZION E PERNO SHOPPRO	1.000	PZ																						
CR1040A0	PERNO CHIUSURA ELETTRMECC C. L.M. MATIC	1.000	PZ																						
PE1443A	CONTROLLO COMPLETO CAP SP TOUCH		KPE1443A	SP TOUCH CAPACITIVE CONTROL PANEL KI	<table border="1"> <thead> <tr> <th>Code</th> <th>Description</th> <th>Qty</th> <th>UOM</th> </tr> </thead> <tbody> <tr> <td>CE2112A0</td> <td>CAVO MICROFIT 4PM-COND 4,7nF-OCCHIE LLO</td> <td>1.000</td> <td>PZ</td> </tr> <tr> <td>PE1443A0</td> <td>CONTROLLO COMPLETO CAP SP TOUC</td> <td>1.000</td> <td>PZ</td> </tr> <tr> <td>VI1930A1</td> <td>VITE 5X20 TRUCIOLARE INOX</td> <td>2.000</td> <td>PZ</td> </tr> <tr> <td>VM1447A0</td> <td>BUSTA AIRBALL ESD ROSA 230X450 MM</td> <td>1.000</td> <td>PZ</td> </tr> </tbody> </table>	Code	Description	Qty	UOM	CE2112A0	CAVO MICROFIT 4PM-COND 4,7nF-OCCHIE LLO	1.000	PZ	PE1443A0	CONTROLLO COMPLETO CAP SP TOUC	1.000	PZ	VI1930A1	VITE 5X20 TRUCIOLARE INOX	2.000	PZ	VM1447A0	BUSTA AIRBALL ESD ROSA 230X450 MM	1.000	PZ
Code	Description	Qty	UOM																						
CE2112A0	CAVO MICROFIT 4PM-COND 4,7nF-OCCHIE LLO	1.000	PZ																						
PE1443A0	CONTROLLO COMPLETO CAP SP TOUC	1.000	PZ																						
VI1930A1	VITE 5X20 TRUCIOLARE INOX	2.000	PZ																						
VM1447A0	BUSTA AIRBALL ESD ROSA 230X450 MM	1.000	PZ																						
VI1174A	VI1174A0		VI1174A0	VI1174A0																					
VM1209A	BOCCOLA PERNO ELETTROSERRATU RA SP		KVM1209A	BAKERLUX SHOP.PRO PIN BUSHING LOCK KIT	<table border="1"> <thead> <tr> <th>Code</th> <th>Description</th> <th>Qty</th> <th>UOM</th> </tr> </thead> <tbody> <tr> <td>VM1209A0</td> <td>BOCCOLA PERNO ELETTROSER RATURA SP</td> <td>1.000</td> <td>PZ</td> </tr> </tbody> </table>	Code	Description	Qty	UOM	VM1209A0	BOCCOLA PERNO ELETTROSER RATURA SP	1.000	PZ												
Code	Description	Qty	UOM																						
VM1209A0	BOCCOLA PERNO ELETTROSER RATURA SP	1.000	PZ																						

COMPONENT			SPARE PART																																																																										
Code	Description	Image	Code	Description	Kit components																																																																								
VM2274A	BOCCOLA SCANALATA CORTA		KVM2274A	GROOVED PIN BUSHING KIT	<table border="1"> <thead> <tr> <th>Code</th> <th>Description</th> <th>Qty</th> <th>UOM</th> </tr> </thead> <tbody> <tr> <td>VM2274A0</td> <td>BOCCOLA SCANALATA CORTA</td> <td>1.000</td> <td>PZ</td> </tr> </tbody> </table>	Code	Description	Qty	UOM	VM2274A0	BOCCOLA SCANALATA CORTA	1.000	PZ																																																																
			Code	Description	Qty	UOM																																																																							
VM2274A0	BOCCOLA SCANALATA CORTA	1.000	PZ																																																																										
K0B1126AR	BAKERTOP MM RIGHT DOOR LOWER BEAM KIT	<table border="1"> <thead> <tr> <th>Code</th> <th>Description</th> <th>Qty</th> <th>UOM</th> </tr> </thead> <tbody> <tr> <td>0B1126A1</td> <td>TRAVERSO INFERIORE PORTA 860 M</td> <td>1.000</td> <td>PZ</td> </tr> <tr> <td>RC1200A0</td> <td>MOLLA A COMPRESSIO NE De4 Df0.5 H24</td> <td>2.000</td> <td>PZ</td> </tr> <tr> <td>VH1220A1</td> <td>VITE AUTOFIL. 4.2X11 TCS+ MARUTEX</td> <td>1.000</td> <td>PZ</td> </tr> <tr> <td>VI1996A0</td> <td>VITE M5x35 TCEI ZN</td> <td>7.000</td> <td>PZ</td> </tr> <tr> <td>VM1794A0</td> <td>FASCETTA 430X4.8 PA66 NERA</td> <td>2.000</td> <td>PZ</td> </tr> <tr> <td>VM2259A1</td> <td>TAPPO INF SX PORTA S6</td> <td>1.000</td> <td>PZ</td> </tr> <tr> <td>VM2261A1</td> <td>TAPPO INF DX PORTA MM</td> <td>1.000</td> <td>PZ</td> </tr> <tr> <td>VM2267A1</td> <td>CORSOIO SISTEMA FERMA VETRO INT</td> <td>1.000</td> <td>PZ</td> </tr> <tr> <td>VM2269A0</td> <td>TAPPO SISTEMA FERMA VETRO INT</td> <td>1.000</td> <td>PZ</td> </tr> <tr> <td>VM2274A0</td> <td>BOCCOLA SCANALATA CORTA</td> <td>1.000</td> <td>PZ</td> </tr> <tr> <td>VM2305A0</td> <td>NOTTOLINO FISSAGGIO TAPPI PORTE MM</td> <td>7.000</td> <td>PZ</td> </tr> </tbody> </table>	Code	Description	Qty	UOM	0B1126A1	TRAVERSO INFERIORE PORTA 860 M	1.000	PZ	RC1200A0	MOLLA A COMPRESSIO NE De4 Df0.5 H24	2.000	PZ	VH1220A1	VITE AUTOFIL. 4.2X11 TCS+ MARUTEX	1.000	PZ	VI1996A0	VITE M5x35 TCEI ZN	7.000	PZ	VM1794A0	FASCETTA 430X4.8 PA66 NERA	2.000	PZ	VM2259A1	TAPPO INF SX PORTA S6	1.000	PZ	VM2261A1	TAPPO INF DX PORTA MM	1.000	PZ	VM2267A1	CORSOIO SISTEMA FERMA VETRO INT	1.000	PZ	VM2269A0	TAPPO SISTEMA FERMA VETRO INT	1.000	PZ	VM2274A0	BOCCOLA SCANALATA CORTA	1.000	PZ	VM2305A0	NOTTOLINO FISSAGGIO TAPPI PORTE MM	7.000	PZ	K0B1126AL	EU AND 2/1 MM LEFT DOOR LOWER BEAM KIT	<table border="1"> <thead> <tr> <th>Code</th> <th>Description</th> <th>Qty</th> <th>UOM</th> </tr> </thead> <tbody> <tr> <td>0B1126A1</td> <td>TRAVERSO INFERIORE PORTA 860 M</td> <td>1.000</td> <td>PZ</td> </tr> <tr> <td>RC1200A0</td> <td>MOLLA A COMPRESSIO NE De4 Df0.5 H24</td> <td>2.000</td> <td>PZ</td> </tr> <tr> <td>VH1220A1</td> <td>VITE AUTOFIL. 4.2X11 TCS+ MARUTEX</td> <td>1.000</td> <td>PZ</td> </tr> <tr> <td>VI1996A0</td> <td>VITE M5x35 TCEI ZN</td> <td>7.000</td> <td>PZ</td> </tr> <tr> <td>VM1794A0</td> <td>FASCETTA 430X4.8 PA66 NERA</td> <td>2.000</td> <td>PZ</td> </tr> </tbody> </table>	Code	Description	Qty	UOM	0B1126A1	TRAVERSO INFERIORE PORTA 860 M	1.000	PZ	RC1200A0	MOLLA A COMPRESSIO NE De4 Df0.5 H24	2.000	PZ	VH1220A1	VITE AUTOFIL. 4.2X11 TCS+ MARUTEX	1.000	PZ	VI1996A0	VITE M5x35 TCEI ZN	7.000	PZ	VM1794A0	FASCETTA 430X4.8 PA66 NERA	2.000	PZ
Code	Description	Qty	UOM																																																																										
0B1126A1	TRAVERSO INFERIORE PORTA 860 M	1.000	PZ																																																																										
RC1200A0	MOLLA A COMPRESSIO NE De4 Df0.5 H24	2.000	PZ																																																																										
VH1220A1	VITE AUTOFIL. 4.2X11 TCS+ MARUTEX	1.000	PZ																																																																										
VI1996A0	VITE M5x35 TCEI ZN	7.000	PZ																																																																										
VM1794A0	FASCETTA 430X4.8 PA66 NERA	2.000	PZ																																																																										
VM2259A1	TAPPO INF SX PORTA S6	1.000	PZ																																																																										
VM2261A1	TAPPO INF DX PORTA MM	1.000	PZ																																																																										
VM2267A1	CORSOIO SISTEMA FERMA VETRO INT	1.000	PZ																																																																										
VM2269A0	TAPPO SISTEMA FERMA VETRO INT	1.000	PZ																																																																										
VM2274A0	BOCCOLA SCANALATA CORTA	1.000	PZ																																																																										
VM2305A0	NOTTOLINO FISSAGGIO TAPPI PORTE MM	7.000	PZ																																																																										
Code	Description	Qty	UOM																																																																										
0B1126A1	TRAVERSO INFERIORE PORTA 860 M	1.000	PZ																																																																										
RC1200A0	MOLLA A COMPRESSIO NE De4 Df0.5 H24	2.000	PZ																																																																										
VH1220A1	VITE AUTOFIL. 4.2X11 TCS+ MARUTEX	1.000	PZ																																																																										
VI1996A0	VITE M5x35 TCEI ZN	7.000	PZ																																																																										
VM1794A0	FASCETTA 430X4.8 PA66 NERA	2.000	PZ																																																																										

COMPONENT			SPARE PART																																											
Code	Description	Image	Code	Description	Kit components																																									
VM2274A	BOCCOLA SCANALATA CORTA		K0B1126AL	EU AND 2/1 MM LEFT DOOR LOWER BEAM KIT	<table border="1"> <thead> <tr> <th>Code</th> <th>Description</th> <th>Qty</th> <th>UOM</th> </tr> </thead> <tbody> <tr> <td>VM2267A1</td> <td>CORSOIO SISTEMA FERMA VETRO INT</td> <td>1.000</td> <td>PZ</td> </tr> <tr> <td>VM2269A0</td> <td>TAPPO SISTEMA FERMA VETRO INT</td> <td>1.000</td> <td>PZ</td> </tr> <tr> <td>VM2274A0</td> <td>BOCCOLA SCANALATA CORTA</td> <td>1.000</td> <td>PZ</td> </tr> <tr> <td>VM2305A0</td> <td>NOTTOLINO FISSAGGIO TAPPI PORTE MM</td> <td>7.000</td> <td>PZ</td> </tr> <tr> <td>VM2384A0</td> <td>TAPPO INF DX PORTA MM LEFT</td> <td>1.000</td> <td>PZ</td> </tr> <tr> <td>VM2386A1</td> <td>TAPPO INF SX PORTA MM LEFT</td> <td>1.000</td> <td>PZ</td> </tr> </tbody> </table>	Code	Description	Qty	UOM	VM2267A1	CORSOIO SISTEMA FERMA VETRO INT	1.000	PZ	VM2269A0	TAPPO SISTEMA FERMA VETRO INT	1.000	PZ	VM2274A0	BOCCOLA SCANALATA CORTA	1.000	PZ	VM2305A0	NOTTOLINO FISSAGGIO TAPPI PORTE MM	7.000	PZ	VM2384A0	TAPPO INF DX PORTA MM LEFT	1.000	PZ	VM2386A1	TAPPO INF SX PORTA MM LEFT	1.000	PZ													
			Code	Description	Qty	UOM																																								
VM2267A1	CORSOIO SISTEMA FERMA VETRO INT	1.000	PZ																																											
VM2269A0	TAPPO SISTEMA FERMA VETRO INT	1.000	PZ																																											
VM2274A0	BOCCOLA SCANALATA CORTA	1.000	PZ																																											
VM2305A0	NOTTOLINO FISSAGGIO TAPPI PORTE MM	7.000	PZ																																											
VM2384A0	TAPPO INF DX PORTA MM LEFT	1.000	PZ																																											
VM2386A1	TAPPO INF SX PORTA MM LEFT	1.000	PZ																																											
K0B1122AR	CHEFTOP MM RIGHT DOOR LOWER BEAM KIT	<table border="1"> <thead> <tr> <th>Code</th> <th>Description</th> <th>Qty</th> <th>UOM</th> </tr> </thead> <tbody> <tr> <td>0B1122A1</td> <td>TRAVERSO INFERIORE PORTA 750 S6</td> <td>1.000</td> <td>PZ</td> </tr> <tr> <td>RC1200A0</td> <td>MOLLA A COMPRESSIO NE De4 D10.5 H24</td> <td>2.000</td> <td>PZ</td> </tr> <tr> <td>VI1220A1</td> <td>VITE AUTOFIL. 4.2X11 TCS+ MARUTEX</td> <td>1.000</td> <td>PZ</td> </tr> <tr> <td>VI1996A0</td> <td>VITE M5x35 TCEI ZN</td> <td>7.000</td> <td>PZ</td> </tr> <tr> <td>VM2259A1</td> <td>TAPPO INF SX PORTA S6</td> <td>1.000</td> <td>PZ</td> </tr> <tr> <td>VM2261A1</td> <td>TAPPO INF DX PORTA MM</td> <td>1.000</td> <td>PZ</td> </tr> <tr> <td>VM2267A1</td> <td>CORSOIO SISTEMA FERMA VETRO INT</td> <td>1.000</td> <td>PZ</td> </tr> <tr> <td>VM2269A0</td> <td>TAPPO SISTEMA FERMA VETRO INT</td> <td>1.000</td> <td>PZ</td> </tr> <tr> <td>VM2274A0</td> <td>BOCCOLA SCANALATA CORTA</td> <td>1.000</td> <td>PZ</td> </tr> <tr> <td>VM2305A0</td> <td>NOTTOLINO FISSAGGIO TAPPI PORTE MM</td> <td>7.000</td> <td>PZ</td> </tr> </tbody> </table>	Code	Description	Qty	UOM	0B1122A1	TRAVERSO INFERIORE PORTA 750 S6	1.000	PZ	RC1200A0	MOLLA A COMPRESSIO NE De4 D10.5 H24	2.000	PZ	VI1220A1	VITE AUTOFIL. 4.2X11 TCS+ MARUTEX	1.000	PZ	VI1996A0	VITE M5x35 TCEI ZN	7.000	PZ	VM2259A1	TAPPO INF SX PORTA S6	1.000	PZ	VM2261A1	TAPPO INF DX PORTA MM	1.000	PZ	VM2267A1	CORSOIO SISTEMA FERMA VETRO INT	1.000	PZ	VM2269A0	TAPPO SISTEMA FERMA VETRO INT	1.000	PZ	VM2274A0	BOCCOLA SCANALATA CORTA	1.000	PZ	VM2305A0	NOTTOLINO FISSAGGIO TAPPI PORTE MM	7.000	PZ
Code	Description	Qty	UOM																																											
0B1122A1	TRAVERSO INFERIORE PORTA 750 S6	1.000	PZ																																											
RC1200A0	MOLLA A COMPRESSIO NE De4 D10.5 H24	2.000	PZ																																											
VI1220A1	VITE AUTOFIL. 4.2X11 TCS+ MARUTEX	1.000	PZ																																											
VI1996A0	VITE M5x35 TCEI ZN	7.000	PZ																																											
VM2259A1	TAPPO INF SX PORTA S6	1.000	PZ																																											
VM2261A1	TAPPO INF DX PORTA MM	1.000	PZ																																											
VM2267A1	CORSOIO SISTEMA FERMA VETRO INT	1.000	PZ																																											
VM2269A0	TAPPO SISTEMA FERMA VETRO INT	1.000	PZ																																											
VM2274A0	BOCCOLA SCANALATA CORTA	1.000	PZ																																											
VM2305A0	NOTTOLINO FISSAGGIO TAPPI PORTE MM	7.000	PZ																																											

COMPONENT			SPARE PART																																																		
Code	Description	Image	Code	Description	Kit components																																																
VM2274A	BOCCOLA SCANALATA CORTA		K0B1122AL	CHEFTOP MM LEFT DOOR LOWER BEAM KIT	<table border="1"> <thead> <tr> <th>Code</th> <th>Description</th> <th>Qty</th> <th>UOM</th> </tr> </thead> <tbody> <tr> <td>0B1122A1</td> <td>TRAVERSO INFERIORE PORTA 750 S6</td> <td>1.000</td> <td>PZ</td> </tr> <tr> <td>RC1200A0</td> <td>MOLLA A COMPRESSIO NE De4 D10.5 H24</td> <td>2.000</td> <td>PZ</td> </tr> <tr> <td>V11220A1</td> <td>VITE AUTOFIL. 4.2X11 TCS+ MARUTEX</td> <td>1.000</td> <td>PZ</td> </tr> <tr> <td>V11996A0</td> <td>VITE M5x35 TCEI ZN</td> <td>7.000</td> <td>PZ</td> </tr> <tr> <td>VM1794A0</td> <td>FASCETTA 430X4.8 PA66 NERA</td> <td>2.000</td> <td>PZ</td> </tr> <tr> <td>VM2267A1</td> <td>CORSOIO SISTEMA FERMA VETRO INT</td> <td>1.000</td> <td>PZ</td> </tr> <tr> <td>VM2269A0</td> <td>TAPPO SISTEMA FERMA VETRO INT</td> <td>1.000</td> <td>PZ</td> </tr> <tr> <td>VM2274A0</td> <td>BOCCOLA SCANALATA CORTA</td> <td>1.000</td> <td>PZ</td> </tr> <tr> <td>VM2305A0</td> <td>NOTTOLINO FISSAGGIO TAPPI PORTE MM</td> <td>7.000</td> <td>PZ</td> </tr> <tr> <td>VM2384A0</td> <td>TAPPO INF DX PORTA MM LEFT</td> <td>1.000</td> <td>PZ</td> </tr> <tr> <td>VM2386A1</td> <td>TAPPO INF SX PORTA MM LEFT</td> <td>1.000</td> <td>PZ</td> </tr> </tbody> </table>	Code	Description	Qty	UOM	0B1122A1	TRAVERSO INFERIORE PORTA 750 S6	1.000	PZ	RC1200A0	MOLLA A COMPRESSIO NE De4 D10.5 H24	2.000	PZ	V11220A1	VITE AUTOFIL. 4.2X11 TCS+ MARUTEX	1.000	PZ	V11996A0	VITE M5x35 TCEI ZN	7.000	PZ	VM1794A0	FASCETTA 430X4.8 PA66 NERA	2.000	PZ	VM2267A1	CORSOIO SISTEMA FERMA VETRO INT	1.000	PZ	VM2269A0	TAPPO SISTEMA FERMA VETRO INT	1.000	PZ	VM2274A0	BOCCOLA SCANALATA CORTA	1.000	PZ	VM2305A0	NOTTOLINO FISSAGGIO TAPPI PORTE MM	7.000	PZ	VM2384A0	TAPPO INF DX PORTA MM LEFT	1.000	PZ	VM2386A1	TAPPO INF SX PORTA MM LEFT	1.000	PZ
					Code	Description	Qty	UOM																																													
					0B1122A1	TRAVERSO INFERIORE PORTA 750 S6	1.000	PZ																																													
					RC1200A0	MOLLA A COMPRESSIO NE De4 D10.5 H24	2.000	PZ																																													
					V11220A1	VITE AUTOFIL. 4.2X11 TCS+ MARUTEX	1.000	PZ																																													
					V11996A0	VITE M5x35 TCEI ZN	7.000	PZ																																													
					VM1794A0	FASCETTA 430X4.8 PA66 NERA	2.000	PZ																																													
					VM2267A1	CORSOIO SISTEMA FERMA VETRO INT	1.000	PZ																																													
					VM2269A0	TAPPO SISTEMA FERMA VETRO INT	1.000	PZ																																													
					VM2274A0	BOCCOLA SCANALATA CORTA	1.000	PZ																																													
					VM2305A0	NOTTOLINO FISSAGGIO TAPPI PORTE MM	7.000	PZ																																													
					VM2384A0	TAPPO INF DX PORTA MM LEFT	1.000	PZ																																													
					VM2386A1	TAPPO INF SX PORTA MM LEFT	1.000	PZ																																													
VM2275A	BOCCOLA LISCIA CORTA		KVM2275A	SMOOTH PIN BUSHING KIT	<table border="1"> <thead> <tr> <th>Code</th> <th>Description</th> <th>Qty</th> <th>UOM</th> </tr> </thead> <tbody> <tr> <td>VM2275A0</td> <td>BOCCOLA LISCIA CORTA</td> <td>1.000</td> <td>PZ</td> </tr> </tbody> </table>	Code	Description	Qty	UOM	VM2275A0	BOCCOLA LISCIA CORTA	1.000	PZ																																								
Code	Description	Qty	UOM																																																		
VM2275A0	BOCCOLA LISCIA CORTA	1.000	PZ																																																		

COMPONENT			SPARE PART																														
Code	Description	Image	Code	Description	Kit components																												
VT1219A	VETRO EST NERO SER ELENA SP 557x364x4		KVT1219A	ELENA BL SPRO EXT BLACK GLASS KIT	<table border="1"> <thead> <tr> <th>Code</th> <th>Description</th> <th>Qty</th> <th>UOM</th> </tr> </thead> <tbody> <tr> <td>0B0386A0</td> <td>PROFILO SUPPORTO VETRO EST STE-ELE SP</td> <td>2.000</td> <td>PZ</td> </tr> <tr> <td>SL1185A1</td> <td>SILICONE VETRO EXT STE-ELE SP</td> <td>2.000</td> <td>PZ</td> </tr> <tr> <td>V11220A1</td> <td>VITE AUTOFIL. 4.2X11 TCS+ MARUTEX</td> <td>6.000</td> <td>PZ</td> </tr> <tr> <td>VT1219A0</td> <td>VETRO EST NERO SER ELENA SP 557x364x4</td> <td>1.000</td> <td>PZ</td> </tr> </tbody> </table>	Code	Description	Qty	UOM	0B0386A0	PROFILO SUPPORTO VETRO EST STE-ELE SP	2.000	PZ	SL1185A1	SILICONE VETRO EXT STE-ELE SP	2.000	PZ	V11220A1	VITE AUTOFIL. 4.2X11 TCS+ MARUTEX	6.000	PZ	VT1219A0	VETRO EST NERO SER ELENA SP 557x364x4	1.000	PZ								
Code	Description	Qty	UOM																														
0B0386A0	PROFILO SUPPORTO VETRO EST STE-ELE SP	2.000	PZ																														
SL1185A1	SILICONE VETRO EXT STE-ELE SP	2.000	PZ																														
V11220A1	VITE AUTOFIL. 4.2X11 TCS+ MARUTEX	6.000	PZ																														
VT1219A0	VETRO EST NERO SER ELENA SP 557x364x4	1.000	PZ																														
VT1346A	SP ELENA FLAG DOOR INNER GLASS+HINGES		KVT1346A	BL SP ELENA INT LATERAL GLASS KIT	<table border="1"> <thead> <tr> <th>Code</th> <th>Description</th> <th>Qty</th> <th>UOM</th> </tr> </thead> <tbody> <tr> <td>CR1103A0</td> <td>CERNIERA VETRO INTERNO INOX SUP</td> <td>1.000</td> <td>PZ</td> </tr> <tr> <td>CR1104A0</td> <td>CERNIERA VETRO INTERNO INOX INF</td> <td>1.000</td> <td>PZ</td> </tr> <tr> <td>V11810A0</td> <td>VITE NO TESTA EI M6X6 TESTA PIANA INOX</td> <td>6.000</td> <td>PZ</td> </tr> <tr> <td>VM2399A0</td> <td>COVER VITI SENZA TESTA CERNIERE PORTA</td> <td>2.000</td> <td>PZ</td> </tr> <tr> <td>VM2476A0</td> <td>INSERTO CERNIERA VETRO INTERNO H6 BL SP</td> <td>2.000</td> <td>PZ</td> </tr> <tr> <td>VT1331A0</td> <td>VETRO INT ELENA SP 715x318.5x6</td> <td>1.000</td> <td>PZ</td> </tr> </tbody> </table>	Code	Description	Qty	UOM	CR1103A0	CERNIERA VETRO INTERNO INOX SUP	1.000	PZ	CR1104A0	CERNIERA VETRO INTERNO INOX INF	1.000	PZ	V11810A0	VITE NO TESTA EI M6X6 TESTA PIANA INOX	6.000	PZ	VM2399A0	COVER VITI SENZA TESTA CERNIERE PORTA	2.000	PZ	VM2476A0	INSERTO CERNIERA VETRO INTERNO H6 BL SP	2.000	PZ	VT1331A0	VETRO INT ELENA SP 715x318.5x6	1.000	PZ
Code	Description	Qty	UOM																														
CR1103A0	CERNIERA VETRO INTERNO INOX SUP	1.000	PZ																														
CR1104A0	CERNIERA VETRO INTERNO INOX INF	1.000	PZ																														
V11810A0	VITE NO TESTA EI M6X6 TESTA PIANA INOX	6.000	PZ																														
VM2399A0	COVER VITI SENZA TESTA CERNIERE PORTA	2.000	PZ																														
VM2476A0	INSERTO CERNIERA VETRO INTERNO H6 BL SP	2.000	PZ																														
VT1331A0	VETRO INT ELENA SP 715x318.5x6	1.000	PZ																														

ASM8226A/0.D00 - Electrical system - FRONT

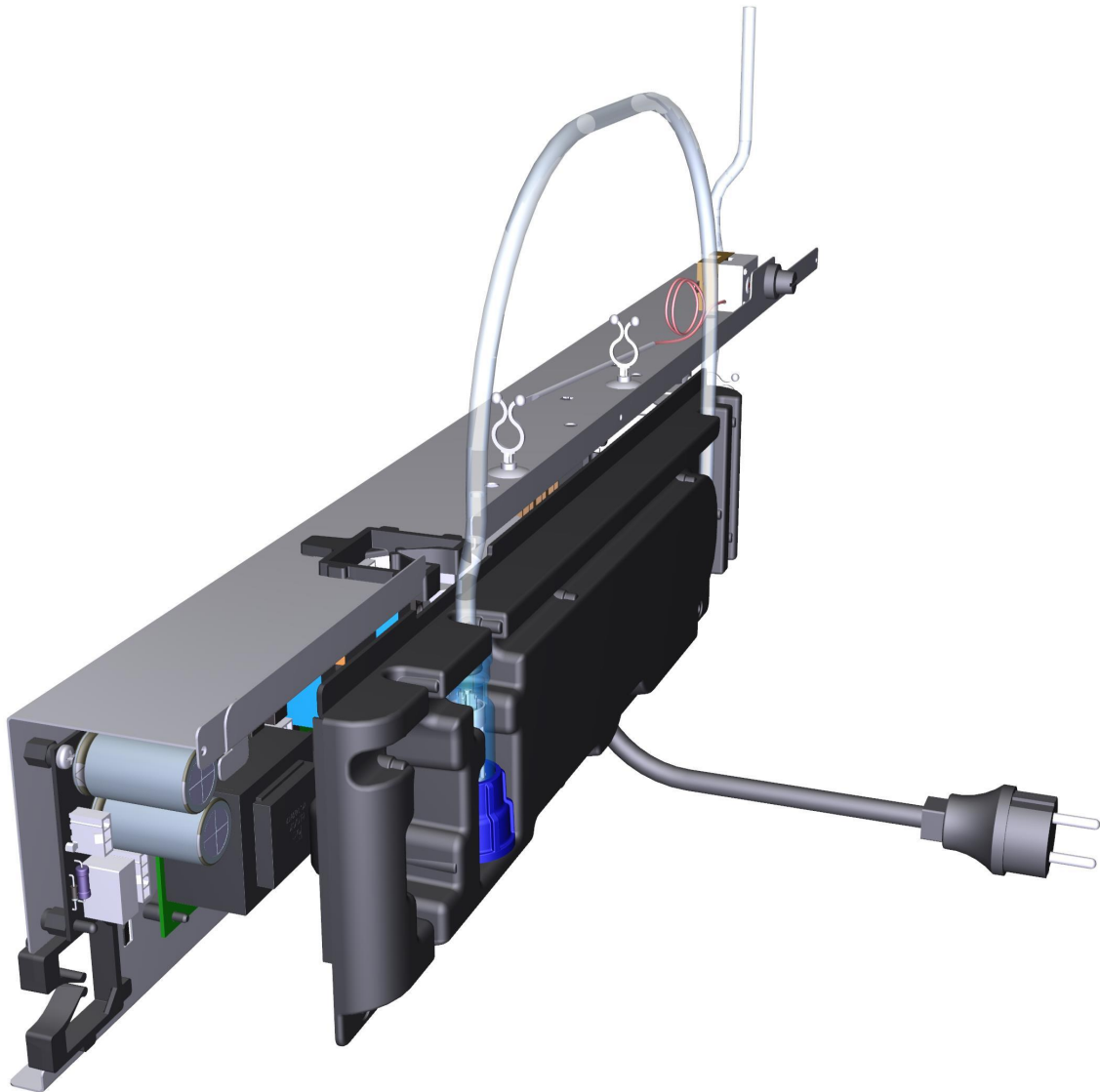





ASM8226A/0.D00 - Electrical system - REAR







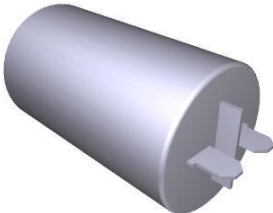
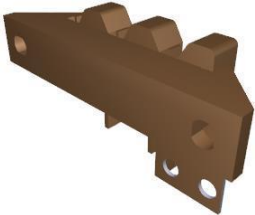

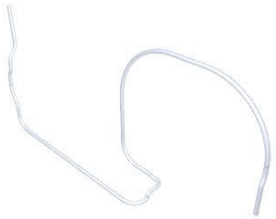

COMPONENT			SPARE PART																		
Code	Description	Image	Code	Description	Kit components																
0P1032A	SP ELE-ROS EL COMPONENTS HOLDER		0P1032A0	SP ELE-ROS EL COMPONENTS HOLDER																	
VE1115A	MINICONTATTORE QUADRIPOLE 20 A 230V		KVE1115A	20A 230V 4 POLES MINICONTACTOR KI	<table border="1"> <thead> <tr> <th>Code</th> <th>Description</th> <th>Qty</th> <th>UOM</th> </tr> </thead> <tbody> <tr> <td>VE1115A0</td> <td>MINICONTATT ORE QUADRIPOLA RE 20 A 230V</td> <td>1.000</td> <td>PZ</td> </tr> <tr> <td>VM1075A1</td> <td>CLIP DI FISSAGGIO PER TELERUTTORI</td> <td>4.000</td> <td>PZ</td> </tr> </tbody> </table>	Code	Description	Qty	UOM	VE1115A0	MINICONTATT ORE QUADRIPOLA RE 20 A 230V	1.000	PZ	VM1075A1	CLIP DI FISSAGGIO PER TELERUTTORI	4.000	PZ				
Code	Description	Qty	UOM																		
VE1115A0	MINICONTATT ORE QUADRIPOLA RE 20 A 230V	1.000	PZ																		
VM1075A1	CLIP DI FISSAGGIO PER TELERUTTORI	4.000	PZ																		
VM1056A	SMALL CONTACTOR BRACKET VE1115A		VM1056A0	SMALL CONTACTOR BRACKET VE1115A																	
VL1145A	RACCORDO 3/4-JG8 CON FILTRO E VNR		KVL1145A	3/4-JG8 FITTING WITH FILTER AND NRV KIT	<table border="1"> <thead> <tr> <th>Code</th> <th>Description</th> <th>Qty</th> <th>UOM</th> </tr> </thead> <tbody> <tr> <td>VL1145A1</td> <td>RACCORDO 3/4-JG8 CON FILTRO E VNR</td> <td>1.000</td> <td>PZ</td> </tr> </tbody> </table>	Code	Description	Qty	UOM	VL1145A1	RACCORDO 3/4-JG8 CON FILTRO E VNR	1.000	PZ								
Code	Description	Qty	UOM																		
VL1145A1	RACCORDO 3/4-JG8 CON FILTRO E VNR	1.000	PZ																		
PE2117A	SCHEDA SERRATURA ELETTROMECCANIC A BLSP		KPE2117A	ELECTRIC LOCKING SYSTEM BOARD KIT 230V	<table border="1"> <thead> <tr> <th>Code</th> <th>Description</th> <th>Qty</th> <th>UOM</th> </tr> </thead> <tbody> <tr> <td>PE2117A0</td> <td>SCHEDA SERRATURA ELETTROMECCANICA BLSP</td> <td>1.000</td> <td>PZ</td> </tr> <tr> <td>VI1850A0</td> <td>VITE M4X6 TCB+ NICHELATA</td> <td>2.000</td> <td>PZ</td> </tr> <tr> <td>VM1447A0</td> <td>BUSTA AIRBALL ESD ROSA 230X450 MM</td> <td>0.500</td> <td>PZ</td> </tr> </tbody> </table>	Code	Description	Qty	UOM	PE2117A0	SCHEDA SERRATURA ELETTROMECCANICA BLSP	1.000	PZ	VI1850A0	VITE M4X6 TCB+ NICHELATA	2.000	PZ	VM1447A0	BUSTA AIRBALL ESD ROSA 230X450 MM	0.500	PZ
Code	Description	Qty	UOM																		
PE2117A0	SCHEDA SERRATURA ELETTROMECCANICA BLSP	1.000	PZ																		
VI1850A0	VITE M4X6 TCB+ NICHELATA	2.000	PZ																		
VM1447A0	BUSTA AIRBALL ESD ROSA 230X450 MM	0.500	PZ																		

COMPONENT			SPARE PART																										
Code	Description	Image	Code	Description	Kit components																								
PE2117A	SCHEDA SERRATURA ELETTROMECCANIC A BLS P		KPE2117A	ELECTRIC LOCKING SYSTEM BOARD KIT 230V	<table border="1"> <thead> <tr> <th>Code</th> <th>Description</th> <th>Qty</th> <th>UOM</th> </tr> </thead> <tbody> <tr> <td>VM1746A0</td> <td>CLIP FISSAGGIO SCHEDA H10 INCASTRO-M4</td> <td>2.000</td> <td>PZ</td> </tr> <tr> <td>VM1747A0</td> <td>CLIP FISSAGGIO SCHEDA H10 INCASTRO-PE RNO</td> <td>2.000</td> <td>PZ</td> </tr> </tbody> </table>	Code	Description	Qty	UOM	VM1746A0	CLIP FISSAGGIO SCHEDA H10 INCASTRO-M4	2.000	PZ	VM1747A0	CLIP FISSAGGIO SCHEDA H10 INCASTRO-PE RNO	2.000	PZ												
Code	Description	Qty	UOM																										
VM1746A0	CLIP FISSAGGIO SCHEDA H10 INCASTRO-M4	2.000	PZ																										
VM1747A0	CLIP FISSAGGIO SCHEDA H10 INCASTRO-PE RNO	2.000	PZ																										
VM1746A	CLIP FISSAGGIO SCHEDA H10 INCASTRO-M4		KVM1746A	BOARD FIXING CLIP JOINT-M4 KIT	<table border="1"> <thead> <tr> <th>Code</th> <th>Description</th> <th>Qty</th> <th>UOM</th> </tr> </thead> <tbody> <tr> <td>VM1746A0</td> <td>CLIP FISSAGGIO SCHEDA H10 INCASTRO-M4</td> <td>10.000</td> <td>PZ</td> </tr> </tbody> </table>	Code	Description	Qty	UOM	VM1746A0	CLIP FISSAGGIO SCHEDA H10 INCASTRO-M4	10.000	PZ																
Code	Description	Qty	UOM																										
VM1746A0	CLIP FISSAGGIO SCHEDA H10 INCASTRO-M4	10.000	PZ																										
VM1747A	CLIP FISSAGGIO SCHEDA H10 INCASTRO-PERNO		KVM1747A	BOARD FIXING CLIP JOINT-PIN KIT	<table border="1"> <thead> <tr> <th>Code</th> <th>Description</th> <th>Qty</th> <th>UOM</th> </tr> </thead> <tbody> <tr> <td>VM1747A0</td> <td>CLIP FISSAGGIO SCHEDA H10 INCASTRO-PE RNO</td> <td>10.000</td> <td>PZ</td> </tr> </tbody> </table>	Code	Description	Qty	UOM	VM1747A0	CLIP FISSAGGIO SCHEDA H10 INCASTRO-PE RNO	10.000	PZ																
Code	Description	Qty	UOM																										
VM1747A0	CLIP FISSAGGIO SCHEDA H10 INCASTRO-PE RNO	10.000	PZ																										
PE2260A	BL SHOP.PRO 230V POWER BOARD		KPE2260A	BL SHOP.PRO 230V POWER CARD KIT	<table border="1"> <thead> <tr> <th>Code</th> <th>Description</th> <th>Qty</th> <th>UOM</th> </tr> </thead> <tbody> <tr> <td>PE2260A2</td> <td>SCHEDA POTENZA BL SHOP.PRO 230V</td> <td>1.000</td> <td>PZ</td> </tr> <tr> <td>V11988A0</td> <td>VITE AUTOFIL. 4.2X19 TCB+ INOX</td> <td>3.000</td> <td>PZ</td> </tr> <tr> <td>VM1187A0</td> <td>TELAIO SCHEDA POTENZA SHOP.PRO</td> <td>1.000</td> <td>PZ</td> </tr> <tr> <td>VM1447A0</td> <td>BUSTA AIRBALL ESD ROSA 230X450 MM</td> <td>1.000</td> <td>PZ</td> </tr> <tr> <td>VM1748A0</td> <td>CLIP FISSAGGIO SCHEDA H10 INCASTRO-IN CAS</td> <td>6.000</td> <td>PZ</td> </tr> </tbody> </table>	Code	Description	Qty	UOM	PE2260A2	SCHEDA POTENZA BL SHOP.PRO 230V	1.000	PZ	V11988A0	VITE AUTOFIL. 4.2X19 TCB+ INOX	3.000	PZ	VM1187A0	TELAIO SCHEDA POTENZA SHOP.PRO	1.000	PZ	VM1447A0	BUSTA AIRBALL ESD ROSA 230X450 MM	1.000	PZ	VM1748A0	CLIP FISSAGGIO SCHEDA H10 INCASTRO-IN CAS	6.000	PZ
Code	Description	Qty	UOM																										
PE2260A2	SCHEDA POTENZA BL SHOP.PRO 230V	1.000	PZ																										
V11988A0	VITE AUTOFIL. 4.2X19 TCB+ INOX	3.000	PZ																										
VM1187A0	TELAIO SCHEDA POTENZA SHOP.PRO	1.000	PZ																										
VM1447A0	BUSTA AIRBALL ESD ROSA 230X450 MM	1.000	PZ																										
VM1748A0	CLIP FISSAGGIO SCHEDA H10 INCASTRO-IN CAS	6.000	PZ																										

COMPONENT			SPARE PART																		
Code	Description	Image	Code	Description	Kit components																
VM1187A	TELAIO SCHEDA POTENZA SHOP.PR		VM1187A0	TELAIO SCHEDA POTENZA SHOP.PR																	
CE1581A	CAVO H07RNF 3G1.5 L1.5MT+SPINA SCHUKO		KCE1581A	H07RNF 3G1.5 L1.5 MT + SHUKO PLUG KIT	<table border="1"> <thead> <tr> <th>Code</th> <th>Description</th> <th>Qty</th> <th>UOM</th> </tr> </thead> <tbody> <tr> <td>CE1581A0</td> <td>CAVO H07RNF 3G1.5 L1.5MT+SPINA SCHUKO</td> <td>1.000</td> <td>PZ</td> </tr> </tbody> </table>	Code	Description	Qty	UOM	CE1581A0	CAVO H07RNF 3G1.5 L1.5MT+SPINA SCHUKO	1.000	PZ								
Code	Description	Qty	UOM																		
CE1581A0	CAVO H07RNF 3G1.5 L1.5MT+SPINA SCHUKO	1.000	PZ																		
CN1003A	CONDENSATORE CORAZZATO 6,3 uF		KCN1003A	6,3 uF MOTOR CAPACITOR KIT	<table border="1"> <thead> <tr> <th>Code</th> <th>Description</th> <th>Qty</th> <th>UOM</th> </tr> </thead> <tbody> <tr> <td>CN1003A0</td> <td>CONDENSATO RE CORAZZATO 6,3 uF</td> <td>1.000</td> <td>PZ</td> </tr> <tr> <td>VI1931A0</td> <td>DADO CONDENSATO RE M8x1.65 H4 CH13 ZINC</td> <td>1.000</td> <td>PZ</td> </tr> <tr> <td>VI1932A0</td> <td>RONDELLA DENTELLATA CONDENSATO RE D8 ZINC</td> <td>1.000</td> <td>PZ</td> </tr> </tbody> </table>	Code	Description	Qty	UOM	CN1003A0	CONDENSATO RE CORAZZATO 6,3 uF	1.000	PZ	VI1931A0	DADO CONDENSATO RE M8x1.65 H4 CH13 ZINC	1.000	PZ	VI1932A0	RONDELLA DENTELLATA CONDENSATO RE D8 ZINC	1.000	PZ
Code	Description	Qty	UOM																		
CN1003A0	CONDENSATO RE CORAZZATO 6,3 uF	1.000	PZ																		
VI1931A0	DADO CONDENSATO RE M8x1.65 H4 CH13 ZINC	1.000	PZ																		
VI1932A0	RONDELLA DENTELLATA CONDENSATO RE D8 ZINC	1.000	PZ																		
MR1025A	MORSETTIERA 3 POLI 450V 41A + TERRA		KMR1025A	3 POLES TERMINAL BLOCK KIT	<table border="1"> <thead> <tr> <th>Code</th> <th>Description</th> <th>Qty</th> <th>UOM</th> </tr> </thead> <tbody> <tr> <td>MR1025A1</td> <td>MORSETTIER A 3 POLI 450V 41A + TERRA</td> <td>1.000</td> <td>PZ</td> </tr> </tbody> </table>	Code	Description	Qty	UOM	MR1025A1	MORSETTIER A 3 POLI 450V 41A + TERRA	1.000	PZ								
Code	Description	Qty	UOM																		
MR1025A1	MORSETTIER A 3 POLI 450V 41A + TERRA	1.000	PZ																		
RC1006A	CURVA GUIDA TUBO PET D8		KRC1006A	20 PCS. Ø8 PET PIPE GUIDE BEND KI	<table border="1"> <thead> <tr> <th>Code</th> <th>Description</th> <th>Qty</th> <th>UOM</th> </tr> </thead> <tbody> <tr> <td>RC1006A0</td> <td>CURVA GUIDA TUBO PET D8</td> <td>20.000</td> <td>PZ</td> </tr> </tbody> </table>	Code	Description	Qty	UOM	RC1006A0	CURVA GUIDA TUBO PET D8	20.000	PZ								
Code	Description	Qty	UOM																		
RC1006A0	CURVA GUIDA TUBO PET D8	20.000	PZ																		

COMPONENT			SPARE PART																										
Code	Description	Image	Code	Description	Kit components																								
TB3283A	TB3283A0		KTB1959A	Ø8 TB1815 TRANSPARENT PIPE 5M KIT	<table border="1"> <thead> <tr> <th>Code</th> <th>Description</th> <th>Qty</th> <th>UOM</th> </tr> </thead> <tbody> <tr> <td>TB1815A0</td> <td>TUBO PE 7,93x4,75 TRASPARENT</td> <td>5.000</td> <td>M</td> </tr> </tbody> </table>	Code	Description	Qty	UOM	TB1815A0	TUBO PE 7,93x4,75 TRASPARENT	5.000	M																
Code	Description	Qty	UOM																										
TB1815A0	TUBO PE 7,93x4,75 TRASPARENT	5.000	M																										
TR1136A	TERMOSTATO SIC. UNIP. 318°C -0/+24		KTR1136A	318°C -0/+24 SAFETY THERMOSTAT KIT	<table border="1"> <thead> <tr> <th>Code</th> <th>Description</th> <th>Qty</th> <th>UOM</th> </tr> </thead> <tbody> <tr> <td>0H8120A0</td> <td>COPERCHIO INGRESSO BULBO XEVL</td> <td>1.000</td> <td>PZ</td> </tr> <tr> <td>GN1531A0</td> <td>GUARNIZIONE TENUTA INGRESSO BULBO</td> <td>1.000</td> <td>PZ</td> </tr> <tr> <td>SL1045A0</td> <td>SILICONE ANTRACITE S57 80 ml</td> <td>1.000</td> <td>PZ</td> </tr> <tr> <td>TR1136A0</td> <td>TERMOSTATO SIC. UNIP. 318°C -0/+24</td> <td>1.000</td> <td>PZ</td> </tr> <tr> <td>VI1220A1</td> <td>VITE AUTOFIL. 4.2X11 TCS+ MARUTEX</td> <td>3.000</td> <td>PZ</td> </tr> </tbody> </table>	Code	Description	Qty	UOM	0H8120A0	COPERCHIO INGRESSO BULBO XEVL	1.000	PZ	GN1531A0	GUARNIZIONE TENUTA INGRESSO BULBO	1.000	PZ	SL1045A0	SILICONE ANTRACITE S57 80 ml	1.000	PZ	TR1136A0	TERMOSTATO SIC. UNIP. 318°C -0/+24	1.000	PZ	VI1220A1	VITE AUTOFIL. 4.2X11 TCS+ MARUTEX	3.000	PZ
Code	Description	Qty	UOM																										
0H8120A0	COPERCHIO INGRESSO BULBO XEVL	1.000	PZ																										
GN1531A0	GUARNIZIONE TENUTA INGRESSO BULBO	1.000	PZ																										
SL1045A0	SILICONE ANTRACITE S57 80 ml	1.000	PZ																										
TR1136A0	TERMOSTATO SIC. UNIP. 318°C -0/+24	1.000	PZ																										
VI1220A1	VITE AUTOFIL. 4.2X11 TCS+ MARUTEX	3.000	PZ																										
VI1328A	VI1328A0		VI1328A0	VI1328A0																									
VM1188A	PASSACAVI SCHEMA POTENZA		KVM1188A	POWER BOARD WIRES PASS-THROUGH 10PCS KIT	<table border="1"> <thead> <tr> <th>Code</th> <th>Description</th> <th>Qty</th> <th>UOM</th> </tr> </thead> <tbody> <tr> <td>VM1188A0</td> <td>PASSACAVI SCHEMA POTENZA</td> <td>10.000</td> <td>PZ</td> </tr> </tbody> </table>	Code	Description	Qty	UOM	VM1188A0	PASSACAVI SCHEMA POTENZA	10.000	PZ																
Code	Description	Qty	UOM																										
VM1188A0	PASSACAVI SCHEMA POTENZA	10.000	PZ																										



COMPONENT			SPARE PART														
Code	Description	Image	Code	Description	Kit components												
VM2482A	TELAIO PORTA COMPONENTI ELETTRICI SP		KVM2482A	BAKERLUX SP ELECTR COMPONENTS HOLDER KIT	<table border="1"> <thead> <tr> <th>Code</th> <th>Description</th> <th>Qty</th> <th>UOM</th> </tr> </thead> <tbody> <tr> <td>VM2482A0</td> <td>TELAIO PORTA COMPONENTI ELETTRICI SP</td> <td>1.000</td> <td>PZ</td> </tr> <tr> <td>VM2484A0</td> <td>FERMACAVO ALLACCIAMEN TO ELETTRIC</td> <td>1.000</td> <td>PZ</td> </tr> </tbody> </table>	Code	Description	Qty	UOM	VM2482A0	TELAIO PORTA COMPONENTI ELETTRICI SP	1.000	PZ	VM2484A0	FERMACAVO ALLACCIAMEN TO ELETTRIC	1.000	PZ
Code	Description	Qty	UOM														
VM2482A0	TELAIO PORTA COMPONENTI ELETTRICI SP	1.000	PZ														
VM2484A0	FERMACAVO ALLACCIAMEN TO ELETTRIC	1.000	PZ														
VM2483A	COPERCHIO PORTA COMPONENTI SP		KVM2483A	BL SHOP.PRO COMPONENTS HOLDER COVER KIT	<table border="1"> <thead> <tr> <th>Code</th> <th>Description</th> <th>Qty</th> <th>UOM</th> </tr> </thead> <tbody> <tr> <td>VM2483A1</td> <td>COPERCHIO PORTA COMPONENTI SP</td> <td>1.000</td> <td>PZ</td> </tr> </tbody> </table>	Code	Description	Qty	UOM	VM2483A1	COPERCHIO PORTA COMPONENTI SP	1.000	PZ				
Code	Description	Qty	UOM														
VM2483A1	COPERCHIO PORTA COMPONENTI SP	1.000	PZ														
VM2484A	FERMACAVO ALLACCIAMENTO ELETTRICO		KVM2484A	CABLE LOCKS ELECTRICAL CONNECTION KIT	<table border="1"> <thead> <tr> <th>Code</th> <th>Description</th> <th>Qty</th> <th>UOM</th> </tr> </thead> <tbody> <tr> <td>VM2484A0</td> <td>FERMACAVO ALLACCIAMEN TO ELETTRIC</td> <td>1.000</td> <td>PZ</td> </tr> </tbody> </table>	Code	Description	Qty	UOM	VM2484A0	FERMACAVO ALLACCIAMEN TO ELETTRIC	1.000	PZ				
Code	Description	Qty	UOM														
VM2484A0	FERMACAVO ALLACCIAMEN TO ELETTRIC	1.000	PZ														
			KVM2482A	BAKERLUX SP ELECTR COMPONENTS HOLDER KIT	<table border="1"> <thead> <tr> <th>Code</th> <th>Description</th> <th>Qty</th> <th>UOM</th> </tr> </thead> <tbody> <tr> <td>VM2482A0</td> <td>TELAIO PORTA COMPONENTI ELETTRICI SP</td> <td>1.000</td> <td>PZ</td> </tr> <tr> <td>VM2484A0</td> <td>FERMACAVO ALLACCIAMEN TO ELETTRIC</td> <td>1.000</td> <td>PZ</td> </tr> </tbody> </table>	Code	Description	Qty	UOM	VM2482A0	TELAIO PORTA COMPONENTI ELETTRICI SP	1.000	PZ	VM2484A0	FERMACAVO ALLACCIAMEN TO ELETTRIC	1.000	PZ
Code	Description	Qty	UOM														
VM2482A0	TELAIO PORTA COMPONENTI ELETTRICI SP	1.000	PZ														
VM2484A0	FERMACAVO ALLACCIAMEN TO ELETTRIC	1.000	PZ														