

microMD

Instruction manual



Read these instructions carefully before using your microwave oven and keep it in a safe place.

By following these instructions, your oven will provide you with many years of good service.

Model:
microMD UK
microMD Euro

Contents

Precautions _____	02	Cleaning instructions _____	08
Safety instructions _____	03	Operation _____	08
Grounding installation _____	04	How to set the U disk _____	14
Cleaning _____	04	Filter cleaning _____	15
Utensils caution _____	05	Splash shield cleaning _____	15
Setting up your oven _____	06	Installation supplement _____	15
Installation _____	07	Troubleshooting _____	16

Precautions to avoid possible exposure to excessive microwave energy

- (a)** Do not attempt to operate this oven with the door open since this can result in harmful exposure to microwave energy. It is important not to break or tamper with the safety interlocks.
- (b)** Do not place any object between the oven front face and the door or allow food deposits, dirt or cleaner residue to accumulate on sealing surfaces.
- (c) WARNING:** If the door or door seals are damaged, the oven must not be operated until it has been repaired by a qualified technician.

If the oven is not maintained in a good state of cleanliness, its surface could be degraded and affect the lifespan of the oven. This can be very dangerous.

Specifications

Model:	microMD UK	microMD Euro
Rated voltage:	240V~50Hz	230V~50Hz
Rated input power(microwave):	3000W	3000W
Rated output power(microwave):	1800W	1800W
Oven capacity:	17L	17L
External dimensions:	420 x 563 x 340mm	420 x 563 x 340mm
Net weight:	Approx. 31.6kg	Approx. 31.6kg
Plug type:	UK 13A	EU 16A Schuko

Important safety instructions warning

To reduce the risk of fire, electric shock, injury to persons or exposure to excessive microwave oven energy when using your appliance, follow basic precautions, including the following:

1. This appliance is not intended for use by persons (including children) with reduced physical, sensory or mental capabilities, or lack of experience and knowledge, unless they have been given supervision or instruction concerning use of the appliance by a person responsible for their safety. Children should be supervised to ensure that they do not play with the appliance.
2. If the supply cord is damaged, it must be replaced by the manufacturer, its service agent or similarly qualified persons in order to avoid a hazard.
3. **WARNING:** Ensure that the appliance is switched off before replacing the lamp to avoid the possibility of electric shock.
4. **WARNING:** It is hazardous for anyone other than a qualified technician to carry out any service or repair operation that involves the removal of a cover which gives protection against exposure to microwave energy.
5. **WARNING:** Liquids and other foods must not be heated in sealed containers since they are liable to explode.
6. **WARNING:** Microwave heating of beverages can result in delayed eruptive boiling, therefore care must be taken when handling the container.
7. **WARNING:** The contents of feeding bottles and baby food jars should be stirred or shaken and the temperature checked before consumption in order to avoid burns.
8. Only use utensils that are suitable for use in microwave ovens.
9. When heating food in plastic or paper containers, remain watchful in case of possible ignition.
10. If smoke is observed, switch off or unplug the appliance and keep the door closed in order to stifle any flames.
11. Eggs in their shell and whole hard-boiled eggs should not be heated in microwave ovens since they may explode, even after microwave heating has ended.
12. The oven should be cleaned regularly and any food deposits should be removed.
13. The appliance must not be cleaned with a water jet.
14. Failure to maintain the oven in a clean condition could lead to deterioration of the surface that could adversely affect the life of the appliance and possibly result in a hazardous situation.
15. Read and follow the instructions on page 2: "PRECAUTIONS TO AVOID POSSIBLE EXPOSURE TO EXCESSIVE MICROWAVE ENERGY".
16. Metallic containers for food and beverages are not allowed during microwave cooking.

Read carefully and keep for future reference

Earthing installation to reduce the risk of injury

Danger

Electric shock hazard: Touching some of the internal components can cause serious personal injury or death. Do not disassemble this appliance.

Warning

Electric shock hazard: Improper use of the earthing installation can result in electric shock. Do not plug into an outlet until appliance is properly installed and earthed.

This appliance must be earthed. In the event of an electrical short circuit, earthing reduces the risk of electric shock by providing an escape wire for the electric current. This appliance is equipped with a cord having an earthing wire with an earthing plug. The plug must be plugged into an outlet that is properly installed and earthed. Consult a qualified electrician or technician if the earthing instructions are not completely understood or if doubt exists as to whether the appliance is properly earthed.

If it is necessary to use an extension cord, use only a 3-wire extension cord.

1. A short power-supply cord is provided to reduce the risks resulting from becoming entangled in or tripping over a longer cord.
2. If a long cord set or extension cord is used:
 - (a) The marked electrical rating of the cord set or extension cord should be at least as great as the electrical rating of the appliance.
 - (b) The extension cord must be an earthing-type 3-wire cord.
 - (c) The long cord should be arranged so that it will not drape over the counter top or tabletop where it can be pulled on by children or tripped over unintentionally.

Cleaning

Be sure to unplug the appliance from the power supply.

1. Clean the cavity of the oven, after using, with a slightly damp cloth.
2. Clean the accessories in the usual way in soapy water.
3. The door frame and seal and neighbouring parts must be cleaned carefully with a damp cloth when they are dirty.
4. Do not use harsh abrasive cleaners or sharp metal scrapers to clean the oven door glass since they can scratch the surface, which may result in shattering of the glass.
5. **Cleaning tip – for easier cleaning of the cavity walls that the cooked food may touch:** Place half a lemon in a bowl, add 300ml (1/2 pint) water and heat on 100% microwave power for 10 minutes. Wipe the oven clean using a soft, dry cloth.

Utensils caution

Personal injury hazard

It is hazardous for anyone other than a qualified technician to carry out any service or repair operation that involves the removal of a cover which gives protection against exposure to microwave energy.

See the instructions in the tables below for: Materials you can use in the microwave oven and the materials to be avoided. There may be certain non-metallic utensils that are not safe to use for microwaving. If in doubt, you can test the utensil in question following the procedure below.

Utensil Test:

1. Fill a microwave-safe container with 1 cup of cold water (250ml) along with the utensil in question.
2. Cook on maximum power for 1 minute.
3. Carefully feel the utensil. If the utensil is warm, do not use it for microwave cooking.
4. Do not exceed 1 minute cooking time.

Materials you can use in the microwave oven

Utensils	Remarks
Browning dish	Follow manufacturer's instructions. The bottom of the browning dish must be at least 3/16 inch (5mm) above the turntable. Incorrect usage may cause the turntable to break.
Dinnerware	Microwave-safe only. Follow manufacturer's instructions. Do not use cracked or chipped dishes.
Glass jars	Always remove lid. Use only to heat food until just warm. Most glass jars are not heat resistant and may break.
Glassware	Heat-resistant oven glassware only. Make sure there is no metallic trim. Do not use cracked or chipped dishes.
Oven cooking bags	Follow manufacturer's instructions. Do not close with a metal tie. Make slits to allow steam to escape.
Paper plates and cups	Use for short-term cooking/warming only. Do not leave oven unattended while cooking.
Paper towels	Use to cover food for reheating and absorbing fat. Use with supervision for short-term cooking only.
Parchment paper	Use as a cover to prevent splattering or a wrap for steaming.
Plastic	Microwave-safe only. Follow the manufacturer's instructions. Should be labelled "Microwave Safe". Some plastic containers soften, as the food inside gets hot. "Boiling bags" and tightly closed plastic bags should be slit, pierced or vented as directed by the packaging.
Plastic wrap	Microwave-safe only. Use to cover food during cooking to retain moisture. Do not allow plastic wrap to touch food.
Thermometers	Microwave-safe only (meat and candy thermometers).
Wax paper	Use as a cover to prevent splattering and retain moisture.

Materials to be avoided in the microwave oven

Utensils	Remarks
Aluminium tray	May cause arcing. Transfer food into microwave-safe dish.
Food carton with metal handle	May cause arcing. Transfer food into microwave-safe dish.
Metal or metal-trimmed utensils	Metal shields the food from microwave energy. Metal trim may cause arcing.
Metal twist ties	May cause arcing and could cause a fire in the oven.
Paper bags	May cause a fire in the oven.
Plastic foam	Plastic foam may melt or contaminate the liquid inside when exposed to high temperature.
Wood	Wood will dry out when used in the microwave oven and may split or crack.

Setting up your oven

Names of oven parts and accessories

Remove the oven and all materials from the carton and oven cavity. Your oven comes with the following accessories:

Instruction Manual x 1

- A** Control panel
- B** Observation window
- C** Safety interlock system
- D** Ceramic board
- E** Filter
- F** Plug
- G** Ventilation

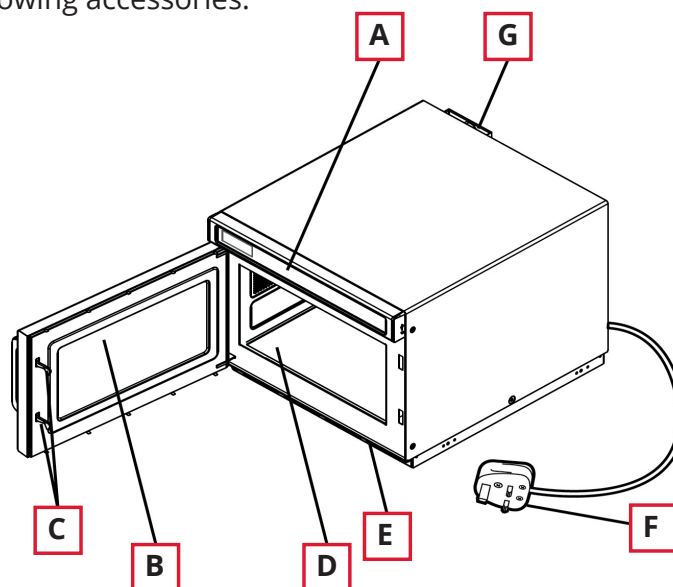

Note:

- 1) Don't press the ceramic board forcibly.
- 2) Gently place and remove utensils during the operation in order to avoid damage to the ceramic board.
- 3) After use, avoid touching the ceramic board as it may cause scalding if hot.

Countertop installation

Remove all packing material and accessories. Examine the oven for any damage such as dents or broken door. Do not install if the oven is damaged.

Case work: Remove any protective film found on the microwave oven case work surface.

Installation

1. Select a level surface that provides enough open space for the intake and/or outlet vents (figure1).

Figure 1

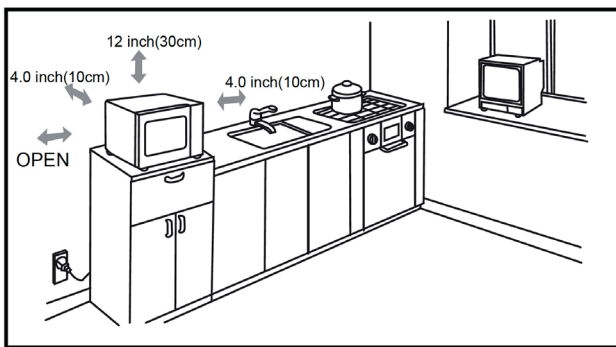

A 10cm spacing should be kept between the appliance and right and back walls, and a 30cm spacing kept on the top. Never dismantle the appliance's feet, nor block the air intake and exhaust opening. The left side must be open.

Additional notes

- a) Blocking the intake and/or outlet openings can damage the oven.
- b) Place the oven as far away from radios and TV as possible. Operation of the microwave oven may cause interference to your radio or TV reception.
- c) Plug your oven into a standard household outlet. Be sure the voltage and the frequency is the same as the voltage and the frequency on the rating label.
- d) **Warning:** Any plugs, sockets or other appliances that could be affected by heat or moisture, should be kept away from oven vents.

2. **Stacking and installation of the microwave oven. The height of stacking should be a maximum of two layers. Specific stacking installation is as follows:**

- a) Unscrew and remove the mounting plate, and then tighten the screws.
- b) Remove the four screws as shown in the diagram below.
- c) Mount the mounting plate to the lower position and fix the screws that are just loosened.

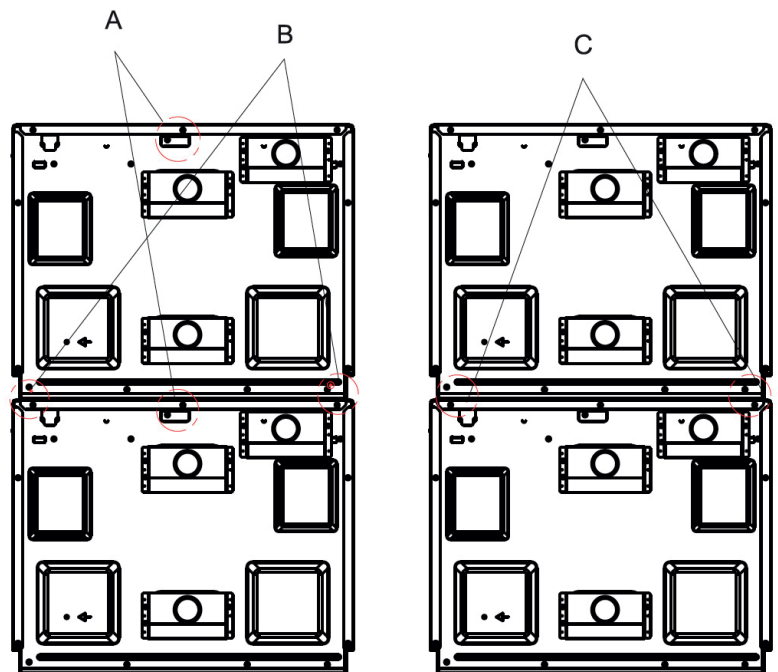

Cleaning Instructions

Always keep the oven clean

- 1. Cleaning the glass viewing window, the inner door panel and oven front face** For best performance and to maintain the high degree of safety, the inner door panel and oven front face should be free of food or grease build-up. Wipe these parts with a mild detergent, rinse and wipe dry. Never use abrasive powders or pads.
- 2. Cleaning the control panel and plastic parts** Do not apply a detergent or an alkaline liquid spray to the control panel and plastic parts, as this may cause damage to these parts. Use a dry cloth (not a soaked cloth) to clean these parts.
- 3. Cleaning the oven interior** After use be sure to clean up spilled liquids, splattered oil and food debris as quickly as possible. Using the oven when dirty may cause bad odours from the food particles stuck on the oven surface. Clean the interior with a warm wet cloth using a mild detergent, then rinse the soap off with a damp cloth.
- 4. Clean the filter regularly, keep it clear** The appliance will over-heat when the filter is blocked.
- 5. When the appliance is operated, oil blockage and filter location must be correct, avoiding damage to other parts** (See the installation instructions on page 7).

Caution: Do not wipe plastic and painted sections of the oven with bleach, thinners or other cleaning agents, as this may cause these parts to dissolve or change shape.

Operation

Control panel (with braille) and features

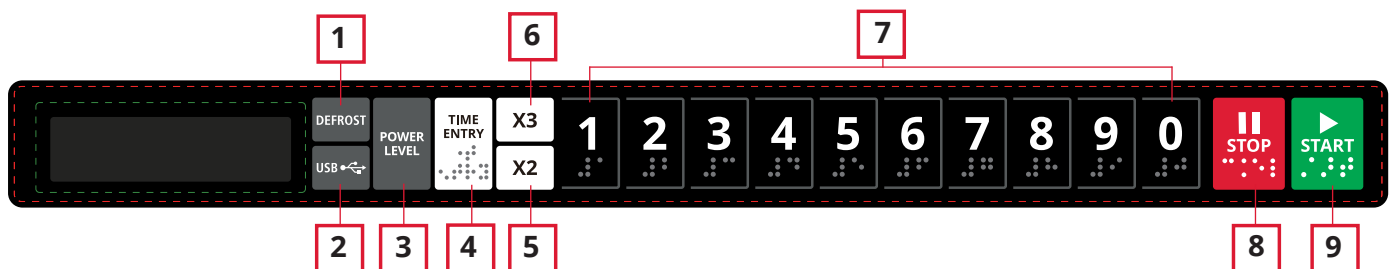

- | | | |
|-----------------------------|---------------------------------|------------------------------|
| 1 Defrost button | 4 Time entry button | 7 Number buttons |
| 2 USB buttons | 5 Double quantity button | 8 Stop / reset button |
| 3 Power level button | 6 Triple quantity button | 9 Start button |

1. Power up

When the oven is turned on for the first time, "-----" will display. If " " button pressed, the oven will change to idle mode.

Note: Under idle mode, the buttons will not respond to being pressed.

2. Idle mode

- (a) The oven will change from ready mode to idle mode after a few seconds if the keyboard is not pressed or the door is not opened or closed. The number of seconds this takes is set by the keyboard time-out window (see User Option 4, Appendix A p13).
- (b) During idle mode, the screen is blank and the oven is not in action.
- (c) Exit the idle mode and into ready mode by opening and closing the oven door.

Note: Under idle mode, the buttons will not respond. If you press the " " button, the buzzer will ring once but there will be no oven activity.

3. Ready mode

- (a) In this mode, the oven is ready to either begin a manual or pre-set cook cycle.
- (b) Opening and closing the door while the oven is in idle mode will put the oven into ready mode.
- (c) During ready mode, "READY" displays.
- (d) From the ready mode, the oven can go to almost all of the other modes.

4. Door open mode

- (a) While the door of the oven is open, the oven will be in door open mode.
- (b) During this mode, the screen is blank. If the door is open during cooking state, "DOOR" and "OPEN" will display in order once only. Then the screen will display the remaining cooking time. The fan and oven lamp will work.
- (c) When the door is closed, the oven will enter ready mode.

Note: When the door is open, if user option OP:60 (see User Options Appendix A, p13) is selected and the oven is running a manual or pre-set cook cycle, the oven will enter pause mode. In all other cases, the oven will return to door open mode with user option OP:61 set (see User Options Appendix A, p13). Opening and closing the door will clear override any manual or pre-set program that was running.

5. Pause mode

- (a) This mode allows the users to temporarily stop the cooking cycle to inspect or stir the food.
- (b) While in manual cook mode or pre-set program cook mode, if the door is opened and then closed, or if the " " keypad is pressed, the oven will enter pause mode.
- (c) While paused, the screen will display the remaining cooking time.
- (d) Pause mode will go to idle mode if no action is taken. The number of seconds this takes is set by the keyboard time-out window (see User Option 4, Appendix A p13). Additionally, if the " " button is pressed, the oven will immediately enter ready mode OR if press " " button, the oven will go into working mode.

6. Manual cook entry mode

- (a) The user may manually enter a cook time and power level while in this mode.
- (b) While the oven is in the ready mode, pressing the "Time Entry" keypad on the keyboard will put the oven into manual cook entry mode.
- (c) During this mode, "00:00" displays. Input the time you need.
- (d) Press the "Power Level" button, "%POWER" displays. Press the number buttons to select the power level you want, and the corresponding power will light. If you want to choose full power level, press "1" and "0" successively, then the screen will display "%POWER". If no power is chosen, 100% power is the default.
- (e) During the setting process, press " " to enter manual cook mode. Press " " to enter ready mode.

7. Manual cook mode

- (a) This mode allows cooking of the food items. While in manual cook entry mode, pressing the " " keypad will cause the oven to begin manual cook mode.
- (b) During this mode, the remaining cooking time displays. The fan and oven lamp will work.
- (c) When the cooking program finishes, the oven will enter end-of-cook-cycle mode. If you press " " button under this mode, the oven will enter pause mode.



8. End-of-cook-cycle mode

- (a) When the manual cook mode or a pre-set program cook mode finishes, the oven will go into the end-of-cook-cycle mode.
- (b) During this mode, "DONE" displays.
- (c) If either user option "OP:11" or "OP:12" (see User Options, Appendix A p13) is selected, the oven will continue to sound until the user acknowledges this by either opening and closing the door or pressing the "▶" keypad. If the User Option OP:10 is selected, after the 3 second beep, the oven will display "DONE". After the beep, "READY" will display and the oven will enter idle mode without any operation for a period of time.

9. Pre-set program cook mode

- (a) This mode allows cooking of food items through a one keypad touch operation. While in ready mode, pressing number buttons will cause the oven to run the pre-set program associated with that number button.
- (b) During this mode, the screen displays the remaining cooking time. If it is multi-stage cooking, the total remaining cooking time displays no particular stage cooking time.
- (c) When the cooking program finishes, the oven will enter end of cook-cycle mode. If you press "▶" button under this mode, the oven will enter pause mode.

10. Ad-hoc cooking

- (a) While the oven is cooking, if user option "OP:51" (see User Options, Appendix A p13) is selected, press number buttons, the pre-set cooking program will start automatically.
- (b) The screen displays the remaining cooking time.
- (c) When the cooking program finishes, the oven will enter end-of-cook-cycle mode.

11. Time defrost function

- (a) In ready mode, press "DEFROST" button, the screen will display "00.00".
- (b) Press the number buttons to input defrosting time. The maximum time is 99 minutes and 99 seconds.

- (c) Press "▶" to start defrosting. The default power is power level 20%.
- (d) The remaining cooking time will be displayed. When the cooking program finishes, the oven will enter end-of-cook-cycle mode. If you press "▶" button under this mode, the oven will enter pause mode.

12. Programming mode

This mode allows the user to assign cook times and power levels to the once touch button

- (a) Open the door and press "1" keypad for 5 seconds, the buzzer will sound once and enter into programming mode.
- (b) "PROGRAM" displays.
- (c) Setting program: Press the number button to set the program. 2 seconds later, the screen will display the time associated with that number button.
- (d) Input the time: Press the number buttons to input time.
- (e) Press the "POWER LEVEL" button, "%POWER" displays. Press the number buttons to select the power level you want, and the corresponding power will light. If you want to choose full power level, press "1" and "0" successively. The screen will then display "%POWER". If no power is chosen, 100% power is the default.

Note: Set the time first, then choose the power.

- (f) After setting the time and power, press "▶", the cooking program will be saved. When the program is saved, "PROGRAM" displays.
- (g) If the cooking time you have input exceeds the max. time in user option 7 (see User Option 7, Appendix A p13), when you press "▶" to save the program, the buzzer will sound three times briefly to tell you there is an error. The screen will then display "PROGRAM". The time set before will not change.

- (h) Close the door, the oven will turn back to ready mode. If you press “” button during the setting process, the oven turns to door-open mode. The program will not save and will be lost. If there is a saved program stored, press the related number button and the saved program will start. If there is no saved program, a buzzer will alarm when pressing the number button and it will not work.

For example, set the program as memory cooking. Power level 70% and cooking time is 1 minute 25 seconds.

Step 1: Open the door, press number button “1” for 5 seconds, “PROGRAM” displays.

Step 2: Press number button “3”, the screen will display “P:03”. After two seconds, the screen will display the related time “:30”.

Step 3: Press number buttons “1”, “2” and “5” to input the cooking time.

Step 4: Press the button “POWER LEVEL”, and then press button number “7”, “1:25 70” displays. Setting finished.

Step 5: Press “” to save. When using the program next time, just press “3”, the related program will start.

Note:

1. If the electricity is cut off, the saved program will not be lost.
2. If the program needs to reset, just repeat the above steps.
3. If “” is pressed at the last step, it will turn back to door open mode.

13. Double/triple quantity cooking

- (a) If the “X2” or “X3” button is pressed in ready mode, followed by the starting of a pre-set program, or if the “X2” or “X3” button is pressed in 5 seconds of starting a pre-set program, the oven will start cooking with the quantity pre-set cooking time.
- (b) Press “X2”, “DOUBLE” displays. Press “X3”, “TRIPLE” displays. After pressing the number buttons, the screen will display the total quantity pre-set time. For example, number button “5” and its pre-set time is 1 minute. Then press “X2”, then time will change to 1:00*2=2 (2 minutes)
- (c) When the cooking program finishes, the oven will enter end-of-cook-cycle mode.

14. Stage cooking programming

This allows the user to cook food items in manual cook mode and programming mode.

- (a) A maximum of 3 stages can be set under cooking mode or programming mode. After setting the power and time for the first stage, press “Time Entry” to set the second stage. Repeat the same steps for the third stage.
- (b) When setting the second and third stages, press “Time Entry”, “STAGE-2”, “STAGE-3” displays.
- (c) Press “” button to start cooking. For example: In programming mode, press number button “3” to set two stages of cooking. The first stage is PL7 and time is 1 minute 25 seconds. The second stage is PL5 and 5 minutes and 40 seconds. The steps are as follows.

Step 1: Open the door, press number button “1” for 5 seconds, “PROGRAM” displays.

Step 2: Press number button “3”, the screen will display “P:03”, After two seconds, the screen will display the related time “:30”.

Step 3: Press “1”, “2”, “5” to input the cooking time. “1:25” displays.

Step 4: Press the button “POWER LEVEL”, and then press number 7, “1:25 70” displays. The first stage is finished.

Step 5: Press “Time Entry”, “STAGE-2” displays.

Step 6: Press “5”, “4”, “0” button, “5:40” displays.

Step 7: Press the button “POWER LEVEL”, and then press number 5, “5:40 50” displays. The second stage is finished.



Step 8: Press “” button to start cooking.



15. Filter cleaning function

- (a) If the user option OP:01 is selected and the setting time appears, the oven will remind the user to clean the filter.

Note: The oven must be turned on.



- (b) The screen will display "CLEAN FILTER". At this time, pressing " " button or opening the door will put the oven into ready mode.
- (c) If you do not need to clean the filter, press " " button and hold for 3 seconds to clear out the reminder information. Otherwise, the oven will remind you throughout idle mode.

16. USB function

- (a) During ready mode, insert the USB which has a "UTABLE" file on it.
- (b) Press "USB" button to update the data of the computer board. "LOADING" displays.
- (c) If the update is successful, the screen will display "SUCCESS". Otherwise, "FAIL" will display.
- (d) Press " " or open the door to finish it.



17. Use option mode

This allows the user to choose between various ways for the oven to operate.

- (a) Open the oven door and press "2" keypad for 5 seconds. The buzzer sounds once and enter this mode.
- (b) The screen displays "OP: - -".
- (c) Press any number button to enter related mode setting. For example: to set the voice of the buzzer to medium. Press "2", "OP:22" displays. If you want to change, keep pressing "2", the screen displays "OP:20", "OP:21", "OP:22", "OP:23", "OP:20"in cycle.
- (d) Press " " to save the current setting. After saved, "OP: - -" displays again.
- (e) During the setting process, press " " to enter door open mode. Close the door will enter ready mode.
- (f) If " " button is not pressed at the last step, the program cannot be saved and will remain the previous way.

18. Factory-default setting

In ready mode, press " " and "0" to factory-default setting.

- (a) Press " " and "0", the buzzer sounds once and the screen will display "CHECK." If it is in the factory-default setting, the screen will display "11" after three seconds, the oven turns to the ready mode. Press " " to cancel the display and back to ready in the process of display.

If not in the factory-default setting the screen will display "00", press " " to the factory-default setting, the screen will display "CLEAR", the buzzer sounds once, after self-testing, the screen will display "11" or "00".

- (b) If you do not press " " when the screen displays " 00 ", the setting will cancel.

Note: Be careful throughout the operation as it will restore all configuration to factory-default setting.

Operation instruction

Appendix A: User Options. Items in bold below are the default values.

Specifications

Option	Setting	Description
1 EOC tone	OP:10	3 seconds beep
	OP:11	Continuous beep
	OP:12	5 quick beeps, repeating
2 Beeper volume	OP:20	Beeper off
	OP:21	Low
	OP:22	Medium
	OP:23	High
3 Beeper on/off	OP:30	Keybeep off
	OP:31	Keybeep on
4 Keyboard window	OP:40	15 seconds
	OP:41	30 seconds
	OP:42	60 seconds
	OP:43	120 seconds
5 Ad-hoc	OP:50	Ad-hoc disabled
	OP:51	Ad-hoc enabled
6 Door reset	OP:60	Door reset disabled
	OP:61	Door reset enabled
7 Max time	OP:70	60 minute maximum cook time
	OP:71	10 minute maximum cook time
8 Manual programming	OP:80	Manual programming disabled
	OP:81	Manual programming enabled
9 Double digit	OP:90	Single digit Mode-10 programs
	OP:91	Double digit mode-100 programs
0 Clean filter	OP:00	Off - never display clean filter
	OP:01	Weekly - display every 7 days
	OP:02	Monthly - display every 30 days
	OP:03	Quarterly - display every 90 days

Appendix B: Default cook times

The oven will ship with the following pre-set cook times unless otherwise noted in the product specification.

Button	Display (time)	Power
1	0:10	100%
2	0:20	100%
3	0:30	100%
4	0:45	100%
5	1:00	100%
6	1:30	100%
7	2:00	100%
8	2:30	100%
9	3:00	100%
0	3:30	100%



How to use USB updates

1. Insert the USB disk into the computer and open the file called "Setup".

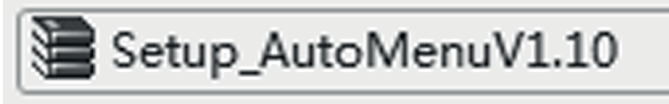

2. Double-click "MenuEdit" to enter editable interface. (Recommendation: Right-click and choose "Run as administrator".)

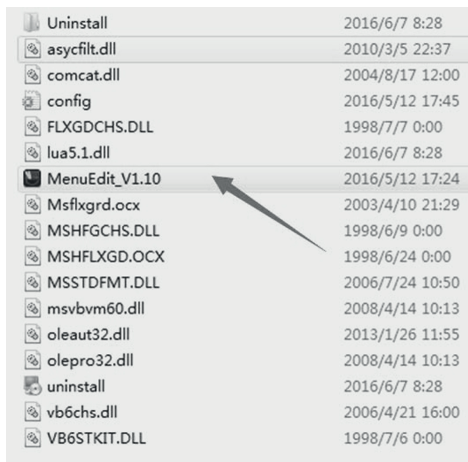

3. Set the maximum cooking time of single menu.

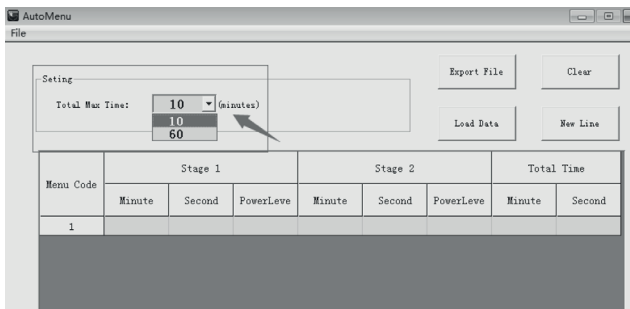

4. Set the first menu. A maximum of 2 cooking stages can be set. You can set the cooking time and power.

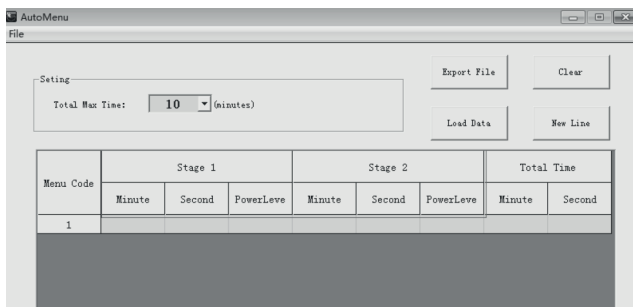

5. Click "New Line " to create the second menu, the third menu, the fourth menu... A maximum of 20 menus can be set.

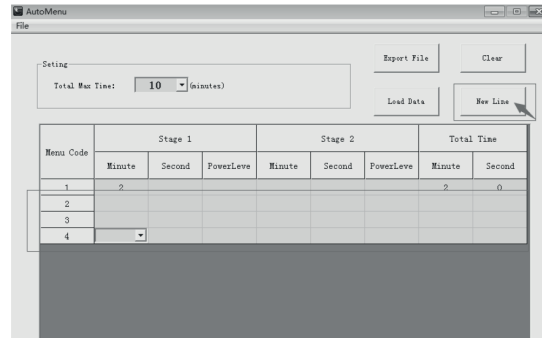

6. Click "Export file" to export the file to U disk. The file will be named "UTABLE.C ". Then click "SAVE" to finish the setting.

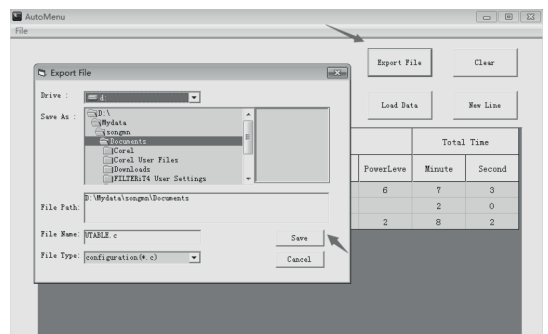

Filter cleaning

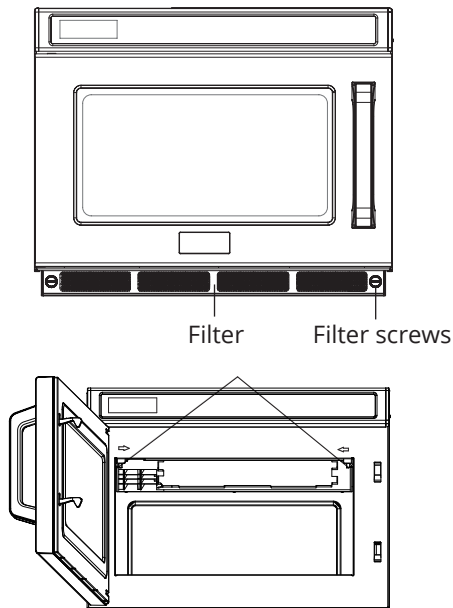

Caution! Make sure the splash shield is installed correctly before using the microwave oven.

The front filter serves as the air inlet; the filter should be cleaned regularly to keep the cavity clean.

1. Turn counter clockwise to unscrew and remove the filter and wash it with warm soapy water.
2. To install the filter screen, tighten the screws clockwise to secure the filter.
3. Ensure the filter is installed before use of the microwave oven.
4. The factory setting has the function to remind the user of washing the filter every 30 days.

Splash shield cleaning

1. **Detaching:** Hold the two buckle positions in front of the splash shield (as shown above by the arrows). Apply your strength in the direction of the arrows and pull downwards after you have pulled out the buckles.
2. Wash the splash shield.
3. **Installation:** Pick up the splash shield and put it into the cavity in the way that it was originally inserted, at the rear, into the positioning hole on the rear plate of cavity. Then push the other side to insert all positioning pins are in their positioning holes.

Installation (supplement)

1. The switching operation of this microwave oven can cause voltage fluctuations on the supply line. The operation of this oven, under unfavourable voltage supply conditions, can have adverse effects. This device is intended for the connection to a power supply system with a maximum permissible system impedance Z_{max} of **0.3 Ohms** at the interface point of the user's supply. The user has to ensure that this device is connected only to a power supply system which fulfils the requirement above. If necessary, the user can ask their public power supply company for the system impedance at the interface point.
2. If there is no equipotential bonding conductor in the electric supply, an external equipotential bonding conductor must be installed at the rear of the appliance (see symbol below). This terminal shall be in effective electrical contact with all fixed exposed metal parts and shall allow the connection of a conductor having a nominal cross-sectional area up to 10 mm².

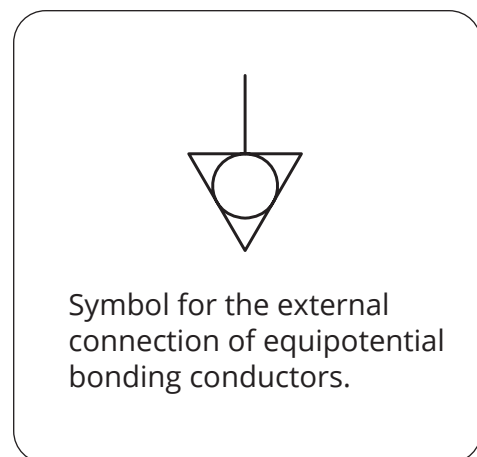

Trouble shooting

Normal	
Microwave oven interfering TV reception	Radio and TV reception may be interfered with when the microwave oven is operating. It is similar to the interference of small electrical appliances like a mixer, vacuum cleaner or electric fan. It is normal.
Dim oven light	In low power microwave cooking, oven light may become dim. It is normal.
Steam accumulating on door, hot air out of vents	While cooking, steam may come out of food. Most will be released out of the vents but some may accumulate on cool places like the oven door. It is normal.
Oven started accidentally with no food in.	Do not run the unit without any food inside. It is very dangerous.

Problem	Possible cause	Solution
Oven cannot be started.	(1) Power cord not plugged in tightly	Unplug. Then plug in again after 10 seconds.
	(2) Fuse blowing or circuit breaker does not work.	Replace fuse or reset circuit breaker (repaired by qualified technician).
	(3) Trouble with outlet.	Test outlet with other electrical appliances.
Oven does not heat.	(4) Door not closed well.	Ensure door is closed well.



According to Waste of Electrical and Electronic Equipment (WEEE) directive, WEEE should be separately collected and treated. If at any time in future you need to dispose of this product please do NOT dispose of this product with household waste. Please send this product to WEEE collecting points where available.