

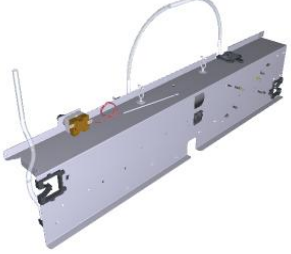

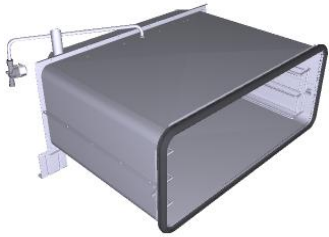

Assembly code	Assembly revision	Assembly image
ASM3440A/0.D00	Electrical system	
ASM3403A/0.D00	Cooking chamber	
ASM3421A/0.D00	Door	
ASM3409A/0.D01	External cover	

ASM3440A/0.D00 - Electrical system

FRONT

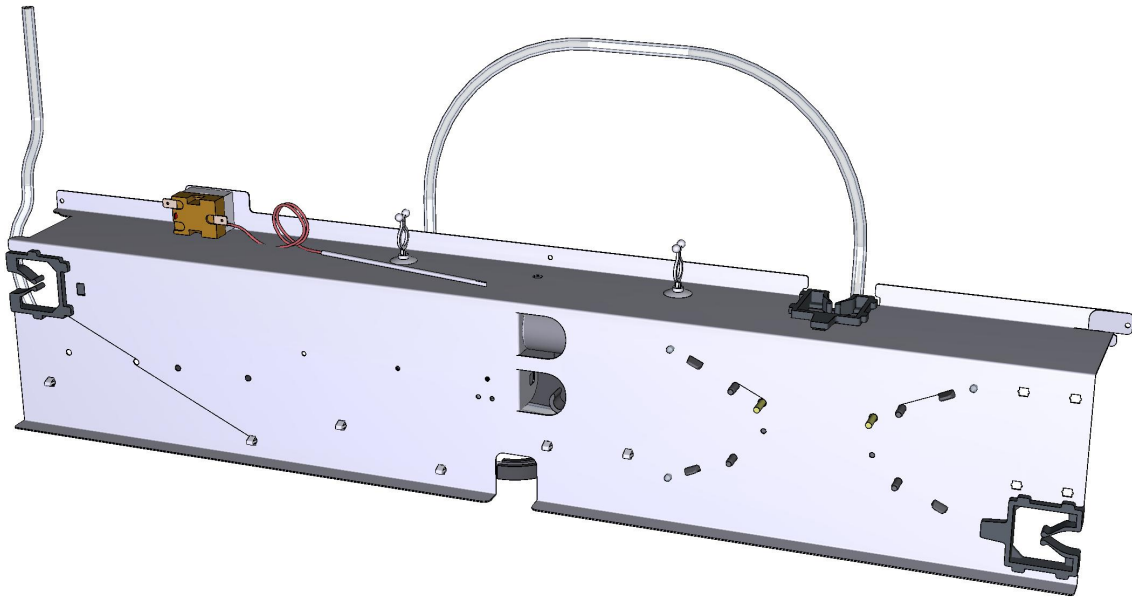





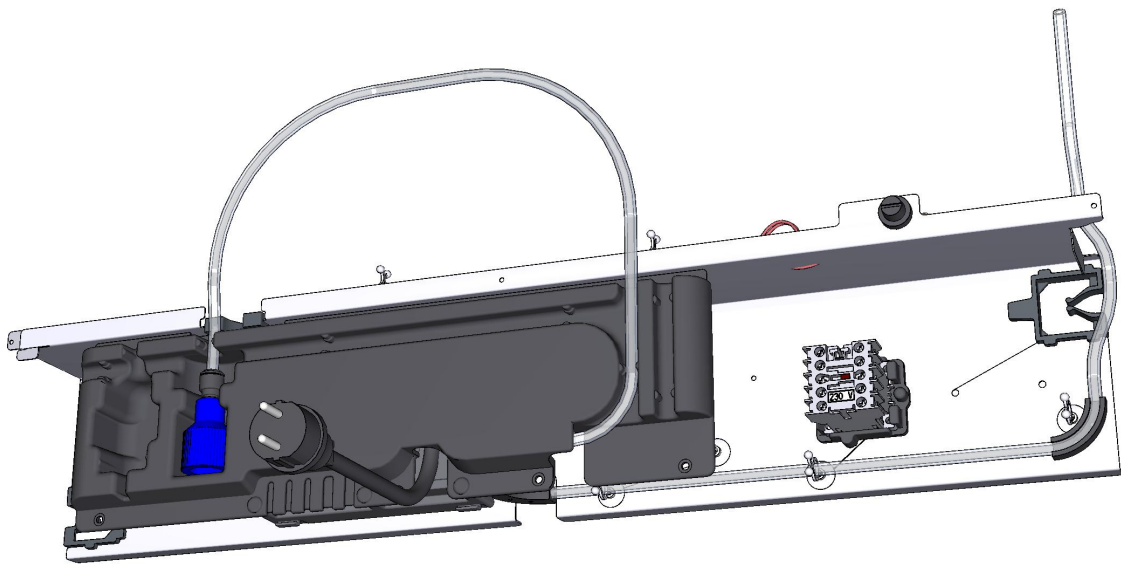

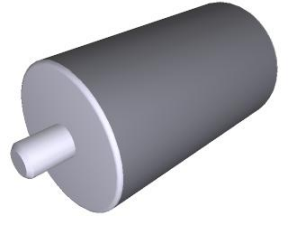
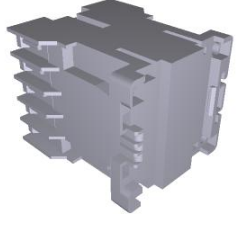
ASM3440A/0.D00 - Electrical system



REAR



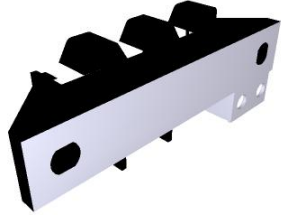

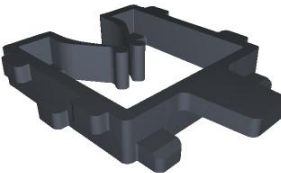
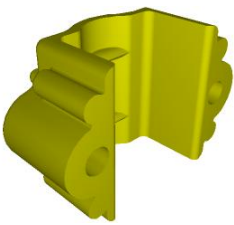

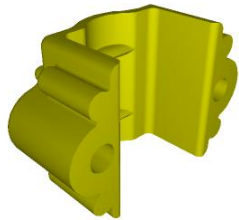
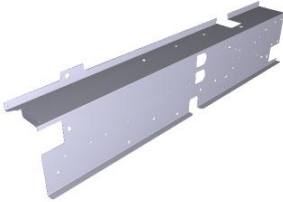
COMPONENT			SPARE PART																																		
Code	Description	Image	Code	Description	Components list																																
TR1136A	330 °C 1 POLE SAFETY THERMOSTAT		KTR1136A	330 °C SAFETY THERMOSTAT KIT	<table border="1"> <thead> <tr> <th>Code</th> <th>Description</th> <th>Qty</th> <th>UOM</th> </tr> </thead> <tbody> <tr> <td>0H7030A0</td> <td>THERMOSTAT BULB INLET COVER</td> <td>1</td> <td>PZ</td> </tr> <tr> <td>GN1531A0</td> <td>THERMOSTAT BULB INLET SEALING</td> <td>1</td> <td>PZ</td> </tr> <tr> <td>MOV0011A0</td> <td>HOOD RING GASKET</td> <td>0.100</td> <td>PZ</td> </tr> <tr> <td>GN1110A2</td> <td></td> <td></td> <td></td> </tr> <tr> <td>SL1045A0</td> <td>S57 BLACK SILICONE - CARTRIDGE</td> <td>1</td> <td>PZ</td> </tr> <tr> <td>TR1136A0</td> <td>330 °C 1 POLE SAFETY THERMOSTAT</td> <td>1</td> <td>PZ</td> </tr> <tr> <td>VI1220A1</td> <td>4,2X12 TCB SELF-TAPPING SCREW</td> <td>3</td> <td>PZ</td> </tr> </tbody> </table>	Code	Description	Qty	UOM	0H7030A0	THERMOSTAT BULB INLET COVER	1	PZ	GN1531A0	THERMOSTAT BULB INLET SEALING	1	PZ	MOV0011A0	HOOD RING GASKET	0.100	PZ	GN1110A2				SL1045A0	S57 BLACK SILICONE - CARTRIDGE	1	PZ	TR1136A0	330 °C 1 POLE SAFETY THERMOSTAT	1	PZ	VI1220A1	4,2X12 TCB SELF-TAPPING SCREW	3	PZ
Code	Description	Qty	UOM																																		
0H7030A0	THERMOSTAT BULB INLET COVER	1	PZ																																		
GN1531A0	THERMOSTAT BULB INLET SEALING	1	PZ																																		
MOV0011A0	HOOD RING GASKET	0.100	PZ																																		
GN1110A2																																					
SL1045A0	S57 BLACK SILICONE - CARTRIDGE	1	PZ																																		
TR1136A0	330 °C 1 POLE SAFETY THERMOSTAT	1	PZ																																		
VI1220A1	4,2X12 TCB SELF-TAPPING SCREW	3	PZ																																		
CN1003A	6,3 UF MOTOR CAPACITOR		KCN1003A	6,3 UF MOTOR CAPACITOR KIT	<table border="1"> <thead> <tr> <th>Code</th> <th>Description</th> <th>Qty</th> <th>UOM</th> </tr> </thead> <tbody> <tr> <td>CN1003A0</td> <td>6,3 UF MOTOR CAPACITOR</td> <td>1</td> <td>PZ</td> </tr> <tr> <td>VI1931A0</td> <td>M8 NUT+INDENTE D WASHER D=8 X COND.</td> <td>1</td> <td>PZ</td> </tr> <tr> <td>VI1932A0</td> <td>M8 NUT+INDENTE D WASHER D=8 X COND.</td> <td>1</td> <td>PZ</td> </tr> <tr> <td>VM1224A0</td> <td>65MY 220MM 2 COLOURS SHRINK TUBE</td> <td>0.200</td> <td>M</td> </tr> </tbody> </table>	Code	Description	Qty	UOM	CN1003A0	6,3 UF MOTOR CAPACITOR	1	PZ	VI1931A0	M8 NUT+INDENTE D WASHER D=8 X COND.	1	PZ	VI1932A0	M8 NUT+INDENTE D WASHER D=8 X COND.	1	PZ	VM1224A0	65MY 220MM 2 COLOURS SHRINK TUBE	0.200	M												
Code	Description	Qty	UOM																																		
CN1003A0	6,3 UF MOTOR CAPACITOR	1	PZ																																		
VI1931A0	M8 NUT+INDENTE D WASHER D=8 X COND.	1	PZ																																		
VI1932A0	M8 NUT+INDENTE D WASHER D=8 X COND.	1	PZ																																		
VM1224A0	65MY 220MM 2 COLOURS SHRINK TUBE	0.200	M																																		
VE1115A	20 A 230V 4 POLES MINICONTACTOR		KVE1115A	20A 230V 4 POLES MINICONTACTOR KI	<table border="1"> <thead> <tr> <th>Code</th> <th>Description</th> <th>Qty</th> <th>UOM</th> </tr> </thead> <tbody> <tr> <td>VE1115A0</td> <td>20 A 230V 4 POLES MINICONTACTOR</td> <td>1</td> <td>PZ</td> </tr> <tr> <td>VM1075A1</td> <td>PLASTIC CLIP TO FIX CONTACTORS</td> <td>4</td> <td>PZ</td> </tr> <tr> <td>VM1224A0</td> <td>65MY 220MM 2 COLOURS SHRINK TUBE</td> <td>0.250</td> <td>M</td> </tr> </tbody> </table>	Code	Description	Qty	UOM	VE1115A0	20 A 230V 4 POLES MINICONTACTOR	1	PZ	VM1075A1	PLASTIC CLIP TO FIX CONTACTORS	4	PZ	VM1224A0	65MY 220MM 2 COLOURS SHRINK TUBE	0.250	M																
Code	Description	Qty	UOM																																		
VE1115A0	20 A 230V 4 POLES MINICONTACTOR	1	PZ																																		
VM1075A1	PLASTIC CLIP TO FIX CONTACTORS	4	PZ																																		
VM1224A0	65MY 220MM 2 COLOURS SHRINK TUBE	0.250	M																																		

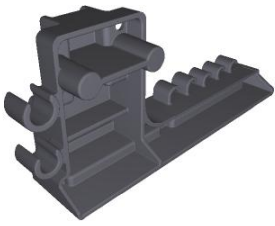
COMPONENT			SPARE PART																														
Code	Description	Image	Code	Description	Components list																												
VM1056A	SMALL CONTACTOR BRACKET VE1115A		VM1056A0	SMALL CONTACTOR BRACKET VE1115A																													
RC1006A	D8 PET PIPE GUIDE BEND		KRC1006A	20 PCS. Ø8 PET PIPE GUIDE BEND KI	<table border="1"> <thead> <tr> <th>Code</th> <th>Description</th> <th>Qty</th> <th>UOM</th> </tr> </thead> <tbody> <tr> <td>RC1006A0</td> <td>D8 PET PIPE GUIDE BEND</td> <td>20</td> <td>PZ</td> </tr> <tr> <td>VM1224A0</td> <td>65MY 220MM 2 COLOURS SHRINK TUBE</td> <td>0.200</td> <td>M</td> </tr> </tbody> </table>	Code	Description	Qty	UOM	RC1006A0	D8 PET PIPE GUIDE BEND	20	PZ	VM1224A0	65MY 220MM 2 COLOURS SHRINK TUBE	0.200	M																
Code	Description	Qty	UOM																														
RC1006A0	D8 PET PIPE GUIDE BEND	20	PZ																														
VM1224A0	65MY 220MM 2 COLOURS SHRINK TUBE	0.200	M																														
VM1187A	POWER BOARD FRAME SHOP.PRO		VM1187A0	POWER BOARD FRAME SHOP.PRO																													
PE2102A	BL LED/TOUCH/PLUS 230 V POWER CARD		KPE2102A	BL LED/TOUCH/MASTE R 230V POWER CARD KIT	<table border="1"> <thead> <tr> <th>Code</th> <th>Description</th> <th>Qty</th> <th>UOM</th> </tr> </thead> <tbody> <tr> <td>PE2102A0</td> <td>BL LED/TOUCH/P LUS 230V POWER BOARD KIT</td> <td>1</td> <td>PZ</td> </tr> <tr> <td>PE2102A1</td> <td>BL LED/TOUCH/P LUS 230 V POWER CARD</td> <td>1</td> <td>PZ</td> </tr> <tr> <td>PE2102A2</td> <td>BL LED/TOUCH/P LUS 230V POWER BOAR</td> <td>1</td> <td>PZ</td> </tr> <tr> <td>V11988A0</td> <td>AUTOTHREAD ING SCREW 4,2X19 TCB+ INOX</td> <td>3</td> <td>PZ</td> </tr> <tr> <td>VM1187A0</td> <td>POWER BOARD FRAME SHOP.PRO</td> <td>1</td> <td>PZ</td> </tr> <tr> <td>VM2147A0</td> <td>410X343X15 MM PINK SMOOTH ESD SPONGE</td> <td>1</td> <td>PZ</td> </tr> </tbody> </table>	Code	Description	Qty	UOM	PE2102A0	BL LED/TOUCH/P LUS 230V POWER BOARD KIT	1	PZ	PE2102A1	BL LED/TOUCH/P LUS 230 V POWER CARD	1	PZ	PE2102A2	BL LED/TOUCH/P LUS 230V POWER BOAR	1	PZ	V11988A0	AUTOTHREAD ING SCREW 4,2X19 TCB+ INOX	3	PZ	VM1187A0	POWER BOARD FRAME SHOP.PRO	1	PZ	VM2147A0	410X343X15 MM PINK SMOOTH ESD SPONGE	1	PZ
Code	Description	Qty	UOM																														
PE2102A0	BL LED/TOUCH/P LUS 230V POWER BOARD KIT	1	PZ																														
PE2102A1	BL LED/TOUCH/P LUS 230 V POWER CARD	1	PZ																														
PE2102A2	BL LED/TOUCH/P LUS 230V POWER BOAR	1	PZ																														
V11988A0	AUTOTHREAD ING SCREW 4,2X19 TCB+ INOX	3	PZ																														
VM1187A0	POWER BOARD FRAME SHOP.PRO	1	PZ																														
VM2147A0	410X343X15 MM PINK SMOOTH ESD SPONGE	1	PZ																														

COMPONENT			SPARE PART																		
Code	Description	Image	Code	Description	Components list																
CE1581A	CABLE H07RNF 3G1.5 L1.5MT+K1/6+SCHU KO		KCE1581A	H07RNF 3G1.5 L1.5 MT + SHUKO PLUG KIT	<table border="1"> <thead> <tr> <th>Code</th> <th>Description</th> <th>Qty</th> <th>UOM</th> </tr> </thead> <tbody> <tr> <td>CE1581A0</td> <td>CABLE H07RNF 3G1.5 L1.5MT+K1/6+ SCHUKO</td> <td>1</td> <td>PZ</td> </tr> <tr> <td>VM1224A0</td> <td>65MY 220MM 2 COLOURS SHRINK TUBE</td> <td>0.300</td> <td>M</td> </tr> </tbody> </table>	Code	Description	Qty	UOM	CE1581A0	CABLE H07RNF 3G1.5 L1.5MT+K1/6+ SCHUKO	1	PZ	VM1224A0	65MY 220MM 2 COLOURS SHRINK TUBE	0.300	M				
Code	Description	Qty	UOM																		
CE1581A0	CABLE H07RNF 3G1.5 L1.5MT+K1/6+ SCHUKO	1	PZ																		
VM1224A0	65MY 220MM 2 COLOURS SHRINK TUBE	0.300	M																		
MR1025A	3 POLES 450V 41A+GROUND TERMINAL BLOCK		KMR1025A	3 POLES TERMINAL BLOCK KIT	<table border="1"> <thead> <tr> <th>Code</th> <th>Description</th> <th>Qty</th> <th>UOM</th> </tr> </thead> <tbody> <tr> <td>MR1025A1</td> <td>3 POLES 450V 41A+GROUND TERMINAL BLOCK</td> <td>1</td> <td>PZ</td> </tr> <tr> <td>VM1224A0</td> <td>65MY 220MM 2 COLOURS SHRINK TUBE</td> <td>0.150</td> <td>M</td> </tr> </tbody> </table>	Code	Description	Qty	UOM	MR1025A1	3 POLES 450V 41A+GROUND TERMINAL BLOCK	1	PZ	VM1224A0	65MY 220MM 2 COLOURS SHRINK TUBE	0.150	M				
Code	Description	Qty	UOM																		
MR1025A1	3 POLES 450V 41A+GROUND TERMINAL BLOCK	1	PZ																		
VM1224A0	65MY 220MM 2 COLOURS SHRINK TUBE	0.150	M																		
VI1328A			VI1328A0																		
VM1188A	BL SHOP.PRO POWER BOARD WIRE PASSAGE		KVM1188A	BL SP POWER BOARD WIRE PASSAGE 10 PC KIT	<table border="1"> <thead> <tr> <th>Code</th> <th>Description</th> <th>Qty</th> <th>UOM</th> </tr> </thead> <tbody> <tr> <td>VM1188A0</td> <td>BL SHOP.PRO POWER BOARD WIRE PASSAGE</td> <td>10</td> <td>PZ</td> </tr> <tr> <td>VM1224A0</td> <td>65MY 220MM 2 COLOURS SHRINK TUBE</td> <td>0.200</td> <td>M</td> </tr> </tbody> </table>	Code	Description	Qty	UOM	VM1188A0	BL SHOP.PRO POWER BOARD WIRE PASSAGE	10	PZ	VM1224A0	65MY 220MM 2 COLOURS SHRINK TUBE	0.200	M				
Code	Description	Qty	UOM																		
VM1188A0	BL SHOP.PRO POWER BOARD WIRE PASSAGE	10	PZ																		
VM1224A0	65MY 220MM 2 COLOURS SHRINK TUBE	0.200	M																		
VM2484A	ELECTRICAL CONNECTION CABLE CLAMP		KVM2484A	CABLE LOCKS ELECTRICAL CONNECTION KIT	<table border="1"> <thead> <tr> <th>Code</th> <th>Description</th> <th>Qty</th> <th>UOM</th> </tr> </thead> <tbody> <tr> <td>VM1224A0</td> <td>65MY 220MM 2 COLOURS SHRINK TUBE</td> <td>0.300</td> <td>M</td> </tr> <tr> <td>VM2484A0</td> <td>ELECTRICAL CONNECTION CABLE CLAMP</td> <td>1</td> <td>PZ</td> </tr> <tr> <td>VM2484A0</td> <td>ELECTRICAL CONNECTION CABLE CLAMP</td> <td>1</td> <td>PZ</td> </tr> </tbody> </table>	Code	Description	Qty	UOM	VM1224A0	65MY 220MM 2 COLOURS SHRINK TUBE	0.300	M	VM2484A0	ELECTRICAL CONNECTION CABLE CLAMP	1	PZ	VM2484A0	ELECTRICAL CONNECTION CABLE CLAMP	1	PZ
Code	Description	Qty	UOM																		
VM1224A0	65MY 220MM 2 COLOURS SHRINK TUBE	0.300	M																		
VM2484A0	ELECTRICAL CONNECTION CABLE CLAMP	1	PZ																		
VM2484A0	ELECTRICAL CONNECTION CABLE CLAMP	1	PZ																		

COMPONENT			SPARE PART																										
Code	Description	Image	Code	Description	Components list																								
VM2484A	ELECTRICAL CONNECTION CABLE CLAMP		KVM2482A	BAKERLUX SP ELECTR COMPONENTS HOLDER KIT	<table border="1"> <thead> <tr> <th>Code</th> <th>Description</th> <th>Qty</th> <th>UOM</th> </tr> </thead> <tbody> <tr> <td>VM1224A0</td> <td>65MY 220MM 2 COLOURS SHRINK TUBE</td> <td>0.300</td> <td>M</td> </tr> <tr> <td>VM2482A0</td> <td>ELECTR COMPONENT S HOLDER FRAME SHOP.PRO</td> <td>1</td> <td>PZ</td> </tr> <tr> <td>VM2482A0</td> <td>ELECTR COMPONENT S HOLDER FRAME SHOP.PRO</td> <td>1</td> <td>PZ</td> </tr> <tr> <td>VM2484A0</td> <td>ELECTRICAL CONNECTION CABLE CLAMP</td> <td>1</td> <td>PZ</td> </tr> <tr> <td>VM2484A0</td> <td>ELECTRICAL CONNECTION CABLE CLAMP</td> <td>1</td> <td>PZ</td> </tr> </tbody> </table>	Code	Description	Qty	UOM	VM1224A0	65MY 220MM 2 COLOURS SHRINK TUBE	0.300	M	VM2482A0	ELECTR COMPONENT S HOLDER FRAME SHOP.PRO	1	PZ	VM2482A0	ELECTR COMPONENT S HOLDER FRAME SHOP.PRO	1	PZ	VM2484A0	ELECTRICAL CONNECTION CABLE CLAMP	1	PZ	VM2484A0	ELECTRICAL CONNECTION CABLE CLAMP	1	PZ
Code	Description	Qty	UOM																										
VM1224A0	65MY 220MM 2 COLOURS SHRINK TUBE	0.300	M																										
VM2482A0	ELECTR COMPONENT S HOLDER FRAME SHOP.PRO	1	PZ																										
VM2482A0	ELECTR COMPONENT S HOLDER FRAME SHOP.PRO	1	PZ																										
VM2484A0	ELECTRICAL CONNECTION CABLE CLAMP	1	PZ																										
VM2484A0	ELECTRICAL CONNECTION CABLE CLAMP	1	PZ																										
0P1022A	COMPONENTS HOLDING PANEL ELE-ROS SP		0P1022A0	COMPONENTS HOLDING PANEL ELE-ROS SP																									
TB3283A			KTB1959A	7,93X4,75 PE TRANSPARENT PIPE 5M KIT	<table border="1"> <thead> <tr> <th>Code</th> <th>Description</th> <th>Qty</th> <th>UOM</th> </tr> </thead> <tbody> <tr> <td>TB1815A0</td> <td>7,93X4,75 PE (JG #PE08100N)</td> <td>5</td> <td>M</td> </tr> </tbody> </table>	Code	Description	Qty	UOM	TB1815A0	7,93X4,75 PE (JG #PE08100N)	5	M																
Code	Description	Qty	UOM																										
TB1815A0	7,93X4,75 PE (JG #PE08100N)	5	M																										
VM2482A	ELECTR COMPONENTS HOLDER FRAME SHOP.PRO		KVM2482A	BAKERLUX SP ELECTR COMPONENTS HOLDER KIT	<table border="1"> <thead> <tr> <th>Code</th> <th>Description</th> <th>Qty</th> <th>UOM</th> </tr> </thead> <tbody> <tr> <td>VM1224A0</td> <td>65MY 220MM 2 COLOURS SHRINK TUBE</td> <td>0.300</td> <td>M</td> </tr> <tr> <td>VM2482A0</td> <td>ELECTR COMPONENT S HOLDER FRAME SHOP.PRO</td> <td>1</td> <td>PZ</td> </tr> <tr> <td>VM2482A0</td> <td>ELECTR COMPONENT S HOLDER FRAME SHOP.PRO</td> <td>1</td> <td>PZ</td> </tr> </tbody> </table>	Code	Description	Qty	UOM	VM1224A0	65MY 220MM 2 COLOURS SHRINK TUBE	0.300	M	VM2482A0	ELECTR COMPONENT S HOLDER FRAME SHOP.PRO	1	PZ	VM2482A0	ELECTR COMPONENT S HOLDER FRAME SHOP.PRO	1	PZ								
Code	Description	Qty	UOM																										
VM1224A0	65MY 220MM 2 COLOURS SHRINK TUBE	0.300	M																										
VM2482A0	ELECTR COMPONENT S HOLDER FRAME SHOP.PRO	1	PZ																										
VM2482A0	ELECTR COMPONENT S HOLDER FRAME SHOP.PRO	1	PZ																										

COMPONENT			SPARE PART																						
Code	Description	Image	Code	Description	Components list																				
VM2482A	ELECTR COMPONENTS HOLDER FRAME SHOP.PRO		KVM2482A	BAKERLUX SP ELECTR COMPONENTS HOLDER KIT	<table border="1"> <thead> <tr> <th>Code</th> <th>Description</th> <th>Qty</th> <th>UOM</th> </tr> </thead> <tbody> <tr> <td>VM2484A0</td> <td>ELECTRICAL CONNECTION CABLE CLAMP</td> <td>1</td> <td>PZ</td> </tr> <tr> <td>VM2484A0</td> <td>ELECTRICAL CONNECTION CABLE CLAMP</td> <td>1</td> <td>PZ</td> </tr> </tbody> </table>	Code	Description	Qty	UOM	VM2484A0	ELECTRICAL CONNECTION CABLE CLAMP	1	PZ	VM2484A0	ELECTRICAL CONNECTION CABLE CLAMP	1	PZ								
Code	Description	Qty	UOM																						
VM2484A0	ELECTRICAL CONNECTION CABLE CLAMP	1	PZ																						
VM2484A0	ELECTRICAL CONNECTION CABLE CLAMP	1	PZ																						
VM2483A	SHOP PRO COMPONENTS HOLDER COVER		KVM2483A	BL SHOP.PRO COMPONENTS HOLDER COVER KIT	<table border="1"> <thead> <tr> <th>Code</th> <th>Description</th> <th>Qty</th> <th>UOM</th> </tr> </thead> <tbody> <tr> <td>VM1224A0</td> <td>65MY 220MM 2 COLOURS SHRINK TUBE</td> <td>0.300</td> <td>M</td> </tr> <tr> <td>VM2483A0</td> <td>COMPONENT S HOLDER COVER SHOP.PRO</td> <td>1</td> <td>PZ</td> </tr> <tr> <td>VM2483A0</td> <td>COMPONENT S HOLDER COVER SHOP.PRO</td> <td>1</td> <td>PZ</td> </tr> <tr> <td>VM2483A1</td> <td>SHOP PRO COMPONENT S HOLDER COVER</td> <td>1</td> <td>PZ</td> </tr> </tbody> </table>	Code	Description	Qty	UOM	VM1224A0	65MY 220MM 2 COLOURS SHRINK TUBE	0.300	M	VM2483A0	COMPONENT S HOLDER COVER SHOP.PRO	1	PZ	VM2483A0	COMPONENT S HOLDER COVER SHOP.PRO	1	PZ	VM2483A1	SHOP PRO COMPONENT S HOLDER COVER	1	PZ
Code	Description	Qty	UOM																						
VM1224A0	65MY 220MM 2 COLOURS SHRINK TUBE	0.300	M																						
VM2483A0	COMPONENT S HOLDER COVER SHOP.PRO	1	PZ																						
VM2483A0	COMPONENT S HOLDER COVER SHOP.PRO	1	PZ																						
VM2483A1	SHOP PRO COMPONENT S HOLDER COVER	1	PZ																						
RC1365A	3/4"-10 JG FEMALE CONNECTION		KRC1365A	3/4"-10 OR 8 JG WATER CONNECTION KIT	<table border="1"> <thead> <tr> <th>Code</th> <th>Description</th> <th>Qty</th> <th>UOM</th> </tr> </thead> <tbody> <tr> <td>GN1200A1</td> <td>3/4 CONNECTION SEAL D=24 RUBBER+NET</td> <td>1</td> <td>PZ</td> </tr> <tr> <td>RC1002A0</td> <td>JG 10M-8F TERMINAL REDUCTION FITTING</td> <td>1</td> <td>PZ</td> </tr> <tr> <td>RC1365A0</td> <td>3/4"-10 JG FEMALE CONNECTION</td> <td>1</td> <td>PZ</td> </tr> <tr> <td>VM1224A0</td> <td>65MY 220MM 2 COLOURS SHRINK TUBE</td> <td>0.150</td> <td>M</td> </tr> </tbody> </table>	Code	Description	Qty	UOM	GN1200A1	3/4 CONNECTION SEAL D=24 RUBBER+NET	1	PZ	RC1002A0	JG 10M-8F TERMINAL REDUCTION FITTING	1	PZ	RC1365A0	3/4"-10 JG FEMALE CONNECTION	1	PZ	VM1224A0	65MY 220MM 2 COLOURS SHRINK TUBE	0.150	M
Code	Description	Qty	UOM																						
GN1200A1	3/4 CONNECTION SEAL D=24 RUBBER+NET	1	PZ																						
RC1002A0	JG 10M-8F TERMINAL REDUCTION FITTING	1	PZ																						
RC1365A0	3/4"-10 JG FEMALE CONNECTION	1	PZ																						
VM1224A0	65MY 220MM 2 COLOURS SHRINK TUBE	0.150	M																						
RC1002A	JG 10M-8F TERMINAL REDUCTION FITTIN		KRC1002A	JG Ø10M-Ø8F REDUCING SPIGOT 10 PCS KIT	<table border="1"> <thead> <tr> <th>Code</th> <th>Description</th> <th>Qty</th> <th>UOM</th> </tr> </thead> <tbody> <tr> <td>RC1002A0</td> <td>JG 10M-8F TERMINAL REDUCTION FITTING</td> <td>10</td> <td>PZ</td> </tr> <tr> <td>VM1224A0</td> <td>65MY 220MM 2 COLOURS SHRINK TUBE</td> <td>0.200</td> <td>M</td> </tr> </tbody> </table>	Code	Description	Qty	UOM	RC1002A0	JG 10M-8F TERMINAL REDUCTION FITTING	10	PZ	VM1224A0	65MY 220MM 2 COLOURS SHRINK TUBE	0.200	M								
Code	Description	Qty	UOM																						
RC1002A0	JG 10M-8F TERMINAL REDUCTION FITTING	10	PZ																						
VM1224A0	65MY 220MM 2 COLOURS SHRINK TUBE	0.200	M																						

ASM3403A/0.D00 - Cooking chamber

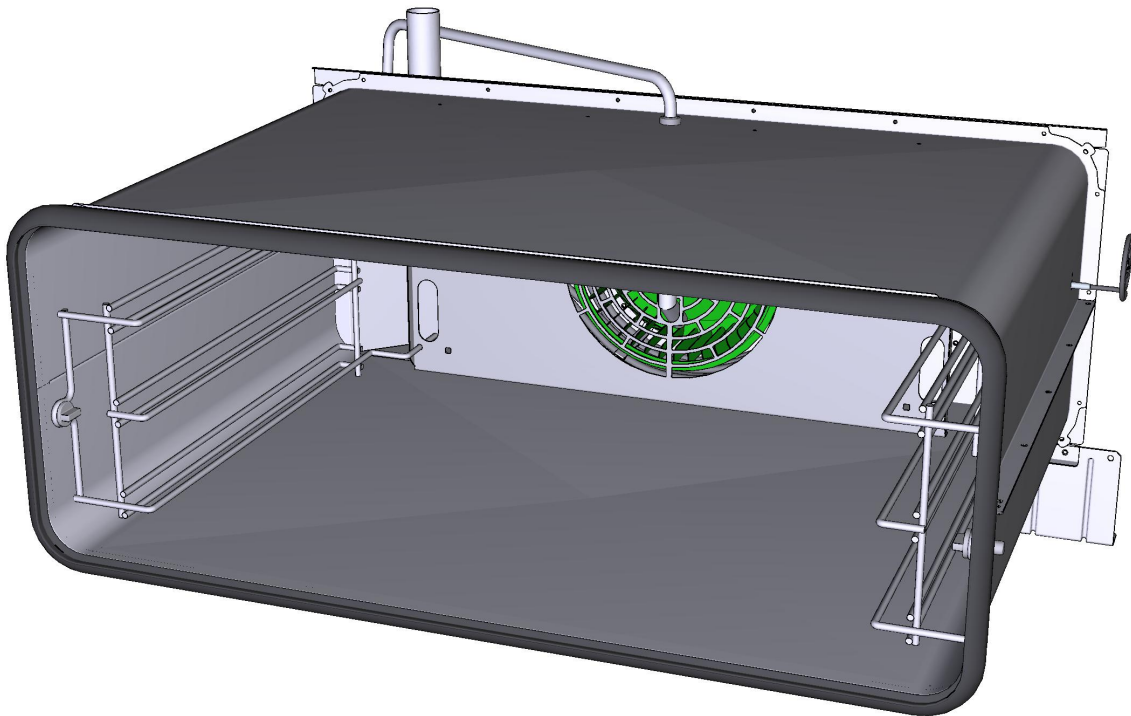

FRONT





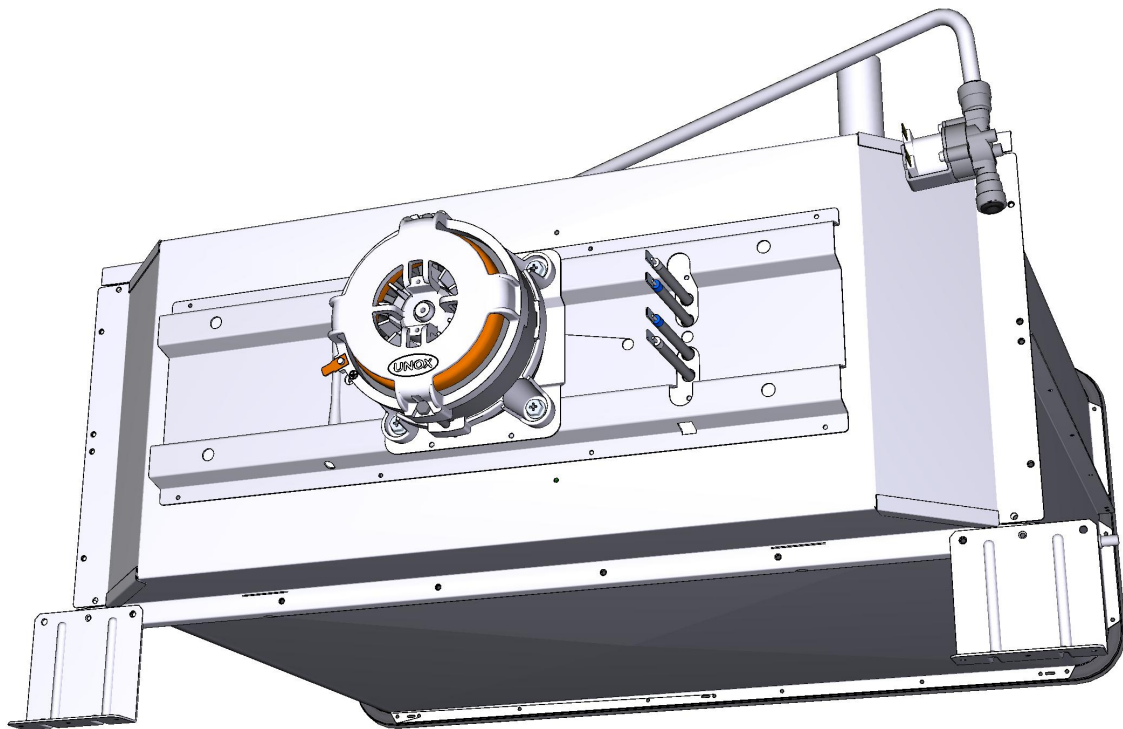

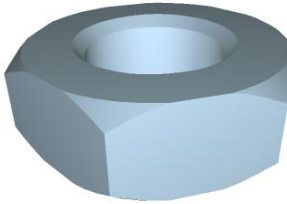
ASM3403A/0.D00 - Cooking chamber



REAR



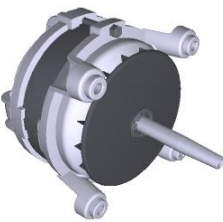

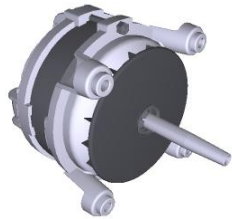
COMPONENT			SPARE PART																																														
Code	Description	Image	Code	Description	Components list																																												
TR1105A	L1000 PT100 TEMPERATURE PROBE		KTR1105A	PT100 L1000 TEMPERATURE PROBE KIT	<table border="1"> <thead> <tr> <th>Code</th> <th>Description</th> <th>Qty</th> <th>UOM</th> </tr> </thead> <tbody> <tr> <td>GN1120A0</td> <td>NTC TEMPERATUR E PROBE SEAL</td> <td>1</td> <td>PZ</td> </tr> <tr> <td>GN1120A1</td> <td>NTC TEMPERATUR E PROBE SEAL</td> <td>1</td> <td>PZ</td> </tr> <tr> <td>GN1285A0</td> <td>NTC TEMPERATUR E PROBE SEALING</td> <td>1</td> <td>PZ</td> </tr> <tr> <td>MOV0010A0</td> <td>HOOD RING GASKET GN1110A2</td> <td>0.100</td> <td>PZ</td> </tr> <tr> <td>SL1045A0</td> <td>S57 BLACK SILICONE - 80ML CARTRIDGE</td> <td>1</td> <td>PZ</td> </tr> <tr> <td>TR1105A4</td> <td>L1000 PT100 TEMPERATUR E PROBE</td> <td>1</td> <td>PZ</td> </tr> <tr> <td>VI1220A1</td> <td>4,2X12 TCB SELF-TAPPIN G SCREW</td> <td>2</td> <td>PZ</td> </tr> <tr> <td>VM1464A1</td> <td>CT BT TEMPERATUR E PROBE COVER</td> <td>1</td> <td>PZ</td> </tr> <tr> <td>VM1465A1</td> <td>CT BT TEMPERATUR E PROBE COVER</td> <td>1</td> <td>PZ</td> </tr> <tr> <td>VM2052A0</td> <td>LM CORE PROBE COVE</td> <td>1</td> <td>PZ</td> </tr> </tbody> </table>	Code	Description	Qty	UOM	GN1120A0	NTC TEMPERATUR E PROBE SEAL	1	PZ	GN1120A1	NTC TEMPERATUR E PROBE SEAL	1	PZ	GN1285A0	NTC TEMPERATUR E PROBE SEALING	1	PZ	MOV0010A0	HOOD RING GASKET GN1110A2	0.100	PZ	SL1045A0	S57 BLACK SILICONE - 80ML CARTRIDGE	1	PZ	TR1105A4	L1000 PT100 TEMPERATUR E PROBE	1	PZ	VI1220A1	4,2X12 TCB SELF-TAPPIN G SCREW	2	PZ	VM1464A1	CT BT TEMPERATUR E PROBE COVER	1	PZ	VM1465A1	CT BT TEMPERATUR E PROBE COVER	1	PZ	VM2052A0	LM CORE PROBE COVE	1	PZ
Code	Description	Qty	UOM																																														
GN1120A0	NTC TEMPERATUR E PROBE SEAL	1	PZ																																														
GN1120A1	NTC TEMPERATUR E PROBE SEAL	1	PZ																																														
GN1285A0	NTC TEMPERATUR E PROBE SEALING	1	PZ																																														
MOV0010A0	HOOD RING GASKET GN1110A2	0.100	PZ																																														
SL1045A0	S57 BLACK SILICONE - 80ML CARTRIDGE	1	PZ																																														
TR1105A4	L1000 PT100 TEMPERATUR E PROBE	1	PZ																																														
VI1220A1	4,2X12 TCB SELF-TAPPIN G SCREW	2	PZ																																														
VM1464A1	CT BT TEMPERATUR E PROBE COVER	1	PZ																																														
VM1465A1	CT BT TEMPERATUR E PROBE COVER	1	PZ																																														
VM2052A0	LM CORE PROBE COVE	1	PZ																																														
RC1170A	STAINLESS STEEL NUT M14 H=8 CH=22		KRC1170A	M14 H8 CH22 NUT - 10 PCS. KIT	<table border="1"> <thead> <tr> <th>Code</th> <th>Description</th> <th>Qty</th> <th>UOM</th> </tr> </thead> <tbody> <tr> <td>RC1170A1</td> <td>STAINLESS STEEL NUT M14 H=8 CH=2</td> <td>10</td> <td>PZ</td> </tr> <tr> <td>VM1224A0</td> <td>65MY 220MM 2 COLOURS SHRINK TUBE</td> <td>0.200</td> <td>M</td> </tr> </tbody> </table>	Code	Description	Qty	UOM	RC1170A1	STAINLESS STEEL NUT M14 H=8 CH=2	10	PZ	VM1224A0	65MY 220MM 2 COLOURS SHRINK TUBE	0.200	M																																
Code	Description	Qty	UOM																																														
RC1170A1	STAINLESS STEEL NUT M14 H=8 CH=2	10	PZ																																														
VM1224A0	65MY 220MM 2 COLOURS SHRINK TUBE	0.200	M																																														
VM2331A	FAN GUARD-TRAYS HOLDER PIN		KVM2331A	KIT FAN GUARD-TRAYS HOLDER PIN	<table border="1"> <thead> <tr> <th>Code</th> <th>Description</th> <th>Qty</th> <th>UOM</th> </tr> </thead> <tbody> <tr> <td>VM1224A0</td> <td>65MY 220MM 2 COLOURS SHRINK TUBE</td> <td>0.200</td> <td>M</td> </tr> <tr> <td>VM2331A0</td> <td>FAN GUARD-TRAY S HOLDER PIN</td> <td>4</td> <td>PZ</td> </tr> </tbody> </table>	Code	Description	Qty	UOM	VM1224A0	65MY 220MM 2 COLOURS SHRINK TUBE	0.200	M	VM2331A0	FAN GUARD-TRAY S HOLDER PIN	4	PZ																																
Code	Description	Qty	UOM																																														
VM1224A0	65MY 220MM 2 COLOURS SHRINK TUBE	0.200	M																																														
VM2331A0	FAN GUARD-TRAY S HOLDER PIN	4	PZ																																														

COMPONENT			SPARE PART																						
Code	Description	Image	Code	Description	Components list																				
0H7875A	MUFFLE SUPPORT BRACKET SHOP.PR		0H7875A0	MUFFLE SUPPORT BRACKET SHOP.PR																					
EL1251A	1-WAY WATER SOLENOID VALVE		KEL1251A	JG D8-D10 1 WAY SOLENOID VALVE KI	<table border="1"> <thead> <tr> <th>Code</th> <th>Description</th> <th>Qty</th> <th>UOM</th> </tr> </thead> <tbody> <tr> <td>EL1251A0</td> <td>1-WAY WATER SOLENOID VALVE</td> <td>1</td> <td>PZ</td> </tr> <tr> <td>VM1224A0</td> <td>65MY 220MM 2 COLOURS SHRINK TUBE</td> <td>0.250</td> <td>M</td> </tr> </tbody> </table>	Code	Description	Qty	UOM	EL1251A0	1-WAY WATER SOLENOID VALVE	1	PZ	VM1224A0	65MY 220MM 2 COLOURS SHRINK TUBE	0.250	M								
Code	Description	Qty	UOM																						
EL1251A0	1-WAY WATER SOLENOID VALVE	1	PZ																						
VM1224A0	65MY 220MM 2 COLOURS SHRINK TUBE	0.250	M																						
TB1574A	FUME CHIMNEY D30 SHOP PRO		TB1574A0	FUME CHIMNEY D30 SHOP PRO																					
0H3020A	MOTOR SHAFT SEALING DISC		0H3020A1	MOTOR SHAFT SEALING DISC																					
MT1012A	330W 230V MOTOR		KVN1130A	LUX =08.2017/S.5/S.5E 330W MOTOR KIT	<table border="1"> <thead> <tr> <th>Code</th> <th>Description</th> <th>Qty</th> <th>UOM</th> </tr> </thead> <tbody> <tr> <td>0H4305A1</td> <td>ST. STEEL MOTOR SHAFT SEALING DISC</td> <td>1</td> <td>PZ</td> </tr> <tr> <td>GN1140A2</td> <td>MOTOR HOLDER GASKET</td> <td>1</td> <td>PZ</td> </tr> <tr> <td>GN1140A3</td> <td>MOLDED MOTOR HOLDER GASKET</td> <td>1</td> <td>PZ</td> </tr> <tr> <td>VI1045A0</td> <td>16X8,4 TH=1,6 ST.STEEL WASHER</td> <td>1</td> <td>PZ</td> </tr> </tbody> </table>	Code	Description	Qty	UOM	0H4305A1	ST. STEEL MOTOR SHAFT SEALING DISC	1	PZ	GN1140A2	MOTOR HOLDER GASKET	1	PZ	GN1140A3	MOLDED MOTOR HOLDER GASKET	1	PZ	VI1045A0	16X8,4 TH=1,6 ST.STEEL WASHER	1	PZ
Code	Description	Qty	UOM																						
0H4305A1	ST. STEEL MOTOR SHAFT SEALING DISC	1	PZ																						
GN1140A2	MOTOR HOLDER GASKET	1	PZ																						
GN1140A3	MOLDED MOTOR HOLDER GASKET	1	PZ																						
VI1045A0	16X8,4 TH=1,6 ST.STEEL WASHER	1	PZ																						

COMPONENT			SPARE PART																																																							
Code	Description	Image	Code	Description	Components list																																																					
MT1012A	330W 230V MOTOR		KVN1130A	LUX =08.2017/S.5/S.5E 330W MOTOR KIT	<table border="1"> <thead> <tr> <th>Code</th> <th>Description</th> <th>Qty</th> <th>UOM</th> </tr> </thead> <tbody> <tr> <td>VI1256A0</td> <td>M8 DIN 980M ST. STEEL SELF LOCKING NUT</td> <td>1</td> <td>PZ</td> </tr> <tr> <td>VM1794A0</td> <td>250X4.8 PA66 BLACK CLAMP</td> <td>4</td> <td>PZ</td> </tr> <tr> <td>VM2103A0</td> <td>CLAMP LOCK</td> <td>4</td> <td>PZ</td> </tr> <tr> <td>VM2196A0</td> <td>MOTOR NUT FASTENING BUSHING</td> <td>1</td> <td>PZ</td> </tr> <tr> <td>VN1130A1</td> <td>330W 230V 50/60HZ MOTO</td> <td>1</td> <td>PZ</td> </tr> <tr> <td>VN1130A1</td> <td>330W 230V 50/60HZ MOTO</td> <td>1</td> <td>PZ</td> </tr> </tbody> </table>	Code	Description	Qty	UOM	VI1256A0	M8 DIN 980M ST. STEEL SELF LOCKING NUT	1	PZ	VM1794A0	250X4.8 PA66 BLACK CLAMP	4	PZ	VM2103A0	CLAMP LOCK	4	PZ	VM2196A0	MOTOR NUT FASTENING BUSHING	1	PZ	VN1130A1	330W 230V 50/60HZ MOTO	1	PZ	VN1130A1	330W 230V 50/60HZ MOTO	1	PZ																									
			Code	Description	Qty	UOM																																																				
VI1256A0	M8 DIN 980M ST. STEEL SELF LOCKING NUT	1	PZ																																																							
VM1794A0	250X4.8 PA66 BLACK CLAMP	4	PZ																																																							
VM2103A0	CLAMP LOCK	4	PZ																																																							
VM2196A0	MOTOR NUT FASTENING BUSHING	1	PZ																																																							
VN1130A1	330W 230V 50/60HZ MOTO	1	PZ																																																							
VN1130A1	330W 230V 50/60HZ MOTO	1	PZ																																																							
KMT1012A	MIND.MAPS 330W 230V MOTOR KIT	<table border="1"> <thead> <tr> <th>Code</th> <th>Description</th> <th>Qty</th> <th>UOM</th> </tr> </thead> <tbody> <tr> <td>0H2842A0</td> <td></td> <td>1</td> <td>PZ</td> </tr> <tr> <td>0H4305A1</td> <td>ST. STEEL MOTOR SHAFT SEALING DISC</td> <td>1</td> <td>PZ</td> </tr> <tr> <td>GN1140A2</td> <td>MOTOR HOLDER GASKET</td> <td>1</td> <td>PZ</td> </tr> <tr> <td>GN1140A3</td> <td>MOLDED MOTOR HOLDER GASKET</td> <td>1</td> <td>PZ</td> </tr> <tr> <td>MOV0007A0</td> <td>HOOD RING GASKET GN1110A2</td> <td>0.100</td> <td>PZ</td> </tr> <tr> <td>MT1012A0</td> <td>330W 230V MOTOR</td> <td>1</td> <td>PZ</td> </tr> <tr> <td>VE1550A0</td> <td>5X3 MM NEODYMIUM MAGNET</td> <td>1</td> <td>PZ</td> </tr> <tr> <td>VI1077A1</td> <td>SCREW M6X12 TE INOX</td> <td>1</td> <td>PZ</td> </tr> <tr> <td>VI1521A0</td> <td>STAINLESS STEEL WASHER D=6 6592</td> <td>1</td> <td>PZ</td> </tr> <tr> <td>VI1966A0</td> <td>M4X14 FLATHEAD SCREW</td> <td>1</td> <td>PZ</td> </tr> <tr> <td>VM1635A0</td> <td>MAGNET HOLDING DIS</td> <td>1</td> <td>PZ</td> </tr> <tr> <td>VM1794A0</td> <td>250X4.8 PA66 BLACK CLAMP</td> <td>4</td> <td>PZ</td> </tr> <tr> <td>VM2103A0</td> <td>CLAMP LOCK</td> <td>4</td> <td>PZ</td> </tr> </tbody> </table>	Code	Description	Qty	UOM	0H2842A0		1	PZ	0H4305A1	ST. STEEL MOTOR SHAFT SEALING DISC	1	PZ	GN1140A2	MOTOR HOLDER GASKET	1	PZ	GN1140A3	MOLDED MOTOR HOLDER GASKET	1	PZ	MOV0007A0	HOOD RING GASKET GN1110A2	0.100	PZ	MT1012A0	330W 230V MOTOR	1	PZ	VE1550A0	5X3 MM NEODYMIUM MAGNET	1	PZ	VI1077A1	SCREW M6X12 TE INOX	1	PZ	VI1521A0	STAINLESS STEEL WASHER D=6 6592	1	PZ	VI1966A0	M4X14 FLATHEAD SCREW	1	PZ	VM1635A0	MAGNET HOLDING DIS	1	PZ	VM1794A0	250X4.8 PA66 BLACK CLAMP	4	PZ	VM2103A0	CLAMP LOCK	4	PZ
Code	Description	Qty	UOM																																																							
0H2842A0		1	PZ																																																							
0H4305A1	ST. STEEL MOTOR SHAFT SEALING DISC	1	PZ																																																							
GN1140A2	MOTOR HOLDER GASKET	1	PZ																																																							
GN1140A3	MOLDED MOTOR HOLDER GASKET	1	PZ																																																							
MOV0007A0	HOOD RING GASKET GN1110A2	0.100	PZ																																																							
MT1012A0	330W 230V MOTOR	1	PZ																																																							
VE1550A0	5X3 MM NEODYMIUM MAGNET	1	PZ																																																							
VI1077A1	SCREW M6X12 TE INOX	1	PZ																																																							
VI1521A0	STAINLESS STEEL WASHER D=6 6592	1	PZ																																																							
VI1966A0	M4X14 FLATHEAD SCREW	1	PZ																																																							
VM1635A0	MAGNET HOLDING DIS	1	PZ																																																							
VM1794A0	250X4.8 PA66 BLACK CLAMP	4	PZ																																																							
VM2103A0	CLAMP LOCK	4	PZ																																																							

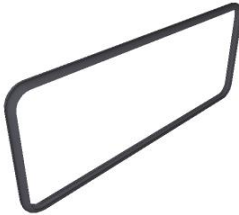
COMPONENT			SPARE PART																						
Code	Description	Image	Code	Description	Components list																				
GN1547A	SHAFT GASKET D11.8		KG1547A	D11.6 MOTOR SHAFT GASKET 3PCS KIT	<table border="1"> <thead> <tr> <th>Code</th> <th>Description</th> <th>Qty</th> <th>UOM</th> </tr> </thead> <tbody> <tr> <td>GN1547A1</td> <td>SHAFT GASKET D11.8</td> <td>3</td> <td>PZ</td> </tr> <tr> <td>VM1224A0</td> <td>65MY 220MM 2 COLOURS SHRINK TUBE</td> <td>0.200</td> <td>M</td> </tr> </tbody> </table>	Code	Description	Qty	UOM	GN1547A1	SHAFT GASKET D11.8	3	PZ	VM1224A0	65MY 220MM 2 COLOURS SHRINK TUBE	0.200	M								
Code	Description	Qty	UOM																						
GN1547A1	SHAFT GASKET D11.8	3	PZ																						
VM1224A0	65MY 220MM 2 COLOURS SHRINK TUBE	0.200	M																						
VN1181A	M6 NUT 39 BLADES H81 D196 FAN		KVN1181A	D196 H81 39 BLADES FAN+SCREW M6 KIT	<table border="1"> <thead> <tr> <th>Code</th> <th>Description</th> <th>Qty</th> <th>UOM</th> </tr> </thead> <tbody> <tr> <td>V11077A1</td> <td>SCREW M6X12 TE INOX</td> <td>1</td> <td>PZ</td> </tr> <tr> <td>V11521A0</td> <td>STAINLESS STEEL WASHER D=6 6592</td> <td>1</td> <td>PZ</td> </tr> <tr> <td>VN1181A0</td> <td>M6 NUT 39 BLADES H81 D196 FAN</td> <td>1</td> <td>PZ</td> </tr> <tr> <td>VN1181A0</td> <td>M6 NUT 39 BLADES H81 D196 FAN</td> <td>1</td> <td>PZ</td> </tr> </tbody> </table>	Code	Description	Qty	UOM	V11077A1	SCREW M6X12 TE INOX	1	PZ	V11521A0	STAINLESS STEEL WASHER D=6 6592	1	PZ	VN1181A0	M6 NUT 39 BLADES H81 D196 FAN	1	PZ	VN1181A0	M6 NUT 39 BLADES H81 D196 FAN	1	PZ
Code	Description	Qty	UOM																						
V11077A1	SCREW M6X12 TE INOX	1	PZ																						
V11521A0	STAINLESS STEEL WASHER D=6 6592	1	PZ																						
VN1181A0	M6 NUT 39 BLADES H81 D196 FAN	1	PZ																						
VN1181A0	M6 NUT 39 BLADES H81 D196 FAN	1	PZ																						
			KVN1030A	LUX =08.2017S.5/S.5E D196 FAN KIT	<table border="1"> <thead> <tr> <th>Code</th> <th>Description</th> <th>Qty</th> <th>UOM</th> </tr> </thead> <tbody> <tr> <td>V11256A0</td> <td>M8 DIN 980M ST. STEEL SELF LOCKING NUT</td> <td>1</td> <td>PZ</td> </tr> <tr> <td>VM2196A0</td> <td>MOTOR NUT FASTENING BUSHING</td> <td>1</td> <td>PZ</td> </tr> <tr> <td>VN1030A5</td> <td>Ø196 H81 38 BLADES MOTOR FAN</td> <td>1</td> <td>PZ</td> </tr> <tr> <td>VN1030A5</td> <td>Ø196 H81 38 BLADES MOTOR FAN</td> <td>1</td> <td>PZ</td> </tr> </tbody> </table>	Code	Description	Qty	UOM	V11256A0	M8 DIN 980M ST. STEEL SELF LOCKING NUT	1	PZ	VM2196A0	MOTOR NUT FASTENING BUSHING	1	PZ	VN1030A5	Ø196 H81 38 BLADES MOTOR FAN	1	PZ	VN1030A5	Ø196 H81 38 BLADES MOTOR FAN	1	PZ
Code	Description	Qty	UOM																						
V11256A0	M8 DIN 980M ST. STEEL SELF LOCKING NUT	1	PZ																						
VM2196A0	MOTOR NUT FASTENING BUSHING	1	PZ																						
VN1030A5	Ø196 H81 38 BLADES MOTOR FAN	1	PZ																						
VN1030A5	Ø196 H81 38 BLADES MOTOR FAN	1	PZ																						
0H7170A	MM MOTOR GLASS WOOL PLATE		0H7170A0	MM MOTOR GLASS WOOL PLATE																					

COMPONENT			SPARE PART																														
Code	Description	Image	Code	Description	Components list																												
RS1284A	3200W 230V+400W 190V 4TURNS H80 ELEMENT		KRS1284A	4TURN 3200W 230V+400W 190V HEAT ELEM KIT	<table border="1"> <thead> <tr> <th>Code</th> <th>Description</th> <th>Qty</th> <th>UOM</th> </tr> </thead> <tbody> <tr> <td>GN1327A0</td> <td>HEATING ELEMENT GASKET</td> <td>1</td> <td>PZ</td> </tr> <tr> <td>RS1284A0</td> <td>3200W 230V+400W 190V 4TURNS H80 ELEMENT</td> <td>1</td> <td>PZ</td> </tr> <tr> <td>SL1045A0</td> <td>S57 BLACK SILICONE - 80ML CARTRIDGE</td> <td>1</td> <td>PZ</td> </tr> <tr> <td>VI1220A1</td> <td>4,2X12 TCB SELF-TAPPIN G SCREW</td> <td>1</td> <td>PZ</td> </tr> <tr> <td>VM1794A0</td> <td>250X4.8 PA66 BLACK CLAMP</td> <td>2</td> <td>PZ</td> </tr> <tr> <td>VM2103A0</td> <td>CLAMP LOCK</td> <td>2</td> <td>PZ</td> </tr> </tbody> </table>	Code	Description	Qty	UOM	GN1327A0	HEATING ELEMENT GASKET	1	PZ	RS1284A0	3200W 230V+400W 190V 4TURNS H80 ELEMENT	1	PZ	SL1045A0	S57 BLACK SILICONE - 80ML CARTRIDGE	1	PZ	VI1220A1	4,2X12 TCB SELF-TAPPIN G SCREW	1	PZ	VM1794A0	250X4.8 PA66 BLACK CLAMP	2	PZ	VM2103A0	CLAMP LOCK	2	PZ
Code	Description	Qty	UOM																														
GN1327A0	HEATING ELEMENT GASKET	1	PZ																														
RS1284A0	3200W 230V+400W 190V 4TURNS H80 ELEMENT	1	PZ																														
SL1045A0	S57 BLACK SILICONE - 80ML CARTRIDGE	1	PZ																														
VI1220A1	4,2X12 TCB SELF-TAPPIN G SCREW	1	PZ																														
VM1794A0	250X4.8 PA66 BLACK CLAMP	2	PZ																														
VM2103A0	CLAMP LOCK	2	PZ																														
GN1597A			KG1597A	BL SHOP.PRO ELENA DOOR GASKET KIT	<table border="1"> <thead> <tr> <th>Code</th> <th>Description</th> <th>Qty</th> <th>UOM</th> </tr> </thead> <tbody> <tr> <td>GN1110A2</td> <td>LINE MISS/XVC105- 055/XK/XL DOOR GASKE</td> <td>1.870</td> <td>M</td> </tr> <tr> <td>VM1224A0</td> <td>65MY 220MM 2 COLOURS SHRINK TUBE</td> <td>0.350</td> <td>M</td> </tr> </tbody> </table>	Code	Description	Qty	UOM	GN1110A2	LINE MISS/XVC105- 055/XK/XL DOOR GASKE	1.870	M	VM1224A0	65MY 220MM 2 COLOURS SHRINK TUBE	0.350	M																
Code	Description	Qty	UOM																														
GN1110A2	LINE MISS/XVC105- 055/XK/XL DOOR GASKE	1.870	M																														
VM1224A0	65MY 220MM 2 COLOURS SHRINK TUBE	0.350	M																														
0G1653A	ELENA SHOP PRO FAN GUARD		0G1653A0	ELENA SHOP PRO FAN GUARD																													
TB1579A	ELENA SHOP PRO INTERNAL HUMIDITY PIPE		TB1579A0	ELENA SHOP PRO INTERNAL HUMIDITY PIPE																													



COMPONENT			SPARE PART		
<i>Code</i>	<i>Description</i>	<i>Image</i>	<i>Code</i>	<i>Description</i>	<i>Components list</i>
TB1638A	ELE-VIT-CAM SP WELDED EXT HUMIDITY PIPE		TB1638A0	ELE-VIT-CAM SP WELDED EXT HUMIDITY PIPE	

ASM3421A/0.D00 - Door



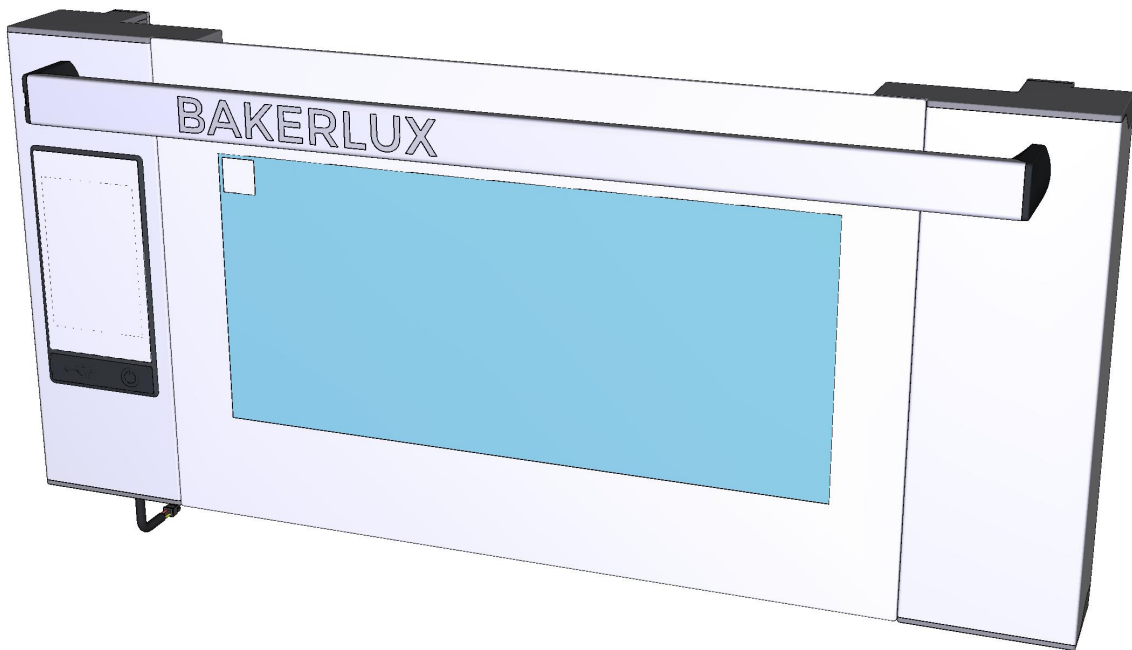

FRONT



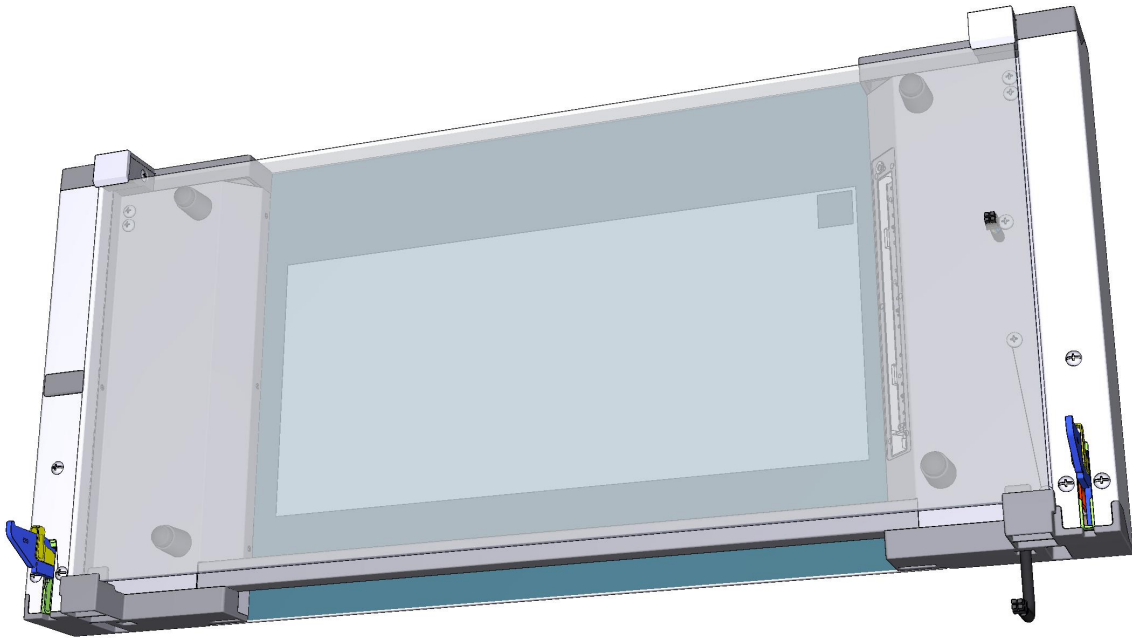

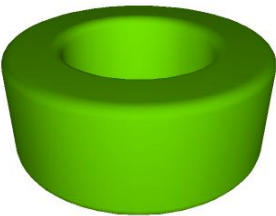
ASM3421A/0.D00 - Door

REAR



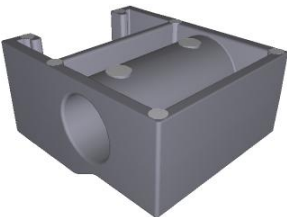
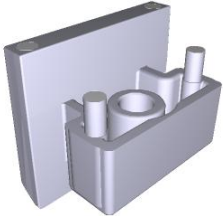

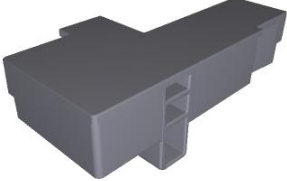

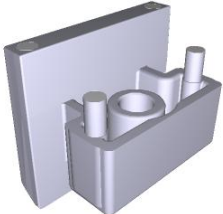
COMPONENT			SPARE PART																										
Code	Description	Image	Code	Description	Components list																								
CE1285A	EMI ROUND FERRITE MOD.2643801502		CE1285A0	EMI ROUND FERRITE MOD.2643801502																									
LP1050A	BL SHOP.PRO L180 COMPLETE LED BA		KLP1050A	BAKERLUX SHOP.PRO L180 LED BAR KIT	<table border="1"> <thead> <tr> <th>Code</th> <th>Description</th> <th>Qty</th> <th>UOM</th> </tr> </thead> <tbody> <tr> <td>IP1385A1</td> <td>CORNER POLYSTYREN E PACKING 110X80X2000</td> <td>0.300</td> <td>M</td> </tr> <tr> <td>LP1050A0</td> <td>BL SHOP.PRO L180 COMPLETE LED BAR</td> <td>1</td> <td>PZ</td> </tr> <tr> <td>VI1014A0</td> <td>STAINLESS STEEL WASHER 4.5X9X0.8</td> <td>1</td> <td>PZ</td> </tr> <tr> <td>VI1220A1</td> <td>4,2X12 TCB SELF-TAPPIN G SCREW</td> <td>1</td> <td>PZ</td> </tr> <tr> <td>VM1059A1</td> <td>HEAT SHRINK FILM H800</td> <td>0.300</td> <td>M</td> </tr> </tbody> </table>	Code	Description	Qty	UOM	IP1385A1	CORNER POLYSTYREN E PACKING 110X80X2000	0.300	M	LP1050A0	BL SHOP.PRO L180 COMPLETE LED BAR	1	PZ	VI1014A0	STAINLESS STEEL WASHER 4.5X9X0.8	1	PZ	VI1220A1	4,2X12 TCB SELF-TAPPIN G SCREW	1	PZ	VM1059A1	HEAT SHRINK FILM H800	0.300	M
Code	Description	Qty	UOM																										
IP1385A1	CORNER POLYSTYREN E PACKING 110X80X2000	0.300	M																										
LP1050A0	BL SHOP.PRO L180 COMPLETE LED BAR	1	PZ																										
VI1014A0	STAINLESS STEEL WASHER 4.5X9X0.8	1	PZ																										
VI1220A1	4,2X12 TCB SELF-TAPPIN G SCREW	1	PZ																										
VM1059A1	HEAT SHRINK FILM H800	0.300	M																										
CE1095A	4 POLES MICROFIT 2 M BUS CABLE		KCE1095A	4POLES 2M BUS CABLE KIT POWER-CONTROL	<table border="1"> <thead> <tr> <th>Code</th> <th>Description</th> <th>Qty</th> <th>UOM</th> </tr> </thead> <tbody> <tr> <td>CE1095A0</td> <td>4 POLES MICROFIT 2 M BUS CABLE</td> <td>1</td> <td>PZ</td> </tr> <tr> <td>VM1224A0</td> <td>65MY 220MM 2 COLOURS SHRINK TUBE</td> <td>0.250</td> <td>M</td> </tr> </tbody> </table>	Code	Description	Qty	UOM	CE1095A0	4 POLES MICROFIT 2 M BUS CABLE	1	PZ	VM1224A0	65MY 220MM 2 COLOURS SHRINK TUBE	0.250	M												
Code	Description	Qty	UOM																										
CE1095A0	4 POLES MICROFIT 2 M BUS CABLE	1	PZ																										
VM1224A0	65MY 220MM 2 COLOURS SHRINK TUBE	0.250	M																										
CR1112A	BLSP ARIANNA-ELENA DROPDOWN DOOR HINGE		KCR1112A	BAKERLUX SP ARIANNA-ELENA HINGES KIT	<table border="1"> <thead> <tr> <th>Code</th> <th>Description</th> <th>Qty</th> <th>UOM</th> </tr> </thead> <tbody> <tr> <td>CR1112A0</td> <td>BLSP ARIANNA-ELE NA DROPDOWN DOOR HINGE</td> <td>1</td> <td>PZ</td> </tr> <tr> <td>VI1875A0</td> <td>SCREW M5X10 TC1/2T INOX</td> <td>3</td> <td>PZ</td> </tr> </tbody> </table>	Code	Description	Qty	UOM	CR1112A0	BLSP ARIANNA-ELE NA DROPDOWN DOOR HINGE	1	PZ	VI1875A0	SCREW M5X10 TC1/2T INOX	3	PZ												
Code	Description	Qty	UOM																										
CR1112A0	BLSP ARIANNA-ELE NA DROPDOWN DOOR HINGE	1	PZ																										
VI1875A0	SCREW M5X10 TC1/2T INOX	3	PZ																										

COMPONENT			SPARE PART																																		
Code	Description	Image	Code	Description	Components list																																
VM2512A	BL SP DOOR-MICROSWITC H SOFT CLOSING		KVM2512A	BL SP DOOR-MICROSWITC H SOFT CLOSING KI	<table border="1"> <thead> <tr> <th>Code</th> <th>Description</th> <th>Qty</th> <th>UOM</th> </tr> </thead> <tbody> <tr> <td>VM1224A0</td> <td>65MY 220MM 2 COLOURS SHRINK TUBE</td> <td>0.250</td> <td>M</td> </tr> <tr> <td>VM2512A0</td> <td>BL SP DOOR-MICRO SWITCH SOFT CLOSING</td> <td>1</td> <td>PZ</td> </tr> <tr> <td>VM2512A0</td> <td>BL SP DOOR-MICRO SWITCH SOFT CLOSING</td> <td>1</td> <td>PZ</td> </tr> </tbody> </table>	Code	Description	Qty	UOM	VM1224A0	65MY 220MM 2 COLOURS SHRINK TUBE	0.250	M	VM2512A0	BL SP DOOR-MICRO SWITCH SOFT CLOSING	1	PZ	VM2512A0	BL SP DOOR-MICRO SWITCH SOFT CLOSING	1	PZ																
Code	Description	Qty	UOM																																		
VM1224A0	65MY 220MM 2 COLOURS SHRINK TUBE	0.250	M																																		
VM2512A0	BL SP DOOR-MICRO SWITCH SOFT CLOSING	1	PZ																																		
VM2512A0	BL SP DOOR-MICRO SWITCH SOFT CLOSING	1	PZ																																		
VM2471A	BL SP LOWER CLAMP INT LOCK GLASS SLIDER		KVM2471A	BL SP INTERNAL GLASS LOCK HOLDER KIT	<table border="1"> <thead> <tr> <th>Code</th> <th>Description</th> <th>Qty</th> <th>UOM</th> </tr> </thead> <tbody> <tr> <td>VH1930A0</td> <td>5X25 ST. STEEL SCREW CHIP</td> <td>2</td> <td>PZ</td> </tr> <tr> <td>VI1998A0</td> <td>ZINC PLATED SCREW 5X30 TCB</td> <td>2</td> <td>PZ</td> </tr> <tr> <td>VM1224A0</td> <td>65MY 220MM 2 COLOURS SHRINK TUBE</td> <td>0.150</td> <td>M</td> </tr> <tr> <td>VM2471A0</td> <td>BL SP LOWER CLAMP INT LOCK GLASS SLIDER</td> <td>1</td> <td>PZ</td> </tr> <tr> <td>VM2471A0</td> <td>BL SP LOWER CLAMP INT LOCK GLASS SLIDER</td> <td>1</td> <td>PZ</td> </tr> <tr> <td>VM2472A0</td> <td>BL SP UPPER CLAMP INT LOCK GLASS SLIDER</td> <td>1</td> <td>PZ</td> </tr> <tr> <td>VM2472A0</td> <td>BL SP UPPER CLAMP INT LOCK GLASS SLIDER</td> <td>1</td> <td>PZ</td> </tr> </tbody> </table>	Code	Description	Qty	UOM	VH1930A0	5X25 ST. STEEL SCREW CHIP	2	PZ	VI1998A0	ZINC PLATED SCREW 5X30 TCB	2	PZ	VM1224A0	65MY 220MM 2 COLOURS SHRINK TUBE	0.150	M	VM2471A0	BL SP LOWER CLAMP INT LOCK GLASS SLIDER	1	PZ	VM2471A0	BL SP LOWER CLAMP INT LOCK GLASS SLIDER	1	PZ	VM2472A0	BL SP UPPER CLAMP INT LOCK GLASS SLIDER	1	PZ	VM2472A0	BL SP UPPER CLAMP INT LOCK GLASS SLIDER	1	PZ
Code	Description	Qty	UOM																																		
VH1930A0	5X25 ST. STEEL SCREW CHIP	2	PZ																																		
VI1998A0	ZINC PLATED SCREW 5X30 TCB	2	PZ																																		
VM1224A0	65MY 220MM 2 COLOURS SHRINK TUBE	0.150	M																																		
VM2471A0	BL SP LOWER CLAMP INT LOCK GLASS SLIDER	1	PZ																																		
VM2471A0	BL SP LOWER CLAMP INT LOCK GLASS SLIDER	1	PZ																																		
VM2472A0	BL SP UPPER CLAMP INT LOCK GLASS SLIDER	1	PZ																																		
VM2472A0	BL SP UPPER CLAMP INT LOCK GLASS SLIDER	1	PZ																																		
VM2503A	SLIDE TO FIX INTERNAL NON REMOV GLASS SP		KVM2503A	BL SP INT FIXED GLASS LOCK 2 PCS KIT	<table border="1"> <thead> <tr> <th>Code</th> <th>Description</th> <th>Qty</th> <th>UOM</th> </tr> </thead> <tbody> <tr> <td>VM1224A0</td> <td>65MY 220MM 2 COLOURS SHRINK TUBE</td> <td>0.150</td> <td>M</td> </tr> <tr> <td>VM2503A0</td> <td>SLIDE TO FIX INTERNAL NON REMOV GLASS SP</td> <td>2</td> <td>PZ</td> </tr> <tr> <td>VM2503A0</td> <td>SLIDE TO FIX INTERNAL NON REMOV GLASS SP</td> <td>2</td> <td>PZ</td> </tr> </tbody> </table>	Code	Description	Qty	UOM	VM1224A0	65MY 220MM 2 COLOURS SHRINK TUBE	0.150	M	VM2503A0	SLIDE TO FIX INTERNAL NON REMOV GLASS SP	2	PZ	VM2503A0	SLIDE TO FIX INTERNAL NON REMOV GLASS SP	2	PZ																
Code	Description	Qty	UOM																																		
VM1224A0	65MY 220MM 2 COLOURS SHRINK TUBE	0.150	M																																		
VM2503A0	SLIDE TO FIX INTERNAL NON REMOV GLASS SP	2	PZ																																		
VM2503A0	SLIDE TO FIX INTERNAL NON REMOV GLASS SP	2	PZ																																		

COMPONENT			SPARE PART																																		
Code	Description	Image	Code	Description	Components list																																
VM2464A	SHOP.PRO LEFT UPPER CAP DROP DOWN DOOR		KVM2464A	BL SP LEFT UPPER DROPDOWN DOOR CAP KIT	<table border="1"> <thead> <tr> <th>Code</th> <th>Description</th> <th>Qty</th> <th>UOM</th> </tr> </thead> <tbody> <tr> <td>VM1224A0</td> <td>65MY 220MM 2 COLOURS SHRINK TUBE</td> <td>0.300</td> <td>M</td> </tr> <tr> <td>VM2464A0</td> <td>SHOP.PRO LEFT UPPER CAP DROP DOWN DOOR</td> <td>1</td> <td>PZ</td> </tr> <tr> <td>VM2464A0</td> <td>SHOP.PRO LEFT UPPER CAP DROP DOWN DOOR</td> <td>1</td> <td>PZ</td> </tr> </tbody> </table>	Code	Description	Qty	UOM	VM1224A0	65MY 220MM 2 COLOURS SHRINK TUBE	0.300	M	VM2464A0	SHOP.PRO LEFT UPPER CAP DROP DOWN DOOR	1	PZ	VM2464A0	SHOP.PRO LEFT UPPER CAP DROP DOWN DOOR	1	PZ																
Code	Description	Qty	UOM																																		
VM1224A0	65MY 220MM 2 COLOURS SHRINK TUBE	0.300	M																																		
VM2464A0	SHOP.PRO LEFT UPPER CAP DROP DOWN DOOR	1	PZ																																		
VM2464A0	SHOP.PRO LEFT UPPER CAP DROP DOWN DOOR	1	PZ																																		
VM2472A	BL SP UPPER CLAMP INT LOCK GLASS SLIDER		KVM2471A	BL SP INTERNAL GLASS LOCK HOLDER KIT	<table border="1"> <thead> <tr> <th>Code</th> <th>Description</th> <th>Qty</th> <th>UOM</th> </tr> </thead> <tbody> <tr> <td>V11930A0</td> <td>5X25 ST. STEEL SCREW CHIP</td> <td>2</td> <td>PZ</td> </tr> <tr> <td>V11998A0</td> <td>ZINC PLATED SCREW 5X30 TCB</td> <td>2</td> <td>PZ</td> </tr> <tr> <td>VM1224A0</td> <td>65MY 220MM 2 COLOURS SHRINK TUBE</td> <td>0.150</td> <td>M</td> </tr> <tr> <td>VM2471A0</td> <td>BL SP LOWER CLAMP INT LOCK GLASS SLIDER</td> <td>1</td> <td>PZ</td> </tr> <tr> <td>VM2471A0</td> <td>BL SP LOWER CLAMP INT LOCK GLASS SLIDER</td> <td>1</td> <td>PZ</td> </tr> <tr> <td>VM2472A0</td> <td>BL SP UPPER CLAMP INT LOCK GLASS SLIDER</td> <td>1</td> <td>PZ</td> </tr> <tr> <td>VM2472A0</td> <td>BL SP UPPER CLAMP INT LOCK GLASS SLIDER</td> <td>1</td> <td>PZ</td> </tr> </tbody> </table>	Code	Description	Qty	UOM	V11930A0	5X25 ST. STEEL SCREW CHIP	2	PZ	V11998A0	ZINC PLATED SCREW 5X30 TCB	2	PZ	VM1224A0	65MY 220MM 2 COLOURS SHRINK TUBE	0.150	M	VM2471A0	BL SP LOWER CLAMP INT LOCK GLASS SLIDER	1	PZ	VM2471A0	BL SP LOWER CLAMP INT LOCK GLASS SLIDER	1	PZ	VM2472A0	BL SP UPPER CLAMP INT LOCK GLASS SLIDER	1	PZ	VM2472A0	BL SP UPPER CLAMP INT LOCK GLASS SLIDER	1	PZ
Code	Description	Qty	UOM																																		
V11930A0	5X25 ST. STEEL SCREW CHIP	2	PZ																																		
V11998A0	ZINC PLATED SCREW 5X30 TCB	2	PZ																																		
VM1224A0	65MY 220MM 2 COLOURS SHRINK TUBE	0.150	M																																		
VM2471A0	BL SP LOWER CLAMP INT LOCK GLASS SLIDER	1	PZ																																		
VM2471A0	BL SP LOWER CLAMP INT LOCK GLASS SLIDER	1	PZ																																		
VM2472A0	BL SP UPPER CLAMP INT LOCK GLASS SLIDER	1	PZ																																		
VM2472A0	BL SP UPPER CLAMP INT LOCK GLASS SLIDER	1	PZ																																		
VM2503A	SLIDE TO FIX INTERNAL NON REMOV GLASS SP		KVM2503A	BL SP INT FIXED GLASS LOCK 2 PCS KIT	<table border="1"> <thead> <tr> <th>Code</th> <th>Description</th> <th>Qty</th> <th>UOM</th> </tr> </thead> <tbody> <tr> <td>VM1224A0</td> <td>65MY 220MM 2 COLOURS SHRINK TUBE</td> <td>0.150</td> <td>M</td> </tr> <tr> <td>VM2503A0</td> <td>SLIDE TO FIX INTERNAL NON REMOV GLASS SP</td> <td>2</td> <td>PZ</td> </tr> <tr> <td>VM2503A0</td> <td>SLIDE TO FIX INTERNAL NON REMOV GLASS SP</td> <td>2</td> <td>PZ</td> </tr> </tbody> </table>	Code	Description	Qty	UOM	VM1224A0	65MY 220MM 2 COLOURS SHRINK TUBE	0.150	M	VM2503A0	SLIDE TO FIX INTERNAL NON REMOV GLASS SP	2	PZ	VM2503A0	SLIDE TO FIX INTERNAL NON REMOV GLASS SP	2	PZ																
Code	Description	Qty	UOM																																		
VM1224A0	65MY 220MM 2 COLOURS SHRINK TUBE	0.150	M																																		
VM2503A0	SLIDE TO FIX INTERNAL NON REMOV GLASS SP	2	PZ																																		
VM2503A0	SLIDE TO FIX INTERNAL NON REMOV GLASS SP	2	PZ																																		

COMPONENT			SPARE PART																										
Code	Description	Image	Code	Description	Components list																								
VM2463A	SHOP.PRO RIGHT UPPER CAP DROP DOWN DOOR		KVM2463A	BL SP RIGHT UPPER DROPDOWN DOOR CAP KIT	<table border="1"> <thead> <tr> <th>Code</th> <th>Description</th> <th>Qty</th> <th>UOM</th> </tr> </thead> <tbody> <tr> <td>VM1224A0</td> <td>65MY 220MM 2 COLOURS SHRINK TUBE</td> <td>0.300</td> <td>M</td> </tr> <tr> <td>VM2463A0</td> <td>SHOP.PRO RIGHT UPPER CAP DROP DOWN DOOR</td> <td>1</td> <td>PZ</td> </tr> <tr> <td>VM2463A0</td> <td>SHOP.PRO RIGHT UPPER CAP DROP DOWN DOOR</td> <td>1</td> <td>PZ</td> </tr> </tbody> </table>	Code	Description	Qty	UOM	VM1224A0	65MY 220MM 2 COLOURS SHRINK TUBE	0.300	M	VM2463A0	SHOP.PRO RIGHT UPPER CAP DROP DOWN DOOR	1	PZ	VM2463A0	SHOP.PRO RIGHT UPPER CAP DROP DOWN DOOR	1	PZ								
Code	Description	Qty	UOM																										
VM1224A0	65MY 220MM 2 COLOURS SHRINK TUBE	0.300	M																										
VM2463A0	SHOP.PRO RIGHT UPPER CAP DROP DOWN DOOR	1	PZ																										
VM2463A0	SHOP.PRO RIGHT UPPER CAP DROP DOWN DOOR	1	PZ																										
VM2461A	BL SP RIGHT LOWER DROPDOWN DOOR CAP KIT		KVM2461A	BL SP RIGHT LOWER DROPDOWN DOOR CAP KIT	<table border="1"> <thead> <tr> <th>Code</th> <th>Description</th> <th>Qty</th> <th>UOM</th> </tr> </thead> <tbody> <tr> <td>VM1224A0</td> <td>65MY 220MM 2 COLOURS SHRINK TUBE</td> <td>0.300</td> <td>M</td> </tr> <tr> <td>VM2461A0</td> <td>BL SP RIGHT LOWER DROPDOWN DOOR CAP KIT</td> <td>1</td> <td>PZ</td> </tr> <tr> <td>VM2461A0</td> <td>BL SP RIGHT LOWER DROPDOWN DOOR CAP KIT</td> <td>1</td> <td>PZ</td> </tr> </tbody> </table>	Code	Description	Qty	UOM	VM1224A0	65MY 220MM 2 COLOURS SHRINK TUBE	0.300	M	VM2461A0	BL SP RIGHT LOWER DROPDOWN DOOR CAP KIT	1	PZ	VM2461A0	BL SP RIGHT LOWER DROPDOWN DOOR CAP KIT	1	PZ								
Code	Description	Qty	UOM																										
VM1224A0	65MY 220MM 2 COLOURS SHRINK TUBE	0.300	M																										
VM2461A0	BL SP RIGHT LOWER DROPDOWN DOOR CAP KIT	1	PZ																										
VM2461A0	BL SP RIGHT LOWER DROPDOWN DOOR CAP KIT	1	PZ																										
VM2462A	BL SP LEFT LOWER DROPDOWN DOOR CAP		KVM2462A	BL SP LEFT LOWER DROPDOWN DOOR CAP KIT	<table border="1"> <thead> <tr> <th>Code</th> <th>Description</th> <th>Qty</th> <th>UOM</th> </tr> </thead> <tbody> <tr> <td>VM1224A0</td> <td>65MY 220MM 2 COLOURS SHRINK TUBE</td> <td>0.300</td> <td>M</td> </tr> <tr> <td>VM2462A0</td> <td>BL SP LEFT LOWER DROPDOWN DOOR CAP</td> <td>1</td> <td>PZ</td> </tr> <tr> <td>VM2462A0</td> <td>BL SP LEFT LOWER DROPDOWN DOOR CAP</td> <td>1</td> <td>PZ</td> </tr> </tbody> </table>	Code	Description	Qty	UOM	VM1224A0	65MY 220MM 2 COLOURS SHRINK TUBE	0.300	M	VM2462A0	BL SP LEFT LOWER DROPDOWN DOOR CAP	1	PZ	VM2462A0	BL SP LEFT LOWER DROPDOWN DOOR CAP	1	PZ								
Code	Description	Qty	UOM																										
VM1224A0	65MY 220MM 2 COLOURS SHRINK TUBE	0.300	M																										
VM2462A0	BL SP LEFT LOWER DROPDOWN DOOR CAP	1	PZ																										
VM2462A0	BL SP LEFT LOWER DROPDOWN DOOR CAP	1	PZ																										
VM2479A	BL SP GLASS H6 PUSHING BRACKET		KVM2479A	BL SHOP.PRO H6 GLASS SUPPORT 6 PCS KIT	<table border="1"> <thead> <tr> <th>Code</th> <th>Description</th> <th>Qty</th> <th>UOM</th> </tr> </thead> <tbody> <tr> <td>VM1224A0</td> <td>65MY 220MM 2 COLOURS SHRINK TUBE</td> <td>0.200</td> <td>M</td> </tr> <tr> <td>VM1630A0</td> <td>INTERNAL GLASS PUSHING CAP</td> <td>6</td> <td>PZ</td> </tr> <tr> <td>VM1630A1</td> <td>INTERNAL GLASS PUSHING CAP</td> <td>6</td> <td>PZ</td> </tr> <tr> <td>VM2479A0</td> <td>BL SP GLASS H6 PUSHING BRACKET</td> <td>6</td> <td>PZ</td> </tr> <tr> <td>VM2479A0</td> <td>BL SP GLASS H6 PUSHING BRACKET</td> <td>6</td> <td>PZ</td> </tr> </tbody> </table>	Code	Description	Qty	UOM	VM1224A0	65MY 220MM 2 COLOURS SHRINK TUBE	0.200	M	VM1630A0	INTERNAL GLASS PUSHING CAP	6	PZ	VM1630A1	INTERNAL GLASS PUSHING CAP	6	PZ	VM2479A0	BL SP GLASS H6 PUSHING BRACKET	6	PZ	VM2479A0	BL SP GLASS H6 PUSHING BRACKET	6	PZ
Code	Description	Qty	UOM																										
VM1224A0	65MY 220MM 2 COLOURS SHRINK TUBE	0.200	M																										
VM1630A0	INTERNAL GLASS PUSHING CAP	6	PZ																										
VM1630A1	INTERNAL GLASS PUSHING CAP	6	PZ																										
VM2479A0	BL SP GLASS H6 PUSHING BRACKET	6	PZ																										
VM2479A0	BL SP GLASS H6 PUSHING BRACKET	6	PZ																										

COMPONENT			SPARE PART																																										
Code	Description	Image	Code	Description	Components list																																								
VM1630A	INTERNAL GLASS PUSHING CAP		KVM1630A	CAP FOR INTERNAL GLASS 10 PCS KIT	<table border="1"> <thead> <tr> <th>Code</th> <th>Description</th> <th>Qty</th> <th>UOM</th> </tr> </thead> <tbody> <tr> <td>VM1224A0</td> <td>65MY 220MM 2 COLOURS SHRINK TUBE</td> <td>0.200</td> <td>M</td> </tr> <tr> <td>VM1630A0</td> <td>INTERNAL GLASS PUSHING CAP</td> <td>10</td> <td>PZ</td> </tr> <tr> <td>VM1630A1</td> <td>INTERNAL GLASS PUSHING CAP</td> <td>10</td> <td>PZ</td> </tr> </tbody> </table>	Code	Description	Qty	UOM	VM1224A0	65MY 220MM 2 COLOURS SHRINK TUBE	0.200	M	VM1630A0	INTERNAL GLASS PUSHING CAP	10	PZ	VM1630A1	INTERNAL GLASS PUSHING CAP	10	PZ																								
Code	Description	Qty	UOM																																										
VM1224A0	65MY 220MM 2 COLOURS SHRINK TUBE	0.200	M																																										
VM1630A0	INTERNAL GLASS PUSHING CAP	10	PZ																																										
VM1630A1	INTERNAL GLASS PUSHING CAP	10	PZ																																										
0B1286A			0B1286A0																																										
0B1288A			0B1288A0																																										
VT1325A	SP ELENA 557X364X4 EXTERNAL GLASS		KVT1325A	BL SHOP.PRO ELENA EXTERNAL GLASS KIT	<table border="1"> <thead> <tr> <th>Code</th> <th>Description</th> <th>Qty</th> <th>UOM</th> </tr> </thead> <tbody> <tr> <td>0B0386A0</td> <td></td> <td>2</td> <td>PZ</td> </tr> <tr> <td>ED1240A0</td> <td>TECHNICAL DATA LABEL</td> <td>1</td> <td>PZ</td> </tr> <tr> <td>IP1385A1</td> <td>CORNER POLYSTYREN E PACKING 110X80X2000</td> <td>1.200</td> <td>M</td> </tr> <tr> <td>IP1508A1</td> <td>POLYSTYREN E U SHAPED PROFILE 2000X60X60</td> <td>0.800</td> <td>M</td> </tr> <tr> <td>SL1155A1</td> <td>LOCTITE BICOMPONEN T SILICON</td> <td>14</td> <td>ML</td> </tr> <tr> <td>VI1220A1</td> <td>4,2X12 TCB SELF-TAPPIN G SCREW</td> <td>6</td> <td>PZ</td> </tr> <tr> <td>VM1059A1</td> <td>HEAT SHRINK FILM H800</td> <td>1.200</td> <td>M</td> </tr> <tr> <td>VT1325A0</td> <td>SP ELENA 557X364X4 EXTERNAL GLASS</td> <td>1</td> <td>PZ</td> </tr> <tr> <td>VT1325A0</td> <td>SP ELENA 557X364X4 EXTERNAL GLASS</td> <td>1</td> <td>PZ</td> </tr> </tbody> </table>	Code	Description	Qty	UOM	0B0386A0		2	PZ	ED1240A0	TECHNICAL DATA LABEL	1	PZ	IP1385A1	CORNER POLYSTYREN E PACKING 110X80X2000	1.200	M	IP1508A1	POLYSTYREN E U SHAPED PROFILE 2000X60X60	0.800	M	SL1155A1	LOCTITE BICOMPONEN T SILICON	14	ML	VI1220A1	4,2X12 TCB SELF-TAPPIN G SCREW	6	PZ	VM1059A1	HEAT SHRINK FILM H800	1.200	M	VT1325A0	SP ELENA 557X364X4 EXTERNAL GLASS	1	PZ	VT1325A0	SP ELENA 557X364X4 EXTERNAL GLASS	1	PZ
Code	Description	Qty	UOM																																										
0B0386A0		2	PZ																																										
ED1240A0	TECHNICAL DATA LABEL	1	PZ																																										
IP1385A1	CORNER POLYSTYREN E PACKING 110X80X2000	1.200	M																																										
IP1508A1	POLYSTYREN E U SHAPED PROFILE 2000X60X60	0.800	M																																										
SL1155A1	LOCTITE BICOMPONEN T SILICON	14	ML																																										
VI1220A1	4,2X12 TCB SELF-TAPPIN G SCREW	6	PZ																																										
VM1059A1	HEAT SHRINK FILM H800	1.200	M																																										
VT1325A0	SP ELENA 557X364X4 EXTERNAL GLASS	1	PZ																																										
VT1325A0	SP ELENA 557X364X4 EXTERNAL GLASS	1	PZ																																										



COMPONENT			SPARE PART																																																																																		
Code	Description	Image	Code	Description	Components list																																																																																
VT1325A	SP ELENA 557X364X4 EXTERNAL GLASS		KDR1289A	BL SHOP.PRO ELENA EXTERNAL LEFT DOOR KIT	<table border="1"> <thead> <tr> <th>Code</th> <th>Description</th> <th>Qty</th> <th>UOM</th> </tr> </thead> <tbody> <tr> <td>0B1293A0</td> <td></td> <td>1</td> <td>PZ</td> </tr> <tr> <td>0B1294A0</td> <td></td> <td>1</td> <td>PZ</td> </tr> <tr> <td>0B1295B0</td> <td></td> <td>1</td> <td>PZ</td> </tr> <tr> <td>0B1296B0</td> <td></td> <td>1</td> <td>PZ</td> </tr> <tr> <td>CR1040A0</td> <td>DOOR LATCH FOR EL.MECH. LOCKING SYSTEM</td> <td>1</td> <td>PZ</td> </tr> <tr> <td>ED1240A0</td> <td>TECHNICAL DATA LABEL</td> <td>1</td> <td>PZ</td> </tr> <tr> <td>IP1325B0</td> <td>POLYSTYREN E CORNER PACKING D20</td> <td>0.650</td> <td>PZ</td> </tr> <tr> <td>IP1385A1</td> <td>CORNER POLYSTYREN E PACKING 110X80X2000</td> <td>0.400</td> <td>M</td> </tr> <tr> <td>IP1508A1</td> <td>POLYSTYREN E U SHAPED PROFILE 2000X60X60</td> <td>1.200</td> <td>M</td> </tr> <tr> <td>ML1005A0</td> <td>DES DF0.6 H18 COMPRESSIO N SPRING</td> <td>2</td> <td>PZ</td> </tr> <tr> <td>SL1155A1</td> <td>LOCTITE BICOMPONEN T SILICON</td> <td>14</td> <td>ML</td> </tr> <tr> <td>TB1563A0</td> <td>DOOR LATERAL BEAM SP800</td> <td>2</td> <td>PZ</td> </tr> <tr> <td>TB3303A0</td> <td>SHOP.PRO STE-ELE FLAG DOOR HANDLE TUBE</td> <td>1</td> <td>PZ</td> </tr> <tr> <td>VI1036A0</td> <td>ST STEEL STRIPED THREAD INSERT M10 FTT/C</td> <td>1</td> <td>PZ</td> </tr> <tr> <td>VI1220A1</td> <td>4,2X12 TCB SELF-TAPPIN G SCREW</td> <td>12</td> <td>PZ</td> </tr> <tr> <td>VI1930A0</td> <td>5X25 ST. STEEL SCREW CHIP</td> <td>22</td> <td>PZ</td> </tr> <tr> <td>VI1998A0</td> <td>ZINC PLATED SCREW 5X30 TCB</td> <td>2</td> <td>PZ</td> </tr> <tr> <td>VM1059A1</td> <td>HEAT SHRINK FILM H800</td> <td>1.200</td> <td>M</td> </tr> <tr> <td>VM1209A0</td> <td>SHOP.PRO LOCK PIN WASHER</td> <td>1</td> <td>PZ</td> </tr> </tbody> </table>	Code	Description	Qty	UOM	0B1293A0		1	PZ	0B1294A0		1	PZ	0B1295B0		1	PZ	0B1296B0		1	PZ	CR1040A0	DOOR LATCH FOR EL.MECH. LOCKING SYSTEM	1	PZ	ED1240A0	TECHNICAL DATA LABEL	1	PZ	IP1325B0	POLYSTYREN E CORNER PACKING D20	0.650	PZ	IP1385A1	CORNER POLYSTYREN E PACKING 110X80X2000	0.400	M	IP1508A1	POLYSTYREN E U SHAPED PROFILE 2000X60X60	1.200	M	ML1005A0	DES DF0.6 H18 COMPRESSIO N SPRING	2	PZ	SL1155A1	LOCTITE BICOMPONEN T SILICON	14	ML	TB1563A0	DOOR LATERAL BEAM SP800	2	PZ	TB3303A0	SHOP.PRO STE-ELE FLAG DOOR HANDLE TUBE	1	PZ	VI1036A0	ST STEEL STRIPED THREAD INSERT M10 FTT/C	1	PZ	VI1220A1	4,2X12 TCB SELF-TAPPIN G SCREW	12	PZ	VI1930A0	5X25 ST. STEEL SCREW CHIP	22	PZ	VI1998A0	ZINC PLATED SCREW 5X30 TCB	2	PZ	VM1059A1	HEAT SHRINK FILM H800	1.200	M	VM1209A0	SHOP.PRO LOCK PIN WASHER	1	PZ
Code	Description	Qty	UOM																																																																																		
0B1293A0		1	PZ																																																																																		
0B1294A0		1	PZ																																																																																		
0B1295B0		1	PZ																																																																																		
0B1296B0		1	PZ																																																																																		
CR1040A0	DOOR LATCH FOR EL.MECH. LOCKING SYSTEM	1	PZ																																																																																		
ED1240A0	TECHNICAL DATA LABEL	1	PZ																																																																																		
IP1325B0	POLYSTYREN E CORNER PACKING D20	0.650	PZ																																																																																		
IP1385A1	CORNER POLYSTYREN E PACKING 110X80X2000	0.400	M																																																																																		
IP1508A1	POLYSTYREN E U SHAPED PROFILE 2000X60X60	1.200	M																																																																																		
ML1005A0	DES DF0.6 H18 COMPRESSIO N SPRING	2	PZ																																																																																		
SL1155A1	LOCTITE BICOMPONEN T SILICON	14	ML																																																																																		
TB1563A0	DOOR LATERAL BEAM SP800	2	PZ																																																																																		
TB3303A0	SHOP.PRO STE-ELE FLAG DOOR HANDLE TUBE	1	PZ																																																																																		
VI1036A0	ST STEEL STRIPED THREAD INSERT M10 FTT/C	1	PZ																																																																																		
VI1220A1	4,2X12 TCB SELF-TAPPIN G SCREW	12	PZ																																																																																		
VI1930A0	5X25 ST. STEEL SCREW CHIP	22	PZ																																																																																		
VI1998A0	ZINC PLATED SCREW 5X30 TCB	2	PZ																																																																																		
VM1059A1	HEAT SHRINK FILM H800	1.200	M																																																																																		
VM1209A0	SHOP.PRO LOCK PIN WASHER	1	PZ																																																																																		





COMPONENT			SPARE PART																																																														
Code	Description	Image	Code	Description	Components list																																																												
VT1325A	SP ELENA 557X364X4 EXTERNAL GLASS		KDR1289A	BL SHOP.PRO ELENA EXTERNAL LEFT DOOR KIT	<table border="1"> <thead> <tr> <th>Code</th> <th>Description</th> <th>Qty</th> <th>UOM</th> </tr> </thead> <tbody> <tr> <td>VM1630A0</td> <td>INTERNAL GLASS PUSHING CAP</td> <td>4</td> <td>PZ</td> </tr> <tr> <td>VM1630A1</td> <td>INTERNAL GLASS PUSHING CAP</td> <td>4</td> <td>PZ</td> </tr> <tr> <td>VM2274A0</td> <td>GROOVED BUSHING</td> <td>1</td> <td>PZ</td> </tr> <tr> <td>VM2275A0</td> <td>SMOOTH BUSHING</td> <td>1</td> <td>PZ</td> </tr> <tr> <td>VM2456A0</td> <td>BAKERLUX SHOP.PRO HANDLE END</td> <td>2</td> <td>PZ</td> </tr> <tr> <td>VM2456A0</td> <td>BAKERLUX SHOP.PRO HANDLE END</td> <td>2</td> <td>PZ</td> </tr> <tr> <td>VM2465A0</td> <td>SP SIDE-OPENIN G DOOR RIGHT LOWER CAP KIT</td> <td>1</td> <td>PZ</td> </tr> <tr> <td>VM2465A0</td> <td>SP SIDE-OPENIN G DOOR RIGHT LOWER CAP KIT</td> <td>1</td> <td>PZ</td> </tr> <tr> <td>VM2466A0</td> <td>BL SP LEFT LOWER LATERAL DOOR CAP</td> <td>1</td> <td>PZ</td> </tr> <tr> <td>VM2466A0</td> <td>BL SP LEFT LOWER LATERAL DOOR CAP</td> <td>1</td> <td>PZ</td> </tr> <tr> <td>VM2467A0</td> <td>SP SIDE-OPENIN G DOOR RIGHT UPPER CAP KIT</td> <td>1</td> <td>PZ</td> </tr> <tr> <td>VM2467A0</td> <td>SP SIDE-OPENIN G DOOR RIGHT UPPER CAP KIT</td> <td>1</td> <td>PZ</td> </tr> <tr> <td>VM2468A0</td> <td>BL SP LEFT UPPER LATERAL DOOR CAP</td> <td>1</td> <td>PZ</td> </tr> <tr> <td>VM2468A0</td> <td>BL SP LEFT UPPER LATERAL DOOR CAP</td> <td>1</td> <td>PZ</td> </tr> </tbody> </table>	Code	Description	Qty	UOM	VM1630A0	INTERNAL GLASS PUSHING CAP	4	PZ	VM1630A1	INTERNAL GLASS PUSHING CAP	4	PZ	VM2274A0	GROOVED BUSHING	1	PZ	VM2275A0	SMOOTH BUSHING	1	PZ	VM2456A0	BAKERLUX SHOP.PRO HANDLE END	2	PZ	VM2456A0	BAKERLUX SHOP.PRO HANDLE END	2	PZ	VM2465A0	SP SIDE-OPENIN G DOOR RIGHT LOWER CAP KIT	1	PZ	VM2465A0	SP SIDE-OPENIN G DOOR RIGHT LOWER CAP KIT	1	PZ	VM2466A0	BL SP LEFT LOWER LATERAL DOOR CAP	1	PZ	VM2466A0	BL SP LEFT LOWER LATERAL DOOR CAP	1	PZ	VM2467A0	SP SIDE-OPENIN G DOOR RIGHT UPPER CAP KIT	1	PZ	VM2467A0	SP SIDE-OPENIN G DOOR RIGHT UPPER CAP KIT	1	PZ	VM2468A0	BL SP LEFT UPPER LATERAL DOOR CAP	1	PZ	VM2468A0	BL SP LEFT UPPER LATERAL DOOR CAP	1	PZ
Code	Description	Qty	UOM																																																														
VM1630A0	INTERNAL GLASS PUSHING CAP	4	PZ																																																														
VM1630A1	INTERNAL GLASS PUSHING CAP	4	PZ																																																														
VM2274A0	GROOVED BUSHING	1	PZ																																																														
VM2275A0	SMOOTH BUSHING	1	PZ																																																														
VM2456A0	BAKERLUX SHOP.PRO HANDLE END	2	PZ																																																														
VM2456A0	BAKERLUX SHOP.PRO HANDLE END	2	PZ																																																														
VM2465A0	SP SIDE-OPENIN G DOOR RIGHT LOWER CAP KIT	1	PZ																																																														
VM2465A0	SP SIDE-OPENIN G DOOR RIGHT LOWER CAP KIT	1	PZ																																																														
VM2466A0	BL SP LEFT LOWER LATERAL DOOR CAP	1	PZ																																																														
VM2466A0	BL SP LEFT LOWER LATERAL DOOR CAP	1	PZ																																																														
VM2467A0	SP SIDE-OPENIN G DOOR RIGHT UPPER CAP KIT	1	PZ																																																														
VM2467A0	SP SIDE-OPENIN G DOOR RIGHT UPPER CAP KIT	1	PZ																																																														
VM2468A0	BL SP LEFT UPPER LATERAL DOOR CAP	1	PZ																																																														
VM2468A0	BL SP LEFT UPPER LATERAL DOOR CAP	1	PZ																																																														



COMPONENT			SPARE PART																																																														
Code	Description	Image	Code	Description	Components list																																																												
VT1325A	SP ELENA 557X364X4 EXTERNAL GLASS		KDR1289A	BL SHOP.PRO ELENA EXTERNAL LEFT DOOR KIT	<table border="1"> <thead> <tr> <th>Code</th> <th>Description</th> <th>Qty</th> <th>UOM</th> </tr> </thead> <tbody> <tr> <td>VM2470A0</td> <td>SLIDE TO FIX INTERNAL GLASS SHOP.PRO</td> <td>2</td> <td>PZ</td> </tr> <tr> <td>VM2470A0</td> <td>SLIDE TO FIX INTERNAL GLASS SHOP.PRO</td> <td>2</td> <td>PZ</td> </tr> <tr> <td>VM2471A0</td> <td>BL SP LOWER CLAMP INT LOCK GLASS SLIDER</td> <td>1</td> <td>PZ</td> </tr> <tr> <td>VM2471A0</td> <td>BL SP LOWER CLAMP INT LOCK GLASS SLIDER</td> <td>1</td> <td>PZ</td> </tr> <tr> <td>VM2472A0</td> <td>BL SP UPPER CLAMP INT LOCK GLASS SLIDER</td> <td>1</td> <td>PZ</td> </tr> <tr> <td>VM2472A0</td> <td>BL SP UPPER CLAMP INT LOCK GLASS SLIDER</td> <td>1</td> <td>PZ</td> </tr> <tr> <td>VM2473A0</td> <td>BL SP INT GLASS HINGE LOWER LOCK PIN</td> <td>1</td> <td>PZ</td> </tr> <tr> <td>VM2473A0</td> <td>BL SP INT GLASS HINGE LOWER LOCK PIN</td> <td>1</td> <td>PZ</td> </tr> <tr> <td>VM2474A0</td> <td>BL SP INT GLASS HINGE UPPER LOCK PIN</td> <td>1</td> <td>PZ</td> </tr> <tr> <td>VM2474A0</td> <td>BL SP INT GLASS HINGE UPPER LOCK PIN</td> <td>1</td> <td>PZ</td> </tr> <tr> <td>VM2479A0</td> <td>BL SP GLASS H6 PUSHING BRACKET</td> <td>4</td> <td>PZ</td> </tr> <tr> <td>VM2479A0</td> <td>BL SP GLASS H6 PUSHING BRACKET</td> <td>4</td> <td>PZ</td> </tr> <tr> <td>VM2489A0</td> <td>SP HANDLE END KIT + STYLUS KIT</td> <td>1</td> <td>PZ</td> </tr> <tr> <td>VM2504A0</td> <td>DOWEL TO GUIDE SLIDE SPRING SHOP.PRO</td> <td>2</td> <td>PZ</td> </tr> </tbody> </table>	Code	Description	Qty	UOM	VM2470A0	SLIDE TO FIX INTERNAL GLASS SHOP.PRO	2	PZ	VM2470A0	SLIDE TO FIX INTERNAL GLASS SHOP.PRO	2	PZ	VM2471A0	BL SP LOWER CLAMP INT LOCK GLASS SLIDER	1	PZ	VM2471A0	BL SP LOWER CLAMP INT LOCK GLASS SLIDER	1	PZ	VM2472A0	BL SP UPPER CLAMP INT LOCK GLASS SLIDER	1	PZ	VM2472A0	BL SP UPPER CLAMP INT LOCK GLASS SLIDER	1	PZ	VM2473A0	BL SP INT GLASS HINGE LOWER LOCK PIN	1	PZ	VM2473A0	BL SP INT GLASS HINGE LOWER LOCK PIN	1	PZ	VM2474A0	BL SP INT GLASS HINGE UPPER LOCK PIN	1	PZ	VM2474A0	BL SP INT GLASS HINGE UPPER LOCK PIN	1	PZ	VM2479A0	BL SP GLASS H6 PUSHING BRACKET	4	PZ	VM2479A0	BL SP GLASS H6 PUSHING BRACKET	4	PZ	VM2489A0	SP HANDLE END KIT + STYLUS KIT	1	PZ	VM2504A0	DOWEL TO GUIDE SLIDE SPRING SHOP.PRO	2	PZ
Code	Description	Qty	UOM																																																														
VM2470A0	SLIDE TO FIX INTERNAL GLASS SHOP.PRO	2	PZ																																																														
VM2470A0	SLIDE TO FIX INTERNAL GLASS SHOP.PRO	2	PZ																																																														
VM2471A0	BL SP LOWER CLAMP INT LOCK GLASS SLIDER	1	PZ																																																														
VM2471A0	BL SP LOWER CLAMP INT LOCK GLASS SLIDER	1	PZ																																																														
VM2472A0	BL SP UPPER CLAMP INT LOCK GLASS SLIDER	1	PZ																																																														
VM2472A0	BL SP UPPER CLAMP INT LOCK GLASS SLIDER	1	PZ																																																														
VM2473A0	BL SP INT GLASS HINGE LOWER LOCK PIN	1	PZ																																																														
VM2473A0	BL SP INT GLASS HINGE LOWER LOCK PIN	1	PZ																																																														
VM2474A0	BL SP INT GLASS HINGE UPPER LOCK PIN	1	PZ																																																														
VM2474A0	BL SP INT GLASS HINGE UPPER LOCK PIN	1	PZ																																																														
VM2479A0	BL SP GLASS H6 PUSHING BRACKET	4	PZ																																																														
VM2479A0	BL SP GLASS H6 PUSHING BRACKET	4	PZ																																																														
VM2489A0	SP HANDLE END KIT + STYLUS KIT	1	PZ																																																														
VM2504A0	DOWEL TO GUIDE SLIDE SPRING SHOP.PRO	2	PZ																																																														



COMPONENT			SPARE PART																																																											
Code	Description	Image	Code	Description	Components list																																																									
VT1325A	SP ELENA 557X364X4 EXTERNAL GLASS		KDR1289A	BL SHOP.PRO ELENA EXTERNAL LEFT DOOR KIT	<table border="1"> <thead> <tr> <th>Code</th> <th>Description</th> <th>Qty</th> <th>UOM</th> </tr> </thead> <tbody> <tr> <td>VM2504A0</td> <td>DOWEL TO GUIDE SLIDE SPRING SHOP.PRO</td> <td>2</td> <td>PZ</td> </tr> <tr> <td>VM2527A0</td> <td>STYLUS PEN FOR SP</td> <td>1</td> <td>PZ</td> </tr> <tr> <td>VT1325A0</td> <td>SP ELENA 557X364X4 EXTERNAL GLASS</td> <td>1</td> <td>PZ</td> </tr> <tr> <td>VT1325A0</td> <td>SP ELENA 557X364X4 EXTERNAL GLASS</td> <td>1</td> <td>PZ</td> </tr> </tbody> </table>	Code	Description	Qty	UOM	VM2504A0	DOWEL TO GUIDE SLIDE SPRING SHOP.PRO	2	PZ	VM2527A0	STYLUS PEN FOR SP	1	PZ	VT1325A0	SP ELENA 557X364X4 EXTERNAL GLASS	1	PZ	VT1325A0	SP ELENA 557X364X4 EXTERNAL GLASS	1	PZ																																					
			Code	Description	Qty	UOM																																																								
VM2504A0	DOWEL TO GUIDE SLIDE SPRING SHOP.PRO	2	PZ																																																											
VM2527A0	STYLUS PEN FOR SP	1	PZ																																																											
VT1325A0	SP ELENA 557X364X4 EXTERNAL GLASS	1	PZ																																																											
VT1325A0	SP ELENA 557X364X4 EXTERNAL GLASS	1	PZ																																																											
KDR1288A	BL SHOP.PRO ELENA EXTERNAL DOOR KIT	<table border="1"> <thead> <tr> <th>Code</th> <th>Description</th> <th>Qty</th> <th>UOM</th> </tr> </thead> <tbody> <tr> <td>OB1293A0</td> <td></td> <td>1</td> <td>PZ</td> </tr> <tr> <td>OB1294A0</td> <td></td> <td>1</td> <td>PZ</td> </tr> <tr> <td>OB1295B0</td> <td></td> <td>1</td> <td>PZ</td> </tr> <tr> <td>OB1296B0</td> <td></td> <td>1</td> <td>PZ</td> </tr> <tr> <td>CR1040A0</td> <td>DOOR LATCH FOR EL.MECH. LOCKING SYSTEM</td> <td>1</td> <td>PZ</td> </tr> <tr> <td>ED1240A0</td> <td>TECHNICAL DATA LABEL</td> <td>1</td> <td>PZ</td> </tr> <tr> <td>IP1325B0</td> <td>POLYSTYREN E CORNER PACKING D20</td> <td>0.650</td> <td>PZ</td> </tr> <tr> <td>IP1385A1</td> <td>CORNER POLYSTYREN E PACKING 110X80X2000</td> <td>0.400</td> <td>M</td> </tr> <tr> <td>IP1508A1</td> <td>POLYSTYREN E U SHAPED PROFILE 2000X60X60</td> <td>1.200</td> <td>M</td> </tr> <tr> <td>ML1005A0</td> <td>DES DF0.6 H18 COMPRESSIO N SPRING</td> <td>2</td> <td>PZ</td> </tr> <tr> <td>SL1155A1</td> <td>LOCTITE BICOMPONEN T SILICON</td> <td>14</td> <td>ML</td> </tr> <tr> <td>TB1563A0</td> <td>DOOR LATERAL BEAM SP800</td> <td>2</td> <td>PZ</td> </tr> <tr> <td>TB3303A0</td> <td>SHOP.PRO STE-ELE FLAG DOOR HANDLE TUBE</td> <td>1</td> <td>PZ</td> </tr> <tr> <td>VI1036A0</td> <td>ST STEEL STRIPED THREAD INSERT M10 FTT/C</td> <td>1</td> <td>PZ</td> </tr> </tbody> </table>	Code	Description	Qty	UOM	OB1293A0		1	PZ	OB1294A0		1	PZ	OB1295B0		1	PZ	OB1296B0		1	PZ	CR1040A0	DOOR LATCH FOR EL.MECH. LOCKING SYSTEM	1	PZ	ED1240A0	TECHNICAL DATA LABEL	1	PZ	IP1325B0	POLYSTYREN E CORNER PACKING D20	0.650	PZ	IP1385A1	CORNER POLYSTYREN E PACKING 110X80X2000	0.400	M	IP1508A1	POLYSTYREN E U SHAPED PROFILE 2000X60X60	1.200	M	ML1005A0	DES DF0.6 H18 COMPRESSIO N SPRING	2	PZ	SL1155A1	LOCTITE BICOMPONEN T SILICON	14	ML	TB1563A0	DOOR LATERAL BEAM SP800	2	PZ	TB3303A0	SHOP.PRO STE-ELE FLAG DOOR HANDLE TUBE	1	PZ	VI1036A0	ST STEEL STRIPED THREAD INSERT M10 FTT/C	1	PZ
Code	Description	Qty	UOM																																																											
OB1293A0		1	PZ																																																											
OB1294A0		1	PZ																																																											
OB1295B0		1	PZ																																																											
OB1296B0		1	PZ																																																											
CR1040A0	DOOR LATCH FOR EL.MECH. LOCKING SYSTEM	1	PZ																																																											
ED1240A0	TECHNICAL DATA LABEL	1	PZ																																																											
IP1325B0	POLYSTYREN E CORNER PACKING D20	0.650	PZ																																																											
IP1385A1	CORNER POLYSTYREN E PACKING 110X80X2000	0.400	M																																																											
IP1508A1	POLYSTYREN E U SHAPED PROFILE 2000X60X60	1.200	M																																																											
ML1005A0	DES DF0.6 H18 COMPRESSIO N SPRING	2	PZ																																																											
SL1155A1	LOCTITE BICOMPONEN T SILICON	14	ML																																																											
TB1563A0	DOOR LATERAL BEAM SP800	2	PZ																																																											
TB3303A0	SHOP.PRO STE-ELE FLAG DOOR HANDLE TUBE	1	PZ																																																											
VI1036A0	ST STEEL STRIPED THREAD INSERT M10 FTT/C	1	PZ																																																											

COMPONENT			SPARE PART																																																																						
Code	Description	Image	Code	Description	Components list																																																																				
VT1325A	SP ELENA 557X364X4 EXTERNAL GLASS		KDR1288A	BL SHOP.PRO ELENA EXTERNAL DOOR KIT	<table border="1"> <thead> <tr> <th>Code</th> <th>Description</th> <th>Qty</th> <th>UOM</th> </tr> </thead> <tbody> <tr> <td>VI1220A1</td> <td>4,2X12 TCB SELF-TAPPIN G SCREW</td> <td>12</td> <td>PZ</td> </tr> <tr> <td>VI1930A0</td> <td>5X25 ST. STEEL SCREW CHIP</td> <td>22</td> <td>PZ</td> </tr> <tr> <td>VI1998A0</td> <td>ZINC PLATED SCREW 5X30 TCB</td> <td>2</td> <td>PZ</td> </tr> <tr> <td>VM1059A1</td> <td>HEAT SHRINK FILM H800</td> <td>1.200</td> <td>M</td> </tr> <tr> <td>VM1209A0</td> <td>SHOP.PRO LOCK PIN WASHER</td> <td>1</td> <td>PZ</td> </tr> <tr> <td>VM1630A0</td> <td>INTERNAL GLASS PUSHING CAP</td> <td>4</td> <td>PZ</td> </tr> <tr> <td>VM1630A1</td> <td>INTERNAL GLASS PUSHING CAP</td> <td>4</td> <td>PZ</td> </tr> <tr> <td>VM2274A0</td> <td>GROOVED BUSHING</td> <td>1</td> <td>PZ</td> </tr> <tr> <td>VM2275A0</td> <td>SMOOTH BUSHING</td> <td>1</td> <td>PZ</td> </tr> <tr> <td>VM2456A0</td> <td>BAKERLUX SHOP.PRO HANDLE END</td> <td>2</td> <td>PZ</td> </tr> <tr> <td>VM2456A0</td> <td>BAKERLUX SHOP.PRO HANDLE END</td> <td>2</td> <td>PZ</td> </tr> <tr> <td>VM2465A0</td> <td>SP SIDE-OPENIN G DOOR RIGHT LOWER CAP KIT</td> <td>1</td> <td>PZ</td> </tr> <tr> <td>VM2465A0</td> <td>SP SIDE-OPENIN G DOOR RIGHT LOWER CAP KIT</td> <td>1</td> <td>PZ</td> </tr> <tr> <td>VM2466A0</td> <td>BL SP LEFT LOWER LATERAL DOOR CAP</td> <td>1</td> <td>PZ</td> </tr> <tr> <td>VM2466A0</td> <td>BL SP LEFT LOWER LATERAL DOOR CAP</td> <td>1</td> <td>PZ</td> </tr> <tr> <td>VM2467A0</td> <td>SP SIDE-OPENIN G DOOR RIGHT UPPER CAP KIT</td> <td>1</td> <td>PZ</td> </tr> </tbody> </table>	Code	Description	Qty	UOM	VI1220A1	4,2X12 TCB SELF-TAPPIN G SCREW	12	PZ	VI1930A0	5X25 ST. STEEL SCREW CHIP	22	PZ	VI1998A0	ZINC PLATED SCREW 5X30 TCB	2	PZ	VM1059A1	HEAT SHRINK FILM H800	1.200	M	VM1209A0	SHOP.PRO LOCK PIN WASHER	1	PZ	VM1630A0	INTERNAL GLASS PUSHING CAP	4	PZ	VM1630A1	INTERNAL GLASS PUSHING CAP	4	PZ	VM2274A0	GROOVED BUSHING	1	PZ	VM2275A0	SMOOTH BUSHING	1	PZ	VM2456A0	BAKERLUX SHOP.PRO HANDLE END	2	PZ	VM2456A0	BAKERLUX SHOP.PRO HANDLE END	2	PZ	VM2465A0	SP SIDE-OPENIN G DOOR RIGHT LOWER CAP KIT	1	PZ	VM2465A0	SP SIDE-OPENIN G DOOR RIGHT LOWER CAP KIT	1	PZ	VM2466A0	BL SP LEFT LOWER LATERAL DOOR CAP	1	PZ	VM2466A0	BL SP LEFT LOWER LATERAL DOOR CAP	1	PZ	VM2467A0	SP SIDE-OPENIN G DOOR RIGHT UPPER CAP KIT	1	PZ
Code	Description	Qty	UOM																																																																						
VI1220A1	4,2X12 TCB SELF-TAPPIN G SCREW	12	PZ																																																																						
VI1930A0	5X25 ST. STEEL SCREW CHIP	22	PZ																																																																						
VI1998A0	ZINC PLATED SCREW 5X30 TCB	2	PZ																																																																						
VM1059A1	HEAT SHRINK FILM H800	1.200	M																																																																						
VM1209A0	SHOP.PRO LOCK PIN WASHER	1	PZ																																																																						
VM1630A0	INTERNAL GLASS PUSHING CAP	4	PZ																																																																						
VM1630A1	INTERNAL GLASS PUSHING CAP	4	PZ																																																																						
VM2274A0	GROOVED BUSHING	1	PZ																																																																						
VM2275A0	SMOOTH BUSHING	1	PZ																																																																						
VM2456A0	BAKERLUX SHOP.PRO HANDLE END	2	PZ																																																																						
VM2456A0	BAKERLUX SHOP.PRO HANDLE END	2	PZ																																																																						
VM2465A0	SP SIDE-OPENIN G DOOR RIGHT LOWER CAP KIT	1	PZ																																																																						
VM2465A0	SP SIDE-OPENIN G DOOR RIGHT LOWER CAP KIT	1	PZ																																																																						
VM2466A0	BL SP LEFT LOWER LATERAL DOOR CAP	1	PZ																																																																						
VM2466A0	BL SP LEFT LOWER LATERAL DOOR CAP	1	PZ																																																																						
VM2467A0	SP SIDE-OPENIN G DOOR RIGHT UPPER CAP KIT	1	PZ																																																																						



COMPONENT			SPARE PART																																																										
Code	Description	Image	Code	Description	Components list																																																								
VT1325A	SP ELENA 557X364X4 EXTERNAL GLASS		KDR1288A	BL SHOP.PRO ELENA EXTERNAL DOOR KIT	<table border="1"> <thead> <tr> <th>Code</th> <th>Description</th> <th>Qty</th> <th>UOM</th> </tr> </thead> <tbody> <tr> <td>VM2467A0</td> <td>SP SIDE-OPENING G DOOR RIGHT UPPER CAP KIT</td> <td>1</td> <td>PZ</td> </tr> <tr> <td>VM2468A0</td> <td>BL SP LEFT UPPER LATERAL DOOR CAP</td> <td>1</td> <td>PZ</td> </tr> <tr> <td>VM2468A0</td> <td>BL SP LEFT UPPER LATERAL DOOR CAP</td> <td>1</td> <td>PZ</td> </tr> <tr> <td>VM2470A0</td> <td>SLIDE TO FIX INTERNAL GLASS SHOP.PRO</td> <td>2</td> <td>PZ</td> </tr> <tr> <td>VM2470A0</td> <td>SLIDE TO FIX INTERNAL GLASS SHOP.PRO</td> <td>2</td> <td>PZ</td> </tr> <tr> <td>VM2471A0</td> <td>BL SP LOWER CLAMP INT LOCK GLASS SLIDER</td> <td>1</td> <td>PZ</td> </tr> <tr> <td>VM2471A0</td> <td>BL SP LOWER CLAMP INT LOCK GLASS SLIDER</td> <td>1</td> <td>PZ</td> </tr> <tr> <td>VM2472A0</td> <td>BL SP UPPER CLAMP INT LOCK GLASS SLIDER</td> <td>1</td> <td>PZ</td> </tr> <tr> <td>VM2472A0</td> <td>BL SP UPPER CLAMP INT LOCK GLASS SLIDER</td> <td>1</td> <td>PZ</td> </tr> <tr> <td>VM2473A0</td> <td>BL SP INT GLASS HINGE LOWER LOCK PIN</td> <td>1</td> <td>PZ</td> </tr> <tr> <td>VM2473A0</td> <td>BL SP INT GLASS HINGE LOWER LOCK PIN</td> <td>1</td> <td>PZ</td> </tr> <tr> <td>VM2474A0</td> <td>BL SP INT GLASS HINGE UPPER LOCK PIN</td> <td>1</td> <td>PZ</td> </tr> <tr> <td>VM2474A0</td> <td>BL SP INT GLASS HINGE UPPER LOCK PIN</td> <td>1</td> <td>PZ</td> </tr> </tbody> </table>	Code	Description	Qty	UOM	VM2467A0	SP SIDE-OPENING G DOOR RIGHT UPPER CAP KIT	1	PZ	VM2468A0	BL SP LEFT UPPER LATERAL DOOR CAP	1	PZ	VM2468A0	BL SP LEFT UPPER LATERAL DOOR CAP	1	PZ	VM2470A0	SLIDE TO FIX INTERNAL GLASS SHOP.PRO	2	PZ	VM2470A0	SLIDE TO FIX INTERNAL GLASS SHOP.PRO	2	PZ	VM2471A0	BL SP LOWER CLAMP INT LOCK GLASS SLIDER	1	PZ	VM2471A0	BL SP LOWER CLAMP INT LOCK GLASS SLIDER	1	PZ	VM2472A0	BL SP UPPER CLAMP INT LOCK GLASS SLIDER	1	PZ	VM2472A0	BL SP UPPER CLAMP INT LOCK GLASS SLIDER	1	PZ	VM2473A0	BL SP INT GLASS HINGE LOWER LOCK PIN	1	PZ	VM2473A0	BL SP INT GLASS HINGE LOWER LOCK PIN	1	PZ	VM2474A0	BL SP INT GLASS HINGE UPPER LOCK PIN	1	PZ	VM2474A0	BL SP INT GLASS HINGE UPPER LOCK PIN	1	PZ
Code	Description	Qty	UOM																																																										
VM2467A0	SP SIDE-OPENING G DOOR RIGHT UPPER CAP KIT	1	PZ																																																										
VM2468A0	BL SP LEFT UPPER LATERAL DOOR CAP	1	PZ																																																										
VM2468A0	BL SP LEFT UPPER LATERAL DOOR CAP	1	PZ																																																										
VM2470A0	SLIDE TO FIX INTERNAL GLASS SHOP.PRO	2	PZ																																																										
VM2470A0	SLIDE TO FIX INTERNAL GLASS SHOP.PRO	2	PZ																																																										
VM2471A0	BL SP LOWER CLAMP INT LOCK GLASS SLIDER	1	PZ																																																										
VM2471A0	BL SP LOWER CLAMP INT LOCK GLASS SLIDER	1	PZ																																																										
VM2472A0	BL SP UPPER CLAMP INT LOCK GLASS SLIDER	1	PZ																																																										
VM2472A0	BL SP UPPER CLAMP INT LOCK GLASS SLIDER	1	PZ																																																										
VM2473A0	BL SP INT GLASS HINGE LOWER LOCK PIN	1	PZ																																																										
VM2473A0	BL SP INT GLASS HINGE LOWER LOCK PIN	1	PZ																																																										
VM2474A0	BL SP INT GLASS HINGE UPPER LOCK PIN	1	PZ																																																										
VM2474A0	BL SP INT GLASS HINGE UPPER LOCK PIN	1	PZ																																																										







COMPONENT			SPARE PART																																											
Code	Description	Image	Code	Description	Components list																																									
VT1325A	SP ELENA 557X364X4 EXTERNAL GLASS		KDR1288A	BL SHOP.PRO ELENA EXTERNAL DOOR KIT	<table border="1"> <thead> <tr> <th>Code</th> <th>Description</th> <th>Qty</th> <th>UOM</th> </tr> </thead> <tbody> <tr> <td>VM2479A0</td> <td>BL SP GLASS H6 PUSHING BRACKET</td> <td>4</td> <td>PZ</td> </tr> <tr> <td>VM2479A0</td> <td>BL SP GLASS H6 PUSHING BRACKET</td> <td>4</td> <td>PZ</td> </tr> <tr> <td>VM2489A0</td> <td>SP HANDLE END KIT + STYLUS KIT</td> <td>1</td> <td>PZ</td> </tr> <tr> <td>VM2504A0</td> <td>DOWEL TO GUIDE SLIDE SPRING SHOP.PRO</td> <td>2</td> <td>PZ</td> </tr> <tr> <td>VM2504A0</td> <td>DOWEL TO GUIDE SLIDE SPRING SHOP.PRO</td> <td>2</td> <td>PZ</td> </tr> <tr> <td>VM2527A0</td> <td>STYLUS PEN FOR SP</td> <td>1</td> <td>PZ</td> </tr> <tr> <td>VT1325A0</td> <td>SP ELENA 557X364X4 EXTERNAL GLASS</td> <td>1</td> <td>PZ</td> </tr> <tr> <td>VT1325A0</td> <td>SP ELENA 557X364X4 EXTERNAL GLASS</td> <td>1</td> <td>PZ</td> </tr> </tbody> </table>	Code	Description	Qty	UOM	VM2479A0	BL SP GLASS H6 PUSHING BRACKET	4	PZ	VM2479A0	BL SP GLASS H6 PUSHING BRACKET	4	PZ	VM2489A0	SP HANDLE END KIT + STYLUS KIT	1	PZ	VM2504A0	DOWEL TO GUIDE SLIDE SPRING SHOP.PRO	2	PZ	VM2504A0	DOWEL TO GUIDE SLIDE SPRING SHOP.PRO	2	PZ	VM2527A0	STYLUS PEN FOR SP	1	PZ	VT1325A0	SP ELENA 557X364X4 EXTERNAL GLASS	1	PZ	VT1325A0	SP ELENA 557X364X4 EXTERNAL GLASS	1	PZ					
			Code	Description	Qty	UOM																																								
VM2479A0	BL SP GLASS H6 PUSHING BRACKET	4	PZ																																											
VM2479A0	BL SP GLASS H6 PUSHING BRACKET	4	PZ																																											
VM2489A0	SP HANDLE END KIT + STYLUS KIT	1	PZ																																											
VM2504A0	DOWEL TO GUIDE SLIDE SPRING SHOP.PRO	2	PZ																																											
VM2504A0	DOWEL TO GUIDE SLIDE SPRING SHOP.PRO	2	PZ																																											
VM2527A0	STYLUS PEN FOR SP	1	PZ																																											
VT1325A0	SP ELENA 557X364X4 EXTERNAL GLASS	1	PZ																																											
VT1325A0	SP ELENA 557X364X4 EXTERNAL GLASS	1	PZ																																											
KDR1282A	BL SHOP.PRO ELENA COMPLETE DOOR KIT	<table border="1"> <thead> <tr> <th>Code</th> <th>Description</th> <th>Qty</th> <th>UOM</th> </tr> </thead> <tbody> <tr> <td>OB1285A0</td> <td></td> <td>1</td> <td>PZ</td> </tr> <tr> <td>OB1286A0</td> <td></td> <td>1</td> <td>PZ</td> </tr> <tr> <td>OB1287A0</td> <td></td> <td>1</td> <td>PZ</td> </tr> <tr> <td>OB1288A0</td> <td></td> <td>1</td> <td>PZ</td> </tr> <tr> <td>CR1112A0</td> <td>BLSP ARIANNA-ELE NA DROPDOWN DOOR HINGE</td> <td>2</td> <td>PZ</td> </tr> <tr> <td>IP1508A1</td> <td>POLYSTYREN E U SHAPED PROFILE 2000X60X60</td> <td>1.500</td> <td>M</td> </tr> <tr> <td>LP1050A0</td> <td>BL SHOP.PRO L180 COMPLETE LED BAR</td> <td>1</td> <td>PZ</td> </tr> <tr> <td>SL1155A1</td> <td>LOCTITE BICOMPONEN T SILICON</td> <td>14</td> <td>ML</td> </tr> <tr> <td>TB1563A0</td> <td>DOOR LATERAL BEAM SP800</td> <td>1</td> <td>PZ</td> </tr> <tr> <td>TB3302A0</td> <td></td> <td>1</td> <td>PZ</td> </tr> </tbody> </table>	Code	Description	Qty	UOM	OB1285A0		1	PZ	OB1286A0		1	PZ	OB1287A0		1	PZ	OB1288A0		1	PZ	CR1112A0	BLSP ARIANNA-ELE NA DROPDOWN DOOR HINGE	2	PZ	IP1508A1	POLYSTYREN E U SHAPED PROFILE 2000X60X60	1.500	M	LP1050A0	BL SHOP.PRO L180 COMPLETE LED BAR	1	PZ	SL1155A1	LOCTITE BICOMPONEN T SILICON	14	ML	TB1563A0	DOOR LATERAL BEAM SP800	1	PZ	TB3302A0		1	PZ
Code	Description	Qty	UOM																																											
OB1285A0		1	PZ																																											
OB1286A0		1	PZ																																											
OB1287A0		1	PZ																																											
OB1288A0		1	PZ																																											
CR1112A0	BLSP ARIANNA-ELE NA DROPDOWN DOOR HINGE	2	PZ																																											
IP1508A1	POLYSTYREN E U SHAPED PROFILE 2000X60X60	1.500	M																																											
LP1050A0	BL SHOP.PRO L180 COMPLETE LED BAR	1	PZ																																											
SL1155A1	LOCTITE BICOMPONEN T SILICON	14	ML																																											
TB1563A0	DOOR LATERAL BEAM SP800	1	PZ																																											
TB3302A0		1	PZ																																											





COMPONENT			SPARE PART																																																																							
Code	Description	Image	Code	Description	Components list																																																																					
VT1325A	SP ELENA 557X364X4 EXTERNAL GLASS		KDR1282A	BL SHOP.PRO ELENA COMPLETE DOOR KIT	<table border="1"> <thead> <tr> <th>Code</th> <th>Description</th> <th>Qty</th> <th>UOM</th> </tr> </thead> <tbody> <tr> <td>VI1014A0</td> <td>STAINLESS STEEL WASHER 4.5X9X0.8</td> <td>1</td> <td>PZ</td> </tr> <tr> <td>VI1220A1</td> <td>4,2X12 TCB SELF-TAPPIN G SCREW</td> <td>10</td> <td>PZ</td> </tr> <tr> <td>VI1875A0</td> <td>SCREW M5X10 TC1/2T INOX</td> <td>6</td> <td>PZ</td> </tr> <tr> <td>VI1930A0</td> <td>5X25 ST. STEEL SCREW CHIP</td> <td>12</td> <td>PZ</td> </tr> <tr> <td>VI1998A0</td> <td>ZINC PLATED SCREW 5X30 TCB</td> <td>2</td> <td>PZ</td> </tr> <tr> <td>VM1059A1</td> <td>HEAT SHRINK FILM H800</td> <td>0.700</td> <td>M</td> </tr> <tr> <td>VM1630A0</td> <td>INTERNAL GLASS PUSHING CAP</td> <td>1</td> <td>PZ</td> </tr> <tr> <td>VM1630A1</td> <td>INTERNAL GLASS PUSHING CAP</td> <td>1</td> <td>PZ</td> </tr> <tr> <td>VM2456A0</td> <td>BAKERLUX SHOP.PRO HANDLE END</td> <td>2</td> <td>PZ</td> </tr> <tr> <td>VM2456A0</td> <td>BAKERLUX SHOP.PRO HANDLE END</td> <td>2</td> <td>PZ</td> </tr> <tr> <td>VM2461A0</td> <td>BL SP RIGHT LOWER DROPDOWN DOOR CAP KIT</td> <td>1</td> <td>PZ</td> </tr> <tr> <td>VM2461A0</td> <td>BL SP RIGHT LOWER DROPDOWN DOOR CAP KIT</td> <td>1</td> <td>PZ</td> </tr> <tr> <td>VM2462A0</td> <td>BL SP LEFT LOWER DROPDOWN DOOR CAP</td> <td>1</td> <td>PZ</td> </tr> <tr> <td>VM2462A0</td> <td>BL SP LEFT LOWER DROPDOWN DOOR CAP</td> <td>1</td> <td>PZ</td> </tr> <tr> <td>VM2463A0</td> <td>SHOP.PRO RIGHT UPPER CAP DROP DOWN DOOR</td> <td>1</td> <td>PZ</td> </tr> <tr> <td>VM2463A0</td> <td>SHOP.PRO RIGHT UPPER CAP DROP DOWN DOOR</td> <td>1</td> <td>PZ</td> </tr> </tbody> </table>		Code	Description	Qty	UOM	VI1014A0	STAINLESS STEEL WASHER 4.5X9X0.8	1	PZ	VI1220A1	4,2X12 TCB SELF-TAPPIN G SCREW	10	PZ	VI1875A0	SCREW M5X10 TC1/2T INOX	6	PZ	VI1930A0	5X25 ST. STEEL SCREW CHIP	12	PZ	VI1998A0	ZINC PLATED SCREW 5X30 TCB	2	PZ	VM1059A1	HEAT SHRINK FILM H800	0.700	M	VM1630A0	INTERNAL GLASS PUSHING CAP	1	PZ	VM1630A1	INTERNAL GLASS PUSHING CAP	1	PZ	VM2456A0	BAKERLUX SHOP.PRO HANDLE END	2	PZ	VM2456A0	BAKERLUX SHOP.PRO HANDLE END	2	PZ	VM2461A0	BL SP RIGHT LOWER DROPDOWN DOOR CAP KIT	1	PZ	VM2461A0	BL SP RIGHT LOWER DROPDOWN DOOR CAP KIT	1	PZ	VM2462A0	BL SP LEFT LOWER DROPDOWN DOOR CAP	1	PZ	VM2462A0	BL SP LEFT LOWER DROPDOWN DOOR CAP	1	PZ	VM2463A0	SHOP.PRO RIGHT UPPER CAP DROP DOWN DOOR	1	PZ	VM2463A0	SHOP.PRO RIGHT UPPER CAP DROP DOWN DOOR	1	PZ
Code	Description	Qty	UOM																																																																							
VI1014A0	STAINLESS STEEL WASHER 4.5X9X0.8	1	PZ																																																																							
VI1220A1	4,2X12 TCB SELF-TAPPIN G SCREW	10	PZ																																																																							
VI1875A0	SCREW M5X10 TC1/2T INOX	6	PZ																																																																							
VI1930A0	5X25 ST. STEEL SCREW CHIP	12	PZ																																																																							
VI1998A0	ZINC PLATED SCREW 5X30 TCB	2	PZ																																																																							
VM1059A1	HEAT SHRINK FILM H800	0.700	M																																																																							
VM1630A0	INTERNAL GLASS PUSHING CAP	1	PZ																																																																							
VM1630A1	INTERNAL GLASS PUSHING CAP	1	PZ																																																																							
VM2456A0	BAKERLUX SHOP.PRO HANDLE END	2	PZ																																																																							
VM2456A0	BAKERLUX SHOP.PRO HANDLE END	2	PZ																																																																							
VM2461A0	BL SP RIGHT LOWER DROPDOWN DOOR CAP KIT	1	PZ																																																																							
VM2461A0	BL SP RIGHT LOWER DROPDOWN DOOR CAP KIT	1	PZ																																																																							
VM2462A0	BL SP LEFT LOWER DROPDOWN DOOR CAP	1	PZ																																																																							
VM2462A0	BL SP LEFT LOWER DROPDOWN DOOR CAP	1	PZ																																																																							
VM2463A0	SHOP.PRO RIGHT UPPER CAP DROP DOWN DOOR	1	PZ																																																																							
VM2463A0	SHOP.PRO RIGHT UPPER CAP DROP DOWN DOOR	1	PZ																																																																							



COMPONENT			SPARE PART																																																																		
Code	Description	Image	Code	Description	Components list																																																																
VT1325A	SP ELENA 557X364X4 EXTERNAL GLASS		KDR1282A	BL SHOP.PRO ELENA COMPLETE DOOR KIT	<table border="1"> <thead> <tr> <th>Code</th> <th>Description</th> <th>Qty</th> <th>UOM</th> </tr> </thead> <tbody> <tr> <td>VM2464A0</td> <td>SHOP.PRO LEFT UPPER CAP DROP DOWN DOOR</td> <td>1</td> <td>PZ</td> </tr> <tr> <td>VM2464A0</td> <td>SHOP.PRO LEFT UPPER CAP DROP DOWN DOOR</td> <td>1</td> <td>PZ</td> </tr> <tr> <td>VM2471A0</td> <td>BL SP LOWER CLAMP INT LOCK GLASS SLIDER</td> <td>1</td> <td>PZ</td> </tr> <tr> <td>VM2471A0</td> <td>BL SP LOWER CLAMP INT LOCK GLASS SLIDER</td> <td>1</td> <td>PZ</td> </tr> <tr> <td>VM2472A0</td> <td>BL SP UPPER CLAMP INT LOCK GLASS SLIDER</td> <td>1</td> <td>PZ</td> </tr> <tr> <td>VM2472A0</td> <td>BL SP UPPER CLAMP INT LOCK GLASS SLIDER</td> <td>1</td> <td>PZ</td> </tr> <tr> <td>VM2479A0</td> <td>BL SP GLASS H6 PUSHING BRACKET</td> <td>1</td> <td>PZ</td> </tr> <tr> <td>VM2479A0</td> <td>BL SP GLASS H6 PUSHING BRACKET</td> <td>1</td> <td>PZ</td> </tr> <tr> <td>VM2489A0</td> <td>SP HANDLE END KIT + STYLUS KIT</td> <td>1</td> <td>PZ</td> </tr> <tr> <td>VM2503A0</td> <td>SLIDE TO FIX INTERNAL NON REMOV GLASS SP</td> <td>2</td> <td>PZ</td> </tr> <tr> <td>VM2503A0</td> <td>SLIDE TO FIX INTERNAL NON REMOV GLASS SP</td> <td>2</td> <td>PZ</td> </tr> <tr> <td>VM2512A0</td> <td>BL SP DOOR-MICRO SWITCH SOFT CLOSING</td> <td>1</td> <td>PZ</td> </tr> <tr> <td>VM2512A0</td> <td>BL SP DOOR-MICRO SWITCH SOFT CLOSING</td> <td>1</td> <td>PZ</td> </tr> <tr> <td>VM2527A0</td> <td>STYLUS PEN FOR SP</td> <td>1</td> <td>PZ</td> </tr> <tr> <td>VT1325A0</td> <td>SP ELENA 557X364X4 EXTERNAL GLASS</td> <td>1</td> <td>PZ</td> </tr> </tbody> </table>	Code	Description	Qty	UOM	VM2464A0	SHOP.PRO LEFT UPPER CAP DROP DOWN DOOR	1	PZ	VM2464A0	SHOP.PRO LEFT UPPER CAP DROP DOWN DOOR	1	PZ	VM2471A0	BL SP LOWER CLAMP INT LOCK GLASS SLIDER	1	PZ	VM2471A0	BL SP LOWER CLAMP INT LOCK GLASS SLIDER	1	PZ	VM2472A0	BL SP UPPER CLAMP INT LOCK GLASS SLIDER	1	PZ	VM2472A0	BL SP UPPER CLAMP INT LOCK GLASS SLIDER	1	PZ	VM2479A0	BL SP GLASS H6 PUSHING BRACKET	1	PZ	VM2479A0	BL SP GLASS H6 PUSHING BRACKET	1	PZ	VM2489A0	SP HANDLE END KIT + STYLUS KIT	1	PZ	VM2503A0	SLIDE TO FIX INTERNAL NON REMOV GLASS SP	2	PZ	VM2503A0	SLIDE TO FIX INTERNAL NON REMOV GLASS SP	2	PZ	VM2512A0	BL SP DOOR-MICRO SWITCH SOFT CLOSING	1	PZ	VM2512A0	BL SP DOOR-MICRO SWITCH SOFT CLOSING	1	PZ	VM2527A0	STYLUS PEN FOR SP	1	PZ	VT1325A0	SP ELENA 557X364X4 EXTERNAL GLASS	1	PZ
Code	Description	Qty	UOM																																																																		
VM2464A0	SHOP.PRO LEFT UPPER CAP DROP DOWN DOOR	1	PZ																																																																		
VM2464A0	SHOP.PRO LEFT UPPER CAP DROP DOWN DOOR	1	PZ																																																																		
VM2471A0	BL SP LOWER CLAMP INT LOCK GLASS SLIDER	1	PZ																																																																		
VM2471A0	BL SP LOWER CLAMP INT LOCK GLASS SLIDER	1	PZ																																																																		
VM2472A0	BL SP UPPER CLAMP INT LOCK GLASS SLIDER	1	PZ																																																																		
VM2472A0	BL SP UPPER CLAMP INT LOCK GLASS SLIDER	1	PZ																																																																		
VM2479A0	BL SP GLASS H6 PUSHING BRACKET	1	PZ																																																																		
VM2479A0	BL SP GLASS H6 PUSHING BRACKET	1	PZ																																																																		
VM2489A0	SP HANDLE END KIT + STYLUS KIT	1	PZ																																																																		
VM2503A0	SLIDE TO FIX INTERNAL NON REMOV GLASS SP	2	PZ																																																																		
VM2503A0	SLIDE TO FIX INTERNAL NON REMOV GLASS SP	2	PZ																																																																		
VM2512A0	BL SP DOOR-MICRO SWITCH SOFT CLOSING	1	PZ																																																																		
VM2512A0	BL SP DOOR-MICRO SWITCH SOFT CLOSING	1	PZ																																																																		
VM2527A0	STYLUS PEN FOR SP	1	PZ																																																																		
VT1325A0	SP ELENA 557X364X4 EXTERNAL GLASS	1	PZ																																																																		

COMPONENT			SPARE PART																														
Code	Description	Image	Code	Description	Components list																												
VT1325A	SP ELENA 557X364X4 EXTERNAL GLASS		KDR1282A	BL SHOP.PRO ELENA COMPLETE DOOR KIT	<table border="1"> <thead> <tr> <th>Code</th> <th>Description</th> <th>Qty</th> <th>UOM</th> </tr> </thead> <tbody> <tr> <td>VT1325A0</td> <td>SP ELENA 557X364X4 EXTERNAL GLASS</td> <td>1</td> <td>PZ</td> </tr> <tr> <td>VT1331A0</td> <td>SP ELENA 715X318.5X6 INNER GLASS</td> <td>1</td> <td>PZ</td> </tr> <tr> <td>VT1331A0</td> <td>SP ELENA 715X318.5X6 INNER GLASS</td> <td>1</td> <td>PZ</td> </tr> </tbody> </table>	Code	Description	Qty	UOM	VT1325A0	SP ELENA 557X364X4 EXTERNAL GLASS	1	PZ	VT1331A0	SP ELENA 715X318.5X6 INNER GLASS	1	PZ	VT1331A0	SP ELENA 715X318.5X6 INNER GLASS	1	PZ												
Code	Description	Qty	UOM																														
VT1325A0	SP ELENA 557X364X4 EXTERNAL GLASS	1	PZ																														
VT1331A0	SP ELENA 715X318.5X6 INNER GLASS	1	PZ																														
VT1331A0	SP ELENA 715X318.5X6 INNER GLASS	1	PZ																														
VT1331A	SP ELENA 715X318.5X6 INNER GLASS		KVT1331A	BL SP ELENA DOOR INNER GLASS KIT	<table border="1"> <thead> <tr> <th>Code</th> <th>Description</th> <th>Qty</th> <th>UOM</th> </tr> </thead> <tbody> <tr> <td>IP1508A1</td> <td>POLYSTYREN E U SHAPED PROFILE 2000X60X60</td> <td>1</td> <td>M</td> </tr> <tr> <td>VM1059A1</td> <td>HEAT SHRINK FILM H800</td> <td>1.500</td> <td>M</td> </tr> <tr> <td>VT1331A0</td> <td>SP ELENA 715X318.5X6 INNER GLASS</td> <td>1</td> <td>PZ</td> </tr> <tr> <td>VT1331A0</td> <td>SP ELENA 715X318.5X6 INNER GLASS</td> <td>1</td> <td>PZ</td> </tr> </tbody> </table>	Code	Description	Qty	UOM	IP1508A1	POLYSTYREN E U SHAPED PROFILE 2000X60X60	1	M	VM1059A1	HEAT SHRINK FILM H800	1.500	M	VT1331A0	SP ELENA 715X318.5X6 INNER GLASS	1	PZ	VT1331A0	SP ELENA 715X318.5X6 INNER GLASS	1	PZ								
Code	Description	Qty	UOM																														
IP1508A1	POLYSTYREN E U SHAPED PROFILE 2000X60X60	1	M																														
VM1059A1	HEAT SHRINK FILM H800	1.500	M																														
VT1331A0	SP ELENA 715X318.5X6 INNER GLASS	1	PZ																														
VT1331A0	SP ELENA 715X318.5X6 INNER GLASS	1	PZ																														
VM2456A	BAKERLUX SHOP.PRO HANDLE END		KVM2456A	2 PCS BAKERLUX SHOP.PRO HANDLE END KIT	<table border="1"> <thead> <tr> <th>Code</th> <th>Description</th> <th>Qty</th> <th>UOM</th> </tr> </thead> <tbody> <tr> <td>VI1930A0</td> <td>5X25 ST. STEEL SCREW CHIP</td> <td>4</td> <td>PZ</td> </tr> <tr> <td>VM1224A0</td> <td>65MY 220MM 2 COLOURS SHRINK TUBE</td> <td>0.300</td> <td>M</td> </tr> <tr> <td>VM2456A0</td> <td>BAKERLUX SHOP.PRO HANDLE END</td> <td>2</td> <td>PZ</td> </tr> <tr> <td>VM2456A0</td> <td>BAKERLUX SHOP.PRO HANDLE END</td> <td>2</td> <td>PZ</td> </tr> <tr> <td>VM2489A0</td> <td>SP HANDLE END KIT + STYLUS KIT</td> <td>1</td> <td>PZ</td> </tr> <tr> <td>VM2527A0</td> <td>STYLUS PEN FOR SP</td> <td>1</td> <td>PZ</td> </tr> </tbody> </table>	Code	Description	Qty	UOM	VI1930A0	5X25 ST. STEEL SCREW CHIP	4	PZ	VM1224A0	65MY 220MM 2 COLOURS SHRINK TUBE	0.300	M	VM2456A0	BAKERLUX SHOP.PRO HANDLE END	2	PZ	VM2456A0	BAKERLUX SHOP.PRO HANDLE END	2	PZ	VM2489A0	SP HANDLE END KIT + STYLUS KIT	1	PZ	VM2527A0	STYLUS PEN FOR SP	1	PZ
Code	Description	Qty	UOM																														
VI1930A0	5X25 ST. STEEL SCREW CHIP	4	PZ																														
VM1224A0	65MY 220MM 2 COLOURS SHRINK TUBE	0.300	M																														
VM2456A0	BAKERLUX SHOP.PRO HANDLE END	2	PZ																														
VM2456A0	BAKERLUX SHOP.PRO HANDLE END	2	PZ																														
VM2489A0	SP HANDLE END KIT + STYLUS KIT	1	PZ																														
VM2527A0	STYLUS PEN FOR SP	1	PZ																														
TB3302A			KTB3302A	BL SP 600X400 DROPDOWN HANDLE TUBE KIT	<table border="1"> <thead> <tr> <th>Code</th> <th>Description</th> <th>Qty</th> <th>UOM</th> </tr> </thead> <tbody> <tr> <td>TB3302A0</td> <td></td> <td>1</td> <td>PZ</td> </tr> <tr> <td>VI1930A0</td> <td>5X25 ST. STEEL SCREW CHIP</td> <td>4</td> <td>PZ</td> </tr> <tr> <td>VM2456A0</td> <td>BAKERLUX SHOP.PRO HANDLE END</td> <td>2</td> <td>PZ</td> </tr> <tr> <td>VM2456A0</td> <td>BAKERLUX SHOP.PRO HANDLE END</td> <td>2</td> <td>PZ</td> </tr> </tbody> </table>	Code	Description	Qty	UOM	TB3302A0		1	PZ	VI1930A0	5X25 ST. STEEL SCREW CHIP	4	PZ	VM2456A0	BAKERLUX SHOP.PRO HANDLE END	2	PZ	VM2456A0	BAKERLUX SHOP.PRO HANDLE END	2	PZ								
Code	Description	Qty	UOM																														
TB3302A0		1	PZ																														
VI1930A0	5X25 ST. STEEL SCREW CHIP	4	PZ																														
VM2456A0	BAKERLUX SHOP.PRO HANDLE END	2	PZ																														
VM2456A0	BAKERLUX SHOP.PRO HANDLE END	2	PZ																														

COMPONENT			SPARE PART																						
Code	Description	Image	Code	Description	Components list																				
TB3302A			KTB3302A	BL SP 600X400 DROPDOWN HANDLE TUBE KIT	<table border="1"> <thead> <tr> <th>Code</th> <th>Description</th> <th>Qty</th> <th>UOM</th> </tr> </thead> <tbody> <tr> <td>VM2489A0</td> <td>SP HANDLE END KIT + STYLUS KIT</td> <td>1</td> <td>PZ</td> </tr> <tr> <td>VM2527A0</td> <td>STYLUS PEN FOR SP</td> <td>1</td> <td>PZ</td> </tr> </tbody> </table>	Code	Description	Qty	UOM	VM2489A0	SP HANDLE END KIT + STYLUS KIT	1	PZ	VM2527A0	STYLUS PEN FOR SP	1	PZ								
Code	Description	Qty	UOM																						
VM2489A0	SP HANDLE END KIT + STYLUS KIT	1	PZ																						
VM2527A0	STYLUS PEN FOR SP	1	PZ																						
VM2527A	STYLUS PEN FOR S		KVM2527A	EVEREO-BLSP TOUCH STYLUS 5 PCS KIT	<table border="1"> <thead> <tr> <th>Code</th> <th>Description</th> <th>Qty</th> <th>UOM</th> </tr> </thead> <tbody> <tr> <td>VM1224A0</td> <td>65MY 220MM 2 COLOURS SHRINK TUBE</td> <td>0.150</td> <td>M</td> </tr> <tr> <td>VM2527A0</td> <td>STYLUS PEN FOR SP</td> <td>5</td> <td>PZ</td> </tr> </tbody> </table>	Code	Description	Qty	UOM	VM1224A0	65MY 220MM 2 COLOURS SHRINK TUBE	0.150	M	VM2527A0	STYLUS PEN FOR SP	5	PZ								
Code	Description	Qty	UOM																						
VM1224A0	65MY 220MM 2 COLOURS SHRINK TUBE	0.150	M																						
VM2527A0	STYLUS PEN FOR SP	5	PZ																						
PE2109A	SP TOUCH COMPLETE CONTROL BOARD		KPE2109A	BL SHOP.PRO TOUCH CONTROL BOARD KIT	<table border="1"> <thead> <tr> <th>Code</th> <th>Description</th> <th>Qty</th> <th>UOM</th> </tr> </thead> <tbody> <tr> <td>PE2109A2</td> <td>BL SHOP.PRO TOUCH CONTROL BOARD</td> <td>1</td> <td>PZ</td> </tr> <tr> <td>PE2109A3</td> <td>SP TOUCH COMPLETE CONTROL BOARD</td> <td>1</td> <td>PZ</td> </tr> <tr> <td>VI1930A0</td> <td>5X25 ST. STEEL SCREW CHIP</td> <td>2</td> <td>PZ</td> </tr> <tr> <td>VM2147A0</td> <td>410X343X15 MM PINK SMOOTH ESD SPONGE</td> <td>1</td> <td>PZ</td> </tr> </tbody> </table>	Code	Description	Qty	UOM	PE2109A2	BL SHOP.PRO TOUCH CONTROL BOARD	1	PZ	PE2109A3	SP TOUCH COMPLETE CONTROL BOARD	1	PZ	VI1930A0	5X25 ST. STEEL SCREW CHIP	2	PZ	VM2147A0	410X343X15 MM PINK SMOOTH ESD SPONGE	1	PZ
Code	Description	Qty	UOM																						
PE2109A2	BL SHOP.PRO TOUCH CONTROL BOARD	1	PZ																						
PE2109A3	SP TOUCH COMPLETE CONTROL BOARD	1	PZ																						
VI1930A0	5X25 ST. STEEL SCREW CHIP	2	PZ																						
VM2147A0	410X343X15 MM PINK SMOOTH ESD SPONGE	1	PZ																						



ASM3409A/0.D01 - External cover

FRONT

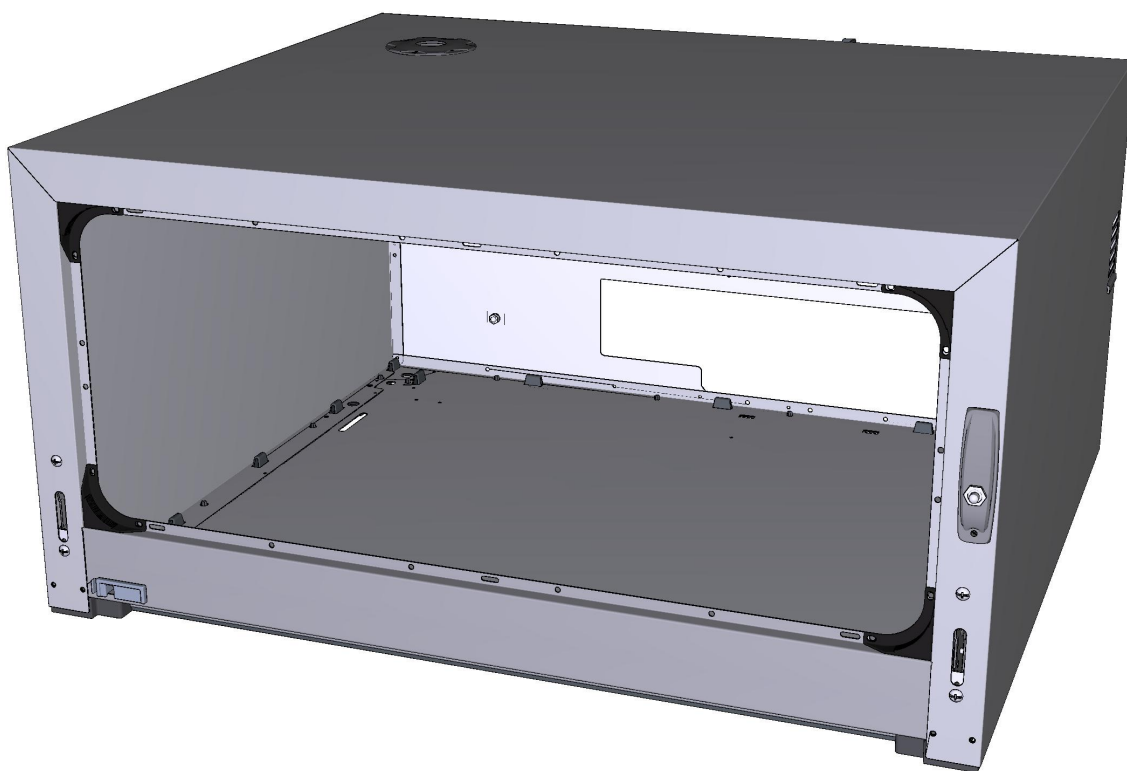



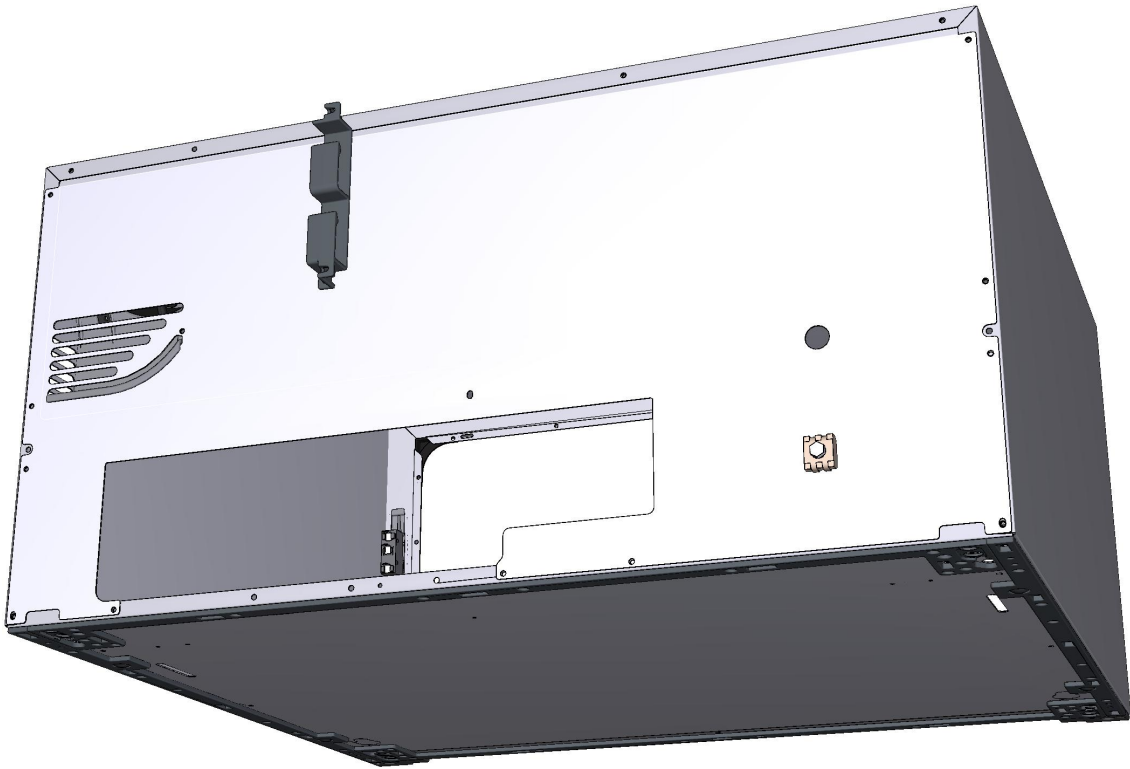

ASM3409A/0.D01 - External cover





REAR





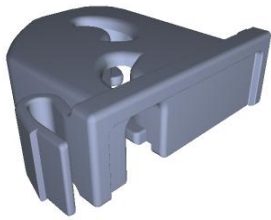

COMPONENT			SPARE PART																		
Code	Description	Image	Code	Description	Components list																
VM1750A	BRASS COMB CLAM		KVM1750A	COMB TERMINAL BLOCK KIT	<table border="1"> <thead> <tr> <th>Code</th> <th>Description</th> <th>Qty</th> <th>UOM</th> </tr> </thead> <tbody> <tr> <td>VM1224A0</td> <td>65MY 220MM 2 COLOURS SHRINK TUBE</td> <td>0.150</td> <td>M</td> </tr> <tr> <td>VM1750A0</td> <td>BRASS COMB CLAMP</td> <td>1</td> <td>PZ</td> </tr> </tbody> </table>	Code	Description	Qty	UOM	VM1224A0	65MY 220MM 2 COLOURS SHRINK TUBE	0.150	M	VM1750A0	BRASS COMB CLAMP	1	PZ				
Code	Description	Qty	UOM																		
VM1224A0	65MY 220MM 2 COLOURS SHRINK TUBE	0.150	M																		
VM1750A0	BRASS COMB CLAMP	1	PZ																		
CR1000A	HINGE LATCH L.M.		KCR1000A	LM HINGES LATCH KIT	<table border="1"> <thead> <tr> <th>Code</th> <th>Description</th> <th>Qty</th> <th>UOM</th> </tr> </thead> <tbody> <tr> <td>CR1000A0</td> <td>HINGE LATCH L.M.</td> <td>1</td> <td>PZ</td> </tr> <tr> <td>VI1875A0</td> <td>SCREW M5X10 TC1/2T INOX</td> <td>2</td> <td>PZ</td> </tr> <tr> <td>VM1224A0</td> <td>65MY 220MM 2 COLOURS SHRINK TUBE</td> <td>0.200</td> <td>M</td> </tr> </tbody> </table>	Code	Description	Qty	UOM	CR1000A0	HINGE LATCH L.M.	1	PZ	VI1875A0	SCREW M5X10 TC1/2T INOX	2	PZ	VM1224A0	65MY 220MM 2 COLOURS SHRINK TUBE	0.200	M
Code	Description	Qty	UOM																		
CR1000A0	HINGE LATCH L.M.	1	PZ																		
VI1875A0	SCREW M5X10 TC1/2T INOX	2	PZ																		
VM1224A0	65MY 220MM 2 COLOURS SHRINK TUBE	0.200	M																		
VM2249A	COOKING CHAMBER FRONT CORNER		KVM2249A	CHAMBER FRONT PROFILE CORNER KIT	<table border="1"> <thead> <tr> <th>Code</th> <th>Description</th> <th>Qty</th> <th>UOM</th> </tr> </thead> <tbody> <tr> <td>VM1224A0</td> <td>65MY 220MM 2 COLOURS SHRINK TUBE</td> <td>0.150</td> <td>M</td> </tr> <tr> <td>VM2249A0</td> <td>COOKING CHAMBER FRONT CORNER</td> <td>1</td> <td>PZ</td> </tr> </tbody> </table>	Code	Description	Qty	UOM	VM1224A0	65MY 220MM 2 COLOURS SHRINK TUBE	0.150	M	VM2249A0	COOKING CHAMBER FRONT CORNER	1	PZ				
Code	Description	Qty	UOM																		
VM1224A0	65MY 220MM 2 COLOURS SHRINK TUBE	0.150	M																		
VM2249A0	COOKING CHAMBER FRONT CORNER	1	PZ																		
VM2502A	BAKERLUX SHOP.PRO CHIMNEY RING		KVM2502A	BAKERLUX SHOP.PRO CHIMNEY RING KIT	<table border="1"> <thead> <tr> <th>Code</th> <th>Description</th> <th>Qty</th> <th>UOM</th> </tr> </thead> <tbody> <tr> <td>VM1224A0</td> <td>65MY 220MM 2 COLOURS SHRINK TUBE</td> <td>0.300</td> <td>M</td> </tr> <tr> <td>VM2502A0</td> <td>BAKERLUX SHOP.PRO CHIMNEY RIN</td> <td>1</td> <td>PZ</td> </tr> <tr> <td>VM2502A0</td> <td>BAKERLUX SHOP.PRO CHIMNEY RIN</td> <td>1</td> <td>PZ</td> </tr> </tbody> </table>	Code	Description	Qty	UOM	VM1224A0	65MY 220MM 2 COLOURS SHRINK TUBE	0.300	M	VM2502A0	BAKERLUX SHOP.PRO CHIMNEY RIN	1	PZ	VM2502A0	BAKERLUX SHOP.PRO CHIMNEY RIN	1	PZ
Code	Description	Qty	UOM																		
VM1224A0	65MY 220MM 2 COLOURS SHRINK TUBE	0.300	M																		
VM2502A0	BAKERLUX SHOP.PRO CHIMNEY RIN	1	PZ																		
VM2502A0	BAKERLUX SHOP.PRO CHIMNEY RIN	1	PZ																		
VE1295A	MK 16A 230V DOOR MICROSWITCH		KVE1295A	16A 230V DOOR MICROSWITCH KIT	<table border="1"> <thead> <tr> <th>Code</th> <th>Description</th> <th>Qty</th> <th>UOM</th> </tr> </thead> <tbody> <tr> <td>VE1295A0</td> <td>MK 16A 230V DOOR MICROSWITC</td> <td>1</td> <td>PZ</td> </tr> <tr> <td>VM1224A0</td> <td>65MY 220MM 2 COLOURS SHRINK TUBE</td> <td>0.300</td> <td>M</td> </tr> </tbody> </table>	Code	Description	Qty	UOM	VE1295A0	MK 16A 230V DOOR MICROSWITC	1	PZ	VM1224A0	65MY 220MM 2 COLOURS SHRINK TUBE	0.300	M				
Code	Description	Qty	UOM																		
VE1295A0	MK 16A 230V DOOR MICROSWITC	1	PZ																		
VM1224A0	65MY 220MM 2 COLOURS SHRINK TUBE	0.300	M																		

COMPONENT			SPARE PART																		
Code	Description	Image	Code	Description	Components list																
VM2508A	BAKERLUX SHOP.PRO DOOR SWITCH COVER		KVM2508A	BAKERLUX SHOP.PRO MICROSWITCH COVER KIT	<table border="1"> <thead> <tr> <th>Code</th> <th>Description</th> <th>Qty</th> <th>UOM</th> </tr> </thead> <tbody> <tr> <td>VM1224A0</td> <td>65MY 220MM 2 COLOURS SHRINK TUBE</td> <td>0.300</td> <td>M</td> </tr> <tr> <td>VM2508A0</td> <td>BAKERLUX SHOP.PRO DOOR SWITCH COVE</td> <td>1</td> <td>PZ</td> </tr> <tr> <td>VM2508A0</td> <td>BAKERLUX SHOP.PRO DOOR SWITCH COVE</td> <td>1</td> <td>PZ</td> </tr> </tbody> </table>	Code	Description	Qty	UOM	VM1224A0	65MY 220MM 2 COLOURS SHRINK TUBE	0.300	M	VM2508A0	BAKERLUX SHOP.PRO DOOR SWITCH COVE	1	PZ	VM2508A0	BAKERLUX SHOP.PRO DOOR SWITCH COVE	1	PZ
Code	Description	Qty	UOM																		
VM1224A0	65MY 220MM 2 COLOURS SHRINK TUBE	0.300	M																		
VM2508A0	BAKERLUX SHOP.PRO DOOR SWITCH COVE	1	PZ																		
VM2508A0	BAKERLUX SHOP.PRO DOOR SWITCH COVE	1	PZ																		
VM2481A	FRONT EXTERNAL COVER LEFT CAP S		KVM2481A	BL SP LEFT EXT COVER FRONT PANEL CAP KIT	<table border="1"> <thead> <tr> <th>Code</th> <th>Description</th> <th>Qty</th> <th>UOM</th> </tr> </thead> <tbody> <tr> <td>VM1224A0</td> <td>65MY 220MM 2 COLOURS SHRINK TUBE</td> <td>0.150</td> <td>M</td> </tr> <tr> <td>VM2481A0</td> <td>FRONT EXTERNAL COVER LEFT CAP SP</td> <td>1</td> <td>PZ</td> </tr> <tr> <td>VM2481A0</td> <td>FRONT EXTERNAL COVER LEFT CAP SP</td> <td>1</td> <td>PZ</td> </tr> </tbody> </table>	Code	Description	Qty	UOM	VM1224A0	65MY 220MM 2 COLOURS SHRINK TUBE	0.150	M	VM2481A0	FRONT EXTERNAL COVER LEFT CAP SP	1	PZ	VM2481A0	FRONT EXTERNAL COVER LEFT CAP SP	1	PZ
Code	Description	Qty	UOM																		
VM1224A0	65MY 220MM 2 COLOURS SHRINK TUBE	0.150	M																		
VM2481A0	FRONT EXTERNAL COVER LEFT CAP SP	1	PZ																		
VM2481A0	FRONT EXTERNAL COVER LEFT CAP SP	1	PZ																		
VM2480A	FRONT EXTERNAL COVER RIGHT CAP SP		KVM2480A	BL SP RIGHT EXT COVER FRONT PANEL CAP	<table border="1"> <thead> <tr> <th>Code</th> <th>Description</th> <th>Qty</th> <th>UOM</th> </tr> </thead> <tbody> <tr> <td>VM1224A0</td> <td>65MY 220MM 2 COLOURS SHRINK TUBE</td> <td>0.150</td> <td>M</td> </tr> <tr> <td>VM2480A0</td> <td>FRONT EXTERNAL COVER RIGHT CAP SP</td> <td>1</td> <td>PZ</td> </tr> <tr> <td>VM2480A0</td> <td>FRONT EXTERNAL COVER RIGHT CAP SP</td> <td>1</td> <td>PZ</td> </tr> </tbody> </table>	Code	Description	Qty	UOM	VM1224A0	65MY 220MM 2 COLOURS SHRINK TUBE	0.150	M	VM2480A0	FRONT EXTERNAL COVER RIGHT CAP SP	1	PZ	VM2480A0	FRONT EXTERNAL COVER RIGHT CAP SP	1	PZ
Code	Description	Qty	UOM																		
VM1224A0	65MY 220MM 2 COLOURS SHRINK TUBE	0.150	M																		
VM2480A0	FRONT EXTERNAL COVER RIGHT CAP SP	1	PZ																		
VM2480A0	FRONT EXTERNAL COVER RIGHT CAP SP	1	PZ																		
VM1222A	CABLE LOCKS SP ACCESSORIES EL CONNECTION		VM1222A0	CABLE LOCKS SP ACCESSORIES EL CONNECTION																	

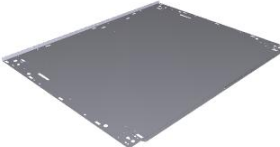

COMPONENT			SPARE PART																						
Code	Description	Image	Code	Description	Components list																				
VM2455A	BL SP CONTROL BOARD CABLE PASSAGE CLIP		KVM2455A	BL SP CONTR BOARD PASSAGE CABLE CLIP KIT	<table border="1"> <thead> <tr> <th>Code</th> <th>Description</th> <th>Qty</th> <th>UOM</th> </tr> </thead> <tbody> <tr> <td>VM1224A0</td> <td>65MY 220MM 2 COLOURS SHRINK TUBE</td> <td>0.150</td> <td>M</td> </tr> <tr> <td>VM2455A0</td> <td>BL SP CONTROL BOARD CABLE PASSAGE CLI</td> <td>1</td> <td>PZ</td> </tr> <tr> <td>VM2455A0</td> <td>BL SP CONTROL BOARD CABLE PASSAGE CLI</td> <td>1</td> <td>PZ</td> </tr> </tbody> </table>	Code	Description	Qty	UOM	VM1224A0	65MY 220MM 2 COLOURS SHRINK TUBE	0.150	M	VM2455A0	BL SP CONTROL BOARD CABLE PASSAGE CLI	1	PZ	VM2455A0	BL SP CONTROL BOARD CABLE PASSAGE CLI	1	PZ				
Code	Description	Qty	UOM																						
VM1224A0	65MY 220MM 2 COLOURS SHRINK TUBE	0.150	M																						
VM2455A0	BL SP CONTROL BOARD CABLE PASSAGE CLI	1	PZ																						
VM2455A0	BL SP CONTROL BOARD CABLE PASSAGE CLI	1	PZ																						
0D2411A	SP800 INF FRONT PROFILE DROP DOWN DOOR		0D2411A0	SP800 INF FRONT PROFILE DROP DOWN DOOR																					
VM1631A	PLUS INNER GLASS PUSHING CAP		KVM1631A	CAP FOR INTERNAL GLASS 10 PCS KIT	<table border="1"> <thead> <tr> <th>Code</th> <th>Description</th> <th>Qty</th> <th>UOM</th> </tr> </thead> <tbody> <tr> <td>VM1224A0</td> <td>65MY 220MM 2 COLOURS SHRINK TUBE</td> <td>0.200</td> <td>M</td> </tr> <tr> <td>VM1631A0</td> <td>PLUS INNER GLASS PUSHING CAP</td> <td>10</td> <td>PZ</td> </tr> </tbody> </table>	Code	Description	Qty	UOM	VM1224A0	65MY 220MM 2 COLOURS SHRINK TUBE	0.200	M	VM1631A0	PLUS INNER GLASS PUSHING CAP	10	PZ								
Code	Description	Qty	UOM																						
VM1224A0	65MY 220MM 2 COLOURS SHRINK TUBE	0.200	M																						
VM1631A0	PLUS INNER GLASS PUSHING CAP	10	PZ																						
VM2492A	BL SP 600X400 EXT BOTTOM PANEL GASKET		KVM2492A	SP 600X400 EXT BOT PANEL GASKET 2PC KIT	<table border="1"> <thead> <tr> <th>Code</th> <th>Description</th> <th>Qty</th> <th>UOM</th> </tr> </thead> <tbody> <tr> <td>VM1794A0</td> <td>250X4.8 PA66 BLACK CLAMP</td> <td>1</td> <td>PZ</td> </tr> <tr> <td>VM2103A0</td> <td>CLAMP LOCK</td> <td>1</td> <td>PZ</td> </tr> <tr> <td>VM2492A0</td> <td>BL SP 600X400 EXT BOTTOM PANEL GASKE</td> <td>2</td> <td>PZ</td> </tr> <tr> <td>VM2492A0</td> <td>BL SP 600X400 EXT BOTTOM PANEL GASKE</td> <td>2</td> <td>PZ</td> </tr> </tbody> </table>	Code	Description	Qty	UOM	VM1794A0	250X4.8 PA66 BLACK CLAMP	1	PZ	VM2103A0	CLAMP LOCK	1	PZ	VM2492A0	BL SP 600X400 EXT BOTTOM PANEL GASKE	2	PZ	VM2492A0	BL SP 600X400 EXT BOTTOM PANEL GASKE	2	PZ
Code	Description	Qty	UOM																						
VM1794A0	250X4.8 PA66 BLACK CLAMP	1	PZ																						
VM2103A0	CLAMP LOCK	1	PZ																						
VM2492A0	BL SP 600X400 EXT BOTTOM PANEL GASKE	2	PZ																						
VM2492A0	BL SP 600X400 EXT BOTTOM PANEL GASKE	2	PZ																						
VM2493A	BL SP 600X400 EX LAT BOTTOM PANEL GASKET		KVM2493A	SP 600X400 BOT LAT PANEL GASKET 2PC KIT	<table border="1"> <thead> <tr> <th>Code</th> <th>Description</th> <th>Qty</th> <th>UOM</th> </tr> </thead> <tbody> <tr> <td>VM1631A0</td> <td>PLUS INNER GLASS PUSHING CAP</td> <td>4</td> <td>PZ</td> </tr> <tr> <td>VM1794A0</td> <td>250X4.8 PA66 BLACK CLAMP</td> <td>1</td> <td>PZ</td> </tr> <tr> <td>VM2103A0</td> <td>CLAMP LOCK</td> <td>1</td> <td>PZ</td> </tr> <tr> <td>VM2493A0</td> <td>BL SP 600X400 EX LAT BOTTOM PANEL GASKE</td> <td>2</td> <td>PZ</td> </tr> </tbody> </table>	Code	Description	Qty	UOM	VM1631A0	PLUS INNER GLASS PUSHING CAP	4	PZ	VM1794A0	250X4.8 PA66 BLACK CLAMP	1	PZ	VM2103A0	CLAMP LOCK	1	PZ	VM2493A0	BL SP 600X400 EX LAT BOTTOM PANEL GASKE	2	PZ
Code	Description	Qty	UOM																						
VM1631A0	PLUS INNER GLASS PUSHING CAP	4	PZ																						
VM1794A0	250X4.8 PA66 BLACK CLAMP	1	PZ																						
VM2103A0	CLAMP LOCK	1	PZ																						
VM2493A0	BL SP 600X400 EX LAT BOTTOM PANEL GASKE	2	PZ																						



COMPONENT			SPARE PART														
Code	Description	Image	Code	Description	Components list												
VM2493A	BL SP 600X400 EX LAT BOTTOM PANEL GASKET		KVM2493A	SP 600X400 BOT LAT PANEL GASKET 2PC KIT	<table border="1"> <thead> <tr> <th>Code</th> <th>Description</th> <th>Qty</th> <th>UOM</th> </tr> </thead> <tbody> <tr> <td>VM2493A0</td> <td>BL SP 600X400 EX LAT BOTTOM PANEL GASKE</td> <td>2</td> <td>PZ</td> </tr> <tr> <td>VM2493A1</td> <td>EXT. LATERAL BACK GASKET SP800</td> <td>2</td> <td>PZ</td> </tr> </tbody> </table>	Code	Description	Qty	UOM	VM2493A0	BL SP 600X400 EX LAT BOTTOM PANEL GASKE	2	PZ	VM2493A1	EXT. LATERAL BACK GASKET SP800	2	PZ
Code	Description	Qty	UOM														
VM2493A0	BL SP 600X400 EX LAT BOTTOM PANEL GASKE	2	PZ														
VM2493A1	EXT. LATERAL BACK GASKET SP800	2	PZ														
0E1382A	SP800 EXTERNAL BOTTOM PANEL		0E1382A1	SP800 EXTERNAL BOTTOM PANEL													
VN1175A	230V 50/60HZ 120X120 COOLING DOWN FAN		KVN1175A	120X120 230V 50/60HZ COOLING FAN KIT	<table border="1"> <thead> <tr> <th>Code</th> <th>Description</th> <th>Qty</th> <th>UOM</th> </tr> </thead> <tbody> <tr> <td>VN1175A0</td> <td>230V 50/60HZ 120X120 COOLING DOWN FAN</td> <td>1</td> <td>PZ</td> </tr> <tr> <td>VN1175A0</td> <td>230V 50/60HZ 120X120 COOLING DOWN FAN</td> <td>1</td> <td>PZ</td> </tr> </tbody> </table>	Code	Description	Qty	UOM	VN1175A0	230V 50/60HZ 120X120 COOLING DOWN FAN	1	PZ	VN1175A0	230V 50/60HZ 120X120 COOLING DOWN FAN	1	PZ
Code	Description	Qty	UOM														
VN1175A0	230V 50/60HZ 120X120 COOLING DOWN FAN	1	PZ														
VN1175A0	230V 50/60HZ 120X120 COOLING DOWN FAN	1	PZ														
VM2495A	SP COOLING FAN SUPPORT		KVM2495A	COOLING FAN SUPPORT KIT	<table border="1"> <thead> <tr> <th>Code</th> <th>Description</th> <th>Qty</th> <th>UOM</th> </tr> </thead> <tbody> <tr> <td>VI1220A1</td> <td>4,2X12 TCB SELF-TAPPIN G SCREW</td> <td>2</td> <td>PZ</td> </tr> <tr> <td>VM2495A0</td> <td>SP COOLING FAN SUPPORT</td> <td>1</td> <td>PZ</td> </tr> </tbody> </table>	Code	Description	Qty	UOM	VI1220A1	4,2X12 TCB SELF-TAPPIN G SCREW	2	PZ	VM2495A0	SP COOLING FAN SUPPORT	1	PZ
Code	Description	Qty	UOM														
VI1220A1	4,2X12 TCB SELF-TAPPIN G SCREW	2	PZ														
VM2495A0	SP COOLING FAN SUPPORT	1	PZ														
0D2403B	ELENA SP DROP-DOWN EXTERNAL CASING		0D2403B0	ELENA SP DROP-DOWN EXTERNAL CASING													



COMPONENT			SPARE PART		
<i>Code</i>	<i>Description</i>	<i>Image</i>	<i>Code</i>	<i>Description</i>	<i>Components list</i>
0F1543B	ELENA SP BACK PANEL		0F1543B0	ELENA SP BACK PANEL	