







Assembly code	Assembly revision	Assembly image
ASM0141B/0.D06		
ASM1571A/0.D00		
ASM1543A/0.D02		
ASM1570A/0.D02		



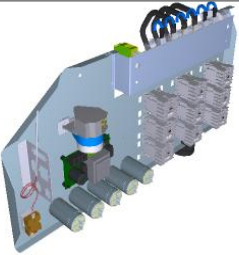

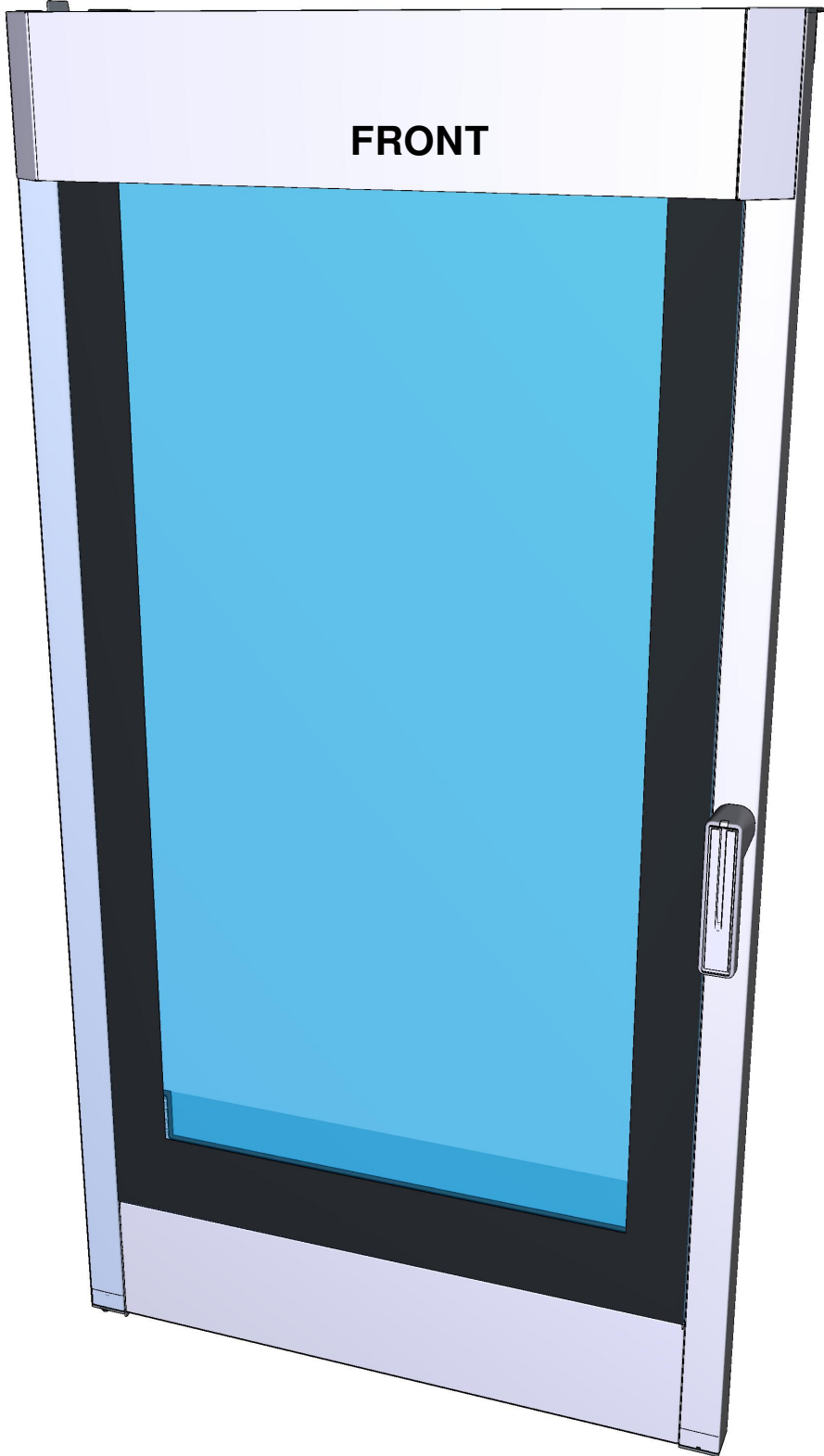
ASM0141B/0.D06 -





ASM0141B/0.D06 -



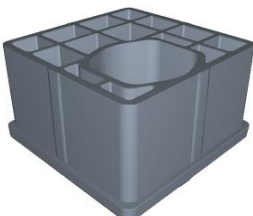



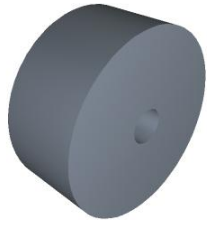

COMPONENT			SPARE PART														
Code	Description	Image	Code	Description	Components list												
VI1785A	CHROMIUM PLATED BRASS SCREW M6X12		KVI1785A	M6X12 SCREW 20 PCS. KIT	<table border="1"> <thead> <tr> <th>Code</th> <th>Description</th> <th>Qty</th> <th>UOM</th> </tr> </thead> <tbody> <tr> <td>VI1300A0</td> <td>SCREW M6X12 T1/2T+INOX</td> <td>20</td> <td>PZ</td> </tr> <tr> <td>VM1224A0</td> <td>65MY 220MM 2 COLOURS SHRINK TUBE</td> <td>0.200</td> <td>M</td> </tr> </tbody> </table>	Code	Description	Qty	UOM	VI1300A0	SCREW M6X12 T1/2T+INOX	20	PZ	VM1224A0	65MY 220MM 2 COLOURS SHRINK TUBE	0.200	M
Code	Description	Qty	UOM														
VI1300A0	SCREW M6X12 T1/2T+INOX	20	PZ														
VM1224A0	65MY 220MM 2 COLOURS SHRINK TUBE	0.200	M														
VM1175A	DOOR COLUMN BLANKING CAP		VM1175A0	DOOR COLUMN BLANKING CAP													
VM1170B	UPPER DOOR FULCRUM CAP		KVM1170B	UPPER DOOR FULCRUM CAP KIT	<table border="1"> <thead> <tr> <th>Code</th> <th>Description</th> <th>Qty</th> <th>UOM</th> </tr> </thead> <tbody> <tr> <td>VM1170B0</td> <td>UPPER DOOR FULCRUM CA</td> <td>2</td> <td>PZ</td> </tr> <tr> <td>VM1224A0</td> <td>65MY 220MM 2 COLOURS SHRINK TUBE</td> <td>0.250</td> <td>M</td> </tr> </tbody> </table>	Code	Description	Qty	UOM	VM1170B0	UPPER DOOR FULCRUM CA	2	PZ	VM1224A0	65MY 220MM 2 COLOURS SHRINK TUBE	0.250	M
Code	Description	Qty	UOM														
VM1170B0	UPPER DOOR FULCRUM CA	2	PZ														
VM1224A0	65MY 220MM 2 COLOURS SHRINK TUBE	0.250	M														
VM1511A	XBC/XVC SLEEK DOOR PIN BUSHING		KVM1511A	5 PCS SLEEK DOOR PIN BUSHING KIT	<table border="1"> <thead> <tr> <th>Code</th> <th>Description</th> <th>Qty</th> <th>UOM</th> </tr> </thead> <tbody> <tr> <td>VM1224A0</td> <td>65MY 220MM 2 COLOURS SHRINK TUBE</td> <td>0.200</td> <td>M</td> </tr> <tr> <td>VM1511A0</td> <td>XBC/XVC SLEEK DOOR PIN BUSHING</td> <td>5</td> <td>PZ</td> </tr> </tbody> </table>	Code	Description	Qty	UOM	VM1224A0	65MY 220MM 2 COLOURS SHRINK TUBE	0.200	M	VM1511A0	XBC/XVC SLEEK DOOR PIN BUSHING	5	PZ
Code	Description	Qty	UOM														
VM1224A0	65MY 220MM 2 COLOURS SHRINK TUBE	0.200	M														
VM1511A0	XBC/XVC SLEEK DOOR PIN BUSHING	5	PZ														
VM1171B	DOOR LOWER FULCRUM CAP		KVM1171B	LOWER DOOR FULCRUM CAP KIT	<table border="1"> <thead> <tr> <th>Code</th> <th>Description</th> <th>Qty</th> <th>UOM</th> </tr> </thead> <tbody> <tr> <td>VM1171B0</td> <td>DOOR LOWER FULCRUM CA</td> <td>2</td> <td>PZ</td> </tr> <tr> <td>VM1224A0</td> <td>65MY 220MM 2 COLOURS SHRINK TUBE</td> <td>0.250</td> <td>M</td> </tr> </tbody> </table>	Code	Description	Qty	UOM	VM1171B0	DOOR LOWER FULCRUM CA	2	PZ	VM1224A0	65MY 220MM 2 COLOURS SHRINK TUBE	0.250	M
Code	Description	Qty	UOM														
VM1171B0	DOOR LOWER FULCRUM CA	2	PZ														
VM1224A0	65MY 220MM 2 COLOURS SHRINK TUBE	0.250	M														

COMPONENT			SPARE PART																										
Code	Description	Image	Code	Description	Components list																								
VM1510A	XBC/XVC GROOVED DOOR PIN BUSHING		KVM1510A	GROOVED DOOR PIN BUSHING 5 PCS KIT	<table border="1"> <thead> <tr> <th>Code</th> <th>Description</th> <th>Qty</th> <th>UOM</th> </tr> </thead> <tbody> <tr> <td>VM1224A0</td> <td>65MY 220MM 2 COLOURS SHRINK TUBE</td> <td>0.150</td> <td>M</td> </tr> <tr> <td>VM1510A0</td> <td>XBC/XVC GROOVED DOOR PIN BUSHING</td> <td>5</td> <td>PZ</td> </tr> </tbody> </table>	Code	Description	Qty	UOM	VM1224A0	65MY 220MM 2 COLOURS SHRINK TUBE	0.150	M	VM1510A0	XBC/XVC GROOVED DOOR PIN BUSHING	5	PZ												
Code	Description	Qty	UOM																										
VM1224A0	65MY 220MM 2 COLOURS SHRINK TUBE	0.150	M																										
VM1510A0	XBC/XVC GROOVED DOOR PIN BUSHING	5	PZ																										
VM1591A	GLASS BRACKET INT. XVC1004		KVM1591A	S.5E INT. GLASS H35 PUSHING BRACKET KIT	<table border="1"> <thead> <tr> <th>Code</th> <th>Description</th> <th>Qty</th> <th>UOM</th> </tr> </thead> <tbody> <tr> <td>VI1220A1</td> <td>4,2X12 TCB SELF-TAPPIN G SCREW</td> <td>2</td> <td>PZ</td> </tr> <tr> <td>VM1224A0</td> <td>65MY 220MM 2 COLOURS SHRINK TUBE</td> <td>0.200</td> <td>M</td> </tr> <tr> <td>VM1591A0</td> <td>GLASS BRACKET INT. XVC1004</td> <td>1</td> <td>PZ</td> </tr> <tr> <td>VM1630A0</td> <td>INTERNAL GLASS PUSHING CAP</td> <td>2</td> <td>PZ</td> </tr> <tr> <td>VM1630A1</td> <td>INTERNAL GLASS PUSHING CAP</td> <td>2</td> <td>PZ</td> </tr> </tbody> </table>	Code	Description	Qty	UOM	VI1220A1	4,2X12 TCB SELF-TAPPIN G SCREW	2	PZ	VM1224A0	65MY 220MM 2 COLOURS SHRINK TUBE	0.200	M	VM1591A0	GLASS BRACKET INT. XVC1004	1	PZ	VM1630A0	INTERNAL GLASS PUSHING CAP	2	PZ	VM1630A1	INTERNAL GLASS PUSHING CAP	2	PZ
Code	Description	Qty	UOM																										
VI1220A1	4,2X12 TCB SELF-TAPPIN G SCREW	2	PZ																										
VM1224A0	65MY 220MM 2 COLOURS SHRINK TUBE	0.200	M																										
VM1591A0	GLASS BRACKET INT. XVC1004	1	PZ																										
VM1630A0	INTERNAL GLASS PUSHING CAP	2	PZ																										
VM1630A1	INTERNAL GLASS PUSHING CAP	2	PZ																										
VM1630A	INTERNAL GLASS PUSHING CAP		KVM1630A	CAP FOR INTERNAL GLASS 10 PCS KIT	<table border="1"> <thead> <tr> <th>Code</th> <th>Description</th> <th>Qty</th> <th>UOM</th> </tr> </thead> <tbody> <tr> <td>VM1224A0</td> <td>65MY 220MM 2 COLOURS SHRINK TUBE</td> <td>0.200</td> <td>M</td> </tr> <tr> <td>VM1630A0</td> <td>INTERNAL GLASS PUSHING CAP</td> <td>10</td> <td>PZ</td> </tr> <tr> <td>VM1630A1</td> <td>INTERNAL GLASS PUSHING CAP</td> <td>10</td> <td>PZ</td> </tr> </tbody> </table>	Code	Description	Qty	UOM	VM1224A0	65MY 220MM 2 COLOURS SHRINK TUBE	0.200	M	VM1630A0	INTERNAL GLASS PUSHING CAP	10	PZ	VM1630A1	INTERNAL GLASS PUSHING CAP	10	PZ								
Code	Description	Qty	UOM																										
VM1224A0	65MY 220MM 2 COLOURS SHRINK TUBE	0.200	M																										
VM1630A0	INTERNAL GLASS PUSHING CAP	10	PZ																										
VM1630A1	INTERNAL GLASS PUSHING CAP	10	PZ																										
VM2008A	SPACER FOR MICROSWITCH		KVM2008A	MICROSWITCH SPACER KIT	<table border="1"> <thead> <tr> <th>Code</th> <th>Description</th> <th>Qty</th> <th>UOM</th> </tr> </thead> <tbody> <tr> <td>VM1224A0</td> <td>65MY 220MM 2 COLOURS SHRINK TUBE</td> <td>0.200</td> <td>M</td> </tr> <tr> <td>VM2008A0</td> <td>SPACER FOR MICROSWITC</td> <td>2</td> <td>PZ</td> </tr> </tbody> </table>	Code	Description	Qty	UOM	VM1224A0	65MY 220MM 2 COLOURS SHRINK TUBE	0.200	M	VM2008A0	SPACER FOR MICROSWITC	2	PZ												
Code	Description	Qty	UOM																										
VM1224A0	65MY 220MM 2 COLOURS SHRINK TUBE	0.200	M																										
VM2008A0	SPACER FOR MICROSWITC	2	PZ																										

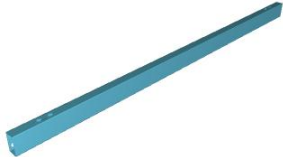
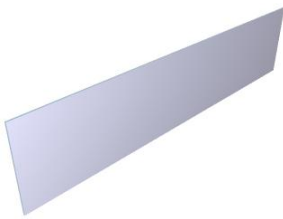
COMPONENT			SPARE PART																																														
Code	Description	Image	Code	Description	Components list																																												
VE1030A	MAGNET FOR DOOR MICROSWITCH D=22,9MM		KVE1030A	2 PCS MAGNET KIT FOR DOOR SWITCH	<table border="1"> <thead> <tr> <th>Code</th> <th>Description</th> <th>Qty</th> <th>UOM</th> </tr> </thead> <tbody> <tr> <td>VE1030A1</td> <td>MAGNET FOR DOOR MICROSWITC H D=22,9MM</td> <td>2</td> <td>PZ</td> </tr> <tr> <td>VM1224A0</td> <td>65MY 220MM 2 COLOURS SHRINK TUBE</td> <td>0.150</td> <td>M</td> </tr> </tbody> </table>	Code	Description	Qty	UOM	VE1030A1	MAGNET FOR DOOR MICROSWITC H D=22,9MM	2	PZ	VM1224A0	65MY 220MM 2 COLOURS SHRINK TUBE	0.150	M																																
			Code	Description	Qty	UOM																																											
VE1030A1	MAGNET FOR DOOR MICROSWITC H D=22,9MM	2	PZ																																														
VM1224A0	65MY 220MM 2 COLOURS SHRINK TUBE	0.150	M																																														
KVE1020A	MICROSWITCH KIT	<table border="1"> <thead> <tr> <th>Code</th> <th>Description</th> <th>Qty</th> <th>UOM</th> </tr> </thead> <tbody> <tr> <td>VE1020A2</td> <td>MAGNETIC DOOR MICROSWITC</td> <td>1</td> <td>PZ</td> </tr> <tr> <td>VE1030A1</td> <td>MAGNET FOR DOOR MICROSWITC H D=22,9MM</td> <td>4</td> <td>PZ</td> </tr> <tr> <td>VM1224A0</td> <td>65MY 220MM 2 COLOURS SHRINK TUBE</td> <td>0.250</td> <td>M</td> </tr> </tbody> </table>	Code	Description	Qty	UOM	VE1020A2	MAGNETIC DOOR MICROSWITC	1	PZ	VE1030A1	MAGNET FOR DOOR MICROSWITC H D=22,9MM	4	PZ	VM1224A0	65MY 220MM 2 COLOURS SHRINK TUBE	0.250	M																															
Code	Description	Qty	UOM																																														
VE1020A2	MAGNETIC DOOR MICROSWITC	1	PZ																																														
VE1030A1	MAGNET FOR DOOR MICROSWITC H D=22,9MM	4	PZ																																														
VM1224A0	65MY 220MM 2 COLOURS SHRINK TUBE	0.250	M																																														
VT1160A	730X1395X6 XBC/XVC 1000-4000 INT. GLASS		KVT1160A	1000-4000 SERIES INNER GLASS KIT	<table border="1"> <thead> <tr> <th>Code</th> <th>Description</th> <th>Qty</th> <th>UOM</th> </tr> </thead> <tbody> <tr> <td>0H3176A1</td> <td>XBC/XVC 1000-4000 INT. GLASS UPPER FRAME</td> <td>1</td> <td>PZ</td> </tr> <tr> <td>0H3177A3</td> <td>XBC/XVC 1000-4000 INT. GLASS LOWER FRAM</td> <td>1</td> <td>PZ</td> </tr> <tr> <td>0H3178A0</td> <td>SERIE1000-4000 GASKET HOLDER PLAT</td> <td>1</td> <td>PZ</td> </tr> <tr> <td>GN1341B0</td> <td>DOOR-TROLL EY SEALING</td> <td>0.730</td> <td>M</td> </tr> <tr> <td>IL1050B0</td> <td>WOODEN PALLET 965X875X123</td> <td>2</td> <td>PZ</td> </tr> <tr> <td>IP1385A1</td> <td>CORNER POLYSTYREN E PACKING 110X80X2000</td> <td>4.500</td> <td>M</td> </tr> <tr> <td>SL1170A1</td> <td>S57 BLACK SILICON - 310ML CARTRIDGE</td> <td>300</td> <td>ML</td> </tr> <tr> <td>VI1075A0</td> <td>NUT M4 H=4 UNI5587 INOX</td> <td>3</td> <td>PZ</td> </tr> <tr> <td>VI1511A0</td> <td>STAINLESS STEEL WASHER 4.2X12X1</td> <td>3</td> <td>PZ</td> </tr> <tr> <td>VI1925A0</td> <td>ST STEEL STUD BOLT M4X8</td> <td>3</td> <td>PZ</td> </tr> </tbody> </table>	Code	Description	Qty	UOM	0H3176A1	XBC/XVC 1000-4000 INT. GLASS UPPER FRAME	1	PZ	0H3177A3	XBC/XVC 1000-4000 INT. GLASS LOWER FRAM	1	PZ	0H3178A0	SERIE1000-4000 GASKET HOLDER PLAT	1	PZ	GN1341B0	DOOR-TROLL EY SEALING	0.730	M	IL1050B0	WOODEN PALLET 965X875X123	2	PZ	IP1385A1	CORNER POLYSTYREN E PACKING 110X80X2000	4.500	M	SL1170A1	S57 BLACK SILICON - 310ML CARTRIDGE	300	ML	VI1075A0	NUT M4 H=4 UNI5587 INOX	3	PZ	VI1511A0	STAINLESS STEEL WASHER 4.2X12X1	3	PZ	VI1925A0	ST STEEL STUD BOLT M4X8	3	PZ
			Code	Description	Qty	UOM																																											
			0H3176A1	XBC/XVC 1000-4000 INT. GLASS UPPER FRAME	1	PZ																																											
			0H3177A3	XBC/XVC 1000-4000 INT. GLASS LOWER FRAM	1	PZ																																											
			0H3178A0	SERIE1000-4000 GASKET HOLDER PLAT	1	PZ																																											
			GN1341B0	DOOR-TROLL EY SEALING	0.730	M																																											
			IL1050B0	WOODEN PALLET 965X875X123	2	PZ																																											
			IP1385A1	CORNER POLYSTYREN E PACKING 110X80X2000	4.500	M																																											
			SL1170A1	S57 BLACK SILICON - 310ML CARTRIDGE	300	ML																																											
			VI1075A0	NUT M4 H=4 UNI5587 INOX	3	PZ																																											
			VI1511A0	STAINLESS STEEL WASHER 4.2X12X1	3	PZ																																											
			VI1925A0	ST STEEL STUD BOLT M4X8	3	PZ																																											

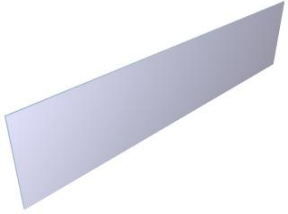
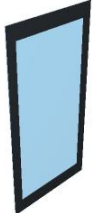
COMPONENT			SPARE PART																																		
Code	Description	Image	Code	Description	Components list																																
VT1160A	730X1395X6 XBC/XVC 1000-4000 INT. GLASS		KVT1160A	1000-4000 SERIES INNER GLASS KIT	<table border="1"> <thead> <tr> <th>Code</th> <th>Description</th> <th>Qty</th> <th>UOM</th> </tr> </thead> <tbody> <tr> <td>VT1160A1</td> <td>730X1395X6 XBC/XVC 1000-4000 INT. GLASS</td> <td>1</td> <td>PZ</td> </tr> <tr> <td>VT1160A1</td> <td>730X1395X6 XBC/XVC 1000-4000 INT. GLASS</td> <td>1</td> <td>PZ</td> </tr> </tbody> </table>	Code	Description	Qty	UOM	VT1160A1	730X1395X6 XBC/XVC 1000-4000 INT. GLASS	1	PZ	VT1160A1	730X1395X6 XBC/XVC 1000-4000 INT. GLASS	1	PZ																				
Code	Description	Qty	UOM																																		
VT1160A1	730X1395X6 XBC/XVC 1000-4000 INT. GLASS	1	PZ																																		
VT1160A1	730X1395X6 XBC/XVC 1000-4000 INT. GLASS	1	PZ																																		
0H3428A	SERIES 1000-4000 UPPER LEFT DOOR BRACKET		0H3428A0	SERIES 1000-4000 UPPER LEFT DOOR BRACKET																																	
0H3170A	UPPER/LOWER DOOR LISTEL XVC/XBC1004		0H3170A1	UPPER/LOWER DOOR LISTEL XVC/XBC1004																																	
VT1264A	XV1093-4093 BLACK GLASS		KVT1264A	1093-4093 EXTERNAL GLASS KIT	<table border="1"> <thead> <tr> <th>Code</th> <th>Description</th> <th>Qty</th> <th>UOM</th> </tr> </thead> <tbody> <tr> <td>0H4450A0</td> <td>CONTROL PANEL CLOSING BACK COVER</td> <td>1</td> <td>PZ</td> </tr> <tr> <td>0H6720A0</td> <td>CONTROL BOARD EXT. LATERAL SIDE</td> <td>2</td> <td>PZ</td> </tr> <tr> <td>0H6900A0</td> <td>SERIES 1093 CONTROL BOARD PANEL</td> <td>1</td> <td>PZ</td> </tr> <tr> <td>IP1508A1</td> <td>POLYSTYREN E U SHAPED PROFILE 2000X60X60</td> <td>1</td> <td>M</td> </tr> <tr> <td>SL1155A1</td> <td>LOCTITE BICOMPONEN T SILICON</td> <td>32</td> <td>ML</td> </tr> <tr> <td>TB1013A0</td> <td>WIRE PROTECTION TUBE Ø10X1 L=46MM</td> <td>1</td> <td>PZ</td> </tr> <tr> <td>VI1310A0</td> <td>ZINC THREAD INSERT M6 FTR/E</td> <td>4</td> <td>PZ</td> </tr> </tbody> </table>	Code	Description	Qty	UOM	0H4450A0	CONTROL PANEL CLOSING BACK COVER	1	PZ	0H6720A0	CONTROL BOARD EXT. LATERAL SIDE	2	PZ	0H6900A0	SERIES 1093 CONTROL BOARD PANEL	1	PZ	IP1508A1	POLYSTYREN E U SHAPED PROFILE 2000X60X60	1	M	SL1155A1	LOCTITE BICOMPONEN T SILICON	32	ML	TB1013A0	WIRE PROTECTION TUBE Ø10X1 L=46MM	1	PZ	VI1310A0	ZINC THREAD INSERT M6 FTR/E	4	PZ
Code	Description	Qty	UOM																																		
0H4450A0	CONTROL PANEL CLOSING BACK COVER	1	PZ																																		
0H6720A0	CONTROL BOARD EXT. LATERAL SIDE	2	PZ																																		
0H6900A0	SERIES 1093 CONTROL BOARD PANEL	1	PZ																																		
IP1508A1	POLYSTYREN E U SHAPED PROFILE 2000X60X60	1	M																																		
SL1155A1	LOCTITE BICOMPONEN T SILICON	32	ML																																		
TB1013A0	WIRE PROTECTION TUBE Ø10X1 L=46MM	1	PZ																																		
VI1310A0	ZINC THREAD INSERT M6 FTR/E	4	PZ																																		

COMPONENT			SPARE PART																																						
Code	Description	Image	Code	Description	Components list																																				
VT1264A	XV1093-4093 BLACK GLASS		KVT1264A	1093-4093 EXTERNAL GLASS KIT	<table border="1"> <thead> <tr> <th>Code</th> <th>Description</th> <th>Qty</th> <th>UOM</th> </tr> </thead> <tbody> <tr> <td>VI1860A0</td> <td>SCREW M6X60 TCB+ INOX</td> <td>4</td> <td>PZ</td> </tr> <tr> <td>VT1264A0</td> <td>XV1093-4093 BLACK GLASS</td> <td>1</td> <td>PZ</td> </tr> <tr> <td>VT1264A0</td> <td>XV1093-4093 BLACK GLASS</td> <td>1</td> <td>PZ</td> </tr> </tbody> </table>	Code	Description	Qty	UOM	VI1860A0	SCREW M6X60 TCB+ INOX	4	PZ	VT1264A0	XV1093-4093 BLACK GLASS	1	PZ	VT1264A0	XV1093-4093 BLACK GLASS	1	PZ																				
Code	Description	Qty	UOM																																						
VI1860A0	SCREW M6X60 TCB+ INOX	4	PZ																																						
VT1264A0	XV1093-4093 BLACK GLASS	1	PZ																																						
VT1264A0	XV1093-4093 BLACK GLASS	1	PZ																																						
VT1161A	SER. EXTERNAL GLASS 757X1467X5		KVT1161A	S.4-5 900/1000/4000 EXTERNAL GLASS KIT	<table border="1"> <thead> <tr> <th>Code</th> <th>Description</th> <th>Qty</th> <th>UOM</th> </tr> </thead> <tbody> <tr> <td>0H4952A0</td> <td>EXTERNAL GLASS HOLDING PROFILE</td> <td>2</td> <td>PZ</td> </tr> <tr> <td>IL1050B0</td> <td>WOODEN PALLET 965X875X123</td> <td>2</td> <td>PZ</td> </tr> <tr> <td>IP1385A1</td> <td>CORNER POLYSTYREN E PACKING 110X80X2000</td> <td>3.060</td> <td>M</td> </tr> <tr> <td>IP1508A1</td> <td>POLYSTYREN E U SHAPED PROFILE 2000X60X60</td> <td>1.220</td> <td>M</td> </tr> <tr> <td>SL1155A1</td> <td>LOCTITE BICOMPONENT SILICON</td> <td>104</td> <td>ML</td> </tr> <tr> <td>SL1156A0</td> <td>NOZZLE FOR SILICON GUN</td> <td>1</td> <td>PZ</td> </tr> <tr> <td>VT1161A1</td> <td>SER. EXTERNAL GLASS 757X1467X5</td> <td>1</td> <td>PZ</td> </tr> <tr> <td>VT1161A1</td> <td>SER. EXTERNAL GLASS 757X1467X5</td> <td>1</td> <td>PZ</td> </tr> </tbody> </table>	Code	Description	Qty	UOM	0H4952A0	EXTERNAL GLASS HOLDING PROFILE	2	PZ	IL1050B0	WOODEN PALLET 965X875X123	2	PZ	IP1385A1	CORNER POLYSTYREN E PACKING 110X80X2000	3.060	M	IP1508A1	POLYSTYREN E U SHAPED PROFILE 2000X60X60	1.220	M	SL1155A1	LOCTITE BICOMPONENT SILICON	104	ML	SL1156A0	NOZZLE FOR SILICON GUN	1	PZ	VT1161A1	SER. EXTERNAL GLASS 757X1467X5	1	PZ	VT1161A1	SER. EXTERNAL GLASS 757X1467X5	1	PZ
Code	Description	Qty	UOM																																						
0H4952A0	EXTERNAL GLASS HOLDING PROFILE	2	PZ																																						
IL1050B0	WOODEN PALLET 965X875X123	2	PZ																																						
IP1385A1	CORNER POLYSTYREN E PACKING 110X80X2000	3.060	M																																						
IP1508A1	POLYSTYREN E U SHAPED PROFILE 2000X60X60	1.220	M																																						
SL1155A1	LOCTITE BICOMPONENT SILICON	104	ML																																						
SL1156A0	NOZZLE FOR SILICON GUN	1	PZ																																						
VT1161A1	SER. EXTERNAL GLASS 757X1467X5	1	PZ																																						
VT1161A1	SER. EXTERNAL GLASS 757X1467X5	1	PZ																																						
0H3425A	ST.STEEL UPPER DOOR SUPPORT BRACKET		0H3425A0	ST.STEEL UPPER DOOR SUPPORT BRACKET																																					







COMPONENT			SPARE PART																																																																																					
Code	Description	Image	Code	Description	Components list																																																																																			
VM1620A	LED BAR LOWER SUPPORT		KLP1044A	LUX LED BAR KIT	<table border="1"> <thead> <tr> <th>Code</th> <th>Description</th> <th>Qty</th> <th>UOM</th> </tr> </thead> <tbody> <tr> <td>CE1455A0</td> <td>TIP END FITTING</td> <td>2</td> <td>PZ</td> </tr> <tr> <td>CE1730A0</td> <td>PVC CABLE NP 2 X AWG22 STYLE 2095</td> <td>4.500</td> <td>M</td> </tr> <tr> <td>CE1735A0</td> <td>MINIFIT FEMALE END FITTING</td> <td>2</td> <td>PZ</td> </tr> <tr> <td>CE1740A0</td> <td>MINIFIT MALE END FITTING</td> <td>4</td> <td>PZ</td> </tr> <tr> <td>CE1745A0</td> <td>2 WAYS FEMALE MINIFIT CONNECTOR</td> <td>2</td> <td>PZ</td> </tr> <tr> <td>CE1750A0</td> <td>3 WAYS MALE MINIFIT CONNECTOR</td> <td>1</td> <td>PZ</td> </tr> <tr> <td>LP1044A0</td> <td>LUX LED BAR</td> <td>1</td> <td>PZ</td> </tr> <tr> <td>VM1620A0</td> <td>LED BAR LOWER SUPPORT</td> <td>1</td> <td>PZ</td> </tr> <tr> <td>VM1621A0</td> <td>LED BAR UPPER SUPPORT</td> <td>1</td> <td>PZ</td> </tr> </tbody> </table>	Code	Description	Qty	UOM	CE1455A0	TIP END FITTING	2	PZ	CE1730A0	PVC CABLE NP 2 X AWG22 STYLE 2095	4.500	M	CE1735A0	MINIFIT FEMALE END FITTING	2	PZ	CE1740A0	MINIFIT MALE END FITTING	4	PZ	CE1745A0	2 WAYS FEMALE MINIFIT CONNECTOR	2	PZ	CE1750A0	3 WAYS MALE MINIFIT CONNECTOR	1	PZ	LP1044A0	LUX LED BAR	1	PZ	VM1620A0	LED BAR LOWER SUPPORT	1	PZ	VM1621A0	LED BAR UPPER SUPPORT	1	PZ	KLP1007A	L200 LED BAR KIT	<table border="1"> <thead> <tr> <th>Code</th> <th>Description</th> <th>Qty</th> <th>UOM</th> </tr> </thead> <tbody> <tr> <td>CE1455A0</td> <td>TIP END FITTING</td> <td>2</td> <td>PZ</td> </tr> <tr> <td>CE1730A0</td> <td>PVC CABLE NP 2 X AWG22 STYLE 2095</td> <td>4.500</td> <td>M</td> </tr> <tr> <td>CE1735A0</td> <td>MINIFIT FEMALE END FITTING</td> <td>2</td> <td>PZ</td> </tr> <tr> <td>CE1740A0</td> <td>MINIFIT MALE END FITTING</td> <td>4</td> <td>PZ</td> </tr> <tr> <td>CE1745A0</td> <td>2 WAYS FEMALE MINIFIT CONNECTOR</td> <td>2</td> <td>PZ</td> </tr> <tr> <td>CE1750A0</td> <td>3 WAYS MALE MINIFIT CONNECTOR</td> <td>1</td> <td>PZ</td> </tr> <tr> <td>LP1007A0</td> <td>LED LIGHT BAR L200</td> <td>1</td> <td>PZ</td> </tr> <tr> <td>VM1620A0</td> <td>LED BAR LOWER SUPPORT</td> <td>1</td> <td>PZ</td> </tr> <tr> <td>VM1621A0</td> <td>LED BAR UPPER SUPPORT</td> <td>1</td> <td>PZ</td> </tr> </tbody> </table>	Code	Description	Qty	UOM	CE1455A0	TIP END FITTING	2	PZ	CE1730A0	PVC CABLE NP 2 X AWG22 STYLE 2095	4.500	M	CE1735A0	MINIFIT FEMALE END FITTING	2	PZ	CE1740A0	MINIFIT MALE END FITTING	4	PZ	CE1745A0	2 WAYS FEMALE MINIFIT CONNECTOR	2	PZ	CE1750A0	3 WAYS MALE MINIFIT CONNECTOR	1	PZ	LP1007A0	LED LIGHT BAR L200	1	PZ	VM1620A0	LED BAR LOWER SUPPORT	1	PZ	VM1621A0	LED BAR UPPER SUPPORT	1	PZ
			Code	Description	Qty	UOM																																																																																		
CE1455A0	TIP END FITTING	2	PZ																																																																																					
CE1730A0	PVC CABLE NP 2 X AWG22 STYLE 2095	4.500	M																																																																																					
CE1735A0	MINIFIT FEMALE END FITTING	2	PZ																																																																																					
CE1740A0	MINIFIT MALE END FITTING	4	PZ																																																																																					
CE1745A0	2 WAYS FEMALE MINIFIT CONNECTOR	2	PZ																																																																																					
CE1750A0	3 WAYS MALE MINIFIT CONNECTOR	1	PZ																																																																																					
LP1044A0	LUX LED BAR	1	PZ																																																																																					
VM1620A0	LED BAR LOWER SUPPORT	1	PZ																																																																																					
VM1621A0	LED BAR UPPER SUPPORT	1	PZ																																																																																					
Code	Description	Qty	UOM																																																																																					
CE1455A0	TIP END FITTING	2	PZ																																																																																					
CE1730A0	PVC CABLE NP 2 X AWG22 STYLE 2095	4.500	M																																																																																					
CE1735A0	MINIFIT FEMALE END FITTING	2	PZ																																																																																					
CE1740A0	MINIFIT MALE END FITTING	4	PZ																																																																																					
CE1745A0	2 WAYS FEMALE MINIFIT CONNECTOR	2	PZ																																																																																					
CE1750A0	3 WAYS MALE MINIFIT CONNECTOR	1	PZ																																																																																					
LP1007A0	LED LIGHT BAR L200	1	PZ																																																																																					
VM1620A0	LED BAR LOWER SUPPORT	1	PZ																																																																																					
VM1621A0	LED BAR UPPER SUPPORT	1	PZ																																																																																					

COMPONENT			SPARE PART																																														
Code	Description	Image	Code	Description	Components list																																												
VM1620A	LED BAR LOWER SUPPORT		KLP1004B	L1000 LED BAR KIT	<table border="1"> <thead> <tr> <th>Code</th> <th>Description</th> <th>Qty</th> <th>UOM</th> </tr> </thead> <tbody> <tr> <td>CE1730A0</td> <td>PVC CABLE NP 2 X AWG22 STYLE 2095</td> <td>1</td> <td>M</td> </tr> <tr> <td>CE1735A0</td> <td>MINIFIT FEMALE END FITTING</td> <td>2</td> <td>PZ</td> </tr> <tr> <td>CE1740A0</td> <td>MINIFIT MALE END FITTING</td> <td>2</td> <td>PZ</td> </tr> <tr> <td>CE1745A0</td> <td>2 WAYS FEMALE MINIFIT CONNECTOR</td> <td>1</td> <td>PZ</td> </tr> <tr> <td>CE1750A0</td> <td>3 WAYS MALE MINIFIT CONNECTOR</td> <td>1</td> <td>PZ</td> </tr> <tr> <td>IP1385A1</td> <td>CORNER POLYSTYREN E PACKING 110X80X2000</td> <td>2.200</td> <td>M</td> </tr> <tr> <td>LP1004B0</td> <td>LEB LIGHTING BAR L1000</td> <td>1</td> <td>PZ</td> </tr> <tr> <td>VM1059A1</td> <td>HEAT SHRINK FILM H800</td> <td>1.300</td> <td>M</td> </tr> <tr> <td>VM1620A0</td> <td>LED BAR LOWER SUPPORT</td> <td>1</td> <td>PZ</td> </tr> <tr> <td>VM1621A0</td> <td>LED BAR UPPER SUPPORT</td> <td>1</td> <td>PZ</td> </tr> </tbody> </table>	Code	Description	Qty	UOM	CE1730A0	PVC CABLE NP 2 X AWG22 STYLE 2095	1	M	CE1735A0	MINIFIT FEMALE END FITTING	2	PZ	CE1740A0	MINIFIT MALE END FITTING	2	PZ	CE1745A0	2 WAYS FEMALE MINIFIT CONNECTOR	1	PZ	CE1750A0	3 WAYS MALE MINIFIT CONNECTOR	1	PZ	IP1385A1	CORNER POLYSTYREN E PACKING 110X80X2000	2.200	M	LP1004B0	LEB LIGHTING BAR L1000	1	PZ	VM1059A1	HEAT SHRINK FILM H800	1.300	M	VM1620A0	LED BAR LOWER SUPPORT	1	PZ	VM1621A0	LED BAR UPPER SUPPORT	1	PZ
			Code	Description	Qty	UOM																																											
CE1730A0	PVC CABLE NP 2 X AWG22 STYLE 2095	1	M																																														
CE1735A0	MINIFIT FEMALE END FITTING	2	PZ																																														
CE1740A0	MINIFIT MALE END FITTING	2	PZ																																														
CE1745A0	2 WAYS FEMALE MINIFIT CONNECTOR	1	PZ																																														
CE1750A0	3 WAYS MALE MINIFIT CONNECTOR	1	PZ																																														
IP1385A1	CORNER POLYSTYREN E PACKING 110X80X2000	2.200	M																																														
LP1004B0	LEB LIGHTING BAR L1000	1	PZ																																														
VM1059A1	HEAT SHRINK FILM H800	1.300	M																																														
VM1620A0	LED BAR LOWER SUPPORT	1	PZ																																														
VM1621A0	LED BAR UPPER SUPPORT	1	PZ																																														
			KLP1003B	2017 LED BAR KIT	<table border="1"> <thead> <tr> <th>Code</th> <th>Description</th> <th>Qty</th> <th>UOM</th> </tr> </thead> <tbody> <tr> <td>CE1730A0</td> <td>PVC CABLE NP 2 X AWG22 STYLE 2095</td> <td>1</td> <td>M</td> </tr> <tr> <td>CE1735A0</td> <td>MINIFIT FEMALE END FITTING</td> <td>2</td> <td>PZ</td> </tr> <tr> <td>CE1740A0</td> <td>MINIFIT MALE END FITTING</td> <td>2</td> <td>PZ</td> </tr> <tr> <td>CE1745A0</td> <td>2 WAYS FEMALE MINIFIT CONNECTOR</td> <td>1</td> <td>PZ</td> </tr> <tr> <td>CE1750A0</td> <td>3 WAYS MALE MINIFIT CONNECTOR</td> <td>1</td> <td>PZ</td> </tr> <tr> <td>LP1003B0</td> <td>LED LIGHT BAR L600</td> <td>1</td> <td>PZ</td> </tr> <tr> <td>VM1620A0</td> <td>LED BAR LOWER SUPPORT</td> <td>1</td> <td>PZ</td> </tr> <tr> <td>VM1621A0</td> <td>LED BAR UPPER SUPPORT</td> <td>1</td> <td>PZ</td> </tr> </tbody> </table>	Code	Description	Qty	UOM	CE1730A0	PVC CABLE NP 2 X AWG22 STYLE 2095	1	M	CE1735A0	MINIFIT FEMALE END FITTING	2	PZ	CE1740A0	MINIFIT MALE END FITTING	2	PZ	CE1745A0	2 WAYS FEMALE MINIFIT CONNECTOR	1	PZ	CE1750A0	3 WAYS MALE MINIFIT CONNECTOR	1	PZ	LP1003B0	LED LIGHT BAR L600	1	PZ	VM1620A0	LED BAR LOWER SUPPORT	1	PZ	VM1621A0	LED BAR UPPER SUPPORT	1	PZ								
Code	Description	Qty	UOM																																														
CE1730A0	PVC CABLE NP 2 X AWG22 STYLE 2095	1	M																																														
CE1735A0	MINIFIT FEMALE END FITTING	2	PZ																																														
CE1740A0	MINIFIT MALE END FITTING	2	PZ																																														
CE1745A0	2 WAYS FEMALE MINIFIT CONNECTOR	1	PZ																																														
CE1750A0	3 WAYS MALE MINIFIT CONNECTOR	1	PZ																																														
LP1003B0	LED LIGHT BAR L600	1	PZ																																														
VM1620A0	LED BAR LOWER SUPPORT	1	PZ																																														
VM1621A0	LED BAR UPPER SUPPORT	1	PZ																																														

COMPONENT			SPARE PART																																							
Code	Description	Image	Code	Description	Components list																																					
VM1620A	LED BAR LOWER SUPPORT		KLP1003B	2017 LED BAR KIT	<table border="1"> <thead> <tr> <th>Code</th> <th>Description</th> <th>Qty</th> <th>UOM</th> </tr> </thead> <tbody> <tr> <td>VM1794A0</td> <td>250X4.8 PA66 BLACK CLAMP</td> <td>2</td> <td>PZ</td> </tr> <tr> <td>VM2103A0</td> <td>CLAMP LOCK</td> <td>2</td> <td>PZ</td> </tr> </tbody> </table>	Code	Description	Qty	UOM	VM1794A0	250X4.8 PA66 BLACK CLAMP	2	PZ	VM2103A0	CLAMP LOCK	2	PZ																									
			Code	Description	Qty	UOM																																				
VM1794A0	250X4.8 PA66 BLACK CLAMP	2	PZ																																							
VM2103A0	CLAMP LOCK	2	PZ																																							
KLP1002B	L400 LED BAR KIT	<table border="1"> <thead> <tr> <th>Code</th> <th>Description</th> <th>Qty</th> <th>UOM</th> </tr> </thead> <tbody> <tr> <td>CE1455A0</td> <td>TIP END FITTING</td> <td>2</td> <td>PZ</td> </tr> <tr> <td>CE1730A0</td> <td>PVC CABLE NP 2 X AWG22 STYLE 2095</td> <td>4.500</td> <td>M</td> </tr> <tr> <td>CE1735A0</td> <td>MINIFIT FEMALE END FITTING</td> <td>2</td> <td>PZ</td> </tr> <tr> <td>CE1740A0</td> <td>MINIFIT MALE END FITTING</td> <td>4</td> <td>PZ</td> </tr> <tr> <td>CE1745A0</td> <td>2 WAYS FEMALE MINIFIT CONNECTOR</td> <td>2</td> <td>PZ</td> </tr> <tr> <td>CE1750A0</td> <td>3 WAYS MALE MINIFIT CONNECTOR</td> <td>1</td> <td>PZ</td> </tr> <tr> <td>LP1002B0</td> <td>LED LIGHTING BAR L400</td> <td>1</td> <td>PZ</td> </tr> <tr> <td>VM1620A0</td> <td>LED BAR LOWER SUPPORT</td> <td>1</td> <td>PZ</td> </tr> <tr> <td>VM1621A0</td> <td>LED BAR UPPER SUPPORT</td> <td>1</td> <td>PZ</td> </tr> </tbody> </table>	Code	Description	Qty	UOM	CE1455A0	TIP END FITTING	2	PZ	CE1730A0	PVC CABLE NP 2 X AWG22 STYLE 2095	4.500	M	CE1735A0	MINIFIT FEMALE END FITTING	2	PZ	CE1740A0	MINIFIT MALE END FITTING	4	PZ	CE1745A0	2 WAYS FEMALE MINIFIT CONNECTOR	2	PZ	CE1750A0	3 WAYS MALE MINIFIT CONNECTOR	1	PZ	LP1002B0	LED LIGHTING BAR L400	1	PZ	VM1620A0	LED BAR LOWER SUPPORT	1	PZ	VM1621A0	LED BAR UPPER SUPPORT	1	PZ
Code	Description	Qty	UOM																																							
CE1455A0	TIP END FITTING	2	PZ																																							
CE1730A0	PVC CABLE NP 2 X AWG22 STYLE 2095	4.500	M																																							
CE1735A0	MINIFIT FEMALE END FITTING	2	PZ																																							
CE1740A0	MINIFIT MALE END FITTING	4	PZ																																							
CE1745A0	2 WAYS FEMALE MINIFIT CONNECTOR	2	PZ																																							
CE1750A0	3 WAYS MALE MINIFIT CONNECTOR	1	PZ																																							
LP1002B0	LED LIGHTING BAR L400	1	PZ																																							
VM1620A0	LED BAR LOWER SUPPORT	1	PZ																																							
VM1621A0	LED BAR UPPER SUPPORT	1	PZ																																							
KLP1001B	L300 LED BAR KIT	<table border="1"> <thead> <tr> <th>Code</th> <th>Description</th> <th>Qty</th> <th>UOM</th> </tr> </thead> <tbody> <tr> <td>CE1455A0</td> <td>TIP END FITTING</td> <td>2</td> <td>PZ</td> </tr> <tr> <td>CE1730A0</td> <td>PVC CABLE NP 2 X AWG22 STYLE 2095</td> <td>4.500</td> <td>M</td> </tr> <tr> <td>CE1735A0</td> <td>MINIFIT FEMALE END FITTING</td> <td>2</td> <td>PZ</td> </tr> <tr> <td>CE1740A0</td> <td>MINIFIT MALE END FITTING</td> <td>4</td> <td>PZ</td> </tr> <tr> <td>CE1745A0</td> <td>2 WAYS FEMALE MINIFIT CONNECTOR</td> <td>2</td> <td>PZ</td> </tr> <tr> <td>CE1750A0</td> <td>3 WAYS MALE MINIFIT CONNECTOR</td> <td>1</td> <td>PZ</td> </tr> <tr> <td>LP1001B0</td> <td>LED LIGHTING BAR L300</td> <td>1</td> <td>PZ</td> </tr> <tr> <td>VM1620A0</td> <td>LED BAR LOWER SUPPORT</td> <td>1</td> <td>PZ</td> </tr> <tr> <td>VM1621A0</td> <td>LED BAR UPPER SUPPORT</td> <td>1</td> <td>PZ</td> </tr> </tbody> </table>	Code	Description	Qty	UOM	CE1455A0	TIP END FITTING	2	PZ	CE1730A0	PVC CABLE NP 2 X AWG22 STYLE 2095	4.500	M	CE1735A0	MINIFIT FEMALE END FITTING	2	PZ	CE1740A0	MINIFIT MALE END FITTING	4	PZ	CE1745A0	2 WAYS FEMALE MINIFIT CONNECTOR	2	PZ	CE1750A0	3 WAYS MALE MINIFIT CONNECTOR	1	PZ	LP1001B0	LED LIGHTING BAR L300	1	PZ	VM1620A0	LED BAR LOWER SUPPORT	1	PZ	VM1621A0	LED BAR UPPER SUPPORT	1	PZ
Code	Description	Qty	UOM																																							
CE1455A0	TIP END FITTING	2	PZ																																							
CE1730A0	PVC CABLE NP 2 X AWG22 STYLE 2095	4.500	M																																							
CE1735A0	MINIFIT FEMALE END FITTING	2	PZ																																							
CE1740A0	MINIFIT MALE END FITTING	4	PZ																																							
CE1745A0	2 WAYS FEMALE MINIFIT CONNECTOR	2	PZ																																							
CE1750A0	3 WAYS MALE MINIFIT CONNECTOR	1	PZ																																							
LP1001B0	LED LIGHTING BAR L300	1	PZ																																							
VM1620A0	LED BAR LOWER SUPPORT	1	PZ																																							
VM1621A0	LED BAR UPPER SUPPORT	1	PZ																																							

COMPONENT			SPARE PART																																										
Code	Description	Image	Code	Description	Components list																																								
VM1620A	LED BAR LOWER SUPPORT		KLP1000A	L100 LED BAR KIT	<table border="1"> <thead> <tr> <th>Code</th> <th>Description</th> <th>Qty</th> <th>UOM</th> </tr> </thead> <tbody> <tr> <td>LP1000A0</td> <td>LED LIGHTING BAR L100</td> <td>1</td> <td>PZ</td> </tr> <tr> <td>VM1620A0</td> <td>LED BAR LOWER SUPPORT</td> <td>1</td> <td>PZ</td> </tr> <tr> <td>VM1621A0</td> <td>LED BAR UPPER SUPPORT</td> <td>1</td> <td>PZ</td> </tr> </tbody> </table>	Code	Description	Qty	UOM	LP1000A0	LED LIGHTING BAR L100	1	PZ	VM1620A0	LED BAR LOWER SUPPORT	1	PZ	VM1621A0	LED BAR UPPER SUPPORT	1	PZ																								
					Code	Description	Qty	UOM																																					
LP1000A0	LED LIGHTING BAR L100	1	PZ																																										
VM1620A0	LED BAR LOWER SUPPORT	1	PZ																																										
VM1621A0	LED BAR UPPER SUPPORT	1	PZ																																										
VM1621A	LED BAR UPPER SUPPORT		KLP1044A	LUX LED BAR KIT	<table border="1"> <thead> <tr> <th>Code</th> <th>Description</th> <th>Qty</th> <th>UOM</th> </tr> </thead> <tbody> <tr> <td>CE1455A0</td> <td>TIP END FITTING</td> <td>2</td> <td>PZ</td> </tr> <tr> <td>CE1730A0</td> <td>PVC CABLE NP 2 X AWG22 STYLE 2095</td> <td>4.500</td> <td>M</td> </tr> <tr> <td>CE1735A0</td> <td>MINIFIT FEMALE END FITTING</td> <td>2</td> <td>PZ</td> </tr> <tr> <td>CE1740A0</td> <td>MINIFIT MALE END FITTING</td> <td>4</td> <td>PZ</td> </tr> <tr> <td>CE1745A0</td> <td>2 WAYS FEMALE MINIFIT CONNECTOR</td> <td>2</td> <td>PZ</td> </tr> <tr> <td>CE1750A0</td> <td>3 WAYS MALE MINIFIT CONNECTOR</td> <td>1</td> <td>PZ</td> </tr> <tr> <td>LP1044A0</td> <td>LUX LED BAR</td> <td>1</td> <td>PZ</td> </tr> <tr> <td>VM1620A0</td> <td>LED BAR LOWER SUPPORT</td> <td>1</td> <td>PZ</td> </tr> <tr> <td>VM1621A0</td> <td>LED BAR UPPER SUPPORT</td> <td>1</td> <td>PZ</td> </tr> </tbody> </table>	Code	Description	Qty	UOM	CE1455A0	TIP END FITTING	2	PZ	CE1730A0	PVC CABLE NP 2 X AWG22 STYLE 2095	4.500	M	CE1735A0	MINIFIT FEMALE END FITTING	2	PZ	CE1740A0	MINIFIT MALE END FITTING	4	PZ	CE1745A0	2 WAYS FEMALE MINIFIT CONNECTOR	2	PZ	CE1750A0	3 WAYS MALE MINIFIT CONNECTOR	1	PZ	LP1044A0	LUX LED BAR	1	PZ	VM1620A0	LED BAR LOWER SUPPORT	1	PZ	VM1621A0	LED BAR UPPER SUPPORT	1	PZ
					Code	Description	Qty	UOM																																					
					CE1455A0	TIP END FITTING	2	PZ																																					
					CE1730A0	PVC CABLE NP 2 X AWG22 STYLE 2095	4.500	M																																					
					CE1735A0	MINIFIT FEMALE END FITTING	2	PZ																																					
					CE1740A0	MINIFIT MALE END FITTING	4	PZ																																					
					CE1745A0	2 WAYS FEMALE MINIFIT CONNECTOR	2	PZ																																					
					CE1750A0	3 WAYS MALE MINIFIT CONNECTOR	1	PZ																																					
					LP1044A0	LUX LED BAR	1	PZ																																					
					VM1620A0	LED BAR LOWER SUPPORT	1	PZ																																					
					VM1621A0	LED BAR UPPER SUPPORT	1	PZ																																					
					KLP1007A	L200 LED BAR KIT	<table border="1"> <thead> <tr> <th>Code</th> <th>Description</th> <th>Qty</th> <th>UOM</th> </tr> </thead> <tbody> <tr> <td>CE1455A0</td> <td>TIP END FITTING</td> <td>2</td> <td>PZ</td> </tr> <tr> <td>CE1730A0</td> <td>PVC CABLE NP 2 X AWG22 STYLE 2095</td> <td>4.500</td> <td>M</td> </tr> <tr> <td>CE1735A0</td> <td>MINIFIT FEMALE END FITTING</td> <td>2</td> <td>PZ</td> </tr> <tr> <td>CE1740A0</td> <td>MINIFIT MALE END FITTING</td> <td>4</td> <td>PZ</td> </tr> <tr> <td>CE1745A0</td> <td>2 WAYS FEMALE MINIFIT CONNECTOR</td> <td>2</td> <td>PZ</td> </tr> <tr> <td>CE1750A0</td> <td>3 WAYS MALE MINIFIT CONNECTOR</td> <td>1</td> <td>PZ</td> </tr> <tr> <td>LP1007A0</td> <td>LED LIGHT BAR L200</td> <td>1</td> <td>PZ</td> </tr> </tbody> </table>	Code	Description	Qty	UOM	CE1455A0	TIP END FITTING	2	PZ	CE1730A0	PVC CABLE NP 2 X AWG22 STYLE 2095	4.500	M	CE1735A0	MINIFIT FEMALE END FITTING	2	PZ	CE1740A0	MINIFIT MALE END FITTING	4	PZ	CE1745A0	2 WAYS FEMALE MINIFIT CONNECTOR	2	PZ	CE1750A0	3 WAYS MALE MINIFIT CONNECTOR	1	PZ	LP1007A0	LED LIGHT BAR L200	1	PZ						
			Code	Description			Qty	UOM																																					
			CE1455A0	TIP END FITTING	2	PZ																																							
CE1730A0	PVC CABLE NP 2 X AWG22 STYLE 2095	4.500	M																																										
CE1735A0	MINIFIT FEMALE END FITTING	2	PZ																																										
CE1740A0	MINIFIT MALE END FITTING	4	PZ																																										
CE1745A0	2 WAYS FEMALE MINIFIT CONNECTOR	2	PZ																																										
CE1750A0	3 WAYS MALE MINIFIT CONNECTOR	1	PZ																																										
LP1007A0	LED LIGHT BAR L200	1	PZ																																										

COMPONENT			SPARE PART																																											
Code	Description	Image	Code	Description	Components list																																									
VM1621A	LED BAR UPPER SUPPORT		KLP1007A	L200 LED BAR KIT	<table border="1"> <thead> <tr> <th>Code</th> <th>Description</th> <th>Qty</th> <th>UOM</th> </tr> </thead> <tbody> <tr> <td>VM1620A0</td> <td>LED BAR LOWER SUPPORT</td> <td>1</td> <td>PZ</td> </tr> <tr> <td>VM1621A0</td> <td>LED BAR UPPER SUPPORT</td> <td>1</td> <td>PZ</td> </tr> </tbody> </table>	Code	Description	Qty	UOM	VM1620A0	LED BAR LOWER SUPPORT	1	PZ	VM1621A0	LED BAR UPPER SUPPORT	1	PZ																													
			Code	Description	Qty	UOM																																								
			VM1620A0	LED BAR LOWER SUPPORT	1	PZ																																								
VM1621A0	LED BAR UPPER SUPPORT	1	PZ																																											
KLP1004B	L1000 LED BAR KIT	<table border="1"> <thead> <tr> <th>Code</th> <th>Description</th> <th>Qty</th> <th>UOM</th> </tr> </thead> <tbody> <tr> <td>CE1730A0</td> <td>PVC CABLE NP 2 X AWG22 STYLE 2095</td> <td>1</td> <td>M</td> </tr> <tr> <td>CE1735A0</td> <td>MINIFIT FEMALE END FITTING</td> <td>2</td> <td>PZ</td> </tr> <tr> <td>CE1740A0</td> <td>MINIFIT MALE END FITTING</td> <td>2</td> <td>PZ</td> </tr> <tr> <td>CE1745A0</td> <td>2 WAYS FEMALE MINIFIT CONNECTOR</td> <td>1</td> <td>PZ</td> </tr> <tr> <td>CE1750A0</td> <td>3 WAYS MALE MINIFIT CONNECTOR</td> <td>1</td> <td>PZ</td> </tr> <tr> <td>IP1385A1</td> <td>CORNER POLYSTYRENE PACKING 110X80X2000</td> <td>2.200</td> <td>M</td> </tr> <tr> <td>LP1004B0</td> <td>LEB LIGHTING BAR L1000</td> <td>1</td> <td>PZ</td> </tr> <tr> <td>VM1059A1</td> <td>HEAT SHRINK FILM H800</td> <td>1.300</td> <td>M</td> </tr> <tr> <td>VM1620A0</td> <td>LED BAR LOWER SUPPORT</td> <td>1</td> <td>PZ</td> </tr> <tr> <td>VM1621A0</td> <td>LED BAR UPPER SUPPORT</td> <td>1</td> <td>PZ</td> </tr> </tbody> </table>	Code	Description	Qty	UOM	CE1730A0	PVC CABLE NP 2 X AWG22 STYLE 2095	1	M	CE1735A0	MINIFIT FEMALE END FITTING	2	PZ	CE1740A0	MINIFIT MALE END FITTING	2	PZ	CE1745A0	2 WAYS FEMALE MINIFIT CONNECTOR	1	PZ	CE1750A0	3 WAYS MALE MINIFIT CONNECTOR	1	PZ	IP1385A1	CORNER POLYSTYRENE PACKING 110X80X2000	2.200	M	LP1004B0	LEB LIGHTING BAR L1000	1	PZ	VM1059A1	HEAT SHRINK FILM H800	1.300	M	VM1620A0	LED BAR LOWER SUPPORT	1	PZ	VM1621A0	LED BAR UPPER SUPPORT	1	PZ
Code	Description	Qty	UOM																																											
CE1730A0	PVC CABLE NP 2 X AWG22 STYLE 2095	1	M																																											
CE1735A0	MINIFIT FEMALE END FITTING	2	PZ																																											
CE1740A0	MINIFIT MALE END FITTING	2	PZ																																											
CE1745A0	2 WAYS FEMALE MINIFIT CONNECTOR	1	PZ																																											
CE1750A0	3 WAYS MALE MINIFIT CONNECTOR	1	PZ																																											
IP1385A1	CORNER POLYSTYRENE PACKING 110X80X2000	2.200	M																																											
LP1004B0	LEB LIGHTING BAR L1000	1	PZ																																											
VM1059A1	HEAT SHRINK FILM H800	1.300	M																																											
VM1620A0	LED BAR LOWER SUPPORT	1	PZ																																											
VM1621A0	LED BAR UPPER SUPPORT	1	PZ																																											
KLP1003B	2017 LED BAR KIT	<table border="1"> <thead> <tr> <th>Code</th> <th>Description</th> <th>Qty</th> <th>UOM</th> </tr> </thead> <tbody> <tr> <td>CE1730A0</td> <td>PVC CABLE NP 2 X AWG22 STYLE 2095</td> <td>1</td> <td>M</td> </tr> <tr> <td>CE1735A0</td> <td>MINIFIT FEMALE END FITTING</td> <td>2</td> <td>PZ</td> </tr> <tr> <td>CE1740A0</td> <td>MINIFIT MALE END FITTING</td> <td>2</td> <td>PZ</td> </tr> <tr> <td>CE1745A0</td> <td>2 WAYS FEMALE MINIFIT CONNECTOR</td> <td>1</td> <td>PZ</td> </tr> <tr> <td>CE1750A0</td> <td>3 WAYS MALE MINIFIT CONNECTOR</td> <td>1</td> <td>PZ</td> </tr> <tr> <td>LP1003B0</td> <td>LED LIGHT BAR L600</td> <td>1</td> <td>PZ</td> </tr> </tbody> </table>	Code	Description	Qty	UOM	CE1730A0	PVC CABLE NP 2 X AWG22 STYLE 2095	1	M	CE1735A0	MINIFIT FEMALE END FITTING	2	PZ	CE1740A0	MINIFIT MALE END FITTING	2	PZ	CE1745A0	2 WAYS FEMALE MINIFIT CONNECTOR	1	PZ	CE1750A0	3 WAYS MALE MINIFIT CONNECTOR	1	PZ	LP1003B0	LED LIGHT BAR L600	1	PZ																
Code	Description	Qty	UOM																																											
CE1730A0	PVC CABLE NP 2 X AWG22 STYLE 2095	1	M																																											
CE1735A0	MINIFIT FEMALE END FITTING	2	PZ																																											
CE1740A0	MINIFIT MALE END FITTING	2	PZ																																											
CE1745A0	2 WAYS FEMALE MINIFIT CONNECTOR	1	PZ																																											
CE1750A0	3 WAYS MALE MINIFIT CONNECTOR	1	PZ																																											
LP1003B0	LED LIGHT BAR L600	1	PZ																																											

COMPONENT			SPARE PART																																										
Code	Description	Image	Code	Description	Components list																																								
VM1621A	LED BAR UPPER SUPPORT		KLP1003B	2017 LED BAR KIT	<table border="1"> <thead> <tr> <th>Code</th> <th>Description</th> <th>Qty</th> <th>UOM</th> </tr> </thead> <tbody> <tr> <td>VM1620A0</td> <td>LED BAR LOWER SUPPORT</td> <td>1</td> <td>PZ</td> </tr> <tr> <td>VM1621A0</td> <td>LED BAR UPPER SUPPORT</td> <td>1</td> <td>PZ</td> </tr> <tr> <td>VM1794A0</td> <td>250X4.8 PA66 BLACK CLAMP</td> <td>2</td> <td>PZ</td> </tr> <tr> <td>VM2103A0</td> <td>CLAMP LOCK</td> <td>2</td> <td>PZ</td> </tr> </tbody> </table>	Code	Description	Qty	UOM	VM1620A0	LED BAR LOWER SUPPORT	1	PZ	VM1621A0	LED BAR UPPER SUPPORT	1	PZ	VM1794A0	250X4.8 PA66 BLACK CLAMP	2	PZ	VM2103A0	CLAMP LOCK	2	PZ																				
			Code	Description	Qty	UOM																																							
			VM1620A0	LED BAR LOWER SUPPORT	1	PZ																																							
			VM1621A0	LED BAR UPPER SUPPORT	1	PZ																																							
			VM1794A0	250X4.8 PA66 BLACK CLAMP	2	PZ																																							
			VM2103A0	CLAMP LOCK	2	PZ																																							
			KLP1002B	L400 LED BAR KIT	<table border="1"> <thead> <tr> <th>Code</th> <th>Description</th> <th>Qty</th> <th>UOM</th> </tr> </thead> <tbody> <tr> <td>CE1455A0</td> <td>TIP END FITTING</td> <td>2</td> <td>PZ</td> </tr> <tr> <td>CE1730A0</td> <td>PVC CABLE NP 2 X AWG22 STYLE 2095</td> <td>4.500</td> <td>M</td> </tr> <tr> <td>CE1735A0</td> <td>MINIFIT FEMALE END FITTING</td> <td>2</td> <td>PZ</td> </tr> <tr> <td>CE1740A0</td> <td>MINIFIT MALE END FITTING</td> <td>4</td> <td>PZ</td> </tr> <tr> <td>CE1745A0</td> <td>2 WAYS FEMALE MINIFIT CONNECTOR</td> <td>2</td> <td>PZ</td> </tr> <tr> <td>CE1750A0</td> <td>3 WAYS MALE MINIFIT CONNECTOR</td> <td>1</td> <td>PZ</td> </tr> <tr> <td>LP1002B0</td> <td>LED LIGHTING BAR L400</td> <td>1</td> <td>PZ</td> </tr> <tr> <td>VM1620A0</td> <td>LED BAR LOWER SUPPORT</td> <td>1</td> <td>PZ</td> </tr> <tr> <td>VM1621A0</td> <td>LED BAR UPPER SUPPORT</td> <td>1</td> <td>PZ</td> </tr> </tbody> </table>	Code	Description	Qty	UOM	CE1455A0	TIP END FITTING	2	PZ	CE1730A0	PVC CABLE NP 2 X AWG22 STYLE 2095	4.500	M	CE1735A0	MINIFIT FEMALE END FITTING	2	PZ	CE1740A0	MINIFIT MALE END FITTING	4	PZ	CE1745A0	2 WAYS FEMALE MINIFIT CONNECTOR	2	PZ	CE1750A0	3 WAYS MALE MINIFIT CONNECTOR	1	PZ	LP1002B0	LED LIGHTING BAR L400	1	PZ	VM1620A0	LED BAR LOWER SUPPORT	1	PZ	VM1621A0	LED BAR UPPER SUPPORT	1	PZ
			Code	Description	Qty	UOM																																							
			CE1455A0	TIP END FITTING	2	PZ																																							
			CE1730A0	PVC CABLE NP 2 X AWG22 STYLE 2095	4.500	M																																							
			CE1735A0	MINIFIT FEMALE END FITTING	2	PZ																																							
			CE1740A0	MINIFIT MALE END FITTING	4	PZ																																							
CE1745A0	2 WAYS FEMALE MINIFIT CONNECTOR	2	PZ																																										
CE1750A0	3 WAYS MALE MINIFIT CONNECTOR	1	PZ																																										
LP1002B0	LED LIGHTING BAR L400	1	PZ																																										
VM1620A0	LED BAR LOWER SUPPORT	1	PZ																																										
VM1621A0	LED BAR UPPER SUPPORT	1	PZ																																										
KLP1001B	L300 LED BAR KIT	<table border="1"> <thead> <tr> <th>Code</th> <th>Description</th> <th>Qty</th> <th>UOM</th> </tr> </thead> <tbody> <tr> <td>CE1455A0</td> <td>TIP END FITTING</td> <td>2</td> <td>PZ</td> </tr> <tr> <td>CE1730A0</td> <td>PVC CABLE NP 2 X AWG22 STYLE 2095</td> <td>4.500</td> <td>M</td> </tr> <tr> <td>CE1735A0</td> <td>MINIFIT FEMALE END FITTING</td> <td>2</td> <td>PZ</td> </tr> <tr> <td>CE1740A0</td> <td>MINIFIT MALE END FITTING</td> <td>4</td> <td>PZ</td> </tr> <tr> <td>CE1745A0</td> <td>2 WAYS FEMALE MINIFIT CONNECTOR</td> <td>2</td> <td>PZ</td> </tr> <tr> <td>CE1750A0</td> <td>3 WAYS MALE MINIFIT CONNECTOR</td> <td>1</td> <td>PZ</td> </tr> </tbody> </table>	Code	Description	Qty	UOM	CE1455A0	TIP END FITTING	2	PZ	CE1730A0	PVC CABLE NP 2 X AWG22 STYLE 2095	4.500	M	CE1735A0	MINIFIT FEMALE END FITTING	2	PZ	CE1740A0	MINIFIT MALE END FITTING	4	PZ	CE1745A0	2 WAYS FEMALE MINIFIT CONNECTOR	2	PZ	CE1750A0	3 WAYS MALE MINIFIT CONNECTOR	1	PZ															
Code	Description	Qty	UOM																																										
CE1455A0	TIP END FITTING	2	PZ																																										
CE1730A0	PVC CABLE NP 2 X AWG22 STYLE 2095	4.500	M																																										
CE1735A0	MINIFIT FEMALE END FITTING	2	PZ																																										
CE1740A0	MINIFIT MALE END FITTING	4	PZ																																										
CE1745A0	2 WAYS FEMALE MINIFIT CONNECTOR	2	PZ																																										
CE1750A0	3 WAYS MALE MINIFIT CONNECTOR	1	PZ																																										



COMPONENT			SPARE PART																		
Code	Description	Image	Code	Description	Components list																
VM1621A	LED BAR UPPER SUPPORT		KLP1001B	L300 LED BAR KIT	<table border="1"> <thead> <tr> <th>Code</th> <th>Description</th> <th>Qty</th> <th>UOM</th> </tr> </thead> <tbody> <tr> <td>LP1001B0</td> <td>LED LIGHTING BAR L300</td> <td>1</td> <td>PZ</td> </tr> <tr> <td>VM1620A0</td> <td>LED BAR LOWER SUPPORT</td> <td>1</td> <td>PZ</td> </tr> <tr> <td>VM1621A0</td> <td>LED BAR UPPER SUPPORT</td> <td>1</td> <td>PZ</td> </tr> </tbody> </table>	Code	Description	Qty	UOM	LP1001B0	LED LIGHTING BAR L300	1	PZ	VM1620A0	LED BAR LOWER SUPPORT	1	PZ	VM1621A0	LED BAR UPPER SUPPORT	1	PZ
			Code	Description	Qty	UOM															
LP1001B0	LED LIGHTING BAR L300	1	PZ																		
VM1620A0	LED BAR LOWER SUPPORT	1	PZ																		
VM1621A0	LED BAR UPPER SUPPORT	1	PZ																		
KLP1000A	L100 LED BAR KIT	<table border="1"> <thead> <tr> <th>Code</th> <th>Description</th> <th>Qty</th> <th>UOM</th> </tr> </thead> <tbody> <tr> <td>LP1000A0</td> <td>LED LIGHTING BAR L100</td> <td>1</td> <td>PZ</td> </tr> <tr> <td>VM1620A0</td> <td>LED BAR LOWER SUPPORT</td> <td>1</td> <td>PZ</td> </tr> <tr> <td>VM1621A0</td> <td>LED BAR UPPER SUPPORT</td> <td>1</td> <td>PZ</td> </tr> </tbody> </table>	Code	Description	Qty	UOM	LP1000A0	LED LIGHTING BAR L100	1	PZ	VM1620A0	LED BAR LOWER SUPPORT	1	PZ	VM1621A0	LED BAR UPPER SUPPORT	1	PZ			
Code	Description	Qty	UOM																		
LP1000A0	LED LIGHTING BAR L100	1	PZ																		
VM1620A0	LED BAR LOWER SUPPORT	1	PZ																		
VM1621A0	LED BAR UPPER SUPPORT	1	PZ																		



ASM1571A/0.D00 -



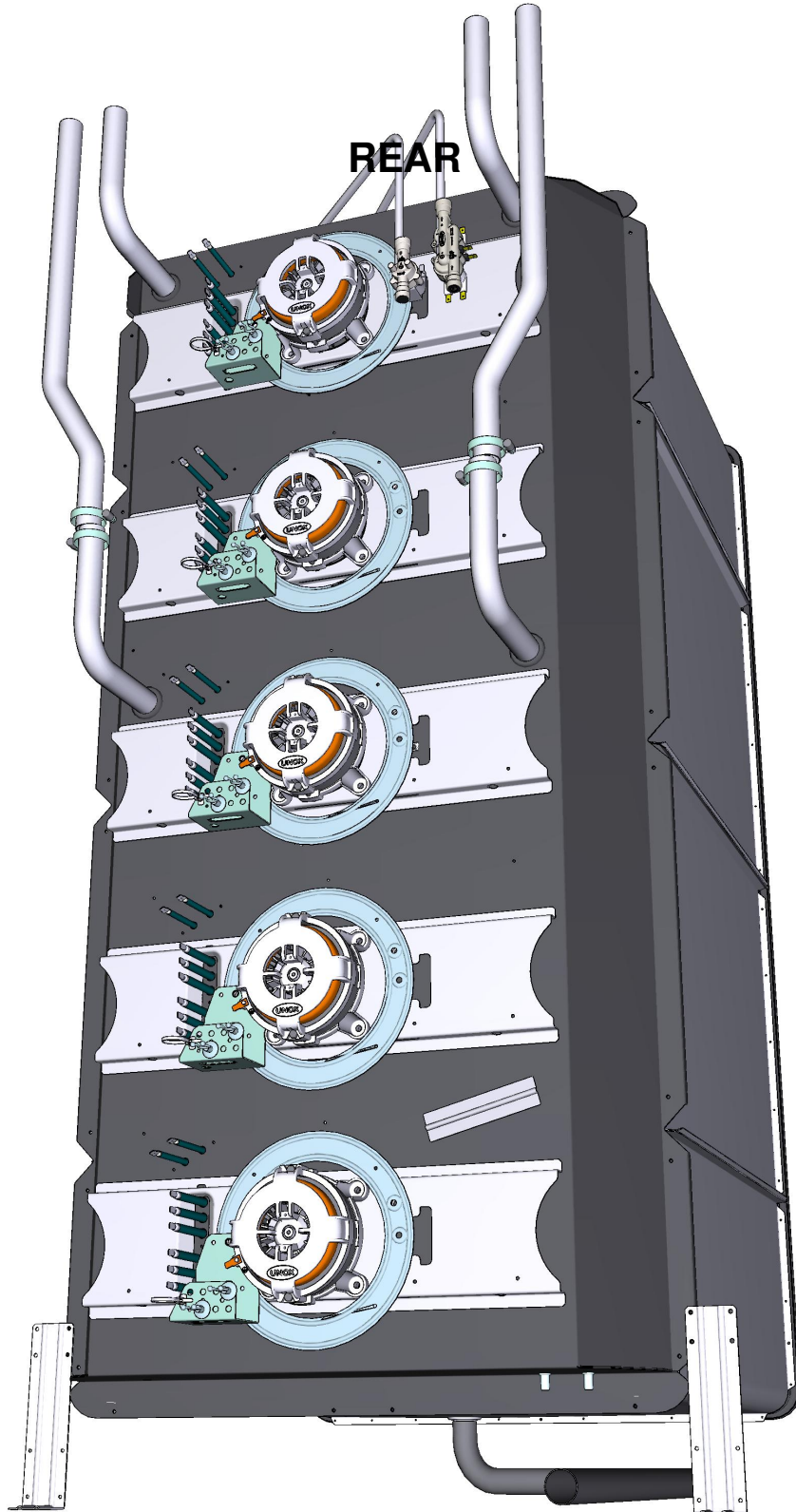

ASM1571A/0.D00 -

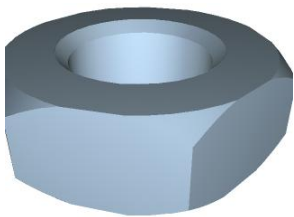

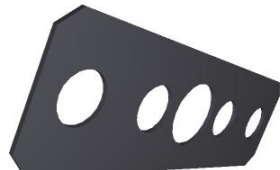

COMPONENT			SPARE PART																																																		
Code	Description	Image	Code	Description	Components list																																																
RC1170A	STAINLESS STEEL NUT M14 H=8 CH=22		KRC1170A	M14 H8 CH22 NUT - 10 PCS. KIT	<table border="1"> <thead> <tr> <th>Code</th> <th>Description</th> <th>Qty</th> <th>UOM</th> </tr> </thead> <tbody> <tr> <td>RC1170A1</td> <td>STAINLESS STEEL NUT M14 H=8 CH=22</td> <td>10</td> <td>PZ</td> </tr> <tr> <td>VM1224A0</td> <td>65MY 220MM 2 COLOURS SHRINK TUBE</td> <td>0.200</td> <td>M</td> </tr> </tbody> </table>	Code	Description	Qty	UOM	RC1170A1	STAINLESS STEEL NUT M14 H=8 CH=22	10	PZ	VM1224A0	65MY 220MM 2 COLOURS SHRINK TUBE	0.200	M																																				
Code	Description	Qty	UOM																																																		
RC1170A1	STAINLESS STEEL NUT M14 H=8 CH=22	10	PZ																																																		
VM1224A0	65MY 220MM 2 COLOURS SHRINK TUBE	0.200	M																																																		
RS1180A	9 KW 230V 6 TURNS CIRC. HEATING ELEMENT		KRS1180A	9KW 6 TURNS CIRC. HEATING ELEMENT KIT	<table border="1"> <thead> <tr> <th>Code</th> <th>Description</th> <th>Qty</th> <th>UOM</th> </tr> </thead> <tbody> <tr> <td>GN1086A0</td> <td>ELEMENT SEALING</td> <td>1</td> <td>PZ</td> </tr> <tr> <td>GN1671A0</td> <td>141X22 G8.5 ELEMENT ARMED GASKET</td> <td>1</td> <td>PZ</td> </tr> <tr> <td>MOV0008A0</td> <td>HOOD RING GASKET GN1110A2</td> <td>0.100</td> <td>PZ</td> </tr> <tr> <td>RS1180A1</td> <td>9 KW 230V 6 TURNS CIRC. HEATING ELEMENT</td> <td>1</td> <td>PZ</td> </tr> <tr> <td>SL1045A0</td> <td>S57 BLACK SILICONE - 80ML CARTRIDGE</td> <td>1</td> <td>PZ</td> </tr> <tr> <td>VI1032A0</td> <td>SCREW M4X16 TCB+ INOX</td> <td>1</td> <td>PZ</td> </tr> <tr> <td>VI1075A0</td> <td>NUT M4 H=4 UNI5587 INOX</td> <td>1</td> <td>PZ</td> </tr> <tr> <td>VI1220A1</td> <td>4,2X12 TCB SELF-TAPPIN G SCREW</td> <td>6</td> <td>PZ</td> </tr> <tr> <td>VI1511A0</td> <td>STAINLESS STEEL WASHER 4.2X12X1</td> <td>1</td> <td>PZ</td> </tr> <tr> <td>VM1794A0</td> <td>250X4.8 PA66 BLACK CLAMP</td> <td>2</td> <td>PZ</td> </tr> <tr> <td>VM2103A0</td> <td>CLAMP LOCK</td> <td>2</td> <td>PZ</td> </tr> </tbody> </table>	Code	Description	Qty	UOM	GN1086A0	ELEMENT SEALING	1	PZ	GN1671A0	141X22 G8.5 ELEMENT ARMED GASKET	1	PZ	MOV0008A0	HOOD RING GASKET GN1110A2	0.100	PZ	RS1180A1	9 KW 230V 6 TURNS CIRC. HEATING ELEMENT	1	PZ	SL1045A0	S57 BLACK SILICONE - 80ML CARTRIDGE	1	PZ	VI1032A0	SCREW M4X16 TCB+ INOX	1	PZ	VI1075A0	NUT M4 H=4 UNI5587 INOX	1	PZ	VI1220A1	4,2X12 TCB SELF-TAPPIN G SCREW	6	PZ	VI1511A0	STAINLESS STEEL WASHER 4.2X12X1	1	PZ	VM1794A0	250X4.8 PA66 BLACK CLAMP	2	PZ	VM2103A0	CLAMP LOCK	2	PZ
Code	Description	Qty	UOM																																																		
GN1086A0	ELEMENT SEALING	1	PZ																																																		
GN1671A0	141X22 G8.5 ELEMENT ARMED GASKET	1	PZ																																																		
MOV0008A0	HOOD RING GASKET GN1110A2	0.100	PZ																																																		
RS1180A1	9 KW 230V 6 TURNS CIRC. HEATING ELEMENT	1	PZ																																																		
SL1045A0	S57 BLACK SILICONE - 80ML CARTRIDGE	1	PZ																																																		
VI1032A0	SCREW M4X16 TCB+ INOX	1	PZ																																																		
VI1075A0	NUT M4 H=4 UNI5587 INOX	1	PZ																																																		
VI1220A1	4,2X12 TCB SELF-TAPPIN G SCREW	6	PZ																																																		
VI1511A0	STAINLESS STEEL WASHER 4.2X12X1	1	PZ																																																		
VM1794A0	250X4.8 PA66 BLACK CLAMP	2	PZ																																																		
VM2103A0	CLAMP LOCK	2	PZ																																																		
RS1215A	147W 105V BRAKING ELEMENT		KRS1215B	147W MOTOR BRAKING ELEMENT KIT	<table border="1"> <thead> <tr> <th>Code</th> <th>Description</th> <th>Qty</th> <th>UOM</th> </tr> </thead> <tbody> <tr> <td>GN1672A1</td> <td>RS1274A ELEMENT GASKET</td> <td>1</td> <td>PZ</td> </tr> <tr> <td>MOV0009A0</td> <td>HOOD RING GASKET GN1110A2</td> <td>0.100</td> <td>PZ</td> </tr> <tr> <td>RS1215B0</td> <td>1 TURN 147W 105V FLAT ELEMENT</td> <td>1</td> <td>PZ</td> </tr> </tbody> </table>	Code	Description	Qty	UOM	GN1672A1	RS1274A ELEMENT GASKET	1	PZ	MOV0009A0	HOOD RING GASKET GN1110A2	0.100	PZ	RS1215B0	1 TURN 147W 105V FLAT ELEMENT	1	PZ																																
Code	Description	Qty	UOM																																																		
GN1672A1	RS1274A ELEMENT GASKET	1	PZ																																																		
MOV0009A0	HOOD RING GASKET GN1110A2	0.100	PZ																																																		
RS1215B0	1 TURN 147W 105V FLAT ELEMENT	1	PZ																																																		

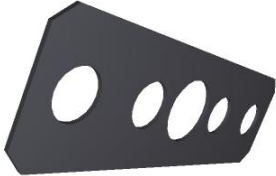

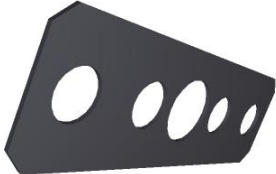

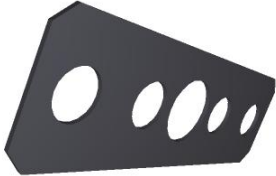
COMPONENT			SPARE PART																																		
Code	Description	Image	Code	Description	Components list																																
RS1215A	147W 105V BRAKING ELEMENT		KRS1215B	147W MOTOR BRAKING ELEMENT KIT	<table border="1"> <thead> <tr> <th>Code</th> <th>Description</th> <th>Qty</th> <th>UOM</th> </tr> </thead> <tbody> <tr> <td>SL1045A0</td> <td>S57 BLACK SILICONE - 80ML CARTRIDGE</td> <td>1</td> <td>PZ</td> </tr> <tr> <td>VI1220A1</td> <td>4,2X12 TCB SELF-TAPPIN G SCREW</td> <td>2</td> <td>PZ</td> </tr> </tbody> </table>	Code	Description	Qty	UOM	SL1045A0	S57 BLACK SILICONE - 80ML CARTRIDGE	1	PZ	VI1220A1	4,2X12 TCB SELF-TAPPIN G SCREW	2	PZ																				
			Code	Description	Qty	UOM																															
SL1045A0	S57 BLACK SILICONE - 80ML CARTRIDGE	1	PZ																																		
VI1220A1	4,2X12 TCB SELF-TAPPIN G SCREW	2	PZ																																		
KRS0026A	BIG-L 147W MOTOR BRAKING ELEMENT KIT	<table border="1"> <thead> <tr> <th>Code</th> <th>Description</th> <th>Qty</th> <th>UOM</th> </tr> </thead> <tbody> <tr> <td>GN1672A0</td> <td></td> <td>1</td> <td>PZ</td> </tr> <tr> <td>GN1672A1</td> <td>RS1274A ELEMENT GASKET</td> <td>1</td> <td>PZ</td> </tr> <tr> <td>RS1215A1</td> <td>147W 105V BRAKING ELEMENT</td> <td>1</td> <td>PZ</td> </tr> <tr> <td>SL1045A0</td> <td>S57 BLACK SILICONE - 80ML CARTRIDGE</td> <td>1</td> <td>PZ</td> </tr> <tr> <td>VI1220A1</td> <td>4,2X12 TCB SELF-TAPPIN G SCREW</td> <td>2</td> <td>PZ</td> </tr> </tbody> </table>	Code	Description	Qty	UOM	GN1672A0		1	PZ	GN1672A1	RS1274A ELEMENT GASKET	1	PZ	RS1215A1	147W 105V BRAKING ELEMENT	1	PZ	SL1045A0	S57 BLACK SILICONE - 80ML CARTRIDGE	1	PZ	VI1220A1	4,2X12 TCB SELF-TAPPIN G SCREW	2	PZ											
Code	Description	Qty	UOM																																		
GN1672A0		1	PZ																																		
GN1672A1	RS1274A ELEMENT GASKET	1	PZ																																		
RS1215A1	147W 105V BRAKING ELEMENT	1	PZ																																		
SL1045A0	S57 BLACK SILICONE - 80ML CARTRIDGE	1	PZ																																		
VI1220A1	4,2X12 TCB SELF-TAPPIN G SCREW	2	PZ																																		
GN1326A	ELEMENT SEALING		KRS1274A	100W MOTOR BRAKING ELEMENT KIT	<table border="1"> <thead> <tr> <th>Code</th> <th>Description</th> <th>Qty</th> <th>UOM</th> </tr> </thead> <tbody> <tr> <td>GN1326A1</td> <td>ELEMENT SEALING</td> <td>1</td> <td>PZ</td> </tr> <tr> <td>GN1672A0</td> <td></td> <td>1</td> <td>PZ</td> </tr> <tr> <td>GN1672A1</td> <td>RS1274A ELEMENT GASKET</td> <td>1</td> <td>PZ</td> </tr> <tr> <td>MOV0009A0</td> <td>HOOD RING GASKET GN1110A2</td> <td>0.100</td> <td>PZ</td> </tr> <tr> <td>RS1274A0</td> <td>100W 60V 1 TURN FLAT ELEMENT</td> <td>1</td> <td>PZ</td> </tr> <tr> <td>SL1045A0</td> <td>S57 BLACK SILICONE - 80ML CARTRIDGE</td> <td>1</td> <td>PZ</td> </tr> <tr> <td>VI1220A1</td> <td>4,2X12 TCB SELF-TAPPIN G SCREW</td> <td>2</td> <td>PZ</td> </tr> </tbody> </table>	Code	Description	Qty	UOM	GN1326A1	ELEMENT SEALING	1	PZ	GN1672A0		1	PZ	GN1672A1	RS1274A ELEMENT GASKET	1	PZ	MOV0009A0	HOOD RING GASKET GN1110A2	0.100	PZ	RS1274A0	100W 60V 1 TURN FLAT ELEMENT	1	PZ	SL1045A0	S57 BLACK SILICONE - 80ML CARTRIDGE	1	PZ	VI1220A1	4,2X12 TCB SELF-TAPPIN G SCREW	2	PZ
			Code	Description	Qty	UOM																															
GN1326A1	ELEMENT SEALING	1	PZ																																		
GN1672A0		1	PZ																																		
GN1672A1	RS1274A ELEMENT GASKET	1	PZ																																		
MOV0009A0	HOOD RING GASKET GN1110A2	0.100	PZ																																		
RS1274A0	100W 60V 1 TURN FLAT ELEMENT	1	PZ																																		
SL1045A0	S57 BLACK SILICONE - 80ML CARTRIDGE	1	PZ																																		
VI1220A1	4,2X12 TCB SELF-TAPPIN G SCREW	2	PZ																																		
KRS1261A	122W MOTOR BREAKING ELEMENT KIT	<table border="1"> <thead> <tr> <th>Code</th> <th>Description</th> <th>Qty</th> <th>UOM</th> </tr> </thead> <tbody> <tr> <td>GN1326A1</td> <td>ELEMENT SEALING</td> <td>1</td> <td>PZ</td> </tr> <tr> <td>RS1261A0</td> <td>BAKERLUX\CH EFLUX MOTOR BREAKING ELEMENT</td> <td>1</td> <td>PZ</td> </tr> </tbody> </table>	Code	Description	Qty	UOM	GN1326A1	ELEMENT SEALING	1	PZ	RS1261A0	BAKERLUX\CH EFLUX MOTOR BREAKING ELEMENT	1	PZ																							
Code	Description	Qty	UOM																																		
GN1326A1	ELEMENT SEALING	1	PZ																																		
RS1261A0	BAKERLUX\CH EFLUX MOTOR BREAKING ELEMENT	1	PZ																																		

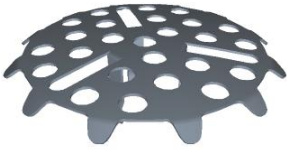
COMPONENT			SPARE PART																															
Code	Description	Image	Code	Description	Components list																													
GN1326A	ELEMENT SEALING		KRS1261A	122W MOTOR BREAKING ELEMENT KIT	<table border="1"> <thead> <tr> <th>Code</th> <th>Description</th> <th>Qty</th> <th>UOM</th> </tr> </thead> <tbody> <tr> <td>SL1045A0</td> <td>S57 BLACK SILICONE - 80ML CARTRIDGE</td> <td>1</td> <td>PZ</td> </tr> <tr> <td>VI1220A1</td> <td>4,2X12 TCB SELF-TAPPIN G SCREW</td> <td>2</td> <td>PZ</td> </tr> <tr> <td>VM2147A0</td> <td>410X343X15 MM PINK SMOOTH ESD SPONGE</td> <td>1</td> <td>PZ</td> </tr> </tbody> </table>	Code	Description	Qty	UOM	SL1045A0	S57 BLACK SILICONE - 80ML CARTRIDGE	1	PZ	VI1220A1	4,2X12 TCB SELF-TAPPIN G SCREW	2	PZ	VM2147A0	410X343X15 MM PINK SMOOTH ESD SPONGE	1	PZ													
			Code	Description	Qty	UOM																												
			SL1045A0	S57 BLACK SILICONE - 80ML CARTRIDGE	1	PZ																												
VI1220A1	4,2X12 TCB SELF-TAPPIN G SCREW	2	PZ																															
VM2147A0	410X343X15 MM PINK SMOOTH ESD SPONGE	1	PZ																															
KRS1215A	147W MOTOR BRAKING ELEMENT KIT	<table border="1"> <thead> <tr> <th>Code</th> <th>Description</th> <th>Qty</th> <th>UOM</th> </tr> </thead> <tbody> <tr> <td>GN1326A1</td> <td>ELEMENT SEALING</td> <td>1</td> <td>PZ</td> </tr> <tr> <td>GN1672A0</td> <td></td> <td>1</td> <td>PZ</td> </tr> <tr> <td>GN1672A1</td> <td>RS1274A ELEMENT GASKET</td> <td>1</td> <td>PZ</td> </tr> <tr> <td>MOV0009A0</td> <td>HOOD RING GASKET GN1110A2</td> <td>0.100</td> <td>PZ</td> </tr> <tr> <td>RS1215A1</td> <td>147W 105V BRAKING ELEMENT</td> <td>1</td> <td>PZ</td> </tr> <tr> <td>SL1045A0</td> <td>S57 BLACK SILICONE - 80ML CARTRIDGE</td> <td>1</td> <td>PZ</td> </tr> <tr> <td>VI1220A1</td> <td>4,2X12 TCB SELF-TAPPIN G SCREW</td> <td>2</td> <td>PZ</td> </tr> </tbody> </table>	Code	Description	Qty	UOM	GN1326A1	ELEMENT SEALING	1	PZ	GN1672A0		1	PZ	GN1672A1	RS1274A ELEMENT GASKET	1	PZ	MOV0009A0	HOOD RING GASKET GN1110A2	0.100	PZ	RS1215A1	147W 105V BRAKING ELEMENT	1	PZ	SL1045A0	S57 BLACK SILICONE - 80ML CARTRIDGE	1	PZ	VI1220A1	4,2X12 TCB SELF-TAPPIN G SCREW	2	PZ
Code	Description	Qty	UOM																															
GN1326A1	ELEMENT SEALING	1	PZ																															
GN1672A0		1	PZ																															
GN1672A1	RS1274A ELEMENT GASKET	1	PZ																															
MOV0009A0	HOOD RING GASKET GN1110A2	0.100	PZ																															
RS1215A1	147W 105V BRAKING ELEMENT	1	PZ																															
SL1045A0	S57 BLACK SILICONE - 80ML CARTRIDGE	1	PZ																															
VI1220A1	4,2X12 TCB SELF-TAPPIN G SCREW	2	PZ																															
KRS1095A	1.2KW HEATING ELEMENT KIT	<table border="1"> <thead> <tr> <th>Code</th> <th>Description</th> <th>Qty</th> <th>UOM</th> </tr> </thead> <tbody> <tr> <td>GN1326A1</td> <td>ELEMENT SEALING</td> <td>1</td> <td>PZ</td> </tr> <tr> <td>IP1385A1</td> <td>CORNER POLYSTYREN E PACKING 110X80X2000</td> <td>0.500</td> <td>M</td> </tr> <tr> <td>RS1095A1</td> <td>HEATING ELEMENT 1200W 230V</td> <td>1</td> <td>PZ</td> </tr> <tr> <td>SL1045A0</td> <td>S57 BLACK SILICONE - 80ML CARTRIDGE</td> <td>1</td> <td>PZ</td> </tr> <tr> <td>VI1220A1</td> <td>4,2X12 TCB SELF-TAPPIN G SCREW</td> <td>2</td> <td>PZ</td> </tr> <tr> <td>VM1059A1</td> <td>HEAT SHRINK FILM H800</td> <td>1.200</td> <td>M</td> </tr> </tbody> </table>	Code	Description	Qty	UOM	GN1326A1	ELEMENT SEALING	1	PZ	IP1385A1	CORNER POLYSTYREN E PACKING 110X80X2000	0.500	M	RS1095A1	HEATING ELEMENT 1200W 230V	1	PZ	SL1045A0	S57 BLACK SILICONE - 80ML CARTRIDGE	1	PZ	VI1220A1	4,2X12 TCB SELF-TAPPIN G SCREW	2	PZ	VM1059A1	HEAT SHRINK FILM H800	1.200	M				
Code	Description	Qty	UOM																															
GN1326A1	ELEMENT SEALING	1	PZ																															
IP1385A1	CORNER POLYSTYREN E PACKING 110X80X2000	0.500	M																															
RS1095A1	HEATING ELEMENT 1200W 230V	1	PZ																															
SL1045A0	S57 BLACK SILICONE - 80ML CARTRIDGE	1	PZ																															
VI1220A1	4,2X12 TCB SELF-TAPPIN G SCREW	2	PZ																															
VM1059A1	HEAT SHRINK FILM H800	1.200	M																															

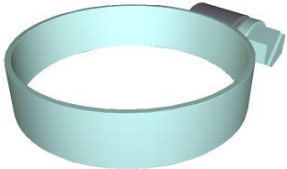
COMPONENT			SPARE PART																																		
Code	Description	Image	Code	Description	Components list																																
GN1326A	ELEMENT SEALING		KRS1012A	1365W 120V HEATING ELEMENT KIT	<table border="1"> <thead> <tr> <th>Code</th> <th>Description</th> <th>Qty</th> <th>UOM</th> </tr> </thead> <tbody> <tr> <td>GN1326A1</td> <td>ELEMENT SEALING</td> <td>1</td> <td>PZ</td> </tr> <tr> <td>MOV0008A0</td> <td>HOOD RING GASKET GN1110A2</td> <td>0.100</td> <td>PZ</td> </tr> <tr> <td>RS1012A0</td> <td>CIRCULAR HEATING ELEMENT 1365W 120V</td> <td>1</td> <td>PZ</td> </tr> <tr> <td>VI1220A1</td> <td>4,2X12 TCB SELF-TAPPIN G SCREW</td> <td>5</td> <td>PZ</td> </tr> <tr> <td>VM1794A0</td> <td>250X4.8 PA66 BLACK CLAMP</td> <td>2</td> <td>PZ</td> </tr> <tr> <td>VM2103A0</td> <td>CLAMP LOCK</td> <td>2</td> <td>PZ</td> </tr> </tbody> </table>	Code	Description	Qty	UOM	GN1326A1	ELEMENT SEALING	1	PZ	MOV0008A0	HOOD RING GASKET GN1110A2	0.100	PZ	RS1012A0	CIRCULAR HEATING ELEMENT 1365W 120V	1	PZ	VI1220A1	4,2X12 TCB SELF-TAPPIN G SCREW	5	PZ	VM1794A0	250X4.8 PA66 BLACK CLAMP	2	PZ	VM2103A0	CLAMP LOCK	2	PZ				
			Code	Description	Qty	UOM																															
			GN1326A1	ELEMENT SEALING	1	PZ																															
			MOV0008A0	HOOD RING GASKET GN1110A2	0.100	PZ																															
			RS1012A0	CIRCULAR HEATING ELEMENT 1365W 120V	1	PZ																															
			VI1220A1	4,2X12 TCB SELF-TAPPIN G SCREW	5	PZ																															
			VM1794A0	250X4.8 PA66 BLACK CLAMP	2	PZ																															
			VM2103A0	CLAMP LOCK	2	PZ																															
			KRS1011A	ROBERTA/LISA HEATING ELEMENT KIT	<table border="1"> <thead> <tr> <th>Code</th> <th>Description</th> <th>Qty</th> <th>UOM</th> </tr> </thead> <tbody> <tr> <td>GN1326A1</td> <td>ELEMENT SEALING</td> <td>1</td> <td>PZ</td> </tr> <tr> <td>MOV0008A0</td> <td>HOOD RING GASKET GN1110A2</td> <td>0.100</td> <td>PZ</td> </tr> <tr> <td>RS1011A0</td> <td>2560W 220-230V HEATING ELEMENT</td> <td>1</td> <td>PZ</td> </tr> <tr> <td>SL1045A0</td> <td>S57 BLACK SILICONE - 80ML CARTRIDGE</td> <td>1</td> <td>PZ</td> </tr> <tr> <td>VI1220A1</td> <td>4,2X12 TCB SELF-TAPPIN G SCREW</td> <td>5</td> <td>PZ</td> </tr> <tr> <td>VM1794A0</td> <td>250X4.8 PA66 BLACK CLAMP</td> <td>2</td> <td>PZ</td> </tr> <tr> <td>VM2103A0</td> <td>CLAMP LOCK</td> <td>2</td> <td>PZ</td> </tr> </tbody> </table>	Code	Description	Qty	UOM	GN1326A1	ELEMENT SEALING	1	PZ	MOV0008A0	HOOD RING GASKET GN1110A2	0.100	PZ	RS1011A0	2560W 220-230V HEATING ELEMENT	1	PZ	SL1045A0	S57 BLACK SILICONE - 80ML CARTRIDGE	1	PZ	VI1220A1	4,2X12 TCB SELF-TAPPIN G SCREW	5	PZ	VM1794A0	250X4.8 PA66 BLACK CLAMP	2	PZ	VM2103A0	CLAMP LOCK	2	PZ
			Code	Description	Qty	UOM																															
			GN1326A1	ELEMENT SEALING	1	PZ																															
			MOV0008A0	HOOD RING GASKET GN1110A2	0.100	PZ																															
RS1011A0	2560W 220-230V HEATING ELEMENT	1	PZ																																		
SL1045A0	S57 BLACK SILICONE - 80ML CARTRIDGE	1	PZ																																		
VI1220A1	4,2X12 TCB SELF-TAPPIN G SCREW	5	PZ																																		
VM1794A0	250X4.8 PA66 BLACK CLAMP	2	PZ																																		
VM2103A0	CLAMP LOCK	2	PZ																																		
KRS0090A	HEATING ELEMENT 1.26KW	<table border="1"> <thead> <tr> <th>Code</th> <th>Description</th> <th>Qty</th> <th>UOM</th> </tr> </thead> <tbody> <tr> <td>GN1326A1</td> <td>ELEMENT SEALING</td> <td>1</td> <td>PZ</td> </tr> <tr> <td>RS0090A0</td> <td>CIRC. HEAT. ELEMENT 1260W 220-230</td> <td>1</td> <td>PZ</td> </tr> <tr> <td>VI1220A1</td> <td>4,2X12 TCB SELF-TAPPIN G SCREW</td> <td>3</td> <td>PZ</td> </tr> <tr> <td>VM1794A0</td> <td>250X4.8 PA66 BLACK CLAMP</td> <td>2</td> <td>PZ</td> </tr> <tr> <td>VM2103A0</td> <td>CLAMP LOCK</td> <td>2</td> <td>PZ</td> </tr> </tbody> </table>	Code	Description	Qty	UOM	GN1326A1	ELEMENT SEALING	1	PZ	RS0090A0	CIRC. HEAT. ELEMENT 1260W 220-230	1	PZ	VI1220A1	4,2X12 TCB SELF-TAPPIN G SCREW	3	PZ	VM1794A0	250X4.8 PA66 BLACK CLAMP	2	PZ	VM2103A0	CLAMP LOCK	2	PZ											
Code	Description	Qty	UOM																																		
GN1326A1	ELEMENT SEALING	1	PZ																																		
RS0090A0	CIRC. HEAT. ELEMENT 1260W 220-230	1	PZ																																		
VI1220A1	4,2X12 TCB SELF-TAPPIN G SCREW	3	PZ																																		
VM1794A0	250X4.8 PA66 BLACK CLAMP	2	PZ																																		
VM2103A0	CLAMP LOCK	2	PZ																																		
KRS0050A	HEATING ELEMENT KIT 0.5KW	<table border="1"> <thead> <tr> <th>Code</th> <th>Description</th> <th>Qty</th> <th>UOM</th> </tr> </thead> <tbody> <tr> <td>GN1326A1</td> <td>ELEMENT SEALING</td> <td>1</td> <td>PZ</td> </tr> </tbody> </table>	Code	Description	Qty	UOM	GN1326A1	ELEMENT SEALING	1	PZ																											
Code	Description	Qty	UOM																																		
GN1326A1	ELEMENT SEALING	1	PZ																																		

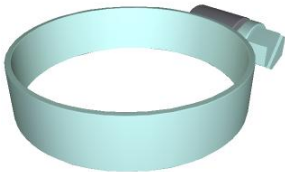
COMPONENT			SPARE PART																										
Code	Description	Image	Code	Description	Components list																								
GN1326A	ELEMENT SEALING		KRS0050A	HEATING ELEMENT KIT 0.5KW	<table border="1"> <thead> <tr> <th>Code</th> <th>Description</th> <th>Qty</th> <th>UOM</th> </tr> </thead> <tbody> <tr> <td>IP1075A1</td> <td>70X150X765 D=10 POLYSTYRE WITH PRECUT</td> <td>1</td> <td>PZ</td> </tr> <tr> <td>IP1080A1</td> <td>280X255X10 D=10 POLYSTYREN</td> <td>1</td> <td>PZ</td> </tr> <tr> <td>RS0050A0</td> <td>HEAT. ELEMENT 500W 220-230V LIEV</td> <td>1</td> <td>PZ</td> </tr> <tr> <td>VI1220A1</td> <td>4,2X12 TCB SELF-TAPPIN G SCREW</td> <td>2</td> <td>PZ</td> </tr> </tbody> </table>	Code	Description	Qty	UOM	IP1075A1	70X150X765 D=10 POLYSTYRE WITH PRECUT	1	PZ	IP1080A1	280X255X10 D=10 POLYSTYREN	1	PZ	RS0050A0	HEAT. ELEMENT 500W 220-230V LIEV	1	PZ	VI1220A1	4,2X12 TCB SELF-TAPPIN G SCREW	2	PZ				
					Code	Description	Qty	UOM																					
					IP1075A1	70X150X765 D=10 POLYSTYRE WITH PRECUT	1	PZ																					
					IP1080A1	280X255X10 D=10 POLYSTYREN	1	PZ																					
			RS0050A0	HEAT. ELEMENT 500W 220-230V LIEV	1	PZ																							
			VI1220A1	4,2X12 TCB SELF-TAPPIN G SCREW	2	PZ																							
			KRS0011A	HEATING ELEMENT 1.465KW RS0011A	<table border="1"> <thead> <tr> <th>Code</th> <th>Description</th> <th>Qty</th> <th>UOM</th> </tr> </thead> <tbody> <tr> <td>GN1326A1</td> <td>ELEMENT SEALING</td> <td>1</td> <td>PZ</td> </tr> <tr> <td>RS0011A0</td> <td>CIRC.HEAT. ELEMENT 1465W 220-230</td> <td>1</td> <td>PZ</td> </tr> <tr> <td>VI1220A1</td> <td>4,2X12 TCB SELF-TAPPIN G SCREW</td> <td>3</td> <td>PZ</td> </tr> <tr> <td>VM1794A0</td> <td>250X4.8 PA66 BLACK CLAMP</td> <td>2</td> <td>PZ</td> </tr> <tr> <td>VM2103A0</td> <td>CLAMP LOCK</td> <td>2</td> <td>PZ</td> </tr> </tbody> </table>	Code	Description	Qty	UOM	GN1326A1	ELEMENT SEALING	1	PZ	RS0011A0	CIRC.HEAT. ELEMENT 1465W 220-230	1	PZ	VI1220A1	4,2X12 TCB SELF-TAPPIN G SCREW	3	PZ	VM1794A0	250X4.8 PA66 BLACK CLAMP	2	PZ	VM2103A0	CLAMP LOCK	2	PZ
					Code	Description	Qty	UOM																					
					GN1326A1	ELEMENT SEALING	1	PZ																					
					RS0011A0	CIRC.HEAT. ELEMENT 1465W 220-230	1	PZ																					
			VI1220A1	4,2X12 TCB SELF-TAPPIN G SCREW	3	PZ																							
			VM1794A0	250X4.8 PA66 BLACK CLAMP	2	PZ																							
VM2103A0	CLAMP LOCK	2	PZ																										
KRS0010A	KIT HEATING ELEMENT RS10010A	<table border="1"> <thead> <tr> <th>Code</th> <th>Description</th> <th>Qty</th> <th>UOM</th> </tr> </thead> <tbody> <tr> <td>GN1326A1</td> <td>ELEMENT SEALING</td> <td>1</td> <td>PZ</td> </tr> <tr> <td>IP1075A1</td> <td>70X150X765 D=10 POLYSTYRE WITH PRECUT</td> <td>1</td> <td>PZ</td> </tr> <tr> <td>IP1080A1</td> <td>280X255X10 D=10 POLYSTYREN</td> <td>5</td> <td>PZ</td> </tr> <tr> <td>RS0010A0</td> <td>CIRC.HEAT. ELEMENT 2560W - 220-230 V</td> <td>1</td> <td>PZ</td> </tr> <tr> <td>VI1220A1</td> <td>4,2X12 TCB SELF-TAPPIN G SCREW</td> <td>3</td> <td>PZ</td> </tr> </tbody> </table>	Code	Description	Qty	UOM	GN1326A1	ELEMENT SEALING	1	PZ	IP1075A1	70X150X765 D=10 POLYSTYRE WITH PRECUT	1	PZ	IP1080A1	280X255X10 D=10 POLYSTYREN	5	PZ	RS0010A0	CIRC.HEAT. ELEMENT 2560W - 220-230 V	1	PZ	VI1220A1	4,2X12 TCB SELF-TAPPIN G SCREW	3	PZ			
		Code	Description	Qty	UOM																								
		GN1326A1	ELEMENT SEALING	1	PZ																								
		IP1075A1	70X150X765 D=10 POLYSTYRE WITH PRECUT	1	PZ																								
IP1080A1	280X255X10 D=10 POLYSTYREN	5	PZ																										
RS0010A0	CIRC.HEAT. ELEMENT 2560W - 220-230 V	1	PZ																										
VI1220A1	4,2X12 TCB SELF-TAPPIN G SCREW	3	PZ																										
KGN1326A	HEATING ELEMENT GASKET 5 PCS KIT	<table border="1"> <thead> <tr> <th>Code</th> <th>Description</th> <th>Qty</th> <th>UOM</th> </tr> </thead> <tbody> <tr> <td>GN1326A1</td> <td>ELEMENT SEALING</td> <td>5</td> <td>PZ</td> </tr> <tr> <td>VM1224A0</td> <td>65MY 220MM 2 COLOURS SHRINK TUBE</td> <td>0.200</td> <td>M</td> </tr> </tbody> </table>	Code	Description	Qty	UOM	GN1326A1	ELEMENT SEALING	5	PZ	VM1224A0	65MY 220MM 2 COLOURS SHRINK TUBE	0.200	M															
		Code	Description	Qty	UOM																								
GN1326A1	ELEMENT SEALING	5	PZ																										
VM1224A0	65MY 220MM 2 COLOURS SHRINK TUBE	0.200	M																										



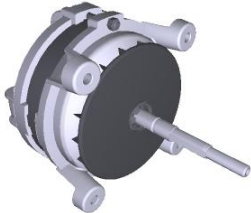

COMPONENT			SPARE PART																																																						
Code	Description	Image	Code	Description	Components list																																																				
0H2551A	XBC/XVC ST.STEEL DRAIN COVER		K0H2551A	DRAIN COVER KIT	<table border="1"> <thead> <tr> <th>Code</th> <th>Description</th> <th>Qty</th> <th>UOM</th> </tr> </thead> <tbody> <tr> <td>0H2551A0</td> <td>XBC/XVC ST.STEEL DRAIN COVER</td> <td>1</td> <td>PZ</td> </tr> <tr> <td>VM1224A0</td> <td>65MY 220MM 2 COLOURS SHRINK TUBE</td> <td>0.200</td> <td>M</td> </tr> </tbody> </table>	Code	Description	Qty	UOM	0H2551A0	XBC/XVC ST.STEEL DRAIN COVER	1	PZ	VM1224A0	65MY 220MM 2 COLOURS SHRINK TUBE	0.200	M																																								
					Code	Description	Qty	UOM																																																	
0H2551A0	XBC/XVC ST.STEEL DRAIN COVER	1	PZ																																																						
VM1224A0	65MY 220MM 2 COLOURS SHRINK TUBE	0.200	M																																																						
<table border="1"> <thead> <tr> <th>Code</th> <th>Description</th> <th>Qty</th> <th>UOM</th> </tr> </thead> <tbody> <tr> <td>VM1224A0</td> <td>65MY 220MM 2 COLOURS SHRINK TUBE</td> <td>0.200</td> <td>M</td> </tr> <tr> <td>VM1820A0</td> <td>LATERAL SUPPORTS M6 FIXING BOLT</td> <td>10</td> <td>PZ</td> </tr> </tbody> </table>	Code	Description	Qty	UOM	VM1224A0	65MY 220MM 2 COLOURS SHRINK TUBE	0.200	M	VM1820A0	LATERAL SUPPORTS M6 FIXING BOLT	10	PZ																																													
Code	Description	Qty	UOM																																																						
VM1224A0	65MY 220MM 2 COLOURS SHRINK TUBE	0.200	M																																																						
VM1820A0	LATERAL SUPPORTS M6 FIXING BOLT	10	PZ																																																						
VM1820A	LATERAL SUPPORTS M6 FIXING BOLT		KVM1820A	THUMB SCREW 10PCS KIT	<table border="1"> <thead> <tr> <th>Code</th> <th>Description</th> <th>Qty</th> <th>UOM</th> </tr> </thead> <tbody> <tr> <td>VM1224A0</td> <td>65MY 220MM 2 COLOURS SHRINK TUBE</td> <td>0.200</td> <td>M</td> </tr> <tr> <td>VM1820A0</td> <td>LATERAL SUPPORTS M6 FIXING BOLT</td> <td>10</td> <td>PZ</td> </tr> </tbody> </table>	Code	Description	Qty	UOM	VM1224A0	65MY 220MM 2 COLOURS SHRINK TUBE	0.200	M	VM1820A0	LATERAL SUPPORTS M6 FIXING BOLT	10	PZ																																								
					Code	Description	Qty	UOM																																																	
VM1224A0	65MY 220MM 2 COLOURS SHRINK TUBE	0.200	M																																																						
VM1820A0	LATERAL SUPPORTS M6 FIXING BOLT	10	PZ																																																						
<table border="1"> <thead> <tr> <th>Code</th> <th>Description</th> <th>Qty</th> <th>UOM</th> </tr> </thead> <tbody> <tr> <td>GN1556A0</td> <td>MM VENTURI SEAL</td> <td>1</td> <td>PZ</td> </tr> <tr> <td>RC1378A0</td> <td>HOSE CLAMP</td> <td>2</td> <td>PZ</td> </tr> <tr> <td>TB1520A0</td> <td>INT. Ø=38 TH=4 DRAIN BLACK RUBBER PIPE</td> <td>0.050</td> <td>M</td> </tr> <tr> <td>VE1135A0</td> <td>220 V 50/60 HZ VENTURI ACTUATOR</td> <td>1</td> <td>PZ</td> </tr> <tr> <td>VI1032A0</td> <td>SCREW M4X16 TCB+ INOX</td> <td>1</td> <td>PZ</td> </tr> <tr> <td>VI1511A0</td> <td>STAINLESS STEEL WASHER 4.2X12X1</td> <td>2</td> <td>PZ</td> </tr> <tr> <td>VI1850A0</td> <td>M4X6 NICKEL PLATED FIXING SCREW</td> <td>2</td> <td>PZ</td> </tr> <tr> <td>VI1865A0</td> <td>5X10 TCB+ SELF-THREADING SCREW</td> <td>3</td> <td>PZ</td> </tr> <tr> <td>VI1965A0</td> <td>M4X6 CROSS-HEAD ST. STEEL SCREW</td> <td>2</td> <td>PZ</td> </tr> <tr> <td>VM1224A0</td> <td>65MY 220MM 2 COLOURS SHRINK TUBE</td> <td>0.250</td> <td>M</td> </tr> <tr> <td>VM1565B0</td> <td>VENTURI LOWER COIL SUPPORT</td> <td>1</td> <td>PZ</td> </tr> <tr> <td>VM1566A0</td> <td>VENTURI UPPER COIL SUPPORT</td> <td>1</td> <td>PZ</td> </tr> </tbody> </table>	Code	Description	Qty	UOM	GN1556A0	MM VENTURI SEAL	1	PZ	RC1378A0	HOSE CLAMP	2	PZ	TB1520A0	INT. Ø=38 TH=4 DRAIN BLACK RUBBER PIPE	0.050	M	VE1135A0	220 V 50/60 HZ VENTURI ACTUATOR	1	PZ	VI1032A0	SCREW M4X16 TCB+ INOX	1	PZ	VI1511A0	STAINLESS STEEL WASHER 4.2X12X1	2	PZ	VI1850A0	M4X6 NICKEL PLATED FIXING SCREW	2	PZ	VI1865A0	5X10 TCB+ SELF-THREADING SCREW	3	PZ	VI1965A0	M4X6 CROSS-HEAD ST. STEEL SCREW	2	PZ	VM1224A0	65MY 220MM 2 COLOURS SHRINK TUBE	0.250	M	VM1565B0	VENTURI LOWER COIL SUPPORT	1	PZ	VM1566A0	VENTURI UPPER COIL SUPPORT	1	PZ					
Code	Description	Qty	UOM																																																						
GN1556A0	MM VENTURI SEAL	1	PZ																																																						
RC1378A0	HOSE CLAMP	2	PZ																																																						
TB1520A0	INT. Ø=38 TH=4 DRAIN BLACK RUBBER PIPE	0.050	M																																																						
VE1135A0	220 V 50/60 HZ VENTURI ACTUATOR	1	PZ																																																						
VI1032A0	SCREW M4X16 TCB+ INOX	1	PZ																																																						
VI1511A0	STAINLESS STEEL WASHER 4.2X12X1	2	PZ																																																						
VI1850A0	M4X6 NICKEL PLATED FIXING SCREW	2	PZ																																																						
VI1865A0	5X10 TCB+ SELF-THREADING SCREW	3	PZ																																																						
VI1965A0	M4X6 CROSS-HEAD ST. STEEL SCREW	2	PZ																																																						
VM1224A0	65MY 220MM 2 COLOURS SHRINK TUBE	0.250	M																																																						
VM1565B0	VENTURI LOWER COIL SUPPORT	1	PZ																																																						
VM1566A0	VENTURI UPPER COIL SUPPORT	1	PZ																																																						
RC1378A	HOSE CLAMP		KVE1135A	SERIES 5/5E VENTURI KIT	<table border="1"> <thead> <tr> <th>Code</th> <th>Description</th> <th>Qty</th> <th>UOM</th> </tr> </thead> <tbody> <tr> <td>GN1556A0</td> <td>MM VENTURI SEAL</td> <td>1</td> <td>PZ</td> </tr> <tr> <td>RC1378A0</td> <td>HOSE CLAMP</td> <td>2</td> <td>PZ</td> </tr> <tr> <td>TB1520A0</td> <td>INT. Ø=38 TH=4 DRAIN BLACK RUBBER PIPE</td> <td>0.050</td> <td>M</td> </tr> <tr> <td>VE1135A0</td> <td>220 V 50/60 HZ VENTURI ACTUATOR</td> <td>1</td> <td>PZ</td> </tr> <tr> <td>VI1032A0</td> <td>SCREW M4X16 TCB+ INOX</td> <td>1</td> <td>PZ</td> </tr> <tr> <td>VI1511A0</td> <td>STAINLESS STEEL WASHER 4.2X12X1</td> <td>2</td> <td>PZ</td> </tr> <tr> <td>VI1850A0</td> <td>M4X6 NICKEL PLATED FIXING SCREW</td> <td>2</td> <td>PZ</td> </tr> <tr> <td>VI1865A0</td> <td>5X10 TCB+ SELF-THREADING SCREW</td> <td>3</td> <td>PZ</td> </tr> <tr> <td>VI1965A0</td> <td>M4X6 CROSS-HEAD ST. STEEL SCREW</td> <td>2</td> <td>PZ</td> </tr> <tr> <td>VM1224A0</td> <td>65MY 220MM 2 COLOURS SHRINK TUBE</td> <td>0.250</td> <td>M</td> </tr> <tr> <td>VM1565B0</td> <td>VENTURI LOWER COIL SUPPORT</td> <td>1</td> <td>PZ</td> </tr> <tr> <td>VM1566A0</td> <td>VENTURI UPPER COIL SUPPORT</td> <td>1</td> <td>PZ</td> </tr> </tbody> </table>	Code	Description	Qty	UOM	GN1556A0	MM VENTURI SEAL	1	PZ	RC1378A0	HOSE CLAMP	2	PZ	TB1520A0	INT. Ø=38 TH=4 DRAIN BLACK RUBBER PIPE	0.050	M	VE1135A0	220 V 50/60 HZ VENTURI ACTUATOR	1	PZ	VI1032A0	SCREW M4X16 TCB+ INOX	1	PZ	VI1511A0	STAINLESS STEEL WASHER 4.2X12X1	2	PZ	VI1850A0	M4X6 NICKEL PLATED FIXING SCREW	2	PZ	VI1865A0	5X10 TCB+ SELF-THREADING SCREW	3	PZ	VI1965A0	M4X6 CROSS-HEAD ST. STEEL SCREW	2	PZ	VM1224A0	65MY 220MM 2 COLOURS SHRINK TUBE	0.250	M	VM1565B0	VENTURI LOWER COIL SUPPORT	1	PZ	VM1566A0	VENTURI UPPER COIL SUPPORT	1	PZ
Code	Description	Qty	UOM																																																						
GN1556A0	MM VENTURI SEAL	1	PZ																																																						
RC1378A0	HOSE CLAMP	2	PZ																																																						
TB1520A0	INT. Ø=38 TH=4 DRAIN BLACK RUBBER PIPE	0.050	M																																																						
VE1135A0	220 V 50/60 HZ VENTURI ACTUATOR	1	PZ																																																						
VI1032A0	SCREW M4X16 TCB+ INOX	1	PZ																																																						
VI1511A0	STAINLESS STEEL WASHER 4.2X12X1	2	PZ																																																						
VI1850A0	M4X6 NICKEL PLATED FIXING SCREW	2	PZ																																																						
VI1865A0	5X10 TCB+ SELF-THREADING SCREW	3	PZ																																																						
VI1965A0	M4X6 CROSS-HEAD ST. STEEL SCREW	2	PZ																																																						
VM1224A0	65MY 220MM 2 COLOURS SHRINK TUBE	0.250	M																																																						
VM1565B0	VENTURI LOWER COIL SUPPORT	1	PZ																																																						
VM1566A0	VENTURI UPPER COIL SUPPORT	1	PZ																																																						

COMPONENT			SPARE PART																		
Code	Description	Image	Code	Description	Components list																
RC1378A	HOSE CLAMP		KVE1135A	SERIES 5/5E VENTURI KIT	<table border="1"> <thead> <tr> <th>Code</th> <th>Description</th> <th>Qty</th> <th>UOM</th> </tr> </thead> <tbody> <tr> <td>VM1567A0</td> <td>VENTURI LOWER BUSHING</td> <td>1</td> <td>PZ</td> </tr> <tr> <td>VM1568A0</td> <td>VENTURI PLATE SPACE</td> <td>1</td> <td>PZ</td> </tr> </tbody> </table>	Code	Description	Qty	UOM	VM1567A0	VENTURI LOWER BUSHING	1	PZ	VM1568A0	VENTURI PLATE SPACE	1	PZ				
Code	Description	Qty	UOM																		
VM1567A0	VENTURI LOWER BUSHING	1	PZ																		
VM1568A0	VENTURI PLATE SPACE	1	PZ																		
EL1361A	D8-D10 J.G. STEAM SOLENOID VALVE		KEL1361A	JG D8-D10 5+9 STEAM SOLENOID VALVE KIT	<table border="1"> <thead> <tr> <th>Code</th> <th>Description</th> <th>Qty</th> <th>UOM</th> </tr> </thead> <tbody> <tr> <td>EL1361A0</td> <td>D8-D10 J.G. STEAM SOLENOID VALVE</td> <td>1</td> <td>PZ</td> </tr> <tr> <td>MOV0004A0</td> <td>HOOD RING GASKET GN1110A2</td> <td>0.100</td> <td>PZ</td> </tr> <tr> <td>VM1224A0</td> <td>65MY 220MM 2 COLOURS SHRINK TUBE</td> <td>0.250</td> <td>M</td> </tr> </tbody> </table>	Code	Description	Qty	UOM	EL1361A0	D8-D10 J.G. STEAM SOLENOID VALVE	1	PZ	MOV0004A0	HOOD RING GASKET GN1110A2	0.100	PZ	VM1224A0	65MY 220MM 2 COLOURS SHRINK TUBE	0.250	M
Code	Description	Qty	UOM																		
EL1361A0	D8-D10 J.G. STEAM SOLENOID VALVE	1	PZ																		
MOV0004A0	HOOD RING GASKET GN1110A2	0.100	PZ																		
VM1224A0	65MY 220MM 2 COLOURS SHRINK TUBE	0.250	M																		
0H2730A	ZINC PLATED MUFFLE SUPPORT BRACKET		0H2730A1	ZINC PLATED MUFFLE SUPPORT BRACKET																	
0H3586A	ZINCED MOTOR GUARD PLATE XBC-XVC		0H3586A0	ZINCED MOTOR GUARD PLATE XBC-XVC																	
0H4305A	ST. STEEL MOTOR SHAFT SEALING DIS		K0H4305A	SEALING DISC FOR MOTOR SHAFT KIT	<table border="1"> <thead> <tr> <th>Code</th> <th>Description</th> <th>Qty</th> <th>UOM</th> </tr> </thead> <tbody> <tr> <td>0H4305A1</td> <td>ST. STEEL MOTOR SHAFT SEALING DISC</td> <td>1</td> <td>PZ</td> </tr> <tr> <td>GN1140A2</td> <td>MOTOR HOLDER GASKET</td> <td>1</td> <td>PZ</td> </tr> <tr> <td>GN1140A3</td> <td>MOLDED MOTOR HOLDER GASKET</td> <td>1</td> <td>PZ</td> </tr> </tbody> </table>	Code	Description	Qty	UOM	0H4305A1	ST. STEEL MOTOR SHAFT SEALING DISC	1	PZ	GN1140A2	MOTOR HOLDER GASKET	1	PZ	GN1140A3	MOLDED MOTOR HOLDER GASKET	1	PZ
Code	Description	Qty	UOM																		
0H4305A1	ST. STEEL MOTOR SHAFT SEALING DISC	1	PZ																		
GN1140A2	MOTOR HOLDER GASKET	1	PZ																		
GN1140A3	MOLDED MOTOR HOLDER GASKET	1	PZ																		

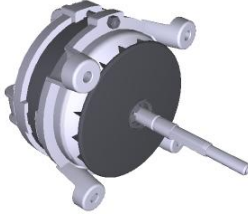

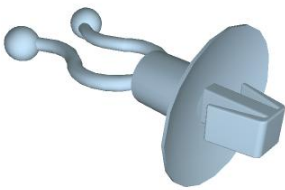
COMPONENT			SPARE PART																																														
Code	Description	Image	Code	Description	Components list																																												
0H4305A	ST. STEEL MOTOR SHAFT SEALING DIS		K0H4305A	SEALING DISC FOR MOTOR SHAFT KIT	<table border="1"> <thead> <tr> <th>Code</th> <th>Description</th> <th>Qty</th> <th>UOM</th> </tr> </thead> <tbody> <tr> <td>SL1045A0</td> <td>S57 BLACK SILICONE - 80ML CARTRIDGE</td> <td>1</td> <td>PZ</td> </tr> <tr> <td>VI1220A1</td> <td>4,2X12 TCB SELF-TAPPIN G SCREW</td> <td>3</td> <td>PZ</td> </tr> </tbody> </table>	Code	Description	Qty	UOM	SL1045A0	S57 BLACK SILICONE - 80ML CARTRIDGE	1	PZ	VI1220A1	4,2X12 TCB SELF-TAPPIN G SCREW	3	PZ																																
Code	Description	Qty	UOM																																														
SL1045A0	S57 BLACK SILICONE - 80ML CARTRIDGE	1	PZ																																														
VI1220A1	4,2X12 TCB SELF-TAPPIN G SCREW	3	PZ																																														
VN1130A	330W 230V 50/60HZ MOTOR		KVN1130A	LUX =08.2017/S.5/S.5E 330W MOTOR KIT	<table border="1"> <thead> <tr> <th>Code</th> <th>Description</th> <th>Qty</th> <th>UOM</th> </tr> </thead> <tbody> <tr> <td>0H4305A1</td> <td>ST. STEEL MOTOR SHAFT SEALING DISC</td> <td>1</td> <td>PZ</td> </tr> <tr> <td>GN1140A2</td> <td>MOTOR HOLDER GASKET</td> <td>1</td> <td>PZ</td> </tr> <tr> <td>GN1140A3</td> <td>MOLDED MOTOR HOLDER GASKET</td> <td>1</td> <td>PZ</td> </tr> <tr> <td>VI1045A0</td> <td>16X8,4 TH=1,6 ST.STEEL WASHER</td> <td>1</td> <td>PZ</td> </tr> <tr> <td>VI1256A0</td> <td>M8 DIN 980M ST. STEEL SELF LOCKING NUT</td> <td>1</td> <td>PZ</td> </tr> <tr> <td>VM1794A0</td> <td>250X4,8 PA66 BLACK CLAMP</td> <td>4</td> <td>PZ</td> </tr> <tr> <td>VM2103A0</td> <td>CLAMP LOCK</td> <td>4</td> <td>PZ</td> </tr> <tr> <td>VM2196A0</td> <td>MOTOR NUT FASTENING BUSHING</td> <td>1</td> <td>PZ</td> </tr> <tr> <td>VN1130A1</td> <td>330W 230V 50/60HZ MOTO</td> <td>1</td> <td>PZ</td> </tr> <tr> <td>VN1130A1</td> <td>330W 230V 50/60HZ MOTO</td> <td>1</td> <td>PZ</td> </tr> </tbody> </table>	Code	Description	Qty	UOM	0H4305A1	ST. STEEL MOTOR SHAFT SEALING DISC	1	PZ	GN1140A2	MOTOR HOLDER GASKET	1	PZ	GN1140A3	MOLDED MOTOR HOLDER GASKET	1	PZ	VI1045A0	16X8,4 TH=1,6 ST.STEEL WASHER	1	PZ	VI1256A0	M8 DIN 980M ST. STEEL SELF LOCKING NUT	1	PZ	VM1794A0	250X4,8 PA66 BLACK CLAMP	4	PZ	VM2103A0	CLAMP LOCK	4	PZ	VM2196A0	MOTOR NUT FASTENING BUSHING	1	PZ	VN1130A1	330W 230V 50/60HZ MOTO	1	PZ	VN1130A1	330W 230V 50/60HZ MOTO	1	PZ
Code	Description	Qty	UOM																																														
0H4305A1	ST. STEEL MOTOR SHAFT SEALING DISC	1	PZ																																														
GN1140A2	MOTOR HOLDER GASKET	1	PZ																																														
GN1140A3	MOLDED MOTOR HOLDER GASKET	1	PZ																																														
VI1045A0	16X8,4 TH=1,6 ST.STEEL WASHER	1	PZ																																														
VI1256A0	M8 DIN 980M ST. STEEL SELF LOCKING NUT	1	PZ																																														
VM1794A0	250X4,8 PA66 BLACK CLAMP	4	PZ																																														
VM2103A0	CLAMP LOCK	4	PZ																																														
VM2196A0	MOTOR NUT FASTENING BUSHING	1	PZ																																														
VN1130A1	330W 230V 50/60HZ MOTO	1	PZ																																														
VN1130A1	330W 230V 50/60HZ MOTO	1	PZ																																														
			KMT1012A	MIND.MAPS 330W 230V MOTOR KIT	<table border="1"> <thead> <tr> <th>Code</th> <th>Description</th> <th>Qty</th> <th>UOM</th> </tr> </thead> <tbody> <tr> <td>0H2842A0</td> <td></td> <td>1</td> <td>PZ</td> </tr> <tr> <td>0H4305A1</td> <td>ST. STEEL MOTOR SHAFT SEALING DISC</td> <td>1</td> <td>PZ</td> </tr> <tr> <td>GN1140A2</td> <td>MOTOR HOLDER GASKET</td> <td>1</td> <td>PZ</td> </tr> <tr> <td>GN1140A3</td> <td>MOLDED MOTOR HOLDER GASKET</td> <td>1</td> <td>PZ</td> </tr> <tr> <td>MOV0007A0</td> <td>HOOD RING GASKET GN1110A2</td> <td>0.100</td> <td>PZ</td> </tr> </tbody> </table>	Code	Description	Qty	UOM	0H2842A0		1	PZ	0H4305A1	ST. STEEL MOTOR SHAFT SEALING DISC	1	PZ	GN1140A2	MOTOR HOLDER GASKET	1	PZ	GN1140A3	MOLDED MOTOR HOLDER GASKET	1	PZ	MOV0007A0	HOOD RING GASKET GN1110A2	0.100	PZ																				
Code	Description	Qty	UOM																																														
0H2842A0		1	PZ																																														
0H4305A1	ST. STEEL MOTOR SHAFT SEALING DISC	1	PZ																																														
GN1140A2	MOTOR HOLDER GASKET	1	PZ																																														
GN1140A3	MOLDED MOTOR HOLDER GASKET	1	PZ																																														
MOV0007A0	HOOD RING GASKET GN1110A2	0.100	PZ																																														

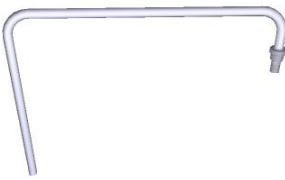
COMPONENT			SPARE PART																																						
Code	Description	Image	Code	Description	Components list																																				
VN1130A	330W 230V 50/60HZ MOTOR		KMT1012A	MIND.MAPS 330W 230V MOTOR KIT	<table border="1"> <thead> <tr> <th>Code</th> <th>Description</th> <th>Qty</th> <th>UOM</th> </tr> </thead> <tbody> <tr> <td>MT1012A0</td> <td>330W 230V MOTOR</td> <td>1</td> <td>PZ</td> </tr> <tr> <td>VE1550A0</td> <td>5X3 MM NEODYMIUM MAGNET</td> <td>1</td> <td>PZ</td> </tr> <tr> <td>VI1077A1</td> <td>SCREW M6X12 TE INOX</td> <td>1</td> <td>PZ</td> </tr> <tr> <td>VI1521A0</td> <td>STAINLESS STEEL WASHER D=6 6592</td> <td>1</td> <td>PZ</td> </tr> <tr> <td>VI1966A0</td> <td>M4X14 FLATHEAD SCREW</td> <td>1</td> <td>PZ</td> </tr> <tr> <td>VM1635A0</td> <td>MAGNET HOLDING DIS</td> <td>1</td> <td>PZ</td> </tr> <tr> <td>VM1794A0</td> <td>250X4.8 PA66 BLACK CLAMP</td> <td>4</td> <td>PZ</td> </tr> <tr> <td>VM2103A0</td> <td>CLAMP LOCK</td> <td>4</td> <td>PZ</td> </tr> </tbody> </table>	Code	Description	Qty	UOM	MT1012A0	330W 230V MOTOR	1	PZ	VE1550A0	5X3 MM NEODYMIUM MAGNET	1	PZ	VI1077A1	SCREW M6X12 TE INOX	1	PZ	VI1521A0	STAINLESS STEEL WASHER D=6 6592	1	PZ	VI1966A0	M4X14 FLATHEAD SCREW	1	PZ	VM1635A0	MAGNET HOLDING DIS	1	PZ	VM1794A0	250X4.8 PA66 BLACK CLAMP	4	PZ	VM2103A0	CLAMP LOCK	4	PZ
					Code	Description	Qty	UOM																																	
					MT1012A0	330W 230V MOTOR	1	PZ																																	
					VE1550A0	5X3 MM NEODYMIUM MAGNET	1	PZ																																	
					VI1077A1	SCREW M6X12 TE INOX	1	PZ																																	
					VI1521A0	STAINLESS STEEL WASHER D=6 6592	1	PZ																																	
					VI1966A0	M4X14 FLATHEAD SCREW	1	PZ																																	
					VM1635A0	MAGNET HOLDING DIS	1	PZ																																	
					VM1794A0	250X4.8 PA66 BLACK CLAMP	4	PZ																																	
					VM2103A0	CLAMP LOCK	4	PZ																																	
VN1030A	Ø196 H81 38 BLADES MOTOR FA		KVN1181A	D196 H81 39 BLADES FAN+SCREW M6 KIT	<table border="1"> <thead> <tr> <th>Code</th> <th>Description</th> <th>Qty</th> <th>UOM</th> </tr> </thead> <tbody> <tr> <td>VI1077A1</td> <td>SCREW M6X12 TE INOX</td> <td>1</td> <td>PZ</td> </tr> <tr> <td>VI1521A0</td> <td>STAINLESS STEEL WASHER D=6 6592</td> <td>1</td> <td>PZ</td> </tr> <tr> <td>VN1181A0</td> <td>M6 NUT 39 BLADES H81 D196 FAN</td> <td>1</td> <td>PZ</td> </tr> <tr> <td>VN1181A0</td> <td>M6 NUT 39 BLADES H81 D196 FAN</td> <td>1</td> <td>PZ</td> </tr> </tbody> </table>	Code	Description	Qty	UOM	VI1077A1	SCREW M6X12 TE INOX	1	PZ	VI1521A0	STAINLESS STEEL WASHER D=6 6592	1	PZ	VN1181A0	M6 NUT 39 BLADES H81 D196 FAN	1	PZ	VN1181A0	M6 NUT 39 BLADES H81 D196 FAN	1	PZ																
					Code	Description	Qty	UOM																																	
					VI1077A1	SCREW M6X12 TE INOX	1	PZ																																	
					VI1521A0	STAINLESS STEEL WASHER D=6 6592	1	PZ																																	
					VN1181A0	M6 NUT 39 BLADES H81 D196 FAN	1	PZ																																	
			VN1181A0	M6 NUT 39 BLADES H81 D196 FAN	1	PZ																																			
			KVN1030A	LUX =08.2017S.5/S.5E D196 FAN KIT	<table border="1"> <thead> <tr> <th>Code</th> <th>Description</th> <th>Qty</th> <th>UOM</th> </tr> </thead> <tbody> <tr> <td>VI1256A0</td> <td>M8 DIN 980M ST. STEEL SELF LOCKING NUT</td> <td>1</td> <td>PZ</td> </tr> <tr> <td>VM2196A0</td> <td>MOTOR NUT FASTENING BUSHING</td> <td>1</td> <td>PZ</td> </tr> <tr> <td>VN1030A5</td> <td>Ø196 H81 38 BLADES MOTOR FAN</td> <td>1</td> <td>PZ</td> </tr> <tr> <td>VN1030A5</td> <td>Ø196 H81 38 BLADES MOTOR FAN</td> <td>1</td> <td>PZ</td> </tr> </tbody> </table>	Code	Description	Qty	UOM	VI1256A0	M8 DIN 980M ST. STEEL SELF LOCKING NUT	1	PZ	VM2196A0	MOTOR NUT FASTENING BUSHING	1	PZ	VN1030A5	Ø196 H81 38 BLADES MOTOR FAN	1	PZ	VN1030A5	Ø196 H81 38 BLADES MOTOR FAN	1	PZ																
					Code	Description	Qty	UOM																																	
					VI1256A0	M8 DIN 980M ST. STEEL SELF LOCKING NUT	1	PZ																																	
					VM2196A0	MOTOR NUT FASTENING BUSHING	1	PZ																																	
VN1030A5	Ø196 H81 38 BLADES MOTOR FAN	1			PZ																																				
VN1030A5	Ø196 H81 38 BLADES MOTOR FAN	1	PZ																																						

COMPONENT			SPARE PART																						
Code	Description	Image	Code	Description	Components list																				
VM1610A	CLIP TWIST LOCK DIAM. 7,6-10,2 MM		VM1605A0	CLIP TWIST LOCK DIAM. 10,2-12,7 MM																					
0H4851A	BT CT WIRING SUPPORT BRACKET		0H4851A1	BT CT WIRING SUPPORT BRACKET																					
GN1140A	MOLDED MOTOR HOLDER GASKET		KGN1140A	5 PCS. MOTOR HOLDER GASKET KI	<table border="1"> <thead> <tr> <th>Code</th> <th>Description</th> <th>Qty</th> <th>UOM</th> </tr> </thead> <tbody> <tr> <td>GN1140A2</td> <td>MOTOR HOLDER GASKET</td> <td>5</td> <td>PZ</td> </tr> <tr> <td>GN1140A3</td> <td>MOLDED MOTOR HOLDER GASKET</td> <td>5</td> <td>PZ</td> </tr> <tr> <td>VM1224A0</td> <td>65MY 220MM 2 COLOURS SHRINK TUBE</td> <td>0.200</td> <td>M</td> </tr> </tbody> </table>	Code	Description	Qty	UOM	GN1140A2	MOTOR HOLDER GASKET	5	PZ	GN1140A3	MOLDED MOTOR HOLDER GASKET	5	PZ	VM1224A0	65MY 220MM 2 COLOURS SHRINK TUBE	0.200	M				
Code	Description	Qty	UOM																						
GN1140A2	MOTOR HOLDER GASKET	5	PZ																						
GN1140A3	MOLDED MOTOR HOLDER GASKET	5	PZ																						
VM1224A0	65MY 220MM 2 COLOURS SHRINK TUBE	0.200	M																						
TB1515A	EXTERNAL HUMIDITY PIPE + RC1165A0		TB1515A1	EXTERNAL HUMIDITY PIPE + RC1165A0																					
GN1392C	XVC1005-4005 DOOR GASKET - GN1006A		KGN1661A	TROLLEY OVENS DOOR GASKET KIT	<table border="1"> <thead> <tr> <th>Code</th> <th>Description</th> <th>Qty</th> <th>UOM</th> </tr> </thead> <tbody> <tr> <td>GN1626A0</td> <td>DOUBLE LIP-TYPE FRONT GASKE</td> <td>4.190</td> <td>M</td> </tr> <tr> <td>SL1025A0</td> <td>CLEAR SILICON DOW CORNING 734</td> <td>0.012</td> <td>PZ</td> </tr> <tr> <td>VM1224A0</td> <td>65MY 220MM 2 COLOURS SHRINK TUBE</td> <td>0.450</td> <td>M</td> </tr> <tr> <td>VM2277A0</td> <td>DOOR SEAL KIT INTERNAL CONNECTION</td> <td>1</td> <td>PZ</td> </tr> </tbody> </table>	Code	Description	Qty	UOM	GN1626A0	DOUBLE LIP-TYPE FRONT GASKE	4.190	M	SL1025A0	CLEAR SILICON DOW CORNING 734	0.012	PZ	VM1224A0	65MY 220MM 2 COLOURS SHRINK TUBE	0.450	M	VM2277A0	DOOR SEAL KIT INTERNAL CONNECTION	1	PZ
Code	Description	Qty	UOM																						
GN1626A0	DOUBLE LIP-TYPE FRONT GASKE	4.190	M																						
SL1025A0	CLEAR SILICON DOW CORNING 734	0.012	PZ																						
VM1224A0	65MY 220MM 2 COLOURS SHRINK TUBE	0.450	M																						
VM2277A0	DOOR SEAL KIT INTERNAL CONNECTION	1	PZ																						

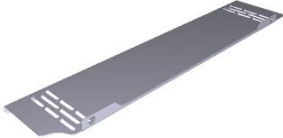
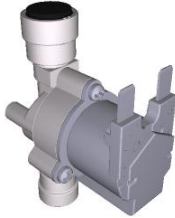
COMPONENT			SPARE PART																										
Code	Description	Image	Code	Description	Components list																								
GN1392C	XVC1005-4005 DOOR GASKET - GN1006A		KGN1392C	900 SERIES DOOR GASKET KIT	<table border="1"> <thead> <tr> <th>Code</th> <th>Description</th> <th>Qty</th> <th>UOM</th> </tr> </thead> <tbody> <tr> <td>GN1006A1</td> <td>DOOR GASKE</td> <td>4.050</td> <td>M</td> </tr> <tr> <td>GN1008A0</td> <td>DOOR SEAL INTERNAL CONNECTION</td> <td>0.030</td> <td>M</td> </tr> <tr> <td>SL1025A0</td> <td>CLEAR SILICON DOW CORNING 734</td> <td>0.012</td> <td>PZ</td> </tr> <tr> <td>VM1224A0</td> <td>65MY 220MM 2 COLOURS SHRINK TUBE</td> <td>0.450</td> <td>M</td> </tr> <tr> <td>VM2277A0</td> <td>DOOR SEAL KIT INTERNAL CONNECTION</td> <td>1</td> <td>PZ</td> </tr> </tbody> </table>	Code	Description	Qty	UOM	GN1006A1	DOOR GASKE	4.050	M	GN1008A0	DOOR SEAL INTERNAL CONNECTION	0.030	M	SL1025A0	CLEAR SILICON DOW CORNING 734	0.012	PZ	VM1224A0	65MY 220MM 2 COLOURS SHRINK TUBE	0.450	M	VM2277A0	DOOR SEAL KIT INTERNAL CONNECTION	1	PZ
					Code	Description	Qty	UOM																					
					GN1006A1	DOOR GASKE	4.050	M																					
					GN1008A0	DOOR SEAL INTERNAL CONNECTION	0.030	M																					
					SL1025A0	CLEAR SILICON DOW CORNING 734	0.012	PZ																					
					VM1224A0	65MY 220MM 2 COLOURS SHRINK TUBE	0.450	M																					
VM2277A0	DOOR SEAL KIT INTERNAL CONNECTION	1	PZ																										
OG1396A			OG1396A0	FAN GUARD SPACE																									
EL1252A	1 WAY WATER VALVE + J.G. CONNECTION		KEL1252A	EL2 JG D8-D10 1 WAY SOLENOID VALVE KIT	<table border="1"> <thead> <tr> <th>Code</th> <th>Description</th> <th>Qty</th> <th>UOM</th> </tr> </thead> <tbody> <tr> <td>EL1252A1</td> <td>1 WAY WATER VALVE + J.G. CONNECTION</td> <td>1</td> <td>PZ</td> </tr> <tr> <td>VM1224A0</td> <td>65MY 220MM 2 COLOURS SHRINK TUBE</td> <td>0.250</td> <td>M</td> </tr> </tbody> </table>	Code	Description	Qty	UOM	EL1252A1	1 WAY WATER VALVE + J.G. CONNECTION	1	PZ	VM1224A0	65MY 220MM 2 COLOURS SHRINK TUBE	0.250	M												
					Code	Description	Qty	UOM																					
EL1252A1	1 WAY WATER VALVE + J.G. CONNECTION	1	PZ																										
VM1224A0	65MY 220MM 2 COLOURS SHRINK TUBE	0.250	M																										

ASM1543A/0.D02 -

FRONT

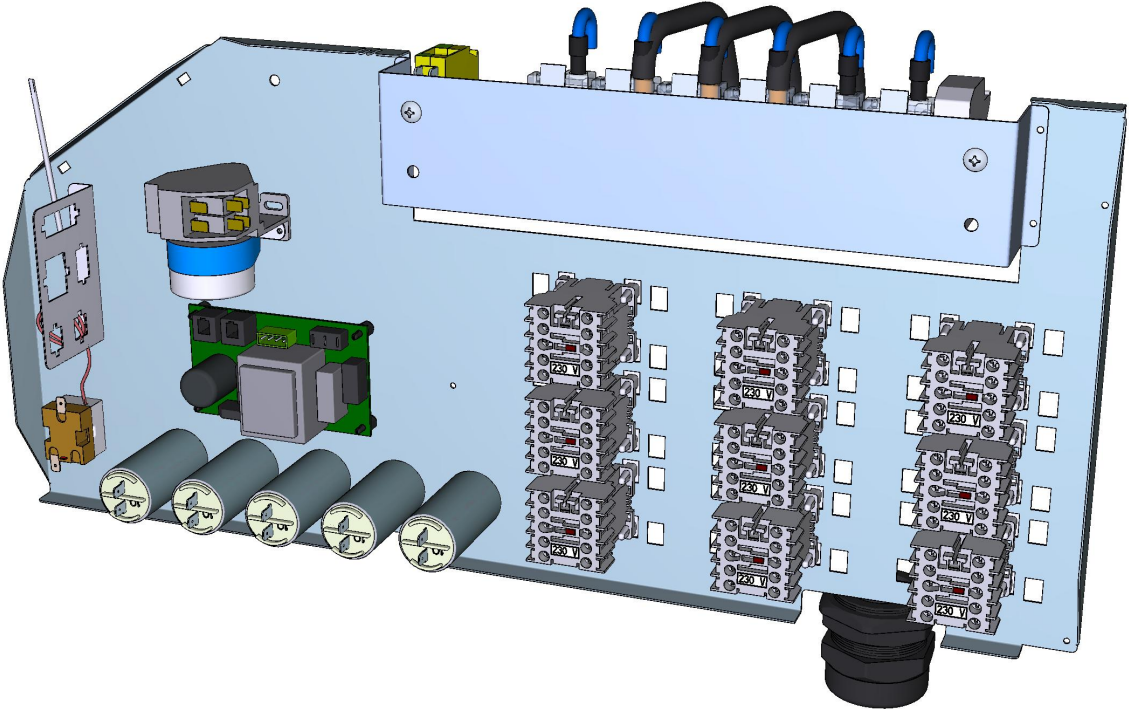



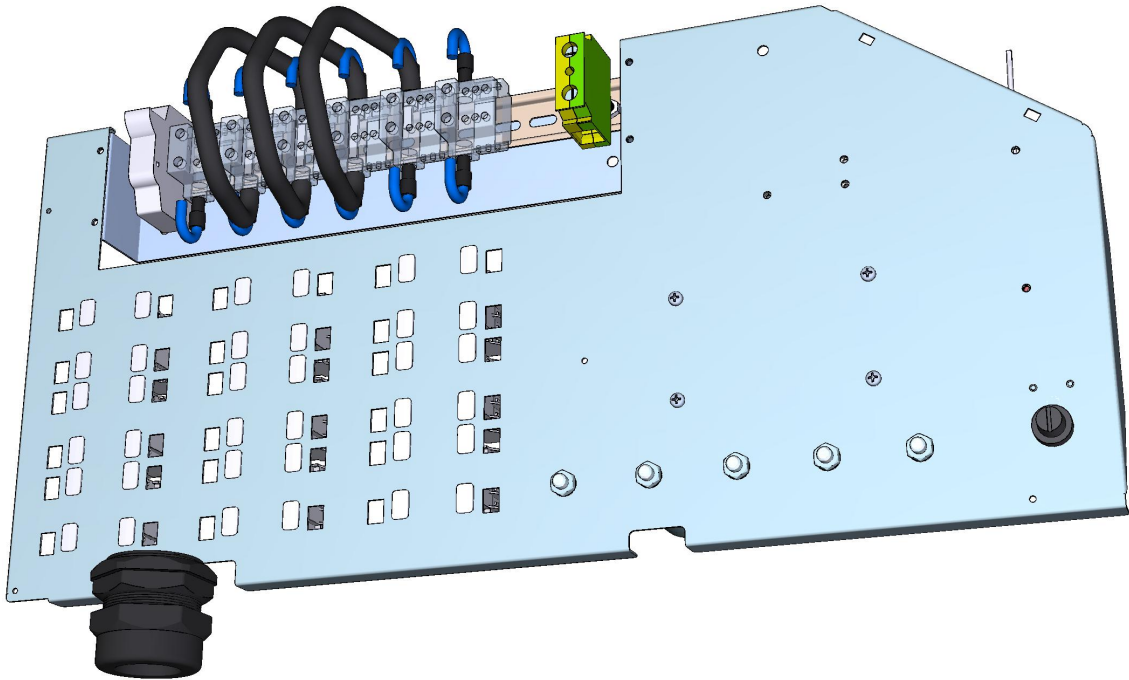

ASM1543A/0.D02 -

REAR

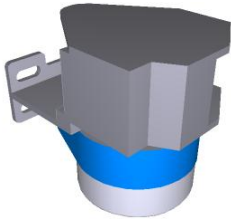

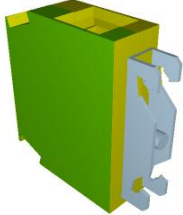
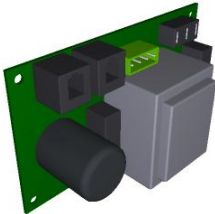

COMPONENT			SPARE PART																																		
Code	Description	Image	Code	Description	Components list																																
TR1136A	330°C 1 POLE SAFETY THERMOSTAT		KTR1136A	330°C SAFETY THERMOSTAT KIT	<table border="1"> <thead> <tr> <th>Code</th> <th>Description</th> <th>Qty</th> <th>UOM</th> </tr> </thead> <tbody> <tr> <td>0H7030A0</td> <td>THERMOSTAT BULB INLET COVER</td> <td>1</td> <td>PZ</td> </tr> <tr> <td>GN1531A0</td> <td>THERMOSTAT BULB INLET SEALING</td> <td>1</td> <td>PZ</td> </tr> <tr> <td>MOV0011A0</td> <td>HOOD RING GASKET</td> <td>0.100</td> <td>PZ</td> </tr> <tr> <td>GN1110A2</td> <td></td> <td></td> <td></td> </tr> <tr> <td>SL1045A0</td> <td>S57 BLACK SILICONE - 80ML CARTRIDGE</td> <td>1</td> <td>PZ</td> </tr> <tr> <td>TR1136A0</td> <td>330°C 1 POLE SAFETY THERMOSTAT</td> <td>1</td> <td>PZ</td> </tr> <tr> <td>VI1220A1</td> <td>4,2X12 TCB SELF-TAPPING SCREW</td> <td>3</td> <td>PZ</td> </tr> </tbody> </table>	Code	Description	Qty	UOM	0H7030A0	THERMOSTAT BULB INLET COVER	1	PZ	GN1531A0	THERMOSTAT BULB INLET SEALING	1	PZ	MOV0011A0	HOOD RING GASKET	0.100	PZ	GN1110A2				SL1045A0	S57 BLACK SILICONE - 80ML CARTRIDGE	1	PZ	TR1136A0	330°C 1 POLE SAFETY THERMOSTAT	1	PZ	VI1220A1	4,2X12 TCB SELF-TAPPING SCREW	3	PZ
Code	Description	Qty	UOM																																		
0H7030A0	THERMOSTAT BULB INLET COVER	1	PZ																																		
GN1531A0	THERMOSTAT BULB INLET SEALING	1	PZ																																		
MOV0011A0	HOOD RING GASKET	0.100	PZ																																		
GN1110A2																																					
SL1045A0	S57 BLACK SILICONE - 80ML CARTRIDGE	1	PZ																																		
TR1136A0	330°C 1 POLE SAFETY THERMOSTAT	1	PZ																																		
VI1220A1	4,2X12 TCB SELF-TAPPING SCREW	3	PZ																																		
CN1003A	6,3 UF MOTOR CAPACITOR		KCN1003A	6,3 UF MOTOR CAPACITOR KIT	<table border="1"> <thead> <tr> <th>Code</th> <th>Description</th> <th>Qty</th> <th>UOM</th> </tr> </thead> <tbody> <tr> <td>CN1003A0</td> <td>6,3 UF MOTOR CAPACITOR</td> <td>1</td> <td>PZ</td> </tr> <tr> <td>VI1931A0</td> <td>M8 NUT+INDENTE D WASHER D=8 X COND.</td> <td>1</td> <td>PZ</td> </tr> <tr> <td>VI1932A0</td> <td>M8 NUT+INDENTE D WASHER D=8 X COND.</td> <td>1</td> <td>PZ</td> </tr> <tr> <td>VM1224A0</td> <td>65MY 220MM 2 COLOURS SHRINK TUBE</td> <td>0.200</td> <td>M</td> </tr> </tbody> </table>	Code	Description	Qty	UOM	CN1003A0	6,3 UF MOTOR CAPACITOR	1	PZ	VI1931A0	M8 NUT+INDENTE D WASHER D=8 X COND.	1	PZ	VI1932A0	M8 NUT+INDENTE D WASHER D=8 X COND.	1	PZ	VM1224A0	65MY 220MM 2 COLOURS SHRINK TUBE	0.200	M												
Code	Description	Qty	UOM																																		
CN1003A0	6,3 UF MOTOR CAPACITOR	1	PZ																																		
VI1931A0	M8 NUT+INDENTE D WASHER D=8 X COND.	1	PZ																																		
VI1932A0	M8 NUT+INDENTE D WASHER D=8 X COND.	1	PZ																																		
VM1224A0	65MY 220MM 2 COLOURS SHRINK TUBE	0.200	M																																		
VM1745A	CARD SUPPORT		KVM1745A	BOARD SUPPORT 10 PCS KIT	<table border="1"> <thead> <tr> <th>Code</th> <th>Description</th> <th>Qty</th> <th>UOM</th> </tr> </thead> <tbody> <tr> <td>VM1224A0</td> <td>65MY 220MM 2 COLOURS SHRINK TUBE</td> <td>0.200</td> <td>M</td> </tr> <tr> <td>VM1745A0</td> <td>CARD SUPPORT</td> <td>10</td> <td>PZ</td> </tr> </tbody> </table>	Code	Description	Qty	UOM	VM1224A0	65MY 220MM 2 COLOURS SHRINK TUBE	0.200	M	VM1745A0	CARD SUPPORT	10	PZ																				
Code	Description	Qty	UOM																																		
VM1224A0	65MY 220MM 2 COLOURS SHRINK TUBE	0.200	M																																		
VM1745A0	CARD SUPPORT	10	PZ																																		
VE1555A	MOTOR REVERSING SWITCH		KVE1615A	MOTOR REVERSING SWITCH KIT	<table border="1"> <thead> <tr> <th>Code</th> <th>Description</th> <th>Qty</th> <th>UOM</th> </tr> </thead> <tbody> <tr> <td>0H1429A0</td> <td>VE1615A INVERTER FIXING PLATE</td> <td>1</td> <td>PZ</td> </tr> <tr> <td>VE1615A0</td> <td>MOTOR REVERSING SWITCH</td> <td>1</td> <td>PZ</td> </tr> </tbody> </table>	Code	Description	Qty	UOM	0H1429A0	VE1615A INVERTER FIXING PLATE	1	PZ	VE1615A0	MOTOR REVERSING SWITCH	1	PZ																				
Code	Description	Qty	UOM																																		
0H1429A0	VE1615A INVERTER FIXING PLATE	1	PZ																																		
VE1615A0	MOTOR REVERSING SWITCH	1	PZ																																		

COMPONENT			SPARE PART																		
Code	Description	Image	Code	Description	Components list																
VE1555A	MOTOR REVERSING SWITCH		KVE1615A	MOTOR REVERSING SWITCH KIT	<table border="1"> <thead> <tr> <th>Code</th> <th>Description</th> <th>Qty</th> <th>UOM</th> </tr> </thead> <tbody> <tr> <td>VI1960A0</td> <td>SELF-TAPPIN G SCREW 4.2X11 TCBS+ AISI410</td> <td>3</td> <td>PZ</td> </tr> <tr> <td>VI1960A1</td> <td>4.2X9.5 CROSS ZN-NI SELF-THREADI NG SCREW</td> <td>3</td> <td>PZ</td> </tr> </tbody> </table>	Code	Description	Qty	UOM	VI1960A0	SELF-TAPPIN G SCREW 4.2X11 TCBS+ AISI410	3	PZ	VI1960A1	4.2X9.5 CROSS ZN-NI SELF-THREADI NG SCREW	3	PZ				
Code	Description	Qty	UOM																		
VI1960A0	SELF-TAPPIN G SCREW 4.2X11 TCBS+ AISI410	3	PZ																		
VI1960A1	4.2X9.5 CROSS ZN-NI SELF-THREADI NG SCREW	3	PZ																		
VI1327A	M6 ZN H=4 NUT		VI1327A0	M6 ZN H=4 NUT																	
MR1011A	UL 125A GROUND TERMINAL		KMR1011A	UL 125A GROUND TERMINAL KIT	<table border="1"> <thead> <tr> <th>Code</th> <th>Description</th> <th>Qty</th> <th>UOM</th> </tr> </thead> <tbody> <tr> <td>MR1011A0</td> <td>UL 125A GROUND TERMINAL</td> <td>1</td> <td>PZ</td> </tr> <tr> <td>VM1224A0</td> <td>65MY 220MM 2 COLOURS SHRINK TUBE</td> <td>0.300</td> <td>M</td> </tr> </tbody> </table>	Code	Description	Qty	UOM	MR1011A0	UL 125A GROUND TERMINAL	1	PZ	VM1224A0	65MY 220MM 2 COLOURS SHRINK TUBE	0.300	M				
Code	Description	Qty	UOM																		
MR1011A0	UL 125A GROUND TERMINAL	1	PZ																		
VM1224A0	65MY 220MM 2 COLOURS SHRINK TUBE	0.300	M																		
PE1780A	CARDBUS 230V 50/60HZ		KPE1780A	BUS POWER SUPPLY BOARD KIT 230V 50/60HZ	<table border="1"> <thead> <tr> <th>Code</th> <th>Description</th> <th>Qty</th> <th>UOM</th> </tr> </thead> <tbody> <tr> <td>PE1780A0</td> <td>CARDBUS 230V 50/60HZ</td> <td>1</td> <td>PZ</td> </tr> <tr> <td>VI1850A0</td> <td>M4X6 NICKEL PLATED FIXING SCREW</td> <td>4</td> <td>PZ</td> </tr> <tr> <td>VM1745A0</td> <td>CARD SUPPORT</td> <td>4</td> <td>PZ</td> </tr> </tbody> </table>	Code	Description	Qty	UOM	PE1780A0	CARDBUS 230V 50/60HZ	1	PZ	VI1850A0	M4X6 NICKEL PLATED FIXING SCREW	4	PZ	VM1745A0	CARD SUPPORT	4	PZ
Code	Description	Qty	UOM																		
PE1780A0	CARDBUS 230V 50/60HZ	1	PZ																		
VI1850A0	M4X6 NICKEL PLATED FIXING SCREW	4	PZ																		
VM1745A0	CARD SUPPORT	4	PZ																		
0H6769A	CONNECTOR FIXING PANEL		0H6769B0																		



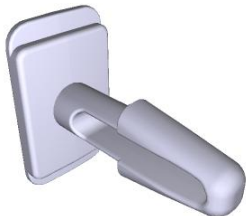

COMPONENT			SPARE PART																						
Code	Description	Image	Code	Description	Components list																				
VE1115A	20 A 230V 4 POLES MINICONTACTOR		KVE1115A	20A 230V 4 POLES MINICONTACTOR KI	<table border="1"> <thead> <tr> <th>Code</th> <th>Description</th> <th>Qty</th> <th>UOM</th> </tr> </thead> <tbody> <tr> <td>VE1115A0</td> <td>20 A 230V 4 POLES MINICONTACT OR</td> <td>1</td> <td>PZ</td> </tr> <tr> <td>VM1075A1</td> <td>PLASTIC CLIP TO FIX CONTACTORS</td> <td>4</td> <td>PZ</td> </tr> <tr> <td>VM1224A0</td> <td>65MY 220MM 2 COLOURS SHRINK TUBE</td> <td>0.250</td> <td>M</td> </tr> </tbody> </table>	Code	Description	Qty	UOM	VE1115A0	20 A 230V 4 POLES MINICONTACT OR	1	PZ	VM1075A1	PLASTIC CLIP TO FIX CONTACTORS	4	PZ	VM1224A0	65MY 220MM 2 COLOURS SHRINK TUBE	0.250	M				
					Code	Description	Qty	UOM																	
					VE1115A0	20 A 230V 4 POLES MINICONTACT OR	1	PZ																	
VM1075A1	PLASTIC CLIP TO FIX CONTACTORS	4	PZ																						
VM1224A0	65MY 220MM 2 COLOURS SHRINK TUBE	0.250	M																						
<table border="1"> <thead> <tr> <th>Code</th> <th>Description</th> <th>Qty</th> <th>UOM</th> </tr> </thead> <tbody> <tr> <td>VM1075A1</td> <td>PLASTIC CLIP TO FIX CONTACTORS</td> <td>50</td> <td>PZ</td> </tr> <tr> <td>VM1224A0</td> <td>65MY 220MM 2 COLOURS SHRINK TUBE</td> <td>0.200</td> <td>M</td> </tr> </tbody> </table>	Code	Description	Qty	UOM	VM1075A1	PLASTIC CLIP TO FIX CONTACTORS	50	PZ	VM1224A0	65MY 220MM 2 COLOURS SHRINK TUBE	0.200	M													
Code	Description	Qty	UOM																						
VM1075A1	PLASTIC CLIP TO FIX CONTACTORS	50	PZ																						
VM1224A0	65MY 220MM 2 COLOURS SHRINK TUBE	0.200	M																						
<table border="1"> <thead> <tr> <th>Code</th> <th>Description</th> <th>Qty</th> <th>UOM</th> </tr> </thead> <tbody> <tr> <td>CE1420A0</td> <td>8 WAYS UNIPOLAR TERMINAL BLOCK Z16-8D</td> <td>1</td> <td>PZ</td> </tr> <tr> <td>VM1224A0</td> <td>65MY 220MM 2 COLOURS SHRINK TUBE</td> <td>0.250</td> <td>M</td> </tr> </tbody> </table>	Code	Description	Qty	UOM	CE1420A0	8 WAYS UNIPOLAR TERMINAL BLOCK Z16-8D	1	PZ	VM1224A0	65MY 220MM 2 COLOURS SHRINK TUBE	0.250	M													
Code	Description	Qty	UOM																						
CE1420A0	8 WAYS UNIPOLAR TERMINAL BLOCK Z16-8D	1	PZ																						
VM1224A0	65MY 220MM 2 COLOURS SHRINK TUBE	0.250	M																						
VM1075A	PLASTIC CLIP TO FIX CONTACTORS		KVM1075A	CLIP TO FIX CONTACTORS 50 PCS. KIT	<table border="1"> <thead> <tr> <th>Code</th> <th>Description</th> <th>Qty</th> <th>UOM</th> </tr> </thead> <tbody> <tr> <td>CE1420A0</td> <td>8 WAYS UNIPOLAR TERMINAL BLOCK Z16-8D</td> <td>1</td> <td>PZ</td> </tr> <tr> <td>VM1224A0</td> <td>65MY 220MM 2 COLOURS SHRINK TUBE</td> <td>0.250</td> <td>M</td> </tr> </tbody> </table>	Code	Description	Qty	UOM	CE1420A0	8 WAYS UNIPOLAR TERMINAL BLOCK Z16-8D	1	PZ	VM1224A0	65MY 220MM 2 COLOURS SHRINK TUBE	0.250	M								
Code	Description	Qty	UOM																						
CE1420A0	8 WAYS UNIPOLAR TERMINAL BLOCK Z16-8D	1	PZ																						
VM1224A0	65MY 220MM 2 COLOURS SHRINK TUBE	0.250	M																						
CE1420A	8 WAYS UNIPOLAR TERMINAL BLOCK Z16-8D		KCE1420A	8 WAY Z16-8D UNIPOLAR TERMINAL BOARD KIT	<table border="1"> <thead> <tr> <th>Code</th> <th>Description</th> <th>Qty</th> <th>UOM</th> </tr> </thead> <tbody> <tr> <td>CN1003A0</td> <td>6,3 UF MOTOR CAPACITOR</td> <td>1</td> <td>PZ</td> </tr> <tr> <td>VI1931A0</td> <td>M8 NUT+INDENTE D WASHER D=8 X COND.</td> <td>1</td> <td>PZ</td> </tr> <tr> <td>VI1932A0</td> <td>M8 NUT+INDENTE D WASHER D=8 X COND.</td> <td>1</td> <td>PZ</td> </tr> <tr> <td>VM1224A0</td> <td>65MY 220MM 2 COLOURS SHRINK TUBE</td> <td>0.200</td> <td>M</td> </tr> </tbody> </table>	Code	Description	Qty	UOM	CN1003A0	6,3 UF MOTOR CAPACITOR	1	PZ	VI1931A0	M8 NUT+INDENTE D WASHER D=8 X COND.	1	PZ	VI1932A0	M8 NUT+INDENTE D WASHER D=8 X COND.	1	PZ	VM1224A0	65MY 220MM 2 COLOURS SHRINK TUBE	0.200	M
Code	Description	Qty	UOM																						
CN1003A0	6,3 UF MOTOR CAPACITOR	1	PZ																						
VI1931A0	M8 NUT+INDENTE D WASHER D=8 X COND.	1	PZ																						
VI1932A0	M8 NUT+INDENTE D WASHER D=8 X COND.	1	PZ																						
VM1224A0	65MY 220MM 2 COLOURS SHRINK TUBE	0.200	M																						
VE1110A	CONDENSER 6,3 ?F 450VAC 50/60HZ		KCN1003A	6,3 UF MOTOR CAPACITOR KIT	<table border="1"> <thead> <tr> <th>Code</th> <th>Description</th> <th>Qty</th> <th>UOM</th> </tr> </thead> <tbody> <tr> <td>CN1003A0</td> <td>6,3 UF MOTOR CAPACITOR</td> <td>1</td> <td>PZ</td> </tr> <tr> <td>VI1931A0</td> <td>M8 NUT+INDENTE D WASHER D=8 X COND.</td> <td>1</td> <td>PZ</td> </tr> <tr> <td>VI1932A0</td> <td>M8 NUT+INDENTE D WASHER D=8 X COND.</td> <td>1</td> <td>PZ</td> </tr> <tr> <td>VM1224A0</td> <td>65MY 220MM 2 COLOURS SHRINK TUBE</td> <td>0.200</td> <td>M</td> </tr> </tbody> </table>	Code	Description	Qty	UOM	CN1003A0	6,3 UF MOTOR CAPACITOR	1	PZ	VI1931A0	M8 NUT+INDENTE D WASHER D=8 X COND.	1	PZ	VI1932A0	M8 NUT+INDENTE D WASHER D=8 X COND.	1	PZ	VM1224A0	65MY 220MM 2 COLOURS SHRINK TUBE	0.200	M
Code	Description	Qty	UOM																						
CN1003A0	6,3 UF MOTOR CAPACITOR	1	PZ																						
VI1931A0	M8 NUT+INDENTE D WASHER D=8 X COND.	1	PZ																						
VI1932A0	M8 NUT+INDENTE D WASHER D=8 X COND.	1	PZ																						
VM1224A0	65MY 220MM 2 COLOURS SHRINK TUBE	0.200	M																						



COMPONENT			SPARE PART										
Code	Description	Image	Code	Description	Components list								
VE1632A	MONOPOL SECTION FUSE HOLDER 10X38 32A		KVE1632A	10X38 32A FUSE HOLDER KIT	<table border="1"> <thead> <tr> <th>Code</th> <th>Description</th> <th>Qty</th> <th>UOM</th> </tr> </thead> <tbody> <tr> <td>VE1632A0</td> <td>MONOPOL SECTION FUSE HOLDER 10X38 32A</td> <td>1</td> <td>PZ</td> </tr> </tbody> </table>	Code	Description	Qty	UOM	VE1632A0	MONOPOL SECTION FUSE HOLDER 10X38 32A	1	PZ
Code	Description	Qty	UOM										
VE1632A0	MONOPOL SECTION FUSE HOLDER 10X38 32A	1	PZ										



ASM1570A/0.D02 -





ASM1570A/0.D02 -



COMPONENT			SPARE PART																										
Code	Description	Image	Code	Description	Components list																								
VI1081A	M6X25 STAINLESS STEEL SCREW		KVI1081A	10PCS. M6X25 ST.STEEL SCREW KI	<table border="1"> <thead> <tr> <th>Code</th> <th>Description</th> <th>Qty</th> <th>UOM</th> </tr> </thead> <tbody> <tr> <td>VI1081A0</td> <td>M6X25 STAINLESS STEEL SCREW</td> <td>10</td> <td>PZ</td> </tr> <tr> <td>VM1224A0</td> <td>65MY 220MM 2 COLOURS SHRINK TUBE</td> <td>0.200</td> <td>M</td> </tr> </tbody> </table>	Code	Description	Qty	UOM	VI1081A0	M6X25 STAINLESS STEEL SCREW	10	PZ	VM1224A0	65MY 220MM 2 COLOURS SHRINK TUBE	0.200	M												
Code	Description	Qty	UOM																										
VI1081A0	M6X25 STAINLESS STEEL SCREW	10	PZ																										
VM1224A0	65MY 220MM 2 COLOURS SHRINK TUBE	0.200	M																										
VM1750A	BRASS COMB CLAM		KVM1750A	COMB TERMINAL BLOCK KIT	<table border="1"> <thead> <tr> <th>Code</th> <th>Description</th> <th>Qty</th> <th>UOM</th> </tr> </thead> <tbody> <tr> <td>VM1224A0</td> <td>65MY 220MM 2 COLOURS SHRINK TUBE</td> <td>0.150</td> <td>M</td> </tr> <tr> <td>VM1750A0</td> <td>BRASS COMB CLAMP</td> <td>1</td> <td>PZ</td> </tr> </tbody> </table>	Code	Description	Qty	UOM	VM1224A0	65MY 220MM 2 COLOURS SHRINK TUBE	0.150	M	VM1750A0	BRASS COMB CLAMP	1	PZ												
Code	Description	Qty	UOM																										
VM1224A0	65MY 220MM 2 COLOURS SHRINK TUBE	0.150	M																										
VM1750A0	BRASS COMB CLAMP	1	PZ																										
VN1165A	230VAC 50/60HZ COOLING DOWN FA		KVN1165A	S.5E ADVANCE/MM 230V COOLING FAN KIT	<table border="1"> <thead> <tr> <th>Code</th> <th>Description</th> <th>Qty</th> <th>UOM</th> </tr> </thead> <tbody> <tr> <td>MOV0017A0</td> <td>HOOD RING GASKET GN1110A2</td> <td>0.100</td> <td>PZ</td> </tr> <tr> <td>VI1099A0</td> <td>SELF-DRILLIN G SCREW 4.8X13 TCB+ Z</td> <td>4</td> <td>PZ</td> </tr> <tr> <td>VM1555A2</td> <td>CT BT COOLING FAN SUPPORT</td> <td>1</td> <td>PZ</td> </tr> <tr> <td>VN1165A0</td> <td>230VAC 50/60HZ COOLING DOWN FAN</td> <td>1</td> <td>PZ</td> </tr> <tr> <td>VN1165A0</td> <td>230VAC 50/60HZ COOLING DOWN FAN</td> <td>1</td> <td>PZ</td> </tr> </tbody> </table>	Code	Description	Qty	UOM	MOV0017A0	HOOD RING GASKET GN1110A2	0.100	PZ	VI1099A0	SELF-DRILLIN G SCREW 4.8X13 TCB+ Z	4	PZ	VM1555A2	CT BT COOLING FAN SUPPORT	1	PZ	VN1165A0	230VAC 50/60HZ COOLING DOWN FAN	1	PZ	VN1165A0	230VAC 50/60HZ COOLING DOWN FAN	1	PZ
Code	Description	Qty	UOM																										
MOV0017A0	HOOD RING GASKET GN1110A2	0.100	PZ																										
VI1099A0	SELF-DRILLIN G SCREW 4.8X13 TCB+ Z	4	PZ																										
VM1555A2	CT BT COOLING FAN SUPPORT	1	PZ																										
VN1165A0	230VAC 50/60HZ COOLING DOWN FAN	1	PZ																										
VN1165A0	230VAC 50/60HZ COOLING DOWN FAN	1	PZ																										
VM1555A	CT BT COOLING FAN SUPPORT		KVN1165A	S.5E ADVANCE/MM 230V COOLING FAN KIT	<table border="1"> <thead> <tr> <th>Code</th> <th>Description</th> <th>Qty</th> <th>UOM</th> </tr> </thead> <tbody> <tr> <td>MOV0017A0</td> <td>HOOD RING GASKET GN1110A2</td> <td>0.100</td> <td>PZ</td> </tr> <tr> <td>VI1099A0</td> <td>SELF-DRILLIN G SCREW 4.8X13 TCB+ Z</td> <td>4</td> <td>PZ</td> </tr> <tr> <td>VM1555A2</td> <td>CT BT COOLING FAN SUPPORT</td> <td>1</td> <td>PZ</td> </tr> <tr> <td>VN1165A0</td> <td>230VAC 50/60HZ COOLING DOWN FAN</td> <td>1</td> <td>PZ</td> </tr> <tr> <td>VN1165A0</td> <td>230VAC 50/60HZ COOLING DOWN FAN</td> <td>1</td> <td>PZ</td> </tr> </tbody> </table>	Code	Description	Qty	UOM	MOV0017A0	HOOD RING GASKET GN1110A2	0.100	PZ	VI1099A0	SELF-DRILLIN G SCREW 4.8X13 TCB+ Z	4	PZ	VM1555A2	CT BT COOLING FAN SUPPORT	1	PZ	VN1165A0	230VAC 50/60HZ COOLING DOWN FAN	1	PZ	VN1165A0	230VAC 50/60HZ COOLING DOWN FAN	1	PZ
Code	Description	Qty	UOM																										
MOV0017A0	HOOD RING GASKET GN1110A2	0.100	PZ																										
VI1099A0	SELF-DRILLIN G SCREW 4.8X13 TCB+ Z	4	PZ																										
VM1555A2	CT BT COOLING FAN SUPPORT	1	PZ																										
VN1165A0	230VAC 50/60HZ COOLING DOWN FAN	1	PZ																										
VN1165A0	230VAC 50/60HZ COOLING DOWN FAN	1	PZ																										

COMPONENT			SPARE PART																														
Code	Description	Image	Code	Description	Components list																												
VM1555A	CT BT COOLING FAN SUPPORT		KVN1164A	S.5/5E 12VDC COOLING DOWN FAN KIT	<table border="1"> <thead> <tr> <th>Code</th> <th>Description</th> <th>Qty</th> <th>UOM</th> </tr> </thead> <tbody> <tr> <td>VI1099A0</td> <td>SELF-DRILLIN G SCREW 4.8X13 TCB+ Z</td> <td>4</td> <td>PZ</td> </tr> <tr> <td>VM1555A2</td> <td>CT BT COOLING FAN SUPPORT</td> <td>1</td> <td>PZ</td> </tr> <tr> <td>VN1164A0</td> <td>12VDC COOLING DONW FAN</td> <td>1</td> <td>PZ</td> </tr> <tr> <td>VN1164A0</td> <td>12VDC COOLING DONW FAN</td> <td>1</td> <td>PZ</td> </tr> </tbody> </table>	Code	Description	Qty	UOM	VI1099A0	SELF-DRILLIN G SCREW 4.8X13 TCB+ Z	4	PZ	VM1555A2	CT BT COOLING FAN SUPPORT	1	PZ	VN1164A0	12VDC COOLING DONW FAN	1	PZ	VN1164A0	12VDC COOLING DONW FAN	1	PZ								
Code	Description	Qty	UOM																														
VI1099A0	SELF-DRILLIN G SCREW 4.8X13 TCB+ Z	4	PZ																														
VM1555A2	CT BT COOLING FAN SUPPORT	1	PZ																														
VN1164A0	12VDC COOLING DONW FAN	1	PZ																														
VN1164A0	12VDC COOLING DONW FAN	1	PZ																														
VM1556A	XBC-XVC COOLING FAN GUARD		KVM1556A	XBC-XVC COOLING FAN GUARD KIT	<table border="1"> <thead> <tr> <th>Code</th> <th>Description</th> <th>Qty</th> <th>UOM</th> </tr> </thead> <tbody> <tr> <td>VM1556A0</td> <td>XBC-XVC COOLING FAN GUARD</td> <td>1</td> <td>PZ</td> </tr> </tbody> </table>	Code	Description	Qty	UOM	VM1556A0	XBC-XVC COOLING FAN GUARD	1	PZ																				
Code	Description	Qty	UOM																														
VM1556A0	XBC-XVC COOLING FAN GUARD	1	PZ																														
RC1055A	Ø25-40 H12 STAINLESS STEEL PIPE CLIP		KRC1055A	Ø25-40 PIPE CLAMP 10PCS KIT	<table border="1"> <thead> <tr> <th>Code</th> <th>Description</th> <th>Qty</th> <th>UOM</th> </tr> </thead> <tbody> <tr> <td>RC1055A0</td> <td>Ø25-40 H12 STAINLESS STEEL PIPE CLIP</td> <td>10</td> <td>PZ</td> </tr> <tr> <td>VM1224A0</td> <td>65MY 220MM 2 COLOURS SHRINK TUBE</td> <td>0.250</td> <td>M</td> </tr> </tbody> </table>	Code	Description	Qty	UOM	RC1055A0	Ø25-40 H12 STAINLESS STEEL PIPE CLIP	10	PZ	VM1224A0	65MY 220MM 2 COLOURS SHRINK TUBE	0.250	M																
Code	Description	Qty	UOM																														
RC1055A0	Ø25-40 H12 STAINLESS STEEL PIPE CLIP	10	PZ																														
VM1224A0	65MY 220MM 2 COLOURS SHRINK TUBE	0.250	M																														
VM1190A	CT BT RIGHT DOOR SPRING LATCH		KVM1190A	CHEFTOP/BAKERTO P DOOR RIGHT LATCH KIT	<table border="1"> <thead> <tr> <th>Code</th> <th>Description</th> <th>Qty</th> <th>UOM</th> </tr> </thead> <tbody> <tr> <td>VI0239A1</td> <td>SELF-TAPPIN G SCREW 4.2X25 TCB+ INOX</td> <td>2</td> <td>PZ</td> </tr> <tr> <td>VI1220A1</td> <td>4.2X12 TCB SELF-TAPPIN G SCREW</td> <td>2</td> <td>PZ</td> </tr> <tr> <td>VM1190A2</td> <td>CT BT RIGHT DOOR SPRING LATCH</td> <td>1</td> <td>PZ</td> </tr> <tr> <td>VM1192A1</td> <td>CT BT DOOR SPRING LATCH BACK COVER</td> <td>1</td> <td>PZ</td> </tr> <tr> <td>VM1224A0</td> <td>65MY 220MM 2 COLOURS SHRINK TUBE</td> <td>0.200</td> <td>M</td> </tr> <tr> <td>VM1460A0</td> <td>XBC/XVC RIGHT DOOR LATCH CAP</td> <td>1</td> <td>PZ</td> </tr> </tbody> </table>	Code	Description	Qty	UOM	VI0239A1	SELF-TAPPIN G SCREW 4.2X25 TCB+ INOX	2	PZ	VI1220A1	4.2X12 TCB SELF-TAPPIN G SCREW	2	PZ	VM1190A2	CT BT RIGHT DOOR SPRING LATCH	1	PZ	VM1192A1	CT BT DOOR SPRING LATCH BACK COVER	1	PZ	VM1224A0	65MY 220MM 2 COLOURS SHRINK TUBE	0.200	M	VM1460A0	XBC/XVC RIGHT DOOR LATCH CAP	1	PZ
Code	Description	Qty	UOM																														
VI0239A1	SELF-TAPPIN G SCREW 4.2X25 TCB+ INOX	2	PZ																														
VI1220A1	4.2X12 TCB SELF-TAPPIN G SCREW	2	PZ																														
VM1190A2	CT BT RIGHT DOOR SPRING LATCH	1	PZ																														
VM1192A1	CT BT DOOR SPRING LATCH BACK COVER	1	PZ																														
VM1224A0	65MY 220MM 2 COLOURS SHRINK TUBE	0.200	M																														
VM1460A0	XBC/XVC RIGHT DOOR LATCH CAP	1	PZ																														

COMPONENT			SPARE PART																														
Code	Description	Image	Code	Description	Components list																												
VM1192A	CT BT DOOR SPRING LATCH BACK COVER		KVM1191A	CHEFTOP/BAKERTO P DOOR LEFT LATCH KIT	<table border="1"> <thead> <tr> <th>Code</th> <th>Description</th> <th>Qty</th> <th>UOM</th> </tr> </thead> <tbody> <tr> <td>VI0239A1</td> <td>SELF-TAPPIN G SCREW 4.2X25 TCB+ INOX</td> <td>2</td> <td>PZ</td> </tr> <tr> <td>VI1220A1</td> <td>4.2X12 TCB SELF-TAPPIN G SCREW</td> <td>2</td> <td>PZ</td> </tr> <tr> <td>VM1191A2</td> <td>CT BT LEFT DOOR SPRING LATCH</td> <td>1</td> <td>PZ</td> </tr> <tr> <td>VM1192A1</td> <td>CT BT DOOR SPRING LATCH BACK COVER</td> <td>1</td> <td>PZ</td> </tr> <tr> <td>VM1224A0</td> <td>65MY 220MM 2 COLOURS SHRINK TUBE</td> <td>0.200</td> <td>M</td> </tr> <tr> <td>VM1460A0</td> <td>XBC/XVC RIGHT DOOR LATCH CAP</td> <td>1</td> <td>PZ</td> </tr> </tbody> </table>	Code	Description	Qty	UOM	VI0239A1	SELF-TAPPIN G SCREW 4.2X25 TCB+ INOX	2	PZ	VI1220A1	4.2X12 TCB SELF-TAPPIN G SCREW	2	PZ	VM1191A2	CT BT LEFT DOOR SPRING LATCH	1	PZ	VM1192A1	CT BT DOOR SPRING LATCH BACK COVER	1	PZ	VM1224A0	65MY 220MM 2 COLOURS SHRINK TUBE	0.200	M	VM1460A0	XBC/XVC RIGHT DOOR LATCH CAP	1	PZ
			Code	Description	Qty	UOM																											
VI0239A1	SELF-TAPPIN G SCREW 4.2X25 TCB+ INOX	2	PZ																														
VI1220A1	4.2X12 TCB SELF-TAPPIN G SCREW	2	PZ																														
VM1191A2	CT BT LEFT DOOR SPRING LATCH	1	PZ																														
VM1192A1	CT BT DOOR SPRING LATCH BACK COVER	1	PZ																														
VM1224A0	65MY 220MM 2 COLOURS SHRINK TUBE	0.200	M																														
VM1460A0	XBC/XVC RIGHT DOOR LATCH CAP	1	PZ																														
KVM1190A	CHEFTOP/BAKERTO P DOOR RIGHT LATCH KIT	<table border="1"> <thead> <tr> <th>Code</th> <th>Description</th> <th>Qty</th> <th>UOM</th> </tr> </thead> <tbody> <tr> <td>VI0239A1</td> <td>SELF-TAPPIN G SCREW 4.2X25 TCB+ INOX</td> <td>2</td> <td>PZ</td> </tr> <tr> <td>VI1220A1</td> <td>4.2X12 TCB SELF-TAPPIN G SCREW</td> <td>2</td> <td>PZ</td> </tr> <tr> <td>VM1190A2</td> <td>CT BT RIGHT DOOR SPRING LATCH</td> <td>1</td> <td>PZ</td> </tr> <tr> <td>VM1192A1</td> <td>CT BT DOOR SPRING LATCH BACK COVER</td> <td>1</td> <td>PZ</td> </tr> <tr> <td>VM1224A0</td> <td>65MY 220MM 2 COLOURS SHRINK TUBE</td> <td>0.200</td> <td>M</td> </tr> <tr> <td>VM1460A0</td> <td>XBC/XVC RIGHT DOOR LATCH CAP</td> <td>1</td> <td>PZ</td> </tr> </tbody> </table>	Code	Description	Qty	UOM	VI0239A1	SELF-TAPPIN G SCREW 4.2X25 TCB+ INOX	2	PZ	VI1220A1	4.2X12 TCB SELF-TAPPIN G SCREW	2	PZ	VM1190A2	CT BT RIGHT DOOR SPRING LATCH	1	PZ	VM1192A1	CT BT DOOR SPRING LATCH BACK COVER	1	PZ	VM1224A0	65MY 220MM 2 COLOURS SHRINK TUBE	0.200	M	VM1460A0	XBC/XVC RIGHT DOOR LATCH CAP	1	PZ			
Code	Description	Qty	UOM																														
VI0239A1	SELF-TAPPIN G SCREW 4.2X25 TCB+ INOX	2	PZ																														
VI1220A1	4.2X12 TCB SELF-TAPPIN G SCREW	2	PZ																														
VM1190A2	CT BT RIGHT DOOR SPRING LATCH	1	PZ																														
VM1192A1	CT BT DOOR SPRING LATCH BACK COVER	1	PZ																														
VM1224A0	65MY 220MM 2 COLOURS SHRINK TUBE	0.200	M																														
VM1460A0	XBC/XVC RIGHT DOOR LATCH CAP	1	PZ																														
VL1005A	U-TRAP TANK		XUC001	SINGLE UNIT INSTALLATION KIT	<table border="1"> <thead> <tr> <th>Code</th> <th>Description</th> <th>Qty</th> <th>UOM</th> </tr> </thead> <tbody> <tr> <td>0H6567A0</td> <td>P-TRAP HOLDING BRACKET</td> <td>1</td> <td>PZ</td> </tr> <tr> <td>GN1400A0</td> <td>U-TRAP SEAL</td> <td>1</td> <td>PZ</td> </tr> <tr> <td>GN1508A0</td> <td>O-RING GASKET COD 2400</td> <td>1</td> <td>PZ</td> </tr> <tr> <td>IL1115A0</td> <td>WOODEN PALET 80X120</td> <td>0.100</td> <td>PZ</td> </tr> </tbody> </table>	Code	Description	Qty	UOM	0H6567A0	P-TRAP HOLDING BRACKET	1	PZ	GN1400A0	U-TRAP SEAL	1	PZ	GN1508A0	O-RING GASKET COD 2400	1	PZ	IL1115A0	WOODEN PALET 80X120	0.100	PZ								
Code	Description	Qty	UOM																														
0H6567A0	P-TRAP HOLDING BRACKET	1	PZ																														
GN1400A0	U-TRAP SEAL	1	PZ																														
GN1508A0	O-RING GASKET COD 2400	1	PZ																														
IL1115A0	WOODEN PALET 80X120	0.100	PZ																														

COMPONENT			SPARE PART																																																																																	
Code	Description	Image	Code	Description	Components list																																																																															
VL1005A	U-TRAP TANK		XUC001	SINGLE UNIT INSTALLATION KIT	<table border="1"> <thead> <tr> <th>Code</th> <th>Description</th> <th>Qty</th> <th>UOM</th> </tr> </thead> <tbody> <tr> <td>RC1055A0</td> <td>Ø25-40 H12 STAINLESS STEEL PIPE CLIP</td> <td>3</td> <td>PZ</td> </tr> <tr> <td>TB1520A0</td> <td>INT. Ø=38 TH=4 DRAIN BLACK RUBBER PIPE</td> <td>2.500</td> <td>M</td> </tr> <tr> <td>VI1075A0</td> <td>NUT M4 H=4 UNI5587 INOX</td> <td>4</td> <td>PZ</td> </tr> <tr> <td>VI1220A1</td> <td>4,2X12 TCB SELF-TAPPIN G SCREW</td> <td>2</td> <td>PZ</td> </tr> <tr> <td>VI1895A0</td> <td>BLIND NUT M4 STAINLESS STEEL DIN 917</td> <td>4</td> <td>PZ</td> </tr> <tr> <td>VI1945A0</td> <td>ENG-VITE M4X20 TCB+ INOX</td> <td>4</td> <td>PZ</td> </tr> <tr> <td>VI1950A0</td> <td>ST. STEEL 4,2X13 TCB SELF-DRILLIN G SCREW</td> <td>2</td> <td>PZ</td> </tr> <tr> <td>VL1005A1</td> <td>U-TRAP TANK</td> <td>1</td> <td>PZ</td> </tr> <tr> <td>VL1006A0</td> <td>SYPHON COVER</td> <td>1</td> <td>PZ</td> </tr> <tr> <td>VL1026A0</td> <td>BEND FOR DRAIN PIPE</td> <td>1</td> <td>PZ</td> </tr> <tr> <td>VM1015A1</td> <td>STAINLESS STEEL Ø30X1.5 90° BEND</td> <td>1</td> <td>PZ</td> </tr> </tbody> </table>	Code	Description	Qty	UOM	RC1055A0	Ø25-40 H12 STAINLESS STEEL PIPE CLIP	3	PZ	TB1520A0	INT. Ø=38 TH=4 DRAIN BLACK RUBBER PIPE	2.500	M	VI1075A0	NUT M4 H=4 UNI5587 INOX	4	PZ	VI1220A1	4,2X12 TCB SELF-TAPPIN G SCREW	2	PZ	VI1895A0	BLIND NUT M4 STAINLESS STEEL DIN 917	4	PZ	VI1945A0	ENG-VITE M4X20 TCB+ INOX	4	PZ	VI1950A0	ST. STEEL 4,2X13 TCB SELF-DRILLIN G SCREW	2	PZ	VL1005A1	U-TRAP TANK	1	PZ	VL1006A0	SYPHON COVER	1	PZ	VL1026A0	BEND FOR DRAIN PIPE	1	PZ	VM1015A1	STAINLESS STEEL Ø30X1.5 90° BEND	1	PZ	XC761	3 OVENS LM TOP XFT200 STACKING KIT	<table border="1"> <thead> <tr> <th>Code</th> <th>Description</th> <th>Qty</th> <th>UOM</th> </tr> </thead> <tbody> <tr> <td>0H1237A0</td> <td>LM TOP SIPHON SUPPORT</td> <td>3</td> <td>PZ</td> </tr> <tr> <td>0H7082A0</td> <td>LM 800 XC STACKING KIT FRONT PROFILE</td> <td>2</td> <td>PZ</td> </tr> <tr> <td>0H7083A0</td> <td>LM 800 XC STACKING KIT BACK PROFIL</td> <td>4</td> <td>PZ</td> </tr> <tr> <td>ED1246A0</td> <td>HOT SURFACE LABEL</td> <td>1</td> <td>PZ</td> </tr> <tr> <td>ED1271A0</td> <td>LIQUID FALLS DANGER LABE</td> <td>1</td> <td>PZ</td> </tr> <tr> <td>EL1020A1</td> <td>D8 INTERMEDIAT E T-SHAPED FITTING</td> <td>4</td> <td>PZ</td> </tr> </tbody> </table>	Code	Description	Qty	UOM	0H1237A0	LM TOP SIPHON SUPPORT	3	PZ	0H7082A0	LM 800 XC STACKING KIT FRONT PROFILE	2	PZ	0H7083A0	LM 800 XC STACKING KIT BACK PROFIL	4	PZ	ED1246A0	HOT SURFACE LABEL	1	PZ	ED1271A0	LIQUID FALLS DANGER LABE	1	PZ	EL1020A1	D8 INTERMEDIAT E T-SHAPED FITTING	4	PZ
			Code	Description	Qty	UOM																																																																														
RC1055A0	Ø25-40 H12 STAINLESS STEEL PIPE CLIP	3	PZ																																																																																	
TB1520A0	INT. Ø=38 TH=4 DRAIN BLACK RUBBER PIPE	2.500	M																																																																																	
VI1075A0	NUT M4 H=4 UNI5587 INOX	4	PZ																																																																																	
VI1220A1	4,2X12 TCB SELF-TAPPIN G SCREW	2	PZ																																																																																	
VI1895A0	BLIND NUT M4 STAINLESS STEEL DIN 917	4	PZ																																																																																	
VI1945A0	ENG-VITE M4X20 TCB+ INOX	4	PZ																																																																																	
VI1950A0	ST. STEEL 4,2X13 TCB SELF-DRILLIN G SCREW	2	PZ																																																																																	
VL1005A1	U-TRAP TANK	1	PZ																																																																																	
VL1006A0	SYPHON COVER	1	PZ																																																																																	
VL1026A0	BEND FOR DRAIN PIPE	1	PZ																																																																																	
VM1015A1	STAINLESS STEEL Ø30X1.5 90° BEND	1	PZ																																																																																	
Code	Description	Qty	UOM																																																																																	
0H1237A0	LM TOP SIPHON SUPPORT	3	PZ																																																																																	
0H7082A0	LM 800 XC STACKING KIT FRONT PROFILE	2	PZ																																																																																	
0H7083A0	LM 800 XC STACKING KIT BACK PROFIL	4	PZ																																																																																	
ED1246A0	HOT SURFACE LABEL	1	PZ																																																																																	
ED1271A0	LIQUID FALLS DANGER LABE	1	PZ																																																																																	
EL1020A1	D8 INTERMEDIAT E T-SHAPED FITTING	4	PZ																																																																																	





COMPONENT			SPARE PART																																																																																		
Code	Description	Image	Code	Description	Components list																																																																																
VL1005A	U-TRAP TANK		XC761	3 OVENS LM TOP XFT200 STACKING KIT	<table border="1"> <thead> <tr> <th>Code</th> <th>Description</th> <th>Qty</th> <th>UOM</th> </tr> </thead> <tbody> <tr> <td>EL1180A0</td> <td>Ø8-Ø8 FEMALE NON-RETURN CONNECTION</td> <td>3</td> <td>PZ</td> </tr> <tr> <td>GN1508A0</td> <td>O-RING GASKET COD 2400</td> <td>3</td> <td>PZ</td> </tr> <tr> <td>RC1008A0</td> <td>D9 ELASTIC CLIP</td> <td>12</td> <td>PZ</td> </tr> <tr> <td>RC1055A0</td> <td>Ø25-40 H12 STAINLESS STEEL PIPE CLIP</td> <td>15</td> <td>PZ</td> </tr> <tr> <td>RC1297A1</td> <td>D10 T-SHAPED FITTING</td> <td>2</td> <td>PZ</td> </tr> <tr> <td>RC1360A0</td> <td>10 - 10 JG ELBOW FITTIN</td> <td>1</td> <td>PZ</td> </tr> <tr> <td>RC1376A0</td> <td>Ø6 Y-FITTING</td> <td>2</td> <td>PZ</td> </tr> <tr> <td>TB1177A0</td> <td>FOOT PANEL 40X40 H58 OVERLAP LM</td> <td>8</td> <td>PZ</td> </tr> <tr> <td>TB1520A0</td> <td>INT. Ø=38 TH=4 DRAIN BLACK RUBBER PIPE</td> <td>5</td> <td>M</td> </tr> <tr> <td>TB1815A0</td> <td>7,93X4,75 PE TRANSP. PIPE (JG #PE08100N)</td> <td>12</td> <td>M</td> </tr> <tr> <td>TB1816A0</td> <td>CLEAR POLYPROPYL ENE PIPE 6X4MM</td> <td>3</td> <td>M</td> </tr> <tr> <td>TB2243A0</td> <td>D10 PE TRANSPAREN T PIPE</td> <td>4</td> <td>M</td> </tr> <tr> <td>VI1075A0</td> <td>NUT M4 H=4 UNI5587 INOX</td> <td>12</td> <td>PZ</td> </tr> <tr> <td>VI1220A1</td> <td>4,2X12 TCB SELF-TAPPIN G SCREW</td> <td>30</td> <td>PZ</td> </tr> <tr> <td>VI1895A0</td> <td>BLIND NUT M4 STAINLESS STEEL DIN 917</td> <td>12</td> <td>PZ</td> </tr> <tr> <td>VI1945A0</td> <td>ENG-VITE M4X20 TCB+ INOX</td> <td>12</td> <td>PZ</td> </tr> <tr> <td>VI1950A0</td> <td>ST. STEEL 4,2X13 TCB SELF-DRILLIN G SCREW</td> <td>20</td> <td>PZ</td> </tr> <tr> <td>VL1005A1</td> <td>U-TRAP TANK</td> <td>3</td> <td>PZ</td> </tr> <tr> <td>VL1006A0</td> <td>SYPHON COVER</td> <td>3</td> <td>PZ</td> </tr> </tbody> </table>	Code	Description	Qty	UOM	EL1180A0	Ø8-Ø8 FEMALE NON-RETURN CONNECTION	3	PZ	GN1508A0	O-RING GASKET COD 2400	3	PZ	RC1008A0	D9 ELASTIC CLIP	12	PZ	RC1055A0	Ø25-40 H12 STAINLESS STEEL PIPE CLIP	15	PZ	RC1297A1	D10 T-SHAPED FITTING	2	PZ	RC1360A0	10 - 10 JG ELBOW FITTIN	1	PZ	RC1376A0	Ø6 Y-FITTING	2	PZ	TB1177A0	FOOT PANEL 40X40 H58 OVERLAP LM	8	PZ	TB1520A0	INT. Ø=38 TH=4 DRAIN BLACK RUBBER PIPE	5	M	TB1815A0	7,93X4,75 PE TRANSP. PIPE (JG #PE08100N)	12	M	TB1816A0	CLEAR POLYPROPYL ENE PIPE 6X4MM	3	M	TB2243A0	D10 PE TRANSPAREN T PIPE	4	M	VI1075A0	NUT M4 H=4 UNI5587 INOX	12	PZ	VI1220A1	4,2X12 TCB SELF-TAPPIN G SCREW	30	PZ	VI1895A0	BLIND NUT M4 STAINLESS STEEL DIN 917	12	PZ	VI1945A0	ENG-VITE M4X20 TCB+ INOX	12	PZ	VI1950A0	ST. STEEL 4,2X13 TCB SELF-DRILLIN G SCREW	20	PZ	VL1005A1	U-TRAP TANK	3	PZ	VL1006A0	SYPHON COVER	3	PZ
Code	Description	Qty	UOM																																																																																		
EL1180A0	Ø8-Ø8 FEMALE NON-RETURN CONNECTION	3	PZ																																																																																		
GN1508A0	O-RING GASKET COD 2400	3	PZ																																																																																		
RC1008A0	D9 ELASTIC CLIP	12	PZ																																																																																		
RC1055A0	Ø25-40 H12 STAINLESS STEEL PIPE CLIP	15	PZ																																																																																		
RC1297A1	D10 T-SHAPED FITTING	2	PZ																																																																																		
RC1360A0	10 - 10 JG ELBOW FITTIN	1	PZ																																																																																		
RC1376A0	Ø6 Y-FITTING	2	PZ																																																																																		
TB1177A0	FOOT PANEL 40X40 H58 OVERLAP LM	8	PZ																																																																																		
TB1520A0	INT. Ø=38 TH=4 DRAIN BLACK RUBBER PIPE	5	M																																																																																		
TB1815A0	7,93X4,75 PE TRANSP. PIPE (JG #PE08100N)	12	M																																																																																		
TB1816A0	CLEAR POLYPROPYL ENE PIPE 6X4MM	3	M																																																																																		
TB2243A0	D10 PE TRANSPAREN T PIPE	4	M																																																																																		
VI1075A0	NUT M4 H=4 UNI5587 INOX	12	PZ																																																																																		
VI1220A1	4,2X12 TCB SELF-TAPPIN G SCREW	30	PZ																																																																																		
VI1895A0	BLIND NUT M4 STAINLESS STEEL DIN 917	12	PZ																																																																																		
VI1945A0	ENG-VITE M4X20 TCB+ INOX	12	PZ																																																																																		
VI1950A0	ST. STEEL 4,2X13 TCB SELF-DRILLIN G SCREW	20	PZ																																																																																		
VL1005A1	U-TRAP TANK	3	PZ																																																																																		
VL1006A0	SYPHON COVER	3	PZ																																																																																		

COMPONENT			SPARE PART																																																																			
Code	Description	Image	Code	Description	Components list																																																																	
VL1005A	U-TRAP TANK		XC761	3 OVENS LM TOP XFT200 STACKING KIT	<table border="1"> <thead> <tr> <th>Code</th> <th>Description</th> <th>Qty</th> <th>UOM</th> </tr> </thead> <tbody> <tr> <td>VL1046A1</td> <td>D6 PIPE HOLDER - D6 J.G. TERMINAL</td> <td>12</td> <td>PZ</td> </tr> <tr> <td>VM1015A1</td> <td>STAINLESS STEEL Ø30X1.5 90° BEND</td> <td>1</td> <td>PZ</td> </tr> <tr> <td>VM1794A0</td> <td>250X4.8 PA66 BLACK CLAMP</td> <td>3</td> <td>PZ</td> </tr> <tr> <td>VM2035A0</td> <td>DRAIN PIPE SUPPORT</td> <td>3</td> <td>PZ</td> </tr> </tbody> </table>	Code	Description	Qty	UOM	VL1046A1	D6 PIPE HOLDER - D6 J.G. TERMINAL	12	PZ	VM1015A1	STAINLESS STEEL Ø30X1.5 90° BEND	1	PZ	VM1794A0	250X4.8 PA66 BLACK CLAMP	3	PZ	VM2035A0	DRAIN PIPE SUPPORT	3	PZ																																													
			Code	Description	Qty	UOM																																																																
VL1046A1	D6 PIPE HOLDER - D6 J.G. TERMINAL	12	PZ																																																																			
VM1015A1	STAINLESS STEEL Ø30X1.5 90° BEND	1	PZ																																																																			
VM1794A0	250X4.8 PA66 BLACK CLAMP	3	PZ																																																																			
VM2035A0	DRAIN PIPE SUPPORT	3	PZ																																																																			
XC757	S. E CHEFTOP GN1/1 STACKING KI	<table border="1"> <thead> <tr> <th>Code</th> <th>Description</th> <th>Qty</th> <th>UOM</th> </tr> </thead> <tbody> <tr> <td>0H6463A0</td> <td>XC757 FRONT PROFILE</td> <td>1</td> <td>PZ</td> </tr> <tr> <td>CE1305A0</td> <td>L=2MT RJ45 - RJ45 CABLE</td> <td>1</td> <td>PZ</td> </tr> <tr> <td>ED1246A0</td> <td>HOT SURFACE LABEL</td> <td>2</td> <td>PZ</td> </tr> <tr> <td>ED1271A0</td> <td>LIQUID FALLS DANGER LABE</td> <td>1</td> <td>PZ</td> </tr> <tr> <td>EL1020A1</td> <td>D8 INTERMEDIAT E T-SHAPED FITTING</td> <td>2</td> <td>PZ</td> </tr> <tr> <td>GN1508A0</td> <td>O-RING GASKET COD 2400</td> <td>2</td> <td>PZ</td> </tr> <tr> <td>PD1069A0</td> <td>FOOT OVERLAP S5 CT-BT-E</td> <td>1</td> <td>PZ</td> </tr> <tr> <td>RC1008A0</td> <td>D9 ELASTIC CLIP</td> <td>3</td> <td>PZ</td> </tr> <tr> <td>RC1055A0</td> <td>Ø25-40 H12 STAINLESS STEEL PIPE CLIP</td> <td>14</td> <td>PZ</td> </tr> <tr> <td>RC1130A0</td> <td>130X2,6 CLAM</td> <td>3</td> <td>PZ</td> </tr> <tr> <td>RC1297A1</td> <td>D10 T-SHAPED FITTING</td> <td>1</td> <td>PZ</td> </tr> <tr> <td>RC1376A0</td> <td>Ø6 Y-FITTING</td> <td>1</td> <td>PZ</td> </tr> <tr> <td>TB1520A0</td> <td>INT. Ø=38 TH=4 DRAIN BLACK RUBBER PIPE</td> <td>5</td> <td>M</td> </tr> <tr> <td>TB1765A1</td> <td>STACKING KIT CHIMNEY CONNECTING PIPE</td> <td>2</td> <td>PZ</td> </tr> <tr> <td>TB2243A0</td> <td>D10 PE TRANSPAREN T PIPE</td> <td>1.500</td> <td>M</td> </tr> <tr> <td>VI1075A0</td> <td>NUT M4 H=4 UNI5587 INOX</td> <td>8</td> <td>PZ</td> </tr> </tbody> </table>	Code	Description	Qty	UOM	0H6463A0	XC757 FRONT PROFILE	1	PZ	CE1305A0	L=2MT RJ45 - RJ45 CABLE	1	PZ	ED1246A0	HOT SURFACE LABEL	2	PZ	ED1271A0	LIQUID FALLS DANGER LABE	1	PZ	EL1020A1	D8 INTERMEDIAT E T-SHAPED FITTING	2	PZ	GN1508A0	O-RING GASKET COD 2400	2	PZ	PD1069A0	FOOT OVERLAP S5 CT-BT-E	1	PZ	RC1008A0	D9 ELASTIC CLIP	3	PZ	RC1055A0	Ø25-40 H12 STAINLESS STEEL PIPE CLIP	14	PZ	RC1130A0	130X2,6 CLAM	3	PZ	RC1297A1	D10 T-SHAPED FITTING	1	PZ	RC1376A0	Ø6 Y-FITTING	1	PZ	TB1520A0	INT. Ø=38 TH=4 DRAIN BLACK RUBBER PIPE	5	M	TB1765A1	STACKING KIT CHIMNEY CONNECTING PIPE	2	PZ	TB2243A0	D10 PE TRANSPAREN T PIPE	1.500	M	VI1075A0	NUT M4 H=4 UNI5587 INOX	8	PZ
Code	Description	Qty	UOM																																																																			
0H6463A0	XC757 FRONT PROFILE	1	PZ																																																																			
CE1305A0	L=2MT RJ45 - RJ45 CABLE	1	PZ																																																																			
ED1246A0	HOT SURFACE LABEL	2	PZ																																																																			
ED1271A0	LIQUID FALLS DANGER LABE	1	PZ																																																																			
EL1020A1	D8 INTERMEDIAT E T-SHAPED FITTING	2	PZ																																																																			
GN1508A0	O-RING GASKET COD 2400	2	PZ																																																																			
PD1069A0	FOOT OVERLAP S5 CT-BT-E	1	PZ																																																																			
RC1008A0	D9 ELASTIC CLIP	3	PZ																																																																			
RC1055A0	Ø25-40 H12 STAINLESS STEEL PIPE CLIP	14	PZ																																																																			
RC1130A0	130X2,6 CLAM	3	PZ																																																																			
RC1297A1	D10 T-SHAPED FITTING	1	PZ																																																																			
RC1376A0	Ø6 Y-FITTING	1	PZ																																																																			
TB1520A0	INT. Ø=38 TH=4 DRAIN BLACK RUBBER PIPE	5	M																																																																			
TB1765A1	STACKING KIT CHIMNEY CONNECTING PIPE	2	PZ																																																																			
TB2243A0	D10 PE TRANSPAREN T PIPE	1.500	M																																																																			
VI1075A0	NUT M4 H=4 UNI5587 INOX	8	PZ																																																																			

COMPONENT			SPARE PART																																																																																													
Code	Description	Image	Code	Description	Components list																																																																																											
VL1005A	U-TRAP TANK		XC757	S. E CHEFTOP GN1/1 STACKING KI	<table border="1"> <thead> <tr> <th>Code</th> <th>Description</th> <th>Qty</th> <th>UOM</th> </tr> </thead> <tbody> <tr> <td>VI1220A1</td> <td>4,2X12 TCB SELF-TAPPIN G SCREW</td> <td>4</td> <td>PZ</td> </tr> <tr> <td>VI1895A0</td> <td>BLIND NUT M4 STAINLESS STEEL DIN 917</td> <td>8</td> <td>PZ</td> </tr> <tr> <td>VI1945A0</td> <td>ENG-VITE M4X20 TCB+ INOX</td> <td>8</td> <td>PZ</td> </tr> <tr> <td>VI1950A0</td> <td>ST. STEEL 4,2X13 TCB SELF-DRILLIN G SCREW</td> <td>26</td> <td>PZ</td> </tr> <tr> <td>VL1005A1</td> <td>U-TRAP TANK</td> <td>2</td> <td>PZ</td> </tr> <tr> <td>VL1006A0</td> <td>SYPHON COVER</td> <td>2</td> <td>PZ</td> </tr> <tr> <td>VL1043A0</td> <td>D4 PIPE HOLDER - D6 J.G. TERMINAL</td> <td>3</td> <td>PZ</td> </tr> <tr> <td>VL1046A1</td> <td>D6 PIPE HOLDER - D6 J.G. TERMINAL</td> <td>3</td> <td>PZ</td> </tr> <tr> <td>VM1015A1</td> <td>STAINLESS STEEL Ø30X1.5 90° BEND</td> <td>1</td> <td>PZ</td> </tr> <tr> <td>VM1794A0</td> <td>250X4.8 PA66 BLACK CLAMP</td> <td>3</td> <td>PZ</td> </tr> <tr> <td>VM1987A0</td> <td>OVEN STACKING BRACKET</td> <td>1</td> <td>PZ</td> </tr> <tr> <td>VM2035A0</td> <td>DRAIN PIPE SUPPORT</td> <td>2</td> <td>PZ</td> </tr> </tbody> </table>	Code	Description	Qty	UOM	VI1220A1	4,2X12 TCB SELF-TAPPIN G SCREW	4	PZ	VI1895A0	BLIND NUT M4 STAINLESS STEEL DIN 917	8	PZ	VI1945A0	ENG-VITE M4X20 TCB+ INOX	8	PZ	VI1950A0	ST. STEEL 4,2X13 TCB SELF-DRILLIN G SCREW	26	PZ	VL1005A1	U-TRAP TANK	2	PZ	VL1006A0	SYPHON COVER	2	PZ	VL1043A0	D4 PIPE HOLDER - D6 J.G. TERMINAL	3	PZ	VL1046A1	D6 PIPE HOLDER - D6 J.G. TERMINAL	3	PZ	VM1015A1	STAINLESS STEEL Ø30X1.5 90° BEND	1	PZ	VM1794A0	250X4.8 PA66 BLACK CLAMP	3	PZ	VM1987A0	OVEN STACKING BRACKET	1	PZ	VM2035A0	DRAIN PIPE SUPPORT	2	PZ	XC756	E SERIES GN 2/3 STACKING KIT	<table border="1"> <thead> <tr> <th>Code</th> <th>Description</th> <th>Qty</th> <th>UOM</th> </tr> </thead> <tbody> <tr> <td>0H6462A0</td> <td>XC756 FRONT PROFILE</td> <td>1</td> <td>PZ</td> </tr> <tr> <td>CE1305A0</td> <td>L=2MT RJ45 - RJ45 CABLE</td> <td>1</td> <td>PZ</td> </tr> <tr> <td>ED1246A0</td> <td>HOT SURFACE LABEL</td> <td>1</td> <td>PZ</td> </tr> <tr> <td>ED1271A0</td> <td>LIQUID FALLS DANGER LABE</td> <td>1</td> <td>PZ</td> </tr> <tr> <td>EL1020A1</td> <td>D8 INTERMEDIAT E T-SHAPED FITTING</td> <td>2</td> <td>PZ</td> </tr> <tr> <td>GN1508A0</td> <td>O-RING GASKET COD 2400</td> <td>2</td> <td>PZ</td> </tr> <tr> <td>PD1069A0</td> <td>FOOT OVERLAP S5 CT-BT-E</td> <td>1</td> <td>PZ</td> </tr> <tr> <td>RC1008A0</td> <td>D9 ELASTIC CLIP</td> <td>3</td> <td>PZ</td> </tr> </tbody> </table>	Code	Description	Qty	UOM	0H6462A0	XC756 FRONT PROFILE	1	PZ	CE1305A0	L=2MT RJ45 - RJ45 CABLE	1	PZ	ED1246A0	HOT SURFACE LABEL	1	PZ	ED1271A0	LIQUID FALLS DANGER LABE	1	PZ	EL1020A1	D8 INTERMEDIAT E T-SHAPED FITTING	2	PZ	GN1508A0	O-RING GASKET COD 2400	2	PZ	PD1069A0	FOOT OVERLAP S5 CT-BT-E	1	PZ	RC1008A0	D9 ELASTIC CLIP	3	PZ
			Code	Description	Qty	UOM																																																																																										
VI1220A1	4,2X12 TCB SELF-TAPPIN G SCREW	4	PZ																																																																																													
VI1895A0	BLIND NUT M4 STAINLESS STEEL DIN 917	8	PZ																																																																																													
VI1945A0	ENG-VITE M4X20 TCB+ INOX	8	PZ																																																																																													
VI1950A0	ST. STEEL 4,2X13 TCB SELF-DRILLIN G SCREW	26	PZ																																																																																													
VL1005A1	U-TRAP TANK	2	PZ																																																																																													
VL1006A0	SYPHON COVER	2	PZ																																																																																													
VL1043A0	D4 PIPE HOLDER - D6 J.G. TERMINAL	3	PZ																																																																																													
VL1046A1	D6 PIPE HOLDER - D6 J.G. TERMINAL	3	PZ																																																																																													
VM1015A1	STAINLESS STEEL Ø30X1.5 90° BEND	1	PZ																																																																																													
VM1794A0	250X4.8 PA66 BLACK CLAMP	3	PZ																																																																																													
VM1987A0	OVEN STACKING BRACKET	1	PZ																																																																																													
VM2035A0	DRAIN PIPE SUPPORT	2	PZ																																																																																													
Code	Description	Qty	UOM																																																																																													
0H6462A0	XC756 FRONT PROFILE	1	PZ																																																																																													
CE1305A0	L=2MT RJ45 - RJ45 CABLE	1	PZ																																																																																													
ED1246A0	HOT SURFACE LABEL	1	PZ																																																																																													
ED1271A0	LIQUID FALLS DANGER LABE	1	PZ																																																																																													
EL1020A1	D8 INTERMEDIAT E T-SHAPED FITTING	2	PZ																																																																																													
GN1508A0	O-RING GASKET COD 2400	2	PZ																																																																																													
PD1069A0	FOOT OVERLAP S5 CT-BT-E	1	PZ																																																																																													
RC1008A0	D9 ELASTIC CLIP	3	PZ																																																																																													

COMPONENT			SPARE PART																																																																																						
Code	Description	Image	Code	Description	Components list																																																																																				
VL1005A	U-TRAP TANK		XC756	E SERIES GN 2/3 STACKING KIT	<table border="1"> <thead> <tr> <th>Code</th> <th>Description</th> <th>Qty</th> <th>UOM</th> </tr> </thead> <tbody> <tr> <td>RC1055A0</td> <td>Ø25-40 H12 STAINLESS STEEL PIPE CLIP</td> <td>14</td> <td>PZ</td> </tr> <tr> <td>RC1130A0</td> <td>130X2,6 CLAM</td> <td>3</td> <td>PZ</td> </tr> <tr> <td>RC1297A1</td> <td>D10 T-SHAPED FITTING</td> <td>1</td> <td>PZ</td> </tr> <tr> <td>RC1376A0</td> <td>Ø6 Y-FITTING</td> <td>1</td> <td>PZ</td> </tr> <tr> <td>TB1520A0</td> <td>INT. Ø=38 TH=4 DRAIN BLACK RUBBER PIPE</td> <td>3</td> <td>M</td> </tr> <tr> <td>TB1765A1</td> <td>STACKING KIT CHIMNEY CONNECTING PIPE</td> <td>1</td> <td>PZ</td> </tr> <tr> <td>TB2243A0</td> <td>D10 PE TRANSPAREN T PIPE</td> <td>1.500</td> <td>M</td> </tr> <tr> <td>VI1075A0</td> <td>NUT M4 H=4 UNI5587 INOX</td> <td>8</td> <td>PZ</td> </tr> <tr> <td>VI1220A1</td> <td>4,2X12 TCB SELF-TAPPIN G SCREW</td> <td>4</td> <td>PZ</td> </tr> <tr> <td>VI1895A0</td> <td>BLIND NUT M4 STAINLESS STEEL DIN 917</td> <td>8</td> <td>PZ</td> </tr> <tr> <td>VI1945A0</td> <td>ENG-VITE M4X20 TCB+ INOX</td> <td>8</td> <td>PZ</td> </tr> <tr> <td>VI1950A0</td> <td>ST. STEEL 4,2X13 TCB SELF-DRILLIN G SCREW</td> <td>26</td> <td>PZ</td> </tr> <tr> <td>VL1005A1</td> <td>U-TRAP TANK</td> <td>2</td> <td>PZ</td> </tr> <tr> <td>VL1006A0</td> <td>SYPHON COVER</td> <td>2</td> <td>PZ</td> </tr> <tr> <td>VL1043A0</td> <td>D4 PIPE HOLDER - D6 J.G. TERMINAL</td> <td>3</td> <td>PZ</td> </tr> <tr> <td>VL1046A1</td> <td>D6 PIPE HOLDER - D6 J.G. TERMINAL</td> <td>3</td> <td>PZ</td> </tr> <tr> <td>VM1015A1</td> <td>STAINLESS STEEL Ø30X1,5 90° BEND</td> <td>1</td> <td>PZ</td> </tr> <tr> <td>VM1794A0</td> <td>250X4,8 PA66 BLACK CLAMP</td> <td>3</td> <td>PZ</td> </tr> <tr> <td>VM1987A0</td> <td>OVEN STACKING BRACKET</td> <td>1</td> <td>PZ</td> </tr> <tr> <td>VM2035A0</td> <td>DRAIN PIPE SUPPORT</td> <td>1</td> <td>PZ</td> </tr> </tbody> </table>	Code	Description	Qty	UOM	RC1055A0	Ø25-40 H12 STAINLESS STEEL PIPE CLIP	14	PZ	RC1130A0	130X2,6 CLAM	3	PZ	RC1297A1	D10 T-SHAPED FITTING	1	PZ	RC1376A0	Ø6 Y-FITTING	1	PZ	TB1520A0	INT. Ø=38 TH=4 DRAIN BLACK RUBBER PIPE	3	M	TB1765A1	STACKING KIT CHIMNEY CONNECTING PIPE	1	PZ	TB2243A0	D10 PE TRANSPAREN T PIPE	1.500	M	VI1075A0	NUT M4 H=4 UNI5587 INOX	8	PZ	VI1220A1	4,2X12 TCB SELF-TAPPIN G SCREW	4	PZ	VI1895A0	BLIND NUT M4 STAINLESS STEEL DIN 917	8	PZ	VI1945A0	ENG-VITE M4X20 TCB+ INOX	8	PZ	VI1950A0	ST. STEEL 4,2X13 TCB SELF-DRILLIN G SCREW	26	PZ	VL1005A1	U-TRAP TANK	2	PZ	VL1006A0	SYPHON COVER	2	PZ	VL1043A0	D4 PIPE HOLDER - D6 J.G. TERMINAL	3	PZ	VL1046A1	D6 PIPE HOLDER - D6 J.G. TERMINAL	3	PZ	VM1015A1	STAINLESS STEEL Ø30X1,5 90° BEND	1	PZ	VM1794A0	250X4,8 PA66 BLACK CLAMP	3	PZ	VM1987A0	OVEN STACKING BRACKET	1	PZ	VM2035A0	DRAIN PIPE SUPPORT	1	PZ
Code	Description	Qty	UOM																																																																																						
RC1055A0	Ø25-40 H12 STAINLESS STEEL PIPE CLIP	14	PZ																																																																																						
RC1130A0	130X2,6 CLAM	3	PZ																																																																																						
RC1297A1	D10 T-SHAPED FITTING	1	PZ																																																																																						
RC1376A0	Ø6 Y-FITTING	1	PZ																																																																																						
TB1520A0	INT. Ø=38 TH=4 DRAIN BLACK RUBBER PIPE	3	M																																																																																						
TB1765A1	STACKING KIT CHIMNEY CONNECTING PIPE	1	PZ																																																																																						
TB2243A0	D10 PE TRANSPAREN T PIPE	1.500	M																																																																																						
VI1075A0	NUT M4 H=4 UNI5587 INOX	8	PZ																																																																																						
VI1220A1	4,2X12 TCB SELF-TAPPIN G SCREW	4	PZ																																																																																						
VI1895A0	BLIND NUT M4 STAINLESS STEEL DIN 917	8	PZ																																																																																						
VI1945A0	ENG-VITE M4X20 TCB+ INOX	8	PZ																																																																																						
VI1950A0	ST. STEEL 4,2X13 TCB SELF-DRILLIN G SCREW	26	PZ																																																																																						
VL1005A1	U-TRAP TANK	2	PZ																																																																																						
VL1006A0	SYPHON COVER	2	PZ																																																																																						
VL1043A0	D4 PIPE HOLDER - D6 J.G. TERMINAL	3	PZ																																																																																						
VL1046A1	D6 PIPE HOLDER - D6 J.G. TERMINAL	3	PZ																																																																																						
VM1015A1	STAINLESS STEEL Ø30X1,5 90° BEND	1	PZ																																																																																						
VM1794A0	250X4,8 PA66 BLACK CLAMP	3	PZ																																																																																						
VM1987A0	OVEN STACKING BRACKET	1	PZ																																																																																						
VM2035A0	DRAIN PIPE SUPPORT	1	PZ																																																																																						

COMPONENT			SPARE PART																																																																																										
Code	Description	Image	Code	Description	Components list																																																																																								
VL1005A	U-TRAP TANK		XC755	E SERIES BT-CT GN 2/1 STACKING KIT	<table border="1"> <thead> <tr> <th>Code</th> <th>Description</th> <th>Qty</th> <th>UOM</th> </tr> </thead> <tbody> <tr> <td>0H6461A0</td> <td>XC755 FRONT PROFILE</td> <td>1</td> <td>PZ</td> </tr> <tr> <td>CE1635A0</td> <td>RJ45 - RJ45 CABLE L=3M</td> <td>1</td> <td>PZ</td> </tr> <tr> <td>ED1246A0</td> <td>HOT SURFACE LABEL</td> <td>2</td> <td>PZ</td> </tr> <tr> <td>ED1271A0</td> <td>LIQUID FALLS DANGER LABE</td> <td>1</td> <td>PZ</td> </tr> <tr> <td>EL1020A1</td> <td>D8 INTERMEDIAT E T-SHAPED FITTING</td> <td>2</td> <td>PZ</td> </tr> <tr> <td>GN1508A0</td> <td>O-RING GASKET COD 2400</td> <td>2</td> <td>PZ</td> </tr> <tr> <td>PD1069A0</td> <td>FOOT OVERLAP S5 CT-BT-E</td> <td>1</td> <td>PZ</td> </tr> <tr> <td>RC1008A0</td> <td>D9 ELASTIC CLIP</td> <td>3</td> <td>PZ</td> </tr> <tr> <td>RC1055A0</td> <td>Ø25-40 H12 STAINLESS STEEL PIPE CLIP</td> <td>14</td> <td>PZ</td> </tr> <tr> <td>RC1130A0</td> <td>130X2,6 CLAM</td> <td>3</td> <td>PZ</td> </tr> <tr> <td>RC1297A1</td> <td>D10 T-SHAPED FITTING</td> <td>1</td> <td>PZ</td> </tr> <tr> <td>RC1376A0</td> <td>Ø6 Y-FITTING</td> <td>1</td> <td>PZ</td> </tr> <tr> <td>TB1520A0</td> <td>INT. Ø=38 TH=4 DRAIN BLACK RUBBER PIPE</td> <td>5</td> <td>M</td> </tr> <tr> <td>TB1765A1</td> <td>STACKING KIT CHIMNEY CONNECTING PIPE</td> <td>2</td> <td>PZ</td> </tr> <tr> <td>TB2243A0</td> <td>D10 PE TRANSPAREN T PIPE</td> <td>1.500</td> <td>M</td> </tr> <tr> <td>VI1075A0</td> <td>NUT M4 H=4 UNI5587 INOX</td> <td>8</td> <td>PZ</td> </tr> <tr> <td>VI1220A1</td> <td>4,2X12 TCB SELF-TAPPIN G SCREW</td> <td>4</td> <td>PZ</td> </tr> <tr> <td>VI1895A0</td> <td>BLIND NUT M4 STAINLESS STEEL DIN 917</td> <td>8</td> <td>PZ</td> </tr> <tr> <td>VI1945A0</td> <td>ENG-VITE M4X20 TCB+ INOX</td> <td>8</td> <td>PZ</td> </tr> <tr> <td>VI1950A0</td> <td>ST. STEEL 4,2X13 TCB SELF-DRILLIN G SCREW</td> <td>26</td> <td>PZ</td> </tr> <tr> <td>VL1005A1</td> <td>U-TRAP TANK</td> <td>2</td> <td>PZ</td> </tr> </tbody> </table>	Code	Description	Qty	UOM	0H6461A0	XC755 FRONT PROFILE	1	PZ	CE1635A0	RJ45 - RJ45 CABLE L=3M	1	PZ	ED1246A0	HOT SURFACE LABEL	2	PZ	ED1271A0	LIQUID FALLS DANGER LABE	1	PZ	EL1020A1	D8 INTERMEDIAT E T-SHAPED FITTING	2	PZ	GN1508A0	O-RING GASKET COD 2400	2	PZ	PD1069A0	FOOT OVERLAP S5 CT-BT-E	1	PZ	RC1008A0	D9 ELASTIC CLIP	3	PZ	RC1055A0	Ø25-40 H12 STAINLESS STEEL PIPE CLIP	14	PZ	RC1130A0	130X2,6 CLAM	3	PZ	RC1297A1	D10 T-SHAPED FITTING	1	PZ	RC1376A0	Ø6 Y-FITTING	1	PZ	TB1520A0	INT. Ø=38 TH=4 DRAIN BLACK RUBBER PIPE	5	M	TB1765A1	STACKING KIT CHIMNEY CONNECTING PIPE	2	PZ	TB2243A0	D10 PE TRANSPAREN T PIPE	1.500	M	VI1075A0	NUT M4 H=4 UNI5587 INOX	8	PZ	VI1220A1	4,2X12 TCB SELF-TAPPIN G SCREW	4	PZ	VI1895A0	BLIND NUT M4 STAINLESS STEEL DIN 917	8	PZ	VI1945A0	ENG-VITE M4X20 TCB+ INOX	8	PZ	VI1950A0	ST. STEEL 4,2X13 TCB SELF-DRILLIN G SCREW	26	PZ	VL1005A1	U-TRAP TANK	2	PZ
					Code	Description	Qty	UOM																																																																																					
0H6461A0	XC755 FRONT PROFILE	1	PZ																																																																																										
CE1635A0	RJ45 - RJ45 CABLE L=3M	1	PZ																																																																																										
ED1246A0	HOT SURFACE LABEL	2	PZ																																																																																										
ED1271A0	LIQUID FALLS DANGER LABE	1	PZ																																																																																										
EL1020A1	D8 INTERMEDIAT E T-SHAPED FITTING	2	PZ																																																																																										
GN1508A0	O-RING GASKET COD 2400	2	PZ																																																																																										
PD1069A0	FOOT OVERLAP S5 CT-BT-E	1	PZ																																																																																										
RC1008A0	D9 ELASTIC CLIP	3	PZ																																																																																										
RC1055A0	Ø25-40 H12 STAINLESS STEEL PIPE CLIP	14	PZ																																																																																										
RC1130A0	130X2,6 CLAM	3	PZ																																																																																										
RC1297A1	D10 T-SHAPED FITTING	1	PZ																																																																																										
RC1376A0	Ø6 Y-FITTING	1	PZ																																																																																										
TB1520A0	INT. Ø=38 TH=4 DRAIN BLACK RUBBER PIPE	5	M																																																																																										
TB1765A1	STACKING KIT CHIMNEY CONNECTING PIPE	2	PZ																																																																																										
TB2243A0	D10 PE TRANSPAREN T PIPE	1.500	M																																																																																										
VI1075A0	NUT M4 H=4 UNI5587 INOX	8	PZ																																																																																										
VI1220A1	4,2X12 TCB SELF-TAPPIN G SCREW	4	PZ																																																																																										
VI1895A0	BLIND NUT M4 STAINLESS STEEL DIN 917	8	PZ																																																																																										
VI1945A0	ENG-VITE M4X20 TCB+ INOX	8	PZ																																																																																										
VI1950A0	ST. STEEL 4,2X13 TCB SELF-DRILLIN G SCREW	26	PZ																																																																																										
VL1005A1	U-TRAP TANK	2	PZ																																																																																										

COMPONENT			SPARE PART																																																			
Code	Description	Image	Code	Description	Components list																																																	
VL1005A	U-TRAP TANK		XC755	E SERIES BT-CT GN 2/1 STACKING KIT	<table border="1"> <thead> <tr> <th>Code</th> <th>Description</th> <th>Qty</th> <th>UOM</th> </tr> </thead> <tbody> <tr> <td>VL1006A0</td> <td>SYPHON COVER</td> <td>2</td> <td>PZ</td> </tr> <tr> <td>VL1043A0</td> <td>D4 PIPE HOLDER - D6 J.G. TERMINAL</td> <td>3</td> <td>PZ</td> </tr> <tr> <td>VL1046A1</td> <td>D6 PIPE HOLDER - D6 J.G. TERMINAL</td> <td>3</td> <td>PZ</td> </tr> <tr> <td>VM1015A1</td> <td>STAINLESS STEEL Ø30X1.5 90° BEND</td> <td>1</td> <td>PZ</td> </tr> <tr> <td>VM1794A0</td> <td>250X4.8 PA66 BLACK CLAMP</td> <td>3</td> <td>PZ</td> </tr> <tr> <td>VM1987A0</td> <td>OVEN STACKING BRACKET</td> <td>1</td> <td>PZ</td> </tr> <tr> <td>VM2035A0</td> <td>DRAIN PIPE SUPPORT</td> <td>2</td> <td>PZ</td> </tr> </tbody> </table>	Code	Description	Qty	UOM	VL1006A0	SYPHON COVER	2	PZ	VL1043A0	D4 PIPE HOLDER - D6 J.G. TERMINAL	3	PZ	VL1046A1	D6 PIPE HOLDER - D6 J.G. TERMINAL	3	PZ	VM1015A1	STAINLESS STEEL Ø30X1.5 90° BEND	1	PZ	VM1794A0	250X4.8 PA66 BLACK CLAMP	3	PZ	VM1987A0	OVEN STACKING BRACKET	1	PZ	VM2035A0	DRAIN PIPE SUPPORT	2	PZ																	
			Code	Description	Qty	UOM																																																
VL1006A0	SYPHON COVER	2	PZ																																																			
VL1043A0	D4 PIPE HOLDER - D6 J.G. TERMINAL	3	PZ																																																			
VL1046A1	D6 PIPE HOLDER - D6 J.G. TERMINAL	3	PZ																																																			
VM1015A1	STAINLESS STEEL Ø30X1.5 90° BEND	1	PZ																																																			
VM1794A0	250X4.8 PA66 BLACK CLAMP	3	PZ																																																			
VM1987A0	OVEN STACKING BRACKET	1	PZ																																																			
VM2035A0	DRAIN PIPE SUPPORT	2	PZ																																																			
XC699	LINEMISS TOP FIRST INSTALLATION KIT	<table border="1"> <thead> <tr> <th>Code</th> <th>Description</th> <th>Qty</th> <th>UOM</th> </tr> </thead> <tbody> <tr> <td>0H1237A0</td> <td>LM TOP SIPHON SUPPORT</td> <td>1</td> <td>PZ</td> </tr> <tr> <td>GN1508A0</td> <td>O-RING GASKET COD 2400</td> <td>1</td> <td>PZ</td> </tr> <tr> <td>RC1055A0</td> <td>Ø25-40 H12 STAINLESS STEEL PIPE CLIP</td> <td>4</td> <td>PZ</td> </tr> <tr> <td>TB1520A0</td> <td>INT. Ø=38 TH=4 DRAIN BLACK RUBBER PIPE</td> <td>2.500</td> <td>M</td> </tr> <tr> <td>VI1075A0</td> <td>NUT M4 H=4 UNI5587 INOX</td> <td>4</td> <td>PZ</td> </tr> <tr> <td>VI1220A1</td> <td>4,2X12 TCB SELF-TAPPIN G SCREW</td> <td>2</td> <td>PZ</td> </tr> <tr> <td>VI1895A0</td> <td>BLIND NUT M4 STAINLESS STEEL DIN 917</td> <td>4</td> <td>PZ</td> </tr> <tr> <td>VI1945A0</td> <td>ENG-VITE M4X20 TCB+ INOX</td> <td>4</td> <td>PZ</td> </tr> <tr> <td>VI1950A0</td> <td>ST. STEEL 4,2X13 TCB SELF-DRILLIN G SCREW</td> <td>2</td> <td>PZ</td> </tr> <tr> <td>VL1005A1</td> <td>U-TRAP TANK</td> <td>1</td> <td>PZ</td> </tr> <tr> <td>VL1006A0</td> <td>SYPHON COVER</td> <td>1</td> <td>PZ</td> </tr> <tr> <td>VM1015A1</td> <td>STAINLESS STEEL Ø30X1.5 90° BEND</td> <td>1</td> <td>PZ</td> </tr> </tbody> </table>	Code	Description	Qty	UOM	0H1237A0	LM TOP SIPHON SUPPORT	1	PZ	GN1508A0	O-RING GASKET COD 2400	1	PZ	RC1055A0	Ø25-40 H12 STAINLESS STEEL PIPE CLIP	4	PZ	TB1520A0	INT. Ø=38 TH=4 DRAIN BLACK RUBBER PIPE	2.500	M	VI1075A0	NUT M4 H=4 UNI5587 INOX	4	PZ	VI1220A1	4,2X12 TCB SELF-TAPPIN G SCREW	2	PZ	VI1895A0	BLIND NUT M4 STAINLESS STEEL DIN 917	4	PZ	VI1945A0	ENG-VITE M4X20 TCB+ INOX	4	PZ	VI1950A0	ST. STEEL 4,2X13 TCB SELF-DRILLIN G SCREW	2	PZ	VL1005A1	U-TRAP TANK	1	PZ	VL1006A0	SYPHON COVER	1	PZ	VM1015A1	STAINLESS STEEL Ø30X1.5 90° BEND	1	PZ
Code	Description	Qty	UOM																																																			
0H1237A0	LM TOP SIPHON SUPPORT	1	PZ																																																			
GN1508A0	O-RING GASKET COD 2400	1	PZ																																																			
RC1055A0	Ø25-40 H12 STAINLESS STEEL PIPE CLIP	4	PZ																																																			
TB1520A0	INT. Ø=38 TH=4 DRAIN BLACK RUBBER PIPE	2.500	M																																																			
VI1075A0	NUT M4 H=4 UNI5587 INOX	4	PZ																																																			
VI1220A1	4,2X12 TCB SELF-TAPPIN G SCREW	2	PZ																																																			
VI1895A0	BLIND NUT M4 STAINLESS STEEL DIN 917	4	PZ																																																			
VI1945A0	ENG-VITE M4X20 TCB+ INOX	4	PZ																																																			
VI1950A0	ST. STEEL 4,2X13 TCB SELF-DRILLIN G SCREW	2	PZ																																																			
VL1005A1	U-TRAP TANK	1	PZ																																																			
VL1006A0	SYPHON COVER	1	PZ																																																			
VM1015A1	STAINLESS STEEL Ø30X1.5 90° BEND	1	PZ																																																			

COMPONENT			SPARE PART																																														
Code	Description	Image	Code	Description	Components list																																												
VL1005A	U-TRAP TANK		XC673	COMPLETE P-TRAP KIT	<table border="1"> <thead> <tr> <th>Code</th> <th>Description</th> <th>Qty</th> <th>UOM</th> </tr> </thead> <tbody> <tr> <td>GN1508A0</td> <td>O-RING GASKET COD 2400</td> <td>1</td> <td>PZ</td> </tr> <tr> <td>RC1055A0</td> <td>Ø25-40 H12 STAINLESS STEEL PIPE CLIP</td> <td>2</td> <td>PZ</td> </tr> <tr> <td>TB1520A0</td> <td>INT. Ø=38 TH=4 DRAIN BLACK RUBBER PIPE</td> <td>0.050</td> <td>M</td> </tr> <tr> <td>VI1075A0</td> <td>NUT M4 H=4 UNI5587 INOX</td> <td>4</td> <td>PZ</td> </tr> <tr> <td>VI1220A1</td> <td>4,2X12 TCB SELF-TAPPIN G SCREW</td> <td>2</td> <td>PZ</td> </tr> <tr> <td>VI1895A0</td> <td>BLIND NUT M4 STAINLESS STEEL DIN 917</td> <td>4</td> <td>PZ</td> </tr> <tr> <td>VI1945A0</td> <td>ENG-VITE M4X20 TCB+ INOX</td> <td>4</td> <td>PZ</td> </tr> <tr> <td>VI1950A0</td> <td>ST. STEEL 4,2X13 TCB SELF-DRILLIN G SCREW</td> <td>2</td> <td>PZ</td> </tr> <tr> <td>VL1005A1</td> <td>U-TRAP TANK</td> <td>1</td> <td>PZ</td> </tr> <tr> <td>VL1006A0</td> <td>SYPHON COVER</td> <td>1</td> <td>PZ</td> </tr> </tbody> </table>	Code	Description	Qty	UOM	GN1508A0	O-RING GASKET COD 2400	1	PZ	RC1055A0	Ø25-40 H12 STAINLESS STEEL PIPE CLIP	2	PZ	TB1520A0	INT. Ø=38 TH=4 DRAIN BLACK RUBBER PIPE	0.050	M	VI1075A0	NUT M4 H=4 UNI5587 INOX	4	PZ	VI1220A1	4,2X12 TCB SELF-TAPPIN G SCREW	2	PZ	VI1895A0	BLIND NUT M4 STAINLESS STEEL DIN 917	4	PZ	VI1945A0	ENG-VITE M4X20 TCB+ INOX	4	PZ	VI1950A0	ST. STEEL 4,2X13 TCB SELF-DRILLIN G SCREW	2	PZ	VL1005A1	U-TRAP TANK	1	PZ	VL1006A0	SYPHON COVER	1	PZ
			Code	Description	Qty	UOM																																											
GN1508A0	O-RING GASKET COD 2400	1	PZ																																														
RC1055A0	Ø25-40 H12 STAINLESS STEEL PIPE CLIP	2	PZ																																														
TB1520A0	INT. Ø=38 TH=4 DRAIN BLACK RUBBER PIPE	0.050	M																																														
VI1075A0	NUT M4 H=4 UNI5587 INOX	4	PZ																																														
VI1220A1	4,2X12 TCB SELF-TAPPIN G SCREW	2	PZ																																														
VI1895A0	BLIND NUT M4 STAINLESS STEEL DIN 917	4	PZ																																														
VI1945A0	ENG-VITE M4X20 TCB+ INOX	4	PZ																																														
VI1950A0	ST. STEEL 4,2X13 TCB SELF-DRILLIN G SCREW	2	PZ																																														
VL1005A1	U-TRAP TANK	1	PZ																																														
VL1006A0	SYPHON COVER	1	PZ																																														
XC653	LINEMISSTOP XFT140 STACKING KIT	<table border="1"> <thead> <tr> <th>Code</th> <th>Description</th> <th>Qty</th> <th>UOM</th> </tr> </thead> <tbody> <tr> <td>0H1237A0</td> <td>LM TOP SIPHON SUPPORT</td> <td>2</td> <td>PZ</td> </tr> <tr> <td>0H7084A0</td> <td>XC651 FRONT STACKING PROFILE</td> <td>1</td> <td>PZ</td> </tr> <tr> <td>0H7085A0</td> <td>LM 600 XC STACKING KIT BACK PROFIL</td> <td>2</td> <td>PZ</td> </tr> <tr> <td>ED1246A0</td> <td>HOT SURFACE LABEL</td> <td>1</td> <td>PZ</td> </tr> <tr> <td>ED1271A0</td> <td>LIQUID FALLS DANGER LABE</td> <td>1</td> <td>PZ</td> </tr> <tr> <td>EL1020A1</td> <td>D8 INTERMEDIAT E T-SHAPED FITTING</td> <td>2</td> <td>PZ</td> </tr> <tr> <td>EL1180A0</td> <td>Ø8-Ø8 FEMALE NON-RETURN CONNECTION</td> <td>2</td> <td>PZ</td> </tr> <tr> <td>GN1508A0</td> <td>O-RING GASKET COD 2400</td> <td>2</td> <td>PZ</td> </tr> </tbody> </table>	Code	Description	Qty	UOM	0H1237A0	LM TOP SIPHON SUPPORT	2	PZ	0H7084A0	XC651 FRONT STACKING PROFILE	1	PZ	0H7085A0	LM 600 XC STACKING KIT BACK PROFIL	2	PZ	ED1246A0	HOT SURFACE LABEL	1	PZ	ED1271A0	LIQUID FALLS DANGER LABE	1	PZ	EL1020A1	D8 INTERMEDIAT E T-SHAPED FITTING	2	PZ	EL1180A0	Ø8-Ø8 FEMALE NON-RETURN CONNECTION	2	PZ	GN1508A0	O-RING GASKET COD 2400	2	PZ											
Code	Description	Qty	UOM																																														
0H1237A0	LM TOP SIPHON SUPPORT	2	PZ																																														
0H7084A0	XC651 FRONT STACKING PROFILE	1	PZ																																														
0H7085A0	LM 600 XC STACKING KIT BACK PROFIL	2	PZ																																														
ED1246A0	HOT SURFACE LABEL	1	PZ																																														
ED1271A0	LIQUID FALLS DANGER LABE	1	PZ																																														
EL1020A1	D8 INTERMEDIAT E T-SHAPED FITTING	2	PZ																																														
EL1180A0	Ø8-Ø8 FEMALE NON-RETURN CONNECTION	2	PZ																																														
GN1508A0	O-RING GASKET COD 2400	2	PZ																																														



COMPONENT			SPARE PART																																																																																										
Code	Description	Image	Code	Description	Components list																																																																																								
VL1005A	U-TRAP TANK		XC653	LINEMISSTOP XFT140 STACKING KIT	<table border="1"> <thead> <tr> <th>Code</th> <th>Description</th> <th>Qty</th> <th>UOM</th> </tr> </thead> <tbody> <tr> <td>RC1008A0</td> <td>D9 ELASTIC CLIP</td> <td>7</td> <td>PZ</td> </tr> <tr> <td>RC1055A0</td> <td>Ø25-40 H12 STAINLESS STEEL PIPE CLIP</td> <td>10</td> <td>PZ</td> </tr> <tr> <td>RC1297A1</td> <td>D10 T-SHAPED FITTING</td> <td>1</td> <td>PZ</td> </tr> <tr> <td>RC1360A0</td> <td>10 - 10 JG ELBOW FITTING</td> <td>1</td> <td>PZ</td> </tr> <tr> <td>RC1376A0</td> <td>Ø6 Y-FITTING</td> <td>1</td> <td>PZ</td> </tr> <tr> <td>TB1177A0</td> <td>FOOT PANEL 40X40 H58 OVERLAP LM</td> <td>4</td> <td>PZ</td> </tr> <tr> <td>TB1520A0</td> <td>INT. Ø=38 TH=4 DRAIN BLACK RUBBER PIPE</td> <td>2.700</td> <td>M</td> </tr> <tr> <td>TB1815A0</td> <td>7,93X4,75 PE TRANSP. PIPE (JG #PE08100N)</td> <td>2</td> <td>M</td> </tr> <tr> <td>TB2243A0</td> <td>D10 PE TRANSPAREN T PIPE</td> <td>1.500</td> <td>M</td> </tr> <tr> <td>VI1075A0</td> <td>NUT M4 H=4 UNI5587 INOX</td> <td>8</td> <td>PZ</td> </tr> <tr> <td>VI1220A1</td> <td>4,2X12 TCB SELF-TAPPING SCREW</td> <td>16</td> <td>PZ</td> </tr> <tr> <td>VI1895A0</td> <td>BLIND NUT M4 STAINLESS STEEL DIN 917</td> <td>8</td> <td>PZ</td> </tr> <tr> <td>VI1945A0</td> <td>ENG-VITE M4X20 TCB+ INOX</td> <td>8</td> <td>PZ</td> </tr> <tr> <td>VI1950A0</td> <td>ST. STEEL 4,2X13 TCB SELF-DRILLING SCREW</td> <td>10</td> <td>PZ</td> </tr> <tr> <td>VL1005A1</td> <td>U-TRAP TANK</td> <td>2</td> <td>PZ</td> </tr> <tr> <td>VL1006A0</td> <td>SYPHON COVER</td> <td>2</td> <td>PZ</td> </tr> <tr> <td>VL1046A1</td> <td>D6 PIPE HOLDER - D6 J.G. TERMINAL</td> <td>6</td> <td>PZ</td> </tr> <tr> <td>VL1047A1</td> <td>D6 PIPE HOLDER - D8 J.G. TERMINAL</td> <td>2</td> <td>PZ</td> </tr> <tr> <td>VM1015A1</td> <td>STAINLESS STEEL Ø30X1.5 90° BEND</td> <td>1</td> <td>PZ</td> </tr> <tr> <td>VM1794A0</td> <td>250X4.8 PA66 BLACK CLAMP</td> <td>2</td> <td>PZ</td> </tr> <tr> <td>VM2035A0</td> <td>DRAIN PIPE SUPPORT</td> <td>1</td> <td>PZ</td> </tr> </tbody> </table>	Code	Description	Qty	UOM	RC1008A0	D9 ELASTIC CLIP	7	PZ	RC1055A0	Ø25-40 H12 STAINLESS STEEL PIPE CLIP	10	PZ	RC1297A1	D10 T-SHAPED FITTING	1	PZ	RC1360A0	10 - 10 JG ELBOW FITTING	1	PZ	RC1376A0	Ø6 Y-FITTING	1	PZ	TB1177A0	FOOT PANEL 40X40 H58 OVERLAP LM	4	PZ	TB1520A0	INT. Ø=38 TH=4 DRAIN BLACK RUBBER PIPE	2.700	M	TB1815A0	7,93X4,75 PE TRANSP. PIPE (JG #PE08100N)	2	M	TB2243A0	D10 PE TRANSPAREN T PIPE	1.500	M	VI1075A0	NUT M4 H=4 UNI5587 INOX	8	PZ	VI1220A1	4,2X12 TCB SELF-TAPPING SCREW	16	PZ	VI1895A0	BLIND NUT M4 STAINLESS STEEL DIN 917	8	PZ	VI1945A0	ENG-VITE M4X20 TCB+ INOX	8	PZ	VI1950A0	ST. STEEL 4,2X13 TCB SELF-DRILLING SCREW	10	PZ	VL1005A1	U-TRAP TANK	2	PZ	VL1006A0	SYPHON COVER	2	PZ	VL1046A1	D6 PIPE HOLDER - D6 J.G. TERMINAL	6	PZ	VL1047A1	D6 PIPE HOLDER - D8 J.G. TERMINAL	2	PZ	VM1015A1	STAINLESS STEEL Ø30X1.5 90° BEND	1	PZ	VM1794A0	250X4.8 PA66 BLACK CLAMP	2	PZ	VM2035A0	DRAIN PIPE SUPPORT	1	PZ
Code	Description	Qty	UOM																																																																																										
RC1008A0	D9 ELASTIC CLIP	7	PZ																																																																																										
RC1055A0	Ø25-40 H12 STAINLESS STEEL PIPE CLIP	10	PZ																																																																																										
RC1297A1	D10 T-SHAPED FITTING	1	PZ																																																																																										
RC1360A0	10 - 10 JG ELBOW FITTING	1	PZ																																																																																										
RC1376A0	Ø6 Y-FITTING	1	PZ																																																																																										
TB1177A0	FOOT PANEL 40X40 H58 OVERLAP LM	4	PZ																																																																																										
TB1520A0	INT. Ø=38 TH=4 DRAIN BLACK RUBBER PIPE	2.700	M																																																																																										
TB1815A0	7,93X4,75 PE TRANSP. PIPE (JG #PE08100N)	2	M																																																																																										
TB2243A0	D10 PE TRANSPAREN T PIPE	1.500	M																																																																																										
VI1075A0	NUT M4 H=4 UNI5587 INOX	8	PZ																																																																																										
VI1220A1	4,2X12 TCB SELF-TAPPING SCREW	16	PZ																																																																																										
VI1895A0	BLIND NUT M4 STAINLESS STEEL DIN 917	8	PZ																																																																																										
VI1945A0	ENG-VITE M4X20 TCB+ INOX	8	PZ																																																																																										
VI1950A0	ST. STEEL 4,2X13 TCB SELF-DRILLING SCREW	10	PZ																																																																																										
VL1005A1	U-TRAP TANK	2	PZ																																																																																										
VL1006A0	SYPHON COVER	2	PZ																																																																																										
VL1046A1	D6 PIPE HOLDER - D6 J.G. TERMINAL	6	PZ																																																																																										
VL1047A1	D6 PIPE HOLDER - D8 J.G. TERMINAL	2	PZ																																																																																										
VM1015A1	STAINLESS STEEL Ø30X1.5 90° BEND	1	PZ																																																																																										
VM1794A0	250X4.8 PA66 BLACK CLAMP	2	PZ																																																																																										
VM2035A0	DRAIN PIPE SUPPORT	1	PZ																																																																																										





COMPONENT			SPARE PART																																																																																		
Code	Description	Image	Code	Description	Components list																																																																																
VL1005A	U-TRAP TANK		XC649	LINEMISS TOP FULL SIZE STACKING KIT	<table border="1"> <thead> <tr> <th>Code</th> <th>Description</th> <th>Qty</th> <th>UOM</th> </tr> </thead> <tbody> <tr> <td>0H1151A0</td> <td>PROOFER-OV EN FIXING BRACKET</td> <td>4</td> <td>PZ</td> </tr> <tr> <td>0H1237A0</td> <td>LM TOP SIPHON SUPPORT</td> <td>2</td> <td>PZ</td> </tr> <tr> <td>ED1335A0</td> <td>CAUTION HOT TRIANGLE LABEL</td> <td>1</td> <td>PZ</td> </tr> <tr> <td>ED1338A0</td> <td>UL LIQUID FALLS DANGER LABE</td> <td>1</td> <td>PZ</td> </tr> <tr> <td>EL1020A1</td> <td>D8 INTERMEDIAT E T-SHAPED FITTING</td> <td>2</td> <td>PZ</td> </tr> <tr> <td>EL1185A0</td> <td>Ø8F - Ø8F ELBOW CONNECTION</td> <td>2</td> <td>PZ</td> </tr> <tr> <td>GN1508A0</td> <td>O-RING GASKET COD 2400</td> <td>2</td> <td>PZ</td> </tr> <tr> <td>RC1008A0</td> <td>D9 ELASTIC CLIP</td> <td>3</td> <td>PZ</td> </tr> <tr> <td>RC1055A0</td> <td>Ø25-40 H12 STAINLESS STEEL PIPE CLIP</td> <td>8</td> <td>PZ</td> </tr> <tr> <td>RC1297A1</td> <td>D10 T-SHAPED FITTING</td> <td>1</td> <td>PZ</td> </tr> <tr> <td>RC1360A0</td> <td>10 - 10 JG ELBOW FITTING</td> <td>1</td> <td>PZ</td> </tr> <tr> <td>RC1376A0</td> <td>Ø6 Y-FITTING</td> <td>1</td> <td>PZ</td> </tr> <tr> <td>TB1520A0</td> <td>INT. Ø=38 TH=4 DRAIN BLACK RUBBER PIPE</td> <td>2.840</td> <td>M</td> </tr> <tr> <td>TB1815A0</td> <td>7,93X4,75 PE TRANSP. PIPE (JG #PE08100N)</td> <td>2</td> <td>M</td> </tr> <tr> <td>TB2243A0</td> <td>D10 PE TRANSPAREN T PIPE</td> <td>1.500</td> <td>M</td> </tr> <tr> <td>VI1075A0</td> <td>NUT M4 H=4 UNI5587 INOX</td> <td>8</td> <td>PZ</td> </tr> <tr> <td>VI1220A1</td> <td>4,2X12 TCB SELF-TAPPING SCREW</td> <td>7</td> <td>PZ</td> </tr> <tr> <td>VI1895A0</td> <td>BLIND NUT M4 STAINLESS STEEL DIN 917</td> <td>8</td> <td>PZ</td> </tr> <tr> <td>VI1945A0</td> <td>ENG-VITE M4X20 TCB+ INOX</td> <td>8</td> <td>PZ</td> </tr> </tbody> </table>	Code	Description	Qty	UOM	0H1151A0	PROOFER-OV EN FIXING BRACKET	4	PZ	0H1237A0	LM TOP SIPHON SUPPORT	2	PZ	ED1335A0	CAUTION HOT TRIANGLE LABEL	1	PZ	ED1338A0	UL LIQUID FALLS DANGER LABE	1	PZ	EL1020A1	D8 INTERMEDIAT E T-SHAPED FITTING	2	PZ	EL1185A0	Ø8F - Ø8F ELBOW CONNECTION	2	PZ	GN1508A0	O-RING GASKET COD 2400	2	PZ	RC1008A0	D9 ELASTIC CLIP	3	PZ	RC1055A0	Ø25-40 H12 STAINLESS STEEL PIPE CLIP	8	PZ	RC1297A1	D10 T-SHAPED FITTING	1	PZ	RC1360A0	10 - 10 JG ELBOW FITTING	1	PZ	RC1376A0	Ø6 Y-FITTING	1	PZ	TB1520A0	INT. Ø=38 TH=4 DRAIN BLACK RUBBER PIPE	2.840	M	TB1815A0	7,93X4,75 PE TRANSP. PIPE (JG #PE08100N)	2	M	TB2243A0	D10 PE TRANSPAREN T PIPE	1.500	M	VI1075A0	NUT M4 H=4 UNI5587 INOX	8	PZ	VI1220A1	4,2X12 TCB SELF-TAPPING SCREW	7	PZ	VI1895A0	BLIND NUT M4 STAINLESS STEEL DIN 917	8	PZ	VI1945A0	ENG-VITE M4X20 TCB+ INOX	8	PZ
Code	Description	Qty	UOM																																																																																		
0H1151A0	PROOFER-OV EN FIXING BRACKET	4	PZ																																																																																		
0H1237A0	LM TOP SIPHON SUPPORT	2	PZ																																																																																		
ED1335A0	CAUTION HOT TRIANGLE LABEL	1	PZ																																																																																		
ED1338A0	UL LIQUID FALLS DANGER LABE	1	PZ																																																																																		
EL1020A1	D8 INTERMEDIAT E T-SHAPED FITTING	2	PZ																																																																																		
EL1185A0	Ø8F - Ø8F ELBOW CONNECTION	2	PZ																																																																																		
GN1508A0	O-RING GASKET COD 2400	2	PZ																																																																																		
RC1008A0	D9 ELASTIC CLIP	3	PZ																																																																																		
RC1055A0	Ø25-40 H12 STAINLESS STEEL PIPE CLIP	8	PZ																																																																																		
RC1297A1	D10 T-SHAPED FITTING	1	PZ																																																																																		
RC1360A0	10 - 10 JG ELBOW FITTING	1	PZ																																																																																		
RC1376A0	Ø6 Y-FITTING	1	PZ																																																																																		
TB1520A0	INT. Ø=38 TH=4 DRAIN BLACK RUBBER PIPE	2.840	M																																																																																		
TB1815A0	7,93X4,75 PE TRANSP. PIPE (JG #PE08100N)	2	M																																																																																		
TB2243A0	D10 PE TRANSPAREN T PIPE	1.500	M																																																																																		
VI1075A0	NUT M4 H=4 UNI5587 INOX	8	PZ																																																																																		
VI1220A1	4,2X12 TCB SELF-TAPPING SCREW	7	PZ																																																																																		
VI1895A0	BLIND NUT M4 STAINLESS STEEL DIN 917	8	PZ																																																																																		
VI1945A0	ENG-VITE M4X20 TCB+ INOX	8	PZ																																																																																		

COMPONENT			SPARE PART																																																											
Code	Description	Image	Code	Description	Components list																																																									
VL1005A	U-TRAP TANK		XC649	LINEMISS TOP FULL SIZE STACKING KIT	<table border="1"> <thead> <tr> <th>Code</th> <th>Description</th> <th>Qty</th> <th>UOM</th> </tr> </thead> <tbody> <tr> <td>VI1950A0</td> <td>ST. STEEL 4.2X13 TCB SELF-DRILLIN G SCREW</td> <td>6</td> <td>PZ</td> </tr> <tr> <td>VL1005A1</td> <td>U-TRAP TANK</td> <td>2</td> <td>PZ</td> </tr> <tr> <td>VL1006A0</td> <td>SYPHON COVER</td> <td>2</td> <td>PZ</td> </tr> <tr> <td>VL1046A1</td> <td>D6 PIPE HOLDER - D6 J.G. TERMINAL</td> <td>3</td> <td>PZ</td> </tr> <tr> <td>VM1794A0</td> <td>250X4.8 PA66 BLACK CLAMP</td> <td>2</td> <td>PZ</td> </tr> <tr> <td>VM2035A0</td> <td>DRAIN PIPE SUPPORT</td> <td>1</td> <td>PZ</td> </tr> </tbody> </table>	Code	Description	Qty	UOM	VI1950A0	ST. STEEL 4.2X13 TCB SELF-DRILLIN G SCREW	6	PZ	VL1005A1	U-TRAP TANK	2	PZ	VL1006A0	SYPHON COVER	2	PZ	VL1046A1	D6 PIPE HOLDER - D6 J.G. TERMINAL	3	PZ	VM1794A0	250X4.8 PA66 BLACK CLAMP	2	PZ	VM2035A0	DRAIN PIPE SUPPORT	1	PZ																													
			Code	Description	Qty	UOM																																																								
VI1950A0	ST. STEEL 4.2X13 TCB SELF-DRILLIN G SCREW	6	PZ																																																											
VL1005A1	U-TRAP TANK	2	PZ																																																											
VL1006A0	SYPHON COVER	2	PZ																																																											
VL1046A1	D6 PIPE HOLDER - D6 J.G. TERMINAL	3	PZ																																																											
VM1794A0	250X4.8 PA66 BLACK CLAMP	2	PZ																																																											
VM2035A0	DRAIN PIPE SUPPORT	1	PZ																																																											
XC648	LINEMISS TOP XFT200 STACKING KIT	<table border="1"> <thead> <tr> <th>Code</th> <th>Description</th> <th>Qty</th> <th>UOM</th> </tr> </thead> <tbody> <tr> <td>0H1237A0</td> <td>LM TOP SIPHON SUPPORT</td> <td>2</td> <td>PZ</td> </tr> <tr> <td>0H7082A0</td> <td>LM 800 XC STACKING KIT FRONT PROFILE</td> <td>1</td> <td>PZ</td> </tr> <tr> <td>0H7083A0</td> <td>LM 800 XC STACKING KIT BACK PROFIL</td> <td>2</td> <td>PZ</td> </tr> <tr> <td>ED1246A0</td> <td>HOT SURFACE LABEL</td> <td>1</td> <td>PZ</td> </tr> <tr> <td>ED1271A0</td> <td>LIQUID FALLS DANGER LABE</td> <td>1</td> <td>PZ</td> </tr> <tr> <td>EL1020A1</td> <td>D8 INTERMEDIAT E T-SHAPED FITTING</td> <td>2</td> <td>PZ</td> </tr> <tr> <td>EL1180A0</td> <td>Ø8-Ø8 FEMALE NON-RETURN CONNECTION</td> <td>2</td> <td>PZ</td> </tr> <tr> <td>GN1508A0</td> <td>O-RING GASKET COD 2400</td> <td>2</td> <td>PZ</td> </tr> <tr> <td>RC1008A0</td> <td>D9 ELASTIC CLIP</td> <td>7</td> <td>PZ</td> </tr> <tr> <td>RC1055A0</td> <td>Ø25-40 H12 STAINLESS STEEL PIPE CLIP</td> <td>10</td> <td>PZ</td> </tr> <tr> <td>RC1297A1</td> <td>D10 T-SHAPED FITTING</td> <td>1</td> <td>PZ</td> </tr> <tr> <td>RC1360A0</td> <td>10 - 10 JG ELBOW FITTIN</td> <td>1</td> <td>PZ</td> </tr> <tr> <td>RC1376A0</td> <td>Ø6 Y-FITTING</td> <td>1</td> <td>PZ</td> </tr> <tr> <td>TB1177A0</td> <td>FOOT PANEL 40X40 H58 OVERLAP LM</td> <td>4</td> <td>PZ</td> </tr> </tbody> </table>	Code	Description	Qty	UOM	0H1237A0	LM TOP SIPHON SUPPORT	2	PZ	0H7082A0	LM 800 XC STACKING KIT FRONT PROFILE	1	PZ	0H7083A0	LM 800 XC STACKING KIT BACK PROFIL	2	PZ	ED1246A0	HOT SURFACE LABEL	1	PZ	ED1271A0	LIQUID FALLS DANGER LABE	1	PZ	EL1020A1	D8 INTERMEDIAT E T-SHAPED FITTING	2	PZ	EL1180A0	Ø8-Ø8 FEMALE NON-RETURN CONNECTION	2	PZ	GN1508A0	O-RING GASKET COD 2400	2	PZ	RC1008A0	D9 ELASTIC CLIP	7	PZ	RC1055A0	Ø25-40 H12 STAINLESS STEEL PIPE CLIP	10	PZ	RC1297A1	D10 T-SHAPED FITTING	1	PZ	RC1360A0	10 - 10 JG ELBOW FITTIN	1	PZ	RC1376A0	Ø6 Y-FITTING	1	PZ	TB1177A0	FOOT PANEL 40X40 H58 OVERLAP LM	4	PZ
Code	Description	Qty	UOM																																																											
0H1237A0	LM TOP SIPHON SUPPORT	2	PZ																																																											
0H7082A0	LM 800 XC STACKING KIT FRONT PROFILE	1	PZ																																																											
0H7083A0	LM 800 XC STACKING KIT BACK PROFIL	2	PZ																																																											
ED1246A0	HOT SURFACE LABEL	1	PZ																																																											
ED1271A0	LIQUID FALLS DANGER LABE	1	PZ																																																											
EL1020A1	D8 INTERMEDIAT E T-SHAPED FITTING	2	PZ																																																											
EL1180A0	Ø8-Ø8 FEMALE NON-RETURN CONNECTION	2	PZ																																																											
GN1508A0	O-RING GASKET COD 2400	2	PZ																																																											
RC1008A0	D9 ELASTIC CLIP	7	PZ																																																											
RC1055A0	Ø25-40 H12 STAINLESS STEEL PIPE CLIP	10	PZ																																																											
RC1297A1	D10 T-SHAPED FITTING	1	PZ																																																											
RC1360A0	10 - 10 JG ELBOW FITTIN	1	PZ																																																											
RC1376A0	Ø6 Y-FITTING	1	PZ																																																											
TB1177A0	FOOT PANEL 40X40 H58 OVERLAP LM	4	PZ																																																											

COMPONENT			SPARE PART																																																																																					
Code	Description	Image	Code	Description	Components list																																																																																			
VL1005A	U-TRAP TANK		XC648	LINEMISS TOP XFT200 STACKING KIT	<table border="1"> <thead> <tr> <th>Code</th> <th>Description</th> <th>Qty</th> <th>UOM</th> </tr> </thead> <tbody> <tr> <td>TB1520A0</td> <td>INT. Ø=38 TH=4 DRAIN BLACK RUBBER PIPE</td> <td>2.700</td> <td>M</td> </tr> <tr> <td>TB1815A0</td> <td>7.93X4,75 PE TRANSP. PIPE (JG #PE08100N)</td> <td>2</td> <td>M</td> </tr> <tr> <td>TB2243A0</td> <td>D10 PE TRANSPAREN T PIPE</td> <td>1.500</td> <td>M</td> </tr> <tr> <td>VI1075A0</td> <td>NUT M4 H=4 UNI5587 INOX</td> <td>8</td> <td>PZ</td> </tr> <tr> <td>VI1220A1</td> <td>4,2X12 TCB SELF-TAPPIN G SCREW</td> <td>16</td> <td>PZ</td> </tr> <tr> <td>VI1895A0</td> <td>BLIND NUT M4 STAINLESS STEEL DIN 917</td> <td>8</td> <td>PZ</td> </tr> <tr> <td>VI1945A0</td> <td>ENG-VITE M4X20 TCB+ INOX</td> <td>8</td> <td>PZ</td> </tr> <tr> <td>VI1950A0</td> <td>ST. STEEL 4,2X13 TCB SELF-DRILLIN G SCREW</td> <td>10</td> <td>PZ</td> </tr> <tr> <td>VL1005A1</td> <td>U-TRAP TANK</td> <td>2</td> <td>PZ</td> </tr> <tr> <td>VL1006A0</td> <td>SYPHON COVER</td> <td>2</td> <td>PZ</td> </tr> <tr> <td>VL1046A1</td> <td>D6 PIPE HOLDER - D6 J.G. TERMINAL</td> <td>6</td> <td>PZ</td> </tr> <tr> <td>VL1047A1</td> <td>D6 PIPE HOLDER - D6 J.G. TERMINAL</td> <td>4</td> <td>PZ</td> </tr> <tr> <td>VM1015A1</td> <td>STAINLESS STEEL Ø30X1.5 90° BEND</td> <td>1</td> <td>PZ</td> </tr> <tr> <td>VM1794A0</td> <td>250X4.8 PA66 BLACK CLAMP</td> <td>2</td> <td>PZ</td> </tr> <tr> <td>VM2035A0</td> <td>DRAIN PIPE SUPPORT</td> <td>1</td> <td>PZ</td> </tr> </tbody> </table>	Code	Description	Qty	UOM	TB1520A0	INT. Ø=38 TH=4 DRAIN BLACK RUBBER PIPE	2.700	M	TB1815A0	7.93X4,75 PE TRANSP. PIPE (JG #PE08100N)	2	M	TB2243A0	D10 PE TRANSPAREN T PIPE	1.500	M	VI1075A0	NUT M4 H=4 UNI5587 INOX	8	PZ	VI1220A1	4,2X12 TCB SELF-TAPPIN G SCREW	16	PZ	VI1895A0	BLIND NUT M4 STAINLESS STEEL DIN 917	8	PZ	VI1945A0	ENG-VITE M4X20 TCB+ INOX	8	PZ	VI1950A0	ST. STEEL 4,2X13 TCB SELF-DRILLIN G SCREW	10	PZ	VL1005A1	U-TRAP TANK	2	PZ	VL1006A0	SYPHON COVER	2	PZ	VL1046A1	D6 PIPE HOLDER - D6 J.G. TERMINAL	6	PZ	VL1047A1	D6 PIPE HOLDER - D6 J.G. TERMINAL	4	PZ	VM1015A1	STAINLESS STEEL Ø30X1.5 90° BEND	1	PZ	VM1794A0	250X4.8 PA66 BLACK CLAMP	2	PZ	VM2035A0	DRAIN PIPE SUPPORT	1	PZ	KVL1005A	U-TRAP KIT	<table border="1"> <thead> <tr> <th>Code</th> <th>Description</th> <th>Qty</th> <th>UOM</th> </tr> </thead> <tbody> <tr> <td>GN1508A0</td> <td>O-RING GASKET COD 2400</td> <td>1</td> <td>PZ</td> </tr> <tr> <td>VI1075A0</td> <td>NUT M4 H=4 UNI5587 INOX</td> <td>4</td> <td>PZ</td> </tr> <tr> <td>VI1895A0</td> <td>BLIND NUT M4 STAINLESS STEEL DIN 917</td> <td>4</td> <td>PZ</td> </tr> </tbody> </table>	Code	Description	Qty	UOM	GN1508A0	O-RING GASKET COD 2400	1	PZ	VI1075A0	NUT M4 H=4 UNI5587 INOX	4	PZ	VI1895A0	BLIND NUT M4 STAINLESS STEEL DIN 917	4	PZ
			Code	Description	Qty	UOM																																																																																		
TB1520A0	INT. Ø=38 TH=4 DRAIN BLACK RUBBER PIPE	2.700	M																																																																																					
TB1815A0	7.93X4,75 PE TRANSP. PIPE (JG #PE08100N)	2	M																																																																																					
TB2243A0	D10 PE TRANSPAREN T PIPE	1.500	M																																																																																					
VI1075A0	NUT M4 H=4 UNI5587 INOX	8	PZ																																																																																					
VI1220A1	4,2X12 TCB SELF-TAPPIN G SCREW	16	PZ																																																																																					
VI1895A0	BLIND NUT M4 STAINLESS STEEL DIN 917	8	PZ																																																																																					
VI1945A0	ENG-VITE M4X20 TCB+ INOX	8	PZ																																																																																					
VI1950A0	ST. STEEL 4,2X13 TCB SELF-DRILLIN G SCREW	10	PZ																																																																																					
VL1005A1	U-TRAP TANK	2	PZ																																																																																					
VL1006A0	SYPHON COVER	2	PZ																																																																																					
VL1046A1	D6 PIPE HOLDER - D6 J.G. TERMINAL	6	PZ																																																																																					
VL1047A1	D6 PIPE HOLDER - D6 J.G. TERMINAL	4	PZ																																																																																					
VM1015A1	STAINLESS STEEL Ø30X1.5 90° BEND	1	PZ																																																																																					
VM1794A0	250X4.8 PA66 BLACK CLAMP	2	PZ																																																																																					
VM2035A0	DRAIN PIPE SUPPORT	1	PZ																																																																																					
Code	Description	Qty	UOM																																																																																					
GN1508A0	O-RING GASKET COD 2400	1	PZ																																																																																					
VI1075A0	NUT M4 H=4 UNI5587 INOX	4	PZ																																																																																					
VI1895A0	BLIND NUT M4 STAINLESS STEEL DIN 917	4	PZ																																																																																					

COMPONENT			SPARE PART																																																																		
Code	Description	Image	Code	Description	Components list																																																																
VL1005A	U-TRAP TANK		KVL1005A	U-TRAP KIT	<table border="1"> <thead> <tr> <th>Code</th> <th>Description</th> <th>Qty</th> <th>UOM</th> </tr> </thead> <tbody> <tr> <td>VI1945A0</td> <td>ENG-VITE M4X20 TCB+ INOX</td> <td>4</td> <td>PZ</td> </tr> <tr> <td>VL1005A1</td> <td>U-TRAP TANK</td> <td>1</td> <td>PZ</td> </tr> <tr> <td>VL1006A0</td> <td>SYPHON COVER</td> <td>1</td> <td>PZ</td> </tr> </tbody> </table>	Code	Description	Qty	UOM	VI1945A0	ENG-VITE M4X20 TCB+ INOX	4	PZ	VL1005A1	U-TRAP TANK	1	PZ	VL1006A0	SYPHON COVER	1	PZ																																																
Code	Description	Qty	UOM																																																																		
VI1945A0	ENG-VITE M4X20 TCB+ INOX	4	PZ																																																																		
VL1005A1	U-TRAP TANK	1	PZ																																																																		
VL1006A0	SYPHON COVER	1	PZ																																																																		
VL1006A	SYPHON COVER		XUC001	SINGLE UNIT INSTALLATION KIT	<table border="1"> <thead> <tr> <th>Code</th> <th>Description</th> <th>Qty</th> <th>UOM</th> </tr> </thead> <tbody> <tr> <td>0H6567A0</td> <td>P-TRAP HOLDING BRACKET</td> <td>1</td> <td>PZ</td> </tr> <tr> <td>GN1400A0</td> <td>U-TRAP SEAL</td> <td>1</td> <td>PZ</td> </tr> <tr> <td>GN1508A0</td> <td>O-RING GASKET COD 2400</td> <td>1</td> <td>PZ</td> </tr> <tr> <td>IL1115A0</td> <td>WOODEN PALET 80X120</td> <td>0.100</td> <td>PZ</td> </tr> <tr> <td>RC1055A0</td> <td>Ø25-40 H12 STAINLESS STEEL PIPE CLIP</td> <td>3</td> <td>PZ</td> </tr> <tr> <td>TB1520A0</td> <td>INT. Ø=38 TH=4 DRAIN BLACK RUBBER PIPE</td> <td>2.500</td> <td>M</td> </tr> <tr> <td>VI1075A0</td> <td>NUT M4 H=4 UNI5587 INOX</td> <td>4</td> <td>PZ</td> </tr> <tr> <td>VI1220A1</td> <td>4,2X12 TCB SELF-TAPPIN G SCREW</td> <td>2</td> <td>PZ</td> </tr> <tr> <td>VI1895A0</td> <td>BLIND NUT M4 STAINLESS STEEL DIN 917</td> <td>4</td> <td>PZ</td> </tr> <tr> <td>VI1945A0</td> <td>ENG-VITE M4X20 TCB+ INOX</td> <td>4</td> <td>PZ</td> </tr> <tr> <td>VI1950A0</td> <td>ST. STEEL 4,2X13 TCB SELF-DRILLIN G SCREW</td> <td>2</td> <td>PZ</td> </tr> <tr> <td>VL1005A1</td> <td>U-TRAP TANK</td> <td>1</td> <td>PZ</td> </tr> <tr> <td>VL1006A0</td> <td>SYPHON COVER</td> <td>1</td> <td>PZ</td> </tr> <tr> <td>VL1026A0</td> <td>BEND FOR DRAIN PIPE</td> <td>1</td> <td>PZ</td> </tr> <tr> <td>VM1015A1</td> <td>STAINLESS STEEL Ø30X1.5 90° BEND</td> <td>1</td> <td>PZ</td> </tr> </tbody> </table>	Code	Description	Qty	UOM	0H6567A0	P-TRAP HOLDING BRACKET	1	PZ	GN1400A0	U-TRAP SEAL	1	PZ	GN1508A0	O-RING GASKET COD 2400	1	PZ	IL1115A0	WOODEN PALET 80X120	0.100	PZ	RC1055A0	Ø25-40 H12 STAINLESS STEEL PIPE CLIP	3	PZ	TB1520A0	INT. Ø=38 TH=4 DRAIN BLACK RUBBER PIPE	2.500	M	VI1075A0	NUT M4 H=4 UNI5587 INOX	4	PZ	VI1220A1	4,2X12 TCB SELF-TAPPIN G SCREW	2	PZ	VI1895A0	BLIND NUT M4 STAINLESS STEEL DIN 917	4	PZ	VI1945A0	ENG-VITE M4X20 TCB+ INOX	4	PZ	VI1950A0	ST. STEEL 4,2X13 TCB SELF-DRILLIN G SCREW	2	PZ	VL1005A1	U-TRAP TANK	1	PZ	VL1006A0	SYPHON COVER	1	PZ	VL1026A0	BEND FOR DRAIN PIPE	1	PZ	VM1015A1	STAINLESS STEEL Ø30X1.5 90° BEND	1	PZ
Code	Description	Qty	UOM																																																																		
0H6567A0	P-TRAP HOLDING BRACKET	1	PZ																																																																		
GN1400A0	U-TRAP SEAL	1	PZ																																																																		
GN1508A0	O-RING GASKET COD 2400	1	PZ																																																																		
IL1115A0	WOODEN PALET 80X120	0.100	PZ																																																																		
RC1055A0	Ø25-40 H12 STAINLESS STEEL PIPE CLIP	3	PZ																																																																		
TB1520A0	INT. Ø=38 TH=4 DRAIN BLACK RUBBER PIPE	2.500	M																																																																		
VI1075A0	NUT M4 H=4 UNI5587 INOX	4	PZ																																																																		
VI1220A1	4,2X12 TCB SELF-TAPPIN G SCREW	2	PZ																																																																		
VI1895A0	BLIND NUT M4 STAINLESS STEEL DIN 917	4	PZ																																																																		
VI1945A0	ENG-VITE M4X20 TCB+ INOX	4	PZ																																																																		
VI1950A0	ST. STEEL 4,2X13 TCB SELF-DRILLIN G SCREW	2	PZ																																																																		
VL1005A1	U-TRAP TANK	1	PZ																																																																		
VL1006A0	SYPHON COVER	1	PZ																																																																		
VL1026A0	BEND FOR DRAIN PIPE	1	PZ																																																																		
VM1015A1	STAINLESS STEEL Ø30X1.5 90° BEND	1	PZ																																																																		

COMPONENT			SPARE PART																																																																														
Code	Description	Image	Code	Description	Components list																																																																												
VL1006A	SYPHON COVER		XC761	3 OVENS LM TOP XFT200 STACKING KIT	<table border="1"> <thead> <tr> <th>Code</th> <th>Description</th> <th>Qty</th> <th>UOM</th> </tr> </thead> <tbody> <tr> <td>0H1237A0</td> <td>LM TOP SIPHON SUPPORT</td> <td>3</td> <td>PZ</td> </tr> <tr> <td>0H7082A0</td> <td>LM 800 XC STACKING KIT FRONT PROFILE</td> <td>2</td> <td>PZ</td> </tr> <tr> <td>0H7083A0</td> <td>LM 800 XC STACKING KIT BACK PROFIL</td> <td>4</td> <td>PZ</td> </tr> <tr> <td>ED1246A0</td> <td>HOT SURFACE LABEL</td> <td>1</td> <td>PZ</td> </tr> <tr> <td>ED1271A0</td> <td>LIQUID FALLS DANGER LABE</td> <td>1</td> <td>PZ</td> </tr> <tr> <td>EL1020A1</td> <td>D8 INTERMEDIAT E T-SHAPED FITTING</td> <td>4</td> <td>PZ</td> </tr> <tr> <td>EL1180A0</td> <td>Ø8-Ø8 FEMALE NON-RETURN CONNECTION</td> <td>3</td> <td>PZ</td> </tr> <tr> <td>GN1508A0</td> <td>O-RING GASKET COD 2400</td> <td>3</td> <td>PZ</td> </tr> <tr> <td>RC1008A0</td> <td>D9 ELASTIC CLIP</td> <td>12</td> <td>PZ</td> </tr> <tr> <td>RC1055A0</td> <td>Ø25-40 H12 STAINLESS STEEL PIPE CLIP</td> <td>15</td> <td>PZ</td> </tr> <tr> <td>RC1297A1</td> <td>D10 T-SHAPED FITTING</td> <td>2</td> <td>PZ</td> </tr> <tr> <td>RC1360A0</td> <td>10 - 10 JG ELBOW FITTIN</td> <td>1</td> <td>PZ</td> </tr> <tr> <td>RC1376A0</td> <td>Ø6 Y-FITTING</td> <td>2</td> <td>PZ</td> </tr> <tr> <td>TB1177A0</td> <td>FOOT PANEL 40X40 H58 OVERLAP LM</td> <td>8</td> <td>PZ</td> </tr> <tr> <td>TB1520A0</td> <td>INT. Ø=38 TH=4 DRAIN BLACK RUBBER PIPE</td> <td>5</td> <td>M</td> </tr> <tr> <td>TB1815A0</td> <td>7,93X4,75 PE TRANSP. PIPE (JG #PE08100N)</td> <td>12</td> <td>M</td> </tr> <tr> <td>TB1816A0</td> <td>CLEAR POLYPROPYL ENE PIPE 6X4MM</td> <td>3</td> <td>M</td> </tr> <tr> <td>TB2243A0</td> <td>D10 PE TRANSPAREN T PIPE</td> <td>4</td> <td>M</td> </tr> </tbody> </table>	Code	Description	Qty	UOM	0H1237A0	LM TOP SIPHON SUPPORT	3	PZ	0H7082A0	LM 800 XC STACKING KIT FRONT PROFILE	2	PZ	0H7083A0	LM 800 XC STACKING KIT BACK PROFIL	4	PZ	ED1246A0	HOT SURFACE LABEL	1	PZ	ED1271A0	LIQUID FALLS DANGER LABE	1	PZ	EL1020A1	D8 INTERMEDIAT E T-SHAPED FITTING	4	PZ	EL1180A0	Ø8-Ø8 FEMALE NON-RETURN CONNECTION	3	PZ	GN1508A0	O-RING GASKET COD 2400	3	PZ	RC1008A0	D9 ELASTIC CLIP	12	PZ	RC1055A0	Ø25-40 H12 STAINLESS STEEL PIPE CLIP	15	PZ	RC1297A1	D10 T-SHAPED FITTING	2	PZ	RC1360A0	10 - 10 JG ELBOW FITTIN	1	PZ	RC1376A0	Ø6 Y-FITTING	2	PZ	TB1177A0	FOOT PANEL 40X40 H58 OVERLAP LM	8	PZ	TB1520A0	INT. Ø=38 TH=4 DRAIN BLACK RUBBER PIPE	5	M	TB1815A0	7,93X4,75 PE TRANSP. PIPE (JG #PE08100N)	12	M	TB1816A0	CLEAR POLYPROPYL ENE PIPE 6X4MM	3	M	TB2243A0	D10 PE TRANSPAREN T PIPE	4	M
Code	Description	Qty	UOM																																																																														
0H1237A0	LM TOP SIPHON SUPPORT	3	PZ																																																																														
0H7082A0	LM 800 XC STACKING KIT FRONT PROFILE	2	PZ																																																																														
0H7083A0	LM 800 XC STACKING KIT BACK PROFIL	4	PZ																																																																														
ED1246A0	HOT SURFACE LABEL	1	PZ																																																																														
ED1271A0	LIQUID FALLS DANGER LABE	1	PZ																																																																														
EL1020A1	D8 INTERMEDIAT E T-SHAPED FITTING	4	PZ																																																																														
EL1180A0	Ø8-Ø8 FEMALE NON-RETURN CONNECTION	3	PZ																																																																														
GN1508A0	O-RING GASKET COD 2400	3	PZ																																																																														
RC1008A0	D9 ELASTIC CLIP	12	PZ																																																																														
RC1055A0	Ø25-40 H12 STAINLESS STEEL PIPE CLIP	15	PZ																																																																														
RC1297A1	D10 T-SHAPED FITTING	2	PZ																																																																														
RC1360A0	10 - 10 JG ELBOW FITTIN	1	PZ																																																																														
RC1376A0	Ø6 Y-FITTING	2	PZ																																																																														
TB1177A0	FOOT PANEL 40X40 H58 OVERLAP LM	8	PZ																																																																														
TB1520A0	INT. Ø=38 TH=4 DRAIN BLACK RUBBER PIPE	5	M																																																																														
TB1815A0	7,93X4,75 PE TRANSP. PIPE (JG #PE08100N)	12	M																																																																														
TB1816A0	CLEAR POLYPROPYL ENE PIPE 6X4MM	3	M																																																																														
TB2243A0	D10 PE TRANSPAREN T PIPE	4	M																																																																														

COMPONENT			SPARE PART																																																																																																	
Code	Description	Image	Code	Description	Components list																																																																																															
VL1006A	SYPHON COVER		XC761	3 OVENS LM TOP XFT200 STACKING KIT	<table border="1"> <thead> <tr> <th>Code</th> <th>Description</th> <th>Qty</th> <th>UOM</th> </tr> </thead> <tbody> <tr> <td>VI1075A0</td> <td>NUT M4 H=4 UNI5587 INOX</td> <td>12</td> <td>PZ</td> </tr> <tr> <td>VI1220A1</td> <td>4,2X12 TCB SELF-TAPPIN G SCREW</td> <td>30</td> <td>PZ</td> </tr> <tr> <td>VI1895A0</td> <td>BLIND NUT M4 STAINLESS STEEL DIN 917</td> <td>12</td> <td>PZ</td> </tr> <tr> <td>VI1945A0</td> <td>ENG-VITE M4X20 TCB+ INOX</td> <td>12</td> <td>PZ</td> </tr> <tr> <td>VI1950A0</td> <td>ST. STEEL 4,2X13 TCB SELF-DRILLIN G SCREW</td> <td>20</td> <td>PZ</td> </tr> <tr> <td>VL1005A1</td> <td>U-TRAP TANK</td> <td>3</td> <td>PZ</td> </tr> <tr> <td>VL1006A0</td> <td>SYPHON COVER</td> <td>3</td> <td>PZ</td> </tr> <tr> <td>VL1046A1</td> <td>D6 PIPE HOLDER - D6 J.G. TERMINAL</td> <td>12</td> <td>PZ</td> </tr> <tr> <td>VM1015A1</td> <td>STAINLESS STEEL Ø30X1,5 90° BEND</td> <td>1</td> <td>PZ</td> </tr> <tr> <td>VM1794A0</td> <td>250X4,8 PA66 BLACK CLAMP</td> <td>3</td> <td>PZ</td> </tr> <tr> <td>VM2035A0</td> <td>DRAIN PIPE SUPPORT</td> <td>3</td> <td>PZ</td> </tr> </tbody> </table>	Code	Description	Qty	UOM	VI1075A0	NUT M4 H=4 UNI5587 INOX	12	PZ	VI1220A1	4,2X12 TCB SELF-TAPPIN G SCREW	30	PZ	VI1895A0	BLIND NUT M4 STAINLESS STEEL DIN 917	12	PZ	VI1945A0	ENG-VITE M4X20 TCB+ INOX	12	PZ	VI1950A0	ST. STEEL 4,2X13 TCB SELF-DRILLIN G SCREW	20	PZ	VL1005A1	U-TRAP TANK	3	PZ	VL1006A0	SYPHON COVER	3	PZ	VL1046A1	D6 PIPE HOLDER - D6 J.G. TERMINAL	12	PZ	VM1015A1	STAINLESS STEEL Ø30X1,5 90° BEND	1	PZ	VM1794A0	250X4,8 PA66 BLACK CLAMP	3	PZ	VM2035A0	DRAIN PIPE SUPPORT	3	PZ	XC757	S. E CHEFTOP GN1/1 STACKING KI	<table border="1"> <thead> <tr> <th>Code</th> <th>Description</th> <th>Qty</th> <th>UOM</th> </tr> </thead> <tbody> <tr> <td>0H6463A0</td> <td>XC757 FRONT PROFILE</td> <td>1</td> <td>PZ</td> </tr> <tr> <td>CE1305A0</td> <td>L=2MT RJ45 - RJ45 CABLE</td> <td>1</td> <td>PZ</td> </tr> <tr> <td>ED1246A0</td> <td>HOT SURFACE LABEL</td> <td>2</td> <td>PZ</td> </tr> <tr> <td>ED1271A0</td> <td>LIQUID FALLS DANGER LABE</td> <td>1</td> <td>PZ</td> </tr> <tr> <td>EL1020A1</td> <td>D8 INTERMEDIAT E T-SHAPED FITTING</td> <td>2</td> <td>PZ</td> </tr> <tr> <td>GN1508A0</td> <td>O-RING GASKET COD 2400</td> <td>2</td> <td>PZ</td> </tr> <tr> <td>PD1069A0</td> <td>FOOT OVERLAP S5 CT-BT-E</td> <td>1</td> <td>PZ</td> </tr> <tr> <td>RC1008A0</td> <td>D9 ELASTIC CLIP</td> <td>3</td> <td>PZ</td> </tr> <tr> <td>RC1055A0</td> <td>Ø25-40 H12 STAINLESS STEEL PIPE CLIP</td> <td>14</td> <td>PZ</td> </tr> <tr> <td>RC1130A0</td> <td>130X2,6 CLAM</td> <td>3</td> <td>PZ</td> </tr> </tbody> </table>	Code	Description	Qty	UOM	0H6463A0	XC757 FRONT PROFILE	1	PZ	CE1305A0	L=2MT RJ45 - RJ45 CABLE	1	PZ	ED1246A0	HOT SURFACE LABEL	2	PZ	ED1271A0	LIQUID FALLS DANGER LABE	1	PZ	EL1020A1	D8 INTERMEDIAT E T-SHAPED FITTING	2	PZ	GN1508A0	O-RING GASKET COD 2400	2	PZ	PD1069A0	FOOT OVERLAP S5 CT-BT-E	1	PZ	RC1008A0	D9 ELASTIC CLIP	3	PZ	RC1055A0	Ø25-40 H12 STAINLESS STEEL PIPE CLIP	14	PZ	RC1130A0	130X2,6 CLAM	3	PZ
			Code	Description	Qty	UOM																																																																																														
VI1075A0	NUT M4 H=4 UNI5587 INOX	12	PZ																																																																																																	
VI1220A1	4,2X12 TCB SELF-TAPPIN G SCREW	30	PZ																																																																																																	
VI1895A0	BLIND NUT M4 STAINLESS STEEL DIN 917	12	PZ																																																																																																	
VI1945A0	ENG-VITE M4X20 TCB+ INOX	12	PZ																																																																																																	
VI1950A0	ST. STEEL 4,2X13 TCB SELF-DRILLIN G SCREW	20	PZ																																																																																																	
VL1005A1	U-TRAP TANK	3	PZ																																																																																																	
VL1006A0	SYPHON COVER	3	PZ																																																																																																	
VL1046A1	D6 PIPE HOLDER - D6 J.G. TERMINAL	12	PZ																																																																																																	
VM1015A1	STAINLESS STEEL Ø30X1,5 90° BEND	1	PZ																																																																																																	
VM1794A0	250X4,8 PA66 BLACK CLAMP	3	PZ																																																																																																	
VM2035A0	DRAIN PIPE SUPPORT	3	PZ																																																																																																	
Code	Description	Qty	UOM																																																																																																	
0H6463A0	XC757 FRONT PROFILE	1	PZ																																																																																																	
CE1305A0	L=2MT RJ45 - RJ45 CABLE	1	PZ																																																																																																	
ED1246A0	HOT SURFACE LABEL	2	PZ																																																																																																	
ED1271A0	LIQUID FALLS DANGER LABE	1	PZ																																																																																																	
EL1020A1	D8 INTERMEDIAT E T-SHAPED FITTING	2	PZ																																																																																																	
GN1508A0	O-RING GASKET COD 2400	2	PZ																																																																																																	
PD1069A0	FOOT OVERLAP S5 CT-BT-E	1	PZ																																																																																																	
RC1008A0	D9 ELASTIC CLIP	3	PZ																																																																																																	
RC1055A0	Ø25-40 H12 STAINLESS STEEL PIPE CLIP	14	PZ																																																																																																	
RC1130A0	130X2,6 CLAM	3	PZ																																																																																																	

COMPONENT			SPARE PART																																																																																													
Code	Description	Image	Code	Description	Components list																																																																																											
VL1006A	SYPHON COVER		XC757	S. E CHEFTOP GN1/1 STACKING KI	<table border="1"> <thead> <tr> <th>Code</th> <th>Description</th> <th>Qty</th> <th>UOM</th> </tr> </thead> <tbody> <tr> <td>RC1297A1</td> <td>D10 T-SHAPED FITTING</td> <td>1</td> <td>PZ</td> </tr> <tr> <td>RC1376A0</td> <td>Ø6 Y-FITTING</td> <td>1</td> <td>PZ</td> </tr> <tr> <td>TB1520A0</td> <td>INT. Ø=38 TH=4 DRAIN BLACK RUBBER PIPE</td> <td>5</td> <td>M</td> </tr> <tr> <td>TB1765A1</td> <td>STACKING KIT CHIMNEY CONNECTING PIPE</td> <td>2</td> <td>PZ</td> </tr> <tr> <td>TB2243A0</td> <td>D10 PE TRANSPAREN T PIPE</td> <td>1.500</td> <td>M</td> </tr> <tr> <td>VI1075A0</td> <td>NUT M4 H=4 UNI5587 INOX</td> <td>8</td> <td>PZ</td> </tr> <tr> <td>VI1220A1</td> <td>4,2X12 TCB SELF-TAPPIN G SCREW</td> <td>4</td> <td>PZ</td> </tr> <tr> <td>VI1895A0</td> <td>BLIND NUT M4 STAINLESS STEEL DIN 917</td> <td>8</td> <td>PZ</td> </tr> <tr> <td>VI1945A0</td> <td>ENG-VITE M4X20 TCB+ INOX</td> <td>8</td> <td>PZ</td> </tr> <tr> <td>VI1950A0</td> <td>ST. STEEL 4,2X13 TCB SELF-DRILLIN G SCREW</td> <td>26</td> <td>PZ</td> </tr> <tr> <td>VL1005A1</td> <td>U-TRAP TANK COVER</td> <td>2</td> <td>PZ</td> </tr> <tr> <td>VL1006A0</td> <td>SYPHON COVER</td> <td>2</td> <td>PZ</td> </tr> <tr> <td>VL1043A0</td> <td>D4 PIPE HOLDER - D6 J.G. TERMINAL</td> <td>3</td> <td>PZ</td> </tr> <tr> <td>VL1046A1</td> <td>D6 PIPE HOLDER - D6 J.G. TERMINAL</td> <td>3</td> <td>PZ</td> </tr> <tr> <td>VM1015A1</td> <td>STAINLESS STEEL Ø30X1.5 90° BEND</td> <td>1</td> <td>PZ</td> </tr> <tr> <td>VM1794A0</td> <td>250X4.8 PA66 BLACK CLAMP</td> <td>3</td> <td>PZ</td> </tr> <tr> <td>VM1987A0</td> <td>OVEN STACKING BRACKET</td> <td>1</td> <td>PZ</td> </tr> <tr> <td>VM2035A0</td> <td>DRAIN PIPE SUPPORT</td> <td>2</td> <td>PZ</td> </tr> </tbody> </table>	Code	Description	Qty	UOM	RC1297A1	D10 T-SHAPED FITTING	1	PZ	RC1376A0	Ø6 Y-FITTING	1	PZ	TB1520A0	INT. Ø=38 TH=4 DRAIN BLACK RUBBER PIPE	5	M	TB1765A1	STACKING KIT CHIMNEY CONNECTING PIPE	2	PZ	TB2243A0	D10 PE TRANSPAREN T PIPE	1.500	M	VI1075A0	NUT M4 H=4 UNI5587 INOX	8	PZ	VI1220A1	4,2X12 TCB SELF-TAPPIN G SCREW	4	PZ	VI1895A0	BLIND NUT M4 STAINLESS STEEL DIN 917	8	PZ	VI1945A0	ENG-VITE M4X20 TCB+ INOX	8	PZ	VI1950A0	ST. STEEL 4,2X13 TCB SELF-DRILLIN G SCREW	26	PZ	VL1005A1	U-TRAP TANK COVER	2	PZ	VL1006A0	SYPHON COVER	2	PZ	VL1043A0	D4 PIPE HOLDER - D6 J.G. TERMINAL	3	PZ	VL1046A1	D6 PIPE HOLDER - D6 J.G. TERMINAL	3	PZ	VM1015A1	STAINLESS STEEL Ø30X1.5 90° BEND	1	PZ	VM1794A0	250X4.8 PA66 BLACK CLAMP	3	PZ	VM1987A0	OVEN STACKING BRACKET	1	PZ	VM2035A0	DRAIN PIPE SUPPORT	2	PZ	XC756	E SERIES GN 2/3 STACKING KIT	<table border="1"> <thead> <tr> <th>Code</th> <th>Description</th> <th>Qty</th> <th>UOM</th> </tr> </thead> <tbody> <tr> <td>0H6462A0</td> <td>XC756 FRONT PROFILE</td> <td>1</td> <td>PZ</td> </tr> <tr> <td>CE1305A0</td> <td>L=2MT RJ45 - RJ45 CABLE</td> <td>1</td> <td>PZ</td> </tr> </tbody> </table>	Code	Description	Qty	UOM	0H6462A0	XC756 FRONT PROFILE	1	PZ	CE1305A0	L=2MT RJ45 - RJ45 CABLE	1	PZ
			Code	Description	Qty	UOM																																																																																										
RC1297A1	D10 T-SHAPED FITTING	1	PZ																																																																																													
RC1376A0	Ø6 Y-FITTING	1	PZ																																																																																													
TB1520A0	INT. Ø=38 TH=4 DRAIN BLACK RUBBER PIPE	5	M																																																																																													
TB1765A1	STACKING KIT CHIMNEY CONNECTING PIPE	2	PZ																																																																																													
TB2243A0	D10 PE TRANSPAREN T PIPE	1.500	M																																																																																													
VI1075A0	NUT M4 H=4 UNI5587 INOX	8	PZ																																																																																													
VI1220A1	4,2X12 TCB SELF-TAPPIN G SCREW	4	PZ																																																																																													
VI1895A0	BLIND NUT M4 STAINLESS STEEL DIN 917	8	PZ																																																																																													
VI1945A0	ENG-VITE M4X20 TCB+ INOX	8	PZ																																																																																													
VI1950A0	ST. STEEL 4,2X13 TCB SELF-DRILLIN G SCREW	26	PZ																																																																																													
VL1005A1	U-TRAP TANK COVER	2	PZ																																																																																													
VL1006A0	SYPHON COVER	2	PZ																																																																																													
VL1043A0	D4 PIPE HOLDER - D6 J.G. TERMINAL	3	PZ																																																																																													
VL1046A1	D6 PIPE HOLDER - D6 J.G. TERMINAL	3	PZ																																																																																													
VM1015A1	STAINLESS STEEL Ø30X1.5 90° BEND	1	PZ																																																																																													
VM1794A0	250X4.8 PA66 BLACK CLAMP	3	PZ																																																																																													
VM1987A0	OVEN STACKING BRACKET	1	PZ																																																																																													
VM2035A0	DRAIN PIPE SUPPORT	2	PZ																																																																																													
Code	Description	Qty	UOM																																																																																													
0H6462A0	XC756 FRONT PROFILE	1	PZ																																																																																													
CE1305A0	L=2MT RJ45 - RJ45 CABLE	1	PZ																																																																																													

COMPONENT			SPARE PART																																																																																						
Code	Description	Image	Code	Description	Components list																																																																																				
VL1006A	SYPHON COVER		XC756	E SERIES GN 2/3 STACKING KIT	<table border="1"> <thead> <tr> <th>Code</th> <th>Description</th> <th>Qty</th> <th>UOM</th> </tr> </thead> <tbody> <tr> <td>ED1246A0</td> <td>HOT SURFACE LABEL</td> <td>1</td> <td>PZ</td> </tr> <tr> <td>ED1271A0</td> <td>LIQUID FALLS DANGER LABEL</td> <td>1</td> <td>PZ</td> </tr> <tr> <td>EL1020A1</td> <td>D8 INTERMEDIAT E T-SHAPED FITTING</td> <td>2</td> <td>PZ</td> </tr> <tr> <td>GN1508A0</td> <td>O-RING GASKET COD 2400</td> <td>2</td> <td>PZ</td> </tr> <tr> <td>PD1069A0</td> <td>FOOT OVERLAP S5 CT-BT-E</td> <td>1</td> <td>PZ</td> </tr> <tr> <td>RC1008A0</td> <td>D9 ELASTIC CLIP</td> <td>3</td> <td>PZ</td> </tr> <tr> <td>RC1055A0</td> <td>Ø25-40 H12 STAINLESS STEEL PIPE CLIP</td> <td>14</td> <td>PZ</td> </tr> <tr> <td>RC1130A0</td> <td>130X2,6 CLAM</td> <td>3</td> <td>PZ</td> </tr> <tr> <td>RC1297A1</td> <td>D10 T-SHAPED FITTING</td> <td>1</td> <td>PZ</td> </tr> <tr> <td>RC1376A0</td> <td>Ø6 Y-FITTING</td> <td>1</td> <td>PZ</td> </tr> <tr> <td>TB1520A0</td> <td>INT. Ø=38 TH=4 DRAIN BLACK RUBBER PIPE</td> <td>3</td> <td>M</td> </tr> <tr> <td>TB1765A1</td> <td>STACKING KIT CHIMNEY CONNECTING PIPE</td> <td>1</td> <td>PZ</td> </tr> <tr> <td>TB2243A0</td> <td>D10 PE TRANSPAREN T PIPE</td> <td>1.500</td> <td>M</td> </tr> <tr> <td>VI1075A0</td> <td>NUT M4 H=4 UNI5587 INOX</td> <td>8</td> <td>PZ</td> </tr> <tr> <td>VI1220A1</td> <td>4,2X12 TCB SELF-TAPPIN G SCREW</td> <td>4</td> <td>PZ</td> </tr> <tr> <td>VI1895A0</td> <td>BLIND NUT M4 STAINLESS STEEL DIN 917</td> <td>8</td> <td>PZ</td> </tr> <tr> <td>VI1945A0</td> <td>ENG-VITE M4X20 TCB+ INOX</td> <td>8</td> <td>PZ</td> </tr> <tr> <td>VI1950A0</td> <td>ST. STEEL 4,2X13 TCB SELF-DRILLIN G SCREW</td> <td>26</td> <td>PZ</td> </tr> <tr> <td>VL1005A1</td> <td>U-TRAP TANK</td> <td>2</td> <td>PZ</td> </tr> <tr> <td>VL1006A0</td> <td>SYPHON COVER</td> <td>2</td> <td>PZ</td> </tr> </tbody> </table>	Code	Description	Qty	UOM	ED1246A0	HOT SURFACE LABEL	1	PZ	ED1271A0	LIQUID FALLS DANGER LABEL	1	PZ	EL1020A1	D8 INTERMEDIAT E T-SHAPED FITTING	2	PZ	GN1508A0	O-RING GASKET COD 2400	2	PZ	PD1069A0	FOOT OVERLAP S5 CT-BT-E	1	PZ	RC1008A0	D9 ELASTIC CLIP	3	PZ	RC1055A0	Ø25-40 H12 STAINLESS STEEL PIPE CLIP	14	PZ	RC1130A0	130X2,6 CLAM	3	PZ	RC1297A1	D10 T-SHAPED FITTING	1	PZ	RC1376A0	Ø6 Y-FITTING	1	PZ	TB1520A0	INT. Ø=38 TH=4 DRAIN BLACK RUBBER PIPE	3	M	TB1765A1	STACKING KIT CHIMNEY CONNECTING PIPE	1	PZ	TB2243A0	D10 PE TRANSPAREN T PIPE	1.500	M	VI1075A0	NUT M4 H=4 UNI5587 INOX	8	PZ	VI1220A1	4,2X12 TCB SELF-TAPPIN G SCREW	4	PZ	VI1895A0	BLIND NUT M4 STAINLESS STEEL DIN 917	8	PZ	VI1945A0	ENG-VITE M4X20 TCB+ INOX	8	PZ	VI1950A0	ST. STEEL 4,2X13 TCB SELF-DRILLIN G SCREW	26	PZ	VL1005A1	U-TRAP TANK	2	PZ	VL1006A0	SYPHON COVER	2	PZ
Code	Description	Qty	UOM																																																																																						
ED1246A0	HOT SURFACE LABEL	1	PZ																																																																																						
ED1271A0	LIQUID FALLS DANGER LABEL	1	PZ																																																																																						
EL1020A1	D8 INTERMEDIAT E T-SHAPED FITTING	2	PZ																																																																																						
GN1508A0	O-RING GASKET COD 2400	2	PZ																																																																																						
PD1069A0	FOOT OVERLAP S5 CT-BT-E	1	PZ																																																																																						
RC1008A0	D9 ELASTIC CLIP	3	PZ																																																																																						
RC1055A0	Ø25-40 H12 STAINLESS STEEL PIPE CLIP	14	PZ																																																																																						
RC1130A0	130X2,6 CLAM	3	PZ																																																																																						
RC1297A1	D10 T-SHAPED FITTING	1	PZ																																																																																						
RC1376A0	Ø6 Y-FITTING	1	PZ																																																																																						
TB1520A0	INT. Ø=38 TH=4 DRAIN BLACK RUBBER PIPE	3	M																																																																																						
TB1765A1	STACKING KIT CHIMNEY CONNECTING PIPE	1	PZ																																																																																						
TB2243A0	D10 PE TRANSPAREN T PIPE	1.500	M																																																																																						
VI1075A0	NUT M4 H=4 UNI5587 INOX	8	PZ																																																																																						
VI1220A1	4,2X12 TCB SELF-TAPPIN G SCREW	4	PZ																																																																																						
VI1895A0	BLIND NUT M4 STAINLESS STEEL DIN 917	8	PZ																																																																																						
VI1945A0	ENG-VITE M4X20 TCB+ INOX	8	PZ																																																																																						
VI1950A0	ST. STEEL 4,2X13 TCB SELF-DRILLIN G SCREW	26	PZ																																																																																						
VL1005A1	U-TRAP TANK	2	PZ																																																																																						
VL1006A0	SYPHON COVER	2	PZ																																																																																						





COMPONENT			SPARE PART																																																											
Code	Description	Image	Code	Description	Components list																																																									
VL1006A	SYPHON COVER		XC756	E SERIES GN 2/3 STACKING KIT	<table border="1"> <thead> <tr> <th>Code</th> <th>Description</th> <th>Qty</th> <th>UOM</th> </tr> </thead> <tbody> <tr> <td>VL1043A0</td> <td>D4 PIPE HOLDER - D6 J.G. TERMINAL</td> <td>3</td> <td>PZ</td> </tr> <tr> <td>VL1046A1</td> <td>D6 PIPE HOLDER - D6 J.G. TERMINAL</td> <td>3</td> <td>PZ</td> </tr> <tr> <td>VM1015A1</td> <td>STAINLESS STEEL Ø30X1.5 90° BEND</td> <td>1</td> <td>PZ</td> </tr> <tr> <td>VM1794A0</td> <td>250X4.8 PA66 BLACK CLAMP</td> <td>3</td> <td>PZ</td> </tr> <tr> <td>VM1987A0</td> <td>OVEN STACKING BRACKET</td> <td>1</td> <td>PZ</td> </tr> <tr> <td>VM2035A0</td> <td>DRAIN PIPE SUPPORT</td> <td>1</td> <td>PZ</td> </tr> </tbody> </table>	Code	Description	Qty	UOM	VL1043A0	D4 PIPE HOLDER - D6 J.G. TERMINAL	3	PZ	VL1046A1	D6 PIPE HOLDER - D6 J.G. TERMINAL	3	PZ	VM1015A1	STAINLESS STEEL Ø30X1.5 90° BEND	1	PZ	VM1794A0	250X4.8 PA66 BLACK CLAMP	3	PZ	VM1987A0	OVEN STACKING BRACKET	1	PZ	VM2035A0	DRAIN PIPE SUPPORT	1	PZ																													
			Code	Description	Qty	UOM																																																								
VL1043A0	D4 PIPE HOLDER - D6 J.G. TERMINAL	3	PZ																																																											
VL1046A1	D6 PIPE HOLDER - D6 J.G. TERMINAL	3	PZ																																																											
VM1015A1	STAINLESS STEEL Ø30X1.5 90° BEND	1	PZ																																																											
VM1794A0	250X4.8 PA66 BLACK CLAMP	3	PZ																																																											
VM1987A0	OVEN STACKING BRACKET	1	PZ																																																											
VM2035A0	DRAIN PIPE SUPPORT	1	PZ																																																											
XC755	E SERIES BT-CT GN 2/1 STACKING KIT	<table border="1"> <thead> <tr> <th>Code</th> <th>Description</th> <th>Qty</th> <th>UOM</th> </tr> </thead> <tbody> <tr> <td>0H6461A0</td> <td>XC755 FRONT PROFILE</td> <td>1</td> <td>PZ</td> </tr> <tr> <td>CE1635A0</td> <td>RJ45 - RJ45 CABLE L=3M</td> <td>1</td> <td>PZ</td> </tr> <tr> <td>ED1246A0</td> <td>HOT SURFACE LABEL</td> <td>2</td> <td>PZ</td> </tr> <tr> <td>ED1271A0</td> <td>LIQUID FALLS DANGER LABE</td> <td>1</td> <td>PZ</td> </tr> <tr> <td>EL1020A1</td> <td>D8 INTERMEDIAT E T-SHAPED FITTING</td> <td>2</td> <td>PZ</td> </tr> <tr> <td>GN1508A0</td> <td>O-RING GASKET COD 2400</td> <td>2</td> <td>PZ</td> </tr> <tr> <td>PD1069A0</td> <td>FOOT OVERLAP S5 CT-BT-E</td> <td>1</td> <td>PZ</td> </tr> <tr> <td>RC1008A0</td> <td>D9 ELASTIC CLIP</td> <td>3</td> <td>PZ</td> </tr> <tr> <td>RC1055A0</td> <td>Ø25-40 H12 STAINLESS STEEL PIPE CLIP</td> <td>14</td> <td>PZ</td> </tr> <tr> <td>RC1130A0</td> <td>130X2,6 CLAM</td> <td>3</td> <td>PZ</td> </tr> <tr> <td>RC1297A1</td> <td>D10 T-SHAPED FITTING</td> <td>1</td> <td>PZ</td> </tr> <tr> <td>RC1376A0</td> <td>Ø6 Y-FITTING</td> <td>1</td> <td>PZ</td> </tr> <tr> <td>TB1520A0</td> <td>INT. Ø=38 TH=4 DRAIN BLACK RUBBER PIPE</td> <td>5</td> <td>M</td> </tr> <tr> <td>TB1765A1</td> <td>STACKING KIT CHIMNEY CONNECTING PIPE</td> <td>2</td> <td>PZ</td> </tr> </tbody> </table>	Code	Description	Qty	UOM	0H6461A0	XC755 FRONT PROFILE	1	PZ	CE1635A0	RJ45 - RJ45 CABLE L=3M	1	PZ	ED1246A0	HOT SURFACE LABEL	2	PZ	ED1271A0	LIQUID FALLS DANGER LABE	1	PZ	EL1020A1	D8 INTERMEDIAT E T-SHAPED FITTING	2	PZ	GN1508A0	O-RING GASKET COD 2400	2	PZ	PD1069A0	FOOT OVERLAP S5 CT-BT-E	1	PZ	RC1008A0	D9 ELASTIC CLIP	3	PZ	RC1055A0	Ø25-40 H12 STAINLESS STEEL PIPE CLIP	14	PZ	RC1130A0	130X2,6 CLAM	3	PZ	RC1297A1	D10 T-SHAPED FITTING	1	PZ	RC1376A0	Ø6 Y-FITTING	1	PZ	TB1520A0	INT. Ø=38 TH=4 DRAIN BLACK RUBBER PIPE	5	M	TB1765A1	STACKING KIT CHIMNEY CONNECTING PIPE	2	PZ
Code	Description	Qty	UOM																																																											
0H6461A0	XC755 FRONT PROFILE	1	PZ																																																											
CE1635A0	RJ45 - RJ45 CABLE L=3M	1	PZ																																																											
ED1246A0	HOT SURFACE LABEL	2	PZ																																																											
ED1271A0	LIQUID FALLS DANGER LABE	1	PZ																																																											
EL1020A1	D8 INTERMEDIAT E T-SHAPED FITTING	2	PZ																																																											
GN1508A0	O-RING GASKET COD 2400	2	PZ																																																											
PD1069A0	FOOT OVERLAP S5 CT-BT-E	1	PZ																																																											
RC1008A0	D9 ELASTIC CLIP	3	PZ																																																											
RC1055A0	Ø25-40 H12 STAINLESS STEEL PIPE CLIP	14	PZ																																																											
RC1130A0	130X2,6 CLAM	3	PZ																																																											
RC1297A1	D10 T-SHAPED FITTING	1	PZ																																																											
RC1376A0	Ø6 Y-FITTING	1	PZ																																																											
TB1520A0	INT. Ø=38 TH=4 DRAIN BLACK RUBBER PIPE	5	M																																																											
TB1765A1	STACKING KIT CHIMNEY CONNECTING PIPE	2	PZ																																																											

COMPONENT			SPARE PART																																																																																					
Code	Description	Image	Code	Description	Components list																																																																																			
VL1006A	SYPHON COVER		XC755	E SERIES BT-CT GN 2/1 STACKING KIT	<table border="1"> <thead> <tr> <th>Code</th> <th>Description</th> <th>Qty</th> <th>UOM</th> </tr> </thead> <tbody> <tr> <td>TB2243A0</td> <td>D10 PE TRANSPAREN T PIPE</td> <td>1.500</td> <td>M</td> </tr> <tr> <td>VI1075A0</td> <td>NUT M4 H=4 UNI5587 INOX</td> <td>8</td> <td>PZ</td> </tr> <tr> <td>VI1220A1</td> <td>4,2X12 TCB SELF-TAPPIN G SCREW</td> <td>4</td> <td>PZ</td> </tr> <tr> <td>VI1895A0</td> <td>BLIND NUT M4 STAINLESS STEEL DIN 917</td> <td>8</td> <td>PZ</td> </tr> <tr> <td>VI1945A0</td> <td>ENG-VITE M4X20 TCB+ INOX</td> <td>8</td> <td>PZ</td> </tr> <tr> <td>VI1950A0</td> <td>ST. STEEL 4,2X13 TCB SELF-DRILLIN G SCREW</td> <td>26</td> <td>PZ</td> </tr> <tr> <td>VL1005A1</td> <td>U-TRAP TANK</td> <td>2</td> <td>PZ</td> </tr> <tr> <td>VL1006A0</td> <td>SYPHON COVER</td> <td>2</td> <td>PZ</td> </tr> <tr> <td>VL1043A0</td> <td>D4 PIPE HOLDER - D6 J.G. TERMINAL</td> <td>3</td> <td>PZ</td> </tr> <tr> <td>VL1046A1</td> <td>D6 PIPE HOLDER - D6 J.G. TERMINAL</td> <td>3</td> <td>PZ</td> </tr> <tr> <td>VM1015A1</td> <td>STAINLESS STEEL Ø30X1,5 90° BEND</td> <td>1</td> <td>PZ</td> </tr> <tr> <td>VM1794A0</td> <td>250X4.8 PA66 BLACK CLAMP</td> <td>3</td> <td>PZ</td> </tr> <tr> <td>VM1987A0</td> <td>OVEN STACKING BRACKET</td> <td>1</td> <td>PZ</td> </tr> <tr> <td>VM2035A0</td> <td>DRAIN PIPE SUPPORT</td> <td>2</td> <td>PZ</td> </tr> </tbody> </table>	Code	Description	Qty	UOM	TB2243A0	D10 PE TRANSPAREN T PIPE	1.500	M	VI1075A0	NUT M4 H=4 UNI5587 INOX	8	PZ	VI1220A1	4,2X12 TCB SELF-TAPPIN G SCREW	4	PZ	VI1895A0	BLIND NUT M4 STAINLESS STEEL DIN 917	8	PZ	VI1945A0	ENG-VITE M4X20 TCB+ INOX	8	PZ	VI1950A0	ST. STEEL 4,2X13 TCB SELF-DRILLIN G SCREW	26	PZ	VL1005A1	U-TRAP TANK	2	PZ	VL1006A0	SYPHON COVER	2	PZ	VL1043A0	D4 PIPE HOLDER - D6 J.G. TERMINAL	3	PZ	VL1046A1	D6 PIPE HOLDER - D6 J.G. TERMINAL	3	PZ	VM1015A1	STAINLESS STEEL Ø30X1,5 90° BEND	1	PZ	VM1794A0	250X4.8 PA66 BLACK CLAMP	3	PZ	VM1987A0	OVEN STACKING BRACKET	1	PZ	VM2035A0	DRAIN PIPE SUPPORT	2	PZ	XC699	LINEMISS TOP FIRST INSTALLATION KIT	<table border="1"> <thead> <tr> <th>Code</th> <th>Description</th> <th>Qty</th> <th>UOM</th> </tr> </thead> <tbody> <tr> <td>0H1237A0</td> <td>LM TOP SIPHON SUPPORT</td> <td>1</td> <td>PZ</td> </tr> <tr> <td>GN1508A0</td> <td>O-RING GASKET COD 2400</td> <td>1</td> <td>PZ</td> </tr> <tr> <td>RC1055A0</td> <td>Ø25-40 H12 STAINLESS STEEL PIPE CLIP</td> <td>4</td> <td>PZ</td> </tr> <tr> <td>TB1520A0</td> <td>INT. Ø=38 TH=4 DRAIN BLACK RUBBER PIPE</td> <td>2.500</td> <td>M</td> </tr> </tbody> </table>	Code	Description	Qty	UOM	0H1237A0	LM TOP SIPHON SUPPORT	1	PZ	GN1508A0	O-RING GASKET COD 2400	1	PZ	RC1055A0	Ø25-40 H12 STAINLESS STEEL PIPE CLIP	4	PZ	TB1520A0	INT. Ø=38 TH=4 DRAIN BLACK RUBBER PIPE	2.500	M
			Code	Description	Qty	UOM																																																																																		
TB2243A0	D10 PE TRANSPAREN T PIPE	1.500	M																																																																																					
VI1075A0	NUT M4 H=4 UNI5587 INOX	8	PZ																																																																																					
VI1220A1	4,2X12 TCB SELF-TAPPIN G SCREW	4	PZ																																																																																					
VI1895A0	BLIND NUT M4 STAINLESS STEEL DIN 917	8	PZ																																																																																					
VI1945A0	ENG-VITE M4X20 TCB+ INOX	8	PZ																																																																																					
VI1950A0	ST. STEEL 4,2X13 TCB SELF-DRILLIN G SCREW	26	PZ																																																																																					
VL1005A1	U-TRAP TANK	2	PZ																																																																																					
VL1006A0	SYPHON COVER	2	PZ																																																																																					
VL1043A0	D4 PIPE HOLDER - D6 J.G. TERMINAL	3	PZ																																																																																					
VL1046A1	D6 PIPE HOLDER - D6 J.G. TERMINAL	3	PZ																																																																																					
VM1015A1	STAINLESS STEEL Ø30X1,5 90° BEND	1	PZ																																																																																					
VM1794A0	250X4.8 PA66 BLACK CLAMP	3	PZ																																																																																					
VM1987A0	OVEN STACKING BRACKET	1	PZ																																																																																					
VM2035A0	DRAIN PIPE SUPPORT	2	PZ																																																																																					
Code	Description	Qty	UOM																																																																																					
0H1237A0	LM TOP SIPHON SUPPORT	1	PZ																																																																																					
GN1508A0	O-RING GASKET COD 2400	1	PZ																																																																																					
RC1055A0	Ø25-40 H12 STAINLESS STEEL PIPE CLIP	4	PZ																																																																																					
TB1520A0	INT. Ø=38 TH=4 DRAIN BLACK RUBBER PIPE	2.500	M																																																																																					





COMPONENT			SPARE PART																																											
Code	Description	Image	Code	Description	Components list																																									
VL1006A	SYPHON COVER		XC699	LINEMISS TOP FIRST INSTALLATION KIT	<table border="1"> <thead> <tr> <th>Code</th> <th>Description</th> <th>Qty</th> <th>UOM</th> </tr> </thead> <tbody> <tr> <td>VI1075A0</td> <td>NUT M4 H=4 UNI5587 INOX</td> <td>4</td> <td>PZ</td> </tr> <tr> <td>VI1220A1</td> <td>4,2X12 TCB SELF-TAPPIN G SCREW</td> <td>2</td> <td>PZ</td> </tr> <tr> <td>VI1895A0</td> <td>BLIND NUT M4 STAINLESS STEEL DIN 917</td> <td>4</td> <td>PZ</td> </tr> <tr> <td>VI1945A0</td> <td>ENG-VITE M4X20 TCB+ INOX</td> <td>4</td> <td>PZ</td> </tr> <tr> <td>VI1950A0</td> <td>ST. STEEL 4,2X13 TCB SELF-DRILLIN G SCREW</td> <td>2</td> <td>PZ</td> </tr> <tr> <td>VL1005A1</td> <td>U-TRAP TANK</td> <td>1</td> <td>PZ</td> </tr> <tr> <td>VL1006A0</td> <td>SYPHON COVER</td> <td>1</td> <td>PZ</td> </tr> <tr> <td>VM1015A1</td> <td>STAINLESS STEEL Ø30X1,5 90° BEND</td> <td>1</td> <td>PZ</td> </tr> </tbody> </table>	Code	Description	Qty	UOM	VI1075A0	NUT M4 H=4 UNI5587 INOX	4	PZ	VI1220A1	4,2X12 TCB SELF-TAPPIN G SCREW	2	PZ	VI1895A0	BLIND NUT M4 STAINLESS STEEL DIN 917	4	PZ	VI1945A0	ENG-VITE M4X20 TCB+ INOX	4	PZ	VI1950A0	ST. STEEL 4,2X13 TCB SELF-DRILLIN G SCREW	2	PZ	VL1005A1	U-TRAP TANK	1	PZ	VL1006A0	SYPHON COVER	1	PZ	VM1015A1	STAINLESS STEEL Ø30X1,5 90° BEND	1	PZ					
			Code	Description	Qty	UOM																																								
VI1075A0	NUT M4 H=4 UNI5587 INOX	4	PZ																																											
VI1220A1	4,2X12 TCB SELF-TAPPIN G SCREW	2	PZ																																											
VI1895A0	BLIND NUT M4 STAINLESS STEEL DIN 917	4	PZ																																											
VI1945A0	ENG-VITE M4X20 TCB+ INOX	4	PZ																																											
VI1950A0	ST. STEEL 4,2X13 TCB SELF-DRILLIN G SCREW	2	PZ																																											
VL1005A1	U-TRAP TANK	1	PZ																																											
VL1006A0	SYPHON COVER	1	PZ																																											
VM1015A1	STAINLESS STEEL Ø30X1,5 90° BEND	1	PZ																																											
XC673	COMPLETE P-TRAP KIT	<table border="1"> <thead> <tr> <th>Code</th> <th>Description</th> <th>Qty</th> <th>UOM</th> </tr> </thead> <tbody> <tr> <td>GN1508A0</td> <td>O-RING GASKET COD 2400</td> <td>1</td> <td>PZ</td> </tr> <tr> <td>RC1055A0</td> <td>Ø25-40 H12 STAINLESS STEEL PIPE CLIP</td> <td>2</td> <td>PZ</td> </tr> <tr> <td>TB1520A0</td> <td>INT. Ø=38 TH=4 DRAIN BLACK RUBBER PIPE</td> <td>0.050</td> <td>M</td> </tr> <tr> <td>VI1075A0</td> <td>NUT M4 H=4 UNI5587 INOX</td> <td>4</td> <td>PZ</td> </tr> <tr> <td>VI1220A1</td> <td>4,2X12 TCB SELF-TAPPIN G SCREW</td> <td>2</td> <td>PZ</td> </tr> <tr> <td>VI1895A0</td> <td>BLIND NUT M4 STAINLESS STEEL DIN 917</td> <td>4</td> <td>PZ</td> </tr> <tr> <td>VI1945A0</td> <td>ENG-VITE M4X20 TCB+ INOX</td> <td>4</td> <td>PZ</td> </tr> <tr> <td>VI1950A0</td> <td>ST. STEEL 4,2X13 TCB SELF-DRILLIN G SCREW</td> <td>2</td> <td>PZ</td> </tr> <tr> <td>VL1005A1</td> <td>U-TRAP TANK</td> <td>1</td> <td>PZ</td> </tr> <tr> <td>VL1006A0</td> <td>SYPHON COVER</td> <td>1</td> <td>PZ</td> </tr> </tbody> </table>	Code	Description	Qty	UOM	GN1508A0	O-RING GASKET COD 2400	1	PZ	RC1055A0	Ø25-40 H12 STAINLESS STEEL PIPE CLIP	2	PZ	TB1520A0	INT. Ø=38 TH=4 DRAIN BLACK RUBBER PIPE	0.050	M	VI1075A0	NUT M4 H=4 UNI5587 INOX	4	PZ	VI1220A1	4,2X12 TCB SELF-TAPPIN G SCREW	2	PZ	VI1895A0	BLIND NUT M4 STAINLESS STEEL DIN 917	4	PZ	VI1945A0	ENG-VITE M4X20 TCB+ INOX	4	PZ	VI1950A0	ST. STEEL 4,2X13 TCB SELF-DRILLIN G SCREW	2	PZ	VL1005A1	U-TRAP TANK	1	PZ	VL1006A0	SYPHON COVER	1	PZ
Code	Description	Qty	UOM																																											
GN1508A0	O-RING GASKET COD 2400	1	PZ																																											
RC1055A0	Ø25-40 H12 STAINLESS STEEL PIPE CLIP	2	PZ																																											
TB1520A0	INT. Ø=38 TH=4 DRAIN BLACK RUBBER PIPE	0.050	M																																											
VI1075A0	NUT M4 H=4 UNI5587 INOX	4	PZ																																											
VI1220A1	4,2X12 TCB SELF-TAPPIN G SCREW	2	PZ																																											
VI1895A0	BLIND NUT M4 STAINLESS STEEL DIN 917	4	PZ																																											
VI1945A0	ENG-VITE M4X20 TCB+ INOX	4	PZ																																											
VI1950A0	ST. STEEL 4,2X13 TCB SELF-DRILLIN G SCREW	2	PZ																																											
VL1005A1	U-TRAP TANK	1	PZ																																											
VL1006A0	SYPHON COVER	1	PZ																																											

COMPONENT			SPARE PART																																																																																		
Code	Description	Image	Code	Description	Components list																																																																																
VL1006A	SYPHON COVER		XC653	LINEMISSTOP XFT140 STACKING KIT	<table border="1"> <thead> <tr> <th>Code</th> <th>Description</th> <th>Qty</th> <th>UOM</th> </tr> </thead> <tbody> <tr> <td>0H1237A0</td> <td>LM TOP SIPHON SUPPORT</td> <td>2</td> <td>PZ</td> </tr> <tr> <td>0H7084A0</td> <td>XC651 FRONT STACKING PROFILE</td> <td>1</td> <td>PZ</td> </tr> <tr> <td>0H7085A0</td> <td>LM 600 XC STACKING KIT BACK PROFIL</td> <td>2</td> <td>PZ</td> </tr> <tr> <td>ED1246A0</td> <td>HOT SURFACE LABEL</td> <td>1</td> <td>PZ</td> </tr> <tr> <td>ED1271A0</td> <td>LIQUID FALLS DANGER LABE</td> <td>1</td> <td>PZ</td> </tr> <tr> <td>EL1020A1</td> <td>D8 INTERMEDIAT E T-SHAPED FITTING</td> <td>2</td> <td>PZ</td> </tr> <tr> <td>EL1180A0</td> <td>Ø8-Ø8 FEMALE NON-RETURN CONNECTION</td> <td>2</td> <td>PZ</td> </tr> <tr> <td>GN1508A0</td> <td>O-RING GASKET COD 2400</td> <td>2</td> <td>PZ</td> </tr> <tr> <td>RC1008A0</td> <td>D9 ELASTIC CLIP</td> <td>7</td> <td>PZ</td> </tr> <tr> <td>RC1055A0</td> <td>Ø25-40 H12 STAINLESS STEEL PIPE CLIP</td> <td>10</td> <td>PZ</td> </tr> <tr> <td>RC1297A1</td> <td>D10 T-SHAPED FITTING</td> <td>1</td> <td>PZ</td> </tr> <tr> <td>RC1360A0</td> <td>10 - 10 JG ELBOW FITTIN</td> <td>1</td> <td>PZ</td> </tr> <tr> <td>RC1376A0</td> <td>Ø6 Y-FITTING</td> <td>1</td> <td>PZ</td> </tr> <tr> <td>TB1177A0</td> <td>FOOT PANEL 40X40 H58 OVERLAP LM</td> <td>4</td> <td>PZ</td> </tr> <tr> <td>TB1520A0</td> <td>INT. Ø=38 TH=4 DRAIN BLACK RUBBER PIPE</td> <td>2.700</td> <td>M</td> </tr> <tr> <td>TB1815A0</td> <td>7,93X4,75 PE TRANSP. PIPE (JG #PE08100N)</td> <td>2</td> <td>M</td> </tr> <tr> <td>TB2243A0</td> <td>D10 PE TRANSPAREN T PIPE</td> <td>1.500</td> <td>M</td> </tr> <tr> <td>VI1075A0</td> <td>NUT M4 H=4 UNI5587 INOX</td> <td>8</td> <td>PZ</td> </tr> <tr> <td>VI1220A1</td> <td>4,2X12 TCB SELF-TAPPIN G SCREW</td> <td>16</td> <td>PZ</td> </tr> </tbody> </table>	Code	Description	Qty	UOM	0H1237A0	LM TOP SIPHON SUPPORT	2	PZ	0H7084A0	XC651 FRONT STACKING PROFILE	1	PZ	0H7085A0	LM 600 XC STACKING KIT BACK PROFIL	2	PZ	ED1246A0	HOT SURFACE LABEL	1	PZ	ED1271A0	LIQUID FALLS DANGER LABE	1	PZ	EL1020A1	D8 INTERMEDIAT E T-SHAPED FITTING	2	PZ	EL1180A0	Ø8-Ø8 FEMALE NON-RETURN CONNECTION	2	PZ	GN1508A0	O-RING GASKET COD 2400	2	PZ	RC1008A0	D9 ELASTIC CLIP	7	PZ	RC1055A0	Ø25-40 H12 STAINLESS STEEL PIPE CLIP	10	PZ	RC1297A1	D10 T-SHAPED FITTING	1	PZ	RC1360A0	10 - 10 JG ELBOW FITTIN	1	PZ	RC1376A0	Ø6 Y-FITTING	1	PZ	TB1177A0	FOOT PANEL 40X40 H58 OVERLAP LM	4	PZ	TB1520A0	INT. Ø=38 TH=4 DRAIN BLACK RUBBER PIPE	2.700	M	TB1815A0	7,93X4,75 PE TRANSP. PIPE (JG #PE08100N)	2	M	TB2243A0	D10 PE TRANSPAREN T PIPE	1.500	M	VI1075A0	NUT M4 H=4 UNI5587 INOX	8	PZ	VI1220A1	4,2X12 TCB SELF-TAPPIN G SCREW	16	PZ
Code	Description	Qty	UOM																																																																																		
0H1237A0	LM TOP SIPHON SUPPORT	2	PZ																																																																																		
0H7084A0	XC651 FRONT STACKING PROFILE	1	PZ																																																																																		
0H7085A0	LM 600 XC STACKING KIT BACK PROFIL	2	PZ																																																																																		
ED1246A0	HOT SURFACE LABEL	1	PZ																																																																																		
ED1271A0	LIQUID FALLS DANGER LABE	1	PZ																																																																																		
EL1020A1	D8 INTERMEDIAT E T-SHAPED FITTING	2	PZ																																																																																		
EL1180A0	Ø8-Ø8 FEMALE NON-RETURN CONNECTION	2	PZ																																																																																		
GN1508A0	O-RING GASKET COD 2400	2	PZ																																																																																		
RC1008A0	D9 ELASTIC CLIP	7	PZ																																																																																		
RC1055A0	Ø25-40 H12 STAINLESS STEEL PIPE CLIP	10	PZ																																																																																		
RC1297A1	D10 T-SHAPED FITTING	1	PZ																																																																																		
RC1360A0	10 - 10 JG ELBOW FITTIN	1	PZ																																																																																		
RC1376A0	Ø6 Y-FITTING	1	PZ																																																																																		
TB1177A0	FOOT PANEL 40X40 H58 OVERLAP LM	4	PZ																																																																																		
TB1520A0	INT. Ø=38 TH=4 DRAIN BLACK RUBBER PIPE	2.700	M																																																																																		
TB1815A0	7,93X4,75 PE TRANSP. PIPE (JG #PE08100N)	2	M																																																																																		
TB2243A0	D10 PE TRANSPAREN T PIPE	1.500	M																																																																																		
VI1075A0	NUT M4 H=4 UNI5587 INOX	8	PZ																																																																																		
VI1220A1	4,2X12 TCB SELF-TAPPIN G SCREW	16	PZ																																																																																		





COMPONENT			SPARE PART																																														
Code	Description	Image	Code	Description	Components list																																												
VL1006A	SYPHON COVER		XC653	LINEMISSTOP XFT140 STACKING KIT	<table border="1"> <thead> <tr> <th>Code</th> <th>Description</th> <th>Qty</th> <th>UOM</th> </tr> </thead> <tbody> <tr> <td>VI1895A0</td> <td>BLIND NUT M4 STAINLESS STEEL DIN 917</td> <td>8</td> <td>PZ</td> </tr> <tr> <td>VI1945A0</td> <td>ENG-VITE M4X20 TCB+ INOX</td> <td>8</td> <td>PZ</td> </tr> <tr> <td>VI1950A0</td> <td>ST. STEEL 4,2X13 TCB SELF-DRILLIN G SCREW</td> <td>10</td> <td>PZ</td> </tr> <tr> <td>VL1005A1</td> <td>U-TRAP TANK</td> <td>2</td> <td>PZ</td> </tr> <tr> <td>VL1006A0</td> <td>SYPHON COVER</td> <td>2</td> <td>PZ</td> </tr> <tr> <td>VL1046A1</td> <td>D6 PIPE HOLDER - D6 J.G. TERMINAL</td> <td>6</td> <td>PZ</td> </tr> <tr> <td>VL1047A1</td> <td>D6 PIPE HOLDER - D8 J.G. TERMINAL</td> <td>2</td> <td>PZ</td> </tr> <tr> <td>VM1015A1</td> <td>STAINLESS STEEL Ø30X1.5 90° BEND</td> <td>1</td> <td>PZ</td> </tr> <tr> <td>VM1794A0</td> <td>250X4.8 PA66 BLACK CLAMP</td> <td>2</td> <td>PZ</td> </tr> <tr> <td>VM2035A0</td> <td>DRAIN PIPE SUPPORT</td> <td>1</td> <td>PZ</td> </tr> </tbody> </table>	Code	Description	Qty	UOM	VI1895A0	BLIND NUT M4 STAINLESS STEEL DIN 917	8	PZ	VI1945A0	ENG-VITE M4X20 TCB+ INOX	8	PZ	VI1950A0	ST. STEEL 4,2X13 TCB SELF-DRILLIN G SCREW	10	PZ	VL1005A1	U-TRAP TANK	2	PZ	VL1006A0	SYPHON COVER	2	PZ	VL1046A1	D6 PIPE HOLDER - D6 J.G. TERMINAL	6	PZ	VL1047A1	D6 PIPE HOLDER - D8 J.G. TERMINAL	2	PZ	VM1015A1	STAINLESS STEEL Ø30X1.5 90° BEND	1	PZ	VM1794A0	250X4.8 PA66 BLACK CLAMP	2	PZ	VM2035A0	DRAIN PIPE SUPPORT	1	PZ
			Code	Description	Qty	UOM																																											
VI1895A0	BLIND NUT M4 STAINLESS STEEL DIN 917	8	PZ																																														
VI1945A0	ENG-VITE M4X20 TCB+ INOX	8	PZ																																														
VI1950A0	ST. STEEL 4,2X13 TCB SELF-DRILLIN G SCREW	10	PZ																																														
VL1005A1	U-TRAP TANK	2	PZ																																														
VL1006A0	SYPHON COVER	2	PZ																																														
VL1046A1	D6 PIPE HOLDER - D6 J.G. TERMINAL	6	PZ																																														
VL1047A1	D6 PIPE HOLDER - D8 J.G. TERMINAL	2	PZ																																														
VM1015A1	STAINLESS STEEL Ø30X1.5 90° BEND	1	PZ																																														
VM1794A0	250X4.8 PA66 BLACK CLAMP	2	PZ																																														
VM2035A0	DRAIN PIPE SUPPORT	1	PZ																																														
XC649	LINEMISS TOP FULL SIZE STACKING KIT	<table border="1"> <thead> <tr> <th>Code</th> <th>Description</th> <th>Qty</th> <th>UOM</th> </tr> </thead> <tbody> <tr> <td>0H1151A0</td> <td>PROOFER-OV EN FIXING BRACKET</td> <td>4</td> <td>PZ</td> </tr> <tr> <td>0H1237A0</td> <td>LM TOP SIPHON SUPPORT</td> <td>2</td> <td>PZ</td> </tr> <tr> <td>ED1335A0</td> <td>CAUTION HOT TRIANGLE LABEL</td> <td>1</td> <td>PZ</td> </tr> <tr> <td>ED1338A0</td> <td>UL LIQUID FALLS DANGER LABE</td> <td>1</td> <td>PZ</td> </tr> <tr> <td>EL1020A1</td> <td>D8 INTERMEDIAT E T-SHAPED FITTING</td> <td>2</td> <td>PZ</td> </tr> <tr> <td>EL1185A0</td> <td>Ø8F - Ø8F ELBOW CONNECTION</td> <td>2</td> <td>PZ</td> </tr> <tr> <td>GN1508A0</td> <td>O-RING GASKET COD 2400</td> <td>2</td> <td>PZ</td> </tr> <tr> <td>RC1008A0</td> <td>D9 ELASTIC CLIP</td> <td>3</td> <td>PZ</td> </tr> </tbody> </table>	Code	Description	Qty	UOM	0H1151A0	PROOFER-OV EN FIXING BRACKET	4	PZ	0H1237A0	LM TOP SIPHON SUPPORT	2	PZ	ED1335A0	CAUTION HOT TRIANGLE LABEL	1	PZ	ED1338A0	UL LIQUID FALLS DANGER LABE	1	PZ	EL1020A1	D8 INTERMEDIAT E T-SHAPED FITTING	2	PZ	EL1185A0	Ø8F - Ø8F ELBOW CONNECTION	2	PZ	GN1508A0	O-RING GASKET COD 2400	2	PZ	RC1008A0	D9 ELASTIC CLIP	3	PZ											
Code	Description	Qty	UOM																																														
0H1151A0	PROOFER-OV EN FIXING BRACKET	4	PZ																																														
0H1237A0	LM TOP SIPHON SUPPORT	2	PZ																																														
ED1335A0	CAUTION HOT TRIANGLE LABEL	1	PZ																																														
ED1338A0	UL LIQUID FALLS DANGER LABE	1	PZ																																														
EL1020A1	D8 INTERMEDIAT E T-SHAPED FITTING	2	PZ																																														
EL1185A0	Ø8F - Ø8F ELBOW CONNECTION	2	PZ																																														
GN1508A0	O-RING GASKET COD 2400	2	PZ																																														
RC1008A0	D9 ELASTIC CLIP	3	PZ																																														

COMPONENT			SPARE PART																																																																																									
Code	Description	Image	Code	Description	Components list																																																																																							
VL1006A	SYPHON COVER		XC649	LINEMISS TOP FULL SIZE STACKING KIT	<table border="1"> <thead> <tr> <th>Code</th> <th>Description</th> <th>Qty</th> <th>UOM</th> </tr> </thead> <tbody> <tr> <td>RC1055A0</td> <td>Ø25-40 H12 STAINLESS STEEL PIPE CLIP</td> <td>8</td> <td>PZ</td> </tr> <tr> <td>RC1297A1</td> <td>D10 T-SHAPED FITTING</td> <td>1</td> <td>PZ</td> </tr> <tr> <td>RC1360A0</td> <td>10 - 10 JG ELBOW FITTING</td> <td>1</td> <td>PZ</td> </tr> <tr> <td>RC1376A0</td> <td>Ø6 Y-FITTING</td> <td>1</td> <td>PZ</td> </tr> <tr> <td>TB1520A0</td> <td>INT. Ø=38 TH=4 DRAIN BLACK RUBBER PIPE</td> <td>2.840</td> <td>M</td> </tr> <tr> <td>TB1815A0</td> <td>7,93X4,75 PE TRANSP. PIPE (JG #PE08100N)</td> <td>2</td> <td>M</td> </tr> <tr> <td>TB2243A0</td> <td>D10 PE TRANSPAREN T PIPE</td> <td>1.500</td> <td>M</td> </tr> <tr> <td>VI1075A0</td> <td>NUT M4 H=4 UNI5587 INOX</td> <td>8</td> <td>PZ</td> </tr> <tr> <td>VI1220A1</td> <td>4,2X12 TCB SELF-TAPPING SCREW</td> <td>7</td> <td>PZ</td> </tr> <tr> <td>VI1895A0</td> <td>BLIND NUT M4 STAINLESS STEEL DIN 917</td> <td>8</td> <td>PZ</td> </tr> <tr> <td>VI1945A0</td> <td>ENG-VITE M4X20 TCB+ INOX</td> <td>8</td> <td>PZ</td> </tr> <tr> <td>VI1950A0</td> <td>ST. STEEL 4,2X13 TCB SELF-DRILLING SCREW</td> <td>6</td> <td>PZ</td> </tr> <tr> <td>VL1005A1</td> <td>U-TRAP TANK COVER</td> <td>2</td> <td>PZ</td> </tr> <tr> <td>VL1006A0</td> <td>SYPHON COVER</td> <td>2</td> <td>PZ</td> </tr> <tr> <td>VL1046A1</td> <td>D6 PIPE HOLDER - D6 J.G. TERMINAL</td> <td>3</td> <td>PZ</td> </tr> <tr> <td>VM1794A0</td> <td>250X4.8 PA66 BLACK CLAMP</td> <td>2</td> <td>PZ</td> </tr> <tr> <td>VM2035A0</td> <td>DRAIN PIPE SUPPORT</td> <td>1</td> <td>PZ</td> </tr> </tbody> </table>	Code	Description	Qty	UOM	RC1055A0	Ø25-40 H12 STAINLESS STEEL PIPE CLIP	8	PZ	RC1297A1	D10 T-SHAPED FITTING	1	PZ	RC1360A0	10 - 10 JG ELBOW FITTING	1	PZ	RC1376A0	Ø6 Y-FITTING	1	PZ	TB1520A0	INT. Ø=38 TH=4 DRAIN BLACK RUBBER PIPE	2.840	M	TB1815A0	7,93X4,75 PE TRANSP. PIPE (JG #PE08100N)	2	M	TB2243A0	D10 PE TRANSPAREN T PIPE	1.500	M	VI1075A0	NUT M4 H=4 UNI5587 INOX	8	PZ	VI1220A1	4,2X12 TCB SELF-TAPPING SCREW	7	PZ	VI1895A0	BLIND NUT M4 STAINLESS STEEL DIN 917	8	PZ	VI1945A0	ENG-VITE M4X20 TCB+ INOX	8	PZ	VI1950A0	ST. STEEL 4,2X13 TCB SELF-DRILLING SCREW	6	PZ	VL1005A1	U-TRAP TANK COVER	2	PZ	VL1006A0	SYPHON COVER	2	PZ	VL1046A1	D6 PIPE HOLDER - D6 J.G. TERMINAL	3	PZ	VM1794A0	250X4.8 PA66 BLACK CLAMP	2	PZ	VM2035A0	DRAIN PIPE SUPPORT	1	PZ	XC648	LINEMISS TOP XFT200 STACKING KIT	<table border="1"> <thead> <tr> <th>Code</th> <th>Description</th> <th>Qty</th> <th>UOM</th> </tr> </thead> <tbody> <tr> <td>0H1237A0</td> <td>LM TOP SIPHON SUPPORT</td> <td>2</td> <td>PZ</td> </tr> <tr> <td>0H7082A0</td> <td>LM 800 XC STACKING KIT FRONT PROFILE</td> <td>1</td> <td>PZ</td> </tr> </tbody> </table>	Code	Description	Qty	UOM	0H1237A0	LM TOP SIPHON SUPPORT	2	PZ	0H7082A0	LM 800 XC STACKING KIT FRONT PROFILE	1	PZ
			Code	Description	Qty	UOM																																																																																						
RC1055A0	Ø25-40 H12 STAINLESS STEEL PIPE CLIP	8	PZ																																																																																									
RC1297A1	D10 T-SHAPED FITTING	1	PZ																																																																																									
RC1360A0	10 - 10 JG ELBOW FITTING	1	PZ																																																																																									
RC1376A0	Ø6 Y-FITTING	1	PZ																																																																																									
TB1520A0	INT. Ø=38 TH=4 DRAIN BLACK RUBBER PIPE	2.840	M																																																																																									
TB1815A0	7,93X4,75 PE TRANSP. PIPE (JG #PE08100N)	2	M																																																																																									
TB2243A0	D10 PE TRANSPAREN T PIPE	1.500	M																																																																																									
VI1075A0	NUT M4 H=4 UNI5587 INOX	8	PZ																																																																																									
VI1220A1	4,2X12 TCB SELF-TAPPING SCREW	7	PZ																																																																																									
VI1895A0	BLIND NUT M4 STAINLESS STEEL DIN 917	8	PZ																																																																																									
VI1945A0	ENG-VITE M4X20 TCB+ INOX	8	PZ																																																																																									
VI1950A0	ST. STEEL 4,2X13 TCB SELF-DRILLING SCREW	6	PZ																																																																																									
VL1005A1	U-TRAP TANK COVER	2	PZ																																																																																									
VL1006A0	SYPHON COVER	2	PZ																																																																																									
VL1046A1	D6 PIPE HOLDER - D6 J.G. TERMINAL	3	PZ																																																																																									
VM1794A0	250X4.8 PA66 BLACK CLAMP	2	PZ																																																																																									
VM2035A0	DRAIN PIPE SUPPORT	1	PZ																																																																																									
Code	Description	Qty	UOM																																																																																									
0H1237A0	LM TOP SIPHON SUPPORT	2	PZ																																																																																									
0H7082A0	LM 800 XC STACKING KIT FRONT PROFILE	1	PZ																																																																																									



COMPONENT			SPARE PART																																																																																		
Code	Description	Image	Code	Description	Components list																																																																																
VL1006A	SYPHON COVER		XC648	LINEMISS TOP XFT200 STACKING KIT	<table border="1"> <thead> <tr> <th>Code</th> <th>Description</th> <th>Qty</th> <th>UOM</th> </tr> </thead> <tbody> <tr> <td>0H7083A0</td> <td>LM 800 XC STACKING KIT BACK PROFIL</td> <td>2</td> <td>PZ</td> </tr> <tr> <td>ED1246A0</td> <td>HOT SURFACE LABEL</td> <td>1</td> <td>PZ</td> </tr> <tr> <td>ED1271A0</td> <td>LIQUID FALLS DANGER LABE</td> <td>1</td> <td>PZ</td> </tr> <tr> <td>EL1020A1</td> <td>D8 INTERMEDIAT E T-SHAPED FITTING</td> <td>2</td> <td>PZ</td> </tr> <tr> <td>EL1180A0</td> <td>Ø8-Ø8 FEMALE NON-RETURN CONNECTION</td> <td>2</td> <td>PZ</td> </tr> <tr> <td>GN1508A0</td> <td>O-RING GASKET COD 2400</td> <td>2</td> <td>PZ</td> </tr> <tr> <td>RC1008A0</td> <td>D9 ELASTIC CLIP</td> <td>7</td> <td>PZ</td> </tr> <tr> <td>RC1055A0</td> <td>Ø25-40 H12 STAINLESS STEEL PIPE CLIP</td> <td>10</td> <td>PZ</td> </tr> <tr> <td>RC1297A1</td> <td>D10 T-SHAPED FITTING</td> <td>1</td> <td>PZ</td> </tr> <tr> <td>RC1360A0</td> <td>10 - 10 JG ELBOW FITTIN</td> <td>1</td> <td>PZ</td> </tr> <tr> <td>RC1376A0</td> <td>Ø6 Y-FITTING</td> <td>1</td> <td>PZ</td> </tr> <tr> <td>TB1177A0</td> <td>FOOT PANEL 40X40 H58 OVERLAP LM</td> <td>4</td> <td>PZ</td> </tr> <tr> <td>TB1520A0</td> <td>INT. Ø=38 TH=4 DRAIN BLACK RUBBER PIPE</td> <td>2.700</td> <td>M</td> </tr> <tr> <td>TB1815A0</td> <td>7,93X4,75 PE TRANSP. PIPE (JG #PE08100N)</td> <td>2</td> <td>M</td> </tr> <tr> <td>TB2243A0</td> <td>D10 PE TRANSPAREN T PIPE</td> <td>1.500</td> <td>M</td> </tr> <tr> <td>VI1075A0</td> <td>NUT M4 H=4 UNI5587 INOX</td> <td>8</td> <td>PZ</td> </tr> <tr> <td>VI1220A1</td> <td>4,2X12 TCB SELF-TAPPIN G SCREW</td> <td>16</td> <td>PZ</td> </tr> <tr> <td>VI1895A0</td> <td>BLIND NUT M4 STAINLESS STEEL DIN 917</td> <td>8</td> <td>PZ</td> </tr> <tr> <td>VI1945A0</td> <td>ENG-VITE M4X20 TCB+ INOX</td> <td>8</td> <td>PZ</td> </tr> </tbody> </table>	Code	Description	Qty	UOM	0H7083A0	LM 800 XC STACKING KIT BACK PROFIL	2	PZ	ED1246A0	HOT SURFACE LABEL	1	PZ	ED1271A0	LIQUID FALLS DANGER LABE	1	PZ	EL1020A1	D8 INTERMEDIAT E T-SHAPED FITTING	2	PZ	EL1180A0	Ø8-Ø8 FEMALE NON-RETURN CONNECTION	2	PZ	GN1508A0	O-RING GASKET COD 2400	2	PZ	RC1008A0	D9 ELASTIC CLIP	7	PZ	RC1055A0	Ø25-40 H12 STAINLESS STEEL PIPE CLIP	10	PZ	RC1297A1	D10 T-SHAPED FITTING	1	PZ	RC1360A0	10 - 10 JG ELBOW FITTIN	1	PZ	RC1376A0	Ø6 Y-FITTING	1	PZ	TB1177A0	FOOT PANEL 40X40 H58 OVERLAP LM	4	PZ	TB1520A0	INT. Ø=38 TH=4 DRAIN BLACK RUBBER PIPE	2.700	M	TB1815A0	7,93X4,75 PE TRANSP. PIPE (JG #PE08100N)	2	M	TB2243A0	D10 PE TRANSPAREN T PIPE	1.500	M	VI1075A0	NUT M4 H=4 UNI5587 INOX	8	PZ	VI1220A1	4,2X12 TCB SELF-TAPPIN G SCREW	16	PZ	VI1895A0	BLIND NUT M4 STAINLESS STEEL DIN 917	8	PZ	VI1945A0	ENG-VITE M4X20 TCB+ INOX	8	PZ
Code	Description	Qty	UOM																																																																																		
0H7083A0	LM 800 XC STACKING KIT BACK PROFIL	2	PZ																																																																																		
ED1246A0	HOT SURFACE LABEL	1	PZ																																																																																		
ED1271A0	LIQUID FALLS DANGER LABE	1	PZ																																																																																		
EL1020A1	D8 INTERMEDIAT E T-SHAPED FITTING	2	PZ																																																																																		
EL1180A0	Ø8-Ø8 FEMALE NON-RETURN CONNECTION	2	PZ																																																																																		
GN1508A0	O-RING GASKET COD 2400	2	PZ																																																																																		
RC1008A0	D9 ELASTIC CLIP	7	PZ																																																																																		
RC1055A0	Ø25-40 H12 STAINLESS STEEL PIPE CLIP	10	PZ																																																																																		
RC1297A1	D10 T-SHAPED FITTING	1	PZ																																																																																		
RC1360A0	10 - 10 JG ELBOW FITTIN	1	PZ																																																																																		
RC1376A0	Ø6 Y-FITTING	1	PZ																																																																																		
TB1177A0	FOOT PANEL 40X40 H58 OVERLAP LM	4	PZ																																																																																		
TB1520A0	INT. Ø=38 TH=4 DRAIN BLACK RUBBER PIPE	2.700	M																																																																																		
TB1815A0	7,93X4,75 PE TRANSP. PIPE (JG #PE08100N)	2	M																																																																																		
TB2243A0	D10 PE TRANSPAREN T PIPE	1.500	M																																																																																		
VI1075A0	NUT M4 H=4 UNI5587 INOX	8	PZ																																																																																		
VI1220A1	4,2X12 TCB SELF-TAPPIN G SCREW	16	PZ																																																																																		
VI1895A0	BLIND NUT M4 STAINLESS STEEL DIN 917	8	PZ																																																																																		
VI1945A0	ENG-VITE M4X20 TCB+ INOX	8	PZ																																																																																		

COMPONENT			SPARE PART																																						
Code	Description	Image	Code	Description	Components list																																				
VL1006A	SYPHON COVER		XC648	LINEMISS TOP XFT200 STACKING KIT	<table border="1"> <thead> <tr> <th>Code</th> <th>Description</th> <th>Qty</th> <th>UOM</th> </tr> </thead> <tbody> <tr> <td>VI1950A0</td> <td>ST. STEEL 4.2X13 TCB SELF-DRILLIN G SCREW</td> <td>10</td> <td>PZ</td> </tr> <tr> <td>VL1005A1</td> <td>U-TRAP TANK</td> <td>2</td> <td>PZ</td> </tr> <tr> <td>VL1006A0</td> <td>SYPHON COVER</td> <td>2</td> <td>PZ</td> </tr> <tr> <td>VL1046A1</td> <td>D6 PIPE HOLDER - D6 J.G. TERMINAL</td> <td>6</td> <td>PZ</td> </tr> <tr> <td>VL1047A1</td> <td>D6 PIPE HOLDER - D8 J.G. TERMINAL</td> <td>4</td> <td>PZ</td> </tr> <tr> <td>VM1015A1</td> <td>STAINLESS STEEL Ø30X1.5 90° BEND</td> <td>1</td> <td>PZ</td> </tr> <tr> <td>VM1794A0</td> <td>250X4.8 PA66 BLACK CLAMP</td> <td>2</td> <td>PZ</td> </tr> <tr> <td>VM2035A0</td> <td>DRAIN PIPE SUPPORT</td> <td>1</td> <td>PZ</td> </tr> </tbody> </table>	Code	Description	Qty	UOM	VI1950A0	ST. STEEL 4.2X13 TCB SELF-DRILLIN G SCREW	10	PZ	VL1005A1	U-TRAP TANK	2	PZ	VL1006A0	SYPHON COVER	2	PZ	VL1046A1	D6 PIPE HOLDER - D6 J.G. TERMINAL	6	PZ	VL1047A1	D6 PIPE HOLDER - D8 J.G. TERMINAL	4	PZ	VM1015A1	STAINLESS STEEL Ø30X1.5 90° BEND	1	PZ	VM1794A0	250X4.8 PA66 BLACK CLAMP	2	PZ	VM2035A0	DRAIN PIPE SUPPORT	1	PZ
Code	Description	Qty	UOM																																						
VI1950A0	ST. STEEL 4.2X13 TCB SELF-DRILLIN G SCREW	10	PZ																																						
VL1005A1	U-TRAP TANK	2	PZ																																						
VL1006A0	SYPHON COVER	2	PZ																																						
VL1046A1	D6 PIPE HOLDER - D6 J.G. TERMINAL	6	PZ																																						
VL1047A1	D6 PIPE HOLDER - D8 J.G. TERMINAL	4	PZ																																						
VM1015A1	STAINLESS STEEL Ø30X1.5 90° BEND	1	PZ																																						
VM1794A0	250X4.8 PA66 BLACK CLAMP	2	PZ																																						
VM2035A0	DRAIN PIPE SUPPORT	1	PZ																																						
VM2036A	DRAIN WATER PIPE SUPPORT		KVM2036A	DRAIN WATER PIPE SUPPORT KIT	<table border="1"> <thead> <tr> <th>Code</th> <th>Description</th> <th>Qty</th> <th>UOM</th> </tr> </thead> <tbody> <tr> <td>VI1220A1</td> <td>4.2X12 TCB SELF-TAPPIN G SCREW</td> <td>2</td> <td>PZ</td> </tr> <tr> <td>VM1224A0</td> <td>65MY 220MM 2 COLOURS SHRINK TUBE</td> <td>0.200</td> <td>M</td> </tr> <tr> <td>VM2036A0</td> <td>DRAIN WATER PIPE SUPPOR</td> <td>2</td> <td>PZ</td> </tr> </tbody> </table>	Code	Description	Qty	UOM	VI1220A1	4.2X12 TCB SELF-TAPPIN G SCREW	2	PZ	VM1224A0	65MY 220MM 2 COLOURS SHRINK TUBE	0.200	M	VM2036A0	DRAIN WATER PIPE SUPPOR	2	PZ																				
Code	Description	Qty	UOM																																						
VI1220A1	4.2X12 TCB SELF-TAPPIN G SCREW	2	PZ																																						
VM1224A0	65MY 220MM 2 COLOURS SHRINK TUBE	0.200	M																																						
VM2036A0	DRAIN WATER PIPE SUPPOR	2	PZ																																						
TB2353A	TROLLEY OVENS GN 2/1 WATER DRAIN PIPE		TB2353A2	TROLLEY OVENS GN 2/1 WATER DRAIN PIPE																																					
VE1295A	MK 16A 230V DOOR MICROSWITCH		KVE1295A	16A 230V DOOR MICROSWITCH KIT	<table border="1"> <thead> <tr> <th>Code</th> <th>Description</th> <th>Qty</th> <th>UOM</th> </tr> </thead> <tbody> <tr> <td>VE1295A0</td> <td>MK 16A 230V DOOR MICROSWITC</td> <td>1</td> <td>PZ</td> </tr> <tr> <td>VM1224A0</td> <td>65MY 220MM 2 COLOURS SHRINK TUBE</td> <td>0.300</td> <td>M</td> </tr> </tbody> </table>	Code	Description	Qty	UOM	VE1295A0	MK 16A 230V DOOR MICROSWITC	1	PZ	VM1224A0	65MY 220MM 2 COLOURS SHRINK TUBE	0.300	M																								
Code	Description	Qty	UOM																																						
VE1295A0	MK 16A 230V DOOR MICROSWITC	1	PZ																																						
VM1224A0	65MY 220MM 2 COLOURS SHRINK TUBE	0.300	M																																						

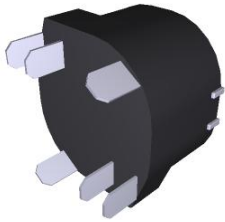
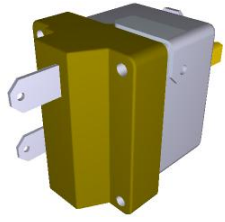

COMPONENT			SPARE PART														
Code	Description	Image	Code	Description	Components list												
VM1200A	DOOR MECHANIC MICROSWITCH SUPPORT PLATE		VM1200A0	DOOR MECHANIC MICROSWITCH SUPPORT PLATE													
0H2560A	XBC/XVC ZINC PLAT. DOOR COUNTERBRACKET		0H2560A0	XBC/XVC ZINC PLAT. DOOR COUNTERBRACKET													
RC1002A	JG 10M-8F TERMINAL REDUCTION FITTIN		KRC1002A	JG Ø10M-Ø8F REDUCING SPIGOT 10 PCS KIT	<table border="1"> <thead> <tr> <th>Code</th> <th>Description</th> <th>Qty</th> <th>UOM</th> </tr> </thead> <tbody> <tr> <td>RC1002A0</td> <td>JG 10M-8F TERMINAL REDUCTION FITTING</td> <td>10</td> <td>PZ</td> </tr> <tr> <td>VM1224A0</td> <td>65MY 220MM 2 COLOURS SHRINK TUBE</td> <td>0.200</td> <td>M</td> </tr> </tbody> </table>	Code	Description	Qty	UOM	RC1002A0	JG 10M-8F TERMINAL REDUCTION FITTING	10	PZ	VM1224A0	65MY 220MM 2 COLOURS SHRINK TUBE	0.200	M
Code	Description	Qty	UOM														
RC1002A0	JG 10M-8F TERMINAL REDUCTION FITTING	10	PZ														
VM1224A0	65MY 220MM 2 COLOURS SHRINK TUBE	0.200	M														
0H6567A	P-TRAP HOLDING BRACKET		0H6567A0	P-TRAP HOLDING BRACKET													
0H3750A	INOX PLATE REINFORCEMENT SIDE XVC1004P		0H3750A1	INOX PLATE REINFORCEMENT SIDE XVC1004P													

COMPONENT			SPARE PART																						
Code	Description	Image	Code	Description	Components list																				
0H1450A	XB-XV-XG ST. STEEL MUFFLE FRONT CORNER		0H1450A0	XB-XV-XG ST. STEEL MUFFLE FRONT CORNER																					
GN1275A	XBC/XVC BLACK CHIMNEY SEALING		KG1275A	KIT GUARNIZIONE CAMINO SILICONE NERO 4PZ	<table border="1"> <thead> <tr> <th>Code</th> <th>Description</th> <th>Qty</th> <th>UOM</th> </tr> </thead> <tbody> <tr> <td>GN1275A0</td> <td>XBC/XVC BLACK CHIMNEY SEALING</td> <td>4</td> <td>PZ</td> </tr> <tr> <td>VM1224A0</td> <td>65MY 220MM 2 COLOURS SHRINK TUBE</td> <td>0.200</td> <td>M</td> </tr> </tbody> </table>	Code	Description	Qty	UOM	GN1275A0	XBC/XVC BLACK CHIMNEY SEALING	4	PZ	VM1224A0	65MY 220MM 2 COLOURS SHRINK TUBE	0.200	M								
Code	Description	Qty	UOM																						
GN1275A0	XBC/XVC BLACK CHIMNEY SEALING	4	PZ																						
VM1224A0	65MY 220MM 2 COLOURS SHRINK TUBE	0.200	M																						
0H3790A	CHIMNEY HOLDING PLATE		0H3790A0	CHIMNEY HOLDING PLATE																					
VM1762A	INNER LAMP SUPPORT		KVM1762A	LAMP INTERNAL SUPPORT KIT	<table border="1"> <thead> <tr> <th>Code</th> <th>Description</th> <th>Qty</th> <th>UOM</th> </tr> </thead> <tbody> <tr> <td>VM1224A0</td> <td>65MY 220MM 2 COLOURS SHRINK TUBE</td> <td>0.150</td> <td>M</td> </tr> <tr> <td>VM1762A0</td> <td>INNER LAMP SUPPORT</td> <td>1</td> <td>PZ</td> </tr> </tbody> </table>	Code	Description	Qty	UOM	VM1224A0	65MY 220MM 2 COLOURS SHRINK TUBE	0.150	M	VM1762A0	INNER LAMP SUPPORT	1	PZ								
Code	Description	Qty	UOM																						
VM1224A0	65MY 220MM 2 COLOURS SHRINK TUBE	0.150	M																						
VM1762A0	INNER LAMP SUPPORT	1	PZ																						
VE1530A	GOLD THERMOMETER BLUE LIGHT COVER		KVE1530A	GOLDEN THERMOMETER BLUE LIGHT KIT	<table border="1"> <thead> <tr> <th>Code</th> <th>Description</th> <th>Qty</th> <th>UOM</th> </tr> </thead> <tbody> <tr> <td>VE1530A0</td> <td>GOLD THERMOMETE R BLUE LIGHT COVER</td> <td>1</td> <td>PZ</td> </tr> <tr> <td>VM1224A0</td> <td>65MY 220MM 2 COLOURS SHRINK TUBE</td> <td>0.150</td> <td>M</td> </tr> <tr> <td>VM1762A0</td> <td>INNER LAMP SUPPORT</td> <td>1</td> <td>PZ</td> </tr> <tr> <td>VM2009A0</td> <td>ELLIPTICAL SILVER SUPPORT D16</td> <td>1</td> <td>PZ</td> </tr> </tbody> </table>	Code	Description	Qty	UOM	VE1530A0	GOLD THERMOMETE R BLUE LIGHT COVER	1	PZ	VM1224A0	65MY 220MM 2 COLOURS SHRINK TUBE	0.150	M	VM1762A0	INNER LAMP SUPPORT	1	PZ	VM2009A0	ELLIPTICAL SILVER SUPPORT D16	1	PZ
Code	Description	Qty	UOM																						
VE1530A0	GOLD THERMOMETE R BLUE LIGHT COVER	1	PZ																						
VM1224A0	65MY 220MM 2 COLOURS SHRINK TUBE	0.150	M																						
VM1762A0	INNER LAMP SUPPORT	1	PZ																						
VM2009A0	ELLIPTICAL SILVER SUPPORT D16	1	PZ																						

COMPONENT			SPARE PART																										
Code	Description	Image	Code	Description	Components list																								
TM1005A	MI2 60 MIN 250V 16A TIMER		KTM1005A	60 MIN TIMER KIT	<table border="1"> <thead> <tr> <th>Code</th> <th>Description</th> <th>Qty</th> <th>UOM</th> </tr> </thead> <tbody> <tr> <td>TM1005A0</td> <td>MI2 60 MIN 250V 16A TIME</td> <td>1</td> <td>PZ</td> </tr> <tr> <td>VI1850A0</td> <td>M4X6 NICKEL PLATED FIXING SCRE</td> <td>2</td> <td>PZ</td> </tr> <tr> <td>VM1224A0</td> <td>65MY 220MM 2 COLOURS SHRINK TUBE</td> <td>0.250</td> <td>M</td> </tr> </tbody> </table>	Code	Description	Qty	UOM	TM1005A0	MI2 60 MIN 250V 16A TIME	1	PZ	VI1850A0	M4X6 NICKEL PLATED FIXING SCRE	2	PZ	VM1224A0	65MY 220MM 2 COLOURS SHRINK TUBE	0.250	M								
Code	Description	Qty	UOM																										
TM1005A0	MI2 60 MIN 250V 16A TIME	1	PZ																										
VI1850A0	M4X6 NICKEL PLATED FIXING SCRE	2	PZ																										
VM1224A0	65MY 220MM 2 COLOURS SHRINK TUBE	0.250	M																										
TR1100A	269°C 55.19052.80 ADJUSTABLE THERMOSTAT		KTR1100A	269°C THERMOSTAT KIT	<table border="1"> <thead> <tr> <th>Code</th> <th>Description</th> <th>Qty</th> <th>UOM</th> </tr> </thead> <tbody> <tr> <td>TR1100A0</td> <td>269°C 55.19052.80 ADJUSTABLE THERMOSTAT</td> <td>1</td> <td>PZ</td> </tr> <tr> <td>VI1850A0</td> <td>M4X6 NICKEL PLATED FIXING SCRE</td> <td>2</td> <td>PZ</td> </tr> </tbody> </table>	Code	Description	Qty	UOM	TR1100A0	269°C 55.19052.80 ADJUSTABLE THERMOSTAT	1	PZ	VI1850A0	M4X6 NICKEL PLATED FIXING SCRE	2	PZ												
Code	Description	Qty	UOM																										
TR1100A0	269°C 55.19052.80 ADJUSTABLE THERMOSTAT	1	PZ																										
VI1850A0	M4X6 NICKEL PLATED FIXING SCRE	2	PZ																										
VE1535A	230V WHITE LED		KVE1535A	LED LIGHT 1 PC KIT	<table border="1"> <thead> <tr> <th>Code</th> <th>Description</th> <th>Qty</th> <th>UOM</th> </tr> </thead> <tbody> <tr> <td>VE1535A1</td> <td>230V WHITE LED</td> <td>1</td> <td>PZ</td> </tr> <tr> <td>VM1224A0</td> <td>65MY 220MM 2 COLOURS SHRINK TUBE</td> <td>0.200</td> <td>M</td> </tr> </tbody> </table>	Code	Description	Qty	UOM	VE1535A1	230V WHITE LED	1	PZ	VM1224A0	65MY 220MM 2 COLOURS SHRINK TUBE	0.200	M												
Code	Description	Qty	UOM																										
VE1535A1	230V WHITE LED	1	PZ																										
VM1224A0	65MY 220MM 2 COLOURS SHRINK TUBE	0.200	M																										
			KVE0105A	CLOUD LED LIGHT+COVER+SUP PORT KIT	<table border="1"> <thead> <tr> <th>Code</th> <th>Description</th> <th>Qty</th> <th>UOM</th> </tr> </thead> <tbody> <tr> <td>VE1170A0</td> <td>D16 OPAQUE NICKEL ELLIPTICAL SUPPORT</td> <td>1</td> <td>PZ</td> </tr> <tr> <td>VE1535A1</td> <td>230V WHITE LED</td> <td>1</td> <td>PZ</td> </tr> <tr> <td>VM1761A0</td> <td>D16 BLACK ELLIPTICAL SUPPORT</td> <td>1</td> <td>PZ</td> </tr> <tr> <td>VM1762A0</td> <td>INNER LAMP SUPPORT</td> <td>1</td> <td>PZ</td> </tr> <tr> <td>VM1903A0</td> <td>GREEN PILOT WITH GOLD "CLOUD"</td> <td>1</td> <td>PZ</td> </tr> </tbody> </table>	Code	Description	Qty	UOM	VE1170A0	D16 OPAQUE NICKEL ELLIPTICAL SUPPORT	1	PZ	VE1535A1	230V WHITE LED	1	PZ	VM1761A0	D16 BLACK ELLIPTICAL SUPPORT	1	PZ	VM1762A0	INNER LAMP SUPPORT	1	PZ	VM1903A0	GREEN PILOT WITH GOLD "CLOUD"	1	PZ
Code	Description	Qty	UOM																										
VE1170A0	D16 OPAQUE NICKEL ELLIPTICAL SUPPORT	1	PZ																										
VE1535A1	230V WHITE LED	1	PZ																										
VM1761A0	D16 BLACK ELLIPTICAL SUPPORT	1	PZ																										
VM1762A0	INNER LAMP SUPPORT	1	PZ																										
VM1903A0	GREEN PILOT WITH GOLD "CLOUD"	1	PZ																										
			KVE0104A	NEUTRAL GREEN LIGHT KIT	<table border="1"> <thead> <tr> <th>Code</th> <th>Description</th> <th>Qty</th> <th>UOM</th> </tr> </thead> <tbody> <tr> <td>VE1170A0</td> <td>D16 OPAQUE NICKEL ELLIPTICAL SUPPORT</td> <td>1</td> <td>PZ</td> </tr> <tr> <td>VE1535A1</td> <td>230V WHITE LED</td> <td>1</td> <td>PZ</td> </tr> <tr> <td>VM1224A0</td> <td>65MY 220MM 2 COLOURS SHRINK TUBE</td> <td>0.200</td> <td>M</td> </tr> </tbody> </table>	Code	Description	Qty	UOM	VE1170A0	D16 OPAQUE NICKEL ELLIPTICAL SUPPORT	1	PZ	VE1535A1	230V WHITE LED	1	PZ	VM1224A0	65MY 220MM 2 COLOURS SHRINK TUBE	0.200	M								
Code	Description	Qty	UOM																										
VE1170A0	D16 OPAQUE NICKEL ELLIPTICAL SUPPORT	1	PZ																										
VE1535A1	230V WHITE LED	1	PZ																										
VM1224A0	65MY 220MM 2 COLOURS SHRINK TUBE	0.200	M																										



COMPONENT			SPARE PART																										
Code	Description	Image	Code	Description	Components list																								
VE1535A	230V WHITE LED		KVE0104A	NEUTRAL GREEN LIGHT KIT	<table border="1"> <thead> <tr> <th>Code</th> <th>Description</th> <th>Qty</th> <th>UOM</th> </tr> </thead> <tbody> <tr> <td>VM1761A0</td> <td>D16 BLACK ELLIPTICAL SUPPORT</td> <td>1</td> <td>PZ</td> </tr> <tr> <td>VM1762A0</td> <td>INNER LAMP SUPPORT</td> <td>1</td> <td>PZ</td> </tr> <tr> <td>VM1902A0</td> <td>NEUTRAL GREEN PLASTIC COVER FOR</td> <td>1</td> <td>PZ</td> </tr> </tbody> </table>	Code	Description	Qty	UOM	VM1761A0	D16 BLACK ELLIPTICAL SUPPORT	1	PZ	VM1762A0	INNER LAMP SUPPORT	1	PZ	VM1902A0	NEUTRAL GREEN PLASTIC COVER FOR	1	PZ								
			Code	Description	Qty	UOM																							
			VM1761A0	D16 BLACK ELLIPTICAL SUPPORT	1	PZ																							
			VM1762A0	INNER LAMP SUPPORT	1	PZ																							
			VM1902A0	NEUTRAL GREEN PLASTIC COVER FOR	1	PZ																							
			KVE0102A	GOLDEN FLAME LIGHT COVER KIT	<table border="1"> <thead> <tr> <th>Code</th> <th>Description</th> <th>Qty</th> <th>UOM</th> </tr> </thead> <tbody> <tr> <td>VE1170A0</td> <td>D16 OPAQUE NICKEL ELLIPTICAL SUPPORT</td> <td>1</td> <td>PZ</td> </tr> <tr> <td>VE1535A1</td> <td>230V WHITE LED</td> <td>1</td> <td>PZ</td> </tr> <tr> <td>VM1761A0</td> <td>D16 BLACK ELLIPTICAL SUPPORT</td> <td>1</td> <td>PZ</td> </tr> <tr> <td>VM1762A0</td> <td>INNER LAMP SUPPORT</td> <td>1</td> <td>PZ</td> </tr> <tr> <td>VM1767A0</td> <td>GREEN PILOT LIGHT W/ GOLD FLAME</td> <td>1</td> <td>PZ</td> </tr> </tbody> </table>	Code	Description	Qty	UOM	VE1170A0	D16 OPAQUE NICKEL ELLIPTICAL SUPPORT	1	PZ	VE1535A1	230V WHITE LED	1	PZ	VM1761A0	D16 BLACK ELLIPTICAL SUPPORT	1	PZ	VM1762A0	INNER LAMP SUPPORT	1	PZ	VM1767A0	GREEN PILOT LIGHT W/ GOLD FLAME	1	PZ
			Code	Description	Qty	UOM																							
			VE1170A0	D16 OPAQUE NICKEL ELLIPTICAL SUPPORT	1	PZ																							
			VE1535A1	230V WHITE LED	1	PZ																							
			VM1761A0	D16 BLACK ELLIPTICAL SUPPORT	1	PZ																							
			VM1762A0	INNER LAMP SUPPORT	1	PZ																							
			VM1767A0	GREEN PILOT LIGHT W/ GOLD FLAME	1	PZ																							
KVE0101A	SINUSOID LIGHT GREEN COVER KIT	<table border="1"> <thead> <tr> <th>Code</th> <th>Description</th> <th>Qty</th> <th>UOM</th> </tr> </thead> <tbody> <tr> <td>VE1170A0</td> <td>D16 OPAQUE NICKEL ELLIPTICAL SUPPORT</td> <td>1</td> <td>PZ</td> </tr> <tr> <td>VE1535A1</td> <td>230V WHITE LED</td> <td>1</td> <td>PZ</td> </tr> <tr> <td>VM1761A0</td> <td>D16 BLACK ELLIPTICAL SUPPORT</td> <td>1</td> <td>PZ</td> </tr> <tr> <td>VM1762A0</td> <td>INNER LAMP SUPPORT</td> <td>1</td> <td>PZ</td> </tr> <tr> <td>VM1765A0</td> <td>GREEN PILOT WITH GOLD SINUSOIDE</td> <td>1</td> <td>PZ</td> </tr> </tbody> </table>	Code	Description	Qty	UOM	VE1170A0	D16 OPAQUE NICKEL ELLIPTICAL SUPPORT	1	PZ	VE1535A1	230V WHITE LED	1	PZ	VM1761A0	D16 BLACK ELLIPTICAL SUPPORT	1	PZ	VM1762A0	INNER LAMP SUPPORT	1	PZ	VM1765A0	GREEN PILOT WITH GOLD SINUSOIDE	1	PZ			
Code	Description	Qty	UOM																										
VE1170A0	D16 OPAQUE NICKEL ELLIPTICAL SUPPORT	1	PZ																										
VE1535A1	230V WHITE LED	1	PZ																										
VM1761A0	D16 BLACK ELLIPTICAL SUPPORT	1	PZ																										
VM1762A0	INNER LAMP SUPPORT	1	PZ																										
VM1765A0	GREEN PILOT WITH GOLD SINUSOIDE	1	PZ																										
KVE0100A	THERMOMETER LIGHT COVER KIT	<table border="1"> <thead> <tr> <th>Code</th> <th>Description</th> <th>Qty</th> <th>UOM</th> </tr> </thead> <tbody> <tr> <td>VE1530A0</td> <td>GOLD THERMOMETE R BLUE LIGHT COVER</td> <td>1</td> <td>PZ</td> </tr> <tr> <td>VE1535A1</td> <td>230V WHITE LED</td> <td>1</td> <td>PZ</td> </tr> <tr> <td>VM1224A0</td> <td>65MY 220MM 2 COLOURS SHRINK TUBE</td> <td>0.200</td> <td>M</td> </tr> </tbody> </table>	Code	Description	Qty	UOM	VE1530A0	GOLD THERMOMETE R BLUE LIGHT COVER	1	PZ	VE1535A1	230V WHITE LED	1	PZ	VM1224A0	65MY 220MM 2 COLOURS SHRINK TUBE	0.200	M											
Code	Description	Qty	UOM																										
VE1530A0	GOLD THERMOMETE R BLUE LIGHT COVER	1	PZ																										
VE1535A1	230V WHITE LED	1	PZ																										
VM1224A0	65MY 220MM 2 COLOURS SHRINK TUBE	0.200	M																										

COMPONENT			SPARE PART																																			
Code	Description	Image	Code	Description	Components list																																	
VE1535A	230V WHITE LED		KVE0100A	THERMOMETER LIGHT COVER KIT	<table border="1"> <thead> <tr> <th>Code</th> <th>Description</th> <th>Qty</th> <th>UOM</th> </tr> </thead> <tbody> <tr> <td>VM1761A0</td> <td>D16 BLACK ELLIPTICAL SUPPORT</td> <td>1</td> <td>PZ</td> </tr> <tr> <td>VM1762A0</td> <td>INNER LAMP SUPPORT</td> <td>1</td> <td>PZ</td> </tr> </tbody> </table>	Code	Description	Qty	UOM	VM1761A0	D16 BLACK ELLIPTICAL SUPPORT	1	PZ	VM1762A0	INNER LAMP SUPPORT	1	PZ																					
			Code	Description	Qty	UOM																																
			VM1761A0	D16 BLACK ELLIPTICAL SUPPORT	1	PZ																																
VM1762A0	INNER LAMP SUPPORT	1	PZ																																			
KVE0011A	SP KNOBS AND LIGHTS KIT	<table border="1"> <thead> <tr> <th>Code</th> <th>Description</th> <th>Qty</th> <th>UOM</th> </tr> </thead> <tbody> <tr> <td>MN1105A0</td> <td>120-400C XP THERMOSTAT KNOB</td> <td>1</td> <td>PZ</td> </tr> <tr> <td>MN1110A0</td> <td>XP NEUTRAL INDEX DIAL</td> <td>1</td> <td>PZ</td> </tr> <tr> <td>VE1530A0</td> <td>GOLD THERMOMETE R BLUE LIGHT COVER</td> <td>1</td> <td>PZ</td> </tr> <tr> <td>VE1535A1</td> <td>230V WHITE LED</td> <td>1</td> <td>PZ</td> </tr> <tr> <td>VE1561A0</td> <td>NA/NA BIPOLAR SWITCH</td> <td>1</td> <td>PZ</td> </tr> <tr> <td>VM1761A0</td> <td>D16 BLACK ELLIPTICAL SUPPORT</td> <td>2</td> <td>PZ</td> </tr> <tr> <td>VM1762A0</td> <td>INNER LAMP SUPPORT</td> <td>1</td> <td>PZ</td> </tr> <tr> <td>VM1776A0</td> <td>"GOLD "0-1" MATT SILVER KEY"</td> <td>1</td> <td>PZ</td> </tr> </tbody> </table>	Code	Description	Qty	UOM	MN1105A0	120-400C XP THERMOSTAT KNOB	1	PZ	MN1110A0	XP NEUTRAL INDEX DIAL	1	PZ	VE1530A0	GOLD THERMOMETE R BLUE LIGHT COVER	1	PZ	VE1535A1	230V WHITE LED	1	PZ	VE1561A0	NA/NA BIPOLAR SWITCH	1	PZ	VM1761A0	D16 BLACK ELLIPTICAL SUPPORT	2	PZ	VM1762A0	INNER LAMP SUPPORT	1	PZ	VM1776A0	"GOLD "0-1" MATT SILVER KEY"	1	PZ
Code	Description	Qty	UOM																																			
MN1105A0	120-400C XP THERMOSTAT KNOB	1	PZ																																			
MN1110A0	XP NEUTRAL INDEX DIAL	1	PZ																																			
VE1530A0	GOLD THERMOMETE R BLUE LIGHT COVER	1	PZ																																			
VE1535A1	230V WHITE LED	1	PZ																																			
VE1561A0	NA/NA BIPOLAR SWITCH	1	PZ																																			
VM1761A0	D16 BLACK ELLIPTICAL SUPPORT	2	PZ																																			
VM1762A0	INNER LAMP SUPPORT	1	PZ																																			
VM1776A0	"GOLD "0-1" MATT SILVER KEY"	1	PZ																																			
KVE0008A	XL PILOT BLUE LIGHTS KIT	<table border="1"> <thead> <tr> <th>Code</th> <th>Description</th> <th>Qty</th> <th>UOM</th> </tr> </thead> <tbody> <tr> <td>VE1170A0</td> <td>D16 OPAQUE NICKEL ELLIPTICAL SUPPORT</td> <td>3</td> <td>PZ</td> </tr> <tr> <td>VE1530A0</td> <td>GOLD THERMOMETE R BLUE LIGHT COVER</td> <td>1</td> <td>PZ</td> </tr> <tr> <td>VE1535A1</td> <td>230V WHITE LED</td> <td>1</td> <td>PZ</td> </tr> <tr> <td>VE1561A0</td> <td>NA/NA BIPOLAR SWITCH</td> <td>1</td> <td>PZ</td> </tr> <tr> <td>VE1562A0</td> <td>UNIPOlar NA PUSH BUTTO</td> <td>1</td> <td>PZ</td> </tr> <tr> <td>VM1224A0</td> <td>65MY 220MM 2 COLOURS SHRINK TUBE</td> <td>0.200</td> <td>M</td> </tr> <tr> <td>VM1761A0</td> <td>D16 BLACK ELLIPTICAL SUPPORT</td> <td>3</td> <td>PZ</td> </tr> <tr> <td>VM1762A0</td> <td>INNER LAMP SUPPORT</td> <td>1</td> <td>PZ</td> </tr> </tbody> </table>	Code	Description	Qty	UOM	VE1170A0	D16 OPAQUE NICKEL ELLIPTICAL SUPPORT	3	PZ	VE1530A0	GOLD THERMOMETE R BLUE LIGHT COVER	1	PZ	VE1535A1	230V WHITE LED	1	PZ	VE1561A0	NA/NA BIPOLAR SWITCH	1	PZ	VE1562A0	UNIPOlar NA PUSH BUTTO	1	PZ	VM1224A0	65MY 220MM 2 COLOURS SHRINK TUBE	0.200	M	VM1761A0	D16 BLACK ELLIPTICAL SUPPORT	3	PZ	VM1762A0	INNER LAMP SUPPORT	1	PZ
Code	Description	Qty	UOM																																			
VE1170A0	D16 OPAQUE NICKEL ELLIPTICAL SUPPORT	3	PZ																																			
VE1530A0	GOLD THERMOMETE R BLUE LIGHT COVER	1	PZ																																			
VE1535A1	230V WHITE LED	1	PZ																																			
VE1561A0	NA/NA BIPOLAR SWITCH	1	PZ																																			
VE1562A0	UNIPOlar NA PUSH BUTTO	1	PZ																																			
VM1224A0	65MY 220MM 2 COLOURS SHRINK TUBE	0.200	M																																			
VM1761A0	D16 BLACK ELLIPTICAL SUPPORT	3	PZ																																			
VM1762A0	INNER LAMP SUPPORT	1	PZ																																			

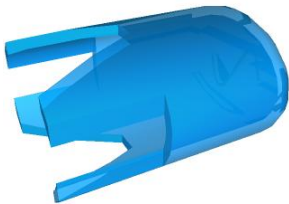
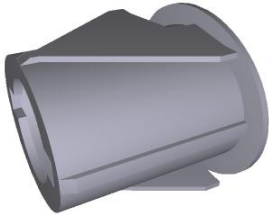
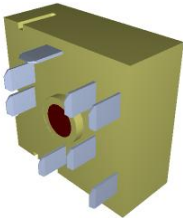

COMPONENT			SPARE PART																																																							
Code	Description	Image	Code	Description	Components list																																																					
VE1535A	230V WHITE LED		KVE0008A	XL PILOT BLUE LIGHTS KIT	<table border="1"> <thead> <tr> <th>Code</th> <th>Description</th> <th>Qty</th> <th>UOM</th> </tr> </thead> <tbody> <tr> <td>VM1775A0</td> <td>*OPAQUE SILVER KEY WITH GOLD "CLOUD"</td> <td>1</td> <td>PZ</td> </tr> <tr> <td>VM1776A0</td> <td>*GOLD "0-1" MATT SILVER KEY"</td> <td>1</td> <td>PZ</td> </tr> </tbody> </table>	Code	Description	Qty	UOM	VM1775A0	*OPAQUE SILVER KEY WITH GOLD "CLOUD"	1	PZ	VM1776A0	*GOLD "0-1" MATT SILVER KEY"	1	PZ																																									
			Code	Description	Qty	UOM																																																				
VM1775A0	*OPAQUE SILVER KEY WITH GOLD "CLOUD"	1	PZ																																																							
VM1776A0	*GOLD "0-1" MATT SILVER KEY"	1	PZ																																																							
KVE0007A	XF-XG LED AND LED COVERS KIT	<table border="1"> <thead> <tr> <th>Code</th> <th>Description</th> <th>Qty</th> <th>UOM</th> </tr> </thead> <tbody> <tr> <td>VE1170A0</td> <td>D16 OPAQUE NICKEL ELLIPTICAL SUPPORT</td> <td>5</td> <td>PZ</td> </tr> <tr> <td>VE1530A0</td> <td>GOLD THERMOMETE R BLUE LIGHT COVER</td> <td>1</td> <td>PZ</td> </tr> <tr> <td>VE1535A1</td> <td>230V WHITE LED</td> <td>1</td> <td>PZ</td> </tr> <tr> <td>VE1562A0</td> <td>UNIPOLAR NA PUSH BUTTO</td> <td>1</td> <td>PZ</td> </tr> <tr> <td>VE1585A0</td> <td>BLUE LIGHT COVER GOLD SINUSOID</td> <td>1</td> <td>PZ</td> </tr> <tr> <td>VM1224A0</td> <td>65MY 220MM 2 COLOURS SHRINK TUBE</td> <td>0.200</td> <td>M</td> </tr> <tr> <td>VM1761A0</td> <td>D16 BLACK ELLIPTICAL SUPPORT</td> <td>5</td> <td>PZ</td> </tr> <tr> <td>VM1762A0</td> <td>INNER LAMP SUPPORT</td> <td>4</td> <td>PZ</td> </tr> <tr> <td>VM1767A0</td> <td>GREEN PILOT LIGHT W/ GOLD FLAME</td> <td>1</td> <td>PZ</td> </tr> <tr> <td>VM1774A0</td> <td>SILVER OPAQUE KEY W/ GOLD FLAME</td> <td>1</td> <td>PZ</td> </tr> <tr> <td>VM1775A0</td> <td>*OPAQUE SILVER KEY WITH GOLD "CLOUD"</td> <td>1</td> <td>PZ</td> </tr> <tr> <td>VM1902A0</td> <td>NEUTRAL GREEN PLASTIC COVER FOR</td> <td>1</td> <td>PZ</td> </tr> <tr> <td>VM1903A0</td> <td>GREEN PILOT WITH GOLD "CLOUD"</td> <td>1</td> <td>PZ</td> </tr> </tbody> </table>	Code	Description	Qty	UOM	VE1170A0	D16 OPAQUE NICKEL ELLIPTICAL SUPPORT	5	PZ	VE1530A0	GOLD THERMOMETE R BLUE LIGHT COVER	1	PZ	VE1535A1	230V WHITE LED	1	PZ	VE1562A0	UNIPOLAR NA PUSH BUTTO	1	PZ	VE1585A0	BLUE LIGHT COVER GOLD SINUSOID	1	PZ	VM1224A0	65MY 220MM 2 COLOURS SHRINK TUBE	0.200	M	VM1761A0	D16 BLACK ELLIPTICAL SUPPORT	5	PZ	VM1762A0	INNER LAMP SUPPORT	4	PZ	VM1767A0	GREEN PILOT LIGHT W/ GOLD FLAME	1	PZ	VM1774A0	SILVER OPAQUE KEY W/ GOLD FLAME	1	PZ	VM1775A0	*OPAQUE SILVER KEY WITH GOLD "CLOUD"	1	PZ	VM1902A0	NEUTRAL GREEN PLASTIC COVER FOR	1	PZ	VM1903A0	GREEN PILOT WITH GOLD "CLOUD"	1	PZ
Code	Description	Qty	UOM																																																							
VE1170A0	D16 OPAQUE NICKEL ELLIPTICAL SUPPORT	5	PZ																																																							
VE1530A0	GOLD THERMOMETE R BLUE LIGHT COVER	1	PZ																																																							
VE1535A1	230V WHITE LED	1	PZ																																																							
VE1562A0	UNIPOLAR NA PUSH BUTTO	1	PZ																																																							
VE1585A0	BLUE LIGHT COVER GOLD SINUSOID	1	PZ																																																							
VM1224A0	65MY 220MM 2 COLOURS SHRINK TUBE	0.200	M																																																							
VM1761A0	D16 BLACK ELLIPTICAL SUPPORT	5	PZ																																																							
VM1762A0	INNER LAMP SUPPORT	4	PZ																																																							
VM1767A0	GREEN PILOT LIGHT W/ GOLD FLAME	1	PZ																																																							
VM1774A0	SILVER OPAQUE KEY W/ GOLD FLAME	1	PZ																																																							
VM1775A0	*OPAQUE SILVER KEY WITH GOLD "CLOUD"	1	PZ																																																							
VM1902A0	NEUTRAL GREEN PLASTIC COVER FOR	1	PZ																																																							
VM1903A0	GREEN PILOT WITH GOLD "CLOUD"	1	PZ																																																							

COMPONENT			SPARE PART																														
Code	Description	Image	Code	Description	Components list																												
VE1535A	230V WHITE LED		KLP1014A	SINUSOID LED LIGHT+COVER+SUPPORT KIT	<table border="1"> <thead> <tr> <th>Code</th> <th>Description</th> <th>Qty</th> <th>UOM</th> </tr> </thead> <tbody> <tr> <td>VE1170A0</td> <td>D16 OPAQUE NICKEL ELLIPTICAL SUPPORT</td> <td>2</td> <td>PZ</td> </tr> <tr> <td>VE1535A1</td> <td>230V WHITE LED</td> <td>2</td> <td>PZ</td> </tr> <tr> <td>VE1585A0</td> <td>BLUE LIGHT COVER GOLD SINUSOID</td> <td>2</td> <td>PZ</td> </tr> <tr> <td>VM1224A0</td> <td>65MY 220MM 2 COLOURS SHRINK TUBE</td> <td>0.200</td> <td>M</td> </tr> <tr> <td>VM1762A0</td> <td>INNER LAMP SUPPORT</td> <td>2</td> <td>PZ</td> </tr> <tr> <td>VM2009A0</td> <td>ELLIPTICAL SILVER SUPPORT D16</td> <td>1</td> <td>PZ</td> </tr> </tbody> </table>	Code	Description	Qty	UOM	VE1170A0	D16 OPAQUE NICKEL ELLIPTICAL SUPPORT	2	PZ	VE1535A1	230V WHITE LED	2	PZ	VE1585A0	BLUE LIGHT COVER GOLD SINUSOID	2	PZ	VM1224A0	65MY 220MM 2 COLOURS SHRINK TUBE	0.200	M	VM1762A0	INNER LAMP SUPPORT	2	PZ	VM2009A0	ELLIPTICAL SILVER SUPPORT D16	1	PZ
			Code	Description	Qty	UOM																											
			VE1170A0	D16 OPAQUE NICKEL ELLIPTICAL SUPPORT	2	PZ																											
VE1535A1	230V WHITE LED	2	PZ																														
VE1585A0	BLUE LIGHT COVER GOLD SINUSOID	2	PZ																														
VM1224A0	65MY 220MM 2 COLOURS SHRINK TUBE	0.200	M																														
VM1762A0	INNER LAMP SUPPORT	2	PZ																														
VM2009A0	ELLIPTICAL SILVER SUPPORT D16	1	PZ																														
KLP1012A	BLUE LIGHT THERMOMETER KIT	<table border="1"> <thead> <tr> <th>Code</th> <th>Description</th> <th>Qty</th> <th>UOM</th> </tr> </thead> <tbody> <tr> <td>VE1170A0</td> <td>D16 OPAQUE NICKEL ELLIPTICAL SUPPORT</td> <td>1</td> <td>PZ</td> </tr> <tr> <td>VE1530A0</td> <td>GOLD THERMOMETE R BLUE LIGHT COVER</td> <td>1</td> <td>PZ</td> </tr> <tr> <td>VE1535A1</td> <td>230V WHITE LED</td> <td>1</td> <td>PZ</td> </tr> <tr> <td>VM1224A0</td> <td>65MY 220MM 2 COLOURS SHRINK TUBE</td> <td>0.200</td> <td>M</td> </tr> <tr> <td>VM1762A0</td> <td>INNER LAMP SUPPORT</td> <td>1</td> <td>PZ</td> </tr> </tbody> </table>	Code	Description	Qty	UOM	VE1170A0	D16 OPAQUE NICKEL ELLIPTICAL SUPPORT	1	PZ	VE1530A0	GOLD THERMOMETE R BLUE LIGHT COVER	1	PZ	VE1535A1	230V WHITE LED	1	PZ	VM1224A0	65MY 220MM 2 COLOURS SHRINK TUBE	0.200	M	VM1762A0	INNER LAMP SUPPORT	1	PZ							
Code	Description	Qty	UOM																														
VE1170A0	D16 OPAQUE NICKEL ELLIPTICAL SUPPORT	1	PZ																														
VE1530A0	GOLD THERMOMETE R BLUE LIGHT COVER	1	PZ																														
VE1535A1	230V WHITE LED	1	PZ																														
VM1224A0	65MY 220MM 2 COLOURS SHRINK TUBE	0.200	M																														
VM1762A0	INNER LAMP SUPPORT	1	PZ																														
KLP1010A	THERMOSTAT GREEN LIGHT KIT	<table border="1"> <thead> <tr> <th>Code</th> <th>Description</th> <th>Qty</th> <th>UOM</th> </tr> </thead> <tbody> <tr> <td>VE1170A0</td> <td>D16 OPAQUE NICKEL ELLIPTICAL SUPPORT</td> <td>1</td> <td>PZ</td> </tr> <tr> <td>VE1535A1</td> <td>230V WHITE LED</td> <td>1</td> <td>PZ</td> </tr> <tr> <td>VM1762A0</td> <td>INNER LAMP SUPPORT</td> <td>1</td> <td>PZ</td> </tr> <tr> <td>VM1764A0</td> <td>GREEN PILOT WITH GOLD THERMOMETE</td> <td>1</td> <td>PZ</td> </tr> </tbody> </table>	Code	Description	Qty	UOM	VE1170A0	D16 OPAQUE NICKEL ELLIPTICAL SUPPORT	1	PZ	VE1535A1	230V WHITE LED	1	PZ	VM1762A0	INNER LAMP SUPPORT	1	PZ	VM1764A0	GREEN PILOT WITH GOLD THERMOMETE	1	PZ											
Code	Description	Qty	UOM																														
VE1170A0	D16 OPAQUE NICKEL ELLIPTICAL SUPPORT	1	PZ																														
VE1535A1	230V WHITE LED	1	PZ																														
VM1762A0	INNER LAMP SUPPORT	1	PZ																														
VM1764A0	GREEN PILOT WITH GOLD THERMOMETE	1	PZ																														

COMPONENT			SPARE PART																														
Code	Description	Image	Code	Description	Components list																												
VE1585A	BLUE LIGHT COVER GOLD SINUSOID		KLP1014A	SINUSOID LED LIGHT+COVER+SUP PORT KIT	<table border="1"> <thead> <tr> <th>Code</th> <th>Description</th> <th>Qty</th> <th>UOM</th> </tr> </thead> <tbody> <tr> <td>VE1170A0</td> <td>D16 OPAQUE NICKEL ELLIPTICAL SUPPORT</td> <td>2</td> <td>PZ</td> </tr> <tr> <td>VE1535A1</td> <td>230V WHITE LED</td> <td>2</td> <td>PZ</td> </tr> <tr> <td>VE1585A0</td> <td>BLUE LIGHT COVER GOLD SINUSOID</td> <td>2</td> <td>PZ</td> </tr> <tr> <td>VM1224A0</td> <td>65MY 220MM 2 COLOURS SHRINK TUBE</td> <td>0.200</td> <td>M</td> </tr> <tr> <td>VM1782A0</td> <td>INNER LAMP SUPPORT</td> <td>2</td> <td>PZ</td> </tr> <tr> <td>VM2009A0</td> <td>ELLIPTICAL SILVER SUPPORT D16</td> <td>1</td> <td>PZ</td> </tr> </tbody> </table>	Code	Description	Qty	UOM	VE1170A0	D16 OPAQUE NICKEL ELLIPTICAL SUPPORT	2	PZ	VE1535A1	230V WHITE LED	2	PZ	VE1585A0	BLUE LIGHT COVER GOLD SINUSOID	2	PZ	VM1224A0	65MY 220MM 2 COLOURS SHRINK TUBE	0.200	M	VM1782A0	INNER LAMP SUPPORT	2	PZ	VM2009A0	ELLIPTICAL SILVER SUPPORT D16	1	PZ
Code	Description	Qty	UOM																														
VE1170A0	D16 OPAQUE NICKEL ELLIPTICAL SUPPORT	2	PZ																														
VE1535A1	230V WHITE LED	2	PZ																														
VE1585A0	BLUE LIGHT COVER GOLD SINUSOID	2	PZ																														
VM1224A0	65MY 220MM 2 COLOURS SHRINK TUBE	0.200	M																														
VM1782A0	INNER LAMP SUPPORT	2	PZ																														
VM2009A0	ELLIPTICAL SILVER SUPPORT D16	1	PZ																														
VM2009A	ELLIPTICAL SILVER SUPPORT D16		KVM2009A	D16 SILVER ELLIPTICAL SUPPORT KIT	<table border="1"> <thead> <tr> <th>Code</th> <th>Description</th> <th>Qty</th> <th>UOM</th> </tr> </thead> <tbody> <tr> <td>VM1224A0</td> <td>65MY 220MM 2 COLOURS SHRINK TUBE</td> <td>0.150</td> <td>M</td> </tr> <tr> <td>VM2009A0</td> <td>ELLIPTICAL SILVER SUPPORT D16</td> <td>1</td> <td>PZ</td> </tr> </tbody> </table>	Code	Description	Qty	UOM	VM1224A0	65MY 220MM 2 COLOURS SHRINK TUBE	0.150	M	VM2009A0	ELLIPTICAL SILVER SUPPORT D16	1	PZ																
Code	Description	Qty	UOM																														
VM1224A0	65MY 220MM 2 COLOURS SHRINK TUBE	0.150	M																														
VM2009A0	ELLIPTICAL SILVER SUPPORT D16	1	PZ																														
VE1556A	THERMAL SWITCH 240V		KVE1556A	ENERGY REGULATOR KIT	<table border="1"> <thead> <tr> <th>Code</th> <th>Description</th> <th>Qty</th> <th>UOM</th> </tr> </thead> <tbody> <tr> <td>MN1000A0</td> <td>SILVER INDEX KNOB</td> <td>1</td> <td>PZ</td> </tr> <tr> <td>MN1085A0</td> <td>PLASTIC DIAL ENERGY REGULATOR</td> <td>1</td> <td>PZ</td> </tr> <tr> <td>VE1556A0</td> <td>THERMAL SWITCH 240V</td> <td>1</td> <td>PZ</td> </tr> <tr> <td>V11850A0</td> <td>M4X6 NICKEL PLATED FIXING SCRE</td> <td>2</td> <td>PZ</td> </tr> </tbody> </table>	Code	Description	Qty	UOM	MN1000A0	SILVER INDEX KNOB	1	PZ	MN1085A0	PLASTIC DIAL ENERGY REGULATOR	1	PZ	VE1556A0	THERMAL SWITCH 240V	1	PZ	V11850A0	M4X6 NICKEL PLATED FIXING SCRE	2	PZ								
Code	Description	Qty	UOM																														
MN1000A0	SILVER INDEX KNOB	1	PZ																														
MN1085A0	PLASTIC DIAL ENERGY REGULATOR	1	PZ																														
VE1556A0	THERMAL SWITCH 240V	1	PZ																														
V11850A0	M4X6 NICKEL PLATED FIXING SCRE	2	PZ																														
MN1112A	CHEFLUX BAKERLUX TIMER KNOB		KMN1112A	CHEFLUX/BAKERLU X TIMER KNOB KIT	<table border="1"> <thead> <tr> <th>Code</th> <th>Description</th> <th>Qty</th> <th>UOM</th> </tr> </thead> <tbody> <tr> <td>MN1112A1</td> <td>CHEFLUX BAKERLUX TIMER KNOB</td> <td>1</td> <td>PZ</td> </tr> <tr> <td>VM1224A0</td> <td>65MY 220MM 2 COLOURS SHRINK TUBE</td> <td>0.200</td> <td>M</td> </tr> </tbody> </table>	Code	Description	Qty	UOM	MN1112A1	CHEFLUX BAKERLUX TIMER KNOB	1	PZ	VM1224A0	65MY 220MM 2 COLOURS SHRINK TUBE	0.200	M																
Code	Description	Qty	UOM																														
MN1112A1	CHEFLUX BAKERLUX TIMER KNOB	1	PZ																														
VM1224A0	65MY 220MM 2 COLOURS SHRINK TUBE	0.200	M																														



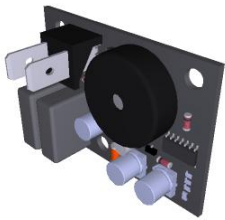

COMPONENT			SPARE PART																														
Code	Description	Image	Code	Description	Components list																												
MN1111A	CHEFLUX BAKERLUX THERMOSTAT KNO		KMN1111A	CL/BL THERMOSTAT KNOB (CELSIUS)	<table border="1"> <thead> <tr> <th>Code</th> <th>Description</th> <th>Qty</th> <th>UOM</th> </tr> </thead> <tbody> <tr> <td>MN1111A1</td> <td>CHEFLUX BAKERLUX THERMOSTAT KNOB</td> <td>1</td> <td>PZ</td> </tr> <tr> <td>VM1224A0</td> <td>65MY 220MM 2 COLOURS SHRINK TUBE</td> <td>0.200</td> <td>M</td> </tr> </tbody> </table>	Code	Description	Qty	UOM	MN1111A1	CHEFLUX BAKERLUX THERMOSTAT KNOB	1	PZ	VM1224A0	65MY 220MM 2 COLOURS SHRINK TUBE	0.200	M																
					Code	Description	Qty	UOM																									
MN1111A1	CHEFLUX BAKERLUX THERMOSTAT KNOB	1	PZ																														
VM1224A0	65MY 220MM 2 COLOURS SHRINK TUBE	0.200	M																														
MN1113A	CHEFLUX BAKERLUX HUMIDITY CONTROL KNOB		KMN1113A	CL/BL HUMIDITY CONTROL KNOB KIT	<table border="1"> <thead> <tr> <th>Code</th> <th>Description</th> <th>Qty</th> <th>UOM</th> </tr> </thead> <tbody> <tr> <td>MN1113A2</td> <td>CHEFLUX BAKERLUX HUMIDITY CONTROL KNOB</td> <td>1</td> <td>PZ</td> </tr> <tr> <td>VM1224A0</td> <td>65MY 220MM 2 COLOURS SHRINK TUBE</td> <td>0.200</td> <td>M</td> </tr> </tbody> </table>	Code	Description	Qty	UOM	MN1113A2	CHEFLUX BAKERLUX HUMIDITY CONTROL KNOB	1	PZ	VM1224A0	65MY 220MM 2 COLOURS SHRINK TUBE	0.200	M																
Code	Description	Qty	UOM																														
MN1113A2	CHEFLUX BAKERLUX HUMIDITY CONTROL KNOB	1	PZ																														
VM1224A0	65MY 220MM 2 COLOURS SHRINK TUBE	0.200	M																														
TM1001C	15 SEC 120V ELECTRONIC BUZZE		KTM1001C	15 SEC BUZZER KIT	<table border="1"> <thead> <tr> <th>Code</th> <th>Description</th> <th>Qty</th> <th>UOM</th> </tr> </thead> <tbody> <tr> <td>TM1001C2</td> <td>15 SEC 120V ELECTRONIC BUZZER</td> <td>1</td> <td>PZ</td> </tr> <tr> <td>TM1001C3</td> <td>15 SEC 120/240V BUZZER KIT</td> <td>1</td> <td>PZ</td> </tr> <tr> <td>VI1220A1</td> <td>4,2X12 TCB SELF-TAPPIN G SCREW</td> <td>3</td> <td>PZ</td> </tr> <tr> <td>VI1850A0</td> <td>M4X6 NICKEL PLATED FIXING SCRE</td> <td>3</td> <td>PZ</td> </tr> <tr> <td>VM1745A0</td> <td>CARD SUPPORT</td> <td>3</td> <td>PZ</td> </tr> <tr> <td>VM2147A0</td> <td>410X343X15 MM PINK SMOOTH ESD SPONGE</td> <td>1</td> <td>PZ</td> </tr> </tbody> </table>	Code	Description	Qty	UOM	TM1001C2	15 SEC 120V ELECTRONIC BUZZER	1	PZ	TM1001C3	15 SEC 120/240V BUZZER KIT	1	PZ	VI1220A1	4,2X12 TCB SELF-TAPPIN G SCREW	3	PZ	VI1850A0	M4X6 NICKEL PLATED FIXING SCRE	3	PZ	VM1745A0	CARD SUPPORT	3	PZ	VM2147A0	410X343X15 MM PINK SMOOTH ESD SPONGE	1	PZ
					Code	Description	Qty	UOM																									
					TM1001C2	15 SEC 120V ELECTRONIC BUZZER	1	PZ																									
					TM1001C3	15 SEC 120/240V BUZZER KIT	1	PZ																									
					VI1220A1	4,2X12 TCB SELF-TAPPIN G SCREW	3	PZ																									
					VI1850A0	M4X6 NICKEL PLATED FIXING SCRE	3	PZ																									
					VM1745A0	CARD SUPPORT	3	PZ																									
VM2147A0	410X343X15 MM PINK SMOOTH ESD SPONGE	1	PZ																														
VM2009A	ELLIPTICAL SILVER SUPPORT D16		KVM2009A	D16 SILVER ELLIPTICAL SUPPORT KIT	<table border="1"> <thead> <tr> <th>Code</th> <th>Description</th> <th>Qty</th> <th>UOM</th> </tr> </thead> <tbody> <tr> <td>VM1224A0</td> <td>65MY 220MM 2 COLOURS SHRINK TUBE</td> <td>0.150</td> <td>M</td> </tr> <tr> <td>VM2009A0</td> <td>ELLIPTICAL SILVER SUPPORT D16</td> <td>1</td> <td>PZ</td> </tr> </tbody> </table>	Code	Description	Qty	UOM	VM1224A0	65MY 220MM 2 COLOURS SHRINK TUBE	0.150	M	VM2009A0	ELLIPTICAL SILVER SUPPORT D16	1	PZ																
Code	Description	Qty	UOM																														
VM1224A0	65MY 220MM 2 COLOURS SHRINK TUBE	0.150	M																														
VM2009A0	ELLIPTICAL SILVER SUPPORT D16	1	PZ																														

COMPONENT			SPARE PART																																		
Code	Description	Image	Code	Description	Components list																																
VM2007A	FAN SPEED SILVER BUTTON		KVM2007A	FAN SPEED BUTTON KIT	<table border="1"> <thead> <tr> <th>Code</th> <th>Description</th> <th>Qty</th> <th>UOM</th> </tr> </thead> <tbody> <tr> <td>VM1224A0</td> <td>65MY 220MM 2 COLOURS SHRINK TUBE</td> <td>0.150</td> <td>M</td> </tr> <tr> <td>VM2007A0</td> <td>FAN SPEED SILVER BUTTON</td> <td>1</td> <td>PZ</td> </tr> </tbody> </table>	Code	Description	Qty	UOM	VM1224A0	65MY 220MM 2 COLOURS SHRINK TUBE	0.150	M	VM2007A0	FAN SPEED SILVER BUTTON	1	PZ																				
Code	Description	Qty	UOM																																		
VM1224A0	65MY 220MM 2 COLOURS SHRINK TUBE	0.150	M																																		
VM2007A0	FAN SPEED SILVER BUTTON	1	PZ																																		
0F1471A	XV1093 EXTERNAL BACK PANEL		0F1471A2	XV1093 EXTERNAL BACK PANEL																																	
RC1006A	D8 PET PIPE GUIDE BEND		KRC1006A	20 PCS. Ø8 PET PIPE GUIDE BEND KI	<table border="1"> <thead> <tr> <th>Code</th> <th>Description</th> <th>Qty</th> <th>UOM</th> </tr> </thead> <tbody> <tr> <td>RC1006A0</td> <td>D8 PET PIPE GUIDE BEND</td> <td>20</td> <td>PZ</td> </tr> <tr> <td>VM1224A0</td> <td>65MY 220MM 2 COLOURS SHRINK TUBE</td> <td>0.200</td> <td>M</td> </tr> </tbody> </table>	Code	Description	Qty	UOM	RC1006A0	D8 PET PIPE GUIDE BEND	20	PZ	VM1224A0	65MY 220MM 2 COLOURS SHRINK TUBE	0.200	M																				
Code	Description	Qty	UOM																																		
RC1006A0	D8 PET PIPE GUIDE BEND	20	PZ																																		
VM1224A0	65MY 220MM 2 COLOURS SHRINK TUBE	0.200	M																																		
RC1004A	Ø10-Ø8-8 Y CONNECTION		KVL1117A	EUR MM 2016+LMT FILTER+PRESS. RED. KIT	<table border="1"> <thead> <tr> <th>Code</th> <th>Description</th> <th>Qty</th> <th>UOM</th> </tr> </thead> <tbody> <tr> <td>0H7472A1</td> <td>DISTRIBUTOR SUPPORT PLATE</td> <td>1</td> <td>PZ</td> </tr> <tr> <td>RC1004A0</td> <td>Ø10-Ø8-8 Y CONNECTION</td> <td>1</td> <td>PZ</td> </tr> <tr> <td>RC1243A0</td> <td>Ø10F-Ø10M ELBOW CONNECTION + JG END KIT</td> <td>1</td> <td>PZ</td> </tr> <tr> <td>RC1372A0</td> <td>Ø10M-1/4 M CIL. STRAIGHT FITTING</td> <td>2</td> <td>PZ</td> </tr> <tr> <td>VI1220A1</td> <td>4,2X12 TCB SELF-TAPPIN G SCREW</td> <td>4</td> <td>PZ</td> </tr> <tr> <td>VL1014B1</td> <td>PRESSURE REDUCER WITH DISTRIBUTOR</td> <td>1</td> <td>PZ</td> </tr> <tr> <td>VL1014B2</td> <td>PRESSURE REDUCER WITH DISTRIBUTOR</td> <td>1</td> <td>PZ</td> </tr> </tbody> </table>	Code	Description	Qty	UOM	0H7472A1	DISTRIBUTOR SUPPORT PLATE	1	PZ	RC1004A0	Ø10-Ø8-8 Y CONNECTION	1	PZ	RC1243A0	Ø10F-Ø10M ELBOW CONNECTION + JG END KIT	1	PZ	RC1372A0	Ø10M-1/4 M CIL. STRAIGHT FITTING	2	PZ	VI1220A1	4,2X12 TCB SELF-TAPPIN G SCREW	4	PZ	VL1014B1	PRESSURE REDUCER WITH DISTRIBUTOR	1	PZ	VL1014B2	PRESSURE REDUCER WITH DISTRIBUTOR	1	PZ
Code	Description	Qty	UOM																																		
0H7472A1	DISTRIBUTOR SUPPORT PLATE	1	PZ																																		
RC1004A0	Ø10-Ø8-8 Y CONNECTION	1	PZ																																		
RC1243A0	Ø10F-Ø10M ELBOW CONNECTION + JG END KIT	1	PZ																																		
RC1372A0	Ø10M-1/4 M CIL. STRAIGHT FITTING	2	PZ																																		
VI1220A1	4,2X12 TCB SELF-TAPPIN G SCREW	4	PZ																																		
VL1014B1	PRESSURE REDUCER WITH DISTRIBUTOR	1	PZ																																		
VL1014B2	PRESSURE REDUCER WITH DISTRIBUTOR	1	PZ																																		

COMPONENT			SPARE PART																		
Code	Description	Image	Code	Description	Components list																
RC1004A	Ø10-Ø8-8 Y CONNECTION		KVL1117A	EUR MM 2016+LMT FILTER+PRESS. RED. KIT	<table border="1"> <thead> <tr> <th>Code</th> <th>Description</th> <th>Qty</th> <th>UOM</th> </tr> </thead> <tbody> <tr> <td>VL1034C0</td> <td>MESH WATER FILTER D10</td> <td>1</td> <td>PZ</td> </tr> <tr> <td>VL1062C0</td> <td>PRESSURE REDUCER-FILTER LOCKING FORK</td> <td>1</td> <td>PZ</td> </tr> <tr> <td>VM1054A0</td> <td>H7.8 PRESSURE REDUCER RING NUT</td> <td>1</td> <td>PZ</td> </tr> </tbody> </table>	Code	Description	Qty	UOM	VL1034C0	MESH WATER FILTER D10	1	PZ	VL1062C0	PRESSURE REDUCER-FILTER LOCKING FORK	1	PZ	VM1054A0	H7.8 PRESSURE REDUCER RING NUT	1	PZ
			Code	Description	Qty	UOM															
VL1034C0	MESH WATER FILTER D10	1	PZ																		
VL1062C0	PRESSURE REDUCER-FILTER LOCKING FORK	1	PZ																		
VM1054A0	H7.8 PRESSURE REDUCER RING NUT	1	PZ																		
KRC1004A	10 PCS Ø10-Ø8-8 JG Y FITTING KIT	<table border="1"> <thead> <tr> <th>Code</th> <th>Description</th> <th>Qty</th> <th>UOM</th> </tr> </thead> <tbody> <tr> <td>RC1004A0</td> <td>Ø10-Ø8-8 Y CONNECTION</td> <td>10</td> <td>PZ</td> </tr> <tr> <td>VM1224A0</td> <td>65MY 220MM 2 COLOURS SHRINK TUBE</td> <td>0.250</td> <td>M</td> </tr> </tbody> </table>	Code	Description	Qty	UOM	RC1004A0	Ø10-Ø8-8 Y CONNECTION	10	PZ	VM1224A0	65MY 220MM 2 COLOURS SHRINK TUBE	0.250	M							
Code	Description	Qty	UOM																		
RC1004A0	Ø10-Ø8-8 Y CONNECTION	10	PZ																		
VM1224A0	65MY 220MM 2 COLOURS SHRINK TUBE	0.250	M																		
VL1095A	D7.8-D10 RUBBER HOLDER M-M FITTING		KVL1095A	STRAIGHT CONNECT-HOLDER D7-D10 10PCS KIT	<table border="1"> <thead> <tr> <th>Code</th> <th>Description</th> <th>Qty</th> <th>UOM</th> </tr> </thead> <tbody> <tr> <td>VL1095A0</td> <td>D7.8-D10 RUBBER HOLDER M-M FITTING</td> <td>10</td> <td>PZ</td> </tr> <tr> <td>VM1224A0</td> <td>65MY 220MM 2 COLOURS SHRINK TUBE</td> <td>0.200</td> <td>M</td> </tr> </tbody> </table>	Code	Description	Qty	UOM	VL1095A0	D7.8-D10 RUBBER HOLDER M-M FITTING	10	PZ	VM1224A0	65MY 220MM 2 COLOURS SHRINK TUBE	0.200	M				
					Code	Description	Qty	UOM													
VL1095A0	D7.8-D10 RUBBER HOLDER M-M FITTING	10	PZ																		
VM1224A0	65MY 220MM 2 COLOURS SHRINK TUBE	0.200	M																		
VM1224A0	65MY 220MM 2 COLOURS SHRINK TUBE	0.200	M																		
TB1771A			TB1771A0																		
VM1054A	H7.8 PRESSURE REDUCER RING NUT		KVM1054A	H7.8 PRESSURE REDUCER DIAL KIT	<table border="1"> <thead> <tr> <th>Code</th> <th>Description</th> <th>Qty</th> <th>UOM</th> </tr> </thead> <tbody> <tr> <td>VM1054A0</td> <td>H7.8 PRESSURE REDUCER RING NUT</td> <td>1</td> <td>PZ</td> </tr> <tr> <td>VM1224A0</td> <td>65MY 220MM 2 COLOURS SHRINK TUBE</td> <td>0.200</td> <td>M</td> </tr> </tbody> </table>	Code	Description	Qty	UOM	VM1054A0	H7.8 PRESSURE REDUCER RING NUT	1	PZ	VM1224A0	65MY 220MM 2 COLOURS SHRINK TUBE	0.200	M				
			Code	Description	Qty	UOM															
			VM1054A0	H7.8 PRESSURE REDUCER RING NUT	1	PZ															
VM1224A0	65MY 220MM 2 COLOURS SHRINK TUBE	0.200	M																		
KVL1117A	EUR MM 2016+LMT FILTER+PRESS. RED. KIT	<table border="1"> <thead> <tr> <th>Code</th> <th>Description</th> <th>Qty</th> <th>UOM</th> </tr> </thead> <tbody> <tr> <td>0H7472A1</td> <td>DISTRIBUTOR SUPPORT PLATE</td> <td>1</td> <td>PZ</td> </tr> <tr> <td>RC1004A0</td> <td>Ø10-Ø8-8 Y CONNECTION</td> <td>1</td> <td>PZ</td> </tr> </tbody> </table>	Code	Description	Qty	UOM	0H7472A1	DISTRIBUTOR SUPPORT PLATE	1	PZ	RC1004A0	Ø10-Ø8-8 Y CONNECTION	1	PZ							
Code	Description	Qty	UOM																		
0H7472A1	DISTRIBUTOR SUPPORT PLATE	1	PZ																		
RC1004A0	Ø10-Ø8-8 Y CONNECTION	1	PZ																		

COMPONENT			SPARE PART																																						
Code	Description	Image	Code	Description	Components list																																				
VM1054A	H7.8 PRESSURE REDUCER RING NUT		KVL1117A	EUR MM 2016+LMT FILTER+PRESS. RED. KIT	<table border="1"> <thead> <tr> <th>Code</th> <th>Description</th> <th>Qty</th> <th>UOM</th> </tr> </thead> <tbody> <tr> <td>RC1243A0</td> <td>Ø10F-Ø10M ELBOW CONNECTION + JG END KIT</td> <td>1</td> <td>PZ</td> </tr> <tr> <td>RC1372A0</td> <td>Ø10M-1/4 M CIL. STRAIGHT FITTING</td> <td>2</td> <td>PZ</td> </tr> <tr> <td>VI1220A1</td> <td>4,2X12 TCB SELF-TAPPING SCREW</td> <td>4</td> <td>PZ</td> </tr> <tr> <td>VL1014B1</td> <td>PRESSURE REDUCER WITH DISTRIBUTOR</td> <td>1</td> <td>PZ</td> </tr> <tr> <td>VL1014B2</td> <td>PRESSURE REDUCER WITH DISTRIBUTOR</td> <td>1</td> <td>PZ</td> </tr> <tr> <td>VL1034C0</td> <td>MESH WATER FILTER D10</td> <td>1</td> <td>PZ</td> </tr> <tr> <td>VL1062C0</td> <td>PRESSURE REDUCER-FILTER LOCKING FORK</td> <td>1</td> <td>PZ</td> </tr> <tr> <td>VM1054A0</td> <td>H7.8 PRESSURE REDUCER RING NUT</td> <td>1</td> <td>PZ</td> </tr> </tbody> </table>	Code	Description	Qty	UOM	RC1243A0	Ø10F-Ø10M ELBOW CONNECTION + JG END KIT	1	PZ	RC1372A0	Ø10M-1/4 M CIL. STRAIGHT FITTING	2	PZ	VI1220A1	4,2X12 TCB SELF-TAPPING SCREW	4	PZ	VL1014B1	PRESSURE REDUCER WITH DISTRIBUTOR	1	PZ	VL1014B2	PRESSURE REDUCER WITH DISTRIBUTOR	1	PZ	VL1034C0	MESH WATER FILTER D10	1	PZ	VL1062C0	PRESSURE REDUCER-FILTER LOCKING FORK	1	PZ	VM1054A0	H7.8 PRESSURE REDUCER RING NUT	1	PZ
Code	Description	Qty	UOM																																						
RC1243A0	Ø10F-Ø10M ELBOW CONNECTION + JG END KIT	1	PZ																																						
RC1372A0	Ø10M-1/4 M CIL. STRAIGHT FITTING	2	PZ																																						
VI1220A1	4,2X12 TCB SELF-TAPPING SCREW	4	PZ																																						
VL1014B1	PRESSURE REDUCER WITH DISTRIBUTOR	1	PZ																																						
VL1014B2	PRESSURE REDUCER WITH DISTRIBUTOR	1	PZ																																						
VL1034C0	MESH WATER FILTER D10	1	PZ																																						
VL1062C0	PRESSURE REDUCER-FILTER LOCKING FORK	1	PZ																																						
VM1054A0	H7.8 PRESSURE REDUCER RING NUT	1	PZ																																						
RC1396A	JG D10-1/4 STRAIGHT END FITTING		KVL0014B	EUR 2017 MIND.MAPS PRESSURE REDUCER KIT	<table border="1"> <thead> <tr> <th>Code</th> <th>Description</th> <th>Qty</th> <th>UOM</th> </tr> </thead> <tbody> <tr> <td>RC1372A0</td> <td>Ø10M-1/4 M CIL. STRAIGHT FITTING</td> <td>1</td> <td>PZ</td> </tr> <tr> <td>RC1396A0</td> <td>JG D10-1/4 STRAIGHT END FITTING</td> <td>1</td> <td>PZ</td> </tr> <tr> <td>VL1014B1</td> <td>PRESSURE REDUCER WITH DISTRIBUTOR</td> <td>1</td> <td>PZ</td> </tr> <tr> <td>VL1014B2</td> <td>PRESSURE REDUCER WITH DISTRIBUTOR</td> <td>1</td> <td>PZ</td> </tr> <tr> <td>VM1054A0</td> <td>H7.8 PRESSURE REDUCER RING NUT</td> <td>1</td> <td>PZ</td> </tr> </tbody> </table>	Code	Description	Qty	UOM	RC1372A0	Ø10M-1/4 M CIL. STRAIGHT FITTING	1	PZ	RC1396A0	JG D10-1/4 STRAIGHT END FITTING	1	PZ	VL1014B1	PRESSURE REDUCER WITH DISTRIBUTOR	1	PZ	VL1014B2	PRESSURE REDUCER WITH DISTRIBUTOR	1	PZ	VM1054A0	H7.8 PRESSURE REDUCER RING NUT	1	PZ												
Code	Description	Qty	UOM																																						
RC1372A0	Ø10M-1/4 M CIL. STRAIGHT FITTING	1	PZ																																						
RC1396A0	JG D10-1/4 STRAIGHT END FITTING	1	PZ																																						
VL1014B1	PRESSURE REDUCER WITH DISTRIBUTOR	1	PZ																																						
VL1014B2	PRESSURE REDUCER WITH DISTRIBUTOR	1	PZ																																						
VM1054A0	H7.8 PRESSURE REDUCER RING NUT	1	PZ																																						

COMPONENT			SPARE PART																							
Code	Description	Image	Code	Description	Components list																					
VL1014B	PRESSURE REDUCER WITH DISTRIBUTOR		KVL0020A	PRESS. REDUCER 03-05XX=OCT18 / MM=MAR19	<table border="1"> <thead> <tr> <th>Code</th> <th>Description</th> <th>Qty</th> <th>UOM</th> </tr> </thead> <tbody> <tr> <td>RC1396A0</td> <td>JG D10-1/4 STRAIGHT END FITTING</td> <td>2</td> <td>PZ</td> </tr> <tr> <td>VL1014B1</td> <td>PRESSURE REDUCER WITH DISTRIBUTOR</td> <td>1</td> <td>PZ</td> </tr> <tr> <td>VL1014B2</td> <td>PRESSURE REDUCER WITH DISTRIBUTOR</td> <td>1</td> <td>PZ</td> </tr> <tr> <td>VM1054A0</td> <td>H7.8 PRESSURE REDUCER RING NUT</td> <td>1</td> <td>PZ</td> </tr> </tbody> </table>	Code	Description	Qty	UOM	RC1396A0	JG D10-1/4 STRAIGHT END FITTING	2	PZ	VL1014B1	PRESSURE REDUCER WITH DISTRIBUTOR	1	PZ	VL1014B2	PRESSURE REDUCER WITH DISTRIBUTOR	1	PZ	VM1054A0	H7.8 PRESSURE REDUCER RING NUT	1	PZ	
			Code	Description	Qty	UOM																				
			RC1396A0	JG D10-1/4 STRAIGHT END FITTING	2	PZ																				
VL1014B1	PRESSURE REDUCER WITH DISTRIBUTOR	1	PZ																							
VL1014B2	PRESSURE REDUCER WITH DISTRIBUTOR	1	PZ																							
VM1054A0	H7.8 PRESSURE REDUCER RING NUT	1	PZ																							
KVL0014B	EUR 2017 MIND.MAPS PRESSURE REDUCER KIT	<table border="1"> <thead> <tr> <th>Code</th> <th>Description</th> <th>Qty</th> <th>UOM</th> </tr> </thead> <tbody> <tr> <td>RC1372A0</td> <td>Ø10M-1/4 M CIL. STRAIGHT FITTING</td> <td>1</td> <td>PZ</td> </tr> <tr> <td>RC1396A0</td> <td>JG D10-1/4 STRAIGHT END FITTING</td> <td>1</td> <td>PZ</td> </tr> <tr> <td>VL1014B1</td> <td>PRESSURE REDUCER WITH DISTRIBUTOR</td> <td>1</td> <td>PZ</td> </tr> <tr> <td>VL1014B2</td> <td>PRESSURE REDUCER WITH DISTRIBUTOR</td> <td>1</td> <td>PZ</td> </tr> <tr> <td>VM1054A0</td> <td>H7.8 PRESSURE REDUCER RING NUT</td> <td>1</td> <td>PZ</td> </tr> </tbody> </table>	Code	Description	Qty	UOM	RC1372A0	Ø10M-1/4 M CIL. STRAIGHT FITTING	1	PZ	RC1396A0	JG D10-1/4 STRAIGHT END FITTING	1	PZ	VL1014B1	PRESSURE REDUCER WITH DISTRIBUTOR	1	PZ	VL1014B2	PRESSURE REDUCER WITH DISTRIBUTOR	1	PZ	VM1054A0	H7.8 PRESSURE REDUCER RING NUT	1	PZ
Code	Description	Qty	UOM																							
RC1372A0	Ø10M-1/4 M CIL. STRAIGHT FITTING	1	PZ																							
RC1396A0	JG D10-1/4 STRAIGHT END FITTING	1	PZ																							
VL1014B1	PRESSURE REDUCER WITH DISTRIBUTOR	1	PZ																							
VL1014B2	PRESSURE REDUCER WITH DISTRIBUTOR	1	PZ																							
VM1054A0	H7.8 PRESSURE REDUCER RING NUT	1	PZ																							
KVL0014A	EUR MIND.MAPS PRESSURE REDUCER KIT 2016	<table border="1"> <thead> <tr> <th>Code</th> <th>Description</th> <th>Qty</th> <th>UOM</th> </tr> </thead> <tbody> <tr> <td>RC1372A0</td> <td>Ø10M-1/4 M CIL. STRAIGHT FITTING</td> <td>2</td> <td>PZ</td> </tr> <tr> <td>VL1014B1</td> <td>PRESSURE REDUCER WITH DISTRIBUTOR</td> <td>1</td> <td>PZ</td> </tr> <tr> <td>VL1014B2</td> <td>PRESSURE REDUCER WITH DISTRIBUTOR</td> <td>1</td> <td>PZ</td> </tr> <tr> <td>VM1054A0</td> <td>H7.8 PRESSURE REDUCER RING NUT</td> <td>1</td> <td>PZ</td> </tr> </tbody> </table>	Code	Description	Qty	UOM	RC1372A0	Ø10M-1/4 M CIL. STRAIGHT FITTING	2	PZ	VL1014B1	PRESSURE REDUCER WITH DISTRIBUTOR	1	PZ	VL1014B2	PRESSURE REDUCER WITH DISTRIBUTOR	1	PZ	VM1054A0	H7.8 PRESSURE REDUCER RING NUT	1	PZ				
Code	Description	Qty	UOM																							
RC1372A0	Ø10M-1/4 M CIL. STRAIGHT FITTING	2	PZ																							
VL1014B1	PRESSURE REDUCER WITH DISTRIBUTOR	1	PZ																							
VL1014B2	PRESSURE REDUCER WITH DISTRIBUTOR	1	PZ																							
VM1054A0	H7.8 PRESSURE REDUCER RING NUT	1	PZ																							

COMPONENT			SPARE PART																																														
Code	Description	Image	Code	Description	Components list																																												
VL1014B	PRESSURE REDUCER WITH DISTRIBUTOR		KVL0010A	S.4 - 5 WATER PRESSURE REDUCER KIT	<table border="1"> <thead> <tr> <th>Code</th> <th>Description</th> <th>Qty</th> <th>UOM</th> </tr> </thead> <tbody> <tr> <td>EL1210A0</td> <td>D8-BSP1/4 JG STRAIGHT END CONNECTION</td> <td>2</td> <td>PZ</td> </tr> <tr> <td>VL1014B1</td> <td>PRESSURE REDUCER WITH DISTRIBUTOR</td> <td>1</td> <td>PZ</td> </tr> <tr> <td>VL1014B2</td> <td>PRESSURE REDUCER WITH DISTRIBUTOR</td> <td>1</td> <td>PZ</td> </tr> </tbody> </table>	Code	Description	Qty	UOM	EL1210A0	D8-BSP1/4 JG STRAIGHT END CONNECTION	2	PZ	VL1014B1	PRESSURE REDUCER WITH DISTRIBUTOR	1	PZ	VL1014B2	PRESSURE REDUCER WITH DISTRIBUTOR	1	PZ																												
					Code	Description	Qty	UOM																																									
EL1210A0	D8-BSP1/4 JG STRAIGHT END CONNECTION	2	PZ																																														
VL1014B1	PRESSURE REDUCER WITH DISTRIBUTOR	1	PZ																																														
VL1014B2	PRESSURE REDUCER WITH DISTRIBUTOR	1	PZ																																														
RC1243A	Ø10F-Ø10M ELBOW CONNECTION + JG END KIT		KVL1117A	EUR MM 2016+LMT FILTER+PRESS. RED. KIT	<table border="1"> <thead> <tr> <th>Code</th> <th>Description</th> <th>Qty</th> <th>UOM</th> </tr> </thead> <tbody> <tr> <td>0H7472A1</td> <td>DISTRIBUTOR SUPPORT PLATE</td> <td>1</td> <td>PZ</td> </tr> <tr> <td>RC1004A0</td> <td>Ø10-Ø8-8 Y CONNECTION</td> <td>1</td> <td>PZ</td> </tr> <tr> <td>RC1243A0</td> <td>Ø10F-Ø10M ELBOW CONNECTION + JG END KIT</td> <td>1</td> <td>PZ</td> </tr> <tr> <td>RC1372A0</td> <td>Ø10M-1/4 M CIL. STRAIGHT FITTING</td> <td>2</td> <td>PZ</td> </tr> <tr> <td>VI1220A1</td> <td>4,2X12 TCB SELF-TAPPING SCREW</td> <td>4</td> <td>PZ</td> </tr> <tr> <td>VL1014B1</td> <td>PRESSURE REDUCER WITH DISTRIBUTOR</td> <td>1</td> <td>PZ</td> </tr> <tr> <td>VL1014B2</td> <td>PRESSURE REDUCER WITH DISTRIBUTOR</td> <td>1</td> <td>PZ</td> </tr> <tr> <td>VL1034C0</td> <td>MESH WATER FILTER D10</td> <td>1</td> <td>PZ</td> </tr> <tr> <td>VL1062C0</td> <td>PRESSURE REDUCER-FILTER LOCKING FORK</td> <td>1</td> <td>PZ</td> </tr> <tr> <td>VM1054A0</td> <td>H7.8 PRESSURE REDUCER RING NUT</td> <td>1</td> <td>PZ</td> </tr> </tbody> </table>	Code	Description	Qty	UOM	0H7472A1	DISTRIBUTOR SUPPORT PLATE	1	PZ	RC1004A0	Ø10-Ø8-8 Y CONNECTION	1	PZ	RC1243A0	Ø10F-Ø10M ELBOW CONNECTION + JG END KIT	1	PZ	RC1372A0	Ø10M-1/4 M CIL. STRAIGHT FITTING	2	PZ	VI1220A1	4,2X12 TCB SELF-TAPPING SCREW	4	PZ	VL1014B1	PRESSURE REDUCER WITH DISTRIBUTOR	1	PZ	VL1014B2	PRESSURE REDUCER WITH DISTRIBUTOR	1	PZ	VL1034C0	MESH WATER FILTER D10	1	PZ	VL1062C0	PRESSURE REDUCER-FILTER LOCKING FORK	1	PZ	VM1054A0	H7.8 PRESSURE REDUCER RING NUT	1	PZ
					Code	Description	Qty	UOM																																									
					0H7472A1	DISTRIBUTOR SUPPORT PLATE	1	PZ																																									
					RC1004A0	Ø10-Ø8-8 Y CONNECTION	1	PZ																																									
					RC1243A0	Ø10F-Ø10M ELBOW CONNECTION + JG END KIT	1	PZ																																									
					RC1372A0	Ø10M-1/4 M CIL. STRAIGHT FITTING	2	PZ																																									
					VI1220A1	4,2X12 TCB SELF-TAPPING SCREW	4	PZ																																									
					VL1014B1	PRESSURE REDUCER WITH DISTRIBUTOR	1	PZ																																									
					VL1014B2	PRESSURE REDUCER WITH DISTRIBUTOR	1	PZ																																									
					VL1034C0	MESH WATER FILTER D10	1	PZ																																									
					VL1062C0	PRESSURE REDUCER-FILTER LOCKING FORK	1	PZ																																									
					VM1054A0	H7.8 PRESSURE REDUCER RING NUT	1	PZ																																									
					KRC1243A	Ø10F-Ø10M ELBOW CONN + JG END 10 PCS KIT				<table border="1"> <thead> <tr> <th>Code</th> <th>Description</th> <th>Qty</th> <th>UOM</th> </tr> </thead> <tbody> <tr> <td>RC1243A0</td> <td>Ø10F-Ø10M ELBOW CONNECTION + JG END KIT</td> <td>10</td> <td>PZ</td> </tr> <tr> <td>VM1224A0</td> <td>65MY 220MM 2 COLOURS SHRINK TUBE</td> <td>0.200</td> <td>M</td> </tr> </tbody> </table>	Code	Description	Qty	UOM	RC1243A0	Ø10F-Ø10M ELBOW CONNECTION + JG END KIT	10	PZ	VM1224A0	65MY 220MM 2 COLOURS SHRINK TUBE	0.200	M																											
										Code	Description	Qty	UOM																																				
RC1243A0	Ø10F-Ø10M ELBOW CONNECTION + JG END KIT	10	PZ																																														
VM1224A0	65MY 220MM 2 COLOURS SHRINK TUBE	0.200	M																																														

COMPONENT			SPARE PART																		
Code	Description	Image	Code	Description	Components list																
VL1135A	3/4-JG10 CONNECTOR + FILTER AND NRV		KVL1135A	3/4-JG10 FITTING WITH FILTER AND VNR KIT	<table border="1"> <thead> <tr> <th>Code</th> <th>Description</th> <th>Qty</th> <th>UOM</th> </tr> </thead> <tbody> <tr> <td>VL1135A0</td> <td>3/4-JG10 CONNECTOR + FILTER AND NRV</td> <td>1</td> <td>PZ</td> </tr> <tr> <td>VM1224A0</td> <td>65MY 220MM 2 COLOURS SHRINK TUBE</td> <td>0.150</td> <td>M</td> </tr> </tbody> </table>	Code	Description	Qty	UOM	VL1135A0	3/4-JG10 CONNECTOR + FILTER AND NRV	1	PZ	VM1224A0	65MY 220MM 2 COLOURS SHRINK TUBE	0.150	M				
Code	Description	Qty	UOM																		
VL1135A0	3/4-JG10 CONNECTOR + FILTER AND NRV	1	PZ																		
VM1224A0	65MY 220MM 2 COLOURS SHRINK TUBE	0.150	M																		
0H8039A	MM COMPACT REDUCER SUPPORT PLATE		0H8039A0	MM COMPACT REDUCER SUPPORT PLATE																	
EL1185A	Ø8F - Ø8F ELBOW CONNECTION		KEL1185A	Ø8F-Ø8F JG ELBOW FITTING 10 PCS KIT	<table border="1"> <thead> <tr> <th>Code</th> <th>Description</th> <th>Qty</th> <th>UOM</th> </tr> </thead> <tbody> <tr> <td>EL1185A0</td> <td>Ø8F - Ø8F ELBOW CONNECTION</td> <td>10</td> <td>PZ</td> </tr> <tr> <td>VM1224A0</td> <td>65MY 220MM 2 COLOURS SHRINK TUBE</td> <td>0.200</td> <td>M</td> </tr> </tbody> </table>	Code	Description	Qty	UOM	EL1185A0	Ø8F - Ø8F ELBOW CONNECTION	10	PZ	VM1224A0	65MY 220MM 2 COLOURS SHRINK TUBE	0.200	M				
Code	Description	Qty	UOM																		
EL1185A0	Ø8F - Ø8F ELBOW CONNECTION	10	PZ																		
VM1224A0	65MY 220MM 2 COLOURS SHRINK TUBE	0.200	M																		
TB1818A	JG Ø8 BLUE PE PIPE		KTB1419A  KTB1349A	TB1818A JG Ø8 WASHING PIPE 1,5M KIT  JGØ8 TB1818A WATER INLET PIPE L30M KIT	<table border="1"> <thead> <tr> <th>Code</th> <th>Description</th> <th>Qty</th> <th>UOM</th> </tr> </thead> <tbody> <tr> <td>TB1818A0</td> <td>JG Ø8 BLUE PE PIPE</td> <td>1.500</td> <td>M</td> </tr> </tbody> </table> <table border="1"> <thead> <tr> <th>Code</th> <th>Description</th> <th>Qty</th> <th>UOM</th> </tr> </thead> <tbody> <tr> <td>TB1818A0</td> <td>JG Ø8 BLUE PE PIPE</td> <td>30</td> <td>M</td> </tr> </tbody> </table>	Code	Description	Qty	UOM	TB1818A0	JG Ø8 BLUE PE PIPE	1.500	M	Code	Description	Qty	UOM	TB1818A0	JG Ø8 BLUE PE PIPE	30	M
Code	Description	Qty	UOM																		
TB1818A0	JG Ø8 BLUE PE PIPE	1.500	M																		
Code	Description	Qty	UOM																		
TB1818A0	JG Ø8 BLUE PE PIPE	30	M																		
0H2160A			0H2160A0																		





COMPONENT			SPARE PART																						
Code	Description	Image	Code	Description	Components list																				
VM1810A	RIGHT WATERTIGHT CAP		VM1810A0	RIGHT WATERTIGHT CAP																					
VM1811A	LEFT WATERTIGHT CAP		VM1811A0	LEFT WATERTIGHT CAP																					
VL1026A	BEND FOR DRAIN PIPE		KVL1026A	DRAIN PIPE BEND KI	<table border="1"> <thead> <tr> <th>Code</th> <th>Description</th> <th>Qty</th> <th>UOM</th> </tr> </thead> <tbody> <tr> <td>GN1400A0</td> <td>U-TRAP SEAL</td> <td>1</td> <td>PZ</td> </tr> <tr> <td>VL1026A0</td> <td>BEND FOR DRAIN PIPE</td> <td>1</td> <td>PZ</td> </tr> <tr> <td>VM1224A0</td> <td>65MY 220MM 2 COLOURS SHRINK TUBE</td> <td>0.300</td> <td>M</td> </tr> <tr> <td>VM2039A0</td> <td>DRAIN BEND FIXING RING</td> <td>1</td> <td>PZ</td> </tr> </tbody> </table>	Code	Description	Qty	UOM	GN1400A0	U-TRAP SEAL	1	PZ	VL1026A0	BEND FOR DRAIN PIPE	1	PZ	VM1224A0	65MY 220MM 2 COLOURS SHRINK TUBE	0.300	M	VM2039A0	DRAIN BEND FIXING RING	1	PZ
Code	Description	Qty	UOM																						
GN1400A0	U-TRAP SEAL	1	PZ																						
VL1026A0	BEND FOR DRAIN PIPE	1	PZ																						
VM1224A0	65MY 220MM 2 COLOURS SHRINK TUBE	0.300	M																						
VM2039A0	DRAIN BEND FIXING RING	1	PZ																						
VM1240A	NYLON SUPPORT CAP		KVM1240A	4 PCS COUNTER BRACKET SUPPORT CAP KIT	<table border="1"> <thead> <tr> <th>Code</th> <th>Description</th> <th>Qty</th> <th>UOM</th> </tr> </thead> <tbody> <tr> <td>VM1224A0</td> <td>65MY 220MM 2 COLOURS SHRINK TUBE</td> <td>0.200</td> <td>M</td> </tr> <tr> <td>VM1240A0</td> <td>NYLON SUPPORT CAP</td> <td>4</td> <td>PZ</td> </tr> </tbody> </table>	Code	Description	Qty	UOM	VM1224A0	65MY 220MM 2 COLOURS SHRINK TUBE	0.200	M	VM1240A0	NYLON SUPPORT CAP	4	PZ								
Code	Description	Qty	UOM																						
VM1224A0	65MY 220MM 2 COLOURS SHRINK TUBE	0.200	M																						
VM1240A0	NYLON SUPPORT CAP	4	PZ																						
VM1008A	GASKET SUPPORT INT.CORNER PANEL		VM1008A0	GASKET SUPPORT INT.CORNER PANEL																					



COMPONENT			SPARE PART																										
Code	Description	Image	Code	Description	Components list																								
VM1195A	HOLES BLANKING PLATE XVC204/304/504/704		VM1195A0	HOLES BLANKING PLATE XVC204/304/504/704																									
VM1505A	WALL PASSING WITH DIAPHRAGM		KVM1505A	THROUGH-WALL CONNECTION+DIAPHRAGM KIT	<table border="1"> <thead> <tr> <th>Code</th> <th>Description</th> <th>Qty</th> <th>UOM</th> </tr> </thead> <tbody> <tr> <td>VI1220A1</td> <td>4,2X12 TCB SELF-TAPPING SCREW</td> <td>1</td> <td>PZ</td> </tr> <tr> <td>VM1224A0</td> <td>65MY 220MM 2 COLOURS SHRINK TUBE</td> <td>0.200</td> <td>M</td> </tr> <tr> <td>VM1505A0</td> <td>WALL PASSING WITH DIAPHRAGM</td> <td>3</td> <td>PZ</td> </tr> <tr> <td>VM2055A0</td> <td>UPPER WALL PASSING ACCESSORY CABLES</td> <td>1</td> <td>PZ</td> </tr> <tr> <td>VM2056A0</td> <td>LOWER WALL PASSING ACCESSORY CABLES</td> <td>1</td> <td>PZ</td> </tr> </tbody> </table>	Code	Description	Qty	UOM	VI1220A1	4,2X12 TCB SELF-TAPPING SCREW	1	PZ	VM1224A0	65MY 220MM 2 COLOURS SHRINK TUBE	0.200	M	VM1505A0	WALL PASSING WITH DIAPHRAGM	3	PZ	VM2055A0	UPPER WALL PASSING ACCESSORY CABLES	1	PZ	VM2056A0	LOWER WALL PASSING ACCESSORY CABLES	1	PZ
Code	Description	Qty	UOM																										
VI1220A1	4,2X12 TCB SELF-TAPPING SCREW	1	PZ																										
VM1224A0	65MY 220MM 2 COLOURS SHRINK TUBE	0.200	M																										
VM1505A0	WALL PASSING WITH DIAPHRAGM	3	PZ																										
VM2055A0	UPPER WALL PASSING ACCESSORY CABLES	1	PZ																										
VM2056A0	LOWER WALL PASSING ACCESSORY CABLES	1	PZ																										
VM1014A	RING MOUNTING OVEN TO THE FLOOR		KVM1014A	BRACKETS TO FIX OVEN TO FLOOR 4PCS KIT	<table border="1"> <thead> <tr> <th>Code</th> <th>Description</th> <th>Qty</th> <th>UOM</th> </tr> </thead> <tbody> <tr> <td>VM1014A0</td> <td>RING MOUNTING OVEN TO THE FLOOR</td> <td>4</td> <td>PZ</td> </tr> <tr> <td>VM1224A0</td> <td>65MY 220MM 2 COLOURS SHRINK TUBE</td> <td>0.300</td> <td>M</td> </tr> </tbody> </table>	Code	Description	Qty	UOM	VM1014A0	RING MOUNTING OVEN TO THE FLOOR	4	PZ	VM1224A0	65MY 220MM 2 COLOURS SHRINK TUBE	0.300	M												
Code	Description	Qty	UOM																										
VM1014A0	RING MOUNTING OVEN TO THE FLOOR	4	PZ																										
VM1224A0	65MY 220MM 2 COLOURS SHRINK TUBE	0.300	M																										
VM1165B	CT BT DOOR UPPER BRACKET		KVM1165B	CT BT CL BL DOOR UPPER BRACKET KI	<table border="1"> <thead> <tr> <th>Code</th> <th>Description</th> <th>Qty</th> <th>UOM</th> </tr> </thead> <tbody> <tr> <td>VM1165B0</td> <td>CT BT DOOR UPPER BRACKET</td> <td>1</td> <td>PZ</td> </tr> <tr> <td>VM1224A0</td> <td>65MY 220MM 2 COLOURS SHRINK TUBE</td> <td>0.250</td> <td>M</td> </tr> </tbody> </table>	Code	Description	Qty	UOM	VM1165B0	CT BT DOOR UPPER BRACKET	1	PZ	VM1224A0	65MY 220MM 2 COLOURS SHRINK TUBE	0.250	M												
Code	Description	Qty	UOM																										
VM1165B0	CT BT DOOR UPPER BRACKET	1	PZ																										
VM1224A0	65MY 220MM 2 COLOURS SHRINK TUBE	0.250	M																										



COMPONENT			SPARE PART										
Code	Description	Image	Code	Description	Components list								
VM1166A	CAP FOR DOOR UPPER STIRRUP XVC204/304/5		KVM1166A	DOOR UPPER BRACKET COVER KI	<table border="1"> <thead> <tr> <th>Code</th> <th>Description</th> <th>Qty</th> <th>UOM</th> </tr> </thead> <tbody> <tr> <td>VM1166A0</td> <td>CAP FOR DOOR UPPER STIRRUP XVC204/304/5</td> <td>1</td> <td>PZ</td> </tr> </tbody> </table>	Code	Description	Qty	UOM	VM1166A0	CAP FOR DOOR UPPER STIRRUP XVC204/304/5	1	PZ
					Code	Description	Qty	UOM					
VM1166A0	CAP FOR DOOR UPPER STIRRUP XVC204/304/5	1	PZ										
<table border="1"> <tbody> <tr> <td>VM1224A0</td> <td>65MY 220MM 2 COLOURS SHRINK TUBE</td> <td>0.200</td> <td>M</td> </tr> </tbody> </table>	VM1224A0	65MY 220MM 2 COLOURS SHRINK TUBE	0.200	M									
VM1224A0	65MY 220MM 2 COLOURS SHRINK TUBE	0.200	M										
VM1160B	CT BT DOOR LOWER BRACKET		KVM1160B	CT BT DOOR LOWER BRACKET KI	<table border="1"> <thead> <tr> <th>Code</th> <th>Description</th> <th>Qty</th> <th>UOM</th> </tr> </thead> <tbody> <tr> <td>VM1160B0</td> <td>CT BT DOOR LOWER BRACKET</td> <td>1</td> <td>PZ</td> </tr> </tbody> </table>	Code	Description	Qty	UOM	VM1160B0	CT BT DOOR LOWER BRACKET	1	PZ
					Code	Description	Qty	UOM					
VM1160B0	CT BT DOOR LOWER BRACKET	1	PZ										
<table border="1"> <tbody> <tr> <td>VM1224A0</td> <td>65MY 220MM 2 COLOURS SHRINK TUBE</td> <td>0.250</td> <td>M</td> </tr> </tbody> </table>	VM1224A0	65MY 220MM 2 COLOURS SHRINK TUBE	0.250	M									
VM1224A0	65MY 220MM 2 COLOURS SHRINK TUBE	0.250	M										