







Assembly code	Assembly revision	Assembly image
ASM2912B/0.D04	Cooking chamber	
ASM2926A/0.D03	Electrical system	
ASM2917D/0.D01	External cover	
ASM2922B/0.D02	Door	



ASM2912B/0.D04 - Cooking chamber





FRONT

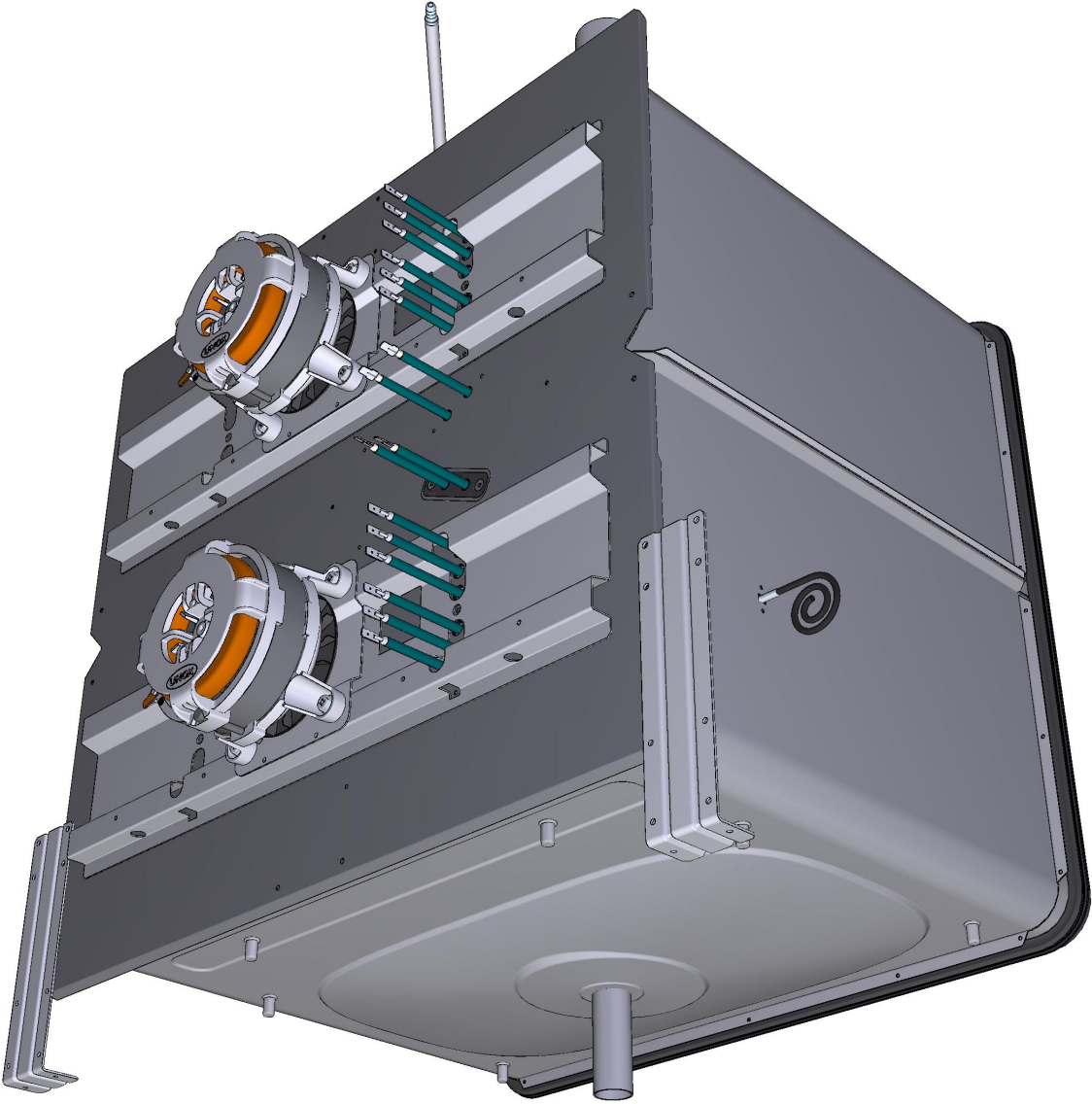

ASM2912B/0.D04 - Cooking chamber

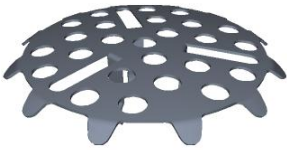
REAR







COMPONENT			SPARE PART																						
Code	Description	Image	Code	Description	Components list																				
0H2551A	XBC/XVC ST.STEEL DRAIN COVER		K0H2551A	DRAIN COVER KIT	<table border="1"> <thead> <tr> <th>Code</th> <th>Description</th> <th>Qty</th> <th>UOM</th> </tr> </thead> <tbody> <tr> <td>0H2551A0</td> <td>XBC/XVC ST.STEEL DRAIN COVER</td> <td>1</td> <td>PZ</td> </tr> <tr> <td>VM1224A0</td> <td>65MY 220MM 2 COLOURS SHRINK TUBE</td> <td>0.200</td> <td>M</td> </tr> </tbody> </table>	Code	Description	Qty	UOM	0H2551A0	XBC/XVC ST.STEEL DRAIN COVER	1	PZ	VM1224A0	65MY 220MM 2 COLOURS SHRINK TUBE	0.200	M								
					Code	Description	Qty	UOM																	
0H2551A0	XBC/XVC ST.STEEL DRAIN COVER	1	PZ																						
VM1224A0	65MY 220MM 2 COLOURS SHRINK TUBE	0.200	M																						
<table border="1"> <thead> <tr> <th>Code</th> <th>Description</th> <th>Qty</th> <th>UOM</th> </tr> </thead> <tbody> <tr> <td>VM1224A0</td> <td>65MY 220MM 2 COLOURS SHRINK TUBE</td> <td>0.200</td> <td>M</td> </tr> <tr> <td>VM1820A0</td> <td>LATERAL SUPPORTS M6 FIXING BOLT</td> <td>10</td> <td>PZ</td> </tr> </tbody> </table>	Code	Description	Qty	UOM	VM1224A0	65MY 220MM 2 COLOURS SHRINK TUBE	0.200	M	VM1820A0	LATERAL SUPPORTS M6 FIXING BOLT	10	PZ													
Code	Description	Qty	UOM																						
VM1224A0	65MY 220MM 2 COLOURS SHRINK TUBE	0.200	M																						
VM1820A0	LATERAL SUPPORTS M6 FIXING BOLT	10	PZ																						
VM1820A	LATERAL SUPPORTS M6 FIXING BOLT		KVM1820A	THUMB SCREW 10PCS KIT	<table border="1"> <thead> <tr> <th>Code</th> <th>Description</th> <th>Qty</th> <th>UOM</th> </tr> </thead> <tbody> <tr> <td>VM1224A0</td> <td>65MY 220MM 2 COLOURS SHRINK TUBE</td> <td>0.200</td> <td>M</td> </tr> <tr> <td>VM1820A0</td> <td>LATERAL SUPPORTS M6 FIXING BOLT</td> <td>10</td> <td>PZ</td> </tr> </tbody> </table>	Code	Description	Qty	UOM	VM1224A0	65MY 220MM 2 COLOURS SHRINK TUBE	0.200	M	VM1820A0	LATERAL SUPPORTS M6 FIXING BOLT	10	PZ								
					Code	Description	Qty	UOM																	
VM1224A0	65MY 220MM 2 COLOURS SHRINK TUBE	0.200	M																						
VM1820A0	LATERAL SUPPORTS M6 FIXING BOLT	10	PZ																						
<table border="1"> <thead> <tr> <th>Code</th> <th>Description</th> <th>Qty</th> <th>UOM</th> </tr> </thead> <tbody> <tr> <td>VM1224A0</td> <td>65MY 220MM 2 COLOURS SHRINK TUBE</td> <td>0.200</td> <td>M</td> </tr> <tr> <td>VM2331A0</td> <td>FAN GUARD-TRAY S HOLDER PIN</td> <td>4</td> <td>PZ</td> </tr> </tbody> </table>	Code	Description	Qty	UOM	VM1224A0	65MY 220MM 2 COLOURS SHRINK TUBE	0.200	M	VM2331A0	FAN GUARD-TRAY S HOLDER PIN	4	PZ													
Code	Description	Qty	UOM																						
VM1224A0	65MY 220MM 2 COLOURS SHRINK TUBE	0.200	M																						
VM2331A0	FAN GUARD-TRAY S HOLDER PIN	4	PZ																						
VM2331A	FAN GUARD-TRAYS HOLDER PIN		KVM2331A	KIT FAN GUARD-TRAYS HOLDER PIN	<table border="1"> <thead> <tr> <th>Code</th> <th>Description</th> <th>Qty</th> <th>UOM</th> </tr> </thead> <tbody> <tr> <td>VM1224A0</td> <td>65MY 220MM 2 COLOURS SHRINK TUBE</td> <td>0.200</td> <td>M</td> </tr> <tr> <td>VM2331A0</td> <td>FAN GUARD-TRAY S HOLDER PIN</td> <td>4</td> <td>PZ</td> </tr> </tbody> </table>	Code	Description	Qty	UOM	VM1224A0	65MY 220MM 2 COLOURS SHRINK TUBE	0.200	M	VM2331A0	FAN GUARD-TRAY S HOLDER PIN	4	PZ								
					Code	Description	Qty	UOM																	
VM1224A0	65MY 220MM 2 COLOURS SHRINK TUBE	0.200	M																						
VM2331A0	FAN GUARD-TRAY S HOLDER PIN	4	PZ																						
<table border="1"> <thead> <tr> <th>Code</th> <th>Description</th> <th>Qty</th> <th>UOM</th> </tr> </thead> <tbody> <tr> <td>GN1285A0</td> <td>NTC TEMPERATURE PROBE SEALING</td> <td>1</td> <td>PZ</td> </tr> <tr> <td>SL1045A0</td> <td>S57 BLACK SILICONE - 80ML CARTRIDGE</td> <td>1</td> <td>PZ</td> </tr> <tr> <td>TR1106B0</td> <td></td> <td>1</td> <td>PZ</td> </tr> <tr> <td>VI1220A1</td> <td>4,2X12 TCB SELF-TAPPING SCREW</td> <td>2</td> <td>PZ</td> </tr> </tbody> </table>	Code	Description	Qty	UOM	GN1285A0	NTC TEMPERATURE PROBE SEALING	1	PZ	SL1045A0	S57 BLACK SILICONE - 80ML CARTRIDGE	1	PZ	TR1106B0		1	PZ	VI1220A1	4,2X12 TCB SELF-TAPPING SCREW	2	PZ					
Code	Description	Qty	UOM																						
GN1285A0	NTC TEMPERATURE PROBE SEALING	1	PZ																						
SL1045A0	S57 BLACK SILICONE - 80ML CARTRIDGE	1	PZ																						
TR1106B0		1	PZ																						
VI1220A1	4,2X12 TCB SELF-TAPPING SCREW	2	PZ																						
0H2730A	ZINC PLATED MUFFLE SUPPORT BRACKET		0H2730A1	ZINC PLATED MUFFLE SUPPORT BRACKET																					
GN1285A	NTC TEMPERATURE PROBE SEALING		KTR1106B	MIND.MAPS L2000 CHAMBER TEMP. PROBE KIT	<table border="1"> <thead> <tr> <th>Code</th> <th>Description</th> <th>Qty</th> <th>UOM</th> </tr> </thead> <tbody> <tr> <td>GN1285A0</td> <td>NTC TEMPERATURE PROBE SEALING</td> <td>1</td> <td>PZ</td> </tr> <tr> <td>SL1045A0</td> <td>S57 BLACK SILICONE - 80ML CARTRIDGE</td> <td>1</td> <td>PZ</td> </tr> <tr> <td>TR1106B0</td> <td></td> <td>1</td> <td>PZ</td> </tr> <tr> <td>VI1220A1</td> <td>4,2X12 TCB SELF-TAPPING SCREW</td> <td>2</td> <td>PZ</td> </tr> </tbody> </table>	Code	Description	Qty	UOM	GN1285A0	NTC TEMPERATURE PROBE SEALING	1	PZ	SL1045A0	S57 BLACK SILICONE - 80ML CARTRIDGE	1	PZ	TR1106B0		1	PZ	VI1220A1	4,2X12 TCB SELF-TAPPING SCREW	2	PZ
					Code	Description	Qty	UOM																	
					GN1285A0	NTC TEMPERATURE PROBE SEALING	1	PZ																	
					SL1045A0	S57 BLACK SILICONE - 80ML CARTRIDGE	1	PZ																	
TR1106B0		1	PZ																						
VI1220A1	4,2X12 TCB SELF-TAPPING SCREW	2	PZ																						





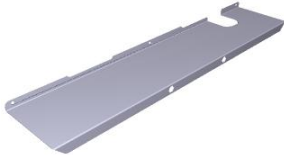

COMPONENT			SPARE PART																											
Code	Description	Image	Code	Description	Components list																									
GN1285A	NTC TEMPERATURE PROBE SEALING		KTR1106B	MIND.MAPS L2000 CHAMBER TEMP. PROBE KIT	<table border="1"> <thead> <tr> <th>Code</th> <th>Description</th> <th>Qty</th> <th>UOM</th> </tr> </thead> <tbody> <tr> <td>VM1464A1</td> <td>CT BT TEMPERATUR E PROBE COVER</td> <td>1</td> <td>PZ</td> </tr> <tr> <td>VM1465A0</td> <td>CHEFTOP TEMPERATUR E PROBE COVER</td> <td>1</td> <td>PZ</td> </tr> <tr> <td>VM1465A1</td> <td>CT BT TEMPERATUR E PROBE COVER</td> <td>1</td> <td>PZ</td> </tr> </tbody> </table>	Code	Description	Qty	UOM	VM1464A1	CT BT TEMPERATUR E PROBE COVER	1	PZ	VM1465A0	CHEFTOP TEMPERATUR E PROBE COVER	1	PZ	VM1465A1	CT BT TEMPERATUR E PROBE COVER	1	PZ									
			Code	Description	Qty	UOM																								
			VM1464A1	CT BT TEMPERATUR E PROBE COVER	1	PZ																								
VM1465A0	CHEFTOP TEMPERATUR E PROBE COVER	1	PZ																											
VM1465A1	CT BT TEMPERATUR E PROBE COVER	1	PZ																											
KTR1106A	5-5E S. L2000 CHAMBER TEMP. PROBE KIT	<table border="1"> <thead> <tr> <th>Code</th> <th>Description</th> <th>Qty</th> <th>UOM</th> </tr> </thead> <tbody> <tr> <td>GN1285A0</td> <td>NTC TEMPERATUR E PROBE SEALING</td> <td>1</td> <td>PZ</td> </tr> <tr> <td>SL1045A0</td> <td>S57 BLACK SILICONE - 80ML CARTRIDGE</td> <td>1</td> <td>PZ</td> </tr> <tr> <td>TR1106A3</td> <td>PT100 L=2000 TEMPERATUR E PROBE</td> <td>1</td> <td>PZ</td> </tr> <tr> <td>VI1220A1</td> <td>4,2X12 TCB SELF-TAPPIN G SCREW</td> <td>2</td> <td>PZ</td> </tr> <tr> <td>VM1465A0</td> <td>CHEFTOP TEMPERATUR E PROBE COVER</td> <td>1</td> <td>PZ</td> </tr> <tr> <td>VM1465A1</td> <td>CT BT TEMPERATUR E PROBE COVER</td> <td>1</td> <td>PZ</td> </tr> </tbody> </table>	Code	Description	Qty	UOM	GN1285A0	NTC TEMPERATUR E PROBE SEALING	1	PZ	SL1045A0	S57 BLACK SILICONE - 80ML CARTRIDGE	1	PZ	TR1106A3	PT100 L=2000 TEMPERATUR E PROBE	1	PZ	VI1220A1	4,2X12 TCB SELF-TAPPIN G SCREW	2	PZ	VM1465A0	CHEFTOP TEMPERATUR E PROBE COVER	1	PZ	VM1465A1	CT BT TEMPERATUR E PROBE COVER	1	PZ
Code	Description	Qty	UOM																											
GN1285A0	NTC TEMPERATUR E PROBE SEALING	1	PZ																											
SL1045A0	S57 BLACK SILICONE - 80ML CARTRIDGE	1	PZ																											
TR1106A3	PT100 L=2000 TEMPERATUR E PROBE	1	PZ																											
VI1220A1	4,2X12 TCB SELF-TAPPIN G SCREW	2	PZ																											
VM1465A0	CHEFTOP TEMPERATUR E PROBE COVER	1	PZ																											
VM1465A1	CT BT TEMPERATUR E PROBE COVER	1	PZ																											
KTR1105A	PT100 L1000 TEMPERATURE PROBE KIT	<table border="1"> <thead> <tr> <th>Code</th> <th>Description</th> <th>Qty</th> <th>UOM</th> </tr> </thead> <tbody> <tr> <td>GN1120A0</td> <td>NTC TEMPERATUR E PROBE SEAL</td> <td>1</td> <td>PZ</td> </tr> <tr> <td>GN1120A1</td> <td>NTC TEMPERATUR E PROBE SEAL</td> <td>1</td> <td>PZ</td> </tr> <tr> <td>GN1285A0</td> <td>NTC TEMPERATUR E PROBE SEALING</td> <td>1</td> <td>PZ</td> </tr> <tr> <td>MOV0010A0</td> <td>HOOD RING GASKET GN1110A2</td> <td>0.100</td> <td>PZ</td> </tr> <tr> <td>SL1045A0</td> <td>S57 BLACK SILICONE - 80ML CARTRIDGE</td> <td>1</td> <td>PZ</td> </tr> </tbody> </table>	Code	Description	Qty	UOM	GN1120A0	NTC TEMPERATUR E PROBE SEAL	1	PZ	GN1120A1	NTC TEMPERATUR E PROBE SEAL	1	PZ	GN1285A0	NTC TEMPERATUR E PROBE SEALING	1	PZ	MOV0010A0	HOOD RING GASKET GN1110A2	0.100	PZ	SL1045A0	S57 BLACK SILICONE - 80ML CARTRIDGE	1	PZ				
Code	Description	Qty	UOM																											
GN1120A0	NTC TEMPERATUR E PROBE SEAL	1	PZ																											
GN1120A1	NTC TEMPERATUR E PROBE SEAL	1	PZ																											
GN1285A0	NTC TEMPERATUR E PROBE SEALING	1	PZ																											
MOV0010A0	HOOD RING GASKET GN1110A2	0.100	PZ																											
SL1045A0	S57 BLACK SILICONE - 80ML CARTRIDGE	1	PZ																											



COMPONENT			SPARE PART																																			
Code	Description	Image	Code	Description	Components list																																	
GN1285A	NTC TEMPERATURE PROBE SEALING		KTR1105A	PT100 L1000 TEMPERATURE PROBE KIT	<table border="1"> <thead> <tr> <th>Code</th> <th>Description</th> <th>Qty</th> <th>UOM</th> </tr> </thead> <tbody> <tr> <td>TR1105A4</td> <td>L1000 PT100 TEMPERATUR E PROBE</td> <td>1</td> <td>PZ</td> </tr> <tr> <td>VI1220A1</td> <td>4,2X12 TCB SELF-TAPPIN G SCREW</td> <td>2</td> <td>PZ</td> </tr> <tr> <td>VM1464A1</td> <td>CT BT TEMPERATUR E PROBE COVER</td> <td>1</td> <td>PZ</td> </tr> <tr> <td>VM1465A1</td> <td>CT BT TEMPERATUR E PROBE COVER</td> <td>1</td> <td>PZ</td> </tr> <tr> <td>VM2052A0</td> <td>LM CORE PROBE COVE</td> <td>1</td> <td>PZ</td> </tr> </tbody> </table>	Code	Description	Qty	UOM	TR1105A4	L1000 PT100 TEMPERATUR E PROBE	1	PZ	VI1220A1	4,2X12 TCB SELF-TAPPIN G SCREW	2	PZ	VM1464A1	CT BT TEMPERATUR E PROBE COVER	1	PZ	VM1465A1	CT BT TEMPERATUR E PROBE COVER	1	PZ	VM2052A0	LM CORE PROBE COVE	1	PZ									
			Code	Description	Qty	UOM																																
			TR1105A4	L1000 PT100 TEMPERATUR E PROBE	1	PZ																																
VI1220A1	4,2X12 TCB SELF-TAPPIN G SCREW	2	PZ																																			
VM1464A1	CT BT TEMPERATUR E PROBE COVER	1	PZ																																			
VM1465A1	CT BT TEMPERATUR E PROBE COVER	1	PZ																																			
VM2052A0	LM CORE PROBE COVE	1	PZ																																			
KTR1096A	NTC 150 L=1500 TEMPERATURE PROBE KIT	<table border="1"> <thead> <tr> <th>Code</th> <th>Description</th> <th>Qty</th> <th>UOM</th> </tr> </thead> <tbody> <tr> <td>GN1120A0</td> <td>NTC TEMPERATUR E PROBE SEAL</td> <td>1</td> <td>PZ</td> </tr> <tr> <td>GN1120A1</td> <td>NTC TEMPERATUR E PROBE SEAL</td> <td>1</td> <td>PZ</td> </tr> <tr> <td>GN1285A0</td> <td>NTC TEMPERATUR E PROBE SEALING</td> <td>2</td> <td>PZ</td> </tr> <tr> <td>SL1045A0</td> <td>S57 BLACK SILICONE - 80ML CARTRIDGE</td> <td>1</td> <td>PZ</td> </tr> <tr> <td>TR1096A0</td> <td>TEMPERATUR E PROBE NTC 150 L=1500</td> <td>1</td> <td>PZ</td> </tr> <tr> <td>VI1220A1</td> <td>4,2X12 TCB SELF-TAPPIN G SCREW</td> <td>2</td> <td>PZ</td> </tr> <tr> <td>VM1465A0</td> <td>CHEFTOP TEMPERATUR E PROBE COVER</td> <td>1</td> <td>PZ</td> </tr> <tr> <td>VM1465A1</td> <td>CT BT TEMPERATUR E PROBE COVER</td> <td>1</td> <td>PZ</td> </tr> </tbody> </table>	Code	Description	Qty	UOM	GN1120A0	NTC TEMPERATUR E PROBE SEAL	1	PZ	GN1120A1	NTC TEMPERATUR E PROBE SEAL	1	PZ	GN1285A0	NTC TEMPERATUR E PROBE SEALING	2	PZ	SL1045A0	S57 BLACK SILICONE - 80ML CARTRIDGE	1	PZ	TR1096A0	TEMPERATUR E PROBE NTC 150 L=1500	1	PZ	VI1220A1	4,2X12 TCB SELF-TAPPIN G SCREW	2	PZ	VM1465A0	CHEFTOP TEMPERATUR E PROBE COVER	1	PZ	VM1465A1	CT BT TEMPERATUR E PROBE COVER	1	PZ
Code	Description	Qty	UOM																																			
GN1120A0	NTC TEMPERATUR E PROBE SEAL	1	PZ																																			
GN1120A1	NTC TEMPERATUR E PROBE SEAL	1	PZ																																			
GN1285A0	NTC TEMPERATUR E PROBE SEALING	2	PZ																																			
SL1045A0	S57 BLACK SILICONE - 80ML CARTRIDGE	1	PZ																																			
TR1096A0	TEMPERATUR E PROBE NTC 150 L=1500	1	PZ																																			
VI1220A1	4,2X12 TCB SELF-TAPPIN G SCREW	2	PZ																																			
VM1465A0	CHEFTOP TEMPERATUR E PROBE COVER	1	PZ																																			
VM1465A1	CT BT TEMPERATUR E PROBE COVER	1	PZ																																			
KTR1095A	NTC 150 L=1050 TEMPERATURE PROBE KIT	<table border="1"> <thead> <tr> <th>Code</th> <th>Description</th> <th>Qty</th> <th>UOM</th> </tr> </thead> <tbody> <tr> <td>GN1120A0</td> <td>NTC TEMPERATUR E PROBE SEAL</td> <td>1</td> <td>PZ</td> </tr> <tr> <td>GN1120A1</td> <td>NTC TEMPERATUR E PROBE SEAL</td> <td>1</td> <td>PZ</td> </tr> </tbody> </table>	Code	Description	Qty	UOM	GN1120A0	NTC TEMPERATUR E PROBE SEAL	1	PZ	GN1120A1	NTC TEMPERATUR E PROBE SEAL	1	PZ																								
Code	Description	Qty	UOM																																			
GN1120A0	NTC TEMPERATUR E PROBE SEAL	1	PZ																																			
GN1120A1	NTC TEMPERATUR E PROBE SEAL	1	PZ																																			

COMPONENT			SPARE PART																														
Code	Description	Image	Code	Description	Components list																												
GN1285A	NTC TEMPERATURE PROBE SEALING		KTR1095A	NTC 150 L=1050 TEMPERATURE PROBE KIT	<table border="1"> <thead> <tr> <th>Code</th> <th>Description</th> <th>Qty</th> <th>UOM</th> </tr> </thead> <tbody> <tr> <td>GN1285A0</td> <td>NTC TEMPERATUR E PROBE SEALING</td> <td>1</td> <td>PZ</td> </tr> <tr> <td>SL1045A0</td> <td>S57 BLACK SILICONE - 80ML CARTRIDGE</td> <td>1</td> <td>PZ</td> </tr> <tr> <td>TR1095A0</td> <td>TEMPERATUR E PROBE NTC 150 L=1050</td> <td>1</td> <td>PZ</td> </tr> <tr> <td>VI1220A1</td> <td>4,2X12 TCB SELF-TAPPIN G SCREW</td> <td>2</td> <td>PZ</td> </tr> <tr> <td>VM1465A0</td> <td>CHEFTOP TEMPERATUR E PROBE COVER</td> <td>1</td> <td>PZ</td> </tr> <tr> <td>VM1465A1</td> <td>CT BT TEMPERATUR E PROBE COVER</td> <td>1</td> <td>PZ</td> </tr> </tbody> </table>	Code	Description	Qty	UOM	GN1285A0	NTC TEMPERATUR E PROBE SEALING	1	PZ	SL1045A0	S57 BLACK SILICONE - 80ML CARTRIDGE	1	PZ	TR1095A0	TEMPERATUR E PROBE NTC 150 L=1050	1	PZ	VI1220A1	4,2X12 TCB SELF-TAPPIN G SCREW	2	PZ	VM1465A0	CHEFTOP TEMPERATUR E PROBE COVER	1	PZ	VM1465A1	CT BT TEMPERATUR E PROBE COVER	1	PZ
			Code	Description	Qty	UOM																											
GN1285A0	NTC TEMPERATUR E PROBE SEALING	1	PZ																														
SL1045A0	S57 BLACK SILICONE - 80ML CARTRIDGE	1	PZ																														
TR1095A0	TEMPERATUR E PROBE NTC 150 L=1050	1	PZ																														
VI1220A1	4,2X12 TCB SELF-TAPPIN G SCREW	2	PZ																														
VM1465A0	CHEFTOP TEMPERATUR E PROBE COVER	1	PZ																														
VM1465A1	CT BT TEMPERATUR E PROBE COVER	1	PZ																														
KTR1002A	PT100 L1000 UL TEMPERATURE PROBE KIT	<table border="1"> <thead> <tr> <th>Code</th> <th>Description</th> <th>Qty</th> <th>UOM</th> </tr> </thead> <tbody> <tr> <td>GN1285A0</td> <td>NTC TEMPERATUR E PROBE SEALING</td> <td>2</td> <td>PZ</td> </tr> <tr> <td>SL1045A0</td> <td>S57 BLACK SILICONE - 80ML CARTRIDGE</td> <td>1</td> <td>PZ</td> </tr> <tr> <td>TR1002A1</td> <td></td> <td>1</td> <td>PZ</td> </tr> <tr> <td>VI1220A1</td> <td>4,2X12 TCB SELF-TAPPIN G SCREW</td> <td>2</td> <td>PZ</td> </tr> <tr> <td>VM1465A0</td> <td>CHEFTOP TEMPERATUR E PROBE COVER</td> <td>1</td> <td>PZ</td> </tr> <tr> <td>VM1465A1</td> <td>CT BT TEMPERATUR E PROBE COVER</td> <td>1</td> <td>PZ</td> </tr> </tbody> </table>	Code	Description	Qty	UOM	GN1285A0	NTC TEMPERATUR E PROBE SEALING	2	PZ	SL1045A0	S57 BLACK SILICONE - 80ML CARTRIDGE	1	PZ	TR1002A1		1	PZ	VI1220A1	4,2X12 TCB SELF-TAPPIN G SCREW	2	PZ	VM1465A0	CHEFTOP TEMPERATUR E PROBE COVER	1	PZ	VM1465A1	CT BT TEMPERATUR E PROBE COVER	1	PZ			
Code	Description	Qty	UOM																														
GN1285A0	NTC TEMPERATUR E PROBE SEALING	2	PZ																														
SL1045A0	S57 BLACK SILICONE - 80ML CARTRIDGE	1	PZ																														
TR1002A1		1	PZ																														
VI1220A1	4,2X12 TCB SELF-TAPPIN G SCREW	2	PZ																														
VM1465A0	CHEFTOP TEMPERATUR E PROBE COVER	1	PZ																														
VM1465A1	CT BT TEMPERATUR E PROBE COVER	1	PZ																														
VM1464A	CT BT TEMPERATURE PROBE COVER		KVM1464A	CT BT TEMPERATURE PROBE COVER KIT	<table border="1"> <thead> <tr> <th>Code</th> <th>Description</th> <th>Qty</th> <th>UOM</th> </tr> </thead> <tbody> <tr> <td>VM1224A0</td> <td>65MY 220MM COLOURS SHRINK TUBE</td> <td>2</td> <td>M</td> </tr> <tr> <td>VM1464A1</td> <td>CT BT TEMPERATUR E PROBE COVER</td> <td>1</td> <td>PZ</td> </tr> </tbody> </table>	Code	Description	Qty	UOM	VM1224A0	65MY 220MM COLOURS SHRINK TUBE	2	M	VM1464A1	CT BT TEMPERATUR E PROBE COVER	1	PZ																
Code	Description	Qty	UOM																														
VM1224A0	65MY 220MM COLOURS SHRINK TUBE	2	M																														
VM1464A1	CT BT TEMPERATUR E PROBE COVER	1	PZ																														

COMPONENT			SPARE PART																																		
Code	Description	Image	Code	Description	Components list																																
TR1106B			KTR1106B	MIND.MAPS L2000 CHAMBER TEMP. PROBE KIT	<table border="1"> <thead> <tr> <th>Code</th> <th>Description</th> <th>Qty</th> <th>UOM</th> </tr> </thead> <tbody> <tr> <td>GN1285A0</td> <td>NTC TEMPERATUR E PROBE SEALING</td> <td>1</td> <td>PZ</td> </tr> <tr> <td>SL1045A0</td> <td>S57 BLACK SILICONE - 80ML CARTRIDGE</td> <td>1</td> <td>PZ</td> </tr> <tr> <td>TR1106B0</td> <td></td> <td>1</td> <td>PZ</td> </tr> <tr> <td>VI1220A1</td> <td>4,2X12 TCB SELF-TAPPIN G SCREW</td> <td>2</td> <td>PZ</td> </tr> <tr> <td>VM1464A1</td> <td>CT BT TEMPERATUR E PROBE COVER</td> <td>1</td> <td>PZ</td> </tr> <tr> <td>VM1465A0</td> <td>CHEFTOP TEMPERATUR E PROBE COVER</td> <td>1</td> <td>PZ</td> </tr> <tr> <td>VM1465A1</td> <td>CT BT TEMPERATUR E PROBE COVER</td> <td>1</td> <td>PZ</td> </tr> </tbody> </table>	Code	Description	Qty	UOM	GN1285A0	NTC TEMPERATUR E PROBE SEALING	1	PZ	SL1045A0	S57 BLACK SILICONE - 80ML CARTRIDGE	1	PZ	TR1106B0		1	PZ	VI1220A1	4,2X12 TCB SELF-TAPPIN G SCREW	2	PZ	VM1464A1	CT BT TEMPERATUR E PROBE COVER	1	PZ	VM1465A0	CHEFTOP TEMPERATUR E PROBE COVER	1	PZ	VM1465A1	CT BT TEMPERATUR E PROBE COVER	1	PZ
Code	Description	Qty	UOM																																		
GN1285A0	NTC TEMPERATUR E PROBE SEALING	1	PZ																																		
SL1045A0	S57 BLACK SILICONE - 80ML CARTRIDGE	1	PZ																																		
TR1106B0		1	PZ																																		
VI1220A1	4,2X12 TCB SELF-TAPPIN G SCREW	2	PZ																																		
VM1464A1	CT BT TEMPERATUR E PROBE COVER	1	PZ																																		
VM1465A0	CHEFTOP TEMPERATUR E PROBE COVER	1	PZ																																		
VM1465A1	CT BT TEMPERATUR E PROBE COVER	1	PZ																																		
OG1558A	FAN GUARD SPACE		KOG1558A	SPACER FAN GUARD KIT	<table border="1"> <thead> <tr> <th>Code</th> <th>Description</th> <th>Qty</th> <th>UOM</th> </tr> </thead> <tbody> <tr> <td>OG1558A0</td> <td>FAN GUARD SPACER</td> <td>1</td> <td>PZ</td> </tr> <tr> <td>IP1508A1</td> <td>POLYSTYREN E U SHAPED PROFILE 2000X60X60</td> <td>1.400</td> <td>M</td> </tr> <tr> <td>VM1059A1</td> <td>HEAT SHRINK FILM H800</td> <td>1.500</td> <td>M</td> </tr> </tbody> </table>	Code	Description	Qty	UOM	OG1558A0	FAN GUARD SPACER	1	PZ	IP1508A1	POLYSTYREN E U SHAPED PROFILE 2000X60X60	1.400	M	VM1059A1	HEAT SHRINK FILM H800	1.500	M																
Code	Description	Qty	UOM																																		
OG1558A0	FAN GUARD SPACER	1	PZ																																		
IP1508A1	POLYSTYREN E U SHAPED PROFILE 2000X60X60	1.400	M																																		
VM1059A1	HEAT SHRINK FILM H800	1.500	M																																		
GRL1396A	7 GN1/1 0711 LEFT LATERAL SUPPORT		KGRL1395A	MIND.MAPS 7 GN1/1 LATERAL SUPPORTS KIT	<table border="1"> <thead> <tr> <th>Code</th> <th>Description</th> <th>Qty</th> <th>UOM</th> </tr> </thead> <tbody> <tr> <td>0H4420A0</td> <td>STAINLESS STEEL CORE TEMPERATUR</td> <td>1</td> <td>PZ</td> </tr> <tr> <td>0H7302A0</td> <td>0H7312+0H731 3 FLAT SUPPORTING PROFILE</td> <td>2</td> <td>PZ</td> </tr> <tr> <td>0H7303A0</td> <td>0H7314+0H731 5 FLAT SUPPORTING PROFILE</td> <td>2</td> <td>PZ</td> </tr> <tr> <td>0H7797A0</td> <td>GN1/1 L287 TRAYS GUIDE SLOTTED PROFILE</td> <td>14</td> <td>PZ</td> </tr> </tbody> </table>	Code	Description	Qty	UOM	0H4420A0	STAINLESS STEEL CORE TEMPERATUR	1	PZ	0H7302A0	0H7312+0H731 3 FLAT SUPPORTING PROFILE	2	PZ	0H7303A0	0H7314+0H731 5 FLAT SUPPORTING PROFILE	2	PZ	0H7797A0	GN1/1 L287 TRAYS GUIDE SLOTTED PROFILE	14	PZ												
Code	Description	Qty	UOM																																		
0H4420A0	STAINLESS STEEL CORE TEMPERATUR	1	PZ																																		
0H7302A0	0H7312+0H731 3 FLAT SUPPORTING PROFILE	2	PZ																																		
0H7303A0	0H7314+0H731 5 FLAT SUPPORTING PROFILE	2	PZ																																		
0H7797A0	GN1/1 L287 TRAYS GUIDE SLOTTED PROFILE	14	PZ																																		

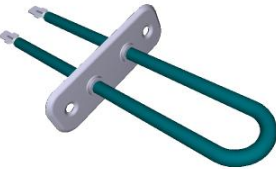

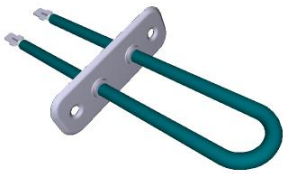

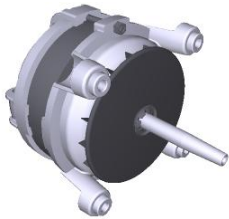
COMPONENT			SPARE PART																														
Code	Description	Image	Code	Description	Components list																												
GRL1396A	7 GN1/1 0711 LEFT LATERAL SUPPORT		KGRL1395A	MIND.MAPS 7 GN1/1 LATERAL SUPPORTS KIT	<table border="1"> <thead> <tr> <th>Code</th> <th>Description</th> <th>Qty</th> <th>UOM</th> </tr> </thead> <tbody> <tr> <td>IP1508A1</td> <td>POLYSTYREN E U SHAPED PROFILE 2000X60X60</td> <td>1.200</td> <td>M</td> </tr> <tr> <td>VM1059A1</td> <td>HEAT SHRINK FILM H800</td> <td>1.500</td> <td>M</td> </tr> </tbody> </table>	Code	Description	Qty	UOM	IP1508A1	POLYSTYREN E U SHAPED PROFILE 2000X60X60	1.200	M	VM1059A1	HEAT SHRINK FILM H800	1.500	M																
Code	Description	Qty	UOM																														
IP1508A1	POLYSTYREN E U SHAPED PROFILE 2000X60X60	1.200	M																														
VM1059A1	HEAT SHRINK FILM H800	1.500	M																														
GRL1395A	7 GN1/1 0711 RIGHT LATERAL SUPPORT		KGRL1395A	MIND.MAPS 7 GN1/1 LATERAL SUPPORTS KIT	<table border="1"> <thead> <tr> <th>Code</th> <th>Description</th> <th>Qty</th> <th>UOM</th> </tr> </thead> <tbody> <tr> <td>0H4420A0</td> <td>STAINLESS STEEL CORE TEMPERATUR</td> <td>1</td> <td>PZ</td> </tr> <tr> <td>0H7302A0</td> <td>0H7312+0H731 3 FLAT SUPPORTING PROFILE</td> <td>2</td> <td>PZ</td> </tr> <tr> <td>0H7303A0</td> <td>0H7314+0H731 5 FLAT SUPPORTING PROFILE</td> <td>2</td> <td>PZ</td> </tr> <tr> <td>0H7797A0</td> <td>GN1/1 L287 TRAYS GUIDE SLOTTED PROFILE</td> <td>14</td> <td>PZ</td> </tr> <tr> <td>IP1508A1</td> <td>POLYSTYREN E U SHAPED PROFILE 2000X60X60</td> <td>1.200</td> <td>M</td> </tr> <tr> <td>VM1059A1</td> <td>HEAT SHRINK FILM H800</td> <td>1.500</td> <td>M</td> </tr> </tbody> </table>	Code	Description	Qty	UOM	0H4420A0	STAINLESS STEEL CORE TEMPERATUR	1	PZ	0H7302A0	0H7312+0H731 3 FLAT SUPPORTING PROFILE	2	PZ	0H7303A0	0H7314+0H731 5 FLAT SUPPORTING PROFILE	2	PZ	0H7797A0	GN1/1 L287 TRAYS GUIDE SLOTTED PROFILE	14	PZ	IP1508A1	POLYSTYREN E U SHAPED PROFILE 2000X60X60	1.200	M	VM1059A1	HEAT SHRINK FILM H800	1.500	M
Code	Description	Qty	UOM																														
0H4420A0	STAINLESS STEEL CORE TEMPERATUR	1	PZ																														
0H7302A0	0H7312+0H731 3 FLAT SUPPORTING PROFILE	2	PZ																														
0H7303A0	0H7314+0H731 5 FLAT SUPPORTING PROFILE	2	PZ																														
0H7797A0	GN1/1 L287 TRAYS GUIDE SLOTTED PROFILE	14	PZ																														
IP1508A1	POLYSTYREN E U SHAPED PROFILE 2000X60X60	1.200	M																														
VM1059A1	HEAT SHRINK FILM H800	1.500	M																														
GN1630A			KGN1630A	0711 DOOR GASKET KIT	<table border="1"> <thead> <tr> <th>Code</th> <th>Description</th> <th>Qty</th> <th>UOM</th> </tr> </thead> <tbody> <tr> <td>GN1626A0</td> <td>DOUBLE LIP-TYPE FRONT GASKE</td> <td>2.260</td> <td>M</td> </tr> <tr> <td>SL1025A0</td> <td>CLEAR SILICON DOW CORNING 734</td> <td>0.012</td> <td>PZ</td> </tr> <tr> <td>VM1224A0</td> <td>65MY 220MM 2 COLOURS SHRINK TUBE</td> <td>0.400</td> <td>M</td> </tr> <tr> <td>VM2277A0</td> <td>DOOR SEAL KIT INTERNAL CONNECTION</td> <td>1</td> <td>PZ</td> </tr> </tbody> </table>	Code	Description	Qty	UOM	GN1626A0	DOUBLE LIP-TYPE FRONT GASKE	2.260	M	SL1025A0	CLEAR SILICON DOW CORNING 734	0.012	PZ	VM1224A0	65MY 220MM 2 COLOURS SHRINK TUBE	0.400	M	VM2277A0	DOOR SEAL KIT INTERNAL CONNECTION	1	PZ								
Code	Description	Qty	UOM																														
GN1626A0	DOUBLE LIP-TYPE FRONT GASKE	2.260	M																														
SL1025A0	CLEAR SILICON DOW CORNING 734	0.012	PZ																														
VM1224A0	65MY 220MM 2 COLOURS SHRINK TUBE	0.400	M																														
VM2277A0	DOOR SEAL KIT INTERNAL CONNECTION	1	PZ																														

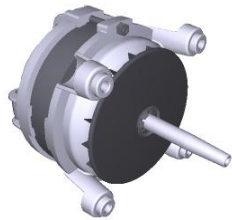

COMPONENT			SPARE PART																														
Code	Description	Image	Code	Description	Components list																												
GN1531A	THERMOSTAT BULB INLET SEALING		KTR1136A	330 °C SAFETY THERMOSTAT KIT	<table border="1"> <thead> <tr> <th>Code</th> <th>Description</th> <th>Qty</th> <th>UOM</th> </tr> </thead> <tbody> <tr> <td>0H7030A0</td> <td>THERMOSTAT BULB INLET COVER</td> <td>1</td> <td>PZ</td> </tr> <tr> <td>GN1531A0</td> <td>THERMOSTAT BULB INLET SEALING</td> <td>1</td> <td>PZ</td> </tr> <tr> <td>MOV0011A0</td> <td>HOOD RING GASKET GN1110A2</td> <td>0.100</td> <td>PZ</td> </tr> <tr> <td>SL1045A0</td> <td>S57 BLACK SILICONE - 80ML CARTRIDGE</td> <td>1</td> <td>PZ</td> </tr> <tr> <td>TR1136A0</td> <td>330 °C 1 POLE SAFETY THERMOSTAT</td> <td>1</td> <td>PZ</td> </tr> <tr> <td>VI1220A1</td> <td>4,2X12 TCB SELF-TAPPIN G SCREW</td> <td>3</td> <td>PZ</td> </tr> </tbody> </table>	Code	Description	Qty	UOM	0H7030A0	THERMOSTAT BULB INLET COVER	1	PZ	GN1531A0	THERMOSTAT BULB INLET SEALING	1	PZ	MOV0011A0	HOOD RING GASKET GN1110A2	0.100	PZ	SL1045A0	S57 BLACK SILICONE - 80ML CARTRIDGE	1	PZ	TR1136A0	330 °C 1 POLE SAFETY THERMOSTAT	1	PZ	VI1220A1	4,2X12 TCB SELF-TAPPIN G SCREW	3	PZ
					Code	Description	Qty	UOM																									
					0H7030A0	THERMOSTAT BULB INLET COVER	1	PZ																									
					GN1531A0	THERMOSTAT BULB INLET SEALING	1	PZ																									
					MOV0011A0	HOOD RING GASKET GN1110A2	0.100	PZ																									
					SL1045A0	S57 BLACK SILICONE - 80ML CARTRIDGE	1	PZ																									
					TR1136A0	330 °C 1 POLE SAFETY THERMOSTAT	1	PZ																									
VI1220A1	4,2X12 TCB SELF-TAPPIN G SCREW	3	PZ																														
0H7030A	THERMOSTAT BULB INLET COVER		K0H7030A	THERMOSTAT BULB INLET COVER KIT	<table border="1"> <thead> <tr> <th>Code</th> <th>Description</th> <th>Qty</th> <th>UOM</th> </tr> </thead> <tbody> <tr> <td>0H7030A0</td> <td>THERMOSTAT BULB INLET COVER</td> <td>1</td> <td>PZ</td> </tr> <tr> <td>VM1224A0</td> <td>65MY 220MM COLOURS SHRINK TUBE</td> <td>0.200</td> <td>M</td> </tr> </tbody> </table>	Code	Description	Qty	UOM	0H7030A0	THERMOSTAT BULB INLET COVER	1	PZ	VM1224A0	65MY 220MM COLOURS SHRINK TUBE	0.200	M																
					Code	Description	Qty	UOM																									
0H7030A0	THERMOSTAT BULB INLET COVER	1	PZ																														
VM1224A0	65MY 220MM COLOURS SHRINK TUBE	0.200	M																														
RS1215B	1 TURN 147W 105V FLAT ELEMENT		KRS1215B	147W MOTOR BRAKING ELEMENT KIT	<table border="1"> <thead> <tr> <th>Code</th> <th>Description</th> <th>Qty</th> <th>UOM</th> </tr> </thead> <tbody> <tr> <td>GN1672A1</td> <td>RS1274A ELEMENT GASKET</td> <td>1</td> <td>PZ</td> </tr> <tr> <td>MOV0009A0</td> <td>HOOD RING GASKET GN1110A2</td> <td>0.100</td> <td>PZ</td> </tr> <tr> <td>RS1215B0</td> <td>1 TURN 147W 105V FLAT ELEMENT</td> <td>1</td> <td>PZ</td> </tr> <tr> <td>SL1045A0</td> <td>S57 BLACK SILICONE - 80ML CARTRIDGE</td> <td>1</td> <td>PZ</td> </tr> <tr> <td>VI1220A1</td> <td>4,2X12 TCB SELF-TAPPIN G SCREW</td> <td>2</td> <td>PZ</td> </tr> </tbody> </table>	Code	Description	Qty	UOM	GN1672A1	RS1274A ELEMENT GASKET	1	PZ	MOV0009A0	HOOD RING GASKET GN1110A2	0.100	PZ	RS1215B0	1 TURN 147W 105V FLAT ELEMENT	1	PZ	SL1045A0	S57 BLACK SILICONE - 80ML CARTRIDGE	1	PZ	VI1220A1	4,2X12 TCB SELF-TAPPIN G SCREW	2	PZ				
					Code	Description	Qty	UOM																									
					GN1672A1	RS1274A ELEMENT GASKET	1	PZ																									
					MOV0009A0	HOOD RING GASKET GN1110A2	0.100	PZ																									
					RS1215B0	1 TURN 147W 105V FLAT ELEMENT	1	PZ																									
			SL1045A0	S57 BLACK SILICONE - 80ML CARTRIDGE	1	PZ																											
			VI1220A1	4,2X12 TCB SELF-TAPPIN G SCREW	2	PZ																											
			KRS0026A	BIG-L 147W MOTOR BRAKING ELEMENT KIT	<table border="1"> <thead> <tr> <th>Code</th> <th>Description</th> <th>Qty</th> <th>UOM</th> </tr> </thead> <tbody> <tr> <td>GN1672A0</td> <td>RS1274A ELEMENT GASKET</td> <td>1</td> <td>PZ</td> </tr> <tr> <td>GN1672A1</td> <td>RS1274A ELEMENT GASKET</td> <td>1</td> <td>PZ</td> </tr> </tbody> </table>	Code	Description	Qty	UOM	GN1672A0	RS1274A ELEMENT GASKET	1	PZ	GN1672A1	RS1274A ELEMENT GASKET	1	PZ																
					Code	Description	Qty	UOM																									
					GN1672A0	RS1274A ELEMENT GASKET	1	PZ																									
GN1672A1	RS1274A ELEMENT GASKET	1			PZ																												

COMPONENT			SPARE PART																																														
Code	Description	Image	Code	Description	Components list																																												
RS1215B	1 TURN 147W 105V FLAT ELEMENT		KRS0026A	BIG-L 147W MOTOR BRAKING ELEMENT KIT	<table border="1"> <thead> <tr> <th>Code</th> <th>Description</th> <th>Qty</th> <th>UOM</th> </tr> </thead> <tbody> <tr> <td>RS1215A1</td> <td>147W 105V BRAKING ELEMENT</td> <td>1</td> <td>PZ</td> </tr> <tr> <td>SL1045A0</td> <td>S57 BLACK SILICONE - 80ML CARTRIDGE</td> <td>1</td> <td>PZ</td> </tr> <tr> <td>VI1220A1</td> <td>4,2X12 TCB SELF-TAPPIN G SCREW</td> <td>2</td> <td>PZ</td> </tr> </tbody> </table>	Code	Description	Qty	UOM	RS1215A1	147W 105V BRAKING ELEMENT	1	PZ	SL1045A0	S57 BLACK SILICONE - 80ML CARTRIDGE	1	PZ	VI1220A1	4,2X12 TCB SELF-TAPPIN G SCREW	2	PZ																												
					Code	Description	Qty	UOM																																									
					RS1215A1	147W 105V BRAKING ELEMENT	1	PZ																																									
SL1045A0	S57 BLACK SILICONE - 80ML CARTRIDGE	1	PZ																																														
VI1220A1	4,2X12 TCB SELF-TAPPIN G SCREW	2	PZ																																														
GN1672A	RS1274A ELEMENT GASKET		KG1672A	71X19 HEATING ELEMENT GASKET 5 PCS KIT	<table border="1"> <thead> <tr> <th>Code</th> <th>Description</th> <th>Qty</th> <th>UOM</th> </tr> </thead> <tbody> <tr> <td>GN1672A0</td> <td></td> <td>5</td> <td>PZ</td> </tr> <tr> <td>GN1672A1</td> <td>RS1274A ELEMENT GASKET</td> <td>5</td> <td>PZ</td> </tr> <tr> <td>VM1224A0</td> <td>65MY 220MM 2 COLOURS SHRINK TUBE</td> <td>0.250</td> <td>M</td> </tr> </tbody> </table>	Code	Description	Qty	UOM	GN1672A0		5	PZ	GN1672A1	RS1274A ELEMENT GASKET	5	PZ	VM1224A0	65MY 220MM 2 COLOURS SHRINK TUBE	0.250	M																												
Code	Description	Qty	UOM																																														
GN1672A0		5	PZ																																														
GN1672A1	RS1274A ELEMENT GASKET	5	PZ																																														
VM1224A0	65MY 220MM 2 COLOURS SHRINK TUBE	0.250	M																																														
MT1012A	330W 230V MOTOR		KVN1130A	LUX =08.2017/S.5/S.5E 330W MOTOR KIT	<table border="1"> <thead> <tr> <th>Code</th> <th>Description</th> <th>Qty</th> <th>UOM</th> </tr> </thead> <tbody> <tr> <td>0H4305A1</td> <td>ST. STEEL MOTOR SHAFT SEALING DISC</td> <td>1</td> <td>PZ</td> </tr> <tr> <td>GN1140A2</td> <td>MOTOR HOLDER GASKET</td> <td>1</td> <td>PZ</td> </tr> <tr> <td>GN1140A3</td> <td>MOLDED MOTOR HOLDER GASKET</td> <td>1</td> <td>PZ</td> </tr> <tr> <td>VI1045A0</td> <td>16X8,4 TH=1,6 ST.STEEL WASHER</td> <td>1</td> <td>PZ</td> </tr> <tr> <td>VI1256A0</td> <td>M8 DIN 980M ST. STEEL SELF LOCKING NUT</td> <td>1</td> <td>PZ</td> </tr> <tr> <td>VM1794A0</td> <td>250X4.8 PA66 BLACK CLAMP</td> <td>4</td> <td>PZ</td> </tr> <tr> <td>VM2103A0</td> <td>CLAMP LOCK</td> <td>4</td> <td>PZ</td> </tr> <tr> <td>VM2196A0</td> <td>MOTOR NUT FASTENING BUSHING</td> <td>1</td> <td>PZ</td> </tr> <tr> <td>VN1130A1</td> <td>330W 230V 50/60HZ MOTO</td> <td>1</td> <td>PZ</td> </tr> <tr> <td>VN1130A1</td> <td>330W 230V 50/60HZ MOTO</td> <td>1</td> <td>PZ</td> </tr> </tbody> </table>	Code	Description	Qty	UOM	0H4305A1	ST. STEEL MOTOR SHAFT SEALING DISC	1	PZ	GN1140A2	MOTOR HOLDER GASKET	1	PZ	GN1140A3	MOLDED MOTOR HOLDER GASKET	1	PZ	VI1045A0	16X8,4 TH=1,6 ST.STEEL WASHER	1	PZ	VI1256A0	M8 DIN 980M ST. STEEL SELF LOCKING NUT	1	PZ	VM1794A0	250X4.8 PA66 BLACK CLAMP	4	PZ	VM2103A0	CLAMP LOCK	4	PZ	VM2196A0	MOTOR NUT FASTENING BUSHING	1	PZ	VN1130A1	330W 230V 50/60HZ MOTO	1	PZ	VN1130A1	330W 230V 50/60HZ MOTO	1	PZ
Code	Description	Qty	UOM																																														
0H4305A1	ST. STEEL MOTOR SHAFT SEALING DISC	1	PZ																																														
GN1140A2	MOTOR HOLDER GASKET	1	PZ																																														
GN1140A3	MOLDED MOTOR HOLDER GASKET	1	PZ																																														
VI1045A0	16X8,4 TH=1,6 ST.STEEL WASHER	1	PZ																																														
VI1256A0	M8 DIN 980M ST. STEEL SELF LOCKING NUT	1	PZ																																														
VM1794A0	250X4.8 PA66 BLACK CLAMP	4	PZ																																														
VM2103A0	CLAMP LOCK	4	PZ																																														
VM2196A0	MOTOR NUT FASTENING BUSHING	1	PZ																																														
VN1130A1	330W 230V 50/60HZ MOTO	1	PZ																																														
VN1130A1	330W 230V 50/60HZ MOTO	1	PZ																																														
			KMT1012A	MIND.MAPS 330W 230V MOTOR KIT	<table border="1"> <thead> <tr> <th>Code</th> <th>Description</th> <th>Qty</th> <th>UOM</th> </tr> </thead> <tbody> <tr> <td>0H2842A0</td> <td></td> <td>1</td> <td>PZ</td> </tr> </tbody> </table>	Code	Description	Qty	UOM	0H2842A0		1	PZ																																				
Code	Description	Qty	UOM																																														
0H2842A0		1	PZ																																														

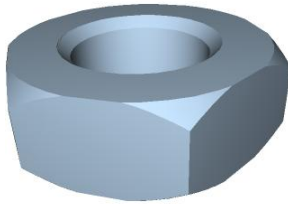
COMPONENT			SPARE PART																																																						
Code	Description	Image	Code	Description	Components list																																																				
MT1012A	330W 230V MOTOR		KMT1012A	MIND.MAPS 330W 230V MOTOR KIT	<table border="1"> <thead> <tr> <th>Code</th> <th>Description</th> <th>Qty</th> <th>UOM</th> </tr> </thead> <tbody> <tr> <td>0H4305A1</td> <td>ST. STEEL MOTOR SHAFT SEALING DISC</td> <td>1</td> <td>PZ</td> </tr> <tr> <td>GN1140A2</td> <td>MOTOR HOLDER GASKET</td> <td>1</td> <td>PZ</td> </tr> <tr> <td>GN1140A3</td> <td>MOLDED MOTOR HOLDER GASKET</td> <td>1</td> <td>PZ</td> </tr> <tr> <td>MOV0007A0</td> <td>HOOD RING GASKET GN1110A2</td> <td>0.100</td> <td>PZ</td> </tr> <tr> <td>MT1012A0</td> <td>330W 230V MOTOR</td> <td>1</td> <td>PZ</td> </tr> <tr> <td>VE1550A0</td> <td>5X3 MM NEODYMIUM MAGNET</td> <td>1</td> <td>PZ</td> </tr> <tr> <td>VI1077A1</td> <td>SCREW M6X12 TE INOX</td> <td>1</td> <td>PZ</td> </tr> <tr> <td>VI1521A0</td> <td>STAINLESS STEEL WASHER D=6 6592</td> <td>1</td> <td>PZ</td> </tr> <tr> <td>VI1966A0</td> <td>M4X14 FLATHEAD SCREW</td> <td>1</td> <td>PZ</td> </tr> <tr> <td>VM1635A0</td> <td>MAGNET HOLDING DIS</td> <td>1</td> <td>PZ</td> </tr> <tr> <td>VM1794A0</td> <td>250X4.8 PA66 BLACK CLAMP</td> <td>4</td> <td>PZ</td> </tr> <tr> <td>VM2103A0</td> <td>CLAMP LOCK</td> <td>4</td> <td>PZ</td> </tr> </tbody> </table>	Code	Description	Qty	UOM	0H4305A1	ST. STEEL MOTOR SHAFT SEALING DISC	1	PZ	GN1140A2	MOTOR HOLDER GASKET	1	PZ	GN1140A3	MOLDED MOTOR HOLDER GASKET	1	PZ	MOV0007A0	HOOD RING GASKET GN1110A2	0.100	PZ	MT1012A0	330W 230V MOTOR	1	PZ	VE1550A0	5X3 MM NEODYMIUM MAGNET	1	PZ	VI1077A1	SCREW M6X12 TE INOX	1	PZ	VI1521A0	STAINLESS STEEL WASHER D=6 6592	1	PZ	VI1966A0	M4X14 FLATHEAD SCREW	1	PZ	VM1635A0	MAGNET HOLDING DIS	1	PZ	VM1794A0	250X4.8 PA66 BLACK CLAMP	4	PZ	VM2103A0	CLAMP LOCK	4	PZ
					Code	Description	Qty	UOM																																																	
					0H4305A1	ST. STEEL MOTOR SHAFT SEALING DISC	1	PZ																																																	
					GN1140A2	MOTOR HOLDER GASKET	1	PZ																																																	
					GN1140A3	MOLDED MOTOR HOLDER GASKET	1	PZ																																																	
					MOV0007A0	HOOD RING GASKET GN1110A2	0.100	PZ																																																	
					MT1012A0	330W 230V MOTOR	1	PZ																																																	
					VE1550A0	5X3 MM NEODYMIUM MAGNET	1	PZ																																																	
					VI1077A1	SCREW M6X12 TE INOX	1	PZ																																																	
					VI1521A0	STAINLESS STEEL WASHER D=6 6592	1	PZ																																																	
					VI1966A0	M4X14 FLATHEAD SCREW	1	PZ																																																	
					VM1635A0	MAGNET HOLDING DIS	1	PZ																																																	
					VM1794A0	250X4.8 PA66 BLACK CLAMP	4	PZ																																																	
VM2103A0	CLAMP LOCK	4	PZ																																																						
0H4305A	ST. STEEL MOTOR SHAFT SEALING DIS		K0H4305A	SEALING DISC FOR MOTOR SHAFT KIT	<table border="1"> <thead> <tr> <th>Code</th> <th>Description</th> <th>Qty</th> <th>UOM</th> </tr> </thead> <tbody> <tr> <td>0H4305A1</td> <td>ST. STEEL MOTOR SHAFT SEALING DISC</td> <td>1</td> <td>PZ</td> </tr> <tr> <td>GN1140A2</td> <td>MOTOR HOLDER GASKET</td> <td>1</td> <td>PZ</td> </tr> <tr> <td>GN1140A3</td> <td>MOLDED MOTOR HOLDER GASKET</td> <td>1</td> <td>PZ</td> </tr> <tr> <td>SL1045A0</td> <td>S57 BLACK SILICONE - 80ML CARTRIDGE</td> <td>1</td> <td>PZ</td> </tr> <tr> <td>VI1220A1</td> <td>4,2X12 TCB SELF-TAPPIN G SCREW</td> <td>3</td> <td>PZ</td> </tr> </tbody> </table>	Code	Description	Qty	UOM	0H4305A1	ST. STEEL MOTOR SHAFT SEALING DISC	1	PZ	GN1140A2	MOTOR HOLDER GASKET	1	PZ	GN1140A3	MOLDED MOTOR HOLDER GASKET	1	PZ	SL1045A0	S57 BLACK SILICONE - 80ML CARTRIDGE	1	PZ	VI1220A1	4,2X12 TCB SELF-TAPPIN G SCREW	3	PZ																												
					Code	Description	Qty	UOM																																																	
					0H4305A1	ST. STEEL MOTOR SHAFT SEALING DISC	1	PZ																																																	
					GN1140A2	MOTOR HOLDER GASKET	1	PZ																																																	
					GN1140A3	MOLDED MOTOR HOLDER GASKET	1	PZ																																																	
					SL1045A0	S57 BLACK SILICONE - 80ML CARTRIDGE	1	PZ																																																	
VI1220A1	4,2X12 TCB SELF-TAPPIN G SCREW	3	PZ																																																						

COMPONENT			SPARE PART																						
Code	Description	Image	Code	Description	Components list																				
VN1170B	D195 H80 8 BLADES FAN+RING		KVN1170B	D195 H80 8 BLADES FAN + RING KIT	<table border="1"> <thead> <tr> <th>Code</th> <th>Description</th> <th>Qty</th> <th>UOM</th> </tr> </thead> <tbody> <tr> <td>VI1077A1</td> <td>SCREW M6X12 TE INOX</td> <td>1</td> <td>PZ</td> </tr> <tr> <td>VI1521A0</td> <td>STAINLESS STEEL WASHER D=6 6592</td> <td>1</td> <td>PZ</td> </tr> <tr> <td>VN1170B0</td> <td>D195 H80 8 BLADES FAN+RING</td> <td>1</td> <td>PZ</td> </tr> <tr> <td>VN1170B0</td> <td>D195 H80 8 BLADES FAN+RING</td> <td>1</td> <td>PZ</td> </tr> </tbody> </table>	Code	Description	Qty	UOM	VI1077A1	SCREW M6X12 TE INOX	1	PZ	VI1521A0	STAINLESS STEEL WASHER D=6 6592	1	PZ	VN1170B0	D195 H80 8 BLADES FAN+RING	1	PZ	VN1170B0	D195 H80 8 BLADES FAN+RING	1	PZ
					Code	Description	Qty	UOM																	
					VI1077A1	SCREW M6X12 TE INOX	1	PZ																	
					VI1521A0	STAINLESS STEEL WASHER D=6 6592	1	PZ																	
VN1170B0	D195 H80 8 BLADES FAN+RING	1	PZ																						
VN1170B0	D195 H80 8 BLADES FAN+RING	1	PZ																						
<table border="1"> <thead> <tr> <th>Code</th> <th>Description</th> <th>Qty</th> <th>UOM</th> </tr> </thead> <tbody> <tr> <td>GN1140A2</td> <td>MOTOR HOLDER GASKET</td> <td>5</td> <td>PZ</td> </tr> <tr> <td>GN1140A3</td> <td>MOLDED MOTOR HOLDER GASKET</td> <td>5</td> <td>PZ</td> </tr> <tr> <td>VM1224A0</td> <td>65MY 220MM 2 COLOURS SHRINK TUBE</td> <td>0.200</td> <td>M</td> </tr> </tbody> </table>	Code	Description	Qty	UOM	GN1140A2	MOTOR HOLDER GASKET	5	PZ	GN1140A3	MOLDED MOTOR HOLDER GASKET	5	PZ	VM1224A0	65MY 220MM 2 COLOURS SHRINK TUBE	0.200	M									
Code	Description	Qty	UOM																						
GN1140A2	MOTOR HOLDER GASKET	5	PZ																						
GN1140A3	MOLDED MOTOR HOLDER GASKET	5	PZ																						
VM1224A0	65MY 220MM 2 COLOURS SHRINK TUBE	0.200	M																						
<table border="1"> <thead> <tr> <th>Code</th> <th>Description</th> <th>Qty</th> <th>UOM</th> </tr> </thead> <tbody> <tr> <td>VM1224A0</td> <td>65MY 220MM 2 COLOURS SHRINK TUBE</td> <td>0.200</td> <td>M</td> </tr> <tr> <td>VM2332A0</td> <td>WATER PIPE BUSHING</td> <td>1</td> <td>PZ</td> </tr> <tr> <td>VM2332A0</td> <td>WATER PIPE BUSHING</td> <td>1</td> <td>PZ</td> </tr> <tr> <td>VM2332A1</td> <td>HUMIDITY PIPES WASHE</td> <td>1</td> <td>PZ</td> </tr> </tbody> </table>	Code	Description	Qty	UOM	VM1224A0	65MY 220MM 2 COLOURS SHRINK TUBE	0.200	M	VM2332A0	WATER PIPE BUSHING	1	PZ	VM2332A0	WATER PIPE BUSHING	1	PZ	VM2332A1	HUMIDITY PIPES WASHE	1	PZ					
Code	Description	Qty	UOM																						
VM1224A0	65MY 220MM 2 COLOURS SHRINK TUBE	0.200	M																						
VM2332A0	WATER PIPE BUSHING	1	PZ																						
VM2332A0	WATER PIPE BUSHING	1	PZ																						
VM2332A1	HUMIDITY PIPES WASHE	1	PZ																						
<table border="1"> <thead> <tr> <th>Code</th> <th>Description</th> <th>Qty</th> <th>UOM</th> </tr> </thead> <tbody> <tr> <td>VM1224A0</td> <td>65MY 220MM 2 COLOURS SHRINK TUBE</td> <td>0.200</td> <td>M</td> </tr> <tr> <td>VM2332A0</td> <td>WATER PIPE BUSHING</td> <td>1</td> <td>PZ</td> </tr> <tr> <td>VM2332A0</td> <td>WATER PIPE BUSHING</td> <td>1</td> <td>PZ</td> </tr> <tr> <td>VM2332A1</td> <td>HUMIDITY PIPES WASHE</td> <td>1</td> <td>PZ</td> </tr> </tbody> </table>	Code	Description	Qty	UOM	VM1224A0	65MY 220MM 2 COLOURS SHRINK TUBE	0.200	M	VM2332A0	WATER PIPE BUSHING	1	PZ	VM2332A0	WATER PIPE BUSHING	1	PZ	VM2332A1	HUMIDITY PIPES WASHE	1	PZ					
Code	Description	Qty	UOM																						
VM1224A0	65MY 220MM 2 COLOURS SHRINK TUBE	0.200	M																						
VM2332A0	WATER PIPE BUSHING	1	PZ																						
VM2332A0	WATER PIPE BUSHING	1	PZ																						
VM2332A1	HUMIDITY PIPES WASHE	1	PZ																						
GN1140A	MOLDED MOTOR HOLDER GASKET		KGN1140A	5 PCS. MOTOR HOLDER GASKET KI																					
0H7170A	MM MOTOR GLASS WOOL PLATE		0H7170A0	MM MOTOR GLASS WOOL PLATE																					
VM2332A	HUMIDITY PIPES WASHER		KVM2332A	WATER PIPE BUSHING KIT VM2332A0																					

COMPONENT			SPARE PART														
Code	Description	Image	Code	Description	Components list												
0G1552C	XEVC0711-E COMPLETE FAN GUARD WITH FLAPS		K0G1552C	XEVC-0711-E COMPLETE FAN GUARD KIT	<table border="1"> <thead> <tr> <th>Code</th> <th>Description</th> <th>Qty</th> <th>UOM</th> </tr> </thead> <tbody> <tr> <td>0G1552C0</td> <td>XEVC0711-E COMPLETE FAN GUARD WITH FLAPS</td> <td>1</td> <td>PZ</td> </tr> <tr> <td>IP1385A1</td> <td>CORNER POLYSTYREN E PACKING 110X80X2000</td> <td>2</td> <td>M</td> </tr> </tbody> </table>	Code	Description	Qty	UOM	0G1552C0	XEVC0711-E COMPLETE FAN GUARD WITH FLAPS	1	PZ	IP1385A1	CORNER POLYSTYREN E PACKING 110X80X2000	2	M
Code	Description	Qty	UOM														
0G1552C0	XEVC0711-E COMPLETE FAN GUARD WITH FLAPS	1	PZ														
IP1385A1	CORNER POLYSTYREN E PACKING 110X80X2000	2	M														
TB3507A	0711 ZERO HUMIDITY PIPE		TB3507A0	0711 ZERO HUMIDITY PIPE													
RC1170A	STAINLESS STEEL NUT M14 H=8 CH=22		KRC1170A	M14 H8 CH22 NUT - 10 PCS. KIT	<table border="1"> <thead> <tr> <th>Code</th> <th>Description</th> <th>Qty</th> <th>UOM</th> </tr> </thead> <tbody> <tr> <td>RC1170A1</td> <td>STAINLESS STEEL NUT M14 H=8 CH=22</td> <td>10</td> <td>PZ</td> </tr> <tr> <td>VM1224A0</td> <td>65MY 220MM 2 COLOURS SHRINK TUBE</td> <td>0.200</td> <td>M</td> </tr> </tbody> </table>	Code	Description	Qty	UOM	RC1170A1	STAINLESS STEEL NUT M14 H=8 CH=22	10	PZ	VM1224A0	65MY 220MM 2 COLOURS SHRINK TUBE	0.200	M
Code	Description	Qty	UOM														
RC1170A1	STAINLESS STEEL NUT M14 H=8 CH=22	10	PZ														
VM1224A0	65MY 220MM 2 COLOURS SHRINK TUBE	0.200	M														
TB2937B	XEBC EXTERNAL WATER PIPE D10+CONNECTION		TB2937B0	XEBC EXTERNAL WATER PIPE D10+CONNECTION													
GN1632A	CORE PROBE INLET HOLDING GASKET		GN1632A0	CORE PROBE INLET HOLDING GASKET													

COMPONENT			SPARE PART																																														
Code	Description	Image	Code	Description	Components list																																												
0H8042A	CORE PROBE INLET COVER CLOSING		0H8042A0	CORE PROBE INLET COVER CLOSING																																													
RS1205B	6 TURNS 5600W 230V D230 ELEMEN		KRS1205B	5600W 230V HEATING ELEMENT KIT	<table border="1"> <thead> <tr> <th>Code</th> <th>Description</th> <th>Qty</th> <th>UOM</th> </tr> </thead> <tbody> <tr> <td>GN1671A0</td> <td>141X22 G8.5 ELEMENT ARMED GASKET</td> <td>1</td> <td>PZ</td> </tr> <tr> <td>MOV0008A0</td> <td>HOOD RING GASKET GN1110A2</td> <td>0.100</td> <td>PZ</td> </tr> <tr> <td>RS1205B0</td> <td>6 TURNS 5600W 230V D230 ELEMEN</td> <td>1</td> <td>PZ</td> </tr> <tr> <td>SL1045A0</td> <td>S57 BLACK SILICONE - 80ML CARTRIDGE</td> <td>1</td> <td>PZ</td> </tr> <tr> <td>VI1032A0</td> <td>SCREW M4X16 TCB+ INOX</td> <td>1</td> <td>PZ</td> </tr> <tr> <td>VI1075A0</td> <td>NUT M4 H=4 UNI5587 INOX</td> <td>1</td> <td>PZ</td> </tr> <tr> <td>VI1220A1</td> <td>4,2X12 TCB SELF-TAPPIN G SCREW</td> <td>6</td> <td>PZ</td> </tr> <tr> <td>VI1511A0</td> <td>STAINLESS STEEL WASHER 4.2X12X1</td> <td>1</td> <td>PZ</td> </tr> <tr> <td>VM1794A0</td> <td>250X4.8 PA66 BLACK CLAMP</td> <td>2</td> <td>PZ</td> </tr> <tr> <td>VM2103A0</td> <td>CLAMP LOCK</td> <td>2</td> <td>PZ</td> </tr> </tbody> </table>	Code	Description	Qty	UOM	GN1671A0	141X22 G8.5 ELEMENT ARMED GASKET	1	PZ	MOV0008A0	HOOD RING GASKET GN1110A2	0.100	PZ	RS1205B0	6 TURNS 5600W 230V D230 ELEMEN	1	PZ	SL1045A0	S57 BLACK SILICONE - 80ML CARTRIDGE	1	PZ	VI1032A0	SCREW M4X16 TCB+ INOX	1	PZ	VI1075A0	NUT M4 H=4 UNI5587 INOX	1	PZ	VI1220A1	4,2X12 TCB SELF-TAPPIN G SCREW	6	PZ	VI1511A0	STAINLESS STEEL WASHER 4.2X12X1	1	PZ	VM1794A0	250X4.8 PA66 BLACK CLAMP	2	PZ	VM2103A0	CLAMP LOCK	2	PZ
Code	Description	Qty	UOM																																														
GN1671A0	141X22 G8.5 ELEMENT ARMED GASKET	1	PZ																																														
MOV0008A0	HOOD RING GASKET GN1110A2	0.100	PZ																																														
RS1205B0	6 TURNS 5600W 230V D230 ELEMEN	1	PZ																																														
SL1045A0	S57 BLACK SILICONE - 80ML CARTRIDGE	1	PZ																																														
VI1032A0	SCREW M4X16 TCB+ INOX	1	PZ																																														
VI1075A0	NUT M4 H=4 UNI5587 INOX	1	PZ																																														
VI1220A1	4,2X12 TCB SELF-TAPPIN G SCREW	6	PZ																																														
VI1511A0	STAINLESS STEEL WASHER 4.2X12X1	1	PZ																																														
VM1794A0	250X4.8 PA66 BLACK CLAMP	2	PZ																																														
VM2103A0	CLAMP LOCK	2	PZ																																														

ASM2926A/0.D03 - Electrical system

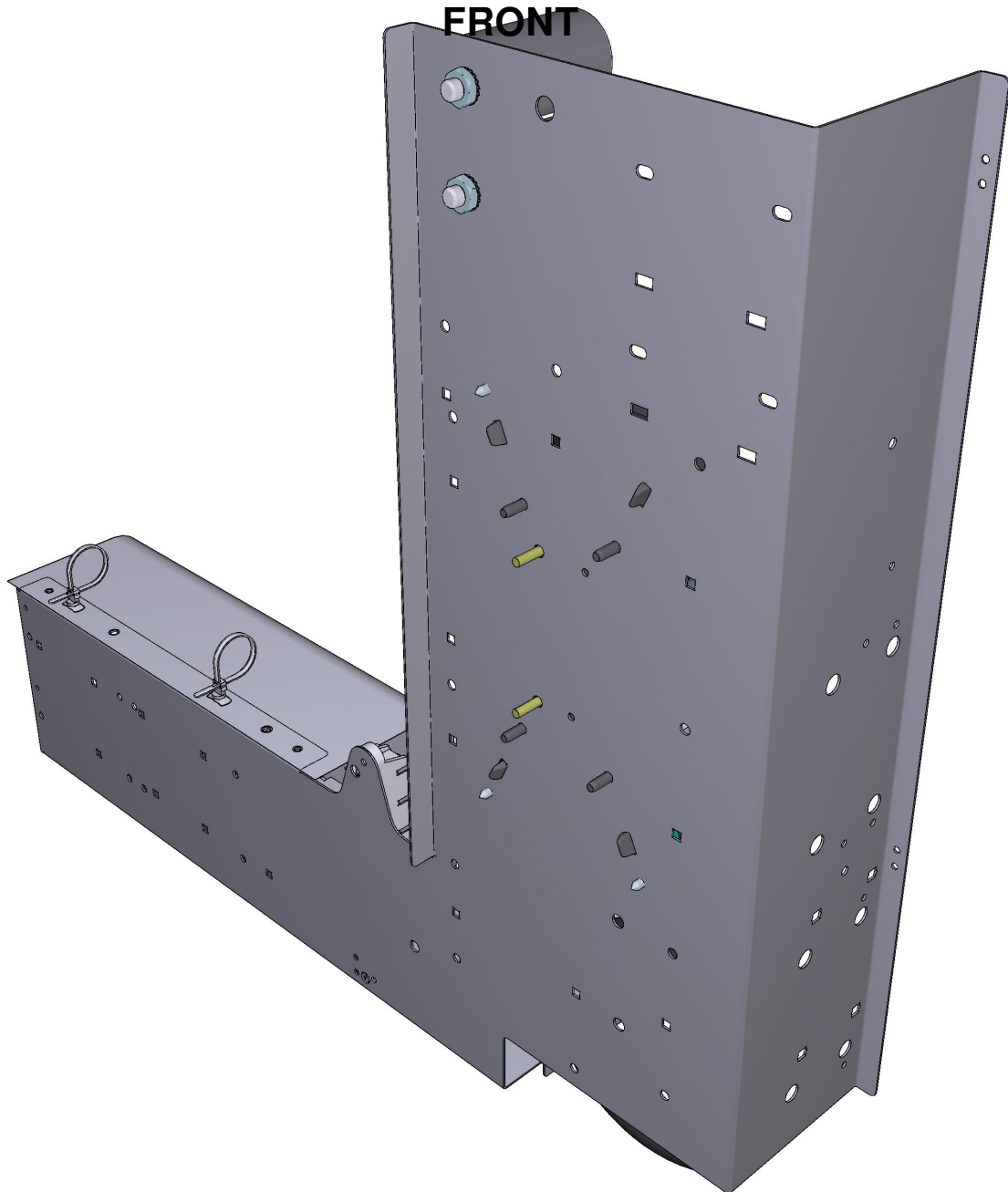



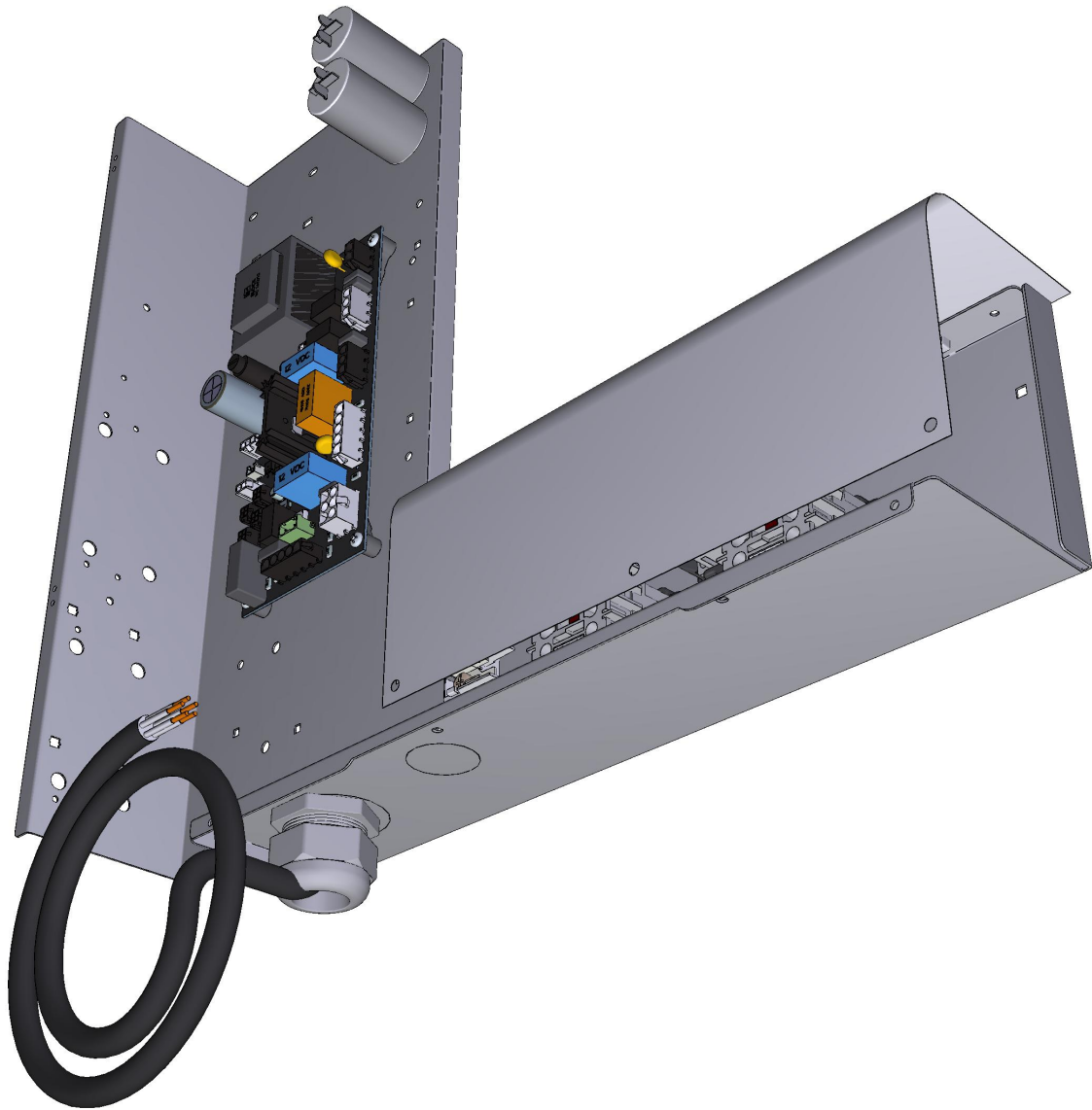

ASM2926A/0.D03 - Electrical system

REAR

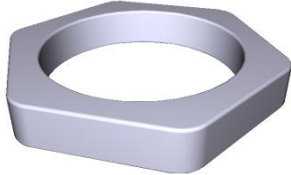

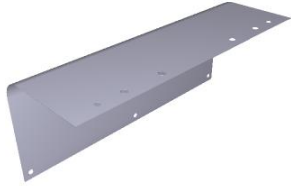
COMPONENT			SPARE PART																						
Code	Description	Image	Code	Description	Components list																				
CN1003A	6,3 UF MOTOR CAPACITOR		KCN1003A	6,3 UF MOTOR CAPACITOR KIT	<table border="1"> <thead> <tr> <th>Code</th> <th>Description</th> <th>Qty</th> <th>UOM</th> </tr> </thead> <tbody> <tr> <td>CN1003A0</td> <td>6,3 UF MOTOR CAPACITOR</td> <td>1</td> <td>PZ</td> </tr> <tr> <td>VI1931A0</td> <td>M8 NUT+INDENTE D WASHER D=8 X COND.</td> <td>1</td> <td>PZ</td> </tr> <tr> <td>VI1932A0</td> <td>M8 NUT+INDENTE D WASHER D=8 X COND.</td> <td>1</td> <td>PZ</td> </tr> <tr> <td>VM1224A0</td> <td>65MY 220MM 2 COLOURS SHRINK TUBE</td> <td>0.200</td> <td>M</td> </tr> </tbody> </table>	Code	Description	Qty	UOM	CN1003A0	6,3 UF MOTOR CAPACITOR	1	PZ	VI1931A0	M8 NUT+INDENTE D WASHER D=8 X COND.	1	PZ	VI1932A0	M8 NUT+INDENTE D WASHER D=8 X COND.	1	PZ	VM1224A0	65MY 220MM 2 COLOURS SHRINK TUBE	0.200	M
					Code	Description	Qty	UOM																	
					CN1003A0	6,3 UF MOTOR CAPACITOR	1	PZ																	
					VI1931A0	M8 NUT+INDENTE D WASHER D=8 X COND.	1	PZ																	
VI1932A0	M8 NUT+INDENTE D WASHER D=8 X COND.	1	PZ																						
VM1224A0	65MY 220MM 2 COLOURS SHRINK TUBE	0.200	M																						
<table border="1"> <thead> <tr> <th>Code</th> <th>Description</th> <th>Qty</th> <th>UOM</th> </tr> </thead> <tbody> <tr> <td>VE1115A0</td> <td>20 A 230V 4 POLES MINICONTACT OR</td> <td>1</td> <td>PZ</td> </tr> <tr> <td>VM1075A1</td> <td>PLASTIC CLIP TO FIX CONTACTORS</td> <td>4</td> <td>PZ</td> </tr> <tr> <td>VM1224A0</td> <td>65MY 220MM 2 COLOURS SHRINK TUBE</td> <td>0.250</td> <td>M</td> </tr> </tbody> </table>	Code	Description	Qty	UOM	VE1115A0	20 A 230V 4 POLES MINICONTACT OR	1	PZ	VM1075A1	PLASTIC CLIP TO FIX CONTACTORS	4	PZ	VM1224A0	65MY 220MM 2 COLOURS SHRINK TUBE	0.250	M									
Code	Description	Qty	UOM																						
VE1115A0	20 A 230V 4 POLES MINICONTACT OR	1	PZ																						
VM1075A1	PLASTIC CLIP TO FIX CONTACTORS	4	PZ																						
VM1224A0	65MY 220MM 2 COLOURS SHRINK TUBE	0.250	M																						
<table border="1"> <thead> <tr> <th>Code</th> <th>Description</th> <th>Qty</th> <th>UOM</th> </tr> </thead> <tbody> <tr> <td>MR1004A1</td> <td>41A 450V 7 POLES TERMINAL</td> <td>1</td> <td>PZ</td> </tr> <tr> <td>VM1224A0</td> <td>65MY 220MM 2 COLOURS SHRINK TUBE</td> <td>0.300</td> <td>M</td> </tr> </tbody> </table>	Code	Description	Qty	UOM	MR1004A1	41A 450V 7 POLES TERMINAL	1	PZ	VM1224A0	65MY 220MM 2 COLOURS SHRINK TUBE	0.300	M													
Code	Description	Qty	UOM																						
MR1004A1	41A 450V 7 POLES TERMINAL	1	PZ																						
VM1224A0	65MY 220MM 2 COLOURS SHRINK TUBE	0.300	M																						
<table border="1"> <thead> <tr> <th>Code</th> <th>Description</th> <th>Qty</th> <th>UOM</th> </tr> </thead> <tbody> <tr> <td>MR1004A1</td> <td>41A 450V 7 POLES TERMINAL</td> <td>1</td> <td>PZ</td> </tr> <tr> <td>VM1224A0</td> <td>65MY 220MM 2 COLOURS SHRINK TUBE</td> <td>0.300</td> <td>M</td> </tr> </tbody> </table>	Code	Description	Qty	UOM	MR1004A1	41A 450V 7 POLES TERMINAL	1	PZ	VM1224A0	65MY 220MM 2 COLOURS SHRINK TUBE	0.300	M													
Code	Description	Qty	UOM																						
MR1004A1	41A 450V 7 POLES TERMINAL	1	PZ																						
VM1224A0	65MY 220MM 2 COLOURS SHRINK TUBE	0.300	M																						
VE1115A	20 A 230V 4 POLES MINICONTACTOR		KVE1115A	20A 230V 4 POLES MINICONTACTOR KI	<table border="1"> <thead> <tr> <th>Code</th> <th>Description</th> <th>Qty</th> <th>UOM</th> </tr> </thead> <tbody> <tr> <td>VE1115A0</td> <td>20 A 230V 4 POLES MINICONTACT OR</td> <td>1</td> <td>PZ</td> </tr> <tr> <td>VM1075A1</td> <td>PLASTIC CLIP TO FIX CONTACTORS</td> <td>4</td> <td>PZ</td> </tr> <tr> <td>VM1224A0</td> <td>65MY 220MM 2 COLOURS SHRINK TUBE</td> <td>0.250</td> <td>M</td> </tr> </tbody> </table>	Code	Description	Qty	UOM	VE1115A0	20 A 230V 4 POLES MINICONTACT OR	1	PZ	VM1075A1	PLASTIC CLIP TO FIX CONTACTORS	4	PZ	VM1224A0	65MY 220MM 2 COLOURS SHRINK TUBE	0.250	M				
Code	Description	Qty	UOM																						
VE1115A0	20 A 230V 4 POLES MINICONTACT OR	1	PZ																						
VM1075A1	PLASTIC CLIP TO FIX CONTACTORS	4	PZ																						
VM1224A0	65MY 220MM 2 COLOURS SHRINK TUBE	0.250	M																						
VM1056A	SMALL CONTACTOR BRACKET VE1115A		VM1056A0	SMALL CONTACTOR BRACKET VE1115A																					
MR1004A	41A 450V 7 POLES TERMINAL		KMR1004A	7FTW 1+2+3/4+5+6 TERMINAL BLOCK KIT	<table border="1"> <thead> <tr> <th>Code</th> <th>Description</th> <th>Qty</th> <th>UOM</th> </tr> </thead> <tbody> <tr> <td>MR1004A1</td> <td>41A 450V 7 POLES TERMINAL</td> <td>1</td> <td>PZ</td> </tr> <tr> <td>VM1224A0</td> <td>65MY 220MM 2 COLOURS SHRINK TUBE</td> <td>0.300</td> <td>M</td> </tr> </tbody> </table>	Code	Description	Qty	UOM	MR1004A1	41A 450V 7 POLES TERMINAL	1	PZ	VM1224A0	65MY 220MM 2 COLOURS SHRINK TUBE	0.300	M								
Code	Description	Qty	UOM																						
MR1004A1	41A 450V 7 POLES TERMINAL	1	PZ																						
VM1224A0	65MY 220MM 2 COLOURS SHRINK TUBE	0.300	M																						

COMPONENT			SPARE PART																		
Code	Description	Image	Code	Description	Components list																
VE1644A	PG 29 STRAIN RELIEF NUT		KVE1645A	REDUCED PG 29 STRAIN RELIEF + NUT KIT	<table border="1"> <thead> <tr> <th>Code</th> <th>Description</th> <th>Qty</th> <th>UOM</th> </tr> </thead> <tbody> <tr> <td>VE1644A0</td> <td>PG 29 STRAIN RELIEF NUT</td> <td>1</td> <td>PZ</td> </tr> <tr> <td>VE1645A1</td> <td>REDUCED PG 29 STRAIN RELIEF</td> <td>1</td> <td>PZ</td> </tr> <tr> <td>VM1224A0</td> <td>65MY 220MM 2 COLOURS SHRINK TUBE</td> <td>0.300</td> <td>M</td> </tr> </tbody> </table>	Code	Description	Qty	UOM	VE1644A0	PG 29 STRAIN RELIEF NUT	1	PZ	VE1645A1	REDUCED PG 29 STRAIN RELIEF	1	PZ	VM1224A0	65MY 220MM 2 COLOURS SHRINK TUBE	0.300	M
Code	Description	Qty	UOM																		
VE1644A0	PG 29 STRAIN RELIEF NUT	1	PZ																		
VE1645A1	REDUCED PG 29 STRAIN RELIEF	1	PZ																		
VM1224A0	65MY 220MM 2 COLOURS SHRINK TUBE	0.300	M																		
VE1645A	REDUCED PG 29 STRAIN RELIEF		KVE1645A	REDUCED PG 29 STRAIN RELIEF + NUT KIT	<table border="1"> <thead> <tr> <th>Code</th> <th>Description</th> <th>Qty</th> <th>UOM</th> </tr> </thead> <tbody> <tr> <td>VE1644A0</td> <td>PG 29 STRAIN RELIEF NUT</td> <td>1</td> <td>PZ</td> </tr> <tr> <td>VE1645A1</td> <td>REDUCED PG 29 STRAIN RELIEF</td> <td>1</td> <td>PZ</td> </tr> <tr> <td>VM1224A0</td> <td>65MY 220MM 2 COLOURS SHRINK TUBE</td> <td>0.300</td> <td>M</td> </tr> </tbody> </table>	Code	Description	Qty	UOM	VE1644A0	PG 29 STRAIN RELIEF NUT	1	PZ	VE1645A1	REDUCED PG 29 STRAIN RELIEF	1	PZ	VM1224A0	65MY 220MM 2 COLOURS SHRINK TUBE	0.300	M
Code	Description	Qty	UOM																		
VE1644A0	PG 29 STRAIN RELIEF NUT	1	PZ																		
VE1645A1	REDUCED PG 29 STRAIN RELIEF	1	PZ																		
VM1224A0	65MY 220MM 2 COLOURS SHRINK TUBE	0.300	M																		
CE1355A	CABLE 5 X 2,5 MMQ H07RNF L = 1,5 MT		KCE1355A	L=1.5M 5X2.5MMQ POWER CABLE KIT	<table border="1"> <thead> <tr> <th>Code</th> <th>Description</th> <th>Qty</th> <th>UOM</th> </tr> </thead> <tbody> <tr> <td>CE1355A1</td> <td>CABLE 5 X 2,5 MMQ H07RNF L = 1,5 MT</td> <td>1</td> <td>PZ</td> </tr> <tr> <td>VM1224A0</td> <td>65MY 220MM 2 COLOURS SHRINK TUBE</td> <td>0.350</td> <td>M</td> </tr> </tbody> </table>	Code	Description	Qty	UOM	CE1355A1	CABLE 5 X 2,5 MMQ H07RNF L = 1,5 MT	1	PZ	VM1224A0	65MY 220MM 2 COLOURS SHRINK TUBE	0.350	M				
Code	Description	Qty	UOM																		
CE1355A1	CABLE 5 X 2,5 MMQ H07RNF L = 1,5 MT	1	PZ																		
VM1224A0	65MY 220MM 2 COLOURS SHRINK TUBE	0.350	M																		
VM2387A	MM XEVC REMOTE CONTROL SWITCH PROTECTION		VM2387A0	MM XEVC REMOTE CONTROL SWITCH PROTECTION																	
VM1187A	POWER BOARD FRAME SHOP.PRO		VM1187A0	POWER BOARD FRAME SHOP.PRO																	

COMPONENT			SPARE PART																														
Code	Description	Image	Code	Description	Components list																												
PE2102A	BL LED/TOUCH/PLUS 230V POWER BOAR		KPE2102A	BL LED/TOUCH/MASTE R 230V POWER CARD KIT	<table border="1"> <thead> <tr> <th>Code</th> <th>Description</th> <th>Qty</th> <th>UOM</th> </tr> </thead> <tbody> <tr> <td>PE2102A0</td> <td>BL LED/TOUCH/P LUS 230V POWER BOARD KIT</td> <td>1</td> <td>PZ</td> </tr> <tr> <td>PE2102A1</td> <td>BL LED/TOUCH/P LUS 230 V POWER CARD</td> <td>1</td> <td>PZ</td> </tr> <tr> <td>PE2102A2</td> <td>BL LED/TOUCH/P LUS 230V POWER BOAR</td> <td>1</td> <td>PZ</td> </tr> <tr> <td>VI1988A0</td> <td>AUTOTHREAD ING SCREW 4,2X19 TCB+ INOX</td> <td>3</td> <td>PZ</td> </tr> <tr> <td>VM1187A0</td> <td>POWER BOARD FRAME SHOP.PRO</td> <td>1</td> <td>PZ</td> </tr> <tr> <td>VM2147A0</td> <td>410X343X15 MM PINK SMOOTH ESD SPONGE</td> <td>1</td> <td>PZ</td> </tr> </tbody> </table>	Code	Description	Qty	UOM	PE2102A0	BL LED/TOUCH/P LUS 230V POWER BOARD KIT	1	PZ	PE2102A1	BL LED/TOUCH/P LUS 230 V POWER CARD	1	PZ	PE2102A2	BL LED/TOUCH/P LUS 230V POWER BOAR	1	PZ	VI1988A0	AUTOTHREAD ING SCREW 4,2X19 TCB+ INOX	3	PZ	VM1187A0	POWER BOARD FRAME SHOP.PRO	1	PZ	VM2147A0	410X343X15 MM PINK SMOOTH ESD SPONGE	1	PZ
Code	Description	Qty	UOM																														
PE2102A0	BL LED/TOUCH/P LUS 230V POWER BOARD KIT	1	PZ																														
PE2102A1	BL LED/TOUCH/P LUS 230 V POWER CARD	1	PZ																														
PE2102A2	BL LED/TOUCH/P LUS 230V POWER BOAR	1	PZ																														
VI1988A0	AUTOTHREAD ING SCREW 4,2X19 TCB+ INOX	3	PZ																														
VM1187A0	POWER BOARD FRAME SHOP.PRO	1	PZ																														
VM2147A0	410X343X15 MM PINK SMOOTH ESD SPONGE	1	PZ																														
0H7250A	MM ONE GN1/1 ELECT. COMPONENTS HOLDER		0H7250A0	MM ONE GN1/1 ELECT. COMPONENTS HOLDER																													

ASM2917D/0.D01 - External cover

FRONT



ASM2917D/0.D01 - External cover

REAR

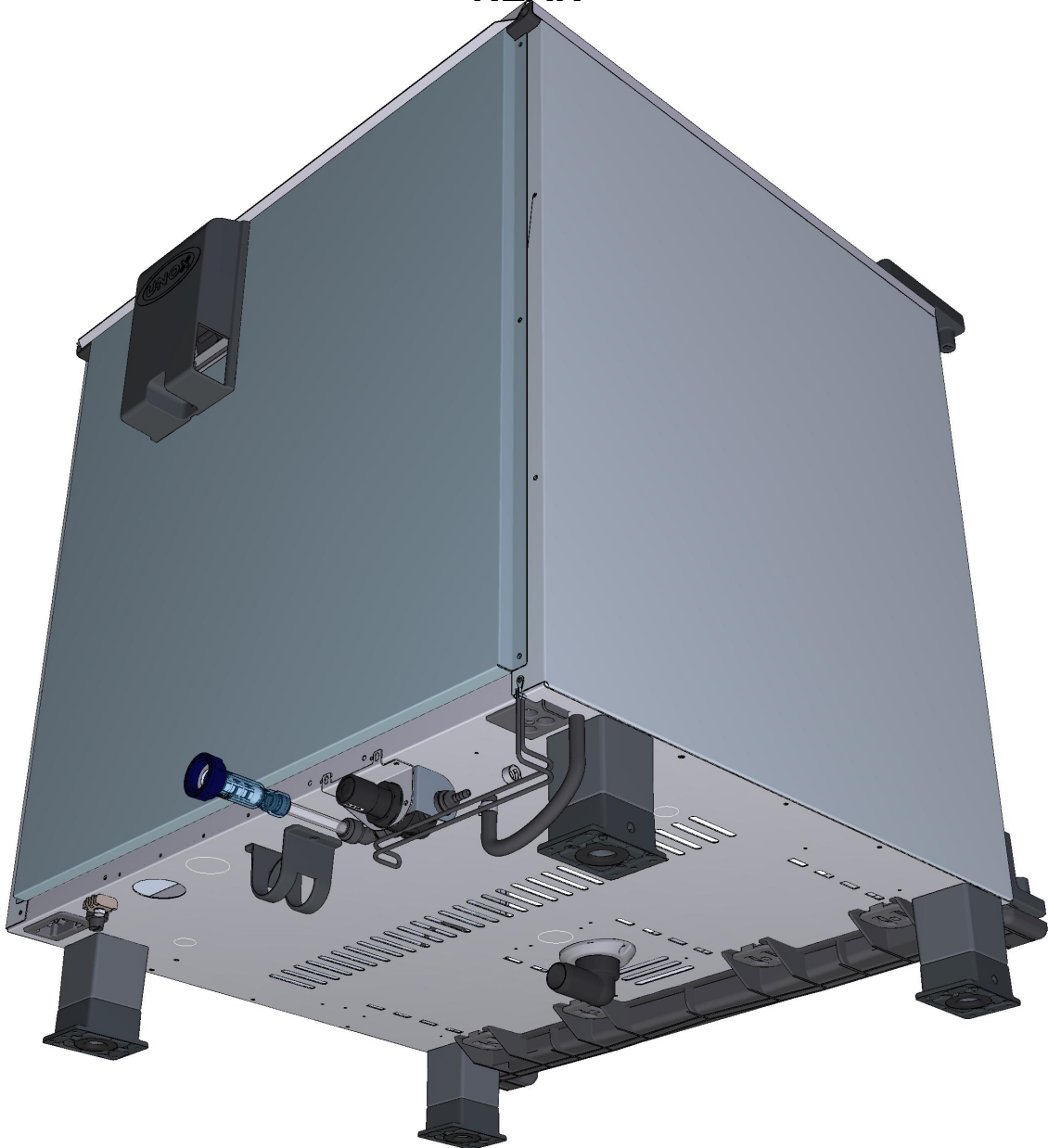







COMPONENT			SPARE PART																										
Code	Description	Image	Code	Description	Components list																								
VM1750A	BRASS COMB CLAM		KVM1750A	COMB TERMINAL BLOCK KIT	<table border="1"> <thead> <tr> <th>Code</th> <th>Description</th> <th>Qty</th> <th>UOM</th> </tr> </thead> <tbody> <tr> <td>VM1224A0</td> <td>65MY 220MM 2 COLOURS SHRINK TUBE</td> <td>0.150</td> <td>M</td> </tr> <tr> <td>VM1750A0</td> <td>BRASS COMB CLAMP</td> <td>1</td> <td>PZ</td> </tr> </tbody> </table>	Code	Description	Qty	UOM	VM1224A0	65MY 220MM 2 COLOURS SHRINK TUBE	0.150	M	VM1750A0	BRASS COMB CLAMP	1	PZ												
Code	Description	Qty	UOM																										
VM1224A0	65MY 220MM 2 COLOURS SHRINK TUBE	0.150	M																										
VM1750A0	BRASS COMB CLAMP	1	PZ																										
VM2074A	DRIP TRAY FIXING CLIP WITH SCREW		KVM1220A	CT/BT DRIP TRAY FIXING CLIPS 4PCS KIT	<table border="1"> <thead> <tr> <th>Code</th> <th>Description</th> <th>Qty</th> <th>UOM</th> </tr> </thead> <tbody> <tr> <td>VI1220A1</td> <td>4.2X12 TCB SELF-TAPPIN G SCREW</td> <td>4</td> <td>PZ</td> </tr> <tr> <td>VM1220A0</td> <td>CLIP TO FIX DRIP TRAY C.T</td> <td>4</td> <td>PZ</td> </tr> <tr> <td>VM1224A0</td> <td>65MY 220MM 2 COLOURS SHRINK TUBE</td> <td>0.250</td> <td>M</td> </tr> <tr> <td>VM2074A0</td> <td>DRIP TRAY FIXING CLIP WITH SCREW</td> <td>4</td> <td>PZ</td> </tr> </tbody> </table>	Code	Description	Qty	UOM	VI1220A1	4.2X12 TCB SELF-TAPPIN G SCREW	4	PZ	VM1220A0	CLIP TO FIX DRIP TRAY C.T	4	PZ	VM1224A0	65MY 220MM 2 COLOURS SHRINK TUBE	0.250	M	VM2074A0	DRIP TRAY FIXING CLIP WITH SCREW	4	PZ				
Code	Description	Qty	UOM																										
VI1220A1	4.2X12 TCB SELF-TAPPIN G SCREW	4	PZ																										
VM1220A0	CLIP TO FIX DRIP TRAY C.T	4	PZ																										
VM1224A0	65MY 220MM 2 COLOURS SHRINK TUBE	0.250	M																										
VM2074A0	DRIP TRAY FIXING CLIP WITH SCREW	4	PZ																										
VN1165A	230VAC 50/60HZ COOLING DOWN FA		KVN1165A	S.5E ADVANCE/MM 230V COOLING FAN KIT	<table border="1"> <thead> <tr> <th>Code</th> <th>Description</th> <th>Qty</th> <th>UOM</th> </tr> </thead> <tbody> <tr> <td>MOV0017A0</td> <td>HOOD RING GASKET GN1110A2</td> <td>0.100</td> <td>PZ</td> </tr> <tr> <td>VI1099A0</td> <td>SELF-DRILLIN G SCREW 4.8X13 TCB+ Z</td> <td>4</td> <td>PZ</td> </tr> <tr> <td>VM1555A2</td> <td>CT BT COOLING FAN SUPPORT</td> <td>1</td> <td>PZ</td> </tr> <tr> <td>VN1165A0</td> <td>230VAC 50/60HZ COOLING DOWN FAN</td> <td>1</td> <td>PZ</td> </tr> <tr> <td>VN1165A0</td> <td>230VAC 50/60HZ COOLING DOWN FAN</td> <td>1</td> <td>PZ</td> </tr> </tbody> </table>	Code	Description	Qty	UOM	MOV0017A0	HOOD RING GASKET GN1110A2	0.100	PZ	VI1099A0	SELF-DRILLIN G SCREW 4.8X13 TCB+ Z	4	PZ	VM1555A2	CT BT COOLING FAN SUPPORT	1	PZ	VN1165A0	230VAC 50/60HZ COOLING DOWN FAN	1	PZ	VN1165A0	230VAC 50/60HZ COOLING DOWN FAN	1	PZ
Code	Description	Qty	UOM																										
MOV0017A0	HOOD RING GASKET GN1110A2	0.100	PZ																										
VI1099A0	SELF-DRILLIN G SCREW 4.8X13 TCB+ Z	4	PZ																										
VM1555A2	CT BT COOLING FAN SUPPORT	1	PZ																										
VN1165A0	230VAC 50/60HZ COOLING DOWN FAN	1	PZ																										
VN1165A0	230VAC 50/60HZ COOLING DOWN FAN	1	PZ																										
VM1555A	CT BT COOLING FAN SUPPORT		KVN1165A	S.5E ADVANCE/MM 230V COOLING FAN KIT	<table border="1"> <thead> <tr> <th>Code</th> <th>Description</th> <th>Qty</th> <th>UOM</th> </tr> </thead> <tbody> <tr> <td>MOV0017A0</td> <td>HOOD RING GASKET GN1110A2</td> <td>0.100</td> <td>PZ</td> </tr> <tr> <td>VI1099A0</td> <td>SELF-DRILLIN G SCREW 4.8X13 TCB+ Z</td> <td>4</td> <td>PZ</td> </tr> <tr> <td>VM1555A2</td> <td>CT BT COOLING FAN SUPPORT</td> <td>1</td> <td>PZ</td> </tr> <tr> <td>VN1165A0</td> <td>230VAC 50/60HZ COOLING DOWN FAN</td> <td>1</td> <td>PZ</td> </tr> <tr> <td>VN1165A0</td> <td>230VAC 50/60HZ COOLING DOWN FAN</td> <td>1</td> <td>PZ</td> </tr> </tbody> </table>	Code	Description	Qty	UOM	MOV0017A0	HOOD RING GASKET GN1110A2	0.100	PZ	VI1099A0	SELF-DRILLIN G SCREW 4.8X13 TCB+ Z	4	PZ	VM1555A2	CT BT COOLING FAN SUPPORT	1	PZ	VN1165A0	230VAC 50/60HZ COOLING DOWN FAN	1	PZ	VN1165A0	230VAC 50/60HZ COOLING DOWN FAN	1	PZ
Code	Description	Qty	UOM																										
MOV0017A0	HOOD RING GASKET GN1110A2	0.100	PZ																										
VI1099A0	SELF-DRILLIN G SCREW 4.8X13 TCB+ Z	4	PZ																										
VM1555A2	CT BT COOLING FAN SUPPORT	1	PZ																										
VN1165A0	230VAC 50/60HZ COOLING DOWN FAN	1	PZ																										
VN1165A0	230VAC 50/60HZ COOLING DOWN FAN	1	PZ																										







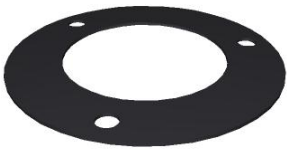



COMPONENT			SPARE PART																										
Code	Description	Image	Code	Description	Components list																								
VM1555A	CT BT COOLING FAN SUPPORT		KVN1164A	S.5/5E 12VDC COOLING DOWN FAN KIT	<table border="1"> <thead> <tr> <th>Code</th> <th>Description</th> <th>Qty</th> <th>UOM</th> </tr> </thead> <tbody> <tr> <td>VI1099A0</td> <td>SELF-DRILLING G SCREW 4.8X13 TCB+ Z</td> <td>4</td> <td>PZ</td> </tr> <tr> <td>VM1555A2</td> <td>CT BT COOLING FAN SUPPORT</td> <td>1</td> <td>PZ</td> </tr> <tr> <td>VN1164A0</td> <td>12VDC COOLING DOWN FAN</td> <td>1</td> <td>PZ</td> </tr> <tr> <td>VN1164A0</td> <td>12VDC COOLING DOWN FAN</td> <td>1</td> <td>PZ</td> </tr> </tbody> </table>	Code	Description	Qty	UOM	VI1099A0	SELF-DRILLING G SCREW 4.8X13 TCB+ Z	4	PZ	VM1555A2	CT BT COOLING FAN SUPPORT	1	PZ	VN1164A0	12VDC COOLING DOWN FAN	1	PZ	VN1164A0	12VDC COOLING DOWN FAN	1	PZ				
Code	Description	Qty	UOM																										
VI1099A0	SELF-DRILLING G SCREW 4.8X13 TCB+ Z	4	PZ																										
VM1555A2	CT BT COOLING FAN SUPPORT	1	PZ																										
VN1164A0	12VDC COOLING DOWN FAN	1	PZ																										
VN1164A0	12VDC COOLING DOWN FAN	1	PZ																										
VM1556A	XBC-XVC COOLING FAN GUARD		KVM1556A	XBC-XVC COOLING FAN GUARD KIT	<table border="1"> <thead> <tr> <th>Code</th> <th>Description</th> <th>Qty</th> <th>UOM</th> </tr> </thead> <tbody> <tr> <td>VM1556A0</td> <td>XBC-XVC COOLING FAN GUARD</td> <td>1</td> <td>PZ</td> </tr> </tbody> </table>	Code	Description	Qty	UOM	VM1556A0	XBC-XVC COOLING FAN GUARD	1	PZ																
Code	Description	Qty	UOM																										
VM1556A0	XBC-XVC COOLING FAN GUARD	1	PZ																										
VL1026A	BEND FOR DRAIN PIPE		KVL1026A	DRAIN PIPE BEND KIT	<table border="1"> <thead> <tr> <th>Code</th> <th>Description</th> <th>Qty</th> <th>UOM</th> </tr> </thead> <tbody> <tr> <td>GN1400A0</td> <td>U-TRAP SEAL</td> <td>1</td> <td>PZ</td> </tr> <tr> <td>VL1026A0</td> <td>BEND FOR DRAIN PIPE</td> <td>1</td> <td>PZ</td> </tr> <tr> <td>VM1224A0</td> <td>65MY 220MM 2 COLOURS SHRINK TUBE</td> <td>0.300</td> <td>M</td> </tr> <tr> <td>VM2039A0</td> <td>DRAIN BEND FIXING RING</td> <td>1</td> <td>PZ</td> </tr> </tbody> </table>	Code	Description	Qty	UOM	GN1400A0	U-TRAP SEAL	1	PZ	VL1026A0	BEND FOR DRAIN PIPE	1	PZ	VM1224A0	65MY 220MM 2 COLOURS SHRINK TUBE	0.300	M	VM2039A0	DRAIN BEND FIXING RING	1	PZ				
Code	Description	Qty	UOM																										
GN1400A0	U-TRAP SEAL	1	PZ																										
VL1026A0	BEND FOR DRAIN PIPE	1	PZ																										
VM1224A0	65MY 220MM 2 COLOURS SHRINK TUBE	0.300	M																										
VM2039A0	DRAIN BEND FIXING RING	1	PZ																										
VM2039A	DRAIN BEND FIXING RING		KVL1026A	DRAIN PIPE BEND KIT	<table border="1"> <thead> <tr> <th>Code</th> <th>Description</th> <th>Qty</th> <th>UOM</th> </tr> </thead> <tbody> <tr> <td>GN1400A0</td> <td>U-TRAP SEAL</td> <td>1</td> <td>PZ</td> </tr> <tr> <td>VL1026A0</td> <td>BEND FOR DRAIN PIPE</td> <td>1</td> <td>PZ</td> </tr> <tr> <td>VM1224A0</td> <td>65MY 220MM 2 COLOURS SHRINK TUBE</td> <td>0.300</td> <td>M</td> </tr> <tr> <td>VM2039A0</td> <td>DRAIN BEND FIXING RING</td> <td>1</td> <td>PZ</td> </tr> </tbody> </table>	Code	Description	Qty	UOM	GN1400A0	U-TRAP SEAL	1	PZ	VL1026A0	BEND FOR DRAIN PIPE	1	PZ	VM1224A0	65MY 220MM 2 COLOURS SHRINK TUBE	0.300	M	VM2039A0	DRAIN BEND FIXING RING	1	PZ				
Code	Description	Qty	UOM																										
GN1400A0	U-TRAP SEAL	1	PZ																										
VL1026A0	BEND FOR DRAIN PIPE	1	PZ																										
VM1224A0	65MY 220MM 2 COLOURS SHRINK TUBE	0.300	M																										
VM2039A0	DRAIN BEND FIXING RING	1	PZ																										
VM1991A	CHEFTOP E SERIES DRIP TRAY		KVM1991A	E SERIES CHEFTOP DRIP TRAY	<table border="1"> <thead> <tr> <th>Code</th> <th>Description</th> <th>Qty</th> <th>UOM</th> </tr> </thead> <tbody> <tr> <td>VM1220A0</td> <td>CLIP TO FIX DRIP TRAY C.T</td> <td>4</td> <td>PZ</td> </tr> <tr> <td>VM1794A0</td> <td>250X4.8 PA66 BLACK CLAMP</td> <td>2</td> <td>PZ</td> </tr> <tr> <td>VM1991A0</td> <td>CHEFTOP E SERIES DRIP TRAY</td> <td>1</td> <td>PZ</td> </tr> <tr> <td>VM2074A0</td> <td>DRIP TRAY FIXING CLIP WITH SCREW</td> <td>4</td> <td>PZ</td> </tr> <tr> <td>VM2103A0</td> <td>CLAMP LOCK</td> <td>2</td> <td>PZ</td> </tr> </tbody> </table>	Code	Description	Qty	UOM	VM1220A0	CLIP TO FIX DRIP TRAY C.T	4	PZ	VM1794A0	250X4.8 PA66 BLACK CLAMP	2	PZ	VM1991A0	CHEFTOP E SERIES DRIP TRAY	1	PZ	VM2074A0	DRIP TRAY FIXING CLIP WITH SCREW	4	PZ	VM2103A0	CLAMP LOCK	2	PZ
Code	Description	Qty	UOM																										
VM1220A0	CLIP TO FIX DRIP TRAY C.T	4	PZ																										
VM1794A0	250X4.8 PA66 BLACK CLAMP	2	PZ																										
VM1991A0	CHEFTOP E SERIES DRIP TRAY	1	PZ																										
VM2074A0	DRIP TRAY FIXING CLIP WITH SCREW	4	PZ																										
VM2103A0	CLAMP LOCK	2	PZ																										

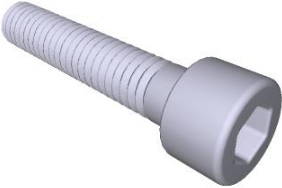

COMPONENT			SPARE PART																		
Code	Description	Image	Code	Description	Components list																
VM2035A	DRAIN PIPE SUPPORT		KVM2035A	DRAIN PIPE SUPPORT 2 PCS. KI	<table border="1"> <thead> <tr> <th>Code</th> <th>Description</th> <th>Qty</th> <th>UOM</th> </tr> </thead> <tbody> <tr> <td>VM1224A0</td> <td>65MY 220MM 2 COLOURS SHRINK TUBE</td> <td>0.250</td> <td>M</td> </tr> <tr> <td>VM2035A0</td> <td>DRAIN PIPE SUPPORT</td> <td>2</td> <td>PZ</td> </tr> </tbody> </table>	Code	Description	Qty	UOM	VM1224A0	65MY 220MM 2 COLOURS SHRINK TUBE	0.250	M	VM2035A0	DRAIN PIPE SUPPORT	2	PZ				
Code	Description	Qty	UOM																		
VM1224A0	65MY 220MM 2 COLOURS SHRINK TUBE	0.250	M																		
VM2035A0	DRAIN PIPE SUPPORT	2	PZ																		
VM1810A	RIGHT WATERTIGHT CAP		VM1810A0	RIGHT WATERTIGHT CAP																	
VM1811A	LEFT WATERTIGHT CAP		VM1811A0	LEFT WATERTIGHT CAP																	
VM2311A	SCREWS COVER		KVM2311A	SCREWS COVER PLATE KIT	<table border="1"> <thead> <tr> <th>Code</th> <th>Description</th> <th>Qty</th> <th>UOM</th> </tr> </thead> <tbody> <tr> <td>VM1224A0</td> <td>65MY 220MM 2 COLOURS SHRINK TUBE</td> <td>0.200</td> <td>M</td> </tr> <tr> <td>VM2311A0</td> <td>SCREWS COVER</td> <td>1</td> <td>PZ</td> </tr> </tbody> </table>	Code	Description	Qty	UOM	VM1224A0	65MY 220MM 2 COLOURS SHRINK TUBE	0.200	M	VM2311A0	SCREWS COVER	1	PZ				
Code	Description	Qty	UOM																		
VM1224A0	65MY 220MM 2 COLOURS SHRINK TUBE	0.200	M																		
VM2311A0	SCREWS COVER	1	PZ																		
GN1558A	EXHAUST SEAL		K0H7291A	GASKET AND SEALING DISC CHIMNEY KIT	<table border="1"> <thead> <tr> <th>Code</th> <th>Description</th> <th>Qty</th> <th>UOM</th> </tr> </thead> <tbody> <tr> <td>0H7291A0</td> <td>CHIMNEY HOLDING DIS</td> <td>1</td> <td>PZ</td> </tr> <tr> <td>GN1558A0</td> <td>EXHAUST SEA</td> <td>1</td> <td>PZ</td> </tr> <tr> <td>VM1224A0</td> <td>65MY 220MM 2 COLOURS SHRINK TUBE</td> <td>0.200</td> <td>M</td> </tr> </tbody> </table>	Code	Description	Qty	UOM	0H7291A0	CHIMNEY HOLDING DIS	1	PZ	GN1558A0	EXHAUST SEA	1	PZ	VM1224A0	65MY 220MM 2 COLOURS SHRINK TUBE	0.200	M
Code	Description	Qty	UOM																		
0H7291A0	CHIMNEY HOLDING DIS	1	PZ																		
GN1558A0	EXHAUST SEA	1	PZ																		
VM1224A0	65MY 220MM 2 COLOURS SHRINK TUBE	0.200	M																		



COMPONENT			SPARE PART																		
Code	Description	Image	Code	Description	Components list																
0H7291A	CHIMNEY HOLDING DISC		K0H7291A	GASKET AND SEALING DISC CHIMNEY KIT	<table border="1"> <thead> <tr> <th>Code</th> <th>Description</th> <th>Qty</th> <th>UOM</th> </tr> </thead> <tbody> <tr> <td>0H7291A0</td> <td>CHIMNEY HOLDING DISC</td> <td>1</td> <td>PZ</td> </tr> <tr> <td>GN1558A0</td> <td>EXHAUST SEA</td> <td>1</td> <td>PZ</td> </tr> <tr> <td>VM1224A0</td> <td>65MY 220MM 2 COLOURS SHRINK TUBE</td> <td>0.200</td> <td>M</td> </tr> </tbody> </table>	Code	Description	Qty	UOM	0H7291A0	CHIMNEY HOLDING DISC	1	PZ	GN1558A0	EXHAUST SEA	1	PZ	VM1224A0	65MY 220MM 2 COLOURS SHRINK TUBE	0.200	M
Code	Description	Qty	UOM																		
0H7291A0	CHIMNEY HOLDING DISC	1	PZ																		
GN1558A0	EXHAUST SEA	1	PZ																		
VM1224A0	65MY 220MM 2 COLOURS SHRINK TUBE	0.200	M																		
0H2561A	6 S. DOOR COUNTERBRACKET		0H2561A0	6 S. DOOR COUNTERBRACKET																	
VI1995A	M5X25 ST.STEEL SCREW		VI1995A0	M5X25 ST.STEEL SCREW																	
VM2352A	MM LOWER DOOR BRACKET LEFT SCREW COVERI		VM2352A0	MM LOWER DOOR BRACKET LEFT SCREW COVERI																	
VM2353A	MM LOWER DOOR BRACKET RIGHT SCREW COVERI		VM2353A0	MM LOWER DOOR BRACKET RIGHT SCREW COVERI																	

COMPONENT			SPARE PART																																						
Code	Description	Image	Code	Description	Components list																																				
VM1240A	NYLON SUPPORT CAP		KVM1240A	4 PCS COUNTER BRACKET SUPPORT CAP KIT	<table border="1"> <thead> <tr> <th>Code</th> <th>Description</th> <th>Qty</th> <th>UOM</th> </tr> </thead> <tbody> <tr> <td>VM1224A0</td> <td>65MY 220MM 2 COLOURS SHRINK TUBE</td> <td>0.200</td> <td>M</td> </tr> <tr> <td>VM1240A0</td> <td>NYLON SUPPORT CAP</td> <td>4</td> <td>PZ</td> </tr> </tbody> </table>	Code	Description	Qty	UOM	VM1224A0	65MY 220MM 2 COLOURS SHRINK TUBE	0.200	M	VM1240A0	NYLON SUPPORT CAP	4	PZ																								
Code	Description	Qty	UOM																																						
VM1224A0	65MY 220MM 2 COLOURS SHRINK TUBE	0.200	M																																						
VM1240A0	NYLON SUPPORT CAP	4	PZ																																						
VM2273A	MM DOOR LEFT LOWER BRACKET		KVM2273A	MIND.MAPS DOOR LOWER LEFT BRACKET KIT	<table border="1"> <thead> <tr> <th>Code</th> <th>Description</th> <th>Qty</th> <th>UOM</th> </tr> </thead> <tbody> <tr> <td>0H7330A0</td> <td>DOOR LOWER BRACKET WASHER</td> <td>2</td> <td>PZ</td> </tr> <tr> <td>VI1995A0</td> <td>M5X25 ST.STEEL SCREW</td> <td>4</td> <td>PZ</td> </tr> <tr> <td>VM1224A0</td> <td>65MY 220MM 2 COLOURS SHRINK TUBE</td> <td>0.300</td> <td>M</td> </tr> <tr> <td>VM2273A1</td> <td>MM DOOR LEFT LOWER BRACKET</td> <td>1</td> <td>PZ</td> </tr> <tr> <td>VM2352A0</td> <td>MM LOWER DOOR BRACKET LEFT SCREW COVERI</td> <td>1</td> <td>PZ</td> </tr> <tr> <td>VM2352A0</td> <td>MM LOWER DOOR BRACKET LEFT SCREW COVERI</td> <td>1</td> <td>PZ</td> </tr> <tr> <td>VM2353A0</td> <td>MM LOWER DOOR BRACKET RIGHT SCREW COVERI</td> <td>1</td> <td>PZ</td> </tr> <tr> <td>VM2353A0</td> <td>MM LOWER DOOR BRACKET RIGHT SCREW COVERI</td> <td>1</td> <td>PZ</td> </tr> </tbody> </table>	Code	Description	Qty	UOM	0H7330A0	DOOR LOWER BRACKET WASHER	2	PZ	VI1995A0	M5X25 ST.STEEL SCREW	4	PZ	VM1224A0	65MY 220MM 2 COLOURS SHRINK TUBE	0.300	M	VM2273A1	MM DOOR LEFT LOWER BRACKET	1	PZ	VM2352A0	MM LOWER DOOR BRACKET LEFT SCREW COVERI	1	PZ	VM2352A0	MM LOWER DOOR BRACKET LEFT SCREW COVERI	1	PZ	VM2353A0	MM LOWER DOOR BRACKET RIGHT SCREW COVERI	1	PZ	VM2353A0	MM LOWER DOOR BRACKET RIGHT SCREW COVERI	1	PZ
Code	Description	Qty	UOM																																						
0H7330A0	DOOR LOWER BRACKET WASHER	2	PZ																																						
VI1995A0	M5X25 ST.STEEL SCREW	4	PZ																																						
VM1224A0	65MY 220MM 2 COLOURS SHRINK TUBE	0.300	M																																						
VM2273A1	MM DOOR LEFT LOWER BRACKET	1	PZ																																						
VM2352A0	MM LOWER DOOR BRACKET LEFT SCREW COVERI	1	PZ																																						
VM2352A0	MM LOWER DOOR BRACKET LEFT SCREW COVERI	1	PZ																																						
VM2353A0	MM LOWER DOOR BRACKET RIGHT SCREW COVERI	1	PZ																																						
VM2353A0	MM LOWER DOOR BRACKET RIGHT SCREW COVERI	1	PZ																																						
0H2561A	6 S. DOOR COUNTERBRACKET		0H2561A0	6 S. DOOR COUNTERBRACKET																																					





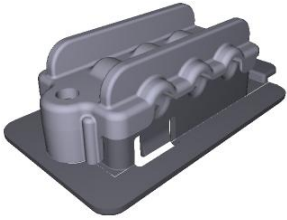

COMPONENT			SPARE PART																														
Code	Description	Image	Code	Description	Components list																												
VI1995A	M5X25 ST.STEEL SCREW		VI1995A0	M5X25 ST.STEEL SCREW																													
VM1240A	NYLON SUPPORT CAP		KVM1240A	4 PCS COUNTER BRACKET SUPPORT CAP KIT	<table border="1"> <thead> <tr> <th>Code</th> <th>Description</th> <th>Qty</th> <th>UOM</th> </tr> </thead> <tbody> <tr> <td>VM1224A0</td> <td>65MY 220MM 2 COLOURS SHRINK TUBE</td> <td>0.200</td> <td>M</td> </tr> <tr> <td>VM1240A0</td> <td>NYLON SUPPORT CAP</td> <td>4</td> <td>PZ</td> </tr> </tbody> </table>	Code	Description	Qty	UOM	VM1224A0	65MY 220MM 2 COLOURS SHRINK TUBE	0.200	M	VM1240A0	NYLON SUPPORT CAP	4	PZ																
Code	Description	Qty	UOM																														
VM1224A0	65MY 220MM 2 COLOURS SHRINK TUBE	0.200	M																														
VM1240A0	NYLON SUPPORT CAP	4	PZ																														
VM2298A	DOOR BRACKET UPPER COVER		KVM2298A	MIND.MAPS DOOR UPPER BRACKET COVER KIT	<table border="1"> <thead> <tr> <th>Code</th> <th>Description</th> <th>Qty</th> <th>UOM</th> </tr> </thead> <tbody> <tr> <td>VI1220A0</td> <td>SELF-TAPPIN G SCREW 4,2X12.TCB</td> <td>2</td> <td>PZ</td> </tr> <tr> <td>VM1224A0</td> <td>65MY 220MM 2 COLOURS SHRINK TUBE</td> <td>0.200</td> <td>M</td> </tr> <tr> <td>VM2298A0</td> <td>DOOR BRACKET UPPER COVER</td> <td>1</td> <td>PZ</td> </tr> </tbody> </table>	Code	Description	Qty	UOM	VI1220A0	SELF-TAPPIN G SCREW 4,2X12.TCB	2	PZ	VM1224A0	65MY 220MM 2 COLOURS SHRINK TUBE	0.200	M	VM2298A0	DOOR BRACKET UPPER COVER	1	PZ												
Code	Description	Qty	UOM																														
VI1220A0	SELF-TAPPIN G SCREW 4,2X12.TCB	2	PZ																														
VM1224A0	65MY 220MM 2 COLOURS SHRINK TUBE	0.200	M																														
VM2298A0	DOOR BRACKET UPPER COVER	1	PZ																														
VM2271A	MM DOOR LEFT UPPER BRACKET		KVM2271A	MIND.MAPS UPPER LEFT DOOR BRACKET KIT	<table border="1"> <thead> <tr> <th>Code</th> <th>Description</th> <th>Qty</th> <th>UOM</th> </tr> </thead> <tbody> <tr> <td>VI1220A1</td> <td>4,2X12.TCB SELF-TAPPIN G SCREW</td> <td>2</td> <td>PZ</td> </tr> <tr> <td>VI1995A0</td> <td>M5X25 ST.STEEL SCREW</td> <td>4</td> <td>PZ</td> </tr> <tr> <td>VI1997A0</td> <td>5X10X1 FLAT WASHER</td> <td>4</td> <td>PZ</td> </tr> <tr> <td>VM1224A0</td> <td>65MY 220MM 2 COLOURS SHRINK TUBE</td> <td>0.300</td> <td>M</td> </tr> <tr> <td>VM2271A0</td> <td>MM DOOR LEFT UPPER BRACKET</td> <td>1</td> <td>PZ</td> </tr> <tr> <td>VM2298A0</td> <td>DOOR BRACKET UPPER COVER</td> <td>1</td> <td>PZ</td> </tr> </tbody> </table>	Code	Description	Qty	UOM	VI1220A1	4,2X12.TCB SELF-TAPPIN G SCREW	2	PZ	VI1995A0	M5X25 ST.STEEL SCREW	4	PZ	VI1997A0	5X10X1 FLAT WASHER	4	PZ	VM1224A0	65MY 220MM 2 COLOURS SHRINK TUBE	0.300	M	VM2271A0	MM DOOR LEFT UPPER BRACKET	1	PZ	VM2298A0	DOOR BRACKET UPPER COVER	1	PZ
Code	Description	Qty	UOM																														
VI1220A1	4,2X12.TCB SELF-TAPPIN G SCREW	2	PZ																														
VI1995A0	M5X25 ST.STEEL SCREW	4	PZ																														
VI1997A0	5X10X1 FLAT WASHER	4	PZ																														
VM1224A0	65MY 220MM 2 COLOURS SHRINK TUBE	0.300	M																														
VM2271A0	MM DOOR LEFT UPPER BRACKET	1	PZ																														
VM2298A0	DOOR BRACKET UPPER COVER	1	PZ																														





COMPONENT			SPARE PART																										
Code	Description	Image	Code	Description	Components list																								
PD1074A	H=100 SQUARE FOO		KPD1074A	MIND.MAPS H100 FOOT KIT	<table border="1"> <thead> <tr> <th>Code</th> <th>Description</th> <th>Qty</th> <th>UOM</th> </tr> </thead> <tbody> <tr> <td>PD1074A0</td> <td>H=100 SQUARE FOO</td> <td>1</td> <td>PZ</td> </tr> <tr> <td>PD1075A0</td> <td>FOOT LOCKING BRACKET</td> <td>1</td> <td>PZ</td> </tr> <tr> <td>PD1075A1</td> <td>PD1074 FOOT LOCKING BRACKET</td> <td>1</td> <td>PZ</td> </tr> <tr> <td>VI1220A1</td> <td>4,2X12 TCB SELF-TAPPIN G SCREW</td> <td>5</td> <td>PZ</td> </tr> <tr> <td>VM1224A0</td> <td>65MY 220MM 2 COLOURS SHRINK TUBE</td> <td>0.300</td> <td>M</td> </tr> </tbody> </table>	Code	Description	Qty	UOM	PD1074A0	H=100 SQUARE FOO	1	PZ	PD1075A0	FOOT LOCKING BRACKET	1	PZ	PD1075A1	PD1074 FOOT LOCKING BRACKET	1	PZ	VI1220A1	4,2X12 TCB SELF-TAPPIN G SCREW	5	PZ	VM1224A0	65MY 220MM 2 COLOURS SHRINK TUBE	0.300	M
Code	Description	Qty	UOM																										
PD1074A0	H=100 SQUARE FOO	1	PZ																										
PD1075A0	FOOT LOCKING BRACKET	1	PZ																										
PD1075A1	PD1074 FOOT LOCKING BRACKET	1	PZ																										
VI1220A1	4,2X12 TCB SELF-TAPPIN G SCREW	5	PZ																										
VM1224A0	65MY 220MM 2 COLOURS SHRINK TUBE	0.300	M																										
PD1075A	PD1074 FOOT LOCKING BRACKET		KPD1075A	OVEN FOOT STOPPING BRACKET KIT	<table border="1"> <thead> <tr> <th>Code</th> <th>Description</th> <th>Qty</th> <th>UOM</th> </tr> </thead> <tbody> <tr> <td>PD1075A0</td> <td>FOOT LOCKING BRACKET</td> <td>4</td> <td>PZ</td> </tr> <tr> <td>PD1075A1</td> <td>PD1074 FOOT LOCKING BRACKET</td> <td>4</td> <td>PZ</td> </tr> <tr> <td>VI1950A0</td> <td>ST. STEEL 4,2X13 TCB SELF-DRILLIN G SCREW</td> <td>8</td> <td>PZ</td> </tr> </tbody> </table>	Code	Description	Qty	UOM	PD1075A0	FOOT LOCKING BRACKET	4	PZ	PD1075A1	PD1074 FOOT LOCKING BRACKET	4	PZ	VI1950A0	ST. STEEL 4,2X13 TCB SELF-DRILLIN G SCREW	8	PZ								
Code	Description	Qty	UOM																										
PD1075A0	FOOT LOCKING BRACKET	4	PZ																										
PD1075A1	PD1074 FOOT LOCKING BRACKET	4	PZ																										
VI1950A0	ST. STEEL 4,2X13 TCB SELF-DRILLIN G SCREW	8	PZ																										
0H1019A	BRACKET FOR CHEFTOP H100 FEE		0H1019A2	BRACKET FOR CHEFTOP H100 FEE																									
VM2061A	ACCESSORIES CABLES WALL PASSING		KVM1505A	THROUGH-WALL CONNECTION+DIAPHRAGM KIT	<table border="1"> <thead> <tr> <th>Code</th> <th>Description</th> <th>Qty</th> <th>UOM</th> </tr> </thead> <tbody> <tr> <td>VI1220A1</td> <td>4,2X12 TCB SELF-TAPPIN G SCREW</td> <td>1</td> <td>PZ</td> </tr> <tr> <td>VM1224A0</td> <td>65MY 220MM 2 COLOURS SHRINK TUBE</td> <td>0.200</td> <td>M</td> </tr> <tr> <td>VM1505A0</td> <td>WALL PASSING WITH DIAPHRAGM</td> <td>3</td> <td>PZ</td> </tr> <tr> <td>VM2055A0</td> <td>UPPER WALL PASSING ACCESSORY CABLES</td> <td>1</td> <td>PZ</td> </tr> <tr> <td>VM2056A0</td> <td>LOWER WALL PASSING ACCESSORY CABLES</td> <td>1</td> <td>PZ</td> </tr> </tbody> </table>	Code	Description	Qty	UOM	VI1220A1	4,2X12 TCB SELF-TAPPIN G SCREW	1	PZ	VM1224A0	65MY 220MM 2 COLOURS SHRINK TUBE	0.200	M	VM1505A0	WALL PASSING WITH DIAPHRAGM	3	PZ	VM2055A0	UPPER WALL PASSING ACCESSORY CABLES	1	PZ	VM2056A0	LOWER WALL PASSING ACCESSORY CABLES	1	PZ
Code	Description	Qty	UOM																										
VI1220A1	4,2X12 TCB SELF-TAPPIN G SCREW	1	PZ																										
VM1224A0	65MY 220MM 2 COLOURS SHRINK TUBE	0.200	M																										
VM1505A0	WALL PASSING WITH DIAPHRAGM	3	PZ																										
VM2055A0	UPPER WALL PASSING ACCESSORY CABLES	1	PZ																										
VM2056A0	LOWER WALL PASSING ACCESSORY CABLES	1	PZ																										

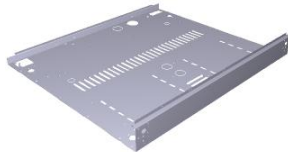

COMPONENT			SPARE PART																		
Code	Description	Image	Code	Description	Components list																
VM2450A	THROUG-WALL CONNECTION 3 PIPES		KVM2450A	3 PIPES THROUGH-WALL CONNECTION KIT	<table border="1"> <thead> <tr> <th>Code</th> <th>Description</th> <th>Qty</th> <th>UOM</th> </tr> </thead> <tbody> <tr> <td>VM1224A0</td> <td>65MY 220MM 2 COLOURS SHRINK TUBE</td> <td>0.200</td> <td>M</td> </tr> <tr> <td>VM2450A0</td> <td>THROUG-WAL L CONNECTION 3 PIPES</td> <td>1</td> <td>PZ</td> </tr> <tr> <td>VM2450A0</td> <td>THROUG-WAL L CONNECTION 3 PIPES</td> <td>1</td> <td>PZ</td> </tr> </tbody> </table>	Code	Description	Qty	UOM	VM1224A0	65MY 220MM 2 COLOURS SHRINK TUBE	0.200	M	VM2450A0	THROUG-WAL L CONNECTION 3 PIPES	1	PZ	VM2450A0	THROUG-WAL L CONNECTION 3 PIPES	1	PZ
Code	Description	Qty	UOM																		
VM1224A0	65MY 220MM 2 COLOURS SHRINK TUBE	0.200	M																		
VM2450A0	THROUG-WAL L CONNECTION 3 PIPES	1	PZ																		
VM2450A0	THROUG-WAL L CONNECTION 3 PIPES	1	PZ																		
0D2295A	GN1-1 XEVC EXTERNAL COVER		0D2295A0	GN1-1 XEVC EXTERNAL COVER																	
0H2561A	6 S. DOOR COUNTERBRACKET		0H2561A0	6 S. DOOR COUNTERBRACKET																	
VM1240A	NYLON SUPPORT CAP		KVM1240A	4 PCS COUNTER BRACKET SUPPORT CAP KIT	<table border="1"> <thead> <tr> <th>Code</th> <th>Description</th> <th>Qty</th> <th>UOM</th> </tr> </thead> <tbody> <tr> <td>VM1224A0</td> <td>65MY 220MM 2 COLOURS SHRINK TUBE</td> <td>0.200</td> <td>M</td> </tr> <tr> <td>VM1240A0</td> <td>NYLON SUPPORT CAP</td> <td>4</td> <td>PZ</td> </tr> </tbody> </table>	Code	Description	Qty	UOM	VM1224A0	65MY 220MM 2 COLOURS SHRINK TUBE	0.200	M	VM1240A0	NYLON SUPPORT CAP	4	PZ				
Code	Description	Qty	UOM																		
VM1224A0	65MY 220MM 2 COLOURS SHRINK TUBE	0.200	M																		
VM1240A0	NYLON SUPPORT CAP	4	PZ																		
VM2310A	UPPER DOOR BRACKET HOLES COVER		KVM2310A	UPPER BRACKET HOLE COVER KIT	<table border="1"> <thead> <tr> <th>Code</th> <th>Description</th> <th>Qty</th> <th>UOM</th> </tr> </thead> <tbody> <tr> <td>VM1224A0</td> <td>65MY 220MM 2 COLOURS SHRINK TUBE</td> <td>0.300</td> <td>M</td> </tr> <tr> <td>VM2310A0</td> <td>UPPER DOOR BRACKET HOLES COVER</td> <td>1</td> <td>PZ</td> </tr> </tbody> </table>	Code	Description	Qty	UOM	VM1224A0	65MY 220MM 2 COLOURS SHRINK TUBE	0.300	M	VM2310A0	UPPER DOOR BRACKET HOLES COVER	1	PZ				
Code	Description	Qty	UOM																		
VM1224A0	65MY 220MM 2 COLOURS SHRINK TUBE	0.300	M																		
VM2310A0	UPPER DOOR BRACKET HOLES COVER	1	PZ																		



COMPONENT			SPARE PART																														
Code	Description	Image	Code	Description	Components list																												
0D2300A	XEVC-0711 LEFT SIDE PANEL		0D2300A1	XEVC-0711 LEFT SIDE PANEL																													
0D2301A	XEVC-0711 EXTERNAL RIGHT SIDE		0D2301A1	XEVC-0711 EXTERNAL RIGHT SIDE																													
0E1350C	GN1-1 XEVC EXTERNAL BOTTOM PANEL		0E1350C0	GN1-1 XEVC EXTERNAL BOTTOM PANEL																													
TR1136A	330 °C 1 POLE SAFETY THERMOSTAT		KTR1136A	330 °C SAFETY THERMOSTAT KIT	<table border="1"> <thead> <tr> <th>Code</th> <th>Description</th> <th>Qty</th> <th>UOM</th> </tr> </thead> <tbody> <tr> <td>0H7030A0</td> <td>THERMOSTAT BULB INLET COVER</td> <td>1</td> <td>PZ</td> </tr> <tr> <td>GN1531A0</td> <td>THERMOSTAT BULB INLET SEALING</td> <td>1</td> <td>PZ</td> </tr> <tr> <td>MOV0011A0</td> <td>HOOD RING GASKET GN1110A2</td> <td>0.100</td> <td>PZ</td> </tr> <tr> <td>SL1045A0</td> <td>S57 BLACK SILICONE - 80ML CARTRIDGE</td> <td>1</td> <td>PZ</td> </tr> <tr> <td>TR1136A0</td> <td>330 °C 1 POLE SAFETY THERMOSTAT</td> <td>1</td> <td>PZ</td> </tr> <tr> <td>VI1220A1</td> <td>4,2X12 TCB SELF-TAPPING SCREW</td> <td>3</td> <td>PZ</td> </tr> </tbody> </table>	Code	Description	Qty	UOM	0H7030A0	THERMOSTAT BULB INLET COVER	1	PZ	GN1531A0	THERMOSTAT BULB INLET SEALING	1	PZ	MOV0011A0	HOOD RING GASKET GN1110A2	0.100	PZ	SL1045A0	S57 BLACK SILICONE - 80ML CARTRIDGE	1	PZ	TR1136A0	330 °C 1 POLE SAFETY THERMOSTAT	1	PZ	VI1220A1	4,2X12 TCB SELF-TAPPING SCREW	3	PZ
Code	Description	Qty	UOM																														
0H7030A0	THERMOSTAT BULB INLET COVER	1	PZ																														
GN1531A0	THERMOSTAT BULB INLET SEALING	1	PZ																														
MOV0011A0	HOOD RING GASKET GN1110A2	0.100	PZ																														
SL1045A0	S57 BLACK SILICONE - 80ML CARTRIDGE	1	PZ																														
TR1136A0	330 °C 1 POLE SAFETY THERMOSTAT	1	PZ																														
VI1220A1	4,2X12 TCB SELF-TAPPING SCREW	3	PZ																														

COMPONENT			SPARE PART																										
Code	Description	Image	Code	Description	Components list																								
VM2249A	COOKING CHAMBER FRONT CORNER		KVM2249A	CHAMBER FRONT PROFILE CORNER KIT	<table border="1"> <thead> <tr> <th>Code</th> <th>Description</th> <th>Qty</th> <th>UOM</th> </tr> </thead> <tbody> <tr> <td>VM1224A0</td> <td>65MY 220MM 2 COLOURS SHRINK TUBE</td> <td>0.150</td> <td>M</td> </tr> <tr> <td>VM2249A0</td> <td>COOKING CHAMBER FRONT CORNER</td> <td>1</td> <td>PZ</td> </tr> </tbody> </table>	Code	Description	Qty	UOM	VM1224A0	65MY 220MM 2 COLOURS SHRINK TUBE	0.150	M	VM2249A0	COOKING CHAMBER FRONT CORNER	1	PZ												
Code	Description	Qty	UOM																										
VM1224A0	65MY 220MM 2 COLOURS SHRINK TUBE	0.150	M																										
VM2249A0	COOKING CHAMBER FRONT CORNER	1	PZ																										
0F1497A	XEVC-0711-E BACK PANEL		0F1497A0	XEVC-0711-E BACK PANEL																									
VL1095A	D7.8-D10 RUBBER HOLDER M-M FITTING		KVL1095A	STRAIGHT CONNECT-HOLDER D7-D10 10PCS KIT	<table border="1"> <thead> <tr> <th>Code</th> <th>Description</th> <th>Qty</th> <th>UOM</th> </tr> </thead> <tbody> <tr> <td>VL1095A0</td> <td>D7.8-D10 RUBBER HOLDER M-M FITTING</td> <td>10</td> <td>PZ</td> </tr> <tr> <td>VM1224A0</td> <td>65MY 220MM 2 COLOURS SHRINK TUBE</td> <td>0.200</td> <td>M</td> </tr> </tbody> </table>	Code	Description	Qty	UOM	VL1095A0	D7.8-D10 RUBBER HOLDER M-M FITTING	10	PZ	VM1224A0	65MY 220MM 2 COLOURS SHRINK TUBE	0.200	M												
Code	Description	Qty	UOM																										
VL1095A0	D7.8-D10 RUBBER HOLDER M-M FITTING	10	PZ																										
VM1224A0	65MY 220MM 2 COLOURS SHRINK TUBE	0.200	M																										
VM1054A	H7.8 PRESSURE REDUCER RING NUT		KVM1054A	H7.8 PRESSURE REDUCER DIAL KIT	<table border="1"> <thead> <tr> <th>Code</th> <th>Description</th> <th>Qty</th> <th>UOM</th> </tr> </thead> <tbody> <tr> <td>VM1054A0</td> <td>H7.8 PRESSURE REDUCER RING NUT</td> <td>1</td> <td>PZ</td> </tr> <tr> <td>VM1224A0</td> <td>65MY 220MM 2 COLOURS SHRINK TUBE</td> <td>0.200</td> <td>M</td> </tr> </tbody> </table>	Code	Description	Qty	UOM	VM1054A0	H7.8 PRESSURE REDUCER RING NUT	1	PZ	VM1224A0	65MY 220MM 2 COLOURS SHRINK TUBE	0.200	M												
Code	Description	Qty	UOM																										
VM1054A0	H7.8 PRESSURE REDUCER RING NUT	1	PZ																										
VM1224A0	65MY 220MM 2 COLOURS SHRINK TUBE	0.200	M																										
			KVL1117A	EUR MM 2016+LMT FILTER+PRESS. RED. KIT	<table border="1"> <thead> <tr> <th>Code</th> <th>Description</th> <th>Qty</th> <th>UOM</th> </tr> </thead> <tbody> <tr> <td>0H7472A1</td> <td>DISTRIBUTOR SUPPORT PLATE</td> <td>1</td> <td>PZ</td> </tr> <tr> <td>RC1004A0</td> <td>Ø10-Ø8-8 Y CONNECTION</td> <td>1</td> <td>PZ</td> </tr> <tr> <td>RC1243A0</td> <td>Ø10F-Ø10M ELBOW CONNECTION + JG END KIT</td> <td>1</td> <td>PZ</td> </tr> <tr> <td>RC1372A0</td> <td>Ø10M-1/4 M CIL. STRAIGHT FITTING</td> <td>2</td> <td>PZ</td> </tr> <tr> <td>VI1220A1</td> <td>4,2X12 TCB SELF-TAPPING SCREW</td> <td>4</td> <td>PZ</td> </tr> </tbody> </table>	Code	Description	Qty	UOM	0H7472A1	DISTRIBUTOR SUPPORT PLATE	1	PZ	RC1004A0	Ø10-Ø8-8 Y CONNECTION	1	PZ	RC1243A0	Ø10F-Ø10M ELBOW CONNECTION + JG END KIT	1	PZ	RC1372A0	Ø10M-1/4 M CIL. STRAIGHT FITTING	2	PZ	VI1220A1	4,2X12 TCB SELF-TAPPING SCREW	4	PZ
Code	Description	Qty	UOM																										
0H7472A1	DISTRIBUTOR SUPPORT PLATE	1	PZ																										
RC1004A0	Ø10-Ø8-8 Y CONNECTION	1	PZ																										
RC1243A0	Ø10F-Ø10M ELBOW CONNECTION + JG END KIT	1	PZ																										
RC1372A0	Ø10M-1/4 M CIL. STRAIGHT FITTING	2	PZ																										
VI1220A1	4,2X12 TCB SELF-TAPPING SCREW	4	PZ																										



COMPONENT			SPARE PART																										
Code	Description	Image	Code	Description	Components list																								
VM1054A	H7.8 PRESSURE REDUCER RING NUT		KVL1117A	EUR MM 2016+LMT FILTER+PRESS. RED. KIT	<table border="1"> <thead> <tr> <th>Code</th> <th>Description</th> <th>Qty</th> <th>UOM</th> </tr> </thead> <tbody> <tr> <td>VL1014B1</td> <td>PRESSURE REDUCER WITH DISTRIBUTOR</td> <td>1</td> <td>PZ</td> </tr> <tr> <td>VL1014B2</td> <td>PRESSURE REDUCER WITH DISTRIBUTOR</td> <td>1</td> <td>PZ</td> </tr> <tr> <td>VL1034C0</td> <td>MESH WATER FILTER D10</td> <td>1</td> <td>PZ</td> </tr> <tr> <td>VL1062C0</td> <td>PRESSURE REDUCER-FILTER LOCKING FORK</td> <td>1</td> <td>PZ</td> </tr> <tr> <td>VM1054A0</td> <td>H7.8 PRESSURE REDUCER RING NUT</td> <td>1</td> <td>PZ</td> </tr> </tbody> </table>	Code	Description	Qty	UOM	VL1014B1	PRESSURE REDUCER WITH DISTRIBUTOR	1	PZ	VL1014B2	PRESSURE REDUCER WITH DISTRIBUTOR	1	PZ	VL1034C0	MESH WATER FILTER D10	1	PZ	VL1062C0	PRESSURE REDUCER-FILTER LOCKING FORK	1	PZ	VM1054A0	H7.8 PRESSURE REDUCER RING NUT	1	PZ
Code	Description	Qty	UOM																										
VL1014B1	PRESSURE REDUCER WITH DISTRIBUTOR	1	PZ																										
VL1014B2	PRESSURE REDUCER WITH DISTRIBUTOR	1	PZ																										
VL1034C0	MESH WATER FILTER D10	1	PZ																										
VL1062C0	PRESSURE REDUCER-FILTER LOCKING FORK	1	PZ																										
VM1054A0	H7.8 PRESSURE REDUCER RING NUT	1	PZ																										
RC1396A	JG D10-1/4 STRAIGHT END FITTING		KVL0014B	EUR 2017 MIND.MAPS PRESSURE REDUCER KIT	<table border="1"> <thead> <tr> <th>Code</th> <th>Description</th> <th>Qty</th> <th>UOM</th> </tr> </thead> <tbody> <tr> <td>RC1372A0</td> <td>Ø10M-1/4 M CIL. STRAIGHT FITTING</td> <td>1</td> <td>PZ</td> </tr> <tr> <td>RC1396A0</td> <td>JG D10-1/4 STRAIGHT END FITTING</td> <td>1</td> <td>PZ</td> </tr> <tr> <td>VL1014B1</td> <td>PRESSURE REDUCER WITH DISTRIBUTOR</td> <td>1</td> <td>PZ</td> </tr> <tr> <td>VL1014B2</td> <td>PRESSURE REDUCER WITH DISTRIBUTOR</td> <td>1</td> <td>PZ</td> </tr> <tr> <td>VM1054A0</td> <td>H7.8 PRESSURE REDUCER RING NUT</td> <td>1</td> <td>PZ</td> </tr> </tbody> </table>	Code	Description	Qty	UOM	RC1372A0	Ø10M-1/4 M CIL. STRAIGHT FITTING	1	PZ	RC1396A0	JG D10-1/4 STRAIGHT END FITTING	1	PZ	VL1014B1	PRESSURE REDUCER WITH DISTRIBUTOR	1	PZ	VL1014B2	PRESSURE REDUCER WITH DISTRIBUTOR	1	PZ	VM1054A0	H7.8 PRESSURE REDUCER RING NUT	1	PZ
Code	Description	Qty	UOM																										
RC1372A0	Ø10M-1/4 M CIL. STRAIGHT FITTING	1	PZ																										
RC1396A0	JG D10-1/4 STRAIGHT END FITTING	1	PZ																										
VL1014B1	PRESSURE REDUCER WITH DISTRIBUTOR	1	PZ																										
VL1014B2	PRESSURE REDUCER WITH DISTRIBUTOR	1	PZ																										
VM1054A0	H7.8 PRESSURE REDUCER RING NUT	1	PZ																										
VL1014B	PRESSURE REDUCER WITH DISTRIBUTOR		KVL0020A	PRESS. REDUCER 03-05XX=OCT18 / MM=MAR19	<table border="1"> <thead> <tr> <th>Code</th> <th>Description</th> <th>Qty</th> <th>UOM</th> </tr> </thead> <tbody> <tr> <td>RC1396A0</td> <td>JG D10-1/4 STRAIGHT END FITTING</td> <td>2</td> <td>PZ</td> </tr> <tr> <td>VL1014B1</td> <td>PRESSURE REDUCER WITH DISTRIBUTOR</td> <td>1</td> <td>PZ</td> </tr> <tr> <td>VL1014B2</td> <td>PRESSURE REDUCER WITH DISTRIBUTOR</td> <td>1</td> <td>PZ</td> </tr> <tr> <td>VM1054A0</td> <td>H7.8 PRESSURE REDUCER RING NUT</td> <td>1</td> <td>PZ</td> </tr> </tbody> </table>	Code	Description	Qty	UOM	RC1396A0	JG D10-1/4 STRAIGHT END FITTING	2	PZ	VL1014B1	PRESSURE REDUCER WITH DISTRIBUTOR	1	PZ	VL1014B2	PRESSURE REDUCER WITH DISTRIBUTOR	1	PZ	VM1054A0	H7.8 PRESSURE REDUCER RING NUT	1	PZ				
Code	Description	Qty	UOM																										
RC1396A0	JG D10-1/4 STRAIGHT END FITTING	2	PZ																										
VL1014B1	PRESSURE REDUCER WITH DISTRIBUTOR	1	PZ																										
VL1014B2	PRESSURE REDUCER WITH DISTRIBUTOR	1	PZ																										
VM1054A0	H7.8 PRESSURE REDUCER RING NUT	1	PZ																										

COMPONENT			SPARE PART																										
Code	Description	Image	Code	Description	Components list																								
VL1014B	PRESSURE REDUCER WITH DISTRIBUTOR		KVL0014B	EUR 2017 MIND.MAPS PRESSURE REDUCER KIT	<table border="1"> <thead> <tr> <th>Code</th> <th>Description</th> <th>Qty</th> <th>UOM</th> </tr> </thead> <tbody> <tr> <td>RC1372A0</td> <td>Ø10M-1/4 M CIL. STRAIGHT FITTING</td> <td>1</td> <td>PZ</td> </tr> <tr> <td>RC1396A0</td> <td>JG D10-1/4 STRAIGHT END FITTING</td> <td>1</td> <td>PZ</td> </tr> <tr> <td>VL1014B1</td> <td>PRESSURE REDUCER WITH DISTRIBUTOR</td> <td>1</td> <td>PZ</td> </tr> <tr> <td>VL1014B2</td> <td>PRESSURE REDUCER WITH DISTRIBUTOR</td> <td>1</td> <td>PZ</td> </tr> <tr> <td>VM1054A0</td> <td>H7.8 PRESSURE REDUCER RING NUT</td> <td>1</td> <td>PZ</td> </tr> </tbody> </table>	Code	Description	Qty	UOM	RC1372A0	Ø10M-1/4 M CIL. STRAIGHT FITTING	1	PZ	RC1396A0	JG D10-1/4 STRAIGHT END FITTING	1	PZ	VL1014B1	PRESSURE REDUCER WITH DISTRIBUTOR	1	PZ	VL1014B2	PRESSURE REDUCER WITH DISTRIBUTOR	1	PZ	VM1054A0	H7.8 PRESSURE REDUCER RING NUT	1	PZ
			Code	Description	Qty	UOM																							
			RC1372A0	Ø10M-1/4 M CIL. STRAIGHT FITTING	1	PZ																							
RC1396A0	JG D10-1/4 STRAIGHT END FITTING	1	PZ																										
VL1014B1	PRESSURE REDUCER WITH DISTRIBUTOR	1	PZ																										
VL1014B2	PRESSURE REDUCER WITH DISTRIBUTOR	1	PZ																										
VM1054A0	H7.8 PRESSURE REDUCER RING NUT	1	PZ																										
KVL0014A	EUR MIND.MAPS PRESSURE REDUCER KIT 2016	<table border="1"> <thead> <tr> <th>Code</th> <th>Description</th> <th>Qty</th> <th>UOM</th> </tr> </thead> <tbody> <tr> <td>RC1372A0</td> <td>Ø10M-1/4 M CIL. STRAIGHT FITTING</td> <td>2</td> <td>PZ</td> </tr> <tr> <td>VL1014B1</td> <td>PRESSURE REDUCER WITH DISTRIBUTOR</td> <td>1</td> <td>PZ</td> </tr> <tr> <td>VL1014B2</td> <td>PRESSURE REDUCER WITH DISTRIBUTOR</td> <td>1</td> <td>PZ</td> </tr> <tr> <td>VM1054A0</td> <td>H7.8 PRESSURE REDUCER RING NUT</td> <td>1</td> <td>PZ</td> </tr> </tbody> </table>	Code	Description	Qty	UOM	RC1372A0	Ø10M-1/4 M CIL. STRAIGHT FITTING	2	PZ	VL1014B1	PRESSURE REDUCER WITH DISTRIBUTOR	1	PZ	VL1014B2	PRESSURE REDUCER WITH DISTRIBUTOR	1	PZ	VM1054A0	H7.8 PRESSURE REDUCER RING NUT	1	PZ							
Code	Description	Qty	UOM																										
RC1372A0	Ø10M-1/4 M CIL. STRAIGHT FITTING	2	PZ																										
VL1014B1	PRESSURE REDUCER WITH DISTRIBUTOR	1	PZ																										
VL1014B2	PRESSURE REDUCER WITH DISTRIBUTOR	1	PZ																										
VM1054A0	H7.8 PRESSURE REDUCER RING NUT	1	PZ																										
KVL0010A	S.4 - 5 WATER PRESSURE REDUCER KIT	<table border="1"> <thead> <tr> <th>Code</th> <th>Description</th> <th>Qty</th> <th>UOM</th> </tr> </thead> <tbody> <tr> <td>EL1210A0</td> <td>D8-BSP1/4 JG STRAIGHT END CONNECTION</td> <td>2</td> <td>PZ</td> </tr> <tr> <td>VL1014B1</td> <td>PRESSURE REDUCER WITH DISTRIBUTOR</td> <td>1</td> <td>PZ</td> </tr> <tr> <td>VL1014B2</td> <td>PRESSURE REDUCER WITH DISTRIBUTOR</td> <td>1</td> <td>PZ</td> </tr> </tbody> </table>	Code	Description	Qty	UOM	EL1210A0	D8-BSP1/4 JG STRAIGHT END CONNECTION	2	PZ	VL1014B1	PRESSURE REDUCER WITH DISTRIBUTOR	1	PZ	VL1014B2	PRESSURE REDUCER WITH DISTRIBUTOR	1	PZ											
Code	Description	Qty	UOM																										
EL1210A0	D8-BSP1/4 JG STRAIGHT END CONNECTION	2	PZ																										
VL1014B1	PRESSURE REDUCER WITH DISTRIBUTOR	1	PZ																										
VL1014B2	PRESSURE REDUCER WITH DISTRIBUTOR	1	PZ																										

COMPONENT			SPARE PART																																														
Code	Description	Image	Code	Description	Components list																																												
RC1243A	Ø10F-Ø10M ELBOW CONNECTION + JG END KIT		KVL1117A	EUR MM 2016+LMT FILTER+PRESS. RED. KIT	<table border="1"> <thead> <tr> <th>Code</th> <th>Description</th> <th>Qty</th> <th>UOM</th> </tr> </thead> <tbody> <tr> <td>0H7472A1</td> <td>DISTRIBUTOR SUPPORT PLATE</td> <td>1</td> <td>PZ</td> </tr> <tr> <td>RC1004A0</td> <td>Ø10-Ø8-8 Y CONNECTION</td> <td>1</td> <td>PZ</td> </tr> <tr> <td>RC1243A0</td> <td>Ø10F-Ø10M ELBOW CONNECTION + JG END KIT</td> <td>1</td> <td>PZ</td> </tr> <tr> <td>RC1372A0</td> <td>Ø10M-1/4 M CIL. STRAIGHT FITTING</td> <td>2</td> <td>PZ</td> </tr> <tr> <td>VI1220A1</td> <td>4,2X12 TCB SELF-TAPPIN G SCREW</td> <td>4</td> <td>PZ</td> </tr> <tr> <td>VL1014B1</td> <td>PRESSURE REDUCER WITH DISTRIBUTOR</td> <td>1</td> <td>PZ</td> </tr> <tr> <td>VL1014B2</td> <td>PRESSURE REDUCER WITH DISTRIBUTOR</td> <td>1</td> <td>PZ</td> </tr> <tr> <td>VL1034C0</td> <td>MESH WATER FILTER D10</td> <td>1</td> <td>PZ</td> </tr> <tr> <td>VL1062C0</td> <td>PRESSURE REDUCER-FILTER LOCKING FORK</td> <td>1</td> <td>PZ</td> </tr> <tr> <td>VM1054A0</td> <td>H7.8 PRESSURE REDUCER RING NUT</td> <td>1</td> <td>PZ</td> </tr> </tbody> </table>	Code	Description	Qty	UOM	0H7472A1	DISTRIBUTOR SUPPORT PLATE	1	PZ	RC1004A0	Ø10-Ø8-8 Y CONNECTION	1	PZ	RC1243A0	Ø10F-Ø10M ELBOW CONNECTION + JG END KIT	1	PZ	RC1372A0	Ø10M-1/4 M CIL. STRAIGHT FITTING	2	PZ	VI1220A1	4,2X12 TCB SELF-TAPPIN G SCREW	4	PZ	VL1014B1	PRESSURE REDUCER WITH DISTRIBUTOR	1	PZ	VL1014B2	PRESSURE REDUCER WITH DISTRIBUTOR	1	PZ	VL1034C0	MESH WATER FILTER D10	1	PZ	VL1062C0	PRESSURE REDUCER-FILTER LOCKING FORK	1	PZ	VM1054A0	H7.8 PRESSURE REDUCER RING NUT	1	PZ
			Code	Description	Qty	UOM																																											
0H7472A1	DISTRIBUTOR SUPPORT PLATE	1	PZ																																														
RC1004A0	Ø10-Ø8-8 Y CONNECTION	1	PZ																																														
RC1243A0	Ø10F-Ø10M ELBOW CONNECTION + JG END KIT	1	PZ																																														
RC1372A0	Ø10M-1/4 M CIL. STRAIGHT FITTING	2	PZ																																														
VI1220A1	4,2X12 TCB SELF-TAPPIN G SCREW	4	PZ																																														
VL1014B1	PRESSURE REDUCER WITH DISTRIBUTOR	1	PZ																																														
VL1014B2	PRESSURE REDUCER WITH DISTRIBUTOR	1	PZ																																														
VL1034C0	MESH WATER FILTER D10	1	PZ																																														
VL1062C0	PRESSURE REDUCER-FILTER LOCKING FORK	1	PZ																																														
VM1054A0	H7.8 PRESSURE REDUCER RING NUT	1	PZ																																														
KRC1243A	Ø10F-Ø10M ELBOW CONN + JG END 10 PCS KIT	<table border="1"> <thead> <tr> <th>Code</th> <th>Description</th> <th>Qty</th> <th>UOM</th> </tr> </thead> <tbody> <tr> <td>RC1243A0</td> <td>Ø10F-Ø10M ELBOW CONNECTION + JG END KIT</td> <td>10</td> <td>PZ</td> </tr> <tr> <td>VM1224A0</td> <td>65MY 220MM 2 COLOURS SHRINK TUBE</td> <td>0.200</td> <td>M</td> </tr> </tbody> </table>	Code	Description	Qty	UOM	RC1243A0	Ø10F-Ø10M ELBOW CONNECTION + JG END KIT	10	PZ	VM1224A0	65MY 220MM 2 COLOURS SHRINK TUBE	0.200	M																																			
Code	Description	Qty	UOM																																														
RC1243A0	Ø10F-Ø10M ELBOW CONNECTION + JG END KIT	10	PZ																																														
VM1224A0	65MY 220MM 2 COLOURS SHRINK TUBE	0.200	M																																														
VL1135A	3/4-JG10 CONNECTOR + FILTER AND NRV		KVL1135A	3/4-JG10 FITTING WITH FILTER AND VNR KIT	<table border="1"> <thead> <tr> <th>Code</th> <th>Description</th> <th>Qty</th> <th>UOM</th> </tr> </thead> <tbody> <tr> <td>VL1135A0</td> <td>3/4-JG10 CONNECTOR + FILTER AND NRV</td> <td>1</td> <td>PZ</td> </tr> <tr> <td>VM1224A0</td> <td>65MY 220MM 2 COLOURS SHRINK TUBE</td> <td>0.150</td> <td>M</td> </tr> </tbody> </table>	Code	Description	Qty	UOM	VL1135A0	3/4-JG10 CONNECTOR + FILTER AND NRV	1	PZ	VM1224A0	65MY 220MM 2 COLOURS SHRINK TUBE	0.150	M																																
Code	Description	Qty	UOM																																														
VL1135A0	3/4-JG10 CONNECTOR + FILTER AND NRV	1	PZ																																														
VM1224A0	65MY 220MM 2 COLOURS SHRINK TUBE	0.150	M																																														





COMPONENT			SPARE PART														
Code	Description	Image	Code	Description	Components list												
TB3251A	TB3131A-H2O STEAM INLET PIPE		KTB3131A	WHITE-BLACK 6X12 REINFORCED PIPE 3M KIT	<table border="1"> <thead> <tr> <th>Code</th> <th>Description</th> <th>Qty</th> <th>UOM</th> </tr> </thead> <tbody> <tr> <td>TB3131A0</td> <td>WHITE-BLACK EPDM TEXTILE BRAID HOSE 6X12</td> <td>3</td> <td>M</td> </tr> <tr> <td>VM1794A0</td> <td>250X4.8 PA66 BLACK CLAMP</td> <td>1</td> <td>PZ</td> </tr> </tbody> </table>	Code	Description	Qty	UOM	TB3131A0	WHITE-BLACK EPDM TEXTILE BRAID HOSE 6X12	3	M	VM1794A0	250X4.8 PA66 BLACK CLAMP	1	PZ
Code	Description	Qty	UOM														
TB3131A0	WHITE-BLACK EPDM TEXTILE BRAID HOSE 6X12	3	M														
VM1794A0	250X4.8 PA66 BLACK CLAMP	1	PZ														
0H8038A	MM REDUCER SUPPORT PLATE		0H8038A0	MM REDUCER SUPPORT PLATE													
0H2562A			0H2562A0														
0H2561A	6 S. DOOR COUNTERBRACKET		0H2561A0	6 S. DOOR COUNTERBRACKET													
VM1240A	NYLON SUPPORT CAP		KVM1240A	4 PCS COUNTER BRACKET SUPPORT CAP KIT	<table border="1"> <thead> <tr> <th>Code</th> <th>Description</th> <th>Qty</th> <th>UOM</th> </tr> </thead> <tbody> <tr> <td>VM1224A0</td> <td>65MY 220MM 2 COLOURS SHRINK TUBE</td> <td>0.200</td> <td>M</td> </tr> <tr> <td>VM1240A0</td> <td>NYLON SUPPORT CAP</td> <td>4</td> <td>PZ</td> </tr> </tbody> </table>	Code	Description	Qty	UOM	VM1224A0	65MY 220MM 2 COLOURS SHRINK TUBE	0.200	M	VM1240A0	NYLON SUPPORT CAP	4	PZ
Code	Description	Qty	UOM														
VM1224A0	65MY 220MM 2 COLOURS SHRINK TUBE	0.200	M														
VM1240A0	NYLON SUPPORT CAP	4	PZ														

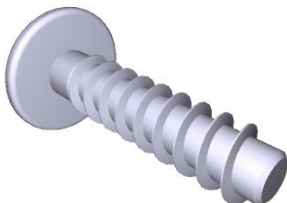

COMPONENT			SPARE PART																																						
Code	Description	Image	Code	Description	Components list																																				
VE1020B	MAGNET DOOR MICROSWITCH		KVE1020B	MICROSWITCH KIT	<table border="1"> <thead> <tr> <th>Code</th> <th>Description</th> <th>Qty</th> <th>UOM</th> </tr> </thead> <tbody> <tr> <td>CE1030A0</td> <td>FEMALE FASTON COVER 6.3X0.8 0,5-1MMQ</td> <td>2</td> <td>PZ</td> </tr> <tr> <td>CE1660A0</td> <td>6,3X0,8 FEMALE FASTON COVE</td> <td>2</td> <td>PZ</td> </tr> <tr> <td>CE1730A0</td> <td>PVC CABLE NP 2 X AWG22 STYLE 2095</td> <td>0.150</td> <td>M</td> </tr> <tr> <td>CE1740A0</td> <td>MINIFIT MALE END FITTING</td> <td>2</td> <td>PZ</td> </tr> <tr> <td>CE1745A0</td> <td>2 WAYS FEMALE MINIFIT CONNECTOR</td> <td>1</td> <td>PZ</td> </tr> <tr> <td>VE1020B0</td> <td>MAGNET DOOR MICROSWITC</td> <td>1</td> <td>PZ</td> </tr> <tr> <td>VE1030A1</td> <td>MAGNET FOR DOOR MICROSWITC H D=22,9MM</td> <td>1</td> <td>PZ</td> </tr> <tr> <td>VM1224A0</td> <td>65MY 220MM 2 COLOURS SHRINK TUBE</td> <td>0.250</td> <td>M</td> </tr> </tbody> </table>	Code	Description	Qty	UOM	CE1030A0	FEMALE FASTON COVER 6.3X0.8 0,5-1MMQ	2	PZ	CE1660A0	6,3X0,8 FEMALE FASTON COVE	2	PZ	CE1730A0	PVC CABLE NP 2 X AWG22 STYLE 2095	0.150	M	CE1740A0	MINIFIT MALE END FITTING	2	PZ	CE1745A0	2 WAYS FEMALE MINIFIT CONNECTOR	1	PZ	VE1020B0	MAGNET DOOR MICROSWITC	1	PZ	VE1030A1	MAGNET FOR DOOR MICROSWITC H D=22,9MM	1	PZ	VM1224A0	65MY 220MM 2 COLOURS SHRINK TUBE	0.250	M
					Code	Description	Qty	UOM																																	
					CE1030A0	FEMALE FASTON COVER 6.3X0.8 0,5-1MMQ	2	PZ																																	
					CE1660A0	6,3X0,8 FEMALE FASTON COVE	2	PZ																																	
					CE1730A0	PVC CABLE NP 2 X AWG22 STYLE 2095	0.150	M																																	
					CE1740A0	MINIFIT MALE END FITTING	2	PZ																																	
					CE1745A0	2 WAYS FEMALE MINIFIT CONNECTOR	1	PZ																																	
					VE1020B0	MAGNET DOOR MICROSWITC	1	PZ																																	
					VE1030A1	MAGNET FOR DOOR MICROSWITC H D=22,9MM	1	PZ																																	
					VM1224A0	65MY 220MM 2 COLOURS SHRINK TUBE	0.250	M																																	
VP1075A	PLUS/1/ZERO MICROSWITCH SUPPORT COVER		KVP1075A	- M MICROSWITCH SUPPORT PLATE KI	<table border="1"> <thead> <tr> <th>Code</th> <th>Description</th> <th>Qty</th> <th>UOM</th> </tr> </thead> <tbody> <tr> <td>VM1224A0</td> <td>65MY 220MM 2 COLOURS SHRINK TUBE</td> <td>0.200</td> <td>M</td> </tr> <tr> <td>VP1075A0</td> <td>PLUS/1/ZERO MICROSWITC H SUPPORT COVER</td> <td>1</td> <td>PZ</td> </tr> </tbody> </table>	Code	Description	Qty	UOM	VM1224A0	65MY 220MM 2 COLOURS SHRINK TUBE	0.200	M	VP1075A0	PLUS/1/ZERO MICROSWITC H SUPPORT COVER	1	PZ																								
					Code	Description	Qty	UOM																																	
VM1224A0	65MY 220MM 2 COLOURS SHRINK TUBE	0.200	M																																						
VP1075A0	PLUS/1/ZERO MICROSWITC H SUPPORT COVER	1	PZ																																						
VM1190A	CT BT RIGHT DOOR SPRING LATCH		KVM1190A	CHEFTOP/BAKERTO P DOOR RIGHT LATCH KIT	<table border="1"> <thead> <tr> <th>Code</th> <th>Description</th> <th>Qty</th> <th>UOM</th> </tr> </thead> <tbody> <tr> <td>VI0239A1</td> <td>SELF-TAPPIN G SCREW 4.2X25 TCB+ INOX</td> <td>2</td> <td>PZ</td> </tr> <tr> <td>VI1220A1</td> <td>4,2X12 TCB SELF-TAPPIN G SCREW</td> <td>2</td> <td>PZ</td> </tr> <tr> <td>VM1190A2</td> <td>CT BT RIGHT DOOR SPRING LATCH</td> <td>1</td> <td>PZ</td> </tr> <tr> <td>VM1192A1</td> <td>CT BT DOOR SPRING LATCH BACK COVER</td> <td>1</td> <td>PZ</td> </tr> <tr> <td>VM1224A0</td> <td>65MY 220MM 2 COLOURS SHRINK TUBE</td> <td>0.200</td> <td>M</td> </tr> <tr> <td>VM1460A0</td> <td>XBC/XVC RIGHT DOOR LATCH CAP</td> <td>1</td> <td>PZ</td> </tr> </tbody> </table>	Code	Description	Qty	UOM	VI0239A1	SELF-TAPPIN G SCREW 4.2X25 TCB+ INOX	2	PZ	VI1220A1	4,2X12 TCB SELF-TAPPIN G SCREW	2	PZ	VM1190A2	CT BT RIGHT DOOR SPRING LATCH	1	PZ	VM1192A1	CT BT DOOR SPRING LATCH BACK COVER	1	PZ	VM1224A0	65MY 220MM 2 COLOURS SHRINK TUBE	0.200	M	VM1460A0	XBC/XVC RIGHT DOOR LATCH CAP	1	PZ								
					Code	Description	Qty	UOM																																	
					VI0239A1	SELF-TAPPIN G SCREW 4.2X25 TCB+ INOX	2	PZ																																	
					VI1220A1	4,2X12 TCB SELF-TAPPIN G SCREW	2	PZ																																	
					VM1190A2	CT BT RIGHT DOOR SPRING LATCH	1	PZ																																	
					VM1192A1	CT BT DOOR SPRING LATCH BACK COVER	1	PZ																																	
VM1224A0	65MY 220MM 2 COLOURS SHRINK TUBE	0.200	M																																						
VM1460A0	XBC/XVC RIGHT DOOR LATCH CAP	1	PZ																																						

COMPONENT			SPARE PART																														
Code	Description	Image	Code	Description	Components list																												
VM1192A	CT BT DOOR SPRING LATCH BACK COVER		KVM1191A	CHEFTOP/BAKERTO P DOOR LEFT LATCH KIT	<table border="1"> <thead> <tr> <th>Code</th> <th>Description</th> <th>Qty</th> <th>UOM</th> </tr> </thead> <tbody> <tr> <td>VI0239A1</td> <td>SELF-TAPPIN G SCREW 4.2X25 TCB+ INOX</td> <td>2</td> <td>PZ</td> </tr> <tr> <td>VI1220A1</td> <td>4.2X12 TCB SELF-TAPPIN G SCREW</td> <td>2</td> <td>PZ</td> </tr> <tr> <td>VM1191A2</td> <td>CT BT LEFT DOOR SPRING LATCH</td> <td>1</td> <td>PZ</td> </tr> <tr> <td>VM1192A1</td> <td>CT BT DOOR SPRING LATCH BACK COVER</td> <td>1</td> <td>PZ</td> </tr> <tr> <td>VM1224A0</td> <td>65MY 220MM 2 COLOURS SHRINK TUBE</td> <td>0.200</td> <td>M</td> </tr> <tr> <td>VM1460A0</td> <td>XBC/XVC RIGHT DOOR LATCH CAP</td> <td>1</td> <td>PZ</td> </tr> </tbody> </table>	Code	Description	Qty	UOM	VI0239A1	SELF-TAPPIN G SCREW 4.2X25 TCB+ INOX	2	PZ	VI1220A1	4.2X12 TCB SELF-TAPPIN G SCREW	2	PZ	VM1191A2	CT BT LEFT DOOR SPRING LATCH	1	PZ	VM1192A1	CT BT DOOR SPRING LATCH BACK COVER	1	PZ	VM1224A0	65MY 220MM 2 COLOURS SHRINK TUBE	0.200	M	VM1460A0	XBC/XVC RIGHT DOOR LATCH CAP	1	PZ
			Code	Description	Qty	UOM																											
VI0239A1	SELF-TAPPIN G SCREW 4.2X25 TCB+ INOX	2	PZ																														
VI1220A1	4.2X12 TCB SELF-TAPPIN G SCREW	2	PZ																														
VM1191A2	CT BT LEFT DOOR SPRING LATCH	1	PZ																														
VM1192A1	CT BT DOOR SPRING LATCH BACK COVER	1	PZ																														
VM1224A0	65MY 220MM 2 COLOURS SHRINK TUBE	0.200	M																														
VM1460A0	XBC/XVC RIGHT DOOR LATCH CAP	1	PZ																														
KVM1190A	CHEFTOP/BAKERTO P DOOR RIGHT LATCH KIT	<table border="1"> <thead> <tr> <th>Code</th> <th>Description</th> <th>Qty</th> <th>UOM</th> </tr> </thead> <tbody> <tr> <td>VI0239A1</td> <td>SELF-TAPPIN G SCREW 4.2X25 TCB+ INOX</td> <td>2</td> <td>PZ</td> </tr> <tr> <td>VI1220A1</td> <td>4.2X12 TCB SELF-TAPPIN G SCREW</td> <td>2</td> <td>PZ</td> </tr> <tr> <td>VM1190A2</td> <td>CT BT RIGHT DOOR SPRING LATCH</td> <td>1</td> <td>PZ</td> </tr> <tr> <td>VM1192A1</td> <td>CT BT DOOR SPRING LATCH BACK COVER</td> <td>1</td> <td>PZ</td> </tr> <tr> <td>VM1224A0</td> <td>65MY 220MM 2 COLOURS SHRINK TUBE</td> <td>0.200</td> <td>M</td> </tr> <tr> <td>VM1460A0</td> <td>XBC/XVC RIGHT DOOR LATCH CAP</td> <td>1</td> <td>PZ</td> </tr> </tbody> </table>	Code	Description	Qty	UOM	VI0239A1	SELF-TAPPIN G SCREW 4.2X25 TCB+ INOX	2	PZ	VI1220A1	4.2X12 TCB SELF-TAPPIN G SCREW	2	PZ	VM1190A2	CT BT RIGHT DOOR SPRING LATCH	1	PZ	VM1192A1	CT BT DOOR SPRING LATCH BACK COVER	1	PZ	VM1224A0	65MY 220MM 2 COLOURS SHRINK TUBE	0.200	M	VM1460A0	XBC/XVC RIGHT DOOR LATCH CAP	1	PZ			
Code	Description	Qty	UOM																														
VI0239A1	SELF-TAPPIN G SCREW 4.2X25 TCB+ INOX	2	PZ																														
VI1220A1	4.2X12 TCB SELF-TAPPIN G SCREW	2	PZ																														
VM1190A2	CT BT RIGHT DOOR SPRING LATCH	1	PZ																														
VM1192A1	CT BT DOOR SPRING LATCH BACK COVER	1	PZ																														
VM1224A0	65MY 220MM 2 COLOURS SHRINK TUBE	0.200	M																														
VM1460A0	XBC/XVC RIGHT DOOR LATCH CAP	1	PZ																														
VI1074A	4X16 SCREW FOR PLASTIC		VI1074A0	4X16 SCREW FOR PLASTIC																													

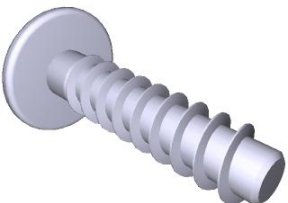
COMPONENT			SPARE PART																														
Code	Description	Image	Code	Description	Components list																												
VM1630A	INTERNAL GLASS PUSHING CAP		KVM1630A	CAP FOR INTERNAL GLASS 10 PCS KIT	<table border="1"> <thead> <tr> <th>Code</th> <th>Description</th> <th>Qty</th> <th>UOM</th> </tr> </thead> <tbody> <tr> <td>VM1224A0</td> <td>65MY 220MM 2 COLOURS SHRINK TUBE</td> <td>0.200</td> <td>M</td> </tr> <tr> <td>VM1630A0</td> <td>INTERNAL GLASS PUSHING CAP</td> <td>10</td> <td>PZ</td> </tr> <tr> <td>VM1630A1</td> <td>INTERNAL GLASS PUSHING CAP</td> <td>10</td> <td>PZ</td> </tr> </tbody> </table>	Code	Description	Qty	UOM	VM1224A0	65MY 220MM 2 COLOURS SHRINK TUBE	0.200	M	VM1630A0	INTERNAL GLASS PUSHING CAP	10	PZ	VM1630A1	INTERNAL GLASS PUSHING CAP	10	PZ												
Code	Description	Qty	UOM																														
VM1224A0	65MY 220MM 2 COLOURS SHRINK TUBE	0.200	M																														
VM1630A0	INTERNAL GLASS PUSHING CAP	10	PZ																														
VM1630A1	INTERNAL GLASS PUSHING CAP	10	PZ																														
VM2280B	HANDLE LATCH PLATE COVER		KVM2280B	VM2280B -M HANDLE LATCH PLATE COVER KIT	<table border="1"> <thead> <tr> <th>Code</th> <th>Description</th> <th>Qty</th> <th>UOM</th> </tr> </thead> <tbody> <tr> <td>V11074A0</td> <td>4X16 SCREW FOR PLASTIC</td> <td>2</td> <td>PZ</td> </tr> <tr> <td>VM1224A0</td> <td>65MY 220MM 2 COLOURS SHRINK TUBE</td> <td>0.200</td> <td>M</td> </tr> <tr> <td>VM1630A1</td> <td>INTERNAL GLASS PUSHING CAP</td> <td>2</td> <td>PZ</td> </tr> <tr> <td>VM2280B0</td> <td>HANDLE LATCH PLATE COVER</td> <td>1</td> <td>PZ</td> </tr> </tbody> </table>	Code	Description	Qty	UOM	V11074A0	4X16 SCREW FOR PLASTIC	2	PZ	VM1224A0	65MY 220MM 2 COLOURS SHRINK TUBE	0.200	M	VM1630A1	INTERNAL GLASS PUSHING CAP	2	PZ	VM2280B0	HANDLE LATCH PLATE COVER	1	PZ								
Code	Description	Qty	UOM																														
V11074A0	4X16 SCREW FOR PLASTIC	2	PZ																														
VM1224A0	65MY 220MM 2 COLOURS SHRINK TUBE	0.200	M																														
VM1630A1	INTERNAL GLASS PUSHING CAP	2	PZ																														
VM2280B0	HANDLE LATCH PLATE COVER	1	PZ																														
VM2281A	DOOR LATCH HOLES COVER		KVM2281A	HOLE PLATE COVER KIT	<table border="1"> <thead> <tr> <th>Code</th> <th>Description</th> <th>Qty</th> <th>UOM</th> </tr> </thead> <tbody> <tr> <td>VM1224A0</td> <td>65MY 220MM 2 COLOURS SHRINK TUBE</td> <td>0.200</td> <td>M</td> </tr> <tr> <td>VM2281A0</td> <td>DOOR LATCH HOLES COVER</td> <td>1</td> <td>PZ</td> </tr> </tbody> </table>	Code	Description	Qty	UOM	VM1224A0	65MY 220MM 2 COLOURS SHRINK TUBE	0.200	M	VM2281A0	DOOR LATCH HOLES COVER	1	PZ																
Code	Description	Qty	UOM																														
VM1224A0	65MY 220MM 2 COLOURS SHRINK TUBE	0.200	M																														
VM2281A0	DOOR LATCH HOLES COVER	1	PZ																														
VM1192A	CT BT DOOR SPRING LATCH BACK COVER		KVM1191A	CHEFTOP/BAKERTO P DOOR LEFT LATCH KIT	<table border="1"> <thead> <tr> <th>Code</th> <th>Description</th> <th>Qty</th> <th>UOM</th> </tr> </thead> <tbody> <tr> <td>VI0239A1</td> <td>SELF-TAPPIN G SCREW 4.2X25 TCB+ INOX</td> <td>2</td> <td>PZ</td> </tr> <tr> <td>V11220A1</td> <td>4.2X12 TCB SELF-TAPPIN G SCREW</td> <td>2</td> <td>PZ</td> </tr> <tr> <td>VM1191A2</td> <td>CT BT LEFT DOOR SPRING LATCH</td> <td>1</td> <td>PZ</td> </tr> <tr> <td>VM1192A1</td> <td>CT BT DOOR SPRING LATCH BACK COVER</td> <td>1</td> <td>PZ</td> </tr> <tr> <td>VM1224A0</td> <td>65MY 220MM 2 COLOURS SHRINK TUBE</td> <td>0.200</td> <td>M</td> </tr> <tr> <td>VM1460A0</td> <td>XBC/XVC RIGHT DOOR LATCH CAP</td> <td>1</td> <td>PZ</td> </tr> </tbody> </table>	Code	Description	Qty	UOM	VI0239A1	SELF-TAPPIN G SCREW 4.2X25 TCB+ INOX	2	PZ	V11220A1	4.2X12 TCB SELF-TAPPIN G SCREW	2	PZ	VM1191A2	CT BT LEFT DOOR SPRING LATCH	1	PZ	VM1192A1	CT BT DOOR SPRING LATCH BACK COVER	1	PZ	VM1224A0	65MY 220MM 2 COLOURS SHRINK TUBE	0.200	M	VM1460A0	XBC/XVC RIGHT DOOR LATCH CAP	1	PZ
Code	Description	Qty	UOM																														
VI0239A1	SELF-TAPPIN G SCREW 4.2X25 TCB+ INOX	2	PZ																														
V11220A1	4.2X12 TCB SELF-TAPPIN G SCREW	2	PZ																														
VM1191A2	CT BT LEFT DOOR SPRING LATCH	1	PZ																														
VM1192A1	CT BT DOOR SPRING LATCH BACK COVER	1	PZ																														
VM1224A0	65MY 220MM 2 COLOURS SHRINK TUBE	0.200	M																														
VM1460A0	XBC/XVC RIGHT DOOR LATCH CAP	1	PZ																														

COMPONENT			SPARE PART																														
Code	Description	Image	Code	Description	Components list																												
VM1192A	CT BT DOOR SPRING LATCH BACK COVER		KVM1190A	CHEFTOP/BAKERTO P DOOR RIGHT LATCH KIT	<table border="1"> <thead> <tr> <th>Code</th> <th>Description</th> <th>Qty</th> <th>UOM</th> </tr> </thead> <tbody> <tr> <td>VI0239A1</td> <td>SELF-TAPPIN G SCREW 4.2X25 TCB+ INOX</td> <td>2</td> <td>PZ</td> </tr> <tr> <td>VI1220A1</td> <td>4,2X12 TCB SELF-TAPPIN G SCREW</td> <td>2</td> <td>PZ</td> </tr> <tr> <td>VM1190A2</td> <td>CT BT RIGHT DOOR SPRING LATCH</td> <td>1</td> <td>PZ</td> </tr> <tr> <td>VM1192A1</td> <td>CT BT DOOR SPRING LATCH BACK COVER</td> <td>1</td> <td>PZ</td> </tr> <tr> <td>VM1224A0</td> <td>65MY 220MM 2 COLOURS SHRINK TUBE</td> <td>0.200</td> <td>M</td> </tr> <tr> <td>VM1460A0</td> <td>XBC/XVC RIGHT DOOR LATCH CAP</td> <td>1</td> <td>PZ</td> </tr> </tbody> </table>	Code	Description	Qty	UOM	VI0239A1	SELF-TAPPIN G SCREW 4.2X25 TCB+ INOX	2	PZ	VI1220A1	4,2X12 TCB SELF-TAPPIN G SCREW	2	PZ	VM1190A2	CT BT RIGHT DOOR SPRING LATCH	1	PZ	VM1192A1	CT BT DOOR SPRING LATCH BACK COVER	1	PZ	VM1224A0	65MY 220MM 2 COLOURS SHRINK TUBE	0.200	M	VM1460A0	XBC/XVC RIGHT DOOR LATCH CAP	1	PZ
					Code	Description	Qty	UOM																									
					VI0239A1	SELF-TAPPIN G SCREW 4.2X25 TCB+ INOX	2	PZ																									
					VI1220A1	4,2X12 TCB SELF-TAPPIN G SCREW	2	PZ																									
					VM1190A2	CT BT RIGHT DOOR SPRING LATCH	1	PZ																									
					VM1192A1	CT BT DOOR SPRING LATCH BACK COVER	1	PZ																									
					VM1224A0	65MY 220MM 2 COLOURS SHRINK TUBE	0.200	M																									
VM1460A0	XBC/XVC RIGHT DOOR LATCH CAP	1	PZ																														
VM1191A	CT BT LEFT DOOR SPRING LATCH		KVM1191A	CHEFTOP/BAKERTO P DOOR LEFT LATCH KIT	<table border="1"> <thead> <tr> <th>Code</th> <th>Description</th> <th>Qty</th> <th>UOM</th> </tr> </thead> <tbody> <tr> <td>VI0239A1</td> <td>SELF-TAPPIN G SCREW 4.2X25 TCB+ INOX</td> <td>2</td> <td>PZ</td> </tr> <tr> <td>VI1220A1</td> <td>4,2X12 TCB SELF-TAPPIN G SCREW</td> <td>2</td> <td>PZ</td> </tr> <tr> <td>VM1191A2</td> <td>CT BT LEFT DOOR SPRING LATCH</td> <td>1</td> <td>PZ</td> </tr> <tr> <td>VM1192A1</td> <td>CT BT DOOR SPRING LATCH BACK COVER</td> <td>1</td> <td>PZ</td> </tr> <tr> <td>VM1224A0</td> <td>65MY 220MM 2 COLOURS SHRINK TUBE</td> <td>0.200</td> <td>M</td> </tr> <tr> <td>VM1460A0</td> <td>XBC/XVC RIGHT DOOR LATCH CAP</td> <td>1</td> <td>PZ</td> </tr> </tbody> </table>	Code	Description	Qty	UOM	VI0239A1	SELF-TAPPIN G SCREW 4.2X25 TCB+ INOX	2	PZ	VI1220A1	4,2X12 TCB SELF-TAPPIN G SCREW	2	PZ	VM1191A2	CT BT LEFT DOOR SPRING LATCH	1	PZ	VM1192A1	CT BT DOOR SPRING LATCH BACK COVER	1	PZ	VM1224A0	65MY 220MM 2 COLOURS SHRINK TUBE	0.200	M	VM1460A0	XBC/XVC RIGHT DOOR LATCH CAP	1	PZ
					Code	Description	Qty	UOM																									
					VI0239A1	SELF-TAPPIN G SCREW 4.2X25 TCB+ INOX	2	PZ																									
					VI1220A1	4,2X12 TCB SELF-TAPPIN G SCREW	2	PZ																									
					VM1191A2	CT BT LEFT DOOR SPRING LATCH	1	PZ																									
					VM1192A1	CT BT DOOR SPRING LATCH BACK COVER	1	PZ																									
					VM1224A0	65MY 220MM 2 COLOURS SHRINK TUBE	0.200	M																									
VM1460A0	XBC/XVC RIGHT DOOR LATCH CAP	1	PZ																														
VI1074A	4X16 SCREW FOR PLASTIC		VI1074A0	4X16 SCREW FOR PLASTIC																													



COMPONENT			SPARE PART																		
Code	Description	Image	Code	Description	Components list																
EL1430B	BARBED 5+21 STEAM SOLENOID VALVE		KEL1430B	5+21 BARBED 6 DUAL SOLENOID VALVE KIT	<table border="1"> <thead> <tr> <th>Code</th> <th>Description</th> <th>Qty</th> <th>UOM</th> </tr> </thead> <tbody> <tr> <td>EL1430B0</td> <td>BARBED 5+21 STEAM SOLENOID VALVE</td> <td>1</td> <td>PZ</td> </tr> <tr> <td>RC1018A0</td> <td>ZINC PLATED D12 ELASTIC CLAMP</td> <td>2</td> <td>PZ</td> </tr> <tr> <td>VM1224A0</td> <td>65MY 220MM 2 COLOURS SHRINK TUBE</td> <td>0.250</td> <td>M</td> </tr> </tbody> </table>	Code	Description	Qty	UOM	EL1430B0	BARBED 5+21 STEAM SOLENOID VALVE	1	PZ	RC1018A0	ZINC PLATED D12 ELASTIC CLAMP	2	PZ	VM1224A0	65MY 220MM 2 COLOURS SHRINK TUBE	0.250	M
Code	Description	Qty	UOM																		
EL1430B0	BARBED 5+21 STEAM SOLENOID VALVE	1	PZ																		
RC1018A0	ZINC PLATED D12 ELASTIC CLAMP	2	PZ																		
VM1224A0	65MY 220MM 2 COLOURS SHRINK TUBE	0.250	M																		
RC1414A	D12 HOSE CLAMP		RC1414A0	D12 HOSE CLAMP																	
0H2202A	ONE WASHING WITH STEAM VALVE SUPPORT		0H2202A1	ONE WASHING WITH STEAM VALVE SUPPORT																	

ASM2922B/0.D02 - Door

FRONT



ASM2922B/0.D02 - Door

REAR





COMPONENT			SPARE PART																																																										
Code	Description	Image	Code	Description	Components list																																																								
VT1277A	XEVC-0711-E EXTERNAL GLASS		KVT1277A	0711 EXTERNAL GLASS KIT	<table border="1"> <thead> <tr> <th>Code</th> <th>Description</th> <th>Qty</th> <th>UOM</th> </tr> </thead> <tbody> <tr> <td>0B1167A0</td> <td>EXT. GLASS SUPPORT PROFILE</td> <td>2</td> <td>PZ</td> </tr> <tr> <td>IP1508A1</td> <td>POLYSTYREN E U SHAPED PROFILE 2000X60X60</td> <td>1</td> <td>M</td> </tr> <tr> <td>MOV0020A0</td> <td>HOOD RING GASKET GN1110A2</td> <td>0.100</td> <td>PZ</td> </tr> <tr> <td>SL1155A1</td> <td>LOCTITE BICOMPONEN T SILICON</td> <td>150</td> <td>ML</td> </tr> <tr> <td>SL1156A0</td> <td>NOZZLE FOR SILICON GUN</td> <td>2</td> <td>PZ</td> </tr> <tr> <td>VM1059A1</td> <td>HEAT SHRINK FILM H800</td> <td>1.500</td> <td>M</td> </tr> <tr> <td>VT1277A0</td> <td>XEVC-0711-E EXTERNAL GLASS</td> <td>1</td> <td>PZ</td> </tr> <tr> <td>VT1277A0</td> <td>XEVC-0711-E EXTERNAL GLASS</td> <td>1</td> <td>PZ</td> </tr> </tbody> </table>	Code	Description	Qty	UOM	0B1167A0	EXT. GLASS SUPPORT PROFILE	2	PZ	IP1508A1	POLYSTYREN E U SHAPED PROFILE 2000X60X60	1	M	MOV0020A0	HOOD RING GASKET GN1110A2	0.100	PZ	SL1155A1	LOCTITE BICOMPONEN T SILICON	150	ML	SL1156A0	NOZZLE FOR SILICON GUN	2	PZ	VM1059A1	HEAT SHRINK FILM H800	1.500	M	VT1277A0	XEVC-0711-E EXTERNAL GLASS	1	PZ	VT1277A0	XEVC-0711-E EXTERNAL GLASS	1	PZ																				
			Code	Description	Qty	UOM																																																							
0B1167A0	EXT. GLASS SUPPORT PROFILE	2	PZ																																																										
IP1508A1	POLYSTYREN E U SHAPED PROFILE 2000X60X60	1	M																																																										
MOV0020A0	HOOD RING GASKET GN1110A2	0.100	PZ																																																										
SL1155A1	LOCTITE BICOMPONEN T SILICON	150	ML																																																										
SL1156A0	NOZZLE FOR SILICON GUN	2	PZ																																																										
VM1059A1	HEAT SHRINK FILM H800	1.500	M																																																										
VT1277A0	XEVC-0711-E EXTERNAL GLASS	1	PZ																																																										
VT1277A0	XEVC-0711-E EXTERNAL GLASS	1	PZ																																																										
KDR1328A					<table border="1"> <thead> <tr> <th>Code</th> <th>Description</th> <th>Qty</th> <th>UOM</th> </tr> </thead> <tbody> <tr> <td>0B1122B0</td> <td></td> <td>1</td> <td>PZ</td> </tr> <tr> <td>0B1167A0</td> <td>EXT. GLASS SUPPORT PROFILE</td> <td>2</td> <td>PZ</td> </tr> <tr> <td>0B1198B0</td> <td></td> <td>1</td> <td>PZ</td> </tr> <tr> <td>0B1198B1</td> <td></td> <td>1</td> <td>PZ</td> </tr> <tr> <td>0B1199A2</td> <td>0711 LEFT - DOOR RIGHT INT COLUMN</td> <td>1</td> <td>PZ</td> </tr> <tr> <td>0B1200A2</td> <td>0711 LEFT - DOOR LEFT INT COLUMN</td> <td>1</td> <td>PZ</td> </tr> <tr> <td>0B1207A0</td> <td>0711 LEFT - DOOR RIGHT EXT COLUMN</td> <td>1</td> <td>PZ</td> </tr> <tr> <td>0B1216B0</td> <td></td> <td>1</td> <td>PZ</td> </tr> <tr> <td>0B1217A1</td> <td>MM DOUBLE GLASS DOOR INT UPPER BEAM 750</td> <td>1</td> <td>PZ</td> </tr> <tr> <td>0H2892A0</td> <td></td> <td>1</td> <td>PZ</td> </tr> <tr> <td>0H2893A0</td> <td></td> <td>1</td> <td>PZ</td> </tr> <tr> <td>0H7321A0</td> <td>MM STAINLESS STEEL HANDLE COVE</td> <td>1</td> <td>PZ</td> </tr> <tr> <td>CE1052A1</td> <td>CABLE CONNECTION CONTROL - USB MM 750M</td> <td>1</td> <td>PZ</td> </tr> </tbody> </table>	Code	Description	Qty	UOM	0B1122B0		1	PZ	0B1167A0	EXT. GLASS SUPPORT PROFILE	2	PZ	0B1198B0		1	PZ	0B1198B1		1	PZ	0B1199A2	0711 LEFT - DOOR RIGHT INT COLUMN	1	PZ	0B1200A2	0711 LEFT - DOOR LEFT INT COLUMN	1	PZ	0B1207A0	0711 LEFT - DOOR RIGHT EXT COLUMN	1	PZ	0B1216B0		1	PZ	0B1217A1	MM DOUBLE GLASS DOOR INT UPPER BEAM 750	1	PZ	0H2892A0		1	PZ	0H2893A0		1	PZ	0H7321A0	MM STAINLESS STEEL HANDLE COVE	1	PZ	CE1052A1	CABLE CONNECTION CONTROL - USB MM 750M	1	PZ
Code	Description	Qty	UOM																																																										
0B1122B0		1	PZ																																																										
0B1167A0	EXT. GLASS SUPPORT PROFILE	2	PZ																																																										
0B1198B0		1	PZ																																																										
0B1198B1		1	PZ																																																										
0B1199A2	0711 LEFT - DOOR RIGHT INT COLUMN	1	PZ																																																										
0B1200A2	0711 LEFT - DOOR LEFT INT COLUMN	1	PZ																																																										
0B1207A0	0711 LEFT - DOOR RIGHT EXT COLUMN	1	PZ																																																										
0B1216B0		1	PZ																																																										
0B1217A1	MM DOUBLE GLASS DOOR INT UPPER BEAM 750	1	PZ																																																										
0H2892A0		1	PZ																																																										
0H2893A0		1	PZ																																																										
0H7321A0	MM STAINLESS STEEL HANDLE COVE	1	PZ																																																										
CE1052A1	CABLE CONNECTION CONTROL - USB MM 750M	1	PZ																																																										



COMPONENT			SPARE PART																																																																						
Code	Description	Image	Code	Description	Components list																																																																				
VT1277A	XEVC-0711-E EXTERNAL GLASS		KDR1328A		<table border="1"> <thead> <tr> <th>Code</th> <th>Description</th> <th>Qty</th> <th>UOM</th> </tr> </thead> <tbody> <tr> <td>CE1053B0</td> <td>MM MICROFIT LED BAR POWER SUPPLY CABL</td> <td>1</td> <td>PZ</td> </tr> <tr> <td>CE1097A0</td> <td>4M SIHF 4 POLES MICROFIT CANBUS</td> <td>1</td> <td>PZ</td> </tr> <tr> <td>CE1285A0</td> <td>EMI ROUND FERRITE MOD.26438015 02</td> <td>1</td> <td>PZ</td> </tr> <tr> <td>GN1525A0</td> <td>O-RING INT DIAM 9,5 THK 1 NBR 70</td> <td>2</td> <td>PZ</td> </tr> <tr> <td>IP1508A1</td> <td>POLYSTYREN E U SHAPED PROFILE 2000X60X60</td> <td>2</td> <td>M</td> </tr> <tr> <td>LP1020A0</td> <td>6 SERIES L400 LED LIGHT BAR - E583</td> <td>1</td> <td>PZ</td> </tr> <tr> <td>MG1099A1</td> <td></td> <td>1</td> <td>PZ</td> </tr> <tr> <td>RC1200A0</td> <td>ED=4 WIRE D.=0.5 COMPRESSIO N SPRING</td> <td>8</td> <td>PZ</td> </tr> <tr> <td>SL1155A1</td> <td>LOCTITE BICOMPONEN T SILICON</td> <td>80</td> <td>ML</td> </tr> <tr> <td>SL1170A1</td> <td>S57 BLACK SILICON - 310ML CARTRIDGE</td> <td>37</td> <td>ML</td> </tr> <tr> <td>VE1030A1</td> <td>MAGNET FOR DOOR MICROSWITC H D=22,9MM</td> <td>2</td> <td>PZ</td> </tr> <tr> <td>VI0239A1</td> <td>SELF-TAPPIN G SCREW 4.2X25 TCB+ INOX</td> <td>4</td> <td>PZ</td> </tr> <tr> <td>VI1034A0</td> <td>STAINLESS STEEL WASHER 8.4X16X1</td> <td>1</td> <td>PZ</td> </tr> <tr> <td>VI1074A0</td> <td>4X16 SCREW FOR PLASTIC</td> <td>2</td> <td>PZ</td> </tr> <tr> <td>VI1103A0</td> <td>40X12 TBSP SCREW FOR PLASTIC</td> <td>2</td> <td>PZ</td> </tr> <tr> <td>VI1220A1</td> <td>4,2X12 TCB SELF-TAPPIN G SCREW</td> <td>30</td> <td>PZ</td> </tr> </tbody> </table>	Code	Description	Qty	UOM	CE1053B0	MM MICROFIT LED BAR POWER SUPPLY CABL	1	PZ	CE1097A0	4M SIHF 4 POLES MICROFIT CANBUS	1	PZ	CE1285A0	EMI ROUND FERRITE MOD.26438015 02	1	PZ	GN1525A0	O-RING INT DIAM 9,5 THK 1 NBR 70	2	PZ	IP1508A1	POLYSTYREN E U SHAPED PROFILE 2000X60X60	2	M	LP1020A0	6 SERIES L400 LED LIGHT BAR - E583	1	PZ	MG1099A1		1	PZ	RC1200A0	ED=4 WIRE D.=0.5 COMPRESSIO N SPRING	8	PZ	SL1155A1	LOCTITE BICOMPONEN T SILICON	80	ML	SL1170A1	S57 BLACK SILICON - 310ML CARTRIDGE	37	ML	VE1030A1	MAGNET FOR DOOR MICROSWITC H D=22,9MM	2	PZ	VI0239A1	SELF-TAPPIN G SCREW 4.2X25 TCB+ INOX	4	PZ	VI1034A0	STAINLESS STEEL WASHER 8.4X16X1	1	PZ	VI1074A0	4X16 SCREW FOR PLASTIC	2	PZ	VI1103A0	40X12 TBSP SCREW FOR PLASTIC	2	PZ	VI1220A1	4,2X12 TCB SELF-TAPPIN G SCREW	30	PZ
Code	Description	Qty	UOM																																																																						
CE1053B0	MM MICROFIT LED BAR POWER SUPPLY CABL	1	PZ																																																																						
CE1097A0	4M SIHF 4 POLES MICROFIT CANBUS	1	PZ																																																																						
CE1285A0	EMI ROUND FERRITE MOD.26438015 02	1	PZ																																																																						
GN1525A0	O-RING INT DIAM 9,5 THK 1 NBR 70	2	PZ																																																																						
IP1508A1	POLYSTYREN E U SHAPED PROFILE 2000X60X60	2	M																																																																						
LP1020A0	6 SERIES L400 LED LIGHT BAR - E583	1	PZ																																																																						
MG1099A1		1	PZ																																																																						
RC1200A0	ED=4 WIRE D.=0.5 COMPRESSIO N SPRING	8	PZ																																																																						
SL1155A1	LOCTITE BICOMPONEN T SILICON	80	ML																																																																						
SL1170A1	S57 BLACK SILICON - 310ML CARTRIDGE	37	ML																																																																						
VE1030A1	MAGNET FOR DOOR MICROSWITC H D=22,9MM	2	PZ																																																																						
VI0239A1	SELF-TAPPIN G SCREW 4.2X25 TCB+ INOX	4	PZ																																																																						
VI1034A0	STAINLESS STEEL WASHER 8.4X16X1	1	PZ																																																																						
VI1074A0	4X16 SCREW FOR PLASTIC	2	PZ																																																																						
VI1103A0	40X12 TBSP SCREW FOR PLASTIC	2	PZ																																																																						
VI1220A1	4,2X12 TCB SELF-TAPPIN G SCREW	30	PZ																																																																						



COMPONENT			SPARE PART																																																																														
Code	Description	Image	Code	Description	Components list																																																																												
VT1277A	XEVC-0711-E EXTERNAL GLASS		KDR1328A		<table border="1"> <thead> <tr> <th>Code</th> <th>Description</th> <th>Qty</th> <th>UOM</th> </tr> </thead> <tbody> <tr> <td>VI1565A0</td> <td>WASHER INTD=4.2 EXTD=20 TH=125/10 INO</td> <td>1</td> <td>PZ</td> </tr> <tr> <td>VI1930A1</td> <td>ST. STEEL 5X20 CHIP SCREW</td> <td>16</td> <td>PZ</td> </tr> <tr> <td>VI1996A0</td> <td>M5X35 SCREW</td> <td>13</td> <td>PZ</td> </tr> <tr> <td>VM1059A1</td> <td>HEAT SHRINK FILM H800</td> <td>1</td> <td>M</td> </tr> <tr> <td>VM1182B1</td> <td>E. S. CT BT HANDLE JUNCTION + PIN GUIDE</td> <td>1</td> <td>PZ</td> </tr> <tr> <td>VM1490A0</td> <td>CHEFTOP/BAK ERTOP HANDLE SCREWS COVER</td> <td>4</td> <td>PZ</td> </tr> <tr> <td>VM1630A1</td> <td>INTERNAL GLASS PUSHING CAP</td> <td>3</td> <td>PZ</td> </tr> <tr> <td>VM1631A0</td> <td>PLUS INNER GLASS PUSHING CAP</td> <td>3</td> <td>PZ</td> </tr> <tr> <td>VM1695A0</td> <td>HANDLE POSITION PIN</td> <td>4</td> <td>PZ</td> </tr> <tr> <td>VM2245A0</td> <td>HANDLE SHAFT WITH LATCH</td> <td>1</td> <td>PZ</td> </tr> <tr> <td>VM2247B0</td> <td>HANDLE SHAFT COVER VM2245-2246</td> <td>1</td> <td>PZ</td> </tr> <tr> <td>VM2248B0</td> <td>HANDLE WITH LATCH CLOSING KEY</td> <td>1</td> <td>PZ</td> </tr> <tr> <td>VM2267A0</td> <td>INTERNAL GLASS LOCKING SYSTEM SLIDER</td> <td>2</td> <td>PZ</td> </tr> <tr> <td>VM2268A0</td> <td>DOOR MAGNET COVER</td> <td>2</td> <td>PZ</td> </tr> <tr> <td>VM2269B0</td> <td>INNER GLASS FIXING CAP</td> <td>2</td> <td>PZ</td> </tr> <tr> <td>VM2274A0</td> <td>GROOVED BUSHING</td> <td>1</td> <td>PZ</td> </tr> <tr> <td>VM2275A0</td> <td>SMOOTH BUSHING</td> <td>1</td> <td>PZ</td> </tr> <tr> <td>VM2284B0</td> <td>750 SERIES DRIP PROFILE KIT</td> <td>1</td> <td>PZ</td> </tr> </tbody> </table>	Code	Description	Qty	UOM	VI1565A0	WASHER INTD=4.2 EXTD=20 TH=125/10 INO	1	PZ	VI1930A1	ST. STEEL 5X20 CHIP SCREW	16	PZ	VI1996A0	M5X35 SCREW	13	PZ	VM1059A1	HEAT SHRINK FILM H800	1	M	VM1182B1	E. S. CT BT HANDLE JUNCTION + PIN GUIDE	1	PZ	VM1490A0	CHEFTOP/BAK ERTOP HANDLE SCREWS COVER	4	PZ	VM1630A1	INTERNAL GLASS PUSHING CAP	3	PZ	VM1631A0	PLUS INNER GLASS PUSHING CAP	3	PZ	VM1695A0	HANDLE POSITION PIN	4	PZ	VM2245A0	HANDLE SHAFT WITH LATCH	1	PZ	VM2247B0	HANDLE SHAFT COVER VM2245-2246	1	PZ	VM2248B0	HANDLE WITH LATCH CLOSING KEY	1	PZ	VM2267A0	INTERNAL GLASS LOCKING SYSTEM SLIDER	2	PZ	VM2268A0	DOOR MAGNET COVER	2	PZ	VM2269B0	INNER GLASS FIXING CAP	2	PZ	VM2274A0	GROOVED BUSHING	1	PZ	VM2275A0	SMOOTH BUSHING	1	PZ	VM2284B0	750 SERIES DRIP PROFILE KIT	1	PZ
Code	Description	Qty	UOM																																																																														
VI1565A0	WASHER INTD=4.2 EXTD=20 TH=125/10 INO	1	PZ																																																																														
VI1930A1	ST. STEEL 5X20 CHIP SCREW	16	PZ																																																																														
VI1996A0	M5X35 SCREW	13	PZ																																																																														
VM1059A1	HEAT SHRINK FILM H800	1	M																																																																														
VM1182B1	E. S. CT BT HANDLE JUNCTION + PIN GUIDE	1	PZ																																																																														
VM1490A0	CHEFTOP/BAK ERTOP HANDLE SCREWS COVER	4	PZ																																																																														
VM1630A1	INTERNAL GLASS PUSHING CAP	3	PZ																																																																														
VM1631A0	PLUS INNER GLASS PUSHING CAP	3	PZ																																																																														
VM1695A0	HANDLE POSITION PIN	4	PZ																																																																														
VM2245A0	HANDLE SHAFT WITH LATCH	1	PZ																																																																														
VM2247B0	HANDLE SHAFT COVER VM2245-2246	1	PZ																																																																														
VM2248B0	HANDLE WITH LATCH CLOSING KEY	1	PZ																																																																														
VM2267A0	INTERNAL GLASS LOCKING SYSTEM SLIDER	2	PZ																																																																														
VM2268A0	DOOR MAGNET COVER	2	PZ																																																																														
VM2269B0	INNER GLASS FIXING CAP	2	PZ																																																																														
VM2274A0	GROOVED BUSHING	1	PZ																																																																														
VM2275A0	SMOOTH BUSHING	1	PZ																																																																														
VM2284B0	750 SERIES DRIP PROFILE KIT	1	PZ																																																																														



COMPONENT			SPARE PART																																																																											
Code	Description	Image	Code	Description	Components list																																																																									
VT1277A	XEVC-0711-E EXTERNAL GLASS		KDR1328A		<table border="1"> <thead> <tr> <th>Code</th> <th>Description</th> <th>Qty</th> <th>UOM</th> </tr> </thead> <tbody> <tr> <td>VM2295A1</td> <td>MIND.MAPS TOUCH CONTROL STYLUS KIT</td> <td>1</td> <td>PZ</td> </tr> <tr> <td>VM2305A0</td> <td>6 SERIES DOOR CAP FIXING PAWL</td> <td>14</td> <td>PZ</td> </tr> <tr> <td>VM2313A0</td> <td>TUBE DX DISCHARGE DRIP MM</td> <td>1</td> <td>PZ</td> </tr> <tr> <td>VM2314A0</td> <td>6 S. DRIP PROFILE CAP</td> <td>1</td> <td>PZ</td> </tr> <tr> <td>VM2315B0</td> <td>S6 INTERNAL GLASS SUPPORT</td> <td>3</td> <td>PZ</td> </tr> <tr> <td>VM2383B0</td> <td>S6 LEFT OVENS UPPER RIGHT CAP</td> <td>1</td> <td>PZ</td> </tr> <tr> <td>VM2384B0</td> <td></td> <td>1</td> <td>PZ</td> </tr> <tr> <td>VM2385B0</td> <td>S6 LEFT OVENS UPPER LEFT CAP</td> <td>1</td> <td>PZ</td> </tr> <tr> <td>VM2386B0</td> <td>MM -M LEFT DOOR LEFT LOWER CAP KI</td> <td>1</td> <td>PZ</td> </tr> <tr> <td>VM2410A0</td> <td>PLATE TO STOP EXTRUDED LED BAR</td> <td>1</td> <td>PZ</td> </tr> <tr> <td>VM2505B0</td> <td>MM PLUS INTERNAL GLASS SUPPORT</td> <td>3</td> <td>PZ</td> </tr> <tr> <td>VM2518A0</td> <td>BOARD COOLING FAN SUPPORT</td> <td>1</td> <td>PZ</td> </tr> <tr> <td>VN1179A1</td> <td>CONTROL BOARD 40X40X20MM 12V COOLING FAN</td> <td>1</td> <td>PZ</td> </tr> <tr> <td>VP1076A0</td> <td>PLUS ONE ZERO HANDLE PIN</td> <td>1</td> <td>PZ</td> </tr> <tr> <td>VP1080A0</td> <td>UPPER HINGE CAP FOR LOWER INNER GLASS</td> <td>1</td> <td>PZ</td> </tr> <tr> <td>VP1081A0</td> <td>UPPER HINGE CAP FOR UPPER INNER GLASS</td> <td>1</td> <td>PZ</td> </tr> <tr> <td>VT1277A0</td> <td>XEVC-0711-E EXTERNAL GLASS</td> <td></td> <td>1</td> <td>PZ</td> </tr> </tbody> </table>	Code	Description	Qty	UOM	VM2295A1	MIND.MAPS TOUCH CONTROL STYLUS KIT	1	PZ	VM2305A0	6 SERIES DOOR CAP FIXING PAWL	14	PZ	VM2313A0	TUBE DX DISCHARGE DRIP MM	1	PZ	VM2314A0	6 S. DRIP PROFILE CAP	1	PZ	VM2315B0	S6 INTERNAL GLASS SUPPORT	3	PZ	VM2383B0	S6 LEFT OVENS UPPER RIGHT CAP	1	PZ	VM2384B0		1	PZ	VM2385B0	S6 LEFT OVENS UPPER LEFT CAP	1	PZ	VM2386B0	MM -M LEFT DOOR LEFT LOWER CAP KI	1	PZ	VM2410A0	PLATE TO STOP EXTRUDED LED BAR	1	PZ	VM2505B0	MM PLUS INTERNAL GLASS SUPPORT	3	PZ	VM2518A0	BOARD COOLING FAN SUPPORT	1	PZ	VN1179A1	CONTROL BOARD 40X40X20MM 12V COOLING FAN	1	PZ	VP1076A0	PLUS ONE ZERO HANDLE PIN	1	PZ	VP1080A0	UPPER HINGE CAP FOR LOWER INNER GLASS	1	PZ	VP1081A0	UPPER HINGE CAP FOR UPPER INNER GLASS	1	PZ	VT1277A0	XEVC-0711-E EXTERNAL GLASS		1	PZ
Code	Description	Qty	UOM																																																																											
VM2295A1	MIND.MAPS TOUCH CONTROL STYLUS KIT	1	PZ																																																																											
VM2305A0	6 SERIES DOOR CAP FIXING PAWL	14	PZ																																																																											
VM2313A0	TUBE DX DISCHARGE DRIP MM	1	PZ																																																																											
VM2314A0	6 S. DRIP PROFILE CAP	1	PZ																																																																											
VM2315B0	S6 INTERNAL GLASS SUPPORT	3	PZ																																																																											
VM2383B0	S6 LEFT OVENS UPPER RIGHT CAP	1	PZ																																																																											
VM2384B0		1	PZ																																																																											
VM2385B0	S6 LEFT OVENS UPPER LEFT CAP	1	PZ																																																																											
VM2386B0	MM -M LEFT DOOR LEFT LOWER CAP KI	1	PZ																																																																											
VM2410A0	PLATE TO STOP EXTRUDED LED BAR	1	PZ																																																																											
VM2505B0	MM PLUS INTERNAL GLASS SUPPORT	3	PZ																																																																											
VM2518A0	BOARD COOLING FAN SUPPORT	1	PZ																																																																											
VN1179A1	CONTROL BOARD 40X40X20MM 12V COOLING FAN	1	PZ																																																																											
VP1076A0	PLUS ONE ZERO HANDLE PIN	1	PZ																																																																											
VP1080A0	UPPER HINGE CAP FOR LOWER INNER GLASS	1	PZ																																																																											
VP1081A0	UPPER HINGE CAP FOR UPPER INNER GLASS	1	PZ																																																																											
VT1277A0	XEVC-0711-E EXTERNAL GLASS		1	PZ																																																																										



COMPONENT			SPARE PART																																																																																						
Code	Description	Image	Code	Description	Components list																																																																																				
VT1277A	XEVC-0711-E EXTERNAL GLASS		KDR1327A		<table border="1"> <thead> <tr> <th>Code</th> <th>Description</th> <th>Qty</th> <th>UOM</th> </tr> </thead> <tbody> <tr> <td>0B1111A0</td> <td>XEVC-0711-E LEFT EXT DOOR COLUMN</td> <td>1</td> <td>PZ</td> </tr> <tr> <td>0B1112A2</td> <td>0711 RIGHT - DOOR LEFT INT COLUMN</td> <td>1</td> <td>PZ</td> </tr> <tr> <td>0B1113B0</td> <td></td> <td>1</td> <td>PZ</td> </tr> <tr> <td>0B1113B1</td> <td></td> <td>1</td> <td>PZ</td> </tr> <tr> <td>0B1114A2</td> <td>0711 RIGHT - DOOR RIGHT INT COLUMN</td> <td>1</td> <td>PZ</td> </tr> <tr> <td>0B1122B0</td> <td></td> <td>1</td> <td>PZ</td> </tr> <tr> <td>0B1167A0</td> <td>EXT. GLASS SUPPORT PROFILE</td> <td>2</td> <td>PZ</td> </tr> <tr> <td>0B1216B0</td> <td></td> <td>1</td> <td>PZ</td> </tr> <tr> <td>0B1217A1</td> <td>MM DOUBLE GLASS DOOR INT UPPER BEAM 750</td> <td>1</td> <td>PZ</td> </tr> <tr> <td>0H2892A0</td> <td></td> <td>1</td> <td>PZ</td> </tr> <tr> <td>0H2893A0</td> <td></td> <td>1</td> <td>PZ</td> </tr> <tr> <td>0H7321A0</td> <td>MM STAINLESS STEEL HANDLE COVE</td> <td>1</td> <td>PZ</td> </tr> <tr> <td>CE1052A1</td> <td>CABLE CONNECTION CONTROL - USB MM 750M</td> <td>1</td> <td>PZ</td> </tr> <tr> <td>CE1053B0</td> <td>MM MICROFIT LED BAR POWER SUPPLY CABL</td> <td>1</td> <td>PZ</td> </tr> <tr> <td>CE1097A0</td> <td>4M SIHF 4 POLES MICROFIT CANBUS</td> <td>1</td> <td>PZ</td> </tr> <tr> <td>CE1285A0</td> <td>EMI ROUND FERRITE MOD.26438015 02</td> <td>1</td> <td>PZ</td> </tr> <tr> <td>GN1525A0</td> <td>O-RING INT DIAM 9,5 THK 1 NBR 70</td> <td>1</td> <td>PZ</td> </tr> <tr> <td>IP1508A1</td> <td>POLYSTYREN E U SHAPED PROFILE 2000X60X60</td> <td>2</td> <td>M</td> </tr> <tr> <td>LP1020A0</td> <td>6 SERIES L400 LED LIGHT BAR - E583</td> <td>1</td> <td>PZ</td> </tr> <tr> <td>MG1099A1</td> <td></td> <td>1</td> <td>PZ</td> </tr> </tbody> </table>	Code	Description	Qty	UOM	0B1111A0	XEVC-0711-E LEFT EXT DOOR COLUMN	1	PZ	0B1112A2	0711 RIGHT - DOOR LEFT INT COLUMN	1	PZ	0B1113B0		1	PZ	0B1113B1		1	PZ	0B1114A2	0711 RIGHT - DOOR RIGHT INT COLUMN	1	PZ	0B1122B0		1	PZ	0B1167A0	EXT. GLASS SUPPORT PROFILE	2	PZ	0B1216B0		1	PZ	0B1217A1	MM DOUBLE GLASS DOOR INT UPPER BEAM 750	1	PZ	0H2892A0		1	PZ	0H2893A0		1	PZ	0H7321A0	MM STAINLESS STEEL HANDLE COVE	1	PZ	CE1052A1	CABLE CONNECTION CONTROL - USB MM 750M	1	PZ	CE1053B0	MM MICROFIT LED BAR POWER SUPPLY CABL	1	PZ	CE1097A0	4M SIHF 4 POLES MICROFIT CANBUS	1	PZ	CE1285A0	EMI ROUND FERRITE MOD.26438015 02	1	PZ	GN1525A0	O-RING INT DIAM 9,5 THK 1 NBR 70	1	PZ	IP1508A1	POLYSTYREN E U SHAPED PROFILE 2000X60X60	2	M	LP1020A0	6 SERIES L400 LED LIGHT BAR - E583	1	PZ	MG1099A1		1	PZ
Code	Description	Qty	UOM																																																																																						
0B1111A0	XEVC-0711-E LEFT EXT DOOR COLUMN	1	PZ																																																																																						
0B1112A2	0711 RIGHT - DOOR LEFT INT COLUMN	1	PZ																																																																																						
0B1113B0		1	PZ																																																																																						
0B1113B1		1	PZ																																																																																						
0B1114A2	0711 RIGHT - DOOR RIGHT INT COLUMN	1	PZ																																																																																						
0B1122B0		1	PZ																																																																																						
0B1167A0	EXT. GLASS SUPPORT PROFILE	2	PZ																																																																																						
0B1216B0		1	PZ																																																																																						
0B1217A1	MM DOUBLE GLASS DOOR INT UPPER BEAM 750	1	PZ																																																																																						
0H2892A0		1	PZ																																																																																						
0H2893A0		1	PZ																																																																																						
0H7321A0	MM STAINLESS STEEL HANDLE COVE	1	PZ																																																																																						
CE1052A1	CABLE CONNECTION CONTROL - USB MM 750M	1	PZ																																																																																						
CE1053B0	MM MICROFIT LED BAR POWER SUPPLY CABL	1	PZ																																																																																						
CE1097A0	4M SIHF 4 POLES MICROFIT CANBUS	1	PZ																																																																																						
CE1285A0	EMI ROUND FERRITE MOD.26438015 02	1	PZ																																																																																						
GN1525A0	O-RING INT DIAM 9,5 THK 1 NBR 70	1	PZ																																																																																						
IP1508A1	POLYSTYREN E U SHAPED PROFILE 2000X60X60	2	M																																																																																						
LP1020A0	6 SERIES L400 LED LIGHT BAR - E583	1	PZ																																																																																						
MG1099A1		1	PZ																																																																																						



COMPONENT			SPARE PART																																																																						
Code	Description	Image	Code	Description	Components list																																																																				
VT1277A	XEVC-0711-E EXTERNAL GLASS		KDR1327A		<table border="1"> <thead> <tr> <th>Code</th> <th>Description</th> <th>Qty</th> <th>UOM</th> </tr> </thead> <tbody> <tr> <td>RC1200A0</td> <td>ED=4 WIRE D.=0.5 COMPRESSIO N SPRING</td> <td>8</td> <td>PZ</td> </tr> <tr> <td>SL1155A1</td> <td>LOCTITE BICOMPONEN T SILICON</td> <td>80</td> <td>ML</td> </tr> <tr> <td>SL1170A1</td> <td>S57 BLACK SILICON - 310ML CARTRIDGE</td> <td>37</td> <td>ML</td> </tr> <tr> <td>VE1030A1</td> <td>MAGNET FOR DOOR MICROSWITC H D=22,9MM</td> <td>2</td> <td>PZ</td> </tr> <tr> <td>VI0239A1</td> <td>SELF-TAPPIN G SCREW 4.2X25 TCB+ INOX</td> <td>4</td> <td>PZ</td> </tr> <tr> <td>VI1034A0</td> <td>STAINLESS STEEL WASHER 8.4X16X1</td> <td>1</td> <td>PZ</td> </tr> <tr> <td>VI1074A0</td> <td>4X16 SCREW FOR PLASTIC</td> <td>2</td> <td>PZ</td> </tr> <tr> <td>VI1103A0</td> <td>40X12 TBSP SCREW FOR PLASTIC</td> <td>2</td> <td>PZ</td> </tr> <tr> <td>VI1220A1</td> <td>4,2X12 TCB SELF-TAPPIN G SCREW</td> <td>30</td> <td>PZ</td> </tr> <tr> <td>VI1565A0</td> <td>WASHER INTD=4.2 EXTD=20 TH=125/10 INO</td> <td>1</td> <td>PZ</td> </tr> <tr> <td>VI1930A1</td> <td>ST. STEEL 5X20 CHIP SCREW</td> <td>16</td> <td>PZ</td> </tr> <tr> <td>VI1996A0</td> <td>M5X35 SCREW</td> <td>13</td> <td>PZ</td> </tr> <tr> <td>VM1059A1</td> <td>HEAT SHRINK FILM H800</td> <td>1</td> <td>M</td> </tr> <tr> <td>VM1182B1</td> <td>E. S. CT BT HANDLE JUNCTION + PIN GUIDE</td> <td>1</td> <td>PZ</td> </tr> <tr> <td>VM1490A0</td> <td>CHEFTOP/BAK ERTOP HANDLE SCREWS COVER</td> <td>4</td> <td>PZ</td> </tr> <tr> <td>VM1630A1</td> <td>INTERNAL GLASS PUSHING CAP</td> <td>3</td> <td>PZ</td> </tr> </tbody> </table>	Code	Description	Qty	UOM	RC1200A0	ED=4 WIRE D.=0.5 COMPRESSIO N SPRING	8	PZ	SL1155A1	LOCTITE BICOMPONEN T SILICON	80	ML	SL1170A1	S57 BLACK SILICON - 310ML CARTRIDGE	37	ML	VE1030A1	MAGNET FOR DOOR MICROSWITC H D=22,9MM	2	PZ	VI0239A1	SELF-TAPPIN G SCREW 4.2X25 TCB+ INOX	4	PZ	VI1034A0	STAINLESS STEEL WASHER 8.4X16X1	1	PZ	VI1074A0	4X16 SCREW FOR PLASTIC	2	PZ	VI1103A0	40X12 TBSP SCREW FOR PLASTIC	2	PZ	VI1220A1	4,2X12 TCB SELF-TAPPIN G SCREW	30	PZ	VI1565A0	WASHER INTD=4.2 EXTD=20 TH=125/10 INO	1	PZ	VI1930A1	ST. STEEL 5X20 CHIP SCREW	16	PZ	VI1996A0	M5X35 SCREW	13	PZ	VM1059A1	HEAT SHRINK FILM H800	1	M	VM1182B1	E. S. CT BT HANDLE JUNCTION + PIN GUIDE	1	PZ	VM1490A0	CHEFTOP/BAK ERTOP HANDLE SCREWS COVER	4	PZ	VM1630A1	INTERNAL GLASS PUSHING CAP	3	PZ
Code	Description	Qty	UOM																																																																						
RC1200A0	ED=4 WIRE D.=0.5 COMPRESSIO N SPRING	8	PZ																																																																						
SL1155A1	LOCTITE BICOMPONEN T SILICON	80	ML																																																																						
SL1170A1	S57 BLACK SILICON - 310ML CARTRIDGE	37	ML																																																																						
VE1030A1	MAGNET FOR DOOR MICROSWITC H D=22,9MM	2	PZ																																																																						
VI0239A1	SELF-TAPPIN G SCREW 4.2X25 TCB+ INOX	4	PZ																																																																						
VI1034A0	STAINLESS STEEL WASHER 8.4X16X1	1	PZ																																																																						
VI1074A0	4X16 SCREW FOR PLASTIC	2	PZ																																																																						
VI1103A0	40X12 TBSP SCREW FOR PLASTIC	2	PZ																																																																						
VI1220A1	4,2X12 TCB SELF-TAPPIN G SCREW	30	PZ																																																																						
VI1565A0	WASHER INTD=4.2 EXTD=20 TH=125/10 INO	1	PZ																																																																						
VI1930A1	ST. STEEL 5X20 CHIP SCREW	16	PZ																																																																						
VI1996A0	M5X35 SCREW	13	PZ																																																																						
VM1059A1	HEAT SHRINK FILM H800	1	M																																																																						
VM1182B1	E. S. CT BT HANDLE JUNCTION + PIN GUIDE	1	PZ																																																																						
VM1490A0	CHEFTOP/BAK ERTOP HANDLE SCREWS COVER	4	PZ																																																																						
VM1630A1	INTERNAL GLASS PUSHING CAP	3	PZ																																																																						



COMPONENT			SPARE PART																																																																																							
Code	Description	Image	Code	Description	Components list																																																																																					
VT1277A	XEVC-0711-E EXTERNAL GLASS		KDR1327A		<table border="1"> <thead> <tr> <th>Code</th> <th>Description</th> <th>Qty</th> <th>UOM</th> </tr> </thead> <tbody> <tr> <td>VM1631A0</td> <td>PLUS INNER GLASS PUSHING CAP</td> <td>3</td> <td>PZ</td> </tr> <tr> <td>VM1695A0</td> <td>HANDLE POSITION PIN</td> <td>4</td> <td>PZ</td> </tr> <tr> <td>VM2245A0</td> <td>HANDLE SHAFT WITH LATCH</td> <td>1</td> <td>PZ</td> </tr> <tr> <td>VM2247B0</td> <td>HANDLE SHAFT COVER VM2245-2246</td> <td>1</td> <td>PZ</td> </tr> <tr> <td>VM2248B0</td> <td>HANDLE WITH LATCH CLOSING KEY</td> <td>1</td> <td>PZ</td> </tr> <tr> <td>VM2259B0</td> <td></td> <td>1</td> <td>PZ</td> </tr> <tr> <td>VM2260B0</td> <td>S6 LEFT UPPER CAP</td> <td>1</td> <td>PZ</td> </tr> <tr> <td>VM2261B0</td> <td></td> <td>1</td> <td>PZ</td> </tr> <tr> <td>VM2262B0</td> <td></td> <td>1</td> <td>PZ</td> </tr> <tr> <td>VM2267A0</td> <td>INTERNAL GLASS LOCKING SYSTEM SLIDER</td> <td>2</td> <td>PZ</td> </tr> <tr> <td>VM2268A0</td> <td>DOOR MAGNET COVER</td> <td>2</td> <td>PZ</td> </tr> <tr> <td>VM2269B0</td> <td>INNER GLASS FIXING CAP</td> <td>2</td> <td>PZ</td> </tr> <tr> <td>VM2274A0</td> <td>GROOVED BUSHING</td> <td>1</td> <td>PZ</td> </tr> <tr> <td>VM2275A0</td> <td>SMOOTH BUSHING</td> <td>1</td> <td>PZ</td> </tr> <tr> <td>VM2284B0</td> <td>750 SERIES DRIP PROFILE KIT</td> <td>1</td> <td>PZ</td> </tr> <tr> <td>VM2295A1</td> <td>MIND.MAPS TOUCH CONTROL STYLUS KIT</td> <td>1</td> <td>PZ</td> </tr> <tr> <td>VM2305A0</td> <td>6 SERIES DOOR CAP FIXING PAWL</td> <td>14</td> <td>PZ</td> </tr> <tr> <td>VM2312A0</td> <td>6 S. DRIP PROFILE DRAIN LEFT PIPE</td> <td>1</td> <td>PZ</td> </tr> <tr> <td>VM2314A0</td> <td>6 S. DRIP PROFILE CAP</td> <td>1</td> <td>PZ</td> </tr> <tr> <td>VM2315B0</td> <td>S6 INTERNAL GLASS SUPPORT</td> <td>3</td> <td>PZ</td> </tr> </tbody> </table>	Code	Description	Qty	UOM	VM1631A0	PLUS INNER GLASS PUSHING CAP	3	PZ	VM1695A0	HANDLE POSITION PIN	4	PZ	VM2245A0	HANDLE SHAFT WITH LATCH	1	PZ	VM2247B0	HANDLE SHAFT COVER VM2245-2246	1	PZ	VM2248B0	HANDLE WITH LATCH CLOSING KEY	1	PZ	VM2259B0		1	PZ	VM2260B0	S6 LEFT UPPER CAP	1	PZ	VM2261B0		1	PZ	VM2262B0		1	PZ	VM2267A0	INTERNAL GLASS LOCKING SYSTEM SLIDER	2	PZ	VM2268A0	DOOR MAGNET COVER	2	PZ	VM2269B0	INNER GLASS FIXING CAP	2	PZ	VM2274A0	GROOVED BUSHING	1	PZ	VM2275A0	SMOOTH BUSHING	1	PZ	VM2284B0	750 SERIES DRIP PROFILE KIT	1	PZ	VM2295A1	MIND.MAPS TOUCH CONTROL STYLUS KIT	1	PZ	VM2305A0	6 SERIES DOOR CAP FIXING PAWL	14	PZ	VM2312A0	6 S. DRIP PROFILE DRAIN LEFT PIPE	1	PZ	VM2314A0	6 S. DRIP PROFILE CAP	1	PZ	VM2315B0	S6 INTERNAL GLASS SUPPORT	3	PZ	
Code	Description	Qty	UOM																																																																																							
VM1631A0	PLUS INNER GLASS PUSHING CAP	3	PZ																																																																																							
VM1695A0	HANDLE POSITION PIN	4	PZ																																																																																							
VM2245A0	HANDLE SHAFT WITH LATCH	1	PZ																																																																																							
VM2247B0	HANDLE SHAFT COVER VM2245-2246	1	PZ																																																																																							
VM2248B0	HANDLE WITH LATCH CLOSING KEY	1	PZ																																																																																							
VM2259B0		1	PZ																																																																																							
VM2260B0	S6 LEFT UPPER CAP	1	PZ																																																																																							
VM2261B0		1	PZ																																																																																							
VM2262B0		1	PZ																																																																																							
VM2267A0	INTERNAL GLASS LOCKING SYSTEM SLIDER	2	PZ																																																																																							
VM2268A0	DOOR MAGNET COVER	2	PZ																																																																																							
VM2269B0	INNER GLASS FIXING CAP	2	PZ																																																																																							
VM2274A0	GROOVED BUSHING	1	PZ																																																																																							
VM2275A0	SMOOTH BUSHING	1	PZ																																																																																							
VM2284B0	750 SERIES DRIP PROFILE KIT	1	PZ																																																																																							
VM2295A1	MIND.MAPS TOUCH CONTROL STYLUS KIT	1	PZ																																																																																							
VM2305A0	6 SERIES DOOR CAP FIXING PAWL	14	PZ																																																																																							
VM2312A0	6 S. DRIP PROFILE DRAIN LEFT PIPE	1	PZ																																																																																							
VM2314A0	6 S. DRIP PROFILE CAP	1	PZ																																																																																							
VM2315B0	S6 INTERNAL GLASS SUPPORT	3	PZ																																																																																							



COMPONENT			SPARE PART																																											
Code	Description	Image	Code	Description	Components list																																									
VT1277A	XEVC-0711-E EXTERNAL GLASS		KDR1327A	0711 -M LEFT EXTERNAL DOOR	<table border="1"> <thead> <tr> <th>Code</th> <th>Description</th> <th>Qty</th> <th>UOM</th> </tr> </thead> <tbody> <tr> <td>VM2410A0</td> <td>PLATE TO STOP EXTRUDED LED BAR</td> <td>1</td> <td>PZ</td> </tr> <tr> <td>VM2505B0</td> <td>MM PLUS INTERNAL GLASS SUPPORT</td> <td>3</td> <td>PZ</td> </tr> <tr> <td>VM2518A0</td> <td>BOARD COOLING FAN SUPPORT</td> <td>1</td> <td>PZ</td> </tr> <tr> <td>VN1179A1</td> <td>CONTROL BOARD 40X40X20MM 12V COOLING FAN</td> <td>1</td> <td>PZ</td> </tr> <tr> <td>VP1076A0</td> <td>PLUS ONE ZERO HANDLE PIN</td> <td>1</td> <td>PZ</td> </tr> <tr> <td>VP1080A0</td> <td>UPPER HINGE CAP FOR LOWER INNER GLASS</td> <td>1</td> <td>PZ</td> </tr> <tr> <td>VP1081A0</td> <td>UPPER HINGE CAP FOR UPPER INNER GLASS</td> <td>1</td> <td>PZ</td> </tr> <tr> <td>VT1277A0</td> <td>XEVC-0711-E EXTERNAL GLASS</td> <td>1</td> <td>PZ</td> </tr> </tbody> </table>	Code	Description	Qty	UOM	VM2410A0	PLATE TO STOP EXTRUDED LED BAR	1	PZ	VM2505B0	MM PLUS INTERNAL GLASS SUPPORT	3	PZ	VM2518A0	BOARD COOLING FAN SUPPORT	1	PZ	VN1179A1	CONTROL BOARD 40X40X20MM 12V COOLING FAN	1	PZ	VP1076A0	PLUS ONE ZERO HANDLE PIN	1	PZ	VP1080A0	UPPER HINGE CAP FOR LOWER INNER GLASS	1	PZ	VP1081A0	UPPER HINGE CAP FOR UPPER INNER GLASS	1	PZ	VT1277A0	XEVC-0711-E EXTERNAL GLASS	1	PZ					
			Code		Description	Qty	UOM																																							
VM2410A0	PLATE TO STOP EXTRUDED LED BAR	1	PZ																																											
VM2505B0	MM PLUS INTERNAL GLASS SUPPORT	3	PZ																																											
VM2518A0	BOARD COOLING FAN SUPPORT	1	PZ																																											
VN1179A1	CONTROL BOARD 40X40X20MM 12V COOLING FAN	1	PZ																																											
VP1076A0	PLUS ONE ZERO HANDLE PIN	1	PZ																																											
VP1080A0	UPPER HINGE CAP FOR LOWER INNER GLASS	1	PZ																																											
VP1081A0	UPPER HINGE CAP FOR UPPER INNER GLASS	1	PZ																																											
VT1277A0	XEVC-0711-E EXTERNAL GLASS	1	PZ																																											
KDR1266B	<table border="1"> <thead> <tr> <th>Code</th> <th>Description</th> <th>Qty</th> <th>UOM</th> </tr> </thead> <tbody> <tr> <td>0B1122B0</td> <td></td> <td>1</td> <td>PZ</td> </tr> <tr> <td>0B1167A0</td> <td>EXT. GLASS SUPPORT PROFILE</td> <td>2</td> <td>PZ</td> </tr> <tr> <td>0B1198B0</td> <td></td> <td>1</td> <td>PZ</td> </tr> <tr> <td>0B1198B1</td> <td></td> <td>1</td> <td>PZ</td> </tr> <tr> <td>0B1199A2</td> <td>0711 LEFT - DOOR RIGHT INT COLUMN</td> <td>1</td> <td>PZ</td> </tr> <tr> <td>0B1200A2</td> <td>0711 LEFT - DOOR LEFT INT COLUMN</td> <td>1</td> <td>PZ</td> </tr> <tr> <td>0B1207A0</td> <td>0711 LEFT - DOOR RIGHT EXT COLUMN</td> <td>1</td> <td>PZ</td> </tr> <tr> <td>0B1216B0</td> <td></td> <td>1</td> <td>PZ</td> </tr> <tr> <td>0B1217A1</td> <td>MM DOUBLE GLASS DOOR INT UPPER BEAM 750</td> <td>1</td> <td>PZ</td> </tr> <tr> <td>0H7321A0</td> <td>MM STAINLESS STEEL HANDLE COVE</td> <td>1</td> <td>PZ</td> </tr> </tbody> </table>	Code	Description		Qty	UOM	0B1122B0		1	PZ	0B1167A0	EXT. GLASS SUPPORT PROFILE	2	PZ	0B1198B0		1	PZ	0B1198B1		1	PZ	0B1199A2	0711 LEFT - DOOR RIGHT INT COLUMN	1	PZ	0B1200A2	0711 LEFT - DOOR LEFT INT COLUMN	1	PZ	0B1207A0	0711 LEFT - DOOR RIGHT EXT COLUMN	1	PZ	0B1216B0		1	PZ	0B1217A1	MM DOUBLE GLASS DOOR INT UPPER BEAM 750	1	PZ	0H7321A0	MM STAINLESS STEEL HANDLE COVE	1	PZ
Code	Description	Qty	UOM																																											
0B1122B0		1	PZ																																											
0B1167A0	EXT. GLASS SUPPORT PROFILE	2	PZ																																											
0B1198B0		1	PZ																																											
0B1198B1		1	PZ																																											
0B1199A2	0711 LEFT - DOOR RIGHT INT COLUMN	1	PZ																																											
0B1200A2	0711 LEFT - DOOR LEFT INT COLUMN	1	PZ																																											
0B1207A0	0711 LEFT - DOOR RIGHT EXT COLUMN	1	PZ																																											
0B1216B0		1	PZ																																											
0B1217A1	MM DOUBLE GLASS DOOR INT UPPER BEAM 750	1	PZ																																											
0H7321A0	MM STAINLESS STEEL HANDLE COVE	1	PZ																																											



COMPONENT			SPARE PART																																																																						
Code	Description	Image	Code	Description	Components list																																																																				
VT1277A	XEVC-0711-E EXTERNAL GLASS		KDR1266B	0711 -M LEFT EXTERNAL DOOR	<table border="1"> <thead> <tr> <th>Code</th> <th>Description</th> <th>Qty</th> <th>UOM</th> </tr> </thead> <tbody> <tr> <td>CE1052A1</td> <td>CABLE CONNECTION CONTROL - USB MM 750M</td> <td>1</td> <td>PZ</td> </tr> <tr> <td>CE1053B0</td> <td>MM MICROFIT LED BAR POWER SUPPLY CABL</td> <td>1</td> <td>PZ</td> </tr> <tr> <td>CE1097A0</td> <td>4M SIHF 4 POLES MICROFIT CANBUS</td> <td>1</td> <td>PZ</td> </tr> <tr> <td>CE1285A0</td> <td>EMI ROUND FERRITE MOD.26438015 02</td> <td>1</td> <td>PZ</td> </tr> <tr> <td>GN1525A0</td> <td>O-RING INT DIAM 9,5 THK 1 NBR 70</td> <td>2</td> <td>PZ</td> </tr> <tr> <td>IP1508A1</td> <td>POLYSTYREN E U SHAPED PROFILE 2000X60X60</td> <td>2</td> <td>M</td> </tr> <tr> <td>LP1020A0</td> <td>6 SERIES L400 LED LIGHT BAR - E583</td> <td>1</td> <td>PZ</td> </tr> <tr> <td>LP1026A0</td> <td>L=583 S6 NO LED LIGHT BAR COVER</td> <td>1</td> <td>PZ</td> </tr> <tr> <td>MG1099A1</td> <td></td> <td>1</td> <td>PZ</td> </tr> <tr> <td>RC1200A0</td> <td>ED=4 WIRE D.=0.5 COMPRESSIO N SPRING</td> <td>8</td> <td>PZ</td> </tr> <tr> <td>SL1155A1</td> <td>LOCTITE BICOMPONEN T SILICON</td> <td>80</td> <td>ML</td> </tr> <tr> <td>SL1170A1</td> <td>S57 BLACK SILICON - 310ML CARTRIDGE</td> <td>37</td> <td>ML</td> </tr> <tr> <td>VE1030A1</td> <td>MAGNET FOR DOOR MICROSWITC H D=22,9MM</td> <td>2</td> <td>PZ</td> </tr> <tr> <td>VI0239A1</td> <td>SELF-TAPPIN G SCREW 4.2X25 TCB+ INOX</td> <td>4</td> <td>PZ</td> </tr> <tr> <td>VI1034A0</td> <td>STAINLESS STEEL WASHER 8.4X16X1</td> <td>1</td> <td>PZ</td> </tr> <tr> <td>VI1074A0</td> <td>4X16 SCREW FOR PLASTIC</td> <td>2</td> <td>PZ</td> </tr> </tbody> </table>	Code	Description	Qty	UOM	CE1052A1	CABLE CONNECTION CONTROL - USB MM 750M	1	PZ	CE1053B0	MM MICROFIT LED BAR POWER SUPPLY CABL	1	PZ	CE1097A0	4M SIHF 4 POLES MICROFIT CANBUS	1	PZ	CE1285A0	EMI ROUND FERRITE MOD.26438015 02	1	PZ	GN1525A0	O-RING INT DIAM 9,5 THK 1 NBR 70	2	PZ	IP1508A1	POLYSTYREN E U SHAPED PROFILE 2000X60X60	2	M	LP1020A0	6 SERIES L400 LED LIGHT BAR - E583	1	PZ	LP1026A0	L=583 S6 NO LED LIGHT BAR COVER	1	PZ	MG1099A1		1	PZ	RC1200A0	ED=4 WIRE D.=0.5 COMPRESSIO N SPRING	8	PZ	SL1155A1	LOCTITE BICOMPONEN T SILICON	80	ML	SL1170A1	S57 BLACK SILICON - 310ML CARTRIDGE	37	ML	VE1030A1	MAGNET FOR DOOR MICROSWITC H D=22,9MM	2	PZ	VI0239A1	SELF-TAPPIN G SCREW 4.2X25 TCB+ INOX	4	PZ	VI1034A0	STAINLESS STEEL WASHER 8.4X16X1	1	PZ	VI1074A0	4X16 SCREW FOR PLASTIC	2	PZ
Code	Description	Qty	UOM																																																																						
CE1052A1	CABLE CONNECTION CONTROL - USB MM 750M	1	PZ																																																																						
CE1053B0	MM MICROFIT LED BAR POWER SUPPLY CABL	1	PZ																																																																						
CE1097A0	4M SIHF 4 POLES MICROFIT CANBUS	1	PZ																																																																						
CE1285A0	EMI ROUND FERRITE MOD.26438015 02	1	PZ																																																																						
GN1525A0	O-RING INT DIAM 9,5 THK 1 NBR 70	2	PZ																																																																						
IP1508A1	POLYSTYREN E U SHAPED PROFILE 2000X60X60	2	M																																																																						
LP1020A0	6 SERIES L400 LED LIGHT BAR - E583	1	PZ																																																																						
LP1026A0	L=583 S6 NO LED LIGHT BAR COVER	1	PZ																																																																						
MG1099A1		1	PZ																																																																						
RC1200A0	ED=4 WIRE D.=0.5 COMPRESSIO N SPRING	8	PZ																																																																						
SL1155A1	LOCTITE BICOMPONEN T SILICON	80	ML																																																																						
SL1170A1	S57 BLACK SILICON - 310ML CARTRIDGE	37	ML																																																																						
VE1030A1	MAGNET FOR DOOR MICROSWITC H D=22,9MM	2	PZ																																																																						
VI0239A1	SELF-TAPPIN G SCREW 4.2X25 TCB+ INOX	4	PZ																																																																						
VI1034A0	STAINLESS STEEL WASHER 8.4X16X1	1	PZ																																																																						
VI1074A0	4X16 SCREW FOR PLASTIC	2	PZ																																																																						



COMPONENT			SPARE PART																																																																																		
Code	Description	Image	Code	Description	Components list																																																																																
VT1277A	XEVC-0711-E EXTERNAL GLASS		KDR1266B	0711 -M LEFT EXTERNAL DOOR	<table border="1"> <thead> <tr> <th>Code</th> <th>Description</th> <th>Qty</th> <th>UOM</th> </tr> </thead> <tbody> <tr> <td>VI1103A0</td> <td>40X12 TBSP SCREW FOR PLASTIC</td> <td>2</td> <td>PZ</td> </tr> <tr> <td>VI1220A1</td> <td>4,2X12 TCB SELF-TAPPIN G SCREW</td> <td>27</td> <td>PZ</td> </tr> <tr> <td>VI1930A1</td> <td>ST. STEEL 5X20 CHIP SCREW</td> <td>16</td> <td>PZ</td> </tr> <tr> <td>VI1996A0</td> <td>M5X35 SCREW</td> <td>13</td> <td>PZ</td> </tr> <tr> <td>VM1059A1</td> <td>HEAT SHRINK FILM H800</td> <td>1</td> <td>M</td> </tr> <tr> <td>VM1182B1</td> <td>E S. CT BT HANDLE JUNCTION + PIN GUIDE</td> <td>1</td> <td>PZ</td> </tr> <tr> <td>VM1490A0</td> <td>CHEFTOP/BAK ERTOP HANDLE SCREWS COVER</td> <td>2</td> <td>PZ</td> </tr> <tr> <td>VM1630A1</td> <td>INTERNAL GLASS PUSHING CAP</td> <td>3</td> <td>PZ</td> </tr> <tr> <td>VM1631A0</td> <td>PLUS INNER GLASS PUSHING CAP</td> <td>2</td> <td>PZ</td> </tr> <tr> <td>VM1695A0</td> <td>HANDLE POSITION PIN</td> <td>4</td> <td>PZ</td> </tr> <tr> <td>VM2245A0</td> <td>HANDLE SHAFT WITH LATCH</td> <td>1</td> <td>PZ</td> </tr> <tr> <td>VM2247B0</td> <td>HANDLE SHAFT COVER VM2245-2246</td> <td>1</td> <td>PZ</td> </tr> <tr> <td>VM2248B0</td> <td>HANDLE WITH LATCH CLOSING KEY</td> <td>1</td> <td>PZ</td> </tr> <tr> <td>VM2267A0</td> <td>INTERNAL GLASS LOCKING SYSTEM SLIDER</td> <td>2</td> <td>PZ</td> </tr> <tr> <td>VM2268A0</td> <td>DOOR MAGNET COVER</td> <td>2</td> <td>PZ</td> </tr> <tr> <td>VM2269B0</td> <td>INNER GLASS FIXING CAP</td> <td>2</td> <td>PZ</td> </tr> <tr> <td>VM2274A0</td> <td>GROOVED BUSHING</td> <td>1</td> <td>PZ</td> </tr> <tr> <td>VM2275A0</td> <td>SMOOTH BUSHING</td> <td>1</td> <td>PZ</td> </tr> <tr> <td>VM2284B0</td> <td>750 SERIES DRIP PROFILE KIT</td> <td>1</td> <td>PZ</td> </tr> </tbody> </table>	Code	Description	Qty	UOM	VI1103A0	40X12 TBSP SCREW FOR PLASTIC	2	PZ	VI1220A1	4,2X12 TCB SELF-TAPPIN G SCREW	27	PZ	VI1930A1	ST. STEEL 5X20 CHIP SCREW	16	PZ	VI1996A0	M5X35 SCREW	13	PZ	VM1059A1	HEAT SHRINK FILM H800	1	M	VM1182B1	E S. CT BT HANDLE JUNCTION + PIN GUIDE	1	PZ	VM1490A0	CHEFTOP/BAK ERTOP HANDLE SCREWS COVER	2	PZ	VM1630A1	INTERNAL GLASS PUSHING CAP	3	PZ	VM1631A0	PLUS INNER GLASS PUSHING CAP	2	PZ	VM1695A0	HANDLE POSITION PIN	4	PZ	VM2245A0	HANDLE SHAFT WITH LATCH	1	PZ	VM2247B0	HANDLE SHAFT COVER VM2245-2246	1	PZ	VM2248B0	HANDLE WITH LATCH CLOSING KEY	1	PZ	VM2267A0	INTERNAL GLASS LOCKING SYSTEM SLIDER	2	PZ	VM2268A0	DOOR MAGNET COVER	2	PZ	VM2269B0	INNER GLASS FIXING CAP	2	PZ	VM2274A0	GROOVED BUSHING	1	PZ	VM2275A0	SMOOTH BUSHING	1	PZ	VM2284B0	750 SERIES DRIP PROFILE KIT	1	PZ
Code	Description	Qty	UOM																																																																																		
VI1103A0	40X12 TBSP SCREW FOR PLASTIC	2	PZ																																																																																		
VI1220A1	4,2X12 TCB SELF-TAPPIN G SCREW	27	PZ																																																																																		
VI1930A1	ST. STEEL 5X20 CHIP SCREW	16	PZ																																																																																		
VI1996A0	M5X35 SCREW	13	PZ																																																																																		
VM1059A1	HEAT SHRINK FILM H800	1	M																																																																																		
VM1182B1	E S. CT BT HANDLE JUNCTION + PIN GUIDE	1	PZ																																																																																		
VM1490A0	CHEFTOP/BAK ERTOP HANDLE SCREWS COVER	2	PZ																																																																																		
VM1630A1	INTERNAL GLASS PUSHING CAP	3	PZ																																																																																		
VM1631A0	PLUS INNER GLASS PUSHING CAP	2	PZ																																																																																		
VM1695A0	HANDLE POSITION PIN	4	PZ																																																																																		
VM2245A0	HANDLE SHAFT WITH LATCH	1	PZ																																																																																		
VM2247B0	HANDLE SHAFT COVER VM2245-2246	1	PZ																																																																																		
VM2248B0	HANDLE WITH LATCH CLOSING KEY	1	PZ																																																																																		
VM2267A0	INTERNAL GLASS LOCKING SYSTEM SLIDER	2	PZ																																																																																		
VM2268A0	DOOR MAGNET COVER	2	PZ																																																																																		
VM2269B0	INNER GLASS FIXING CAP	2	PZ																																																																																		
VM2274A0	GROOVED BUSHING	1	PZ																																																																																		
VM2275A0	SMOOTH BUSHING	1	PZ																																																																																		
VM2284B0	750 SERIES DRIP PROFILE KIT	1	PZ																																																																																		



COMPONENT			SPARE PART																																																																												
Code	Description	Image	Code	Description	Components list																																																																										
VT1277A	XEVC-0711-E EXTERNAL GLASS		KDR1266B	0711 -M LEFT EXTERNAL DOOR	<table border="1"> <thead> <tr> <th>Code</th> <th>Description</th> <th>Qty</th> <th>UOM</th> </tr> </thead> <tbody> <tr> <td>VM2295A1</td> <td>MIND.MAPS TOUCH CONTROL STYLUS KIT</td> <td>1</td> <td>PZ</td> </tr> <tr> <td>VM2305A0</td> <td>6 SERIES DOOR CAP FIXING PAWL</td> <td>14</td> <td>PZ</td> </tr> <tr> <td>VM2313A0</td> <td>TUBE DX DISCHARGE DRIP MM</td> <td>1</td> <td>PZ</td> </tr> <tr> <td>VM2314A0</td> <td>6 S. DRIP PROFILE CAP</td> <td>1</td> <td>PZ</td> </tr> <tr> <td>VM2315B0</td> <td>S6 INTERNAL GLASS SUPPORT</td> <td>3</td> <td>PZ</td> </tr> <tr> <td>VM2383B0</td> <td>S6 LEFT OVENS UPPER RIGHT CAP</td> <td>1</td> <td>PZ</td> </tr> <tr> <td>VM2384B0</td> <td></td> <td>1</td> <td>PZ</td> </tr> <tr> <td>VM2385B0</td> <td>S6 LEFT OVENS UPPER LEFT CAP</td> <td>1</td> <td>PZ</td> </tr> <tr> <td>VM2386B0</td> <td>MM -M LEFT DOOR LEFT LOWER CAP KI</td> <td>1</td> <td>PZ</td> </tr> <tr> <td>VM2410A0</td> <td>PLATE TO STOP EXTRUDED LED BAR</td> <td>2</td> <td>PZ</td> </tr> <tr> <td>VM2505B0</td> <td>MM PLUS INTERNAL GLASS SUPPORT</td> <td>2</td> <td>PZ</td> </tr> <tr> <td>VM2518A0</td> <td>BOARD COOLING FAN SUPPORT</td> <td>1</td> <td>PZ</td> </tr> <tr> <td>VN1179A1</td> <td>CONTROL BOARD 40X40X20MM 12V COOLING FAN</td> <td>1</td> <td>PZ</td> </tr> <tr> <td>VP1076A0</td> <td>PLUS ONE ZERO HANDLE PIN</td> <td>1</td> <td>PZ</td> </tr> <tr> <td>VP1080A0</td> <td>UPPER HINGE CAP FOR LOWER INNER GLASS</td> <td>1</td> <td>PZ</td> </tr> <tr> <td>VP1081A0</td> <td>UPPER HINGE CAP FOR UPPER INNER GLASS</td> <td>1</td> <td>PZ</td> </tr> <tr> <td>VT1277A0</td> <td>XEVC-0711-E EXTERNAL GLASS</td> <td></td> <td></td> <td>1</td> <td>PZ</td> </tr> </tbody> </table>	Code	Description	Qty	UOM	VM2295A1	MIND.MAPS TOUCH CONTROL STYLUS KIT	1	PZ	VM2305A0	6 SERIES DOOR CAP FIXING PAWL	14	PZ	VM2313A0	TUBE DX DISCHARGE DRIP MM	1	PZ	VM2314A0	6 S. DRIP PROFILE CAP	1	PZ	VM2315B0	S6 INTERNAL GLASS SUPPORT	3	PZ	VM2383B0	S6 LEFT OVENS UPPER RIGHT CAP	1	PZ	VM2384B0		1	PZ	VM2385B0	S6 LEFT OVENS UPPER LEFT CAP	1	PZ	VM2386B0	MM -M LEFT DOOR LEFT LOWER CAP KI	1	PZ	VM2410A0	PLATE TO STOP EXTRUDED LED BAR	2	PZ	VM2505B0	MM PLUS INTERNAL GLASS SUPPORT	2	PZ	VM2518A0	BOARD COOLING FAN SUPPORT	1	PZ	VN1179A1	CONTROL BOARD 40X40X20MM 12V COOLING FAN	1	PZ	VP1076A0	PLUS ONE ZERO HANDLE PIN	1	PZ	VP1080A0	UPPER HINGE CAP FOR LOWER INNER GLASS	1	PZ	VP1081A0	UPPER HINGE CAP FOR UPPER INNER GLASS	1	PZ	VT1277A0	XEVC-0711-E EXTERNAL GLASS			1	PZ
Code	Description	Qty	UOM																																																																												
VM2295A1	MIND.MAPS TOUCH CONTROL STYLUS KIT	1	PZ																																																																												
VM2305A0	6 SERIES DOOR CAP FIXING PAWL	14	PZ																																																																												
VM2313A0	TUBE DX DISCHARGE DRIP MM	1	PZ																																																																												
VM2314A0	6 S. DRIP PROFILE CAP	1	PZ																																																																												
VM2315B0	S6 INTERNAL GLASS SUPPORT	3	PZ																																																																												
VM2383B0	S6 LEFT OVENS UPPER RIGHT CAP	1	PZ																																																																												
VM2384B0		1	PZ																																																																												
VM2385B0	S6 LEFT OVENS UPPER LEFT CAP	1	PZ																																																																												
VM2386B0	MM -M LEFT DOOR LEFT LOWER CAP KI	1	PZ																																																																												
VM2410A0	PLATE TO STOP EXTRUDED LED BAR	2	PZ																																																																												
VM2505B0	MM PLUS INTERNAL GLASS SUPPORT	2	PZ																																																																												
VM2518A0	BOARD COOLING FAN SUPPORT	1	PZ																																																																												
VN1179A1	CONTROL BOARD 40X40X20MM 12V COOLING FAN	1	PZ																																																																												
VP1076A0	PLUS ONE ZERO HANDLE PIN	1	PZ																																																																												
VP1080A0	UPPER HINGE CAP FOR LOWER INNER GLASS	1	PZ																																																																												
VP1081A0	UPPER HINGE CAP FOR UPPER INNER GLASS	1	PZ																																																																												
VT1277A0	XEVC-0711-E EXTERNAL GLASS			1	PZ																																																																										



COMPONENT			SPARE PART																																																																										
Code	Description	Image	Code	Description	Components list																																																																								
VT1277A	XEVC-0711-E EXTERNAL GLASS		KDR1266A	0711 LEFT EXTERNAL DOOR	<table border="1"> <thead> <tr> <th>Code</th> <th>Description</th> <th>Qty</th> <th>UOM</th> </tr> </thead> <tbody> <tr> <td>0B1122A0</td> <td>750MM DOOR LOWER FRAME SHAPE</td> <td>1</td> <td>PZ</td> </tr> <tr> <td>0B1122A1</td> <td>750MM DOOR LOWER FRAME SHAPE</td> <td>1</td> <td>PZ</td> </tr> <tr> <td>0B1167A0</td> <td>EXT. GLASS SUPPORT PROFILE</td> <td>2</td> <td>PZ</td> </tr> <tr> <td>0B1198A0</td> <td>0711 LEFT - DOOR LEFT EXT COLUMN</td> <td>1</td> <td>PZ</td> </tr> <tr> <td>0B1198B0</td> <td></td> <td>1</td> <td>PZ</td> </tr> <tr> <td>0B1198B1</td> <td></td> <td>1</td> <td>PZ</td> </tr> <tr> <td>0B1199A2</td> <td>0711 LEFT - DOOR RIGHT INT COLUMN</td> <td>1</td> <td>PZ</td> </tr> <tr> <td>0B1200A2</td> <td>0711 LEFT - DOOR LEFT INT COLUMN</td> <td>1</td> <td>PZ</td> </tr> <tr> <td>0B1207A0</td> <td>0711 LEFT - DOOR RIGHT EXT COLUMN</td> <td>1</td> <td>PZ</td> </tr> <tr> <td>0B1216A0</td> <td>MM DOUBLE GLASS DOOR 750MM UPPER BEAM</td> <td>1</td> <td>PZ</td> </tr> <tr> <td>0B1216A1</td> <td>MM DOUBLE GLASS DOOR 750MM UPPER BEAM</td> <td>1</td> <td>PZ</td> </tr> <tr> <td>0B1217A1</td> <td>MM DOUBLE GLASS DOOR INT UPPER BEAM 750</td> <td>1</td> <td>PZ</td> </tr> <tr> <td>0H7321A0</td> <td>MM STAINLESS STEEL HANDLE COVE</td> <td>1</td> <td>PZ</td> </tr> <tr> <td>CE1052A1</td> <td>CABLE CONNECTION CONTROL - USB MM 750M</td> <td>1</td> <td>PZ</td> </tr> <tr> <td>CE1053B0</td> <td>MM MICROFIT LED BAR POWER SUPPLY CABL</td> <td>1</td> <td>PZ</td> </tr> <tr> <td>CE1285A0</td> <td>EMI ROUND FERRITE MOD.26438015 02</td> <td>1</td> <td>PZ</td> </tr> <tr> <td>CE1290A0</td> <td>EXTRACTABL E FEMALE TERMINAL CPF 5/4</td> <td>1</td> <td>PZ</td> </tr> </tbody> </table>	Code	Description	Qty	UOM	0B1122A0	750MM DOOR LOWER FRAME SHAPE	1	PZ	0B1122A1	750MM DOOR LOWER FRAME SHAPE	1	PZ	0B1167A0	EXT. GLASS SUPPORT PROFILE	2	PZ	0B1198A0	0711 LEFT - DOOR LEFT EXT COLUMN	1	PZ	0B1198B0		1	PZ	0B1198B1		1	PZ	0B1199A2	0711 LEFT - DOOR RIGHT INT COLUMN	1	PZ	0B1200A2	0711 LEFT - DOOR LEFT INT COLUMN	1	PZ	0B1207A0	0711 LEFT - DOOR RIGHT EXT COLUMN	1	PZ	0B1216A0	MM DOUBLE GLASS DOOR 750MM UPPER BEAM	1	PZ	0B1216A1	MM DOUBLE GLASS DOOR 750MM UPPER BEAM	1	PZ	0B1217A1	MM DOUBLE GLASS DOOR INT UPPER BEAM 750	1	PZ	0H7321A0	MM STAINLESS STEEL HANDLE COVE	1	PZ	CE1052A1	CABLE CONNECTION CONTROL - USB MM 750M	1	PZ	CE1053B0	MM MICROFIT LED BAR POWER SUPPLY CABL	1	PZ	CE1285A0	EMI ROUND FERRITE MOD.26438015 02	1	PZ	CE1290A0	EXTRACTABL E FEMALE TERMINAL CPF 5/4	1	PZ
Code	Description	Qty	UOM																																																																										
0B1122A0	750MM DOOR LOWER FRAME SHAPE	1	PZ																																																																										
0B1122A1	750MM DOOR LOWER FRAME SHAPE	1	PZ																																																																										
0B1167A0	EXT. GLASS SUPPORT PROFILE	2	PZ																																																																										
0B1198A0	0711 LEFT - DOOR LEFT EXT COLUMN	1	PZ																																																																										
0B1198B0		1	PZ																																																																										
0B1198B1		1	PZ																																																																										
0B1199A2	0711 LEFT - DOOR RIGHT INT COLUMN	1	PZ																																																																										
0B1200A2	0711 LEFT - DOOR LEFT INT COLUMN	1	PZ																																																																										
0B1207A0	0711 LEFT - DOOR RIGHT EXT COLUMN	1	PZ																																																																										
0B1216A0	MM DOUBLE GLASS DOOR 750MM UPPER BEAM	1	PZ																																																																										
0B1216A1	MM DOUBLE GLASS DOOR 750MM UPPER BEAM	1	PZ																																																																										
0B1217A1	MM DOUBLE GLASS DOOR INT UPPER BEAM 750	1	PZ																																																																										
0H7321A0	MM STAINLESS STEEL HANDLE COVE	1	PZ																																																																										
CE1052A1	CABLE CONNECTION CONTROL - USB MM 750M	1	PZ																																																																										
CE1053B0	MM MICROFIT LED BAR POWER SUPPLY CABL	1	PZ																																																																										
CE1285A0	EMI ROUND FERRITE MOD.26438015 02	1	PZ																																																																										
CE1290A0	EXTRACTABL E FEMALE TERMINAL CPF 5/4	1	PZ																																																																										



COMPONENT			SPARE PART																																																																														
Code	Description	Image	Code	Description	Components list																																																																												
VT1277A	XEVC-0711-E EXTERNAL GLASS		KDR1266A	0711 LEFT EXTERNAL DOOR	<table border="1"> <thead> <tr> <th>Code</th> <th>Description</th> <th>Qty</th> <th>UOM</th> </tr> </thead> <tbody> <tr> <td>CE1455A0</td> <td>TIP END FITTING</td> <td>4</td> <td>PZ</td> </tr> <tr> <td>CE1725A0</td> <td>ROBOTICS SILICON PIPE 4X0,5 MMO</td> <td>4</td> <td>M</td> </tr> <tr> <td>CE1735A0</td> <td>MINIFIT FEMALE END FITTING</td> <td>4</td> <td>PZ</td> </tr> <tr> <td>CE1755A0</td> <td>4 WAYS MALE MINIFIT CONNECTOR</td> <td>1</td> <td>PZ</td> </tr> <tr> <td>GN1525A0</td> <td>O-RING INT DIAM 9,5 THK 1 NBR 70</td> <td>1</td> <td>PZ</td> </tr> <tr> <td>IP1508A1</td> <td>POLYSTYREN E U SHAPED PROFILE 2000X60X60</td> <td>2</td> <td>M</td> </tr> <tr> <td>LP1020A0</td> <td>6 SERIES L400 LED LIGHT BAR - E583</td> <td>1</td> <td>PZ</td> </tr> <tr> <td>LP1026A0</td> <td>L=583 S6 NO LED LIGHT BAR COVER</td> <td>1</td> <td>PZ</td> </tr> <tr> <td>MG1083A2</td> <td></td> <td>1</td> <td>PZ</td> </tr> <tr> <td>RC1200A0</td> <td>ED=4 WIRE D=0,5 COMPRESSIO N SPRING</td> <td>4</td> <td>PZ</td> </tr> <tr> <td>SL1170A1</td> <td>S57 BLACK SILICON - 310ML CARTRIDGE</td> <td>37</td> <td>ML</td> </tr> <tr> <td>VE1030A1</td> <td>MAGNET FOR DOOR MICROSWITC H D=22,9MM</td> <td>2</td> <td>PZ</td> </tr> <tr> <td>VI0239A1</td> <td>SELF-TAPPIN G SCREW 4.2X25 TCB+ INOX</td> <td>4</td> <td>PZ</td> </tr> <tr> <td>VI1034A0</td> <td>STAINLESS STEEL WASHER 8,4X16X1</td> <td>1</td> <td>PZ</td> </tr> <tr> <td>VI1220A1</td> <td>4,2X12 TCB SELF-TAPPIN G SCREW</td> <td>25</td> <td>PZ</td> </tr> <tr> <td>VI1930A0</td> <td>5X25 ST. STEEL SCREW CHIP</td> <td>16</td> <td>PZ</td> </tr> <tr> <td>VI1996A0</td> <td>M5X35 SCREW</td> <td>13</td> <td>PZ</td> </tr> <tr> <td>VI2000A0</td> <td>SCREW M4X22 TCB+ INOX</td> <td>2</td> <td>PZ</td> </tr> </tbody> </table>	Code	Description	Qty	UOM	CE1455A0	TIP END FITTING	4	PZ	CE1725A0	ROBOTICS SILICON PIPE 4X0,5 MMO	4	M	CE1735A0	MINIFIT FEMALE END FITTING	4	PZ	CE1755A0	4 WAYS MALE MINIFIT CONNECTOR	1	PZ	GN1525A0	O-RING INT DIAM 9,5 THK 1 NBR 70	1	PZ	IP1508A1	POLYSTYREN E U SHAPED PROFILE 2000X60X60	2	M	LP1020A0	6 SERIES L400 LED LIGHT BAR - E583	1	PZ	LP1026A0	L=583 S6 NO LED LIGHT BAR COVER	1	PZ	MG1083A2		1	PZ	RC1200A0	ED=4 WIRE D=0,5 COMPRESSIO N SPRING	4	PZ	SL1170A1	S57 BLACK SILICON - 310ML CARTRIDGE	37	ML	VE1030A1	MAGNET FOR DOOR MICROSWITC H D=22,9MM	2	PZ	VI0239A1	SELF-TAPPIN G SCREW 4.2X25 TCB+ INOX	4	PZ	VI1034A0	STAINLESS STEEL WASHER 8,4X16X1	1	PZ	VI1220A1	4,2X12 TCB SELF-TAPPIN G SCREW	25	PZ	VI1930A0	5X25 ST. STEEL SCREW CHIP	16	PZ	VI1996A0	M5X35 SCREW	13	PZ	VI2000A0	SCREW M4X22 TCB+ INOX	2	PZ
Code	Description	Qty	UOM																																																																														
CE1455A0	TIP END FITTING	4	PZ																																																																														
CE1725A0	ROBOTICS SILICON PIPE 4X0,5 MMO	4	M																																																																														
CE1735A0	MINIFIT FEMALE END FITTING	4	PZ																																																																														
CE1755A0	4 WAYS MALE MINIFIT CONNECTOR	1	PZ																																																																														
GN1525A0	O-RING INT DIAM 9,5 THK 1 NBR 70	1	PZ																																																																														
IP1508A1	POLYSTYREN E U SHAPED PROFILE 2000X60X60	2	M																																																																														
LP1020A0	6 SERIES L400 LED LIGHT BAR - E583	1	PZ																																																																														
LP1026A0	L=583 S6 NO LED LIGHT BAR COVER	1	PZ																																																																														
MG1083A2		1	PZ																																																																														
RC1200A0	ED=4 WIRE D=0,5 COMPRESSIO N SPRING	4	PZ																																																																														
SL1170A1	S57 BLACK SILICON - 310ML CARTRIDGE	37	ML																																																																														
VE1030A1	MAGNET FOR DOOR MICROSWITC H D=22,9MM	2	PZ																																																																														
VI0239A1	SELF-TAPPIN G SCREW 4.2X25 TCB+ INOX	4	PZ																																																																														
VI1034A0	STAINLESS STEEL WASHER 8,4X16X1	1	PZ																																																																														
VI1220A1	4,2X12 TCB SELF-TAPPIN G SCREW	25	PZ																																																																														
VI1930A0	5X25 ST. STEEL SCREW CHIP	16	PZ																																																																														
VI1996A0	M5X35 SCREW	13	PZ																																																																														
VI2000A0	SCREW M4X22 TCB+ INOX	2	PZ																																																																														



COMPONENT			SPARE PART																																																																										
Code	Description	Image	Code	Description	Components list																																																																								
VT1277A	XEVC-0711-E EXTERNAL GLASS		KDR1266A	0711 LEFT EXTERNAL DOOR	<table border="1"> <thead> <tr> <th>Code</th> <th>Description</th> <th>Qty</th> <th>UOM</th> </tr> </thead> <tbody> <tr> <td>VM1059A1</td> <td>HEAT SHRINK FILM H800</td> <td>1.500</td> <td>M</td> </tr> <tr> <td>VM1182B1</td> <td>E.S. CT BT HANDLE JUNCTION + PIN GUIDE</td> <td>1</td> <td>PZ</td> </tr> <tr> <td>VM1183B0</td> <td>CHEFTOP/BAK ERTOP HANDLE PIN</td> <td>1</td> <td>PZ</td> </tr> <tr> <td>VM1183B1</td> <td>CT BT HANDLE PIN</td> <td>1</td> <td>PZ</td> </tr> <tr> <td>VM1183C0</td> <td>CT BT HANDLE T-SHAPED PIN KIT</td> <td>1</td> <td>PZ</td> </tr> <tr> <td>VM1183C1</td> <td>CT BT HANDLE T-SHAPED PIN KIT</td> <td>1</td> <td>PZ</td> </tr> <tr> <td>VM1490A0</td> <td>CHEFTOP/BAK ERTOP HANDLE SCREWS COVER</td> <td>2</td> <td>PZ</td> </tr> <tr> <td>VM1630A0</td> <td>INTERNAL GLASS PUSHING CAP</td> <td>1</td> <td>PZ</td> </tr> <tr> <td>VM1630A1</td> <td>INTERNAL GLASS PUSHING CAP</td> <td>1</td> <td>PZ</td> </tr> <tr> <td>VM1631A0</td> <td>PLUS INNER GLASS PUSHING CAP</td> <td>2</td> <td>PZ</td> </tr> <tr> <td>VM1695A0</td> <td>HANDLE POSITION PIN</td> <td>4</td> <td>PZ</td> </tr> <tr> <td>VM2245A0</td> <td>HANDLE SHAFT WITH LATCH</td> <td>1</td> <td>PZ</td> </tr> <tr> <td>VM2247A0</td> <td>HANDLE SHAFT COVER VM2245-2246</td> <td>1</td> <td>PZ</td> </tr> <tr> <td>VM2247B0</td> <td>HANDLE SHAFT COVER VM2245-2246</td> <td>1</td> <td>PZ</td> </tr> <tr> <td>VM2248B0</td> <td>HANDLE WITH LATCH CLOSING KEY</td> <td>1</td> <td>PZ</td> </tr> <tr> <td>VM2260A1</td> <td>6 SERIES DOOR UPPER LEFT CAP</td> <td>1</td> <td>PZ</td> </tr> <tr> <td>VM2267A0</td> <td>INTERNAL GLASS LOCKING SYSTEM SLIDER</td> <td>2</td> <td>PZ</td> </tr> </tbody> </table>	Code	Description	Qty	UOM	VM1059A1	HEAT SHRINK FILM H800	1.500	M	VM1182B1	E.S. CT BT HANDLE JUNCTION + PIN GUIDE	1	PZ	VM1183B0	CHEFTOP/BAK ERTOP HANDLE PIN	1	PZ	VM1183B1	CT BT HANDLE PIN	1	PZ	VM1183C0	CT BT HANDLE T-SHAPED PIN KIT	1	PZ	VM1183C1	CT BT HANDLE T-SHAPED PIN KIT	1	PZ	VM1490A0	CHEFTOP/BAK ERTOP HANDLE SCREWS COVER	2	PZ	VM1630A0	INTERNAL GLASS PUSHING CAP	1	PZ	VM1630A1	INTERNAL GLASS PUSHING CAP	1	PZ	VM1631A0	PLUS INNER GLASS PUSHING CAP	2	PZ	VM1695A0	HANDLE POSITION PIN	4	PZ	VM2245A0	HANDLE SHAFT WITH LATCH	1	PZ	VM2247A0	HANDLE SHAFT COVER VM2245-2246	1	PZ	VM2247B0	HANDLE SHAFT COVER VM2245-2246	1	PZ	VM2248B0	HANDLE WITH LATCH CLOSING KEY	1	PZ	VM2260A1	6 SERIES DOOR UPPER LEFT CAP	1	PZ	VM2267A0	INTERNAL GLASS LOCKING SYSTEM SLIDER	2	PZ
Code	Description	Qty	UOM																																																																										
VM1059A1	HEAT SHRINK FILM H800	1.500	M																																																																										
VM1182B1	E.S. CT BT HANDLE JUNCTION + PIN GUIDE	1	PZ																																																																										
VM1183B0	CHEFTOP/BAK ERTOP HANDLE PIN	1	PZ																																																																										
VM1183B1	CT BT HANDLE PIN	1	PZ																																																																										
VM1183C0	CT BT HANDLE T-SHAPED PIN KIT	1	PZ																																																																										
VM1183C1	CT BT HANDLE T-SHAPED PIN KIT	1	PZ																																																																										
VM1490A0	CHEFTOP/BAK ERTOP HANDLE SCREWS COVER	2	PZ																																																																										
VM1630A0	INTERNAL GLASS PUSHING CAP	1	PZ																																																																										
VM1630A1	INTERNAL GLASS PUSHING CAP	1	PZ																																																																										
VM1631A0	PLUS INNER GLASS PUSHING CAP	2	PZ																																																																										
VM1695A0	HANDLE POSITION PIN	4	PZ																																																																										
VM2245A0	HANDLE SHAFT WITH LATCH	1	PZ																																																																										
VM2247A0	HANDLE SHAFT COVER VM2245-2246	1	PZ																																																																										
VM2247B0	HANDLE SHAFT COVER VM2245-2246	1	PZ																																																																										
VM2248B0	HANDLE WITH LATCH CLOSING KEY	1	PZ																																																																										
VM2260A1	6 SERIES DOOR UPPER LEFT CAP	1	PZ																																																																										
VM2267A0	INTERNAL GLASS LOCKING SYSTEM SLIDER	2	PZ																																																																										



COMPONENT			SPARE PART																																																																														
Code	Description	Image	Code	Description	Components list																																																																												
VT1277A	XEVC-0711-E EXTERNAL GLASS		KDR1266A	0711 LEFT EXTERNAL DOOR	<table border="1"> <thead> <tr> <th>Code</th> <th>Description</th> <th>Qty</th> <th>UOM</th> </tr> </thead> <tbody> <tr> <td>VM2268A0</td> <td>DOOR MAGNET COVER</td> <td>2</td> <td>PZ</td> </tr> <tr> <td>VM2269A0</td> <td>INTERNAL GLASS LOCKING SYSTEM CAP</td> <td>2</td> <td>PZ</td> </tr> <tr> <td>VM2274A0</td> <td>GROOVED BUSHING</td> <td>1</td> <td>PZ</td> </tr> <tr> <td>VM2275A0</td> <td>SMOOTH BUSHING</td> <td>1</td> <td>PZ</td> </tr> <tr> <td>VM2284A0</td> <td>750 SERIES DRIP PROFILE</td> <td>1</td> <td>PZ</td> </tr> <tr> <td>VM2295A0</td> <td>STYLUS PEN FOR MM</td> <td>1</td> <td>PZ</td> </tr> <tr> <td>VM2305A0</td> <td>6 SERIES DOOR CAP FIXING PAWL</td> <td>14</td> <td>PZ</td> </tr> <tr> <td>VM2312A0</td> <td>6 S. DRIP PROFILE DRAIN LEFT PIPE</td> <td>1</td> <td>PZ</td> </tr> <tr> <td>VM2313A0</td> <td>TUBE DX DISCHARGE DRIP MM</td> <td>1</td> <td>PZ</td> </tr> <tr> <td>VM2314A0</td> <td>6 S. DRIP PROFILE CAP</td> <td>1</td> <td>PZ</td> </tr> <tr> <td>VM2315A0</td> <td>MIND.MAPS INTERNAL GLASS CAP SUPPORT</td> <td>1</td> <td>PZ</td> </tr> <tr> <td>VM2371A0</td> <td>DOUBLE GLASS DOOR PUSHING BRACKET</td> <td>2</td> <td>PZ</td> </tr> <tr> <td>VM2371A0</td> <td>DOUBLE GLASS DOOR PUSHING BRACKET</td> <td>2</td> <td>PZ</td> </tr> <tr> <td>VM2383A0</td> <td>MM LEFT DOOR RIGHT UPPER CAP</td> <td>1</td> <td>PZ</td> </tr> <tr> <td>VM2383A0</td> <td>MM LEFT DOOR RIGHT UPPER CAP</td> <td>1</td> <td>PZ</td> </tr> <tr> <td>VM2385A1</td> <td>LEFT MM DOOR UPPER LEFT CAP</td> <td>1</td> <td>PZ</td> </tr> <tr> <td>VM2385A1</td> <td>LEFT MM DOOR UPPER LEFT CAP</td> <td>1</td> <td>PZ</td> </tr> <tr> <td>VM2386A1</td> <td>LEFT MM DOOR LOWER LEFT CAP</td> <td>1</td> <td>PZ</td> </tr> </tbody> </table>	Code	Description	Qty	UOM	VM2268A0	DOOR MAGNET COVER	2	PZ	VM2269A0	INTERNAL GLASS LOCKING SYSTEM CAP	2	PZ	VM2274A0	GROOVED BUSHING	1	PZ	VM2275A0	SMOOTH BUSHING	1	PZ	VM2284A0	750 SERIES DRIP PROFILE	1	PZ	VM2295A0	STYLUS PEN FOR MM	1	PZ	VM2305A0	6 SERIES DOOR CAP FIXING PAWL	14	PZ	VM2312A0	6 S. DRIP PROFILE DRAIN LEFT PIPE	1	PZ	VM2313A0	TUBE DX DISCHARGE DRIP MM	1	PZ	VM2314A0	6 S. DRIP PROFILE CAP	1	PZ	VM2315A0	MIND.MAPS INTERNAL GLASS CAP SUPPORT	1	PZ	VM2371A0	DOUBLE GLASS DOOR PUSHING BRACKET	2	PZ	VM2371A0	DOUBLE GLASS DOOR PUSHING BRACKET	2	PZ	VM2383A0	MM LEFT DOOR RIGHT UPPER CAP	1	PZ	VM2383A0	MM LEFT DOOR RIGHT UPPER CAP	1	PZ	VM2385A1	LEFT MM DOOR UPPER LEFT CAP	1	PZ	VM2385A1	LEFT MM DOOR UPPER LEFT CAP	1	PZ	VM2386A1	LEFT MM DOOR LOWER LEFT CAP	1	PZ
Code	Description	Qty	UOM																																																																														
VM2268A0	DOOR MAGNET COVER	2	PZ																																																																														
VM2269A0	INTERNAL GLASS LOCKING SYSTEM CAP	2	PZ																																																																														
VM2274A0	GROOVED BUSHING	1	PZ																																																																														
VM2275A0	SMOOTH BUSHING	1	PZ																																																																														
VM2284A0	750 SERIES DRIP PROFILE	1	PZ																																																																														
VM2295A0	STYLUS PEN FOR MM	1	PZ																																																																														
VM2305A0	6 SERIES DOOR CAP FIXING PAWL	14	PZ																																																																														
VM2312A0	6 S. DRIP PROFILE DRAIN LEFT PIPE	1	PZ																																																																														
VM2313A0	TUBE DX DISCHARGE DRIP MM	1	PZ																																																																														
VM2314A0	6 S. DRIP PROFILE CAP	1	PZ																																																																														
VM2315A0	MIND.MAPS INTERNAL GLASS CAP SUPPORT	1	PZ																																																																														
VM2371A0	DOUBLE GLASS DOOR PUSHING BRACKET	2	PZ																																																																														
VM2371A0	DOUBLE GLASS DOOR PUSHING BRACKET	2	PZ																																																																														
VM2383A0	MM LEFT DOOR RIGHT UPPER CAP	1	PZ																																																																														
VM2383A0	MM LEFT DOOR RIGHT UPPER CAP	1	PZ																																																																														
VM2385A1	LEFT MM DOOR UPPER LEFT CAP	1	PZ																																																																														
VM2385A1	LEFT MM DOOR UPPER LEFT CAP	1	PZ																																																																														
VM2386A1	LEFT MM DOOR LOWER LEFT CAP	1	PZ																																																																														



COMPONENT			SPARE PART																																																																													
Code	Description	Image	Code	Description	Components list																																																																											
VT1277A	XEVC-0711-E EXTERNAL GLASS		KDR1266A	0711 LEFT EXTERNAL DOOR	<table border="1"> <thead> <tr> <th>Code</th> <th>Description</th> <th>Qty</th> <th>UOM</th> </tr> </thead> <tbody> <tr> <td>VM2386A1</td> <td>LEFT MM DOOR LOWER LEFT CAP</td> <td>1</td> <td>PZ</td> </tr> <tr> <td>VM2410A0</td> <td>PLATE TO STOP EXTRUDED LED BAR</td> <td>2</td> <td>PZ</td> </tr> <tr> <td>VM2410A0</td> <td>PLATE TO STOP EXTRUDED LED BAR</td> <td>2</td> <td>PZ</td> </tr> <tr> <td>VM2505A0</td> <td>MM PLUS INTERNAL GLASS SUPPORT</td> <td>2</td> <td>PZ</td> </tr> <tr> <td>VM2518A0</td> <td>BOARD COOLING FAN SUPPORT</td> <td>1</td> <td>PZ</td> </tr> <tr> <td>VM2518A0</td> <td>BOARD COOLING FAN SUPPORT</td> <td>1</td> <td>PZ</td> </tr> <tr> <td>VN1179A0</td> <td>CONTROL BOARD 40X40X20MM 12V COOLING FAN</td> <td>1</td> <td>PZ</td> </tr> <tr> <td>VN1179A0</td> <td>CONTROL BOARD 40X40X20MM 12V COOLING FAN</td> <td>1</td> <td>PZ</td> </tr> <tr> <td>VN1179A1</td> <td>CONTROL BOARD 40X40X20MM 12V COOLING FAN</td> <td>1</td> <td>PZ</td> </tr> <tr> <td>VT1277A0</td> <td>XEVC-0711-E EXTERNAL GLASS</td> <td>1</td> <td>PZ</td> </tr> <tr> <td>VT1277A0</td> <td>XEVC-0711-E EXTERNAL GLASS</td> <td>1</td> <td>PZ</td> </tr> </tbody> </table>	Code	Description	Qty	UOM	VM2386A1	LEFT MM DOOR LOWER LEFT CAP	1	PZ	VM2410A0	PLATE TO STOP EXTRUDED LED BAR	2	PZ	VM2410A0	PLATE TO STOP EXTRUDED LED BAR	2	PZ	VM2505A0	MM PLUS INTERNAL GLASS SUPPORT	2	PZ	VM2518A0	BOARD COOLING FAN SUPPORT	1	PZ	VM2518A0	BOARD COOLING FAN SUPPORT	1	PZ	VN1179A0	CONTROL BOARD 40X40X20MM 12V COOLING FAN	1	PZ	VN1179A0	CONTROL BOARD 40X40X20MM 12V COOLING FAN	1	PZ	VN1179A1	CONTROL BOARD 40X40X20MM 12V COOLING FAN	1	PZ	VT1277A0	XEVC-0711-E EXTERNAL GLASS	1	PZ	VT1277A0	XEVC-0711-E EXTERNAL GLASS	1	PZ	KDR1262B	0711 -M RIGHT EXTERNAL DOOR	<table border="1"> <thead> <tr> <th>Code</th> <th>Description</th> <th>Qty</th> <th>UOM</th> </tr> </thead> <tbody> <tr> <td>0B1111A0</td> <td>XEVC-0711-E LEFT EXT DOOR COLUM</td> <td>1</td> <td>PZ</td> </tr> <tr> <td>0B1112A2</td> <td>0711 RIGHT - DOOR LEFT INT COLUMN</td> <td>1</td> <td>PZ</td> </tr> <tr> <td>0B1113B0</td> <td></td> <td>1</td> <td>PZ</td> </tr> <tr> <td>0B1113B1</td> <td></td> <td>1</td> <td>PZ</td> </tr> <tr> <td>0B1114A2</td> <td>0711 RIGHT - DOOR RIGHT INT COLUMN</td> <td>1</td> <td>PZ</td> </tr> </tbody> </table>	Code	Description	Qty	UOM	0B1111A0	XEVC-0711-E LEFT EXT DOOR COLUM	1	PZ	0B1112A2	0711 RIGHT - DOOR LEFT INT COLUMN	1	PZ	0B1113B0		1	PZ	0B1113B1		1	PZ	0B1114A2	0711 RIGHT - DOOR RIGHT INT COLUMN	1	PZ
			Code	Description	Qty	UOM																																																																										
VM2386A1	LEFT MM DOOR LOWER LEFT CAP	1	PZ																																																																													
VM2410A0	PLATE TO STOP EXTRUDED LED BAR	2	PZ																																																																													
VM2410A0	PLATE TO STOP EXTRUDED LED BAR	2	PZ																																																																													
VM2505A0	MM PLUS INTERNAL GLASS SUPPORT	2	PZ																																																																													
VM2518A0	BOARD COOLING FAN SUPPORT	1	PZ																																																																													
VM2518A0	BOARD COOLING FAN SUPPORT	1	PZ																																																																													
VN1179A0	CONTROL BOARD 40X40X20MM 12V COOLING FAN	1	PZ																																																																													
VN1179A0	CONTROL BOARD 40X40X20MM 12V COOLING FAN	1	PZ																																																																													
VN1179A1	CONTROL BOARD 40X40X20MM 12V COOLING FAN	1	PZ																																																																													
VT1277A0	XEVC-0711-E EXTERNAL GLASS	1	PZ																																																																													
VT1277A0	XEVC-0711-E EXTERNAL GLASS	1	PZ																																																																													
Code	Description	Qty	UOM																																																																													
0B1111A0	XEVC-0711-E LEFT EXT DOOR COLUM	1	PZ																																																																													
0B1112A2	0711 RIGHT - DOOR LEFT INT COLUMN	1	PZ																																																																													
0B1113B0		1	PZ																																																																													
0B1113B1		1	PZ																																																																													
0B1114A2	0711 RIGHT - DOOR RIGHT INT COLUMN	1	PZ																																																																													



COMPONENT			SPARE PART																																																																										
Code	Description	Image	Code	Description	Components list																																																																								
VT1277A	XEVC-0711-E EXTERNAL GLASS		KDR1262B	0711 -M RIGHT EXTERNAL DOOR	<table border="1"> <thead> <tr> <th>Code</th> <th>Description</th> <th>Qty</th> <th>UOM</th> </tr> </thead> <tbody> <tr> <td>0B1122B0</td> <td></td> <td>1</td> <td>PZ</td> </tr> <tr> <td>0B1167A0</td> <td>EXT. GLASS SUPPORT PROFILE</td> <td>2</td> <td>PZ</td> </tr> <tr> <td>0B1216B0</td> <td></td> <td>1</td> <td>PZ</td> </tr> <tr> <td>0B1217A1</td> <td>MM DOUBLE GLASS DOOR INT UPPER BEAM 750</td> <td>1</td> <td>PZ</td> </tr> <tr> <td>0H7321A0</td> <td>MM STAINLESS STEEL HANDLE COVE</td> <td>1</td> <td>PZ</td> </tr> <tr> <td>CE1052A1</td> <td>CABLE CONNECTION CONTROL - USB MM 750M</td> <td>1</td> <td>PZ</td> </tr> <tr> <td>CE1053B0</td> <td>MM MICROFIT LED BAR POWER SUPPLY CABL</td> <td>1</td> <td>PZ</td> </tr> <tr> <td>CE1097A0</td> <td>4M SIHF 4 POLES MICROFIT CANBUS</td> <td>1</td> <td>PZ</td> </tr> <tr> <td>CE1285A0</td> <td>EMI ROUND FERRITE MOD.26438015 02</td> <td>1</td> <td>PZ</td> </tr> <tr> <td>GN1525A0</td> <td>O-RING INT DIAM 9,5 THK 1 NBR 70</td> <td>1</td> <td>PZ</td> </tr> <tr> <td>IP1508A1</td> <td>POLYSTYREN E U SHAPED PROFILE 2000X60X60</td> <td>2</td> <td>M</td> </tr> <tr> <td>LP1020A0</td> <td>6 SERIES L400 LED LIGHT BAR - E583</td> <td>1</td> <td>PZ</td> </tr> <tr> <td>LP1026A0</td> <td>L=583 S6 NO LED LIGHT BAR COVER</td> <td>1</td> <td>PZ</td> </tr> <tr> <td>MG1099A1</td> <td></td> <td>1</td> <td>PZ</td> </tr> <tr> <td>RC1200A0</td> <td>ED=4 WIRE D.=0.5 COMPRESSIO N SPRING</td> <td>8</td> <td>PZ</td> </tr> <tr> <td>SL1155A1</td> <td>LOCTITE BICOMPONEN T SILICON</td> <td>80</td> <td>ML</td> </tr> <tr> <td>SL1170A1</td> <td>S57 BLACK SILICON - 310ML CARTRIDGE</td> <td>1</td> <td>ML</td> </tr> </tbody> </table>	Code	Description	Qty	UOM	0B1122B0		1	PZ	0B1167A0	EXT. GLASS SUPPORT PROFILE	2	PZ	0B1216B0		1	PZ	0B1217A1	MM DOUBLE GLASS DOOR INT UPPER BEAM 750	1	PZ	0H7321A0	MM STAINLESS STEEL HANDLE COVE	1	PZ	CE1052A1	CABLE CONNECTION CONTROL - USB MM 750M	1	PZ	CE1053B0	MM MICROFIT LED BAR POWER SUPPLY CABL	1	PZ	CE1097A0	4M SIHF 4 POLES MICROFIT CANBUS	1	PZ	CE1285A0	EMI ROUND FERRITE MOD.26438015 02	1	PZ	GN1525A0	O-RING INT DIAM 9,5 THK 1 NBR 70	1	PZ	IP1508A1	POLYSTYREN E U SHAPED PROFILE 2000X60X60	2	M	LP1020A0	6 SERIES L400 LED LIGHT BAR - E583	1	PZ	LP1026A0	L=583 S6 NO LED LIGHT BAR COVER	1	PZ	MG1099A1		1	PZ	RC1200A0	ED=4 WIRE D.=0.5 COMPRESSIO N SPRING	8	PZ	SL1155A1	LOCTITE BICOMPONEN T SILICON	80	ML	SL1170A1	S57 BLACK SILICON - 310ML CARTRIDGE	1	ML
Code	Description	Qty	UOM																																																																										
0B1122B0		1	PZ																																																																										
0B1167A0	EXT. GLASS SUPPORT PROFILE	2	PZ																																																																										
0B1216B0		1	PZ																																																																										
0B1217A1	MM DOUBLE GLASS DOOR INT UPPER BEAM 750	1	PZ																																																																										
0H7321A0	MM STAINLESS STEEL HANDLE COVE	1	PZ																																																																										
CE1052A1	CABLE CONNECTION CONTROL - USB MM 750M	1	PZ																																																																										
CE1053B0	MM MICROFIT LED BAR POWER SUPPLY CABL	1	PZ																																																																										
CE1097A0	4M SIHF 4 POLES MICROFIT CANBUS	1	PZ																																																																										
CE1285A0	EMI ROUND FERRITE MOD.26438015 02	1	PZ																																																																										
GN1525A0	O-RING INT DIAM 9,5 THK 1 NBR 70	1	PZ																																																																										
IP1508A1	POLYSTYREN E U SHAPED PROFILE 2000X60X60	2	M																																																																										
LP1020A0	6 SERIES L400 LED LIGHT BAR - E583	1	PZ																																																																										
LP1026A0	L=583 S6 NO LED LIGHT BAR COVER	1	PZ																																																																										
MG1099A1		1	PZ																																																																										
RC1200A0	ED=4 WIRE D.=0.5 COMPRESSIO N SPRING	8	PZ																																																																										
SL1155A1	LOCTITE BICOMPONEN T SILICON	80	ML																																																																										
SL1170A1	S57 BLACK SILICON - 310ML CARTRIDGE	1	ML																																																																										





COMPONENT			SPARE PART																																																																																		
Code	Description	Image	Code	Description	Components list																																																																																
VT1277A	XEVC-0711-E EXTERNAL GLASS		KDR1262B	0711 -M RIGHT EXTERNAL DOOR	<table border="1"> <thead> <tr> <th>Code</th> <th>Description</th> <th>Qty</th> <th>UOM</th> </tr> </thead> <tbody> <tr> <td>VE1030A1</td> <td>MAGNET FOR DOOR MICROSWITC H D=22.9MM</td> <td>2</td> <td>PZ</td> </tr> <tr> <td>VI0239A1</td> <td>SELF-TAPPIN G SCREW 4.2X25 TCB+ INOX</td> <td>4</td> <td>PZ</td> </tr> <tr> <td>VI1034A0</td> <td>STAINLESS STEEL WASHER 8.4X16X1</td> <td>1</td> <td>PZ</td> </tr> <tr> <td>VI1074A0</td> <td>4X16 SCREW FOR PLASTIC</td> <td>2</td> <td>PZ</td> </tr> <tr> <td>VI1103A0</td> <td>40X12 TBSP SCREW FOR PLASTIC</td> <td>2</td> <td>PZ</td> </tr> <tr> <td>VI1220A1</td> <td>4,2X12 TCB SELF-TAPPIN G SCREW</td> <td>27</td> <td>PZ</td> </tr> <tr> <td>VI1930A1</td> <td>ST. STEEL 5X20 CHIP SCREW</td> <td>16</td> <td>PZ</td> </tr> <tr> <td>VI1996A0</td> <td>M5X35 SCREW</td> <td>13</td> <td>PZ</td> </tr> <tr> <td>VM1059A1</td> <td>HEAT SHRINK FILM H800</td> <td>1</td> <td>M</td> </tr> <tr> <td>VM1182B1</td> <td>E S. CT BT HANDLE JUNCTION + PIN GUIDE</td> <td>1</td> <td>PZ</td> </tr> <tr> <td>VM1490A0</td> <td>CHEFTOP/BAK ERTOP HANDLE SCREWS COVER</td> <td>2</td> <td>PZ</td> </tr> <tr> <td>VM1630A1</td> <td>INTERNAL GLASS PUSHING CAP</td> <td>3</td> <td>PZ</td> </tr> <tr> <td>VM1631A0</td> <td>PLUS INNER GLASS PUSHING CAP</td> <td>2</td> <td>PZ</td> </tr> <tr> <td>VM1695A0</td> <td>HANDLE POSITION PIN</td> <td>4</td> <td>PZ</td> </tr> <tr> <td>VM2245A0</td> <td>HANDLE SHAFT WITH LATCH</td> <td>1</td> <td>PZ</td> </tr> <tr> <td>VM2247B0</td> <td>HANDLE SHAFT COVER VM2245-2246</td> <td>1</td> <td>PZ</td> </tr> <tr> <td>VM2248B0</td> <td>HANDLE WITH LATCH CLOSING KEY</td> <td>1</td> <td>PZ</td> </tr> <tr> <td>VM2259B0</td> <td></td> <td>1</td> <td>PZ</td> </tr> <tr> <td>VM2260B0</td> <td>S6 LEFT UPPER CAP</td> <td>1</td> <td>PZ</td> </tr> </tbody> </table>	Code	Description	Qty	UOM	VE1030A1	MAGNET FOR DOOR MICROSWITC H D=22.9MM	2	PZ	VI0239A1	SELF-TAPPIN G SCREW 4.2X25 TCB+ INOX	4	PZ	VI1034A0	STAINLESS STEEL WASHER 8.4X16X1	1	PZ	VI1074A0	4X16 SCREW FOR PLASTIC	2	PZ	VI1103A0	40X12 TBSP SCREW FOR PLASTIC	2	PZ	VI1220A1	4,2X12 TCB SELF-TAPPIN G SCREW	27	PZ	VI1930A1	ST. STEEL 5X20 CHIP SCREW	16	PZ	VI1996A0	M5X35 SCREW	13	PZ	VM1059A1	HEAT SHRINK FILM H800	1	M	VM1182B1	E S. CT BT HANDLE JUNCTION + PIN GUIDE	1	PZ	VM1490A0	CHEFTOP/BAK ERTOP HANDLE SCREWS COVER	2	PZ	VM1630A1	INTERNAL GLASS PUSHING CAP	3	PZ	VM1631A0	PLUS INNER GLASS PUSHING CAP	2	PZ	VM1695A0	HANDLE POSITION PIN	4	PZ	VM2245A0	HANDLE SHAFT WITH LATCH	1	PZ	VM2247B0	HANDLE SHAFT COVER VM2245-2246	1	PZ	VM2248B0	HANDLE WITH LATCH CLOSING KEY	1	PZ	VM2259B0		1	PZ	VM2260B0	S6 LEFT UPPER CAP	1	PZ
Code	Description	Qty	UOM																																																																																		
VE1030A1	MAGNET FOR DOOR MICROSWITC H D=22.9MM	2	PZ																																																																																		
VI0239A1	SELF-TAPPIN G SCREW 4.2X25 TCB+ INOX	4	PZ																																																																																		
VI1034A0	STAINLESS STEEL WASHER 8.4X16X1	1	PZ																																																																																		
VI1074A0	4X16 SCREW FOR PLASTIC	2	PZ																																																																																		
VI1103A0	40X12 TBSP SCREW FOR PLASTIC	2	PZ																																																																																		
VI1220A1	4,2X12 TCB SELF-TAPPIN G SCREW	27	PZ																																																																																		
VI1930A1	ST. STEEL 5X20 CHIP SCREW	16	PZ																																																																																		
VI1996A0	M5X35 SCREW	13	PZ																																																																																		
VM1059A1	HEAT SHRINK FILM H800	1	M																																																																																		
VM1182B1	E S. CT BT HANDLE JUNCTION + PIN GUIDE	1	PZ																																																																																		
VM1490A0	CHEFTOP/BAK ERTOP HANDLE SCREWS COVER	2	PZ																																																																																		
VM1630A1	INTERNAL GLASS PUSHING CAP	3	PZ																																																																																		
VM1631A0	PLUS INNER GLASS PUSHING CAP	2	PZ																																																																																		
VM1695A0	HANDLE POSITION PIN	4	PZ																																																																																		
VM2245A0	HANDLE SHAFT WITH LATCH	1	PZ																																																																																		
VM2247B0	HANDLE SHAFT COVER VM2245-2246	1	PZ																																																																																		
VM2248B0	HANDLE WITH LATCH CLOSING KEY	1	PZ																																																																																		
VM2259B0		1	PZ																																																																																		
VM2260B0	S6 LEFT UPPER CAP	1	PZ																																																																																		



COMPONENT			SPARE PART					
Code	Description	Image	Code	Description	Components list			
VT1277A	XEVC-0711-E EXTERNAL GLASS		KDR1262B	0711 -M RIGHT EXTERNAL DOOR	Code	Description	Qty	UOM
					VM2261B0		1	PZ
					VM2262B0		1	PZ
					VM2267A0	INTERNAL GLASS LOCKING SYSTEM SLIDER	2	PZ
					VM2268A0	DOOR MAGNET COVER	2	PZ
					VM2269B0	INNER GLASS FIXING CAP	2	PZ
					VM2274A0	GROOVED BUSHING	1	PZ
					VM2275A0	SMOOTH BUSHING	1	PZ
					VM2284B0	750 SERIES DRIP PROFILE KIT	1	PZ
					VM2295A1	MIND.MAPS TOUCH CONTROL STYLUS KIT	1	PZ
					VM2305A0	6 SERIES DOOR CAP FIXING PAWL	14	PZ
					VM2312A0	6 S. DRIP PROFILE DRAIN LEFT PIPE	1	PZ
					VM2314A0	6 S. DRIP PROFILE CAP	1	PZ
					VM2315B0	S6 INTERNAL GLASS SUPPORT	3	PZ
					VM2410A0	PLATE TO STOP EXTRUDED LED BAR	2	PZ
					VM2505B0	MM PLUS INTERNAL GLASS SUPPORT	2	PZ
					VM2518A0	BOARD COOLING FAN SUPPORT	1	PZ
					VN1179A1	CONTROL BOARD 40X40X20MM 12V COOLING FAN	1	PZ
					VP1076A0	PLUS ONE ZERO HANDLE PIN	1	PZ



COMPONENT			SPARE PART																																																											
Code	Description	Image	Code	Description	Components list																																																									
VT1277A	XEVC-0711-E EXTERNAL GLASS		KDR1262B	0711 -M RIGHT EXTERNAL DOOR	<table border="1"> <thead> <tr> <th>Code</th> <th>Description</th> <th>Qty</th> <th>UOM</th> </tr> </thead> <tbody> <tr> <td>VP1080A0</td> <td>UPPER HINGE CAP FOR LOWER INNER GLASS</td> <td>1</td> <td>PZ</td> </tr> <tr> <td>VP1081A0</td> <td>UPPER HINGE CAP FOR UPPER INNER GLASS</td> <td>1</td> <td>PZ</td> </tr> <tr> <td>VT1277A0</td> <td>XEVC-0711-E EXTERNAL GLASS</td> <td>1</td> <td>PZ</td> </tr> </tbody> </table>	Code	Description	Qty	UOM	VP1080A0	UPPER HINGE CAP FOR LOWER INNER GLASS	1	PZ	VP1081A0	UPPER HINGE CAP FOR UPPER INNER GLASS	1	PZ	VT1277A0	XEVC-0711-E EXTERNAL GLASS	1	PZ																																									
			Code	Description	Qty	UOM																																																								
VP1080A0	UPPER HINGE CAP FOR LOWER INNER GLASS	1	PZ																																																											
VP1081A0	UPPER HINGE CAP FOR UPPER INNER GLASS	1	PZ																																																											
VT1277A0	XEVC-0711-E EXTERNAL GLASS	1	PZ																																																											
KDR1262A	0711 RIGHT EXTERNAL DOOR	<table border="1"> <thead> <tr> <th>Code</th> <th>Description</th> <th>Qty</th> <th>UOM</th> </tr> </thead> <tbody> <tr> <td>0B1111A0</td> <td>XEVC-0711-E LEFT EXT DOOR COLUM</td> <td>1</td> <td>PZ</td> </tr> <tr> <td>0B1112A2</td> <td>0711 RIGHT - DOOR LEFT INT COLUMN</td> <td>1</td> <td>PZ</td> </tr> <tr> <td>0B1113A0</td> <td>XEVC-0711-E RIGHT EXT DOOR COLUM</td> <td>1</td> <td>PZ</td> </tr> <tr> <td>0B1113B0</td> <td></td> <td>1</td> <td>PZ</td> </tr> <tr> <td>0B1113B1</td> <td></td> <td>1</td> <td>PZ</td> </tr> <tr> <td>0B1114A2</td> <td>0711 RIGHT - DOOR RIGHT INT COLUMN</td> <td>1</td> <td>PZ</td> </tr> <tr> <td>0B1122A0</td> <td>750MM DOOR LOWER FRAME SHAPE</td> <td>1</td> <td>PZ</td> </tr> <tr> <td>0B1122A1</td> <td>750MM DOOR LOWER FRAME SHAPE</td> <td>1</td> <td>PZ</td> </tr> <tr> <td>0B1167A0</td> <td>EXT. GLASS SUPPORT PROFILE</td> <td>2</td> <td>PZ</td> </tr> <tr> <td>0B1216A0</td> <td>MM DOUBLE GLASS DOOR 750MM UPPER BEAM</td> <td>1</td> <td>PZ</td> </tr> <tr> <td>0B1216A1</td> <td>MM DOUBLE GLASS DOOR 750MM UPPER BEAM</td> <td>1</td> <td>PZ</td> </tr> <tr> <td>0B1217A1</td> <td>MM DOUBLE GLASS DOOR INT UPPER BEAM 750</td> <td>1</td> <td>PZ</td> </tr> <tr> <td>0H7321A0</td> <td>MM STAINLESS STEEL HANDLE COVE</td> <td>1</td> <td>PZ</td> </tr> <tr> <td>CE1052A1</td> <td>CABLE CONNECTION CONTROL - USB MM 750M</td> <td>1</td> <td>PZ</td> </tr> </tbody> </table>	Code	Description	Qty	UOM	0B1111A0	XEVC-0711-E LEFT EXT DOOR COLUM	1	PZ	0B1112A2	0711 RIGHT - DOOR LEFT INT COLUMN	1	PZ	0B1113A0	XEVC-0711-E RIGHT EXT DOOR COLUM	1	PZ	0B1113B0		1	PZ	0B1113B1		1	PZ	0B1114A2	0711 RIGHT - DOOR RIGHT INT COLUMN	1	PZ	0B1122A0	750MM DOOR LOWER FRAME SHAPE	1	PZ	0B1122A1	750MM DOOR LOWER FRAME SHAPE	1	PZ	0B1167A0	EXT. GLASS SUPPORT PROFILE	2	PZ	0B1216A0	MM DOUBLE GLASS DOOR 750MM UPPER BEAM	1	PZ	0B1216A1	MM DOUBLE GLASS DOOR 750MM UPPER BEAM	1	PZ	0B1217A1	MM DOUBLE GLASS DOOR INT UPPER BEAM 750	1	PZ	0H7321A0	MM STAINLESS STEEL HANDLE COVE	1	PZ	CE1052A1	CABLE CONNECTION CONTROL - USB MM 750M	1	PZ
Code	Description	Qty	UOM																																																											
0B1111A0	XEVC-0711-E LEFT EXT DOOR COLUM	1	PZ																																																											
0B1112A2	0711 RIGHT - DOOR LEFT INT COLUMN	1	PZ																																																											
0B1113A0	XEVC-0711-E RIGHT EXT DOOR COLUM	1	PZ																																																											
0B1113B0		1	PZ																																																											
0B1113B1		1	PZ																																																											
0B1114A2	0711 RIGHT - DOOR RIGHT INT COLUMN	1	PZ																																																											
0B1122A0	750MM DOOR LOWER FRAME SHAPE	1	PZ																																																											
0B1122A1	750MM DOOR LOWER FRAME SHAPE	1	PZ																																																											
0B1167A0	EXT. GLASS SUPPORT PROFILE	2	PZ																																																											
0B1216A0	MM DOUBLE GLASS DOOR 750MM UPPER BEAM	1	PZ																																																											
0B1216A1	MM DOUBLE GLASS DOOR 750MM UPPER BEAM	1	PZ																																																											
0B1217A1	MM DOUBLE GLASS DOOR INT UPPER BEAM 750	1	PZ																																																											
0H7321A0	MM STAINLESS STEEL HANDLE COVE	1	PZ																																																											
CE1052A1	CABLE CONNECTION CONTROL - USB MM 750M	1	PZ																																																											



COMPONENT			SPARE PART																																																																						
Code	Description	Image	Code	Description	Components list																																																																				
VT1277A	XEVC-0711-E EXTERNAL GLASS		KDR1262A	0711 RIGHT EXTERNAL DOOR	<table border="1"> <thead> <tr> <th>Code</th> <th>Description</th> <th>Qty</th> <th>UOM</th> </tr> </thead> <tbody> <tr> <td>CE1053B0</td> <td>MM MICROFIT LED BAR POWER SUPPLY CABL</td> <td>1</td> <td>PZ</td> </tr> <tr> <td>CE1285A0</td> <td>EMI ROUND FERRITE MOD.26438015 02</td> <td>1</td> <td>PZ</td> </tr> <tr> <td>CE1290A0</td> <td>EXTRACTABL E FEMALE TERMINAL CPF 5/4</td> <td>1</td> <td>PZ</td> </tr> <tr> <td>CE1455A0</td> <td>TIP END FITTING</td> <td>4</td> <td>PZ</td> </tr> <tr> <td>CE1725A0</td> <td>ROBOTICS SILICON PIPE 4X0,5 MMO</td> <td>4</td> <td>M</td> </tr> <tr> <td>CE1735A0</td> <td>MINIFIT FEMALE END FITTING</td> <td>4</td> <td>PZ</td> </tr> <tr> <td>CE1755A0</td> <td>4 WAYS MALE MINIFIT CONNECTOR</td> <td>1</td> <td>PZ</td> </tr> <tr> <td>GN1525A0</td> <td>O-RING INT DIAM 9,5 THK 1 NBR 70</td> <td>1</td> <td>PZ</td> </tr> <tr> <td>IP1508A1</td> <td>POLYSTYREN E U SHAPED PROFILE 2000X60X60</td> <td>2</td> <td>M</td> </tr> <tr> <td>LP1020A0</td> <td>6 SERIES L400 LED LIGHT BAR - E583</td> <td>1</td> <td>PZ</td> </tr> <tr> <td>LP1026A0</td> <td>L=583 S6 NO LED LIGHT BAR COVER</td> <td>1</td> <td>PZ</td> </tr> <tr> <td>MG1083A2</td> <td></td> <td>1</td> <td>PZ</td> </tr> <tr> <td>RC1200A0</td> <td>ED=4 WIRE D.=0.5 COMPRESSIO N SPRING</td> <td>4</td> <td>PZ</td> </tr> <tr> <td>SL1170A1</td> <td>S57 BLACK SILICON - 310ML CARTRIDGE</td> <td>11</td> <td>ML</td> </tr> <tr> <td>VE1030A1</td> <td>MAGNET FOR DOOR MICROSWITC H D=22,9MM</td> <td>2</td> <td>PZ</td> </tr> <tr> <td>VI0239A1</td> <td>SELF-TAPPIN G SCREW 4.2X25 TCB+ INOX</td> <td>4</td> <td>PZ</td> </tr> </tbody> </table>	Code	Description	Qty	UOM	CE1053B0	MM MICROFIT LED BAR POWER SUPPLY CABL	1	PZ	CE1285A0	EMI ROUND FERRITE MOD.26438015 02	1	PZ	CE1290A0	EXTRACTABL E FEMALE TERMINAL CPF 5/4	1	PZ	CE1455A0	TIP END FITTING	4	PZ	CE1725A0	ROBOTICS SILICON PIPE 4X0,5 MMO	4	M	CE1735A0	MINIFIT FEMALE END FITTING	4	PZ	CE1755A0	4 WAYS MALE MINIFIT CONNECTOR	1	PZ	GN1525A0	O-RING INT DIAM 9,5 THK 1 NBR 70	1	PZ	IP1508A1	POLYSTYREN E U SHAPED PROFILE 2000X60X60	2	M	LP1020A0	6 SERIES L400 LED LIGHT BAR - E583	1	PZ	LP1026A0	L=583 S6 NO LED LIGHT BAR COVER	1	PZ	MG1083A2		1	PZ	RC1200A0	ED=4 WIRE D.=0.5 COMPRESSIO N SPRING	4	PZ	SL1170A1	S57 BLACK SILICON - 310ML CARTRIDGE	11	ML	VE1030A1	MAGNET FOR DOOR MICROSWITC H D=22,9MM	2	PZ	VI0239A1	SELF-TAPPIN G SCREW 4.2X25 TCB+ INOX	4	PZ
Code	Description	Qty	UOM																																																																						
CE1053B0	MM MICROFIT LED BAR POWER SUPPLY CABL	1	PZ																																																																						
CE1285A0	EMI ROUND FERRITE MOD.26438015 02	1	PZ																																																																						
CE1290A0	EXTRACTABL E FEMALE TERMINAL CPF 5/4	1	PZ																																																																						
CE1455A0	TIP END FITTING	4	PZ																																																																						
CE1725A0	ROBOTICS SILICON PIPE 4X0,5 MMO	4	M																																																																						
CE1735A0	MINIFIT FEMALE END FITTING	4	PZ																																																																						
CE1755A0	4 WAYS MALE MINIFIT CONNECTOR	1	PZ																																																																						
GN1525A0	O-RING INT DIAM 9,5 THK 1 NBR 70	1	PZ																																																																						
IP1508A1	POLYSTYREN E U SHAPED PROFILE 2000X60X60	2	M																																																																						
LP1020A0	6 SERIES L400 LED LIGHT BAR - E583	1	PZ																																																																						
LP1026A0	L=583 S6 NO LED LIGHT BAR COVER	1	PZ																																																																						
MG1083A2		1	PZ																																																																						
RC1200A0	ED=4 WIRE D.=0.5 COMPRESSIO N SPRING	4	PZ																																																																						
SL1170A1	S57 BLACK SILICON - 310ML CARTRIDGE	11	ML																																																																						
VE1030A1	MAGNET FOR DOOR MICROSWITC H D=22,9MM	2	PZ																																																																						
VI0239A1	SELF-TAPPIN G SCREW 4.2X25 TCB+ INOX	4	PZ																																																																						

COMPONENT			SPARE PART																																																																														
Code	Description	Image	Code	Description	Components list																																																																												
VT1277A	XEVC-0711-E EXTERNAL GLASS		KDR1262A	0711 RIGHT EXTERNAL DOOR	<table border="1"> <thead> <tr> <th>Code</th> <th>Description</th> <th>Qty</th> <th>UOM</th> </tr> </thead> <tbody> <tr> <td>VI1034A0</td> <td>STAINLESS STEEL WASHER 8.4X16X1</td> <td>1</td> <td>PZ</td> </tr> <tr> <td>VI1220A1</td> <td>4,2X12 TCB SELF-TAPPIN G SCREW</td> <td>25</td> <td>PZ</td> </tr> <tr> <td>VI1930A0</td> <td>5X25 ST. STEEL SCREW CHIP</td> <td>16</td> <td>PZ</td> </tr> <tr> <td>VI1996A0</td> <td>MSX35 SCREW</td> <td>13</td> <td>PZ</td> </tr> <tr> <td>VI2000A0</td> <td>SCREW M4X22 TCB+ INOX</td> <td>2</td> <td>PZ</td> </tr> <tr> <td>VM1059A1</td> <td>HEAT SHRINK FILM H800</td> <td>1.500</td> <td>M</td> </tr> <tr> <td>VM1182B1</td> <td>E. S. CT BT HANDLE JUNCTION + PIN GUIDE</td> <td>1</td> <td>PZ</td> </tr> <tr> <td>VM1183B0</td> <td>CHEFTOP/BAK ERTOP HANDLE PIN</td> <td>1</td> <td>PZ</td> </tr> <tr> <td>VM1183B1</td> <td>CT BT HANDLE PIN</td> <td>1</td> <td>PZ</td> </tr> <tr> <td>VM1183C0</td> <td>CT BT HANDLE T-SHAPED PIN KIT</td> <td>1</td> <td>PZ</td> </tr> <tr> <td>VM1183C1</td> <td>CT BT HANDLE T-SHAPED PIN KIT</td> <td>1</td> <td>PZ</td> </tr> <tr> <td>VM1490A0</td> <td>CHEFTOP/BAK ERTOP HANDLE SCREWS COVER</td> <td>2</td> <td>PZ</td> </tr> <tr> <td>VM1630A0</td> <td>INTERNAL GLASS PUSHING CAP</td> <td>1</td> <td>PZ</td> </tr> <tr> <td>VM1630A1</td> <td>INTERNAL GLASS PUSHING CAP</td> <td>1</td> <td>PZ</td> </tr> <tr> <td>VM1631A0</td> <td>PLUS INNER GLASS PUSHING CAP</td> <td>2</td> <td>PZ</td> </tr> <tr> <td>VM1695A0</td> <td>HANDLE POSITION PIN</td> <td>4</td> <td>PZ</td> </tr> <tr> <td>VM2245A0</td> <td>HANDLE SHAFT WITH LATCH</td> <td>1</td> <td>PZ</td> </tr> <tr> <td>VM2247A0</td> <td>HANDLE SHAFT COVER VM2245-2246</td> <td>1</td> <td>PZ</td> </tr> </tbody> </table>	Code	Description	Qty	UOM	VI1034A0	STAINLESS STEEL WASHER 8.4X16X1	1	PZ	VI1220A1	4,2X12 TCB SELF-TAPPIN G SCREW	25	PZ	VI1930A0	5X25 ST. STEEL SCREW CHIP	16	PZ	VI1996A0	MSX35 SCREW	13	PZ	VI2000A0	SCREW M4X22 TCB+ INOX	2	PZ	VM1059A1	HEAT SHRINK FILM H800	1.500	M	VM1182B1	E. S. CT BT HANDLE JUNCTION + PIN GUIDE	1	PZ	VM1183B0	CHEFTOP/BAK ERTOP HANDLE PIN	1	PZ	VM1183B1	CT BT HANDLE PIN	1	PZ	VM1183C0	CT BT HANDLE T-SHAPED PIN KIT	1	PZ	VM1183C1	CT BT HANDLE T-SHAPED PIN KIT	1	PZ	VM1490A0	CHEFTOP/BAK ERTOP HANDLE SCREWS COVER	2	PZ	VM1630A0	INTERNAL GLASS PUSHING CAP	1	PZ	VM1630A1	INTERNAL GLASS PUSHING CAP	1	PZ	VM1631A0	PLUS INNER GLASS PUSHING CAP	2	PZ	VM1695A0	HANDLE POSITION PIN	4	PZ	VM2245A0	HANDLE SHAFT WITH LATCH	1	PZ	VM2247A0	HANDLE SHAFT COVER VM2245-2246	1	PZ
Code	Description	Qty	UOM																																																																														
VI1034A0	STAINLESS STEEL WASHER 8.4X16X1	1	PZ																																																																														
VI1220A1	4,2X12 TCB SELF-TAPPIN G SCREW	25	PZ																																																																														
VI1930A0	5X25 ST. STEEL SCREW CHIP	16	PZ																																																																														
VI1996A0	MSX35 SCREW	13	PZ																																																																														
VI2000A0	SCREW M4X22 TCB+ INOX	2	PZ																																																																														
VM1059A1	HEAT SHRINK FILM H800	1.500	M																																																																														
VM1182B1	E. S. CT BT HANDLE JUNCTION + PIN GUIDE	1	PZ																																																																														
VM1183B0	CHEFTOP/BAK ERTOP HANDLE PIN	1	PZ																																																																														
VM1183B1	CT BT HANDLE PIN	1	PZ																																																																														
VM1183C0	CT BT HANDLE T-SHAPED PIN KIT	1	PZ																																																																														
VM1183C1	CT BT HANDLE T-SHAPED PIN KIT	1	PZ																																																																														
VM1490A0	CHEFTOP/BAK ERTOP HANDLE SCREWS COVER	2	PZ																																																																														
VM1630A0	INTERNAL GLASS PUSHING CAP	1	PZ																																																																														
VM1630A1	INTERNAL GLASS PUSHING CAP	1	PZ																																																																														
VM1631A0	PLUS INNER GLASS PUSHING CAP	2	PZ																																																																														
VM1695A0	HANDLE POSITION PIN	4	PZ																																																																														
VM2245A0	HANDLE SHAFT WITH LATCH	1	PZ																																																																														
VM2247A0	HANDLE SHAFT COVER VM2245-2246	1	PZ																																																																														



COMPONENT			SPARE PART																																																																															
Code	Description	Image	Code	Description	Components list																																																																													
VT1277A	XEVC-0711-E EXTERNAL GLASS		KDR1262A	0711 RIGHT EXTERNAL DOOR	<table border="1"> <thead> <tr> <th>Code</th> <th>Description</th> <th>Qty</th> <th>UOM</th> </tr> </thead> <tbody> <tr> <td>VM2247B0</td> <td>HANDLE SHAFT COVER VM2245-2246</td> <td>1</td> <td>PZ</td> </tr> <tr> <td>VM2248B0</td> <td>HANDLE WITH LATCH CLOSING KEY</td> <td>1</td> <td>PZ</td> </tr> <tr> <td>VM2259A1</td> <td>6 SERIES DOOR LOWER LEFT CAP</td> <td>1</td> <td>PZ</td> </tr> <tr> <td>VM2260A1</td> <td>6 SERIES DOOR UPPER LEFT CAP</td> <td>1</td> <td>PZ</td> </tr> <tr> <td>VM2262A1</td> <td>6 SERIES DOOR UPPER RIGHT CAP</td> <td>1</td> <td>PZ</td> </tr> <tr> <td>VM2267A0</td> <td>INTERNAL GLASS LOCKING SYSTEM SLIDER</td> <td>2</td> <td>PZ</td> </tr> <tr> <td>VM2268A0</td> <td>DOOR MAGNET COVER</td> <td>2</td> <td>PZ</td> </tr> <tr> <td>VM2269A0</td> <td>INTERNAL GLASS LOCKING SYSTEM CAP</td> <td>2</td> <td>PZ</td> </tr> <tr> <td>VM2274A0</td> <td>GROOVED BUSHING</td> <td>1</td> <td>PZ</td> </tr> <tr> <td>VM2275A0</td> <td>SMOOTH BUSHING</td> <td>1</td> <td>PZ</td> </tr> <tr> <td>VM2284A0</td> <td>750 SERIES DRIP PROFILE</td> <td>1</td> <td>PZ</td> </tr> <tr> <td>VM2295A0</td> <td>STYLUS PEN FOR MM</td> <td>1</td> <td>PZ</td> </tr> <tr> <td>VM2305A0</td> <td>6 SERIES DOOR CAP FIXING PAWL</td> <td>14</td> <td>PZ</td> </tr> <tr> <td>VM2312A0</td> <td>6 S. DRIP PROFILE DRAIN LEFT PIPE</td> <td>1</td> <td>PZ</td> </tr> <tr> <td>VM2313A0</td> <td>TUBE DX DISCHARGE DRIP MM</td> <td>1</td> <td>PZ</td> </tr> <tr> <td>VM2314A0</td> <td>6 S. DRIP PROFILE CAP</td> <td>1</td> <td>PZ</td> </tr> <tr> <td>VM2315A0</td> <td>MIND.MAPS INTERNAL GLASS CAP SUPPORT</td> <td>1</td> <td>PZ</td> </tr> <tr> <td>VM2371A0</td> <td>DOUBLE GLASS DOOR PUSHING BRACKET</td> <td>2</td> <td>PZ</td> </tr> </tbody> </table>	Code	Description	Qty	UOM	VM2247B0	HANDLE SHAFT COVER VM2245-2246	1	PZ	VM2248B0	HANDLE WITH LATCH CLOSING KEY	1	PZ	VM2259A1	6 SERIES DOOR LOWER LEFT CAP	1	PZ	VM2260A1	6 SERIES DOOR UPPER LEFT CAP	1	PZ	VM2262A1	6 SERIES DOOR UPPER RIGHT CAP	1	PZ	VM2267A0	INTERNAL GLASS LOCKING SYSTEM SLIDER	2	PZ	VM2268A0	DOOR MAGNET COVER	2	PZ	VM2269A0	INTERNAL GLASS LOCKING SYSTEM CAP	2	PZ	VM2274A0	GROOVED BUSHING	1	PZ	VM2275A0	SMOOTH BUSHING	1	PZ	VM2284A0	750 SERIES DRIP PROFILE	1	PZ	VM2295A0	STYLUS PEN FOR MM	1	PZ	VM2305A0	6 SERIES DOOR CAP FIXING PAWL	14	PZ	VM2312A0	6 S. DRIP PROFILE DRAIN LEFT PIPE	1	PZ	VM2313A0	TUBE DX DISCHARGE DRIP MM	1	PZ	VM2314A0	6 S. DRIP PROFILE CAP	1	PZ	VM2315A0	MIND.MAPS INTERNAL GLASS CAP SUPPORT	1	PZ	VM2371A0	DOUBLE GLASS DOOR PUSHING BRACKET	2	PZ	
Code	Description	Qty	UOM																																																																															
VM2247B0	HANDLE SHAFT COVER VM2245-2246	1	PZ																																																																															
VM2248B0	HANDLE WITH LATCH CLOSING KEY	1	PZ																																																																															
VM2259A1	6 SERIES DOOR LOWER LEFT CAP	1	PZ																																																																															
VM2260A1	6 SERIES DOOR UPPER LEFT CAP	1	PZ																																																																															
VM2262A1	6 SERIES DOOR UPPER RIGHT CAP	1	PZ																																																																															
VM2267A0	INTERNAL GLASS LOCKING SYSTEM SLIDER	2	PZ																																																																															
VM2268A0	DOOR MAGNET COVER	2	PZ																																																																															
VM2269A0	INTERNAL GLASS LOCKING SYSTEM CAP	2	PZ																																																																															
VM2274A0	GROOVED BUSHING	1	PZ																																																																															
VM2275A0	SMOOTH BUSHING	1	PZ																																																																															
VM2284A0	750 SERIES DRIP PROFILE	1	PZ																																																																															
VM2295A0	STYLUS PEN FOR MM	1	PZ																																																																															
VM2305A0	6 SERIES DOOR CAP FIXING PAWL	14	PZ																																																																															
VM2312A0	6 S. DRIP PROFILE DRAIN LEFT PIPE	1	PZ																																																																															
VM2313A0	TUBE DX DISCHARGE DRIP MM	1	PZ																																																																															
VM2314A0	6 S. DRIP PROFILE CAP	1	PZ																																																																															
VM2315A0	MIND.MAPS INTERNAL GLASS CAP SUPPORT	1	PZ																																																																															
VM2371A0	DOUBLE GLASS DOOR PUSHING BRACKET	2	PZ																																																																															





COMPONENT			SPARE PART																																																		
Code	Description	Image	Code	Description	Components list																																																
VT1277A	XEVC-0711-E EXTERNAL GLASS		KDR1262A	0711 RIGHT EXTERNAL DOOR	<table border="1"> <thead> <tr> <th>Code</th> <th>Description</th> <th>Qty</th> <th>UOM</th> </tr> </thead> <tbody> <tr> <td>VM2371A0</td> <td>DOUBLE GLASS DOOR PUSHING BRACKET</td> <td>2</td> <td>PZ</td> </tr> <tr> <td>VM2410A0</td> <td>PLATE TO STOP EXTRUDED LED BAR</td> <td>2</td> <td>PZ</td> </tr> <tr> <td>VM2410A0</td> <td>PLATE TO STOP EXTRUDED LED BAR</td> <td>2</td> <td>PZ</td> </tr> <tr> <td>VM2505A0</td> <td>MM PLUS INTERNAL GLASS SUPPORT</td> <td>2</td> <td>PZ</td> </tr> <tr> <td>VM2518A0</td> <td>BOARD COOLING FAN SUPPORT</td> <td>1</td> <td>PZ</td> </tr> <tr> <td>VM2518A0</td> <td>BOARD COOLING FAN SUPPORT</td> <td>1</td> <td>PZ</td> </tr> <tr> <td>VN1179A0</td> <td>CONTROL BOARD 40X40X20MM 12V COOLING FAN</td> <td>1</td> <td>PZ</td> </tr> <tr> <td>VN1179A0</td> <td>CONTROL BOARD 40X40X20MM 12V COOLING FAN</td> <td>1</td> <td>PZ</td> </tr> <tr> <td>VN1179A1</td> <td>CONTROL BOARD 40X40X20MM 12V COOLING FAN</td> <td>1</td> <td>PZ</td> </tr> <tr> <td>VT1277A0</td> <td>XEVC-0711-E EXTERNAL GLASS</td> <td>1</td> <td>PZ</td> </tr> <tr> <td>VT1277A0</td> <td>XEVC-0711-E EXTERNAL GLASS</td> <td>1</td> <td>PZ</td> </tr> </tbody> </table>	Code	Description	Qty	UOM	VM2371A0	DOUBLE GLASS DOOR PUSHING BRACKET	2	PZ	VM2410A0	PLATE TO STOP EXTRUDED LED BAR	2	PZ	VM2410A0	PLATE TO STOP EXTRUDED LED BAR	2	PZ	VM2505A0	MM PLUS INTERNAL GLASS SUPPORT	2	PZ	VM2518A0	BOARD COOLING FAN SUPPORT	1	PZ	VM2518A0	BOARD COOLING FAN SUPPORT	1	PZ	VN1179A0	CONTROL BOARD 40X40X20MM 12V COOLING FAN	1	PZ	VN1179A0	CONTROL BOARD 40X40X20MM 12V COOLING FAN	1	PZ	VN1179A1	CONTROL BOARD 40X40X20MM 12V COOLING FAN	1	PZ	VT1277A0	XEVC-0711-E EXTERNAL GLASS	1	PZ	VT1277A0	XEVC-0711-E EXTERNAL GLASS	1	PZ
					Code	Description	Qty	UOM																																													
					VM2371A0	DOUBLE GLASS DOOR PUSHING BRACKET	2	PZ																																													
					VM2410A0	PLATE TO STOP EXTRUDED LED BAR	2	PZ																																													
					VM2410A0	PLATE TO STOP EXTRUDED LED BAR	2	PZ																																													
					VM2505A0	MM PLUS INTERNAL GLASS SUPPORT	2	PZ																																													
					VM2518A0	BOARD COOLING FAN SUPPORT	1	PZ																																													
					VM2518A0	BOARD COOLING FAN SUPPORT	1	PZ																																													
					VN1179A0	CONTROL BOARD 40X40X20MM 12V COOLING FAN	1	PZ																																													
					VN1179A0	CONTROL BOARD 40X40X20MM 12V COOLING FAN	1	PZ																																													
VN1179A1	CONTROL BOARD 40X40X20MM 12V COOLING FAN	1	PZ																																																		
VT1277A0	XEVC-0711-E EXTERNAL GLASS	1	PZ																																																		
VT1277A0	XEVC-0711-E EXTERNAL GLASS	1	PZ																																																		
LP1020A	6 SERIES L400 LED LIGHT BAR - E583		KLP1020A	L400 E583 LED LIGHT BAR KIT	<table border="1"> <thead> <tr> <th>Code</th> <th>Description</th> <th>Qty</th> <th>UOM</th> </tr> </thead> <tbody> <tr> <td>IP1385A1</td> <td>CORNER POLYSTYREN E PACKING 110X80X2000</td> <td>1.240</td> <td>M</td> </tr> <tr> <td>LP1020A0</td> <td>6 SERIES L400 LED LIGHT BAR - E583</td> <td>1</td> <td>PZ</td> </tr> <tr> <td>VM1059A1</td> <td>HEAT SHRINK FILM H800</td> <td>1.240</td> <td>M</td> </tr> </tbody> </table>	Code	Description	Qty	UOM	IP1385A1	CORNER POLYSTYREN E PACKING 110X80X2000	1.240	M	LP1020A0	6 SERIES L400 LED LIGHT BAR - E583	1	PZ	VM1059A1	HEAT SHRINK FILM H800	1.240	M																																
					Code	Description	Qty	UOM																																													
					IP1385A1	CORNER POLYSTYREN E PACKING 110X80X2000	1.240	M																																													
LP1020A0	6 SERIES L400 LED LIGHT BAR - E583	1	PZ																																																		
VM1059A1	HEAT SHRINK FILM H800	1.240	M																																																		

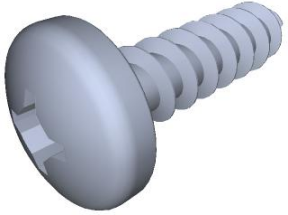
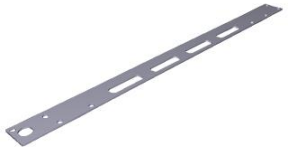

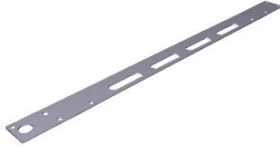

COMPONENT			SPARE PART																						
Code	Description	Image	Code	Description	Components list																				
VM2410A	PLATE TO STOP EXTRUDED LED BAR		KVM2410A	PLATE TO STOP EXTRUDED LED BAR 2P KIT	<table border="1"> <thead> <tr> <th>Code</th> <th>Description</th> <th>Qty</th> <th>UOM</th> </tr> </thead> <tbody> <tr> <td>0B1190A0</td> <td>PLATE TO STOP EXTRUDED LED BAR</td> <td>2</td> <td>PZ</td> </tr> <tr> <td>VM1224A0</td> <td>65MY 220MM 2 COLOURS SHRINK TUBE</td> <td>0.200</td> <td>M</td> </tr> <tr> <td>VM2410A0</td> <td>PLATE TO STOP EXTRUDED LED BAR</td> <td>2</td> <td>PZ</td> </tr> <tr> <td>VM2410A0</td> <td>PLATE TO STOP EXTRUDED LED BAR</td> <td>2</td> <td>PZ</td> </tr> </tbody> </table>	Code	Description	Qty	UOM	0B1190A0	PLATE TO STOP EXTRUDED LED BAR	2	PZ	VM1224A0	65MY 220MM 2 COLOURS SHRINK TUBE	0.200	M	VM2410A0	PLATE TO STOP EXTRUDED LED BAR	2	PZ	VM2410A0	PLATE TO STOP EXTRUDED LED BAR	2	PZ
Code	Description	Qty	UOM																						
0B1190A0	PLATE TO STOP EXTRUDED LED BAR	2	PZ																						
VM1224A0	65MY 220MM 2 COLOURS SHRINK TUBE	0.200	M																						
VM2410A0	PLATE TO STOP EXTRUDED LED BAR	2	PZ																						
VM2410A0	PLATE TO STOP EXTRUDED LED BAR	2	PZ																						
VI1074A	4X16 SCREW FOR PLASTIC		VI1074A0	4X16 SCREW FOR PLASTIC																					
0B1111A	XEVC-0711-E LEFT EXT DOOR COLUMN		0B1111A0	XEVC-0711-E LEFT EXT DOOR COLUMN																					
0B1167A	EXT. GLASS SUPPORT PROFILE		OUTOFPRODUCTIO	ITEM OUT OF PRODUCTION																					





COMPONENT			SPARE PART																																																																										
Code	Description	Image	Code	Description	Components list																																																																								
VI1930A	ST. STEEL 5X20 CHIP SCREW		VI1930A1	ST. STEEL 5X20 CHIP SCREW																																																																									
OB1122B			K0B1122BR	CHEFTOP MM -M RIGHT DOOR LOWER BEAM KIT	<table border="1"> <thead> <tr> <th>Code</th> <th>Description</th> <th>Qty</th> <th>UOM</th> </tr> </thead> <tbody> <tr> <td>OB1122B0</td> <td></td> <td>1</td> <td>PZ</td> </tr> <tr> <td>RC1200A0</td> <td>ED=4 WIRE D.=0.5 COMPRESSIO N SPRING</td> <td>2</td> <td>PZ</td> </tr> <tr> <td>VE1030A1</td> <td>MAGNET FOR DOOR MICROSWITC H D=22,9MM</td> <td>1</td> <td>PZ</td> </tr> <tr> <td>VI1103A0</td> <td>40X12 TBSP SCREW FOR PLASTIC</td> <td>1</td> <td>PZ</td> </tr> <tr> <td>VI1220A1</td> <td>4,2X12 TCB SELF-TAPPIN G SCREW</td> <td>1</td> <td>PZ</td> </tr> <tr> <td>VI1930A1</td> <td>ST. STEEL 5X20 CHIP SCREW</td> <td>8</td> <td>PZ</td> </tr> <tr> <td>VI1996A0</td> <td>M5X35 SCREW</td> <td>7</td> <td>PZ</td> </tr> <tr> <td>VM1794A0</td> <td>250X4.8 PA66 BLACK CLAMP</td> <td>2</td> <td>PZ</td> </tr> <tr> <td>VM2103A0</td> <td>CLAMP LOCK</td> <td>2</td> <td>PZ</td> </tr> <tr> <td>VM2259B0</td> <td></td> <td>1</td> <td>PZ</td> </tr> <tr> <td>VM2261B0</td> <td></td> <td>1</td> <td>PZ</td> </tr> <tr> <td>VM2267A0</td> <td>INTERNAL GLASS LOCKING SYSTEM SLIDER</td> <td>1</td> <td>PZ</td> </tr> <tr> <td>VM2268A0</td> <td>DOOR MAGNET COVER</td> <td>1</td> <td>PZ</td> </tr> <tr> <td>VM2269B0</td> <td>INNER GLASS FIXING CAP</td> <td>1</td> <td>PZ</td> </tr> <tr> <td>VM2274A0</td> <td>GROOVED BUSHING</td> <td>1</td> <td>PZ</td> </tr> <tr> <td>VM2305A0</td> <td>6 SERIES DOOR CAP FIXING PAWL</td> <td>7</td> <td>PZ</td> </tr> <tr> <td>VP1080A0</td> <td>UPPER HINGE CAP FOR LOWER INNER GLASS</td> <td>1</td> <td>PZ</td> </tr> </tbody> </table>	Code	Description	Qty	UOM	OB1122B0		1	PZ	RC1200A0	ED=4 WIRE D.=0.5 COMPRESSIO N SPRING	2	PZ	VE1030A1	MAGNET FOR DOOR MICROSWITC H D=22,9MM	1	PZ	VI1103A0	40X12 TBSP SCREW FOR PLASTIC	1	PZ	VI1220A1	4,2X12 TCB SELF-TAPPIN G SCREW	1	PZ	VI1930A1	ST. STEEL 5X20 CHIP SCREW	8	PZ	VI1996A0	M5X35 SCREW	7	PZ	VM1794A0	250X4.8 PA66 BLACK CLAMP	2	PZ	VM2103A0	CLAMP LOCK	2	PZ	VM2259B0		1	PZ	VM2261B0		1	PZ	VM2267A0	INTERNAL GLASS LOCKING SYSTEM SLIDER	1	PZ	VM2268A0	DOOR MAGNET COVER	1	PZ	VM2269B0	INNER GLASS FIXING CAP	1	PZ	VM2274A0	GROOVED BUSHING	1	PZ	VM2305A0	6 SERIES DOOR CAP FIXING PAWL	7	PZ	VP1080A0	UPPER HINGE CAP FOR LOWER INNER GLASS	1	PZ
Code	Description	Qty	UOM																																																																										
OB1122B0		1	PZ																																																																										
RC1200A0	ED=4 WIRE D.=0.5 COMPRESSIO N SPRING	2	PZ																																																																										
VE1030A1	MAGNET FOR DOOR MICROSWITC H D=22,9MM	1	PZ																																																																										
VI1103A0	40X12 TBSP SCREW FOR PLASTIC	1	PZ																																																																										
VI1220A1	4,2X12 TCB SELF-TAPPIN G SCREW	1	PZ																																																																										
VI1930A1	ST. STEEL 5X20 CHIP SCREW	8	PZ																																																																										
VI1996A0	M5X35 SCREW	7	PZ																																																																										
VM1794A0	250X4.8 PA66 BLACK CLAMP	2	PZ																																																																										
VM2103A0	CLAMP LOCK	2	PZ																																																																										
VM2259B0		1	PZ																																																																										
VM2261B0		1	PZ																																																																										
VM2267A0	INTERNAL GLASS LOCKING SYSTEM SLIDER	1	PZ																																																																										
VM2268A0	DOOR MAGNET COVER	1	PZ																																																																										
VM2269B0	INNER GLASS FIXING CAP	1	PZ																																																																										
VM2274A0	GROOVED BUSHING	1	PZ																																																																										
VM2305A0	6 SERIES DOOR CAP FIXING PAWL	7	PZ																																																																										
VP1080A0	UPPER HINGE CAP FOR LOWER INNER GLASS	1	PZ																																																																										

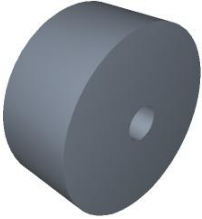
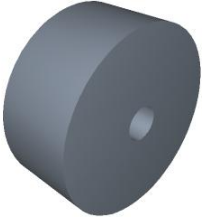





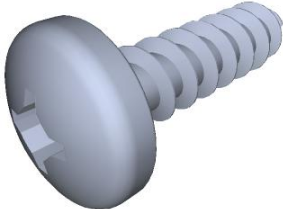
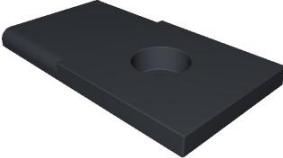

COMPONENT			SPARE PART																																																																										
Code	Description	Image	Code	Description	Components list																																																																								
0B1122B			K0B1122BL	CHEFTOP MM -M LEFT DOOR LOWER BEAM KIT	<table border="1"> <thead> <tr> <th>Code</th> <th>Description</th> <th>Qty</th> <th>UOM</th> </tr> </thead> <tbody> <tr> <td>0B1122B0</td> <td></td> <td>1</td> <td>PZ</td> </tr> <tr> <td>RC1200A0</td> <td>ED=4 WIRE D.=0.5 COMPRESSIO N SPRING</td> <td>2</td> <td>PZ</td> </tr> <tr> <td>VE1030A1</td> <td>MAGNET FOR DOOR MICROSWITC H D=22,9MM</td> <td>1</td> <td>PZ</td> </tr> <tr> <td>VI1103A0</td> <td>40X12 TBSP SCREW FOR PLASTIC</td> <td>1</td> <td>PZ</td> </tr> <tr> <td>VI1220A1</td> <td>4,2X12 TCB SELF-TAPPIN G SCREW</td> <td>1</td> <td>PZ</td> </tr> <tr> <td>VI1930A1</td> <td>ST. STEEL 5X20 CHIP SCREW</td> <td>8</td> <td>PZ</td> </tr> <tr> <td>VI1996A0</td> <td>M5X35 SCREW</td> <td>6</td> <td>PZ</td> </tr> <tr> <td>VM1794A0</td> <td>250X4.8 PA66 BLACK CLAMP</td> <td>2</td> <td>PZ</td> </tr> <tr> <td>VM2103A0</td> <td>CLAMP LOCK</td> <td>2</td> <td>PZ</td> </tr> <tr> <td>VM2267A0</td> <td>INTERNAL GLASS LOCKING SYSTEM SLIDER</td> <td>1</td> <td>PZ</td> </tr> <tr> <td>VM2268A0</td> <td>DOOR MAGNET COVER</td> <td>1</td> <td>PZ</td> </tr> <tr> <td>VM2269B0</td> <td>INNER GLASS FIXING CAP</td> <td>1</td> <td>PZ</td> </tr> <tr> <td>VM2274A0</td> <td>GROOVED BUSHING</td> <td>1</td> <td>PZ</td> </tr> <tr> <td>VM2305A0</td> <td>6 SERIES DOOR CAP FIXING PAWL</td> <td>7</td> <td>PZ</td> </tr> <tr> <td>VM2384B0</td> <td></td> <td>1</td> <td>PZ</td> </tr> <tr> <td>VM2386B0</td> <td>MM -M LEFT DOOR LEFT LOWER CAP KI</td> <td>1</td> <td>PZ</td> </tr> <tr> <td>VP1081A0</td> <td>UPPER HINGE CAP FOR UPPER INNER GLASS</td> <td>1</td> <td>PZ</td> </tr> </tbody> </table>	Code	Description	Qty	UOM	0B1122B0		1	PZ	RC1200A0	ED=4 WIRE D.=0.5 COMPRESSIO N SPRING	2	PZ	VE1030A1	MAGNET FOR DOOR MICROSWITC H D=22,9MM	1	PZ	VI1103A0	40X12 TBSP SCREW FOR PLASTIC	1	PZ	VI1220A1	4,2X12 TCB SELF-TAPPIN G SCREW	1	PZ	VI1930A1	ST. STEEL 5X20 CHIP SCREW	8	PZ	VI1996A0	M5X35 SCREW	6	PZ	VM1794A0	250X4.8 PA66 BLACK CLAMP	2	PZ	VM2103A0	CLAMP LOCK	2	PZ	VM2267A0	INTERNAL GLASS LOCKING SYSTEM SLIDER	1	PZ	VM2268A0	DOOR MAGNET COVER	1	PZ	VM2269B0	INNER GLASS FIXING CAP	1	PZ	VM2274A0	GROOVED BUSHING	1	PZ	VM2305A0	6 SERIES DOOR CAP FIXING PAWL	7	PZ	VM2384B0		1	PZ	VM2386B0	MM -M LEFT DOOR LEFT LOWER CAP KI	1	PZ	VP1081A0	UPPER HINGE CAP FOR UPPER INNER GLASS	1	PZ
Code	Description	Qty	UOM																																																																										
0B1122B0		1	PZ																																																																										
RC1200A0	ED=4 WIRE D.=0.5 COMPRESSIO N SPRING	2	PZ																																																																										
VE1030A1	MAGNET FOR DOOR MICROSWITC H D=22,9MM	1	PZ																																																																										
VI1103A0	40X12 TBSP SCREW FOR PLASTIC	1	PZ																																																																										
VI1220A1	4,2X12 TCB SELF-TAPPIN G SCREW	1	PZ																																																																										
VI1930A1	ST. STEEL 5X20 CHIP SCREW	8	PZ																																																																										
VI1996A0	M5X35 SCREW	6	PZ																																																																										
VM1794A0	250X4.8 PA66 BLACK CLAMP	2	PZ																																																																										
VM2103A0	CLAMP LOCK	2	PZ																																																																										
VM2267A0	INTERNAL GLASS LOCKING SYSTEM SLIDER	1	PZ																																																																										
VM2268A0	DOOR MAGNET COVER	1	PZ																																																																										
VM2269B0	INNER GLASS FIXING CAP	1	PZ																																																																										
VM2274A0	GROOVED BUSHING	1	PZ																																																																										
VM2305A0	6 SERIES DOOR CAP FIXING PAWL	7	PZ																																																																										
VM2384B0		1	PZ																																																																										
VM2386B0	MM -M LEFT DOOR LEFT LOWER CAP KI	1	PZ																																																																										
VP1081A0	UPPER HINGE CAP FOR UPPER INNER GLASS	1	PZ																																																																										

COMPONENT			SPARE PART														
Code	Description	Image	Code	Description	Components list												
0B1217A	MM DOUBLE GLASS DOOR INT UPPER BEAM 750		OUTOFPRODUCTIO	ITEM OUT OF PRODUCTION													
VM2312A	6 S. DRIP PROFILE DRAIN LEFT PIPE		KVM2312A	M.M. DRIP TRAY LEFT DRAIN PIPE KI	<table border="1"> <thead> <tr> <th>Code</th> <th>Description</th> <th>Qty</th> <th>UOM</th> </tr> </thead> <tbody> <tr> <td>VM1224A0</td> <td>65MY 220MM 2 COLOURS SHRINK TUBE</td> <td>0.150</td> <td>M</td> </tr> <tr> <td>VM2312A0</td> <td>6 S. DRIP PROFILE DRAIN LEFT PIPE</td> <td>1</td> <td>PZ</td> </tr> </tbody> </table>	Code	Description	Qty	UOM	VM1224A0	65MY 220MM 2 COLOURS SHRINK TUBE	0.150	M	VM2312A0	6 S. DRIP PROFILE DRAIN LEFT PIPE	1	PZ
Code	Description	Qty	UOM														
VM1224A0	65MY 220MM 2 COLOURS SHRINK TUBE	0.150	M														
VM2312A0	6 S. DRIP PROFILE DRAIN LEFT PIPE	1	PZ														
VM2314A	6 S. DRIP PROFILE CAP		KVM2314A	MIND.MAPS DRIP TRAY CAP	<table border="1"> <thead> <tr> <th>Code</th> <th>Description</th> <th>Qty</th> <th>UOM</th> </tr> </thead> <tbody> <tr> <td>VM1224A0</td> <td>65MY 220MM 2 COLOURS SHRINK TUBE</td> <td>0.200</td> <td>M</td> </tr> <tr> <td>VM2314A0</td> <td>6 S. DRIP PROFILE CAP</td> <td>1</td> <td>PZ</td> </tr> </tbody> </table>	Code	Description	Qty	UOM	VM1224A0	65MY 220MM 2 COLOURS SHRINK TUBE	0.200	M	VM2314A0	6 S. DRIP PROFILE CAP	1	PZ
Code	Description	Qty	UOM														
VM1224A0	65MY 220MM 2 COLOURS SHRINK TUBE	0.200	M														
VM2314A0	6 S. DRIP PROFILE CAP	1	PZ														
VM2284B	750 SERIES DRIP PROFILE KIT		KVM2284B	750 -M SERIES DRIP PROFILE KIT	<table border="1"> <thead> <tr> <th>Code</th> <th>Description</th> <th>Qty</th> <th>UOM</th> </tr> </thead> <tbody> <tr> <td>VM2284B0</td> <td>750 SERIES DRIP PROFILE KIT</td> <td>1</td> <td>PZ</td> </tr> </tbody> </table>	Code	Description	Qty	UOM	VM2284B0	750 SERIES DRIP PROFILE KIT	1	PZ				
Code	Description	Qty	UOM														
VM2284B0	750 SERIES DRIP PROFILE KIT	1	PZ														
CE1285A	EMI ROUND FERRITE MOD.2643801502		CE1285A0	EMI ROUND FERRITE MOD.2643801502													

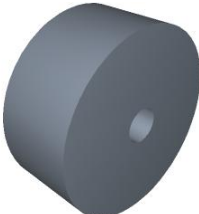

COMPONENT			SPARE PART																		
Code	Description	Image	Code	Description	Components list																
CE1097A	4M SIHF 4 POLES MICROFIT CANBUS		KCE1097A	4 POLES MICROFIT 4 METRES BUS CABLE KIT	<table border="1"> <thead> <tr> <th>Code</th> <th>Description</th> <th>Qty</th> <th>UOM</th> </tr> </thead> <tbody> <tr> <td>CE1097A0</td> <td>4M SIHF 4 POLES MICROFIT CANBUS</td> <td>1</td> <td>PZ</td> </tr> <tr> <td>CE1285A0</td> <td>EMI ROUND FERRITE MOD.26438015 02</td> <td>1</td> <td>PZ</td> </tr> <tr> <td>VM1224A0</td> <td>65MY 220MM 2 COLOURS SHRINK TUBE</td> <td>0.300</td> <td>M</td> </tr> </tbody> </table>	Code	Description	Qty	UOM	CE1097A0	4M SIHF 4 POLES MICROFIT CANBUS	1	PZ	CE1285A0	EMI ROUND FERRITE MOD.26438015 02	1	PZ	VM1224A0	65MY 220MM 2 COLOURS SHRINK TUBE	0.300	M
Code	Description	Qty	UOM																		
CE1097A0	4M SIHF 4 POLES MICROFIT CANBUS	1	PZ																		
CE1285A0	EMI ROUND FERRITE MOD.26438015 02	1	PZ																		
VM1224A0	65MY 220MM 2 COLOURS SHRINK TUBE	0.300	M																		
VM2305A	6 SERIES DOOR CAP FIXING PAWL		KVM2305A	MM FIXING DOOR THUB SCREWS 10 PCS KIT	<table border="1"> <thead> <tr> <th>Code</th> <th>Description</th> <th>Qty</th> <th>UOM</th> </tr> </thead> <tbody> <tr> <td>VM1224A0</td> <td>65MY 220MM 2 COLOURS SHRINK TUBE</td> <td>0.200</td> <td>M</td> </tr> <tr> <td>VM2305A0</td> <td>6 SERIES DOOR CAP FIXING PAWL</td> <td>10</td> <td>PZ</td> </tr> </tbody> </table>	Code	Description	Qty	UOM	VM1224A0	65MY 220MM 2 COLOURS SHRINK TUBE	0.200	M	VM2305A0	6 SERIES DOOR CAP FIXING PAWL	10	PZ				
Code	Description	Qty	UOM																		
VM1224A0	65MY 220MM 2 COLOURS SHRINK TUBE	0.200	M																		
VM2305A0	6 SERIES DOOR CAP FIXING PAWL	10	PZ																		
VE1030A	MAGNET FOR DOOR MICROSWITCH D=22,9MM		KVE1030A	2 PCS MAGNET KIT FOR DOOR SWITCH	<table border="1"> <thead> <tr> <th>Code</th> <th>Description</th> <th>Qty</th> <th>UOM</th> </tr> </thead> <tbody> <tr> <td>VE1030A1</td> <td>MAGNET FOR DOOR MICROSWITCH H D=22,9MM</td> <td>2</td> <td>PZ</td> </tr> <tr> <td>VM1224A0</td> <td>65MY 220MM 2 COLOURS SHRINK TUBE</td> <td>0.150</td> <td>M</td> </tr> </tbody> </table>	Code	Description	Qty	UOM	VE1030A1	MAGNET FOR DOOR MICROSWITCH H D=22,9MM	2	PZ	VM1224A0	65MY 220MM 2 COLOURS SHRINK TUBE	0.150	M				
Code	Description	Qty	UOM																		
VE1030A1	MAGNET FOR DOOR MICROSWITCH H D=22,9MM	2	PZ																		
VM1224A0	65MY 220MM 2 COLOURS SHRINK TUBE	0.150	M																		
VE1030A	MAGNET FOR DOOR MICROSWITCH D=22,9MM		KVE1020A	MICROSWITCH KIT	<table border="1"> <thead> <tr> <th>Code</th> <th>Description</th> <th>Qty</th> <th>UOM</th> </tr> </thead> <tbody> <tr> <td>VE1020A2</td> <td>MAGNETIC DOOR MICROSWITCH</td> <td>1</td> <td>PZ</td> </tr> <tr> <td>VE1030A1</td> <td>MAGNET FOR DOOR MICROSWITCH H D=22,9MM</td> <td>4</td> <td>PZ</td> </tr> <tr> <td>VM1224A0</td> <td>65MY 220MM 2 COLOURS SHRINK TUBE</td> <td>0.250</td> <td>M</td> </tr> </tbody> </table>	Code	Description	Qty	UOM	VE1020A2	MAGNETIC DOOR MICROSWITCH	1	PZ	VE1030A1	MAGNET FOR DOOR MICROSWITCH H D=22,9MM	4	PZ	VM1224A0	65MY 220MM 2 COLOURS SHRINK TUBE	0.250	M
Code	Description	Qty	UOM																		
VE1020A2	MAGNETIC DOOR MICROSWITCH	1	PZ																		
VE1030A1	MAGNET FOR DOOR MICROSWITCH H D=22,9MM	4	PZ																		
VM1224A0	65MY 220MM 2 COLOURS SHRINK TUBE	0.250	M																		
VM2268A	DOOR MAGNET COVER		KVM2268A	DOOR MAGNET COVER KIT	<table border="1"> <thead> <tr> <th>Code</th> <th>Description</th> <th>Qty</th> <th>UOM</th> </tr> </thead> <tbody> <tr> <td>VM1224A0</td> <td>65MY 220MM 2 COLOURS SHRINK TUBE</td> <td>0.200</td> <td>M</td> </tr> <tr> <td>VM2268A0</td> <td>DOOR MAGNET COVER</td> <td>1</td> <td>PZ</td> </tr> </tbody> </table>	Code	Description	Qty	UOM	VM1224A0	65MY 220MM 2 COLOURS SHRINK TUBE	0.200	M	VM2268A0	DOOR MAGNET COVER	1	PZ				
Code	Description	Qty	UOM																		
VM1224A0	65MY 220MM 2 COLOURS SHRINK TUBE	0.200	M																		
VM2268A0	DOOR MAGNET COVER	1	PZ																		

COMPONENT			SPARE PART																										
Code	Description	Image	Code	Description	Components list																								
VI1996A	M5X35 SCREW		VI1996A0	M5X35 SCREW																									
VM2267A	INTERNAL GLASS LOCKING SYSTEM SLIDER		VM2267A0	INTERNAL GLASS LOCKING SYSTEM SLIDER																									
VI1930A	ST. STEEL 5X20 CHIP SCREW		VI1930A1	ST. STEEL 5X20 CHIP SCREW																									
VM2269B	INNER GLASS FIXING CAP		KVM2269B	INNER GLASS FIXING CAP KIT -M	<table border="1"> <thead> <tr> <th>Code</th> <th>Description</th> <th>Qty</th> <th>UOM</th> </tr> </thead> <tbody> <tr> <td>VM2269B0</td> <td>INNER GLASS FIXING CAP</td> <td>2</td> <td>PZ</td> </tr> </tbody> </table>	Code	Description	Qty	UOM	VM2269B0	INNER GLASS FIXING CAP	2	PZ																
Code	Description	Qty	UOM																										
VM2269B0	INNER GLASS FIXING CAP	2	PZ																										
VM2262B			KVM2262B	MIND.MAPS -M DOOR RIGHT UPPER CAP KIT	<table border="1"> <thead> <tr> <th>Code</th> <th>Description</th> <th>Qty</th> <th>UOM</th> </tr> </thead> <tbody> <tr> <td>RC1200A0</td> <td>ED=4 WIRE D.=0.5 COMPRESSIO N SPRING</td> <td>2</td> <td>PZ</td> </tr> <tr> <td>VE1030A1</td> <td>MAGNET FOR DOOR MICROSWITC H D=22,9MM</td> <td>1</td> <td>PZ</td> </tr> <tr> <td>VI1220A1</td> <td>4,2X12 TCB SELF-TAPPIN G SCREW</td> <td>1</td> <td>PZ</td> </tr> <tr> <td>VI1930A1</td> <td>ST. STEEL 5X20 CHIP SCREW</td> <td>4</td> <td>PZ</td> </tr> <tr> <td>VI1996A0</td> <td>M5X35 SCREW</td> <td>4</td> <td>PZ</td> </tr> </tbody> </table>	Code	Description	Qty	UOM	RC1200A0	ED=4 WIRE D.=0.5 COMPRESSIO N SPRING	2	PZ	VE1030A1	MAGNET FOR DOOR MICROSWITC H D=22,9MM	1	PZ	VI1220A1	4,2X12 TCB SELF-TAPPIN G SCREW	1	PZ	VI1930A1	ST. STEEL 5X20 CHIP SCREW	4	PZ	VI1996A0	M5X35 SCREW	4	PZ
Code	Description	Qty	UOM																										
RC1200A0	ED=4 WIRE D.=0.5 COMPRESSIO N SPRING	2	PZ																										
VE1030A1	MAGNET FOR DOOR MICROSWITC H D=22,9MM	1	PZ																										
VI1220A1	4,2X12 TCB SELF-TAPPIN G SCREW	1	PZ																										
VI1930A1	ST. STEEL 5X20 CHIP SCREW	4	PZ																										
VI1996A0	M5X35 SCREW	4	PZ																										

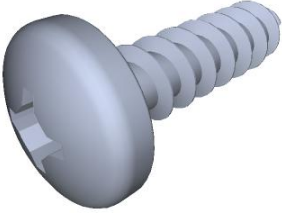
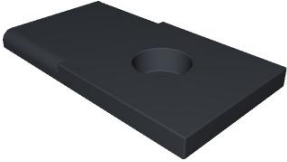
COMPONENT			SPARE PART																														
Code	Description	Image	Code	Description	Components list																												
VM2262B			KVM2262B	MIND.MAPS -M DOOR RIGHT UPPER CAP KIT	<table border="1"> <thead> <tr> <th>Code</th> <th>Description</th> <th>Qty</th> <th>UOM</th> </tr> </thead> <tbody> <tr> <td>VM1224A0</td> <td>65MY 220MM 2 COLOURS SHRINK TUBE</td> <td>0.300</td> <td>M</td> </tr> <tr> <td>VM2262B0</td> <td></td> <td>1</td> <td>PZ</td> </tr> <tr> <td>VM2267A0</td> <td>INTERNAL GLASS LOCKING SYSTEM SLIDER</td> <td>1</td> <td>PZ</td> </tr> <tr> <td>VM2268A0</td> <td>DOOR MAGNET COVER</td> <td>1</td> <td>PZ</td> </tr> <tr> <td>VM2269B0</td> <td>INNER GLASS FIXING CAP</td> <td>1</td> <td>PZ</td> </tr> <tr> <td>VM2305A0</td> <td>6 SERIES DOOR CAP FIXING PAWL</td> <td>4</td> <td>PZ</td> </tr> </tbody> </table>	Code	Description	Qty	UOM	VM1224A0	65MY 220MM 2 COLOURS SHRINK TUBE	0.300	M	VM2262B0		1	PZ	VM2267A0	INTERNAL GLASS LOCKING SYSTEM SLIDER	1	PZ	VM2268A0	DOOR MAGNET COVER	1	PZ	VM2269B0	INNER GLASS FIXING CAP	1	PZ	VM2305A0	6 SERIES DOOR CAP FIXING PAWL	4	PZ
Code	Description	Qty	UOM																														
VM1224A0	65MY 220MM 2 COLOURS SHRINK TUBE	0.300	M																														
VM2262B0		1	PZ																														
VM2267A0	INTERNAL GLASS LOCKING SYSTEM SLIDER	1	PZ																														
VM2268A0	DOOR MAGNET COVER	1	PZ																														
VM2269B0	INNER GLASS FIXING CAP	1	PZ																														
VM2305A0	6 SERIES DOOR CAP FIXING PAWL	4	PZ																														
VM2305A	6 SERIES DOOR CAP FIXING PAWL		KVM2305A	MM FIXING DOOR THUB SCREWS 10 PCS KIT	<table border="1"> <thead> <tr> <th>Code</th> <th>Description</th> <th>Qty</th> <th>UOM</th> </tr> </thead> <tbody> <tr> <td>VM1224A0</td> <td>65MY 220MM 2 COLOURS SHRINK TUBE</td> <td>0.200</td> <td>M</td> </tr> <tr> <td>VM2305A0</td> <td>6 SERIES DOOR CAP FIXING PAWL</td> <td>10</td> <td>PZ</td> </tr> </tbody> </table>	Code	Description	Qty	UOM	VM1224A0	65MY 220MM 2 COLOURS SHRINK TUBE	0.200	M	VM2305A0	6 SERIES DOOR CAP FIXING PAWL	10	PZ																
Code	Description	Qty	UOM																														
VM1224A0	65MY 220MM 2 COLOURS SHRINK TUBE	0.200	M																														
VM2305A0	6 SERIES DOOR CAP FIXING PAWL	10	PZ																														
VE1030A	MAGNET FOR DOOR MICROSWITCH D=22,9MM		KVE1030A	2 PCS MAGNET KIT FOR DOOR SWITCH	<table border="1"> <thead> <tr> <th>Code</th> <th>Description</th> <th>Qty</th> <th>UOM</th> </tr> </thead> <tbody> <tr> <td>VE1030A1</td> <td>MAGNET FOR DOOR MICROSWITC H D=22,9MM</td> <td>2</td> <td>PZ</td> </tr> <tr> <td>VM1224A0</td> <td>65MY 220MM 2 COLOURS SHRINK TUBE</td> <td>0.150</td> <td>M</td> </tr> </tbody> </table>	Code	Description	Qty	UOM	VE1030A1	MAGNET FOR DOOR MICROSWITC H D=22,9MM	2	PZ	VM1224A0	65MY 220MM 2 COLOURS SHRINK TUBE	0.150	M																
Code	Description	Qty	UOM																														
VE1030A1	MAGNET FOR DOOR MICROSWITC H D=22,9MM	2	PZ																														
VM1224A0	65MY 220MM 2 COLOURS SHRINK TUBE	0.150	M																														
			KVE1020A	MICROSWITCH KIT	<table border="1"> <thead> <tr> <th>Code</th> <th>Description</th> <th>Qty</th> <th>UOM</th> </tr> </thead> <tbody> <tr> <td>VE1020A2</td> <td>MAGNETIC DOOR MICROSWITC</td> <td>1</td> <td>PZ</td> </tr> <tr> <td>VE1030A1</td> <td>MAGNET FOR DOOR MICROSWITC H D=22,9MM</td> <td>4</td> <td>PZ</td> </tr> <tr> <td>VM1224A0</td> <td>65MY 220MM 2 COLOURS SHRINK TUBE</td> <td>0.250</td> <td>M</td> </tr> </tbody> </table>	Code	Description	Qty	UOM	VE1020A2	MAGNETIC DOOR MICROSWITC	1	PZ	VE1030A1	MAGNET FOR DOOR MICROSWITC H D=22,9MM	4	PZ	VM1224A0	65MY 220MM 2 COLOURS SHRINK TUBE	0.250	M												
Code	Description	Qty	UOM																														
VE1020A2	MAGNETIC DOOR MICROSWITC	1	PZ																														
VE1030A1	MAGNET FOR DOOR MICROSWITC H D=22,9MM	4	PZ																														
VM1224A0	65MY 220MM 2 COLOURS SHRINK TUBE	0.250	M																														

COMPONENT			SPARE PART														
Code	Description	Image	Code	Description	Components list												
VM2268A	DOOR MAGNET COVER		KVM2268A	DOOR MAGNET COVER KIT	<table border="1"> <thead> <tr> <th>Code</th> <th>Description</th> <th>Qty</th> <th>UOM</th> </tr> </thead> <tbody> <tr> <td>VM1224A0</td> <td>65MY 220MM 2 COLOURS SHRINK TUBE</td> <td>0.200</td> <td>M</td> </tr> <tr> <td>VM2268A0</td> <td>DOOR MAGNET COVER</td> <td>1</td> <td>PZ</td> </tr> </tbody> </table>	Code	Description	Qty	UOM	VM1224A0	65MY 220MM 2 COLOURS SHRINK TUBE	0.200	M	VM2268A0	DOOR MAGNET COVER	1	PZ
Code	Description	Qty	UOM														
VM1224A0	65MY 220MM 2 COLOURS SHRINK TUBE	0.200	M														
VM2268A0	DOOR MAGNET COVER	1	PZ														
VI1996A	M5X35 SCREW		VI1996A0	M5X35 SCREW													
VM2267A	INTERNAL GLASS LOCKING SYSTEM SLIDER		VM2267A0	INTERNAL GLASS LOCKING SYSTEM SLIDER													
VI1930A	ST. STEEL 5X20 CHIP SCREW		VI1930A1	ST. STEEL 5X20 CHIP SCREW													
VM2269B	INNER GLASS FIXING CAP		KVM2269B	INNER GLASS FIXING CAP KIT -M	<table border="1"> <thead> <tr> <th>Code</th> <th>Description</th> <th>Qty</th> <th>UOM</th> </tr> </thead> <tbody> <tr> <td>VM2269B0</td> <td>INNER GLASS FIXING CAP</td> <td>2</td> <td>PZ</td> </tr> </tbody> </table>	Code	Description	Qty	UOM	VM2269B0	INNER GLASS FIXING CAP	2	PZ				
Code	Description	Qty	UOM														
VM2269B0	INNER GLASS FIXING CAP	2	PZ														

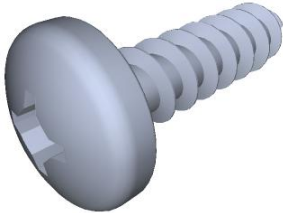
COMPONENT			SPARE PART																																																		
Code	Description	Image	Code	Description	Components list																																																
VM2261B			KVM2261B	MIND.MAPS -M DOOR RIGHT LOWER CAP KIT	<table border="1"> <thead> <tr> <th>Code</th> <th>Description</th> <th>Qty</th> <th>UOM</th> </tr> </thead> <tbody> <tr> <td>RC1200A0</td> <td>ED=4 WIRE D.=0.5 COMPRESSIO N SPRING</td> <td>2</td> <td>PZ</td> </tr> <tr> <td>VE1030A1</td> <td>MAGNET FOR DOOR MICROSWITC H D=22.9MM</td> <td>1</td> <td>PZ</td> </tr> <tr> <td>VI1220A1</td> <td>4,2X12 TCB SELF-TAPPIN G SCREW</td> <td>1</td> <td>PZ</td> </tr> <tr> <td>VI1930A1</td> <td>ST. STEEL 5X20 CHIP SCREW</td> <td>4</td> <td>PZ</td> </tr> <tr> <td>VI1996A0</td> <td>M5X35 SCREW</td> <td>4</td> <td>PZ</td> </tr> <tr> <td>VM1224A0</td> <td>65MY 220MM 2 COLOURS SHRINK TUBE</td> <td>0.300</td> <td>M</td> </tr> <tr> <td>VM2261B0</td> <td></td> <td>1</td> <td>PZ</td> </tr> <tr> <td>VM2267A0</td> <td>INTERNAL GLASS LOCKING SYSTEM SLIDER</td> <td>1</td> <td>PZ</td> </tr> <tr> <td>VM2268A0</td> <td>DOOR MAGNET COVER</td> <td>1</td> <td>PZ</td> </tr> <tr> <td>VM2269B0</td> <td>INNER GLASS FIXING CAP</td> <td>1</td> <td>PZ</td> </tr> <tr> <td>VM2305A0</td> <td>6 SERIES DOOR CAP FIXING PAWL</td> <td>4</td> <td>PZ</td> </tr> </tbody> </table>	Code	Description	Qty	UOM	RC1200A0	ED=4 WIRE D.=0.5 COMPRESSIO N SPRING	2	PZ	VE1030A1	MAGNET FOR DOOR MICROSWITC H D=22.9MM	1	PZ	VI1220A1	4,2X12 TCB SELF-TAPPIN G SCREW	1	PZ	VI1930A1	ST. STEEL 5X20 CHIP SCREW	4	PZ	VI1996A0	M5X35 SCREW	4	PZ	VM1224A0	65MY 220MM 2 COLOURS SHRINK TUBE	0.300	M	VM2261B0		1	PZ	VM2267A0	INTERNAL GLASS LOCKING SYSTEM SLIDER	1	PZ	VM2268A0	DOOR MAGNET COVER	1	PZ	VM2269B0	INNER GLASS FIXING CAP	1	PZ	VM2305A0	6 SERIES DOOR CAP FIXING PAWL	4	PZ
Code	Description	Qty	UOM																																																		
RC1200A0	ED=4 WIRE D.=0.5 COMPRESSIO N SPRING	2	PZ																																																		
VE1030A1	MAGNET FOR DOOR MICROSWITC H D=22.9MM	1	PZ																																																		
VI1220A1	4,2X12 TCB SELF-TAPPIN G SCREW	1	PZ																																																		
VI1930A1	ST. STEEL 5X20 CHIP SCREW	4	PZ																																																		
VI1996A0	M5X35 SCREW	4	PZ																																																		
VM1224A0	65MY 220MM 2 COLOURS SHRINK TUBE	0.300	M																																																		
VM2261B0		1	PZ																																																		
VM2267A0	INTERNAL GLASS LOCKING SYSTEM SLIDER	1	PZ																																																		
VM2268A0	DOOR MAGNET COVER	1	PZ																																																		
VM2269B0	INNER GLASS FIXING CAP	1	PZ																																																		
VM2305A0	6 SERIES DOOR CAP FIXING PAWL	4	PZ																																																		
VM2305A	6 SERIES DOOR CAP FIXING PAWL		KVM2305A	MM FIXING DOOR THUB SCREWS 10 PCS KIT	<table border="1"> <thead> <tr> <th>Code</th> <th>Description</th> <th>Qty</th> <th>UOM</th> </tr> </thead> <tbody> <tr> <td>VM1224A0</td> <td>65MY 220MM 2 COLOURS SHRINK TUBE</td> <td>0.200</td> <td>M</td> </tr> <tr> <td>VM2305A0</td> <td>6 SERIES DOOR CAP FIXING PAWL</td> <td>10</td> <td>PZ</td> </tr> </tbody> </table>	Code	Description	Qty	UOM	VM1224A0	65MY 220MM 2 COLOURS SHRINK TUBE	0.200	M	VM2305A0	6 SERIES DOOR CAP FIXING PAWL	10	PZ																																				
Code	Description	Qty	UOM																																																		
VM1224A0	65MY 220MM 2 COLOURS SHRINK TUBE	0.200	M																																																		
VM2305A0	6 SERIES DOOR CAP FIXING PAWL	10	PZ																																																		
VM2275A	SMOOTH BUSHING		KVM2275A	SMOOTH PIN BUSHING KIT	<table border="1"> <thead> <tr> <th>Code</th> <th>Description</th> <th>Qty</th> <th>UOM</th> </tr> </thead> <tbody> <tr> <td>VM1224A0</td> <td>65MY 220MM 2 COLOURS SHRINK TUBE</td> <td>0.150</td> <td>M</td> </tr> <tr> <td>VM2275A0</td> <td>SMOOTH BUSHING</td> <td>1</td> <td>PZ</td> </tr> </tbody> </table>	Code	Description	Qty	UOM	VM1224A0	65MY 220MM 2 COLOURS SHRINK TUBE	0.150	M	VM2275A0	SMOOTH BUSHING	1	PZ																																				
Code	Description	Qty	UOM																																																		
VM1224A0	65MY 220MM 2 COLOURS SHRINK TUBE	0.150	M																																																		
VM2275A0	SMOOTH BUSHING	1	PZ																																																		

COMPONENT			SPARE PART																																						
Code	Description	Image	Code	Description	Components list																																				
VI1996A	M5X35 SCREW		VI1996A0	M5X35 SCREW																																					
VI1930A	ST. STEEL 5X20 CHIP SCREW		VI1930A1	ST. STEEL 5X20 CHIP SCREW																																					
VP1081A	UPPER HINGE CAP FOR UPPER INNER GLASS		KVM2384B	MM- M LEFT DOOR RIGHT LOWER CAP KIT	<table border="1"> <thead> <tr> <th>Code</th> <th>Description</th> <th>Qty</th> <th>UOM</th> </tr> </thead> <tbody> <tr> <td>VI1074A0</td> <td>4X16 SCREW FOR PLASTIC</td> <td>1</td> <td>PZ</td> </tr> <tr> <td>VI1930A1</td> <td>ST. STEEL 5X20 CHIP SCREW</td> <td>4</td> <td>PZ</td> </tr> <tr> <td>VI1996A0</td> <td>M5X35 SCREW</td> <td>2</td> <td>PZ</td> </tr> <tr> <td>VM2274A0</td> <td>GROOVED BUSHING</td> <td>1</td> <td>PZ</td> </tr> <tr> <td>VM2305A0</td> <td>6 SERIES DOOR CAP FIXING PAWL</td> <td>3</td> <td>PZ</td> </tr> <tr> <td>VM2384B0</td> <td></td> <td>1</td> <td>PZ</td> </tr> <tr> <td>VP1081A0</td> <td>UPPER HINGE CAP FOR UPPER INNER GLASS</td> <td>1</td> <td>PZ</td> </tr> </tbody> </table>	Code	Description	Qty	UOM	VI1074A0	4X16 SCREW FOR PLASTIC	1	PZ	VI1930A1	ST. STEEL 5X20 CHIP SCREW	4	PZ	VI1996A0	M5X35 SCREW	2	PZ	VM2274A0	GROOVED BUSHING	1	PZ	VM2305A0	6 SERIES DOOR CAP FIXING PAWL	3	PZ	VM2384B0		1	PZ	VP1081A0	UPPER HINGE CAP FOR UPPER INNER GLASS	1	PZ				
Code	Description	Qty	UOM																																						
VI1074A0	4X16 SCREW FOR PLASTIC	1	PZ																																						
VI1930A1	ST. STEEL 5X20 CHIP SCREW	4	PZ																																						
VI1996A0	M5X35 SCREW	2	PZ																																						
VM2274A0	GROOVED BUSHING	1	PZ																																						
VM2305A0	6 SERIES DOOR CAP FIXING PAWL	3	PZ																																						
VM2384B0		1	PZ																																						
VP1081A0	UPPER HINGE CAP FOR UPPER INNER GLASS	1	PZ																																						
			KVM2260B	MM M RIGHT DOOR -LEFT UPPER CAP KI	<table border="1"> <thead> <tr> <th>Code</th> <th>Description</th> <th>Qty</th> <th>UOM</th> </tr> </thead> <tbody> <tr> <td>VI1103A0</td> <td>40X12 TBSP SCREW FOR PLASTIC</td> <td>1</td> <td>PZ</td> </tr> <tr> <td>VI1930A1</td> <td>ST. STEEL 5X20 CHIP SCREW</td> <td>4</td> <td>PZ</td> </tr> <tr> <td>VI1996A0</td> <td>M5X35 SCREW</td> <td>2</td> <td>PZ</td> </tr> <tr> <td>VM1224A0</td> <td>65MY 220MM 2 COLOURS SHRINK TUBE</td> <td>0.300</td> <td>M</td> </tr> <tr> <td>VM2260B0</td> <td>S6 LEFT UPPER CAP</td> <td>1</td> <td>PZ</td> </tr> <tr> <td>VM2275A0</td> <td>SMOOTH BUSHING</td> <td>1</td> <td>PZ</td> </tr> <tr> <td>VM2305A0</td> <td>6 SERIES DOOR CAP FIXING PAWL</td> <td>3</td> <td>PZ</td> </tr> <tr> <td>VP1081A0</td> <td>UPPER HINGE CAP FOR UPPER INNER GLASS</td> <td>1</td> <td>PZ</td> </tr> </tbody> </table>	Code	Description	Qty	UOM	VI1103A0	40X12 TBSP SCREW FOR PLASTIC	1	PZ	VI1930A1	ST. STEEL 5X20 CHIP SCREW	4	PZ	VI1996A0	M5X35 SCREW	2	PZ	VM1224A0	65MY 220MM 2 COLOURS SHRINK TUBE	0.300	M	VM2260B0	S6 LEFT UPPER CAP	1	PZ	VM2275A0	SMOOTH BUSHING	1	PZ	VM2305A0	6 SERIES DOOR CAP FIXING PAWL	3	PZ	VP1081A0	UPPER HINGE CAP FOR UPPER INNER GLASS	1	PZ
Code	Description	Qty	UOM																																						
VI1103A0	40X12 TBSP SCREW FOR PLASTIC	1	PZ																																						
VI1930A1	ST. STEEL 5X20 CHIP SCREW	4	PZ																																						
VI1996A0	M5X35 SCREW	2	PZ																																						
VM1224A0	65MY 220MM 2 COLOURS SHRINK TUBE	0.300	M																																						
VM2260B0	S6 LEFT UPPER CAP	1	PZ																																						
VM2275A0	SMOOTH BUSHING	1	PZ																																						
VM2305A0	6 SERIES DOOR CAP FIXING PAWL	3	PZ																																						
VP1081A0	UPPER HINGE CAP FOR UPPER INNER GLASS	1	PZ																																						



COMPONENT			SPARE PART																																										
Code	Description	Image	Code	Description	Components list																																								
VM2260B	S6 LEFT UPPER CAP		KVM2260B	MM M RIGHT DOOR -LEFT UPPER CAP KI	<table border="1"> <thead> <tr> <th>Code</th> <th>Description</th> <th>Qty</th> <th>UOM</th> </tr> </thead> <tbody> <tr> <td>VI1103A0</td> <td>40X12 TBSP SCREW FOR PLASTIC</td> <td>1</td> <td>PZ</td> </tr> <tr> <td>VI1930A1</td> <td>ST. STEEL 5X20 CHIP SCREW</td> <td>4</td> <td>PZ</td> </tr> <tr> <td>VI1996A0</td> <td>M5X35 SCREW</td> <td>2</td> <td>PZ</td> </tr> <tr> <td>VM1224A0</td> <td>65MY 220MM 2 COLOURS SHRINK TUBE</td> <td>0.300</td> <td>M</td> </tr> <tr> <td>VM2260B0</td> <td>S6 LEFT UPPER CAP</td> <td>1</td> <td>PZ</td> </tr> <tr> <td>VM2275A0</td> <td>SMOOTH BUSHING</td> <td>1</td> <td>PZ</td> </tr> <tr> <td>VM2305A0</td> <td>6 SERIES DOOR CAP FIXING PAWL</td> <td>3</td> <td>PZ</td> </tr> <tr> <td>VP1081A0</td> <td>UPPER HINGE CAP FOR UPPER INNER GLASS</td> <td>1</td> <td>PZ</td> </tr> </tbody> </table>	Code	Description	Qty	UOM	VI1103A0	40X12 TBSP SCREW FOR PLASTIC	1	PZ	VI1930A1	ST. STEEL 5X20 CHIP SCREW	4	PZ	VI1996A0	M5X35 SCREW	2	PZ	VM1224A0	65MY 220MM 2 COLOURS SHRINK TUBE	0.300	M	VM2260B0	S6 LEFT UPPER CAP	1	PZ	VM2275A0	SMOOTH BUSHING	1	PZ	VM2305A0	6 SERIES DOOR CAP FIXING PAWL	3	PZ	VP1081A0	UPPER HINGE CAP FOR UPPER INNER GLASS	1	PZ				
Code	Description	Qty	UOM																																										
VI1103A0	40X12 TBSP SCREW FOR PLASTIC	1	PZ																																										
VI1930A1	ST. STEEL 5X20 CHIP SCREW	4	PZ																																										
VI1996A0	M5X35 SCREW	2	PZ																																										
VM1224A0	65MY 220MM 2 COLOURS SHRINK TUBE	0.300	M																																										
VM2260B0	S6 LEFT UPPER CAP	1	PZ																																										
VM2275A0	SMOOTH BUSHING	1	PZ																																										
VM2305A0	6 SERIES DOOR CAP FIXING PAWL	3	PZ																																										
VP1081A0	UPPER HINGE CAP FOR UPPER INNER GLASS	1	PZ																																										
VM2274A	GROOVED BUSHING		KVM2274A	GROOVED PIN BUSHING KIT	<table border="1"> <thead> <tr> <th>Code</th> <th>Description</th> <th>Qty</th> <th>UOM</th> </tr> </thead> <tbody> <tr> <td>VM1224A0</td> <td>65MY 220MM 2 COLOURS SHRINK TUBE</td> <td>0.150</td> <td>M</td> </tr> <tr> <td>VM2274A0</td> <td>GROOVED BUSHING</td> <td>1</td> <td>PZ</td> </tr> </tbody> </table>	Code	Description	Qty	UOM	VM1224A0	65MY 220MM 2 COLOURS SHRINK TUBE	0.150	M	VM2274A0	GROOVED BUSHING	1	PZ																												
Code	Description	Qty	UOM																																										
VM1224A0	65MY 220MM 2 COLOURS SHRINK TUBE	0.150	M																																										
VM2274A0	GROOVED BUSHING	1	PZ																																										
			K0B1126AR	BAKERTOP MM RIGHT DOOR LOWER BEAM KIT	<table border="1"> <thead> <tr> <th>Code</th> <th>Description</th> <th>Qty</th> <th>UOM</th> </tr> </thead> <tbody> <tr> <td>0B1126A0</td> <td>DOOR LOWER FRAME SHAPE 860 MM</td> <td>1</td> <td>PZ</td> </tr> <tr> <td>0B1126A1</td> <td></td> <td>1</td> <td>PZ</td> </tr> <tr> <td>RC1200A0</td> <td>ED=4 WIRE D.=0.5 COMPRESSIO N SPRING</td> <td>2</td> <td>PZ</td> </tr> <tr> <td>VI1220A1</td> <td>4,2X12 TCB SELF-TAPPIN G SCREW</td> <td>1</td> <td>PZ</td> </tr> <tr> <td>VI1996A0</td> <td>M5X35 SCREW</td> <td>7</td> <td>PZ</td> </tr> <tr> <td>VM1794A0</td> <td>250X4.8 PA66 BLACK CLAMP</td> <td>2</td> <td>PZ</td> </tr> <tr> <td>VM2103A0</td> <td>CLAMP LOCK</td> <td>2</td> <td>PZ</td> </tr> <tr> <td>VM2259A1</td> <td>6 SERIES DOOR LOWER LEFT CAP</td> <td>1</td> <td>PZ</td> </tr> <tr> <td>VM2261A1</td> <td>6 SERIES DOOR LOWER RIGHT CAP</td> <td>1</td> <td>PZ</td> </tr> </tbody> </table>	Code	Description	Qty	UOM	0B1126A0	DOOR LOWER FRAME SHAPE 860 MM	1	PZ	0B1126A1		1	PZ	RC1200A0	ED=4 WIRE D.=0.5 COMPRESSIO N SPRING	2	PZ	VI1220A1	4,2X12 TCB SELF-TAPPIN G SCREW	1	PZ	VI1996A0	M5X35 SCREW	7	PZ	VM1794A0	250X4.8 PA66 BLACK CLAMP	2	PZ	VM2103A0	CLAMP LOCK	2	PZ	VM2259A1	6 SERIES DOOR LOWER LEFT CAP	1	PZ	VM2261A1	6 SERIES DOOR LOWER RIGHT CAP	1	PZ
Code	Description	Qty	UOM																																										
0B1126A0	DOOR LOWER FRAME SHAPE 860 MM	1	PZ																																										
0B1126A1		1	PZ																																										
RC1200A0	ED=4 WIRE D.=0.5 COMPRESSIO N SPRING	2	PZ																																										
VI1220A1	4,2X12 TCB SELF-TAPPIN G SCREW	1	PZ																																										
VI1996A0	M5X35 SCREW	7	PZ																																										
VM1794A0	250X4.8 PA66 BLACK CLAMP	2	PZ																																										
VM2103A0	CLAMP LOCK	2	PZ																																										
VM2259A1	6 SERIES DOOR LOWER LEFT CAP	1	PZ																																										
VM2261A1	6 SERIES DOOR LOWER RIGHT CAP	1	PZ																																										





COMPONENT			SPARE PART																																																															
Code	Description	Image	Code	Description	Components list																																																													
VM2274A	GROOVED BUSHING		K0B1126AR	BAKERTOP MM RIGHT DOOR LOWER BEAM KIT	<table border="1"> <thead> <tr> <th>Code</th> <th>Description</th> <th>Qty</th> <th>UOM</th> </tr> </thead> <tbody> <tr> <td>VM2267A0</td> <td>INTERNAL GLASS LOCKING SYSTEM SLIDER</td> <td>1</td> <td>PZ</td> </tr> <tr> <td>VM2269A0</td> <td>INTERNAL GLASS LOCKING SYSTEM CAP</td> <td>1</td> <td>PZ</td> </tr> <tr> <td>VM2274A0</td> <td>GROOVED BUSHING</td> <td>1</td> <td>PZ</td> </tr> <tr> <td>VM2305A0</td> <td>6 SERIES DOOR CAP FIXING PAWL</td> <td>7</td> <td>PZ</td> </tr> </tbody> </table>	Code	Description	Qty	UOM	VM2267A0	INTERNAL GLASS LOCKING SYSTEM SLIDER	1	PZ	VM2269A0	INTERNAL GLASS LOCKING SYSTEM CAP	1	PZ	VM2274A0	GROOVED BUSHING	1	PZ	VM2305A0	6 SERIES DOOR CAP FIXING PAWL	7	PZ																																									
			Code	Description	Qty	UOM																																																												
VM2267A0	INTERNAL GLASS LOCKING SYSTEM SLIDER	1	PZ																																																															
VM2269A0	INTERNAL GLASS LOCKING SYSTEM CAP	1	PZ																																																															
VM2274A0	GROOVED BUSHING	1	PZ																																																															
VM2305A0	6 SERIES DOOR CAP FIXING PAWL	7	PZ																																																															
K0B1126AL	EU AND 2/1 MM LEFT DOOR LOWER BEAM KIT	<table border="1"> <thead> <tr> <th>Code</th> <th>Description</th> <th>Qty</th> <th>UOM</th> </tr> </thead> <tbody> <tr> <td>0B1126A0</td> <td>DOOR LOWER FRAME SHAPE 860 MM</td> <td>1</td> <td>PZ</td> </tr> <tr> <td>0B1126A1</td> <td></td> <td>1</td> <td>PZ</td> </tr> <tr> <td>RC1200A0</td> <td>ED=4 WIRE D.=0.5 COMPRESSIO N SPRING</td> <td>2</td> <td>PZ</td> </tr> <tr> <td>VI1220A1</td> <td>4,2X12 TCB SELF-TAPPIN G SCREW</td> <td>1</td> <td>PZ</td> </tr> <tr> <td>VI1996A0</td> <td>M5X35 SCREW</td> <td>7</td> <td>PZ</td> </tr> <tr> <td>VM1794A0</td> <td>250X4.8 PA66 BLACK CLAMP</td> <td>2</td> <td>PZ</td> </tr> <tr> <td>VM2103A0</td> <td>CLAMP LOCK</td> <td>2</td> <td>PZ</td> </tr> <tr> <td>VM2267A0</td> <td>INTERNAL GLASS LOCKING SYSTEM SLIDER</td> <td>1</td> <td>PZ</td> </tr> <tr> <td>VM2269A0</td> <td>INTERNAL GLASS LOCKING SYSTEM CAP</td> <td>1</td> <td>PZ</td> </tr> <tr> <td>VM2274A0</td> <td>GROOVED BUSHING</td> <td>1</td> <td>PZ</td> </tr> <tr> <td>VM2305A0</td> <td>6 SERIES DOOR CAP FIXING PAWL</td> <td>7</td> <td>PZ</td> </tr> <tr> <td>VM2384A0</td> <td>MM LEFT DOOR RIGHT LOWER CAP</td> <td>1</td> <td>PZ</td> </tr> <tr> <td>VM2384A0</td> <td>MM LEFT DOOR RIGHT LOWER CAP</td> <td>1</td> <td>PZ</td> </tr> <tr> <td>VM2386A1</td> <td>LEFT MM DOOR LOWER LEFT CAP</td> <td>1</td> <td>PZ</td> </tr> <tr> <td>VM2386A1</td> <td>LEFT MM DOOR LOWER LEFT CAP</td> <td>1</td> <td>PZ</td> </tr> </tbody> </table>	Code	Description	Qty	UOM	0B1126A0	DOOR LOWER FRAME SHAPE 860 MM	1	PZ	0B1126A1		1	PZ	RC1200A0	ED=4 WIRE D.=0.5 COMPRESSIO N SPRING	2	PZ	VI1220A1	4,2X12 TCB SELF-TAPPIN G SCREW	1	PZ	VI1996A0	M5X35 SCREW	7	PZ	VM1794A0	250X4.8 PA66 BLACK CLAMP	2	PZ	VM2103A0	CLAMP LOCK	2	PZ	VM2267A0	INTERNAL GLASS LOCKING SYSTEM SLIDER	1	PZ	VM2269A0	INTERNAL GLASS LOCKING SYSTEM CAP	1	PZ	VM2274A0	GROOVED BUSHING	1	PZ	VM2305A0	6 SERIES DOOR CAP FIXING PAWL	7	PZ	VM2384A0	MM LEFT DOOR RIGHT LOWER CAP	1	PZ	VM2384A0	MM LEFT DOOR RIGHT LOWER CAP	1	PZ	VM2386A1	LEFT MM DOOR LOWER LEFT CAP	1	PZ	VM2386A1	LEFT MM DOOR LOWER LEFT CAP	1	PZ
Code	Description	Qty	UOM																																																															
0B1126A0	DOOR LOWER FRAME SHAPE 860 MM	1	PZ																																																															
0B1126A1		1	PZ																																																															
RC1200A0	ED=4 WIRE D.=0.5 COMPRESSIO N SPRING	2	PZ																																																															
VI1220A1	4,2X12 TCB SELF-TAPPIN G SCREW	1	PZ																																																															
VI1996A0	M5X35 SCREW	7	PZ																																																															
VM1794A0	250X4.8 PA66 BLACK CLAMP	2	PZ																																																															
VM2103A0	CLAMP LOCK	2	PZ																																																															
VM2267A0	INTERNAL GLASS LOCKING SYSTEM SLIDER	1	PZ																																																															
VM2269A0	INTERNAL GLASS LOCKING SYSTEM CAP	1	PZ																																																															
VM2274A0	GROOVED BUSHING	1	PZ																																																															
VM2305A0	6 SERIES DOOR CAP FIXING PAWL	7	PZ																																																															
VM2384A0	MM LEFT DOOR RIGHT LOWER CAP	1	PZ																																																															
VM2384A0	MM LEFT DOOR RIGHT LOWER CAP	1	PZ																																																															
VM2386A1	LEFT MM DOOR LOWER LEFT CAP	1	PZ																																																															
VM2386A1	LEFT MM DOOR LOWER LEFT CAP	1	PZ																																																															

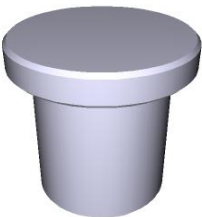



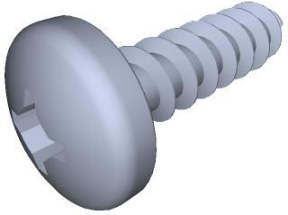

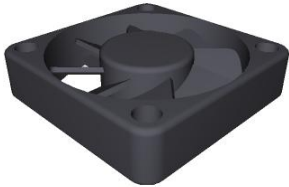

COMPONENT			SPARE PART																																																																																									
Code	Description	Image	Code	Description	Components list																																																																																							
VM2274A	GROOVED BUSHING		K0B1122AR	CHEFTOP MM RIGHT DOOR LOWER BEAM KIT	<table border="1"> <thead> <tr> <th>Code</th> <th>Description</th> <th>Qty</th> <th>UOM</th> </tr> </thead> <tbody> <tr> <td>0B1122A0</td> <td>750MM DOOR LOWER FRAME SHAPE</td> <td>1</td> <td>PZ</td> </tr> <tr> <td>0B1122A1</td> <td>750MM DOOR LOWER FRAME SHAPE</td> <td>1</td> <td>PZ</td> </tr> <tr> <td>RC1200A0</td> <td>ED=4 WIRE D.=0.5 COMPRESSIO N SPRING</td> <td>2</td> <td>PZ</td> </tr> <tr> <td>VI1220A1</td> <td>4,2X12 TCB SELF-TAPPIN G SCREW</td> <td>1</td> <td>PZ</td> </tr> <tr> <td>VI1996A0</td> <td>M5X35 SCREW</td> <td>7</td> <td>PZ</td> </tr> <tr> <td>VM1794A0</td> <td>250X4.8 PA66 BLACK CLAMP</td> <td>2</td> <td>PZ</td> </tr> <tr> <td>VM2103A0</td> <td>CLAMP LOCK</td> <td>2</td> <td>PZ</td> </tr> <tr> <td>VM2259A1</td> <td>6 SERIES DOOR LOWER LEFT CAP</td> <td>1</td> <td>PZ</td> </tr> <tr> <td>VM2261A1</td> <td>6 SERIES DOOR LOWER RIGHT CAP</td> <td>1</td> <td>PZ</td> </tr> <tr> <td>VM2267A0</td> <td>INTERNAL GLASS LOCKING SYSTEM SLIDER</td> <td>1</td> <td>PZ</td> </tr> <tr> <td>VM2269A0</td> <td>INTERNAL GLASS LOCKING SYSTEM CAP</td> <td>1</td> <td>PZ</td> </tr> <tr> <td>VM2274A0</td> <td>GROOVED BUSHING</td> <td>1</td> <td>PZ</td> </tr> <tr> <td>VM2305A0</td> <td>6 SERIES DOOR CAP FIXING PAWL</td> <td>7</td> <td>PZ</td> </tr> </tbody> </table>	Code	Description	Qty	UOM	0B1122A0	750MM DOOR LOWER FRAME SHAPE	1	PZ	0B1122A1	750MM DOOR LOWER FRAME SHAPE	1	PZ	RC1200A0	ED=4 WIRE D.=0.5 COMPRESSIO N SPRING	2	PZ	VI1220A1	4,2X12 TCB SELF-TAPPIN G SCREW	1	PZ	VI1996A0	M5X35 SCREW	7	PZ	VM1794A0	250X4.8 PA66 BLACK CLAMP	2	PZ	VM2103A0	CLAMP LOCK	2	PZ	VM2259A1	6 SERIES DOOR LOWER LEFT CAP	1	PZ	VM2261A1	6 SERIES DOOR LOWER RIGHT CAP	1	PZ	VM2267A0	INTERNAL GLASS LOCKING SYSTEM SLIDER	1	PZ	VM2269A0	INTERNAL GLASS LOCKING SYSTEM CAP	1	PZ	VM2274A0	GROOVED BUSHING	1	PZ	VM2305A0	6 SERIES DOOR CAP FIXING PAWL	7	PZ	K0B1122AL	CHEFTOP MM LEFT DOOR LOWER BEAM KIT	<table border="1"> <thead> <tr> <th>Code</th> <th>Description</th> <th>Qty</th> <th>UOM</th> </tr> </thead> <tbody> <tr> <td>0B1122A0</td> <td>750MM DOOR LOWER FRAME SHAPE</td> <td>1</td> <td>PZ</td> </tr> <tr> <td>0B1122A1</td> <td>750MM DOOR LOWER FRAME SHAPE</td> <td>1</td> <td>PZ</td> </tr> <tr> <td>RC1200A0</td> <td>ED=4 WIRE D.=0.5 COMPRESSIO N SPRING</td> <td>2</td> <td>PZ</td> </tr> <tr> <td>VI1220A1</td> <td>4,2X12 TCB SELF-TAPPIN G SCREW</td> <td>1</td> <td>PZ</td> </tr> <tr> <td>VI1996A0</td> <td>M5X35 SCREW</td> <td>7</td> <td>PZ</td> </tr> <tr> <td>VM1794A0</td> <td>250X4.8 PA66 BLACK CLAMP</td> <td>2</td> <td>PZ</td> </tr> </tbody> </table>	Code	Description	Qty	UOM	0B1122A0	750MM DOOR LOWER FRAME SHAPE	1	PZ	0B1122A1	750MM DOOR LOWER FRAME SHAPE	1	PZ	RC1200A0	ED=4 WIRE D.=0.5 COMPRESSIO N SPRING	2	PZ	VI1220A1	4,2X12 TCB SELF-TAPPIN G SCREW	1	PZ	VI1996A0	M5X35 SCREW	7	PZ	VM1794A0	250X4.8 PA66 BLACK CLAMP	2	PZ
			Code	Description	Qty	UOM																																																																																						
0B1122A0	750MM DOOR LOWER FRAME SHAPE	1	PZ																																																																																									
0B1122A1	750MM DOOR LOWER FRAME SHAPE	1	PZ																																																																																									
RC1200A0	ED=4 WIRE D.=0.5 COMPRESSIO N SPRING	2	PZ																																																																																									
VI1220A1	4,2X12 TCB SELF-TAPPIN G SCREW	1	PZ																																																																																									
VI1996A0	M5X35 SCREW	7	PZ																																																																																									
VM1794A0	250X4.8 PA66 BLACK CLAMP	2	PZ																																																																																									
VM2103A0	CLAMP LOCK	2	PZ																																																																																									
VM2259A1	6 SERIES DOOR LOWER LEFT CAP	1	PZ																																																																																									
VM2261A1	6 SERIES DOOR LOWER RIGHT CAP	1	PZ																																																																																									
VM2267A0	INTERNAL GLASS LOCKING SYSTEM SLIDER	1	PZ																																																																																									
VM2269A0	INTERNAL GLASS LOCKING SYSTEM CAP	1	PZ																																																																																									
VM2274A0	GROOVED BUSHING	1	PZ																																																																																									
VM2305A0	6 SERIES DOOR CAP FIXING PAWL	7	PZ																																																																																									
Code	Description	Qty	UOM																																																																																									
0B1122A0	750MM DOOR LOWER FRAME SHAPE	1	PZ																																																																																									
0B1122A1	750MM DOOR LOWER FRAME SHAPE	1	PZ																																																																																									
RC1200A0	ED=4 WIRE D.=0.5 COMPRESSIO N SPRING	2	PZ																																																																																									
VI1220A1	4,2X12 TCB SELF-TAPPIN G SCREW	1	PZ																																																																																									
VI1996A0	M5X35 SCREW	7	PZ																																																																																									
VM1794A0	250X4.8 PA66 BLACK CLAMP	2	PZ																																																																																									

COMPONENT			SPARE PART																																										
Code	Description	Image	Code	Description	Components list																																								
VM2274A	GROOVED BUSHING		K0B1122AL	CHEFTOP MM LEFT DOOR LOWER BEAM KIT	<table border="1"> <thead> <tr> <th>Code</th> <th>Description</th> <th>Qty</th> <th>UOM</th> </tr> </thead> <tbody> <tr> <td>VM2103A0</td> <td>CLAMP LOCK</td> <td>2</td> <td>PZ</td> </tr> <tr> <td>VM2267A0</td> <td>INTERNAL GLASS LOCKING SYSTEM SLIDER</td> <td>1</td> <td>PZ</td> </tr> <tr> <td>VM2269A0</td> <td>INTERNAL GLASS LOCKING SYSTEM CAP</td> <td>1</td> <td>PZ</td> </tr> <tr> <td>VM2274A0</td> <td>GROOVED BUSHING</td> <td>1</td> <td>PZ</td> </tr> <tr> <td>VM2305A0</td> <td>6 SERIES DOOR CAP FIXING PAWL</td> <td>7</td> <td>PZ</td> </tr> <tr> <td>VM2384A0</td> <td>MM LEFT DOOR RIGHT LOWER CAP</td> <td>1</td> <td>PZ</td> </tr> <tr> <td>VM2384A0</td> <td>MM LEFT DOOR RIGHT LOWER CAP</td> <td>1</td> <td>PZ</td> </tr> <tr> <td>VM2386A1</td> <td>LEFT MM DOOR LOWER LEFT CAP</td> <td>1</td> <td>PZ</td> </tr> <tr> <td>VM2386A1</td> <td>LEFT MM DOOR LOWER LEFT CAP</td> <td>1</td> <td>PZ</td> </tr> </tbody> </table>	Code	Description	Qty	UOM	VM2103A0	CLAMP LOCK	2	PZ	VM2267A0	INTERNAL GLASS LOCKING SYSTEM SLIDER	1	PZ	VM2269A0	INTERNAL GLASS LOCKING SYSTEM CAP	1	PZ	VM2274A0	GROOVED BUSHING	1	PZ	VM2305A0	6 SERIES DOOR CAP FIXING PAWL	7	PZ	VM2384A0	MM LEFT DOOR RIGHT LOWER CAP	1	PZ	VM2384A0	MM LEFT DOOR RIGHT LOWER CAP	1	PZ	VM2386A1	LEFT MM DOOR LOWER LEFT CAP	1	PZ	VM2386A1	LEFT MM DOOR LOWER LEFT CAP	1	PZ
Code	Description	Qty	UOM																																										
VM2103A0	CLAMP LOCK	2	PZ																																										
VM2267A0	INTERNAL GLASS LOCKING SYSTEM SLIDER	1	PZ																																										
VM2269A0	INTERNAL GLASS LOCKING SYSTEM CAP	1	PZ																																										
VM2274A0	GROOVED BUSHING	1	PZ																																										
VM2305A0	6 SERIES DOOR CAP FIXING PAWL	7	PZ																																										
VM2384A0	MM LEFT DOOR RIGHT LOWER CAP	1	PZ																																										
VM2384A0	MM LEFT DOOR RIGHT LOWER CAP	1	PZ																																										
VM2386A1	LEFT MM DOOR LOWER LEFT CAP	1	PZ																																										
VM2386A1	LEFT MM DOOR LOWER LEFT CAP	1	PZ																																										
VM2305A	6 SERIES DOOR CAP FIXING PAWL		KVM2305A	MM FIXING DOOR THUB SCREWS 10 PCS KIT	<table border="1"> <thead> <tr> <th>Code</th> <th>Description</th> <th>Qty</th> <th>UOM</th> </tr> </thead> <tbody> <tr> <td>VM1224A0</td> <td>65MY 220MM 2 COLOURS SHRINK TUBE</td> <td>0.200</td> <td>M</td> </tr> <tr> <td>VM2305A0</td> <td>6 SERIES DOOR CAP FIXING PAWL</td> <td>10</td> <td>PZ</td> </tr> </tbody> </table>	Code	Description	Qty	UOM	VM1224A0	65MY 220MM 2 COLOURS SHRINK TUBE	0.200	M	VM2305A0	6 SERIES DOOR CAP FIXING PAWL	10	PZ																												
Code	Description	Qty	UOM																																										
VM1224A0	65MY 220MM 2 COLOURS SHRINK TUBE	0.200	M																																										
VM2305A0	6 SERIES DOOR CAP FIXING PAWL	10	PZ																																										
VI1996A	M5X35 SCREW		VI1996A0	M5X35 SCREW																																									

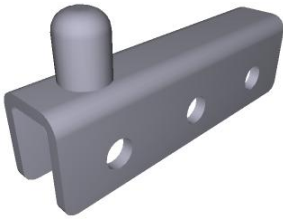

COMPONENT			SPARE PART																																						
Code	Description	Image	Code	Description	Components list																																				
VI1930A	ST. STEEL 5X20 CHIP SCREW		VI1930A1	ST. STEEL 5X20 CHIP SCREW																																					
VP1080A	UPPER HINGE CAP FOR LOWER INNER GLASS		KVM2383B	MM -M LEFT DOOR RIGHT UPPER CAP KIT	<table border="1"> <thead> <tr> <th>Code</th> <th>Description</th> <th>Qty</th> <th>UOM</th> </tr> </thead> <tbody> <tr> <td>VI1074A0</td> <td>4X16 SCREW FOR PLASTIC</td> <td>1</td> <td>PZ</td> </tr> <tr> <td>VI1930A1</td> <td>ST. STEEL 5X20 CHIP SCREW</td> <td>4</td> <td>PZ</td> </tr> <tr> <td>VI1996A0</td> <td>M5X35 SCREW</td> <td>3</td> <td>PZ</td> </tr> <tr> <td>VM2275A0</td> <td>SMOOTH BUSHING</td> <td>1</td> <td>PZ</td> </tr> <tr> <td>VM2305A0</td> <td>6 SERIES DOOR CAP FIXING PAWL</td> <td>3</td> <td>PZ</td> </tr> <tr> <td>VM2383B0</td> <td>S6 LEFT OVENS UPPER RIGHT CAP</td> <td>1</td> <td>PZ</td> </tr> <tr> <td>VP1080A0</td> <td>UPPER HINGE CAP FOR LOWER INNER GLASS</td> <td>1</td> <td>PZ</td> </tr> </tbody> </table>	Code	Description	Qty	UOM	VI1074A0	4X16 SCREW FOR PLASTIC	1	PZ	VI1930A1	ST. STEEL 5X20 CHIP SCREW	4	PZ	VI1996A0	M5X35 SCREW	3	PZ	VM2275A0	SMOOTH BUSHING	1	PZ	VM2305A0	6 SERIES DOOR CAP FIXING PAWL	3	PZ	VM2383B0	S6 LEFT OVENS UPPER RIGHT CAP	1	PZ	VP1080A0	UPPER HINGE CAP FOR LOWER INNER GLASS	1	PZ				
Code	Description	Qty	UOM																																						
VI1074A0	4X16 SCREW FOR PLASTIC	1	PZ																																						
VI1930A1	ST. STEEL 5X20 CHIP SCREW	4	PZ																																						
VI1996A0	M5X35 SCREW	3	PZ																																						
VM2275A0	SMOOTH BUSHING	1	PZ																																						
VM2305A0	6 SERIES DOOR CAP FIXING PAWL	3	PZ																																						
VM2383B0	S6 LEFT OVENS UPPER RIGHT CAP	1	PZ																																						
VP1080A0	UPPER HINGE CAP FOR LOWER INNER GLASS	1	PZ																																						
			KVM2259B	MM -M RIGHT DOOR LEFT LOWER CAP KI	<table border="1"> <thead> <tr> <th>Code</th> <th>Description</th> <th>Qty</th> <th>UOM</th> </tr> </thead> <tbody> <tr> <td>VI1103A0</td> <td>40X12 TBSP SCREW FOR PLASTIC</td> <td>1</td> <td>PZ</td> </tr> <tr> <td>VI1930A1</td> <td>ST. STEEL 5X20 CHIP SCREW</td> <td>4</td> <td>PZ</td> </tr> <tr> <td>VI1996A0</td> <td>M5X35 SCREW</td> <td>3</td> <td>PZ</td> </tr> <tr> <td>VM1224A0</td> <td>65MY 220MM 2 COLOURS SHRINK TUBE</td> <td>0.300</td> <td>M</td> </tr> <tr> <td>VM2259B0</td> <td></td> <td>1</td> <td>PZ</td> </tr> <tr> <td>VM2274A0</td> <td>GROOVED BUSHING</td> <td>1</td> <td>PZ</td> </tr> <tr> <td>VM2305A0</td> <td>6 SERIES DOOR CAP FIXING PAWL</td> <td>3</td> <td>PZ</td> </tr> <tr> <td>VP1080A0</td> <td>UPPER HINGE CAP FOR LOWER INNER GLASS</td> <td>1</td> <td>PZ</td> </tr> </tbody> </table>	Code	Description	Qty	UOM	VI1103A0	40X12 TBSP SCREW FOR PLASTIC	1	PZ	VI1930A1	ST. STEEL 5X20 CHIP SCREW	4	PZ	VI1996A0	M5X35 SCREW	3	PZ	VM1224A0	65MY 220MM 2 COLOURS SHRINK TUBE	0.300	M	VM2259B0		1	PZ	VM2274A0	GROOVED BUSHING	1	PZ	VM2305A0	6 SERIES DOOR CAP FIXING PAWL	3	PZ	VP1080A0	UPPER HINGE CAP FOR LOWER INNER GLASS	1	PZ
Code	Description	Qty	UOM																																						
VI1103A0	40X12 TBSP SCREW FOR PLASTIC	1	PZ																																						
VI1930A1	ST. STEEL 5X20 CHIP SCREW	4	PZ																																						
VI1996A0	M5X35 SCREW	3	PZ																																						
VM1224A0	65MY 220MM 2 COLOURS SHRINK TUBE	0.300	M																																						
VM2259B0		1	PZ																																						
VM2274A0	GROOVED BUSHING	1	PZ																																						
VM2305A0	6 SERIES DOOR CAP FIXING PAWL	3	PZ																																						
VP1080A0	UPPER HINGE CAP FOR LOWER INNER GLASS	1	PZ																																						

COMPONENT			SPARE PART																																						
Code	Description	Image	Code	Description	Components list																																				
VM2259B			KVM2259B	MM -M RIGHT DOOR LEFT LOWER CAP KI	<table border="1"> <thead> <tr> <th>Code</th> <th>Description</th> <th>Qty</th> <th>UOM</th> </tr> </thead> <tbody> <tr> <td>VI1103A0</td> <td>40X12 TBSP SCREW FOR PLASTIC</td> <td>1</td> <td>PZ</td> </tr> <tr> <td>VI1930A1</td> <td>ST. STEEL 5X20 CHIP SCREW</td> <td>4</td> <td>PZ</td> </tr> <tr> <td>VI1996A0</td> <td>M5X35 SCREW</td> <td>3</td> <td>PZ</td> </tr> <tr> <td>VM1224A0</td> <td>65MY 220MM 2 COLOURS SHRINK TUBE</td> <td>0.300</td> <td>M</td> </tr> <tr> <td>VM2259B0</td> <td></td> <td>1</td> <td>PZ</td> </tr> <tr> <td>VM2274A0</td> <td>GROOVED BUSHING</td> <td>1</td> <td>PZ</td> </tr> <tr> <td>VM2305A0</td> <td>6 SERIES DOOR CAP FIXING PAWL</td> <td>3</td> <td>PZ</td> </tr> <tr> <td>VP1080A0</td> <td>UPPER HINGE CAP FOR LOWER INNER GLASS</td> <td>1</td> <td>PZ</td> </tr> </tbody> </table>	Code	Description	Qty	UOM	VI1103A0	40X12 TBSP SCREW FOR PLASTIC	1	PZ	VI1930A1	ST. STEEL 5X20 CHIP SCREW	4	PZ	VI1996A0	M5X35 SCREW	3	PZ	VM1224A0	65MY 220MM 2 COLOURS SHRINK TUBE	0.300	M	VM2259B0		1	PZ	VM2274A0	GROOVED BUSHING	1	PZ	VM2305A0	6 SERIES DOOR CAP FIXING PAWL	3	PZ	VP1080A0	UPPER HINGE CAP FOR LOWER INNER GLASS	1	PZ
Code	Description	Qty	UOM																																						
VI1103A0	40X12 TBSP SCREW FOR PLASTIC	1	PZ																																						
VI1930A1	ST. STEEL 5X20 CHIP SCREW	4	PZ																																						
VI1996A0	M5X35 SCREW	3	PZ																																						
VM1224A0	65MY 220MM 2 COLOURS SHRINK TUBE	0.300	M																																						
VM2259B0		1	PZ																																						
VM2274A0	GROOVED BUSHING	1	PZ																																						
VM2305A0	6 SERIES DOOR CAP FIXING PAWL	3	PZ																																						
VP1080A0	UPPER HINGE CAP FOR LOWER INNER GLASS	1	PZ																																						
0B1113B			0B1113B0																																						
0B1216B			0B1216B0																																						
VM2316A	CONTROL BOARD H10 COOLING FAN HOLDER		KVM2316A	PANEL COOLING FAN SUPPORT KIT	<table border="1"> <thead> <tr> <th>Code</th> <th>Description</th> <th>Qty</th> <th>UOM</th> </tr> </thead> <tbody> <tr> <td>VM1224A0</td> <td>65MY 220MM 2 COLOURS SHRINK TUBE</td> <td>0.150</td> <td>M</td> </tr> <tr> <td>VM2316A0</td> <td>CONTROL BOARD H10 COOLING FAN HOLDER</td> <td>1</td> <td>PZ</td> </tr> </tbody> </table>	Code	Description	Qty	UOM	VM1224A0	65MY 220MM 2 COLOURS SHRINK TUBE	0.150	M	VM2316A0	CONTROL BOARD H10 COOLING FAN HOLDER	1	PZ																								
Code	Description	Qty	UOM																																						
VM1224A0	65MY 220MM 2 COLOURS SHRINK TUBE	0.150	M																																						
VM2316A0	CONTROL BOARD H10 COOLING FAN HOLDER	1	PZ																																						



COMPONENT			SPARE PART																						
Code	Description	Image	Code	Description	Components list																				
VN1177A	CONTROL BOARD COOLING FAN		KVN1177A	CONTROL BOARD COOLING FAN KIT	<table border="1"> <thead> <tr> <th>Code</th> <th>Description</th> <th>Qty</th> <th>UOM</th> </tr> </thead> <tbody> <tr> <td>MOV0019A0</td> <td>HOOD RING GASKET GN1110A2</td> <td>0.100</td> <td>PZ</td> </tr> <tr> <td>VM1224A0</td> <td>65MY 220MM 2 COLOURS SHRINK TUBE</td> <td>0.150</td> <td>M</td> </tr> <tr> <td>VN1177A0</td> <td>CONTROL BOARD COOLING FAN</td> <td>1</td> <td>PZ</td> </tr> <tr> <td>VN1177A0</td> <td>CONTROL BOARD COOLING FAN</td> <td>1</td> <td>PZ</td> </tr> </tbody> </table>	Code	Description	Qty	UOM	MOV0019A0	HOOD RING GASKET GN1110A2	0.100	PZ	VM1224A0	65MY 220MM 2 COLOURS SHRINK TUBE	0.150	M	VN1177A0	CONTROL BOARD COOLING FAN	1	PZ	VN1177A0	CONTROL BOARD COOLING FAN	1	PZ
					Code	Description	Qty	UOM																	
					MOV0019A0	HOOD RING GASKET GN1110A2	0.100	PZ																	
					VM1224A0	65MY 220MM 2 COLOURS SHRINK TUBE	0.150	M																	
VN1177A0	CONTROL BOARD COOLING FAN	1	PZ																						
VN1177A0	CONTROL BOARD COOLING FAN	1	PZ																						
PE1063A	MM ZERO CONTROL BOARD		KPE1063A	MM ZERO CONTROL BOARD KIT	<table border="1"> <thead> <tr> <th>Code</th> <th>Description</th> <th>Qty</th> <th>UOM</th> </tr> </thead> <tbody> <tr> <td>PE1063A0</td> <td>MM ZERO CONTROL BOARD</td> <td>1</td> <td>PZ</td> </tr> <tr> <td>VI1074A0</td> <td>4X16 SCREW FOR PLASTIC</td> <td>2</td> <td>PZ</td> </tr> <tr> <td>VM2147A0</td> <td>410X343X15 MM PINK SMOOTH ESD SPONGE</td> <td>1</td> <td>PZ</td> </tr> </tbody> </table>	Code	Description	Qty	UOM	PE1063A0	MM ZERO CONTROL BOARD	1	PZ	VI1074A0	4X16 SCREW FOR PLASTIC	2	PZ	VM2147A0	410X343X15 MM PINK SMOOTH ESD SPONGE	1	PZ				
					Code	Description	Qty	UOM																	
					PE1063A0	MM ZERO CONTROL BOARD	1	PZ																	
VI1074A0	4X16 SCREW FOR PLASTIC	2	PZ																						
VM2147A0	410X343X15 MM PINK SMOOTH ESD SPONGE	1	PZ																						
PE1071A	MM ZERO USB-RESET SUPPORT		KPE1071A	MIND.MAPS ZERO USB-RESET SUPPORT KIT	<table border="1"> <thead> <tr> <th>Code</th> <th>Description</th> <th>Qty</th> <th>UOM</th> </tr> </thead> <tbody> <tr> <td>PE1071A0</td> <td>MM ZERO USB-RESET SUPPORT</td> <td>1</td> <td>PZ</td> </tr> <tr> <td>VI1220A1</td> <td>4.2X12 TCB SELF-TAPPIN G SCREW</td> <td>2</td> <td>PZ</td> </tr> <tr> <td>VM2147A0</td> <td>410X343X15 MM PINK SMOOTH ESD SPONGE</td> <td>0.250</td> <td>PZ</td> </tr> </tbody> </table>	Code	Description	Qty	UOM	PE1071A0	MM ZERO USB-RESET SUPPORT	1	PZ	VI1220A1	4.2X12 TCB SELF-TAPPIN G SCREW	2	PZ	VM2147A0	410X343X15 MM PINK SMOOTH ESD SPONGE	0.250	PZ				
					Code	Description	Qty	UOM																	
					PE1071A0	MM ZERO USB-RESET SUPPORT	1	PZ																	
VI1220A1	4.2X12 TCB SELF-TAPPIN G SCREW	2	PZ																						
VM2147A0	410X343X15 MM PINK SMOOTH ESD SPONGE	0.250	PZ																						
VT1281B	XEVC-0711 643X624X6 INNER SINGLE GLASS		KVT1281B	0711 INTERNAL SINGLE GLASS KIT	<table border="1"> <thead> <tr> <th>Code</th> <th>Description</th> <th>Qty</th> <th>UOM</th> </tr> </thead> <tbody> <tr> <td>IP1508A1</td> <td>POLYSTYREN E U SHAPED PROFILE 2000X60X60</td> <td>1</td> <td>M</td> </tr> <tr> <td>VM1059A1</td> <td>HEAT SHRINK FILM H800</td> <td>1.500</td> <td>M</td> </tr> <tr> <td>VT1281B0</td> <td>XEVC-0711 643X624X6 INNER SINGLE GLASS</td> <td>1</td> <td>PZ</td> </tr> </tbody> </table>	Code	Description	Qty	UOM	IP1508A1	POLYSTYREN E U SHAPED PROFILE 2000X60X60	1	M	VM1059A1	HEAT SHRINK FILM H800	1.500	M	VT1281B0	XEVC-0711 643X624X6 INNER SINGLE GLASS	1	PZ				
					Code	Description	Qty	UOM																	
					IP1508A1	POLYSTYREN E U SHAPED PROFILE 2000X60X60	1	M																	
VM1059A1	HEAT SHRINK FILM H800	1.500	M																						
VT1281B0	XEVC-0711 643X624X6 INNER SINGLE GLASS	1	PZ																						

COMPONENT			SPARE PART																																		
Code	Description	Image	Code	Description	Components list																																
CR1103A	INTERNAL GLASS ST. STEEL UPPER HINGE		XRF033	MM ONE INT GLASS HINGES RETROFIT KIT	<table border="1"> <thead> <tr> <th>Code</th> <th>Description</th> <th>Qty</th> <th>UOM</th> </tr> </thead> <tbody> <tr> <td>0H1928A0</td> <td></td> <td>1</td> <td>PZ</td> </tr> <tr> <td>CR1103A0</td> <td>INTERNAL GLASS ST. STEEL UPPER HINGE</td> <td>1</td> <td>PZ</td> </tr> <tr> <td>CR1104A0</td> <td>INTERNAL GLASS ST. STEEL LOWER HINGE</td> <td>1</td> <td>PZ</td> </tr> <tr> <td>GN1182A1</td> <td>INTERNAL GLASS HINGE CR1103-1104 SEAL</td> <td>2</td> <td>PZ</td> </tr> <tr> <td>VI1810A0</td> <td>M6X6 STAINLESS STEEL FLATHEAD SCREW</td> <td>6</td> <td>PZ</td> </tr> <tr> <td>VM1224A0</td> <td>65MY 220MM 2 COLOURS SHRINK TUBE</td> <td>0.300</td> <td>M</td> </tr> <tr> <td>VM2399A0</td> <td>DOOR HINGES HEADLESS SCREWS COVER</td> <td>2</td> <td>PZ</td> </tr> </tbody> </table>	Code	Description	Qty	UOM	0H1928A0		1	PZ	CR1103A0	INTERNAL GLASS ST. STEEL UPPER HINGE	1	PZ	CR1104A0	INTERNAL GLASS ST. STEEL LOWER HINGE	1	PZ	GN1182A1	INTERNAL GLASS HINGE CR1103-1104 SEAL	2	PZ	VI1810A0	M6X6 STAINLESS STEEL FLATHEAD SCREW	6	PZ	VM1224A0	65MY 220MM 2 COLOURS SHRINK TUBE	0.300	M	VM2399A0	DOOR HINGES HEADLESS SCREWS COVER	2	PZ
					Code	Description	Qty	UOM																													
0H1928A0		1	PZ																																		
CR1103A0	INTERNAL GLASS ST. STEEL UPPER HINGE	1	PZ																																		
CR1104A0	INTERNAL GLASS ST. STEEL LOWER HINGE	1	PZ																																		
GN1182A1	INTERNAL GLASS HINGE CR1103-1104 SEAL	2	PZ																																		
VI1810A0	M6X6 STAINLESS STEEL FLATHEAD SCREW	6	PZ																																		
VM1224A0	65MY 220MM 2 COLOURS SHRINK TUBE	0.300	M																																		
VM2399A0	DOOR HINGES HEADLESS SCREWS COVER	2	PZ																																		
VM2399A	DOOR HINGES HEADLESS SCREWS COVER		VM2399A0	DOOR HINGES HEADLESS SCREWS COVER																																	
GN1182A	INTERNAL GLASS HINGE CR1103-1104 SEAL		XRF033	MM ONE INT GLASS HINGES RETROFIT KIT	<table border="1"> <thead> <tr> <th>Code</th> <th>Description</th> <th>Qty</th> <th>UOM</th> </tr> </thead> <tbody> <tr> <td>0H1928A0</td> <td></td> <td>1</td> <td>PZ</td> </tr> <tr> <td>CR1103A0</td> <td>INTERNAL GLASS ST. STEEL UPPER HINGE</td> <td>1</td> <td>PZ</td> </tr> <tr> <td>CR1104A0</td> <td>INTERNAL GLASS ST. STEEL LOWER HINGE</td> <td>1</td> <td>PZ</td> </tr> <tr> <td>GN1182A1</td> <td>INTERNAL GLASS HINGE CR1103-1104 SEAL</td> <td>2</td> <td>PZ</td> </tr> <tr> <td>VI1810A0</td> <td>M6X6 STAINLESS STEEL FLATHEAD SCREW</td> <td>6</td> <td>PZ</td> </tr> </tbody> </table>	Code	Description	Qty	UOM	0H1928A0		1	PZ	CR1103A0	INTERNAL GLASS ST. STEEL UPPER HINGE	1	PZ	CR1104A0	INTERNAL GLASS ST. STEEL LOWER HINGE	1	PZ	GN1182A1	INTERNAL GLASS HINGE CR1103-1104 SEAL	2	PZ	VI1810A0	M6X6 STAINLESS STEEL FLATHEAD SCREW	6	PZ								
					Code	Description	Qty	UOM																													
0H1928A0		1	PZ																																		
CR1103A0	INTERNAL GLASS ST. STEEL UPPER HINGE	1	PZ																																		
CR1104A0	INTERNAL GLASS ST. STEEL LOWER HINGE	1	PZ																																		
GN1182A1	INTERNAL GLASS HINGE CR1103-1104 SEAL	2	PZ																																		
VI1810A0	M6X6 STAINLESS STEEL FLATHEAD SCREW	6	PZ																																		

COMPONENT			SPARE PART																																		
Code	Description	Image	Code	Description	Components list																																
GN1182A	INTERNAL GLASS HINGE CR1103-1104 SEAL		XRF033	MM ONE INT GLASS HINGES RETROFIT KIT	<table border="1"> <thead> <tr> <th>Code</th> <th>Description</th> <th>Qty</th> <th>UOM</th> </tr> </thead> <tbody> <tr> <td>VM1224A0</td> <td>65MY 220MM 2 COLOURS SHRINK TUBE</td> <td>0.300</td> <td>M</td> </tr> <tr> <td>VM2399A0</td> <td>DOOR HINGES HEADLESS SCREWS COVER</td> <td>2</td> <td>PZ</td> </tr> </tbody> </table>	Code	Description	Qty	UOM	VM1224A0	65MY 220MM 2 COLOURS SHRINK TUBE	0.300	M	VM2399A0	DOOR HINGES HEADLESS SCREWS COVER	2	PZ																				
Code	Description	Qty	UOM																																		
VM1224A0	65MY 220MM 2 COLOURS SHRINK TUBE	0.300	M																																		
VM2399A0	DOOR HINGES HEADLESS SCREWS COVER	2	PZ																																		
CR1104A	INTERNAL GLASS ST. STEEL LOWER HINGE		XRF033	MM ONE INT GLASS HINGES RETROFIT KIT	<table border="1"> <thead> <tr> <th>Code</th> <th>Description</th> <th>Qty</th> <th>UOM</th> </tr> </thead> <tbody> <tr> <td>0H1928A0</td> <td></td> <td>1</td> <td>PZ</td> </tr> <tr> <td>CR1103A0</td> <td>INTERNAL GLASS ST. STEEL UPPER HINGE</td> <td>1</td> <td>PZ</td> </tr> <tr> <td>CR1104A0</td> <td>INTERNAL GLASS ST. STEEL LOWER HINGE</td> <td>1</td> <td>PZ</td> </tr> <tr> <td>GN1182A1</td> <td>INTERNAL GLASS HINGE CR1103-1104 SEAL</td> <td>2</td> <td>PZ</td> </tr> <tr> <td>VI1810A0</td> <td>M6X6 STAINLESS STEEL FLATHEAD SCREW</td> <td>6</td> <td>PZ</td> </tr> <tr> <td>VM1224A0</td> <td>65MY 220MM 2 COLOURS SHRINK TUBE</td> <td>0.300</td> <td>M</td> </tr> <tr> <td>VM2399A0</td> <td>DOOR HINGES HEADLESS SCREWS COVER</td> <td>2</td> <td>PZ</td> </tr> </tbody> </table>	Code	Description	Qty	UOM	0H1928A0		1	PZ	CR1103A0	INTERNAL GLASS ST. STEEL UPPER HINGE	1	PZ	CR1104A0	INTERNAL GLASS ST. STEEL LOWER HINGE	1	PZ	GN1182A1	INTERNAL GLASS HINGE CR1103-1104 SEAL	2	PZ	VI1810A0	M6X6 STAINLESS STEEL FLATHEAD SCREW	6	PZ	VM1224A0	65MY 220MM 2 COLOURS SHRINK TUBE	0.300	M	VM2399A0	DOOR HINGES HEADLESS SCREWS COVER	2	PZ
Code	Description	Qty	UOM																																		
0H1928A0		1	PZ																																		
CR1103A0	INTERNAL GLASS ST. STEEL UPPER HINGE	1	PZ																																		
CR1104A0	INTERNAL GLASS ST. STEEL LOWER HINGE	1	PZ																																		
GN1182A1	INTERNAL GLASS HINGE CR1103-1104 SEAL	2	PZ																																		
VI1810A0	M6X6 STAINLESS STEEL FLATHEAD SCREW	6	PZ																																		
VM1224A0	65MY 220MM 2 COLOURS SHRINK TUBE	0.300	M																																		
VM2399A0	DOOR HINGES HEADLESS SCREWS COVER	2	PZ																																		
VM2399A	DOOR HINGES HEADLESS SCREWS COVER		VM2399A0	DOOR HINGES HEADLESS SCREWS COVER																																	

COMPONENT			SPARE PART																																		
Code	Description	Image	Code	Description	Components list																																
GN1182A	INTERNAL GLASS HINGE CR1103-1104 SEAL		XRF033	MM ONE INT GLASS HINGES RETROFIT KIT	<table border="1"> <thead> <tr> <th>Code</th> <th>Description</th> <th>Qty</th> <th>UOM</th> </tr> </thead> <tbody> <tr> <td>0H1928A0</td> <td></td> <td>1</td> <td>PZ</td> </tr> <tr> <td>CR1103A0</td> <td>INTERNAL GLASS ST. STEEL UPPER HINGE</td> <td>1</td> <td>PZ</td> </tr> <tr> <td>CR1104A0</td> <td>INTERNAL GLASS ST. STEEL LOWER HINGE</td> <td>1</td> <td>PZ</td> </tr> <tr> <td>GN1182A1</td> <td>INTERNAL GLASS HINGE CR1103-1104 SEAL</td> <td>2</td> <td>PZ</td> </tr> <tr> <td>VI1810A0</td> <td>M6X6 STAINLESS STEEL FLATHEAD SCREW</td> <td>6</td> <td>PZ</td> </tr> <tr> <td>VM1224A0</td> <td>65MY 220MM 2 COLOURS SHRINK TUBE</td> <td>0.300</td> <td>M</td> </tr> <tr> <td>VM2399A0</td> <td>DOOR HINGES HEADLESS SCREWS COVER</td> <td>2</td> <td>PZ</td> </tr> </tbody> </table>	Code	Description	Qty	UOM	0H1928A0		1	PZ	CR1103A0	INTERNAL GLASS ST. STEEL UPPER HINGE	1	PZ	CR1104A0	INTERNAL GLASS ST. STEEL LOWER HINGE	1	PZ	GN1182A1	INTERNAL GLASS HINGE CR1103-1104 SEAL	2	PZ	VI1810A0	M6X6 STAINLESS STEEL FLATHEAD SCREW	6	PZ	VM1224A0	65MY 220MM 2 COLOURS SHRINK TUBE	0.300	M	VM2399A0	DOOR HINGES HEADLESS SCREWS COVER	2	PZ
Code	Description	Qty	UOM																																		
0H1928A0		1	PZ																																		
CR1103A0	INTERNAL GLASS ST. STEEL UPPER HINGE	1	PZ																																		
CR1104A0	INTERNAL GLASS ST. STEEL LOWER HINGE	1	PZ																																		
GN1182A1	INTERNAL GLASS HINGE CR1103-1104 SEAL	2	PZ																																		
VI1810A0	M6X6 STAINLESS STEEL FLATHEAD SCREW	6	PZ																																		
VM1224A0	65MY 220MM 2 COLOURS SHRINK TUBE	0.300	M																																		
VM2399A0	DOOR HINGES HEADLESS SCREWS COVER	2	PZ																																		
VM1630A	INTERNAL GLASS PUSHING CAP		KVM1630A	CAP FOR INTERNAL GLASS 10 PCS KIT	<table border="1"> <thead> <tr> <th>Code</th> <th>Description</th> <th>Qty</th> <th>UOM</th> </tr> </thead> <tbody> <tr> <td>VM1224A0</td> <td>65MY 220MM 2 COLOURS SHRINK TUBE</td> <td>0.200</td> <td>M</td> </tr> <tr> <td>VM1630A0</td> <td>INTERNAL GLASS PUSHING CAP</td> <td>10</td> <td>PZ</td> </tr> <tr> <td>VM1630A1</td> <td>INTERNAL GLASS PUSHING CAP</td> <td>10</td> <td>PZ</td> </tr> </tbody> </table>	Code	Description	Qty	UOM	VM1224A0	65MY 220MM 2 COLOURS SHRINK TUBE	0.200	M	VM1630A0	INTERNAL GLASS PUSHING CAP	10	PZ	VM1630A1	INTERNAL GLASS PUSHING CAP	10	PZ																
Code	Description	Qty	UOM																																		
VM1224A0	65MY 220MM 2 COLOURS SHRINK TUBE	0.200	M																																		
VM1630A0	INTERNAL GLASS PUSHING CAP	10	PZ																																		
VM1630A1	INTERNAL GLASS PUSHING CAP	10	PZ																																		
VM2315B	S6 INTERNAL GLASS SUPPORT		KVM2315B	3 PCS MM -M INTERNAL GLASS SUPPORT KIT	<table border="1"> <thead> <tr> <th>Code</th> <th>Description</th> <th>Qty</th> <th>UOM</th> </tr> </thead> <tbody> <tr> <td>VI1220A1</td> <td>4,2X12 TCB SELF-TAPPIN G SCREW</td> <td>3</td> <td>PZ</td> </tr> <tr> <td>VM1224A0</td> <td>65MY 220MM 2 COLOURS SHRINK TUBE</td> <td>0.200</td> <td>M</td> </tr> <tr> <td>VM1630A1</td> <td>INTERNAL GLASS PUSHING CAP</td> <td>3</td> <td>PZ</td> </tr> <tr> <td>VM2315B0</td> <td>S6 INTERNAL GLASS SUPPORT</td> <td>3</td> <td>PZ</td> </tr> </tbody> </table>	Code	Description	Qty	UOM	VI1220A1	4,2X12 TCB SELF-TAPPIN G SCREW	3	PZ	VM1224A0	65MY 220MM 2 COLOURS SHRINK TUBE	0.200	M	VM1630A1	INTERNAL GLASS PUSHING CAP	3	PZ	VM2315B0	S6 INTERNAL GLASS SUPPORT	3	PZ												
Code	Description	Qty	UOM																																		
VI1220A1	4,2X12 TCB SELF-TAPPIN G SCREW	3	PZ																																		
VM1224A0	65MY 220MM 2 COLOURS SHRINK TUBE	0.200	M																																		
VM1630A1	INTERNAL GLASS PUSHING CAP	3	PZ																																		
VM2315B0	S6 INTERNAL GLASS SUPPORT	3	PZ																																		



COMPONENT			SPARE PART																																																										
Code	Description	Image	Code	Description	Components list																																																								
MG1099A	MIND.MAPS -M COMPLETE HANDLE		KMG1099A	MIND.MAPS SERIES HANDLE KIT -M	<table border="1"> <thead> <tr> <th>Code</th> <th>Description</th> <th>Qty</th> <th>UOM</th> </tr> </thead> <tbody> <tr> <td>0H7321A0</td> <td>MM STAINLESS STEEL HANDLE COVE</td> <td>1</td> <td>PZ</td> </tr> <tr> <td>MG1099A1</td> <td></td> <td>1</td> <td>PZ</td> </tr> <tr> <td>RC1200A0</td> <td>ED=4 WIRE D.=0.5 COMPRESSIO N SPRING</td> <td>4</td> <td>PZ</td> </tr> <tr> <td>VI0239A1</td> <td>SELF-TAPPIN G SCREW 4.2X25 TCB+ INOX</td> <td>8</td> <td>PZ</td> </tr> <tr> <td>VI1220A1</td> <td>4.2X12 TCB SELF-TAPPIN G SCREW</td> <td>2</td> <td>PZ</td> </tr> <tr> <td>VM1182B1</td> <td>E.S. CT BT HANDLE JUNCTION + PIN GUIDE</td> <td>1</td> <td>PZ</td> </tr> <tr> <td>VM1490A0</td> <td>CHEFTOP/BAK ERTOP HANDLE SCREWS COVER</td> <td>4</td> <td>PZ</td> </tr> <tr> <td>VM1695A0</td> <td>HANDLE POSITION PIN</td> <td>4</td> <td>PZ</td> </tr> <tr> <td>VM2245A0</td> <td>HANDLE SHAFT WITH LATCH</td> <td>1</td> <td>PZ</td> </tr> <tr> <td>VM2247B0</td> <td>HANDLE SHAFT COVER VM2245-2246</td> <td>1</td> <td>PZ</td> </tr> <tr> <td>VM2248B0</td> <td>HANDLE WITH LATCH CLOSING KEY</td> <td>1</td> <td>PZ</td> </tr> <tr> <td>VM2295A1</td> <td>MIND.MAPS TOUCH CONTROL STYLUS KIT</td> <td>1</td> <td>PZ</td> </tr> <tr> <td>VP1076A0</td> <td>PLUS ONE ZERO HANDLE PIN</td> <td>1</td> <td>PZ</td> </tr> </tbody> </table>	Code	Description	Qty	UOM	0H7321A0	MM STAINLESS STEEL HANDLE COVE	1	PZ	MG1099A1		1	PZ	RC1200A0	ED=4 WIRE D.=0.5 COMPRESSIO N SPRING	4	PZ	VI0239A1	SELF-TAPPIN G SCREW 4.2X25 TCB+ INOX	8	PZ	VI1220A1	4.2X12 TCB SELF-TAPPIN G SCREW	2	PZ	VM1182B1	E.S. CT BT HANDLE JUNCTION + PIN GUIDE	1	PZ	VM1490A0	CHEFTOP/BAK ERTOP HANDLE SCREWS COVER	4	PZ	VM1695A0	HANDLE POSITION PIN	4	PZ	VM2245A0	HANDLE SHAFT WITH LATCH	1	PZ	VM2247B0	HANDLE SHAFT COVER VM2245-2246	1	PZ	VM2248B0	HANDLE WITH LATCH CLOSING KEY	1	PZ	VM2295A1	MIND.MAPS TOUCH CONTROL STYLUS KIT	1	PZ	VP1076A0	PLUS ONE ZERO HANDLE PIN	1	PZ
					Code	Description	Qty	UOM																																																					
					0H7321A0	MM STAINLESS STEEL HANDLE COVE	1	PZ																																																					
					MG1099A1		1	PZ																																																					
					RC1200A0	ED=4 WIRE D.=0.5 COMPRESSIO N SPRING	4	PZ																																																					
					VI0239A1	SELF-TAPPIN G SCREW 4.2X25 TCB+ INOX	8	PZ																																																					
					VI1220A1	4.2X12 TCB SELF-TAPPIN G SCREW	2	PZ																																																					
					VM1182B1	E.S. CT BT HANDLE JUNCTION + PIN GUIDE	1	PZ																																																					
					VM1490A0	CHEFTOP/BAK ERTOP HANDLE SCREWS COVER	4	PZ																																																					
					VM1695A0	HANDLE POSITION PIN	4	PZ																																																					
					VM2245A0	HANDLE SHAFT WITH LATCH	1	PZ																																																					
					VM2247B0	HANDLE SHAFT COVER VM2245-2246	1	PZ																																																					
					VM2248B0	HANDLE WITH LATCH CLOSING KEY	1	PZ																																																					
VM2295A1	MIND.MAPS TOUCH CONTROL STYLUS KIT	1	PZ																																																										
VP1076A0	PLUS ONE ZERO HANDLE PIN	1	PZ																																																										
0B1112A	0711 RIGHT - DOOR LEFT INT COLUMN		0B1112A2	0711 RIGHT - DOOR LEFT INT COLUMN																																																									



COMPONENT			SPARE PART		
<i>Code</i>	<i>Description</i>	<i>Image</i>	<i>Code</i>	<i>Description</i>	<i>Components list</i>
0B1114A	0711 RIGHT - DOOR RIGHT INT COLUMN		OUTOFPRODUCTIO	ITEM OUT OF PRODUCTION	