

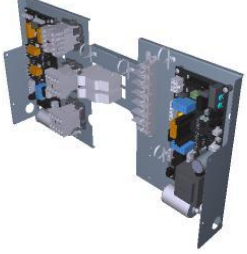





Assembly code	Assembly revision	Assembly image
ASM3238A/0.D00	Electrical system	
ASM3274A/0.D00	Door	
ASM3199A/0.D01	Cooking chamber	
ASM3226A/0.D02	External cover	
ASM3244A/0.D01	Electrical system	

**ASM3238A/0.D00 - Electrical system**

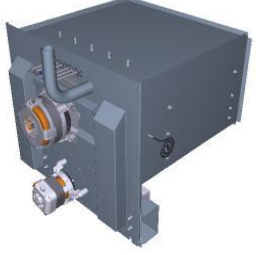
**FRONT**

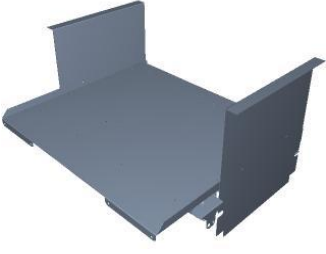
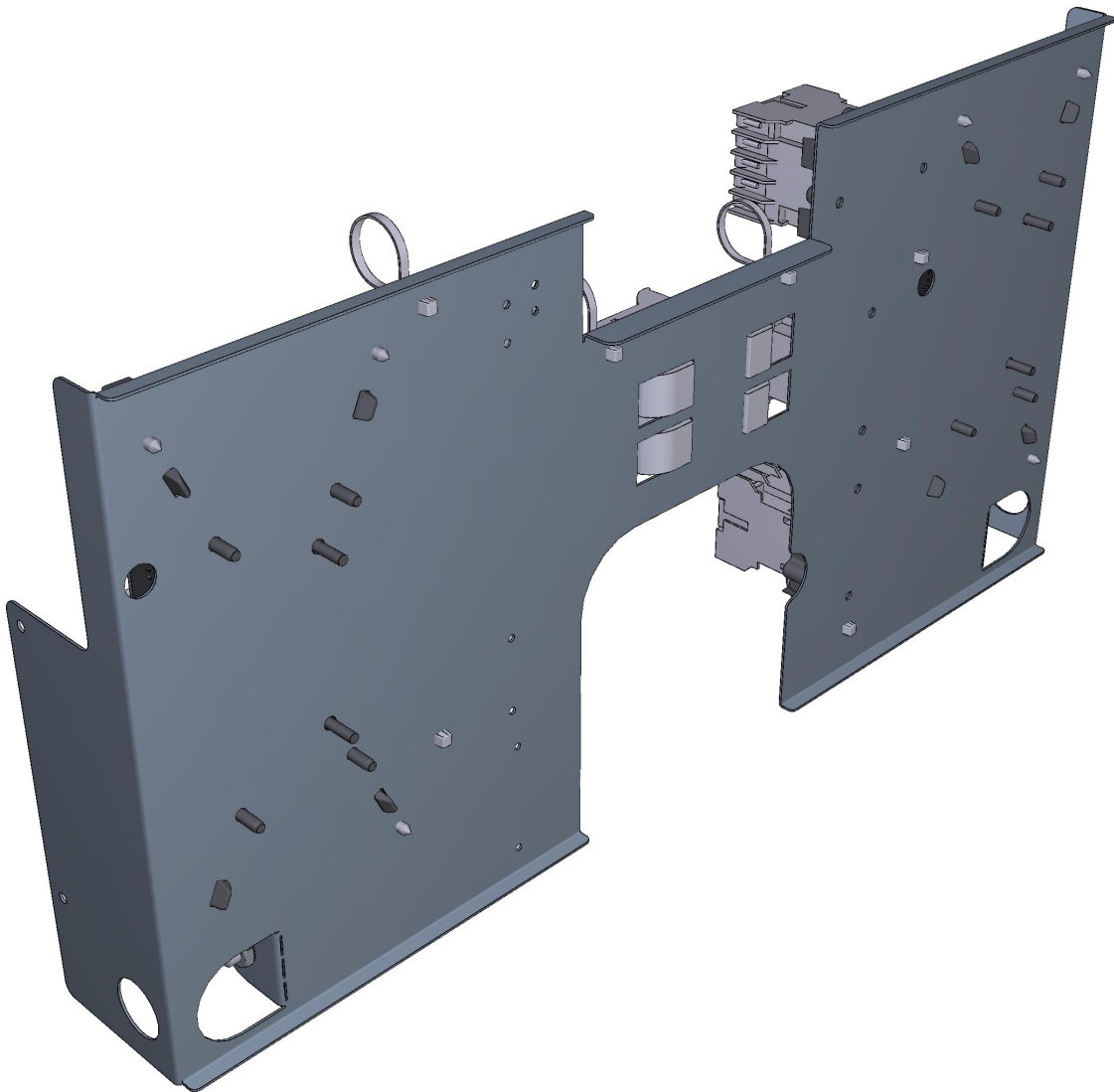



ASM3238A/0.D00 - Electrical system

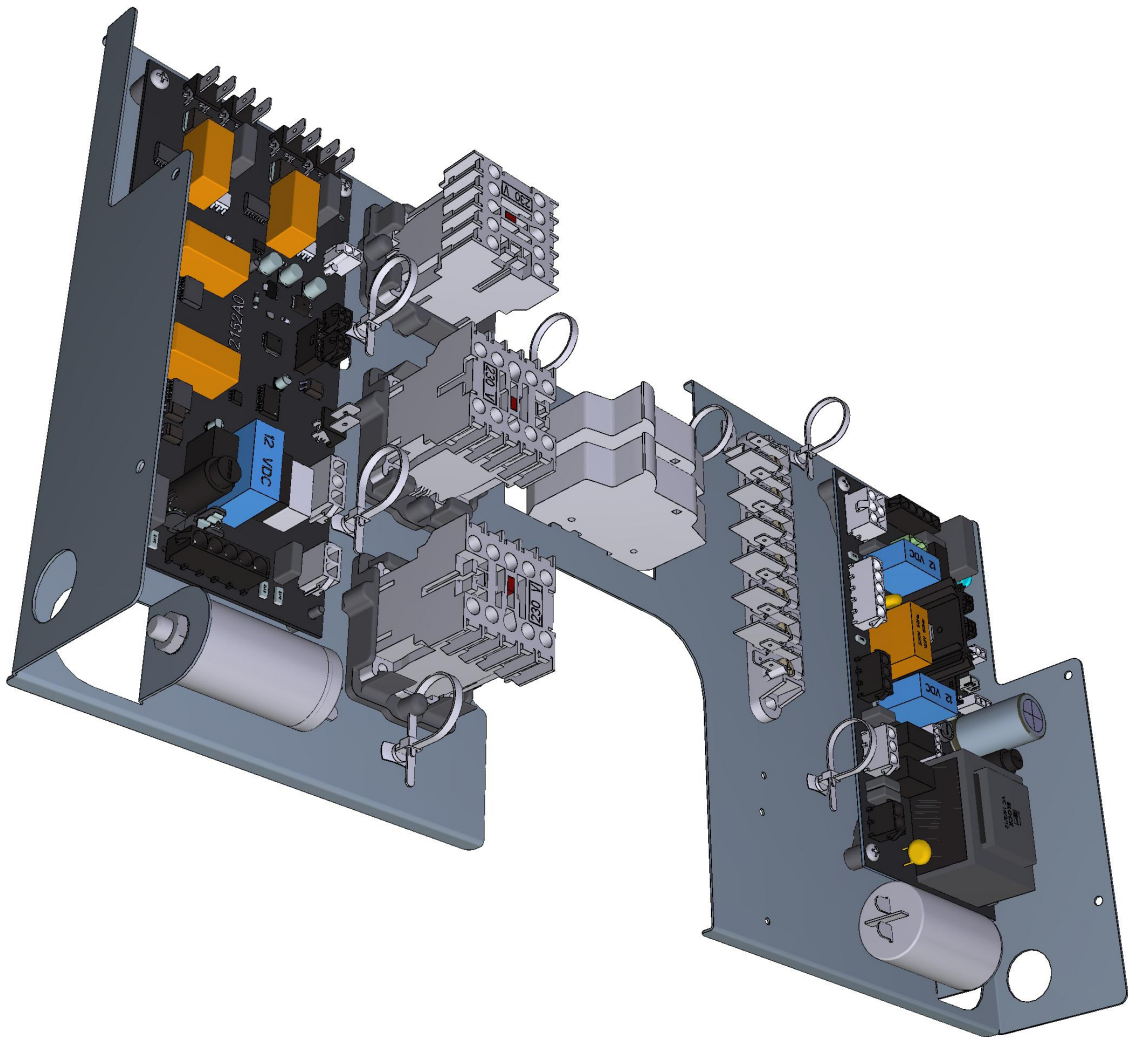

REAR

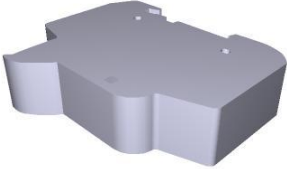

COMPONENT			SPARE PART																						
Code	Description	Image	Code	Description	Components list																				
CN1003A	6,3 UF MOTOR CAPACITOR		KCN1003A	6,3 UF MOTOR CAPACITOR KIT	<table border="1"> <thead> <tr> <th>Code</th> <th>Description</th> <th>Qty</th> <th>UOM</th> </tr> </thead> <tbody> <tr> <td>CN1003A0</td> <td>6,3 UF MOTOR CAPACITOR</td> <td>1</td> <td>PZ</td> </tr> <tr> <td>VI1931A0</td> <td>M8 NUT+INDENTE D WASHER D=8 X COND.</td> <td>1</td> <td>PZ</td> </tr> <tr> <td>VI1932A0</td> <td>M8 NUT+INDENTE D WASHER D=8 X COND.</td> <td>1</td> <td>PZ</td> </tr> <tr> <td>VM1224A0</td> <td>65MY 220MM 2 COLOURS SHRINK TUBE</td> <td>0.200</td> <td>M</td> </tr> </tbody> </table>	Code	Description	Qty	UOM	CN1003A0	6,3 UF MOTOR CAPACITOR	1	PZ	VI1931A0	M8 NUT+INDENTE D WASHER D=8 X COND.	1	PZ	VI1932A0	M8 NUT+INDENTE D WASHER D=8 X COND.	1	PZ	VM1224A0	65MY 220MM 2 COLOURS SHRINK TUBE	0.200	M
Code	Description	Qty	UOM																						
CN1003A0	6,3 UF MOTOR CAPACITOR	1	PZ																						
VI1931A0	M8 NUT+INDENTE D WASHER D=8 X COND.	1	PZ																						
VI1932A0	M8 NUT+INDENTE D WASHER D=8 X COND.	1	PZ																						
VM1224A0	65MY 220MM 2 COLOURS SHRINK TUBE	0.200	M																						
VE1115A	20 A 230V 4 POLES MINICONTACTOR		KVE1115A	20A 230V 4 POLES MINICONTACTOR KI	<table border="1"> <thead> <tr> <th>Code</th> <th>Description</th> <th>Qty</th> <th>UOM</th> </tr> </thead> <tbody> <tr> <td>VE1115A0</td> <td>20 A 230V 4 POLES MINICONTACT OR</td> <td>1</td> <td>PZ</td> </tr> <tr> <td>VM1075A1</td> <td>PLASTIC CLIP TO FIX CONTACTORS</td> <td>4</td> <td>PZ</td> </tr> <tr> <td>VM1224A0</td> <td>65MY 220MM 2 COLOURS SHRINK TUBE</td> <td>0.250</td> <td>M</td> </tr> </tbody> </table>	Code	Description	Qty	UOM	VE1115A0	20 A 230V 4 POLES MINICONTACT OR	1	PZ	VM1075A1	PLASTIC CLIP TO FIX CONTACTORS	4	PZ	VM1224A0	65MY 220MM 2 COLOURS SHRINK TUBE	0.250	M				
Code	Description	Qty	UOM																						
VE1115A0	20 A 230V 4 POLES MINICONTACT OR	1	PZ																						
VM1075A1	PLASTIC CLIP TO FIX CONTACTORS	4	PZ																						
VM1224A0	65MY 220MM 2 COLOURS SHRINK TUBE	0.250	M																						
VM1056A	SMALL CONTACTOR BRACKET VE1115A		VM1056A0	SMALL CONTACTOR BRACKET VE1115A																					
CN1010A	MOTOR CAPACITOR 3,5?F 450V,CE/UL,P CLASS		KCN1010A	3.5UF MOTOR CAPACITOR KIT	<table border="1"> <thead> <tr> <th>Code</th> <th>Description</th> <th>Qty</th> <th>UOM</th> </tr> </thead> <tbody> <tr> <td>CN1010A0</td> <td>MOTOR CAPACITOR 3,5?F 450V,CE/UL,P CLASS</td> <td>1</td> <td>PZ</td> </tr> <tr> <td>VI1931A0</td> <td>M8 NUT+INDENTE D WASHER D=8 X COND.</td> <td>1</td> <td>PZ</td> </tr> <tr> <td>VI1932A0</td> <td>M8 NUT+INDENTE D WASHER D=8 X COND.</td> <td>1</td> <td>PZ</td> </tr> <tr> <td>VM1224A0</td> <td>65MY 220MM 2 COLOURS SHRINK TUBE</td> <td>0.200</td> <td>M</td> </tr> </tbody> </table>	Code	Description	Qty	UOM	CN1010A0	MOTOR CAPACITOR 3,5?F 450V,CE/UL,P CLASS	1	PZ	VI1931A0	M8 NUT+INDENTE D WASHER D=8 X COND.	1	PZ	VI1932A0	M8 NUT+INDENTE D WASHER D=8 X COND.	1	PZ	VM1224A0	65MY 220MM 2 COLOURS SHRINK TUBE	0.200	M
Code	Description	Qty	UOM																						
CN1010A0	MOTOR CAPACITOR 3,5?F 450V,CE/UL,P CLASS	1	PZ																						
VI1931A0	M8 NUT+INDENTE D WASHER D=8 X COND.	1	PZ																						
VI1932A0	M8 NUT+INDENTE D WASHER D=8 X COND.	1	PZ																						
VM1224A0	65MY 220MM 2 COLOURS SHRINK TUBE	0.200	M																						

COMPONENT			SPARE PART																														
Code	Description	Image	Code	Description	Components list																												
MR1004A	41A 450V 7 POLES TERMINAL		KMR1004A	7FTW 1+2+3/4+5+6 TERMINAL BLOCK KIT	<table border="1"> <thead> <tr> <th>Code</th> <th>Description</th> <th>Qty</th> <th>UOM</th> </tr> </thead> <tbody> <tr> <td>MR1004A1</td> <td>41A 450V 7 POLES TERMINAL</td> <td>1</td> <td>PZ</td> </tr> <tr> <td>VM1224A0</td> <td>65MY 220MM 2 COLOURS SHRINK TUBE</td> <td>0.300</td> <td>M</td> </tr> </tbody> </table>	Code	Description	Qty	UOM	MR1004A1	41A 450V 7 POLES TERMINAL	1	PZ	VM1224A0	65MY 220MM 2 COLOURS SHRINK TUBE	0.300	M																
Code	Description	Qty	UOM																														
MR1004A1	41A 450V 7 POLES TERMINAL	1	PZ																														
VM1224A0	65MY 220MM 2 COLOURS SHRINK TUBE	0.300	M																														
VE1632A	MONOPOL SECTION FUSE HOLDER 10X38 32A		KVE1632A	10X38 32A FUSE HOLDER KIT	<table border="1"> <thead> <tr> <th>Code</th> <th>Description</th> <th>Qty</th> <th>UOM</th> </tr> </thead> <tbody> <tr> <td>VE1632A0</td> <td>MONOPOL SECTION FUSE HOLDER 10X38 32A</td> <td>1</td> <td>PZ</td> </tr> </tbody> </table>	Code	Description	Qty	UOM	VE1632A0	MONOPOL SECTION FUSE HOLDER 10X38 32A	1	PZ																				
Code	Description	Qty	UOM																														
VE1632A0	MONOPOL SECTION FUSE HOLDER 10X38 32A	1	PZ																														
VM1187A	POWER BOARD FRAME SHOP.PRO		VM1187A0	POWER BOARD FRAME SHOP.PRO																													
PE2102A	BL LED/TOUCH/PLUS 230V POWER BOAR		KPE2102A	BL LED/TOUCH/MASTE R 230V POWER CARD KIT	<table border="1"> <thead> <tr> <th>Code</th> <th>Description</th> <th>Qty</th> <th>UOM</th> </tr> </thead> <tbody> <tr> <td>PE2102A0</td> <td>BL LED/TOUCH/P LUS 230V POWER BOARD KIT</td> <td>1</td> <td>PZ</td> </tr> <tr> <td>PE2102A1</td> <td>BL LED/TOUCH/P LUS 230 V POWER CARD</td> <td>1</td> <td>PZ</td> </tr> <tr> <td>PE2102A2</td> <td>BL LED/TOUCH/P LUS 230V POWER BOAR</td> <td>1</td> <td>PZ</td> </tr> <tr> <td>VI1988A0</td> <td>AUTOTHREAD ING SCREW 4,2X19 TCB+ INOX</td> <td>3</td> <td>PZ</td> </tr> <tr> <td>VM1187A0</td> <td>POWER BOARD FRAME SHOP.PRO</td> <td>1</td> <td>PZ</td> </tr> <tr> <td>VM2147A0</td> <td>410X343X15 MM PINK SMOOTH ESD SPONGE</td> <td>1</td> <td>PZ</td> </tr> </tbody> </table>	Code	Description	Qty	UOM	PE2102A0	BL LED/TOUCH/P LUS 230V POWER BOARD KIT	1	PZ	PE2102A1	BL LED/TOUCH/P LUS 230 V POWER CARD	1	PZ	PE2102A2	BL LED/TOUCH/P LUS 230V POWER BOAR	1	PZ	VI1988A0	AUTOTHREAD ING SCREW 4,2X19 TCB+ INOX	3	PZ	VM1187A0	POWER BOARD FRAME SHOP.PRO	1	PZ	VM2147A0	410X343X15 MM PINK SMOOTH ESD SPONGE	1	PZ
Code	Description	Qty	UOM																														
PE2102A0	BL LED/TOUCH/P LUS 230V POWER BOARD KIT	1	PZ																														
PE2102A1	BL LED/TOUCH/P LUS 230 V POWER CARD	1	PZ																														
PE2102A2	BL LED/TOUCH/P LUS 230V POWER BOAR	1	PZ																														
VI1988A0	AUTOTHREAD ING SCREW 4,2X19 TCB+ INOX	3	PZ																														
VM1187A0	POWER BOARD FRAME SHOP.PRO	1	PZ																														
VM2147A0	410X343X15 MM PINK SMOOTH ESD SPONGE	1	PZ																														



COMPONENT			SPARE PART																		
Code	Description	Image	Code	Description	Components list																
VM1187A	POWER BOARD FRAME SHOP.PRO		VM1187A0	POWER BOARD FRAME SHOP.PRO																	
PE2152A	MW POWER BOARD		KPE2152A	SPEED.PRO POWER BOARD KIT	<table border="1"> <thead> <tr> <th>Code</th> <th>Description</th> <th>Qty</th> <th>UOM</th> </tr> </thead> <tbody> <tr> <td>PE2152A0</td> <td>MW POWER BOARD</td> <td>1</td> <td>PZ</td> </tr> <tr> <td>VI1988A0</td> <td>AUTOTHREADING SCREW 4,2X19 TCB+ INOX</td> <td>3</td> <td>PZ</td> </tr> <tr> <td>VM2147A0</td> <td>410X343X15 MM PINK SMOOTH ESD SPONGE</td> <td>1</td> <td>PZ</td> </tr> </tbody> </table>	Code	Description	Qty	UOM	PE2152A0	MW POWER BOARD	1	PZ	VI1988A0	AUTOTHREADING SCREW 4,2X19 TCB+ INOX	3	PZ	VM2147A0	410X343X15 MM PINK SMOOTH ESD SPONGE	1	PZ
Code	Description	Qty	UOM																		
PE2152A0	MW POWER BOARD	1	PZ																		
VI1988A0	AUTOTHREADING SCREW 4,2X19 TCB+ INOX	3	PZ																		
VM2147A0	410X343X15 MM PINK SMOOTH ESD SPONGE	1	PZ																		
0H5264A			0H5264A1																		

ASM3274A/0.D00 - Door

FRONT





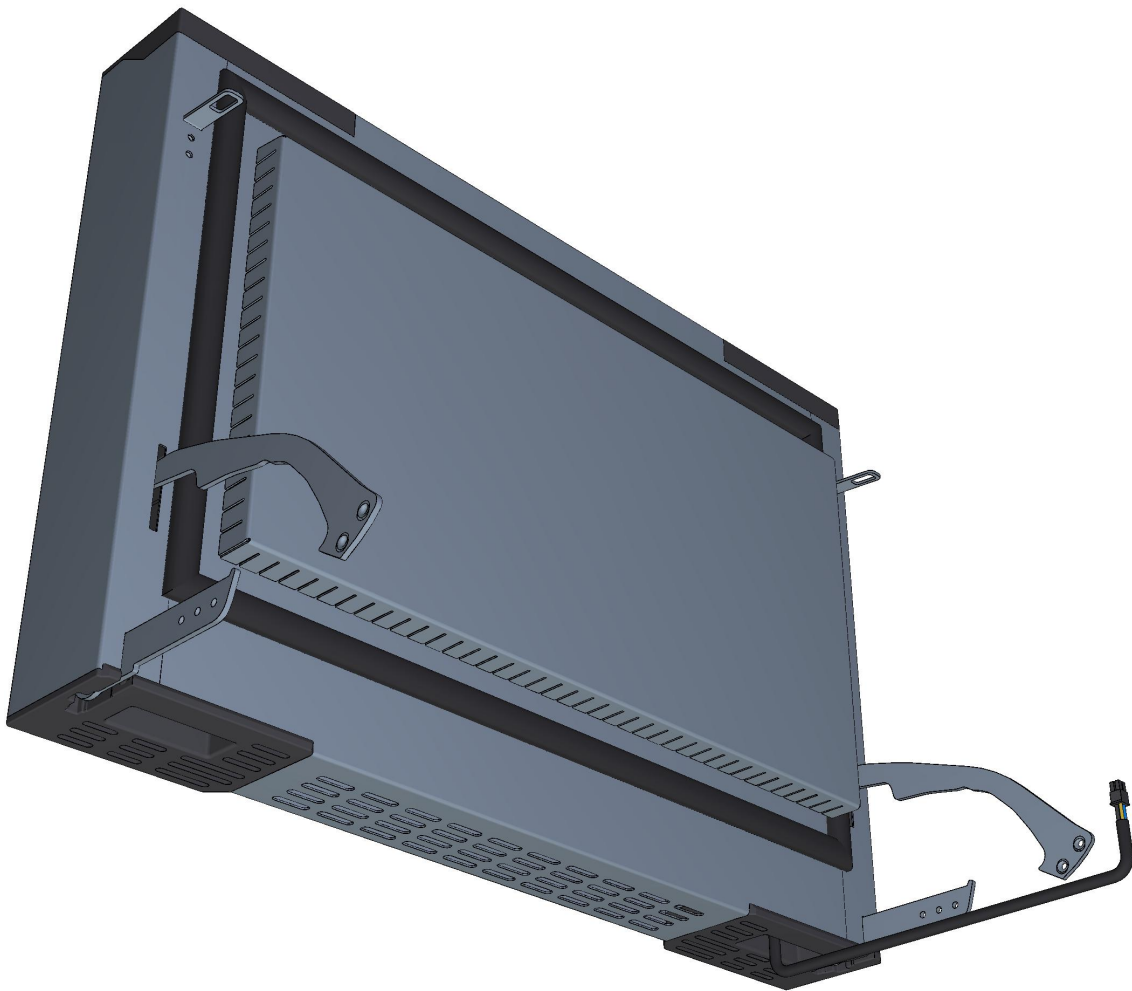

ASM3274A/0.D00 - Door



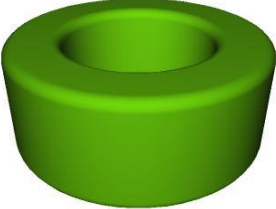
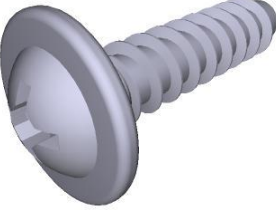

REAR







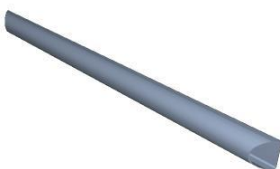





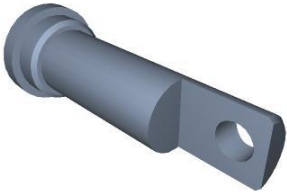

COMPONENT			SPARE PART																		
Code	Description	Image	Code	Description	Components list																
CE1285A	EMI ROUND FERRITE MOD.2643801502		CE1285A0	EMI ROUND FERRITE MOD.2643801502																	
VI1074A	4X16 SCREW FOR PLASTIC		VI1074A0	4X16 SCREW FOR PLASTIC																	
CE1065A	4X0.5 MICROFIT WIRE 4P-500MM-MICROFI T4P		KCE1065A	4P-500MM MICROFIT CABLE KI	<table border="1"> <thead> <tr> <th>Code</th> <th>Description</th> <th>Qty</th> <th>UOM</th> </tr> </thead> <tbody> <tr> <td>CE1065A0</td> <td>4X0.5 MICROFIT WIRE 4P-500MM-MIC ROFIT4P</td> <td>1</td> <td>PZ</td> </tr> <tr> <td>VM1224A0</td> <td>65MY 220MM 2 COLOURS SHRINK TUBE</td> <td>0.200</td> <td>M</td> </tr> </tbody> </table>	Code	Description	Qty	UOM	CE1065A0	4X0.5 MICROFIT WIRE 4P-500MM-MIC ROFIT4P	1	PZ	VM1224A0	65MY 220MM 2 COLOURS SHRINK TUBE	0.200	M				
Code	Description	Qty	UOM																		
CE1065A0	4X0.5 MICROFIT WIRE 4P-500MM-MIC ROFIT4P	1	PZ																		
VM1224A0	65MY 220MM 2 COLOURS SHRINK TUBE	0.200	M																		
0H5265A			0H5265A1																		
0H5272A			K0H5272A	MW DOOR MICROSWITCH HOOK KIT	<table border="1"> <thead> <tr> <th>Code</th> <th>Description</th> <th>Qty</th> <th>UOM</th> </tr> </thead> <tbody> <tr> <td>0H5272A1</td> <td></td> <td>2</td> <td>PZ</td> </tr> <tr> <td>VI1220A1</td> <td>4,2X12 TCB SELF-TAPPIN G SCREW</td> <td>4</td> <td>PZ</td> </tr> <tr> <td>VM1224A0</td> <td>65MY 220MM 2 COLOURS SHRINK TUBE</td> <td>0.200</td> <td>M</td> </tr> </tbody> </table>	Code	Description	Qty	UOM	0H5272A1		2	PZ	VI1220A1	4,2X12 TCB SELF-TAPPIN G SCREW	4	PZ	VM1224A0	65MY 220MM 2 COLOURS SHRINK TUBE	0.200	M
Code	Description	Qty	UOM																		
0H5272A1		2	PZ																		
VI1220A1	4,2X12 TCB SELF-TAPPIN G SCREW	4	PZ																		
VM1224A0	65MY 220MM 2 COLOURS SHRINK TUBE	0.200	M																		

COMPONENT			SPARE PART																														
Code	Description	Image	Code	Description	Components list																												
VM2527A	STYLUS PEN FOR S		KVM2527A	EVEREO-BLSP TOUCH STYLUS 5 PCS KIT	<table border="1"> <thead> <tr> <th>Code</th> <th>Description</th> <th>Qty</th> <th>UOM</th> </tr> </thead> <tbody> <tr> <td>VM1224A0</td> <td>65MY 220MM 2 COLOURS SHRINK TUBE</td> <td>0.150</td> <td>M</td> </tr> <tr> <td>VM2527A0</td> <td>STYLUS PEN FOR SP</td> <td>5</td> <td>PZ</td> </tr> </tbody> </table>	Code	Description	Qty	UOM	VM1224A0	65MY 220MM 2 COLOURS SHRINK TUBE	0.150	M	VM2527A0	STYLUS PEN FOR SP	5	PZ																
Code	Description	Qty	UOM																														
VM1224A0	65MY 220MM 2 COLOURS SHRINK TUBE	0.150	M																														
VM2527A0	STYLUS PEN FOR SP	5	PZ																														
VM2456A	BAKERLUX SHOP.PRO HANDLE END		KVM2456A	2 PCS BAKERLUX SHOP.PRO HANDLE END KIT	<table border="1"> <thead> <tr> <th>Code</th> <th>Description</th> <th>Qty</th> <th>UOM</th> </tr> </thead> <tbody> <tr> <td>V11930A0</td> <td>5X25 ST. STEEL SCREW CHIP</td> <td>4</td> <td>PZ</td> </tr> <tr> <td>VM1224A0</td> <td>65MY 220MM 2 COLOURS SHRINK TUBE</td> <td>0.300</td> <td>M</td> </tr> <tr> <td>VM2456A0</td> <td>BAKERLUX SHOP.PRO HANDLE END</td> <td>2</td> <td>PZ</td> </tr> <tr> <td>VM2456A0</td> <td>BAKERLUX SHOP.PRO HANDLE END</td> <td>2</td> <td>PZ</td> </tr> <tr> <td>VM2489A0</td> <td>SP HANDLE END KIT + STYLUS KIT</td> <td>1</td> <td>PZ</td> </tr> <tr> <td>VM2527A0</td> <td>STYLUS PEN FOR SP</td> <td>1</td> <td>PZ</td> </tr> </tbody> </table>	Code	Description	Qty	UOM	V11930A0	5X25 ST. STEEL SCREW CHIP	4	PZ	VM1224A0	65MY 220MM 2 COLOURS SHRINK TUBE	0.300	M	VM2456A0	BAKERLUX SHOP.PRO HANDLE END	2	PZ	VM2456A0	BAKERLUX SHOP.PRO HANDLE END	2	PZ	VM2489A0	SP HANDLE END KIT + STYLUS KIT	1	PZ	VM2527A0	STYLUS PEN FOR SP	1	PZ
Code	Description	Qty	UOM																														
V11930A0	5X25 ST. STEEL SCREW CHIP	4	PZ																														
VM1224A0	65MY 220MM 2 COLOURS SHRINK TUBE	0.300	M																														
VM2456A0	BAKERLUX SHOP.PRO HANDLE END	2	PZ																														
VM2456A0	BAKERLUX SHOP.PRO HANDLE END	2	PZ																														
VM2489A0	SP HANDLE END KIT + STYLUS KIT	1	PZ																														
VM2527A0	STYLUS PEN FOR SP	1	PZ																														
TB2843A	MW HANDLE TUBE		KTB2843A	SPEED.PRO DROP DOWN DOOR HANDLE TUBE KIT	<table border="1"> <thead> <tr> <th>Code</th> <th>Description</th> <th>Qty</th> <th>UOM</th> </tr> </thead> <tbody> <tr> <td>TB2843A0</td> <td>MW HANDLE TUBE</td> <td>1</td> <td>PZ</td> </tr> <tr> <td>V11930A1</td> <td>ST. STEEL 5X20 CHIP SCREW</td> <td>4</td> <td>PZ</td> </tr> <tr> <td>VM2456A0</td> <td>BAKERLUX SHOP.PRO HANDLE END</td> <td>1</td> <td>PZ</td> </tr> <tr> <td>VM2489A0</td> <td>SP HANDLE END KIT + STYLUS KIT</td> <td>1</td> <td>PZ</td> </tr> <tr> <td>VM2527A0</td> <td>STYLUS PEN FOR SP</td> <td>1</td> <td>PZ</td> </tr> </tbody> </table>	Code	Description	Qty	UOM	TB2843A0	MW HANDLE TUBE	1	PZ	V11930A1	ST. STEEL 5X20 CHIP SCREW	4	PZ	VM2456A0	BAKERLUX SHOP.PRO HANDLE END	1	PZ	VM2489A0	SP HANDLE END KIT + STYLUS KIT	1	PZ	VM2527A0	STYLUS PEN FOR SP	1	PZ				
Code	Description	Qty	UOM																														
TB2843A0	MW HANDLE TUBE	1	PZ																														
V11930A1	ST. STEEL 5X20 CHIP SCREW	4	PZ																														
VM2456A0	BAKERLUX SHOP.PRO HANDLE END	1	PZ																														
VM2489A0	SP HANDLE END KIT + STYLUS KIT	1	PZ																														
VM2527A0	STYLUS PEN FOR SP	1	PZ																														
VN1179A	CONTROL BOARD 40X40X20MM 12V COOLING FAN		KVN1179A	CONTROL BOARD COOLING FAN KIT	<table border="1"> <thead> <tr> <th>Code</th> <th>Description</th> <th>Qty</th> <th>UOM</th> </tr> </thead> <tbody> <tr> <td>VM1224A0</td> <td>65MY 220MM 2 COLOURS SHRINK TUBE</td> <td>0.150</td> <td>M</td> </tr> <tr> <td>VN1179A0</td> <td>CONTROL BOARD 40X40X20MM 12V COOLING FAN</td> <td>1</td> <td>PZ</td> </tr> </tbody> </table>	Code	Description	Qty	UOM	VM1224A0	65MY 220MM 2 COLOURS SHRINK TUBE	0.150	M	VN1179A0	CONTROL BOARD 40X40X20MM 12V COOLING FAN	1	PZ																
Code	Description	Qty	UOM																														
VM1224A0	65MY 220MM 2 COLOURS SHRINK TUBE	0.150	M																														
VN1179A0	CONTROL BOARD 40X40X20MM 12V COOLING FAN	1	PZ																														





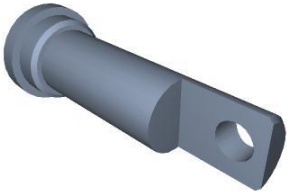

COMPONENT			SPARE PART														
Code	Description	Image	Code	Description	Components list												
VN1179A	CONTROL BOARD 40X40X20MM 12V COOLING FAN		KVN1179A	CONTROL BOARD COOLING FAN KIT	<table border="1"> <thead> <tr> <th>Code</th> <th>Description</th> <th>Qty</th> <th>UOM</th> </tr> </thead> <tbody> <tr> <td>VN1179A0</td> <td>CONTROL BOARD 40X40X20MM 12V COOLING FAN</td> <td>1</td> <td>PZ</td> </tr> <tr> <td>VN1179A1</td> <td>CONTROL BOARD 40X40X20MM 12V COOLING FAN</td> <td>1</td> <td>PZ</td> </tr> </tbody> </table>	Code	Description	Qty	UOM	VN1179A0	CONTROL BOARD 40X40X20MM 12V COOLING FAN	1	PZ	VN1179A1	CONTROL BOARD 40X40X20MM 12V COOLING FAN	1	PZ
					Code	Description	Qty	UOM									
VN1179A0	CONTROL BOARD 40X40X20MM 12V COOLING FAN	1	PZ														
VN1179A1	CONTROL BOARD 40X40X20MM 12V COOLING FAN	1	PZ														
PE2153A	SP DUO CONTROL BOARD		KPE2153A	SPEED.PRO CONTROL BOARD KIT	<table border="1"> <thead> <tr> <th>Code</th> <th>Description</th> <th>Qty</th> <th>UOM</th> </tr> </thead> <tbody> <tr> <td>PE2153A0</td> <td>SP DUO CONTROL BOARD</td> <td>1</td> <td>PZ</td> </tr> <tr> <td>VM2147A0</td> <td>410X343X15 MM PINK SMOOTH ESD SPONGE</td> <td>1</td> <td>PZ</td> </tr> </tbody> </table>	Code	Description	Qty	UOM	PE2153A0	SP DUO CONTROL BOARD	1	PZ	VM2147A0	410X343X15 MM PINK SMOOTH ESD SPONGE	1	PZ
Code	Description	Qty	UOM														
PE2153A0	SP DUO CONTROL BOARD	1	PZ														
VM2147A0	410X343X15 MM PINK SMOOTH ESD SPONGE	1	PZ														
VP1030A			KVP1030A		<table border="1"> <thead> <tr> <th>Code</th> <th>Description</th> <th>Qty</th> <th>UOM</th> </tr> </thead> <tbody> <tr> <td>VM1224A0</td> <td>65MY 220MM 2 COLOURS SHRINK TUBE</td> <td>0.200</td> <td>M</td> </tr> <tr> <td>VP1030A0</td> <td></td> <td>1</td> <td>PZ</td> </tr> </tbody> </table>	Code	Description	Qty	UOM	VM1224A0	65MY 220MM 2 COLOURS SHRINK TUBE	0.200	M	VP1030A0		1	PZ
					Code	Description	Qty	UOM									
VM1224A0	65MY 220MM 2 COLOURS SHRINK TUBE	0.200	M														
VP1030A0		1	PZ														
VP1031A	MW FAN CARRIER		KVP1031A		<table border="1"> <thead> <tr> <th>Code</th> <th>Description</th> <th>Qty</th> <th>UOM</th> </tr> </thead> <tbody> <tr> <td>VM1224A0</td> <td>65MY 220MM 2 COLOURS SHRINK TUBE</td> <td>0.200</td> <td>M</td> </tr> <tr> <td>VP1031A0</td> <td>MW FAN CARRIER</td> <td>1</td> <td>PZ</td> </tr> </tbody> </table>	Code	Description	Qty	UOM	VM1224A0	65MY 220MM 2 COLOURS SHRINK TUBE	0.200	M	VP1031A0	MW FAN CARRIER	1	PZ
Code	Description	Qty	UOM														
VM1224A0	65MY 220MM 2 COLOURS SHRINK TUBE	0.200	M														
VP1031A0	MW FAN CARRIER	1	PZ														
VI1930A	ST. STEEL 5X20 CHIP SCREW		VI1930A1	ST. STEEL 5X20 CHIP SCREW													

COMPONENT			SPARE PART																										
Code	Description	Image	Code	Description	Components list																								
0H2918A			0H2918A0																										
0H2569A			K0H2569A	SPEED.PRO DOOR UPPER HINGE KIT	<table border="1"> <thead> <tr> <th>Code</th> <th>Description</th> <th>Qty</th> <th>UOM</th> </tr> </thead> <tbody> <tr> <td>0H2569A0</td> <td></td> <td>1</td> <td>PZ</td> </tr> <tr> <td>V11074A0</td> <td>4X16 SCREW FOR PLASTIC</td> <td>3</td> <td>PZ</td> </tr> <tr> <td>VM1524A0</td> <td>D 24 D 8 B 8 MW HINGE BEARING</td> <td>1</td> <td>PZ</td> </tr> <tr> <td>VM1534A0</td> <td>SPEED.PRO DOOR HOLDER BEARING PIN</td> <td>1</td> <td>PZ</td> </tr> <tr> <td>VP1077A0</td> <td>MW HINGES BALL-BEARING CARRIER</td> <td>1</td> <td>PZ</td> </tr> </tbody> </table>	Code	Description	Qty	UOM	0H2569A0		1	PZ	V11074A0	4X16 SCREW FOR PLASTIC	3	PZ	VM1524A0	D 24 D 8 B 8 MW HINGE BEARING	1	PZ	VM1534A0	SPEED.PRO DOOR HOLDER BEARING PIN	1	PZ	VP1077A0	MW HINGES BALL-BEARING CARRIER	1	PZ
Code	Description	Qty	UOM																										
0H2569A0		1	PZ																										
V11074A0	4X16 SCREW FOR PLASTIC	3	PZ																										
VM1524A0	D 24 D 8 B 8 MW HINGE BEARING	1	PZ																										
VM1534A0	SPEED.PRO DOOR HOLDER BEARING PIN	1	PZ																										
VP1077A0	MW HINGES BALL-BEARING CARRIER	1	PZ																										
VM1524A	D 24 D 8 B 8 MW HINGE BEARING		VM1524A0	D 24 D 8 B 8 MW HINGE BEARING																									
VM1534A	SPEED.PRO DOOR HOLDER BEARING PIN		VM1534A0	SPEED.PRO DOOR HOLDER BEARING PIN																									
VP1077A	MW HINGES BALL-BEARING CARRIER		KVP1077A	SPEED.PRO HINGES BEARING HOLDER KIT	<table border="1"> <thead> <tr> <th>Code</th> <th>Description</th> <th>Qty</th> <th>UOM</th> </tr> </thead> <tbody> <tr> <td>VM1224A0</td> <td>65MY 220MM 2 COLOURS SHRINK TUBE</td> <td>0.200</td> <td>M</td> </tr> <tr> <td>VP1077A0</td> <td>MW HINGES BALL-BEARING CARRIER</td> <td>1</td> <td>PZ</td> </tr> </tbody> </table>	Code	Description	Qty	UOM	VM1224A0	65MY 220MM 2 COLOURS SHRINK TUBE	0.200	M	VP1077A0	MW HINGES BALL-BEARING CARRIER	1	PZ												
Code	Description	Qty	UOM																										
VM1224A0	65MY 220MM 2 COLOURS SHRINK TUBE	0.200	M																										
VP1077A0	MW HINGES BALL-BEARING CARRIER	1	PZ																										

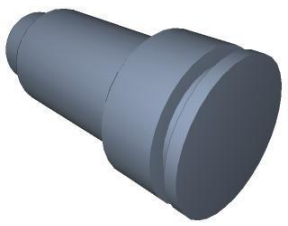
COMPONENT			SPARE PART																										
Code	Description	Image	Code	Description	Components list																								
0H2918A			0H2918A0																										
0H2569A			K0H2569A	SPEED.PRO DOOR UPPER HINGE KIT	<table border="1"> <thead> <tr> <th>Code</th> <th>Description</th> <th>Qty</th> <th>UOM</th> </tr> </thead> <tbody> <tr> <td>0H2569A0</td> <td></td> <td>1</td> <td>PZ</td> </tr> <tr> <td>V11074A0</td> <td>4X16 SCREW FOR PLASTIC</td> <td>3</td> <td>PZ</td> </tr> <tr> <td>VM1524A0</td> <td>D 24 D 8 B 8 MW HINGE BEARING</td> <td>1</td> <td>PZ</td> </tr> <tr> <td>VM1534A0</td> <td>SPEED.PRO DOOR HOLDER BEARING PIN</td> <td>1</td> <td>PZ</td> </tr> <tr> <td>VP1077A0</td> <td>MW HINGES BALL-BEARING CARRIER</td> <td>1</td> <td>PZ</td> </tr> </tbody> </table>	Code	Description	Qty	UOM	0H2569A0		1	PZ	V11074A0	4X16 SCREW FOR PLASTIC	3	PZ	VM1524A0	D 24 D 8 B 8 MW HINGE BEARING	1	PZ	VM1534A0	SPEED.PRO DOOR HOLDER BEARING PIN	1	PZ	VP1077A0	MW HINGES BALL-BEARING CARRIER	1	PZ
Code	Description	Qty	UOM																										
0H2569A0		1	PZ																										
V11074A0	4X16 SCREW FOR PLASTIC	3	PZ																										
VM1524A0	D 24 D 8 B 8 MW HINGE BEARING	1	PZ																										
VM1534A0	SPEED.PRO DOOR HOLDER BEARING PIN	1	PZ																										
VP1077A0	MW HINGES BALL-BEARING CARRIER	1	PZ																										
VM1524A	D 24 D 8 B 8 MW HINGE BEARING		VM1524A0	D 24 D 8 B 8 MW HINGE BEARING																									
VM1534A	SPEED.PRO DOOR HOLDER BEARING PIN		VM1534A0	SPEED.PRO DOOR HOLDER BEARING PIN																									
VP1077A	MW HINGES BALL-BEARING CARRIER		KVP1077A	SPEED.PRO HINGES BEARING HOLDER KIT	<table border="1"> <thead> <tr> <th>Code</th> <th>Description</th> <th>Qty</th> <th>UOM</th> </tr> </thead> <tbody> <tr> <td>VM1224A0</td> <td>65MY 220MM 2 COLOURS SHRINK TUBE</td> <td>0.200</td> <td>M</td> </tr> <tr> <td>VP1077A0</td> <td>MW HINGES BALL-BEARING CARRIER</td> <td>1</td> <td>PZ</td> </tr> </tbody> </table>	Code	Description	Qty	UOM	VM1224A0	65MY 220MM 2 COLOURS SHRINK TUBE	0.200	M	VP1077A0	MW HINGES BALL-BEARING CARRIER	1	PZ												
Code	Description	Qty	UOM																										
VM1224A0	65MY 220MM 2 COLOURS SHRINK TUBE	0.200	M																										
VP1077A0	MW HINGES BALL-BEARING CARRIER	1	PZ																										





COMPONENT			SPARE PART																						
Code	Description	Image	Code	Description	Components list																				
VM1524A	D 24 D 8 B 8 MW HINGE BEARING		VM1524A0	D 24 D 8 B 8 MW HINGE BEARING																					
0H2574A			K0H2574A	SPEED.PRO DOOR LOWER HINGE KIT	<table border="1"> <thead> <tr> <th>Code</th> <th>Description</th> <th>Qty</th> <th>UOM</th> </tr> </thead> <tbody> <tr> <td>0H2574A0</td> <td></td> <td>1</td> <td>PZ</td> </tr> <tr> <td>VM1224A0</td> <td>65MY 220MM 2 COLOURS SHRINK TUBE</td> <td>0.200</td> <td>M</td> </tr> <tr> <td>VM1524A0</td> <td>D 24 D 8 B 8 MW HINGE BEARING</td> <td>1</td> <td>PZ</td> </tr> <tr> <td>VM1533A0</td> <td>SPEED.PRO DOOR FULCRUM PIN</td> <td>1</td> <td>PZ</td> </tr> </tbody> </table>	Code	Description	Qty	UOM	0H2574A0		1	PZ	VM1224A0	65MY 220MM 2 COLOURS SHRINK TUBE	0.200	M	VM1524A0	D 24 D 8 B 8 MW HINGE BEARING	1	PZ	VM1533A0	SPEED.PRO DOOR FULCRUM PIN	1	PZ
Code	Description	Qty	UOM																						
0H2574A0		1	PZ																						
VM1224A0	65MY 220MM 2 COLOURS SHRINK TUBE	0.200	M																						
VM1524A0	D 24 D 8 B 8 MW HINGE BEARING	1	PZ																						
VM1533A0	SPEED.PRO DOOR FULCRUM PIN	1	PZ																						
VM1533A	SPEED.PRO DOOR FULCRUM PIN		VM1533A0	SPEED.PRO DOOR FULCRUM PIN																					
VP1024A	MW DOOR LEFT LOWER CAP		KVP1024A	SPEED.PRO DOOR LEFT LOWER CAP KI	<table border="1"> <thead> <tr> <th>Code</th> <th>Description</th> <th>Qty</th> <th>UOM</th> </tr> </thead> <tbody> <tr> <td>VM1224A0</td> <td>65MY 220MM 2 COLOURS SHRINK TUBE</td> <td>0.200</td> <td>M</td> </tr> <tr> <td>VP1024A0</td> <td>MW DOOR LEFT LOWER CAP</td> <td>1</td> <td>PZ</td> </tr> </tbody> </table>	Code	Description	Qty	UOM	VM1224A0	65MY 220MM 2 COLOURS SHRINK TUBE	0.200	M	VP1024A0	MW DOOR LEFT LOWER CAP	1	PZ								
Code	Description	Qty	UOM																						
VM1224A0	65MY 220MM 2 COLOURS SHRINK TUBE	0.200	M																						
VP1024A0	MW DOOR LEFT LOWER CAP	1	PZ																						
VM1524A	D 24 D 8 B 8 MW HINGE BEARING		VM1524A0	D 24 D 8 B 8 MW HINGE BEARING																					

COMPONENT			SPARE PART																						
Code	Description	Image	Code	Description	Components list																				
0H2574A			K0H2574A	SPEED.PRO DOOR LOWER HINGE KIT	<table border="1"> <thead> <tr> <th>Code</th> <th>Description</th> <th>Qty</th> <th>UOM</th> </tr> </thead> <tbody> <tr> <td>0H2574A0</td> <td></td> <td>1</td> <td>PZ</td> </tr> <tr> <td>VM1224A0</td> <td>65MY 220MM 2 COLOURS SHRINK TUBE</td> <td>0.200</td> <td>M</td> </tr> <tr> <td>VM1524A0</td> <td>D 24 D 8 B 8 MW HINGE BEARING</td> <td>1</td> <td>PZ</td> </tr> <tr> <td>VM1533A0</td> <td>SPEED.PRO DOOR FULCRUM PIN</td> <td>1</td> <td>PZ</td> </tr> </tbody> </table>	Code	Description	Qty	UOM	0H2574A0		1	PZ	VM1224A0	65MY 220MM 2 COLOURS SHRINK TUBE	0.200	M	VM1524A0	D 24 D 8 B 8 MW HINGE BEARING	1	PZ	VM1533A0	SPEED.PRO DOOR FULCRUM PIN	1	PZ
					Code	Description	Qty	UOM																	
					0H2574A0		1	PZ																	
					VM1224A0	65MY 220MM 2 COLOURS SHRINK TUBE	0.200	M																	
VM1524A0	D 24 D 8 B 8 MW HINGE BEARING	1	PZ																						
VM1533A0	SPEED.PRO DOOR FULCRUM PIN	1	PZ																						
VM1533A	SPEED.PRO DOOR FULCRUM PIN		VM1533A0	SPEED.PRO DOOR FULCRUM PIN																					
VP1025A	MW DOOR RIGHT LOWER CAP		KVP1025A	SPEED.PRO DOOR RIGHT LOWER CAP KIT	<table border="1"> <thead> <tr> <th>Code</th> <th>Description</th> <th>Qty</th> <th>UOM</th> </tr> </thead> <tbody> <tr> <td>VM1224A0</td> <td>65MY 220MM 2 COLOURS SHRINK TUBE</td> <td>0.200</td> <td>M</td> </tr> <tr> <td>VP1025A0</td> <td>MW DOOR RIGHT LOWER CAP</td> <td>1</td> <td>PZ</td> </tr> </tbody> </table>	Code	Description	Qty	UOM	VM1224A0	65MY 220MM 2 COLOURS SHRINK TUBE	0.200	M	VP1025A0	MW DOOR RIGHT LOWER CAP	1	PZ								
					Code	Description	Qty	UOM																	
VM1224A0	65MY 220MM 2 COLOURS SHRINK TUBE	0.200	M																						
VP1025A0	MW DOOR RIGHT LOWER CAP	1	PZ																						
CE1053B	MM MICROFIT LED BAR POWER SUPPLY CABLE		KCE1053B	LED BAR EXTENSION CABLE KIT	<table border="1"> <thead> <tr> <th>Code</th> <th>Description</th> <th>Qty</th> <th>UOM</th> </tr> </thead> <tbody> <tr> <td>CE1053B0</td> <td>MM MICROFIT LED BAR POWER SUPPLY CABL</td> <td>1</td> <td>PZ</td> </tr> </tbody> </table>	Code	Description	Qty	UOM	CE1053B0	MM MICROFIT LED BAR POWER SUPPLY CABL	1	PZ												
Code	Description	Qty	UOM																						
CE1053B0	MM MICROFIT LED BAR POWER SUPPLY CABL	1	PZ																						
GN1682A			KLP1055A	SPEED PRO RGB LED BAR KIT	<table border="1"> <thead> <tr> <th>Code</th> <th>Description</th> <th>Qty</th> <th>UOM</th> </tr> </thead> <tbody> <tr> <td>CE1053B0</td> <td>MM MICROFIT LED BAR POWER SUPPLY CABL</td> <td>1</td> <td>PZ</td> </tr> <tr> <td>GN1682A0</td> <td></td> <td>1</td> <td>PZ</td> </tr> <tr> <td>IP1385A1</td> <td>CORNER POLYSTYREN E PACKING 110X80X2000</td> <td>1</td> <td>M</td> </tr> <tr> <td>LP1055A0</td> <td>SPEED PRO RGB LED BAR</td> <td>1</td> <td>PZ</td> </tr> </tbody> </table>	Code	Description	Qty	UOM	CE1053B0	MM MICROFIT LED BAR POWER SUPPLY CABL	1	PZ	GN1682A0		1	PZ	IP1385A1	CORNER POLYSTYREN E PACKING 110X80X2000	1	M	LP1055A0	SPEED PRO RGB LED BAR	1	PZ
					Code	Description	Qty	UOM																	
					CE1053B0	MM MICROFIT LED BAR POWER SUPPLY CABL	1	PZ																	
					GN1682A0		1	PZ																	
IP1385A1	CORNER POLYSTYREN E PACKING 110X80X2000	1	M																						
LP1055A0	SPEED PRO RGB LED BAR	1	PZ																						

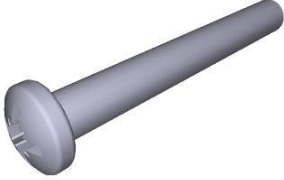

COMPONENT			SPARE PART																																		
Code	Description	Image	Code	Description	Components list																																
GN1682A			KLP1055A	SPEED PRO RGB LED BAR KIT	<table border="1"> <thead> <tr> <th>Code</th> <th>Description</th> <th>Qty</th> <th>UOM</th> </tr> </thead> <tbody> <tr> <td>VM1059A1</td> <td>HEAT SHRINK FILM H800</td> <td>1</td> <td>M</td> </tr> <tr> <td>VM2147A0</td> <td>410X343X15 MM PINK SMOOTH ESD SPONGE</td> <td>1</td> <td>PZ</td> </tr> <tr> <td>VP1026A0</td> <td>MW LED COVE</td> <td>1</td> <td>PZ</td> </tr> </tbody> </table>	Code	Description	Qty	UOM	VM1059A1	HEAT SHRINK FILM H800	1	M	VM2147A0	410X343X15 MM PINK SMOOTH ESD SPONGE	1	PZ	VP1026A0	MW LED COVE	1	PZ																
Code	Description	Qty	UOM																																		
VM1059A1	HEAT SHRINK FILM H800	1	M																																		
VM2147A0	410X343X15 MM PINK SMOOTH ESD SPONGE	1	PZ																																		
VP1026A0	MW LED COVE	1	PZ																																		
LP1055A	SPEED PRO RGB LED BAR		KLP1055A	SPEED PRO RGB LED BAR KIT	<table border="1"> <thead> <tr> <th>Code</th> <th>Description</th> <th>Qty</th> <th>UOM</th> </tr> </thead> <tbody> <tr> <td>CE1053B0</td> <td>MM MICROFIT LED BAR POWER SUPPLY CABL</td> <td>1</td> <td>PZ</td> </tr> <tr> <td>GN1682A0</td> <td></td> <td>1</td> <td>PZ</td> </tr> <tr> <td>IP1385A1</td> <td>CORNER POLYSTYRENE PACKING 110X80X2000</td> <td>1</td> <td>M</td> </tr> <tr> <td>LP1055A0</td> <td>SPEED PRO RGB LED BAR</td> <td>1</td> <td>PZ</td> </tr> <tr> <td>VM1059A1</td> <td>HEAT SHRINK FILM H800</td> <td>1</td> <td>M</td> </tr> <tr> <td>VM2147A0</td> <td>410X343X15 MM PINK SMOOTH ESD SPONGE</td> <td>1</td> <td>PZ</td> </tr> <tr> <td>VP1026A0</td> <td>MW LED COVE</td> <td>1</td> <td>PZ</td> </tr> </tbody> </table>	Code	Description	Qty	UOM	CE1053B0	MM MICROFIT LED BAR POWER SUPPLY CABL	1	PZ	GN1682A0		1	PZ	IP1385A1	CORNER POLYSTYRENE PACKING 110X80X2000	1	M	LP1055A0	SPEED PRO RGB LED BAR	1	PZ	VM1059A1	HEAT SHRINK FILM H800	1	M	VM2147A0	410X343X15 MM PINK SMOOTH ESD SPONGE	1	PZ	VP1026A0	MW LED COVE	1	PZ
Code	Description	Qty	UOM																																		
CE1053B0	MM MICROFIT LED BAR POWER SUPPLY CABL	1	PZ																																		
GN1682A0		1	PZ																																		
IP1385A1	CORNER POLYSTYRENE PACKING 110X80X2000	1	M																																		
LP1055A0	SPEED PRO RGB LED BAR	1	PZ																																		
VM1059A1	HEAT SHRINK FILM H800	1	M																																		
VM2147A0	410X343X15 MM PINK SMOOTH ESD SPONGE	1	PZ																																		
VP1026A0	MW LED COVE	1	PZ																																		
VP1022A	MW DOOR LEFT UPPER CAP		KVP1022A		<table border="1"> <thead> <tr> <th>Code</th> <th>Description</th> <th>Qty</th> <th>UOM</th> </tr> </thead> <tbody> <tr> <td>VM1224A0</td> <td>65MY 220MM 2 COLOURS SHRINK TUBE</td> <td>0.200</td> <td>M</td> </tr> <tr> <td>VP1022A0</td> <td>MW DOOR LEFT UPPER CAP</td> <td>1</td> <td>PZ</td> </tr> </tbody> </table>	Code	Description	Qty	UOM	VM1224A0	65MY 220MM 2 COLOURS SHRINK TUBE	0.200	M	VP1022A0	MW DOOR LEFT UPPER CAP	1	PZ																				
Code	Description	Qty	UOM																																		
VM1224A0	65MY 220MM 2 COLOURS SHRINK TUBE	0.200	M																																		
VP1022A0	MW DOOR LEFT UPPER CAP	1	PZ																																		
VP1026A	MW LED COVER		VP1026A0	MW LED COVER																																	

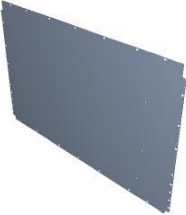



COMPONENT			SPARE PART														
Code	Description	Image	Code	Description	Components list												
VI2043A	5X40 ST. STEEL SCREW FOR PLASTI		VI2043A0	5X40 ST. STEEL SCREW FOR PLASTI													
VP1023A	MW DOOR RIGHT UPPER CAP		KVP1023A		<table border="1"> <thead> <tr> <th>Code</th> <th>Description</th> <th>Qty</th> <th>UOM</th> </tr> </thead> <tbody> <tr> <td>VM1224A0</td> <td>65MY 220MM 2 COLOURS SHRINK TUBE</td> <td>0.200</td> <td>M</td> </tr> <tr> <td>VP1023A0</td> <td>MW DOOR RIGHT UPPER CAP</td> <td>1</td> <td>PZ</td> </tr> </tbody> </table>	Code	Description	Qty	UOM	VM1224A0	65MY 220MM 2 COLOURS SHRINK TUBE	0.200	M	VP1023A0	MW DOOR RIGHT UPPER CAP	1	PZ
Code	Description	Qty	UOM														
VM1224A0	65MY 220MM 2 COLOURS SHRINK TUBE	0.200	M														
VP1023A0	MW DOOR RIGHT UPPER CAP	1	PZ														
OH5266A			OH5266A1														
OH5269A			OH5269A1														
OH5270A			OH5270A1														

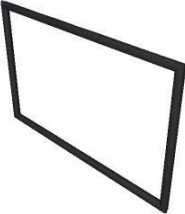

COMPONENT			SPARE PART										
Code	Description	Image	Code	Description	Components list								
0H2689B			0H2689B0										
0H5267A			0H5267A1										
0H5268B			0H5268B0										
GN1432B			KGN1432B		<table border="1"> <thead> <tr> <th>Code</th> <th>Description</th> <th>Qty</th> <th>UOM</th> </tr> </thead> <tbody> <tr> <td>GN1432B1</td> <td></td> <td>1</td> <td>PZ</td> </tr> </tbody> </table>	Code	Description	Qty	UOM	GN1432B1		1	PZ
Code	Description	Qty	UOM										
GN1432B1		1	PZ										



**ASM3199A/0.D01 - Cooking chamber**

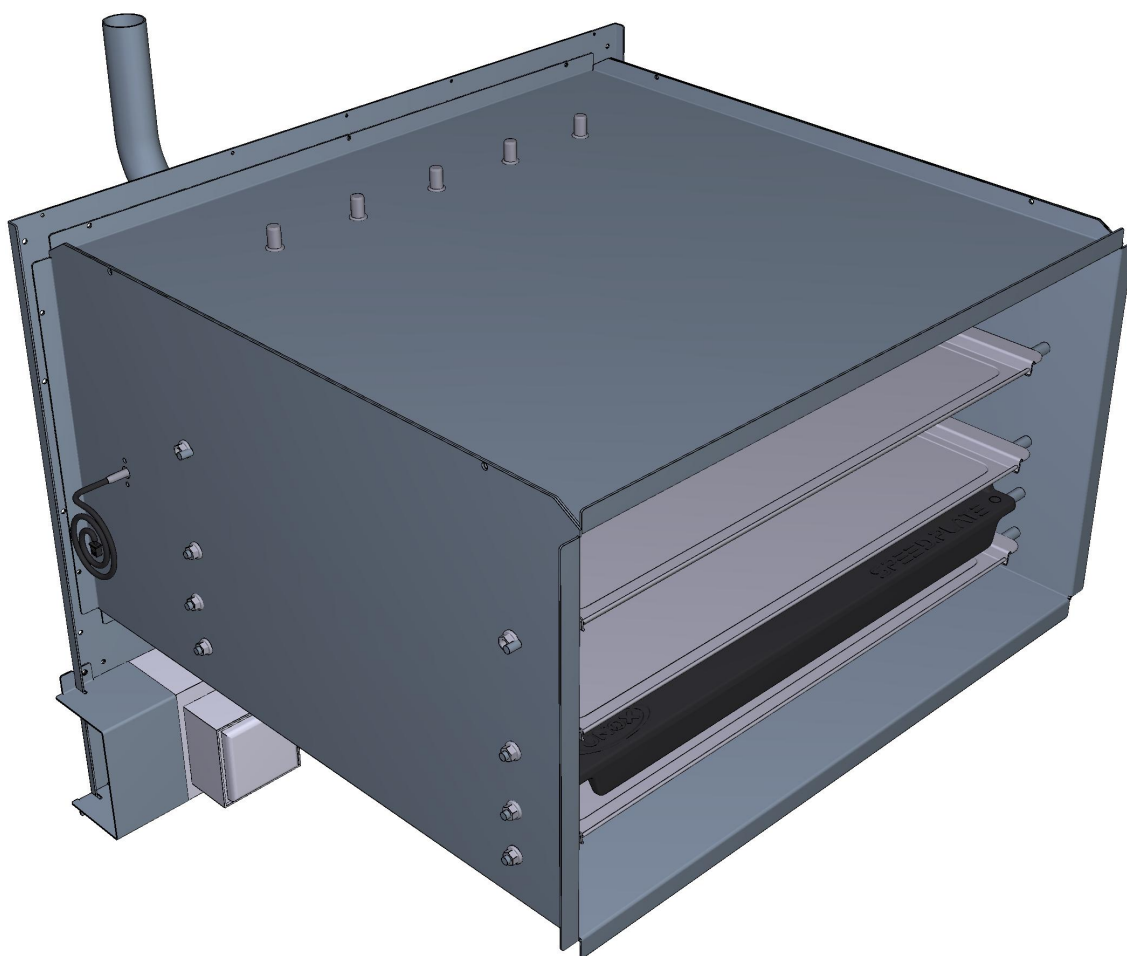

**FRONT**





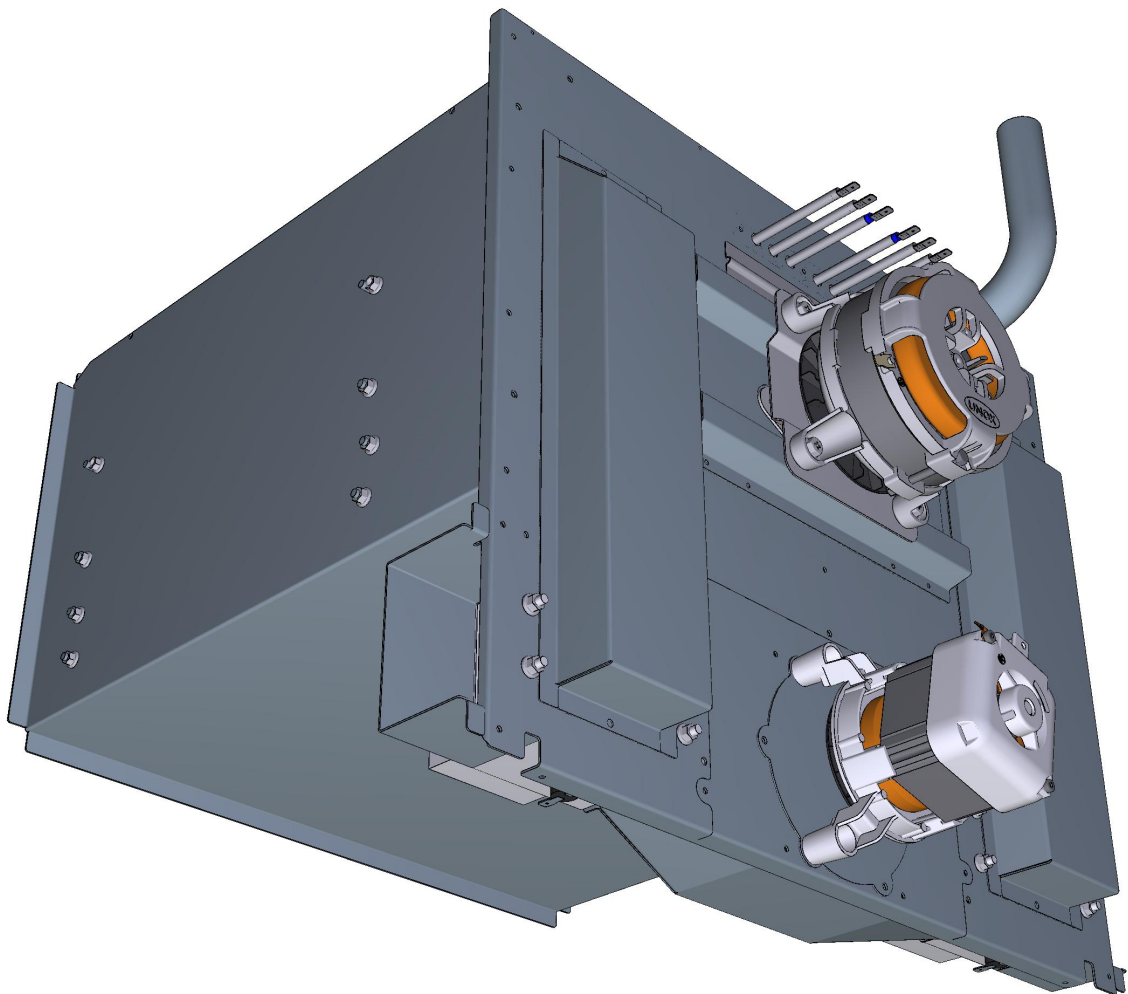

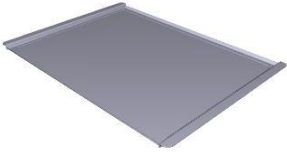
**ASM3199A/0.D01 - Cooking chamber**

**REAR**

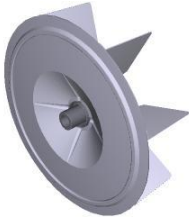

COMPONENT			SPARE PART																																														
Code	Description	Image	Code	Description	Components list																																												
ATG305	TRAY 460X330 FLAT ALUMINIUM		ATG3050	TRAY 460X330 FLAT ALUMINIUM																																													
TR1105A	L1000 PT100 TEMPERATURE PROBE		KTR1105A	PT100 L1000 TEMPERATURE PROBE KIT	<table border="1"> <thead> <tr> <th>Code</th> <th>Description</th> <th>Qty</th> <th>UOM</th> </tr> </thead> <tbody> <tr> <td>GN1120A0</td> <td>NTC TEMPERATUR E PROBE SEAL</td> <td>1</td> <td>PZ</td> </tr> <tr> <td>GN1120A1</td> <td>NTC TEMPERATUR E PROBE SEAL</td> <td>1</td> <td>PZ</td> </tr> <tr> <td>GN1285A0</td> <td>NTC TEMPERATUR E PROBE SEALING</td> <td>1</td> <td>PZ</td> </tr> <tr> <td>MOV0010A0</td> <td>HOOD RING GASKET GN1110A2</td> <td>0.100</td> <td>PZ</td> </tr> <tr> <td>SL1045A0</td> <td>S57 BLACK SILICONE - 80ML CARTRIDGE</td> <td>1</td> <td>PZ</td> </tr> <tr> <td>TR1105A4</td> <td>L1000 PT100 TEMPERATUR E PROBE</td> <td>1</td> <td>PZ</td> </tr> <tr> <td>VI1220A1</td> <td>4,2X12 TCB SELF-TAPPIN G SCREW</td> <td>2</td> <td>PZ</td> </tr> <tr> <td>VM1464A1</td> <td>CT BT TEMPERATUR E PROBE COVER</td> <td>1</td> <td>PZ</td> </tr> <tr> <td>VM1465A1</td> <td>CT BT TEMPERATUR E PROBE COVER</td> <td>1</td> <td>PZ</td> </tr> <tr> <td>VM2052A0</td> <td>LM CORE PROBE COVE</td> <td>1</td> <td>PZ</td> </tr> </tbody> </table>	Code	Description	Qty	UOM	GN1120A0	NTC TEMPERATUR E PROBE SEAL	1	PZ	GN1120A1	NTC TEMPERATUR E PROBE SEAL	1	PZ	GN1285A0	NTC TEMPERATUR E PROBE SEALING	1	PZ	MOV0010A0	HOOD RING GASKET GN1110A2	0.100	PZ	SL1045A0	S57 BLACK SILICONE - 80ML CARTRIDGE	1	PZ	TR1105A4	L1000 PT100 TEMPERATUR E PROBE	1	PZ	VI1220A1	4,2X12 TCB SELF-TAPPIN G SCREW	2	PZ	VM1464A1	CT BT TEMPERATUR E PROBE COVER	1	PZ	VM1465A1	CT BT TEMPERATUR E PROBE COVER	1	PZ	VM2052A0	LM CORE PROBE COVE	1	PZ
Code	Description	Qty	UOM																																														
GN1120A0	NTC TEMPERATUR E PROBE SEAL	1	PZ																																														
GN1120A1	NTC TEMPERATUR E PROBE SEAL	1	PZ																																														
GN1285A0	NTC TEMPERATUR E PROBE SEALING	1	PZ																																														
MOV0010A0	HOOD RING GASKET GN1110A2	0.100	PZ																																														
SL1045A0	S57 BLACK SILICONE - 80ML CARTRIDGE	1	PZ																																														
TR1105A4	L1000 PT100 TEMPERATUR E PROBE	1	PZ																																														
VI1220A1	4,2X12 TCB SELF-TAPPIN G SCREW	2	PZ																																														
VM1464A1	CT BT TEMPERATUR E PROBE COVER	1	PZ																																														
VM1465A1	CT BT TEMPERATUR E PROBE COVER	1	PZ																																														
VM2052A0	LM CORE PROBE COVE	1	PZ																																														
0H5252A			0H5252A1																																														

COMPONENT			SPARE PART																																														
Code	Description	Image	Code	Description	Components list																																												
MT1012A	330W 230V MOTOR		KVN1130A	LUX =08.2017/S.5/S.5E 330W MOTOR KIT	<table border="1"> <thead> <tr> <th>Code</th> <th>Description</th> <th>Qty</th> <th>UOM</th> </tr> </thead> <tbody> <tr> <td>0H4305A1</td> <td>ST. STEEL MOTOR SHAFT SEALING DISC</td> <td>1</td> <td>PZ</td> </tr> <tr> <td>GN1140A2</td> <td>MOTOR HOLDER GASKET</td> <td>1</td> <td>PZ</td> </tr> <tr> <td>GN1140A3</td> <td>MOLDED MOTOR HOLDER GASKET</td> <td>1</td> <td>PZ</td> </tr> <tr> <td>VI1045A0</td> <td>16X8,4 TH=1,6 ST.STEEL WASHER</td> <td>1</td> <td>PZ</td> </tr> <tr> <td>VI1256A0</td> <td>M8 DIN 980M ST. STEEL SELF LOCKING NUT</td> <td>1</td> <td>PZ</td> </tr> <tr> <td>VM1794A0</td> <td>250X4.8 PA66 BLACK CLAMP</td> <td>4</td> <td>PZ</td> </tr> <tr> <td>VM2103A0</td> <td>CLAMP LOCK</td> <td>4</td> <td>PZ</td> </tr> <tr> <td>VM2196A0</td> <td>MOTOR NUT FASTENING BUSHING</td> <td>1</td> <td>PZ</td> </tr> <tr> <td>VN1130A1</td> <td>330W 230V 50/60HZ MOTO</td> <td>1</td> <td>PZ</td> </tr> <tr> <td>VN1130A1</td> <td>330W 230V 50/60HZ MOTO</td> <td>1</td> <td>PZ</td> </tr> </tbody> </table>	Code	Description	Qty	UOM	0H4305A1	ST. STEEL MOTOR SHAFT SEALING DISC	1	PZ	GN1140A2	MOTOR HOLDER GASKET	1	PZ	GN1140A3	MOLDED MOTOR HOLDER GASKET	1	PZ	VI1045A0	16X8,4 TH=1,6 ST.STEEL WASHER	1	PZ	VI1256A0	M8 DIN 980M ST. STEEL SELF LOCKING NUT	1	PZ	VM1794A0	250X4.8 PA66 BLACK CLAMP	4	PZ	VM2103A0	CLAMP LOCK	4	PZ	VM2196A0	MOTOR NUT FASTENING BUSHING	1	PZ	VN1130A1	330W 230V 50/60HZ MOTO	1	PZ	VN1130A1	330W 230V 50/60HZ MOTO	1	PZ
			Code	Description	Qty	UOM																																											
0H4305A1	ST. STEEL MOTOR SHAFT SEALING DISC	1	PZ																																														
GN1140A2	MOTOR HOLDER GASKET	1	PZ																																														
GN1140A3	MOLDED MOTOR HOLDER GASKET	1	PZ																																														
VI1045A0	16X8,4 TH=1,6 ST.STEEL WASHER	1	PZ																																														
VI1256A0	M8 DIN 980M ST. STEEL SELF LOCKING NUT	1	PZ																																														
VM1794A0	250X4.8 PA66 BLACK CLAMP	4	PZ																																														
VM2103A0	CLAMP LOCK	4	PZ																																														
VM2196A0	MOTOR NUT FASTENING BUSHING	1	PZ																																														
VN1130A1	330W 230V 50/60HZ MOTO	1	PZ																																														
VN1130A1	330W 230V 50/60HZ MOTO	1	PZ																																														
KMT1012A	MIND.MAPS 330W 230V MOTOR KIT	<table border="1"> <thead> <tr> <th>Code</th> <th>Description</th> <th>Qty</th> <th>UOM</th> </tr> </thead> <tbody> <tr> <td>0H2842A0</td> <td></td> <td>1</td> <td>PZ</td> </tr> <tr> <td>0H4305A1</td> <td>ST. STEEL MOTOR SHAFT SEALING DISC</td> <td>1</td> <td>PZ</td> </tr> <tr> <td>GN1140A2</td> <td>MOTOR HOLDER GASKET</td> <td>1</td> <td>PZ</td> </tr> <tr> <td>GN1140A3</td> <td>MOLDED MOTOR HOLDER GASKET</td> <td>1</td> <td>PZ</td> </tr> <tr> <td>MOV0007A0</td> <td>HOOD RING GASKET GN1110A2</td> <td>0.100</td> <td>PZ</td> </tr> <tr> <td>MT1012A0</td> <td>330W 230V MOTOR</td> <td>1</td> <td>PZ</td> </tr> <tr> <td>VE1550A0</td> <td>5X3 MM NEODYMIUM MAGNET</td> <td>1</td> <td>PZ</td> </tr> <tr> <td>VI1077A1</td> <td>SCREW M6X12 TE INOX</td> <td>1</td> <td>PZ</td> </tr> </tbody> </table>	Code	Description	Qty	UOM	0H2842A0		1	PZ	0H4305A1	ST. STEEL MOTOR SHAFT SEALING DISC	1	PZ	GN1140A2	MOTOR HOLDER GASKET	1	PZ	GN1140A3	MOLDED MOTOR HOLDER GASKET	1	PZ	MOV0007A0	HOOD RING GASKET GN1110A2	0.100	PZ	MT1012A0	330W 230V MOTOR	1	PZ	VE1550A0	5X3 MM NEODYMIUM MAGNET	1	PZ	VI1077A1	SCREW M6X12 TE INOX	1	PZ											
Code	Description	Qty	UOM																																														
0H2842A0		1	PZ																																														
0H4305A1	ST. STEEL MOTOR SHAFT SEALING DISC	1	PZ																																														
GN1140A2	MOTOR HOLDER GASKET	1	PZ																																														
GN1140A3	MOLDED MOTOR HOLDER GASKET	1	PZ																																														
MOV0007A0	HOOD RING GASKET GN1110A2	0.100	PZ																																														
MT1012A0	330W 230V MOTOR	1	PZ																																														
VE1550A0	5X3 MM NEODYMIUM MAGNET	1	PZ																																														
VI1077A1	SCREW M6X12 TE INOX	1	PZ																																														



COMPONENT			SPARE PART																										
Code	Description	Image	Code	Description	Components list																								
MT1012A	330W 230V MOTOR		KMT1012A	MIND.MAPS 330W 230V MOTOR KIT	<table border="1"> <thead> <tr> <th>Code</th> <th>Description</th> <th>Qty</th> <th>UOM</th> </tr> </thead> <tbody> <tr> <td>VI1521A0</td> <td>STAINLESS STEEL WASHER D=6 6592</td> <td>1</td> <td>PZ</td> </tr> <tr> <td>VI1966A0</td> <td>M4X14 FLATHEAD SCREW</td> <td>1</td> <td>PZ</td> </tr> <tr> <td>VM1635A0</td> <td>MAGNET HOLDING DIS</td> <td>1</td> <td>PZ</td> </tr> <tr> <td>VM1794A0</td> <td>250X4.8 PA66 BLACK CLAMP</td> <td>4</td> <td>PZ</td> </tr> <tr> <td>VM2103A0</td> <td>CLAMP LOCK</td> <td>4</td> <td>PZ</td> </tr> </tbody> </table>	Code	Description	Qty	UOM	VI1521A0	STAINLESS STEEL WASHER D=6 6592	1	PZ	VI1966A0	M4X14 FLATHEAD SCREW	1	PZ	VM1635A0	MAGNET HOLDING DIS	1	PZ	VM1794A0	250X4.8 PA66 BLACK CLAMP	4	PZ	VM2103A0	CLAMP LOCK	4	PZ
					Code	Description	Qty	UOM																					
					VI1521A0	STAINLESS STEEL WASHER D=6 6592	1	PZ																					
					VI1966A0	M4X14 FLATHEAD SCREW	1	PZ																					
					VM1635A0	MAGNET HOLDING DIS	1	PZ																					
VM1794A0	250X4.8 PA66 BLACK CLAMP	4	PZ																										
VM2103A0	CLAMP LOCK	4	PZ																										
VN1171A	D195 H60 8 BLADES FAN		KVN1171A	D195 H60 8 BLADES M8 NUT FAN KIT	<table border="1"> <thead> <tr> <th>Code</th> <th>Description</th> <th>Qty</th> <th>UOM</th> </tr> </thead> <tbody> <tr> <td>VI1077A1</td> <td>SCREW M6X12 TE INOX</td> <td>1</td> <td>PZ</td> </tr> <tr> <td>VI1521A0</td> <td>STAINLESS STEEL WASHER D=6 6592</td> <td>1</td> <td>PZ</td> </tr> <tr> <td>VN1171A0</td> <td>D195 H60 8 BLADES FAN</td> <td>1</td> <td>PZ</td> </tr> <tr> <td>VN1171A0</td> <td>D195 H60 8 BLADES FAN</td> <td>1</td> <td>PZ</td> </tr> </tbody> </table>	Code	Description	Qty	UOM	VI1077A1	SCREW M6X12 TE INOX	1	PZ	VI1521A0	STAINLESS STEEL WASHER D=6 6592	1	PZ	VN1171A0	D195 H60 8 BLADES FAN	1	PZ	VN1171A0	D195 H60 8 BLADES FAN	1	PZ				
					Code	Description	Qty	UOM																					
					VI1077A1	SCREW M6X12 TE INOX	1	PZ																					
					VI1521A0	STAINLESS STEEL WASHER D=6 6592	1	PZ																					
VN1171A0	D195 H60 8 BLADES FAN	1	PZ																										
VN1171A0	D195 H60 8 BLADES FAN	1	PZ																										
GN1547A	SHAFT GASKET D11.8		KGN1547A	D11.6 MOTOR SHAFT GASKET 3PCS KIT	<table border="1"> <thead> <tr> <th>Code</th> <th>Description</th> <th>Qty</th> <th>UOM</th> </tr> </thead> <tbody> <tr> <td>GN1547A1</td> <td>SHAFT GASKET D11.8</td> <td>3</td> <td>PZ</td> </tr> <tr> <td>VM1224A0</td> <td>65MY 220MM 2 COLOURS SHRINK TUBE</td> <td>0.200</td> <td>M</td> </tr> </tbody> </table>	Code	Description	Qty	UOM	GN1547A1	SHAFT GASKET D11.8	3	PZ	VM1224A0	65MY 220MM 2 COLOURS SHRINK TUBE	0.200	M												
					Code	Description	Qty	UOM																					
GN1547A1	SHAFT GASKET D11.8	3	PZ																										
VM1224A0	65MY 220MM 2 COLOURS SHRINK TUBE	0.200	M																										
0H3020A	MOTOR SHAFT SEALING DISC		0H3020A1	MOTOR SHAFT SEALING DISC																									





COMPONENT			SPARE PART																										
Code	Description	Image	Code	Description	Components list																								
0H5245A			0H5245A0																										
VM1462A			VM1462A0																										
VM1441A			VM1441A1																										
VM1442A			VM1442A1																										
VN1035B	LINE MISS 230 VAC MOTOR		KVN1035B	LINEMISS / LINEMICRO MOTOR KIT	<table border="1"> <thead> <tr> <th>Code</th> <th>Description</th> <th>Qty</th> <th>UOM</th> </tr> </thead> <tbody> <tr> <td>GN1270A0</td> <td>13X5.5X0.8 FLAT WASHER</td> <td>3</td> <td>PZ</td> </tr> <tr> <td>GN1546A0</td> <td>SHAFT GASKET D8</td> <td>1</td> <td>PZ</td> </tr> <tr> <td>VI1695A0</td> <td>M6X16 H6 CH10 STAINLESS STEEL NUT</td> <td>1</td> <td>PZ</td> </tr> <tr> <td>VI1700A0</td> <td>18X6.4X1.5 STAINLESS STEEL FLAT WASHER</td> <td>1</td> <td>PZ</td> </tr> <tr> <td>VI1836A0</td> <td>M6X12 OT63 ROTOR SCRE</td> <td>3</td> <td>PZ</td> </tr> </tbody> </table>	Code	Description	Qty	UOM	GN1270A0	13X5.5X0.8 FLAT WASHER	3	PZ	GN1546A0	SHAFT GASKET D8	1	PZ	VI1695A0	M6X16 H6 CH10 STAINLESS STEEL NUT	1	PZ	VI1700A0	18X6.4X1.5 STAINLESS STEEL FLAT WASHER	1	PZ	VI1836A0	M6X12 OT63 ROTOR SCRE	3	PZ
Code	Description	Qty	UOM																										
GN1270A0	13X5.5X0.8 FLAT WASHER	3	PZ																										
GN1546A0	SHAFT GASKET D8	1	PZ																										
VI1695A0	M6X16 H6 CH10 STAINLESS STEEL NUT	1	PZ																										
VI1700A0	18X6.4X1.5 STAINLESS STEEL FLAT WASHER	1	PZ																										
VI1836A0	M6X12 OT63 ROTOR SCRE	3	PZ																										

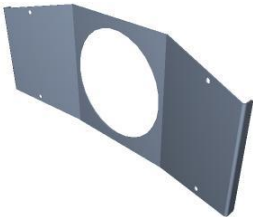
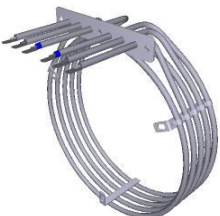

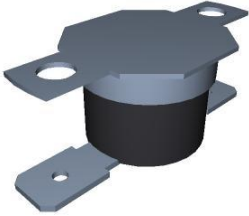

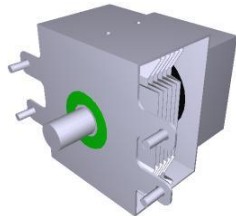
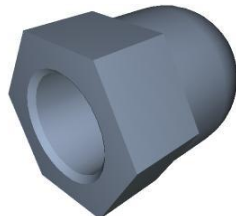
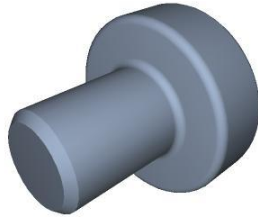
COMPONENT			SPARE PART																						
Code	Description	Image	Code	Description	Components list																				
VN1035B	LINE MISS 230 VAC MOTOR		KVN1035B	LINEMISS / LINEMICRO MOTOR KIT	<table border="1"> <thead> <tr> <th>Code</th> <th>Description</th> <th>Qty</th> <th>UOM</th> </tr> </thead> <tbody> <tr> <td>VM1794A0</td> <td>250X4.8 PA66 BLACK CLAMP</td> <td>3</td> <td>PZ</td> </tr> <tr> <td>VM2103A0</td> <td>CLAMP LOCK</td> <td>3</td> <td>PZ</td> </tr> <tr> <td>VN1035B1</td> <td>LINE MISS 230 VAC MOTOR</td> <td>1</td> <td>PZ</td> </tr> <tr> <td>VN1035B1</td> <td>LINE MISS 230 VAC MOTOR</td> <td>1</td> <td>PZ</td> </tr> </tbody> </table>	Code	Description	Qty	UOM	VM1794A0	250X4.8 PA66 BLACK CLAMP	3	PZ	VM2103A0	CLAMP LOCK	3	PZ	VN1035B1	LINE MISS 230 VAC MOTOR	1	PZ	VN1035B1	LINE MISS 230 VAC MOTOR	1	PZ
Code	Description	Qty	UOM																						
VM1794A0	250X4.8 PA66 BLACK CLAMP	3	PZ																						
VM2103A0	CLAMP LOCK	3	PZ																						
VN1035B1	LINE MISS 230 VAC MOTOR	1	PZ																						
VN1035B1	LINE MISS 230 VAC MOTOR	1	PZ																						
0H5246A			0H5246A1																						
VI1110A	AUTOBLOCKING NUT STAINLESS STEEL		VI1110A0	AUTOBLOCKING NUT STAINLESS STEEL																					
VN1182A	M6 NUT 24 BLADES H60 D120 FAN		KVN1182A	SPEED.PRO COOLING FAN KIT	<table border="1"> <thead> <tr> <th>Code</th> <th>Description</th> <th>Qty</th> <th>UOM</th> </tr> </thead> <tbody> <tr> <td>VI1110A0</td> <td>AUTOBLOCKING NUT STAINLESS STEEL</td> <td>1</td> <td>PZ</td> </tr> <tr> <td>VN1182A0</td> <td>M6 NUT 24 BLADES H60 D120 FAN</td> <td>1</td> <td>PZ</td> </tr> </tbody> </table>	Code	Description	Qty	UOM	VI1110A0	AUTOBLOCKING NUT STAINLESS STEEL	1	PZ	VN1182A0	M6 NUT 24 BLADES H60 D120 FAN	1	PZ								
Code	Description	Qty	UOM																						
VI1110A0	AUTOBLOCKING NUT STAINLESS STEEL	1	PZ																						
VN1182A0	M6 NUT 24 BLADES H60 D120 FAN	1	PZ																						
0H5247A			0H5247A1																						

COMPONENT			SPARE PART																										
Code	Description	Image	Code	Description	Components list																								
0H5248A			0H5248A1																										
RS1018A	2X1600W 230V+210W CIRCULAR HEAT. ELEMENT		KRS1018A	SPEED.PRO HEATING ELEMENT KIT	<table border="1"> <thead> <tr> <th>Code</th> <th>Description</th> <th>Qty</th> <th>UOM</th> </tr> </thead> <tbody> <tr> <td>GN1671A0</td> <td>141X22 G8.5 ELEMENT ARMED GASKET</td> <td>1</td> <td>PZ</td> </tr> <tr> <td>RS1018A0</td> <td>2X1600W 230V+210W CIRCULAR HEAT. ELEMENT</td> <td>1</td> <td>PZ</td> </tr> <tr> <td>VI1220A1</td> <td>4,2X12 TCB SELF-TAPPIN G SCREW</td> <td>6</td> <td>PZ</td> </tr> <tr> <td>VM1794A0</td> <td>250X4.8 PA66 BLACK CLAMP</td> <td>2</td> <td>PZ</td> </tr> <tr> <td>VM2103A0</td> <td>CLAMP LOCK</td> <td>2</td> <td>PZ</td> </tr> </tbody> </table>	Code	Description	Qty	UOM	GN1671A0	141X22 G8.5 ELEMENT ARMED GASKET	1	PZ	RS1018A0	2X1600W 230V+210W CIRCULAR HEAT. ELEMENT	1	PZ	VI1220A1	4,2X12 TCB SELF-TAPPIN G SCREW	6	PZ	VM1794A0	250X4.8 PA66 BLACK CLAMP	2	PZ	VM2103A0	CLAMP LOCK	2	PZ
Code	Description	Qty	UOM																										
GN1671A0	141X22 G8.5 ELEMENT ARMED GASKET	1	PZ																										
RS1018A0	2X1600W 230V+210W CIRCULAR HEAT. ELEMENT	1	PZ																										
VI1220A1	4,2X12 TCB SELF-TAPPIN G SCREW	6	PZ																										
VM1794A0	250X4.8 PA66 BLACK CLAMP	2	PZ																										
VM2103A0	CLAMP LOCK	2	PZ																										
TB2714A	BAFFLE CHIMNEY		TB2714A1	BAFFLE CHIMNEY																									
TR1164A			KTR1164A	SPEED.PRO THERMOSTAT KIT	<table border="1"> <thead> <tr> <th>Code</th> <th>Description</th> <th>Qty</th> <th>UOM</th> </tr> </thead> <tbody> <tr> <td>TR1164A0</td> <td></td> <td>1</td> <td>PZ</td> </tr> <tr> <td>VM1224A0</td> <td>65MY 220MM 2 COLOURS SHRINK TUBE</td> <td>0.200</td> <td>M</td> </tr> </tbody> </table>	Code	Description	Qty	UOM	TR1164A0		1	PZ	VM1224A0	65MY 220MM 2 COLOURS SHRINK TUBE	0.200	M												
Code	Description	Qty	UOM																										
TR1164A0		1	PZ																										
VM1224A0	65MY 220MM 2 COLOURS SHRINK TUBE	0.200	M																										

COMPONENT			SPARE PART																		
Code	Description	Image	Code	Description	Components list																
VE1800A			KVE1800A	SPEED.PRO 1080W MAGNETRON KIT	<table border="1"> <thead> <tr> <th>Code</th> <th>Description</th> <th>Qty</th> <th>UOM</th> </tr> </thead> <tbody> <tr> <td>TR1164A0</td> <td></td> <td>1</td> <td>PZ</td> </tr> <tr> <td>VE1800A0</td> <td></td> <td>1</td> <td>PZ</td> </tr> <tr> <td>VI2037A1</td> <td>40X8 TORX SHEETTRACS SELF-THREAD SCREW</td> <td>2</td> <td>PZ</td> </tr> </tbody> </table>	Code	Description	Qty	UOM	TR1164A0		1	PZ	VE1800A0		1	PZ	VI2037A1	40X8 TORX SHEETTRACS SELF-THREAD SCREW	2	PZ
Code	Description	Qty	UOM																		
TR1164A0		1	PZ																		
VE1800A0		1	PZ																		
VI2037A1	40X8 TORX SHEETTRACS SELF-THREAD SCREW	2	PZ																		
VI1126A			VI1126A0																		
VI1127A			VI1127A0																		
VM1443A	SPEED.PRO CATALYTIC CONVERTER		KVM1443A	SPEED.PRO CATALYTIC CONVERTER 2PCS KIT	<table border="1"> <thead> <tr> <th>Code</th> <th>Description</th> <th>Qty</th> <th>UOM</th> </tr> </thead> <tbody> <tr> <td>VI1127A0</td> <td></td> <td>4</td> <td>PZ</td> </tr> <tr> <td>VM1443A0</td> <td>SPEED.PRO CATALYTIC CONVERTER</td> <td>2</td> <td>PZ</td> </tr> </tbody> </table>	Code	Description	Qty	UOM	VI1127A0		4	PZ	VM1443A0	SPEED.PRO CATALYTIC CONVERTER	2	PZ				
Code	Description	Qty	UOM																		
VI1127A0		4	PZ																		
VM1443A0	SPEED.PRO CATALYTIC CONVERTER	2	PZ																		
OG1076A			OG1076A1																		



COMPONENT			SPARE PART		
<i>Code</i>	<i>Description</i>	<i>Image</i>	<i>Code</i>	<i>Description</i>	<i>Components list</i>
0H5253B			0H5253B0		
GN1430B			GN1430B0		

**ASM3226A/0.D02 - External cover**

**FRONT**







ASM3226A/0.D02 - External cover





REAR



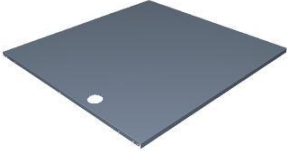

COMPONENT			SPARE PART																		
Code	Description	Image	Code	Description	Components list																
VM1750A	BRASS COMB CLAM		KVM1750A	COMB TERMINAL BLOCK KIT	<table border="1"> <thead> <tr> <th>Code</th> <th>Description</th> <th>Qty</th> <th>UOM</th> </tr> </thead> <tbody> <tr> <td>VM1224A0</td> <td>65MY 220MM 2 COLOURS SHRINK TUBE</td> <td>0.150</td> <td>M</td> </tr> <tr> <td>VM1750A0</td> <td>BRASS COMB CLAMP</td> <td>1</td> <td>PZ</td> </tr> </tbody> </table>	Code	Description	Qty	UOM	VM1224A0	65MY 220MM 2 COLOURS SHRINK TUBE	0.150	M	VM1750A0	BRASS COMB CLAMP	1	PZ				
Code	Description	Qty	UOM																		
VM1224A0	65MY 220MM 2 COLOURS SHRINK TUBE	0.150	M																		
VM1750A0	BRASS COMB CLAMP	1	PZ																		
VE1607A	RUBBER MAGNETIC SUCTION CUP		KVE1607A	MAGNETIC SUCTION CUP	<table border="1"> <thead> <tr> <th>Code</th> <th>Description</th> <th>Qty</th> <th>UOM</th> </tr> </thead> <tbody> <tr> <td>VE1607A1</td> <td>RUBBER MAGNETIC SUCTION CUP</td> <td>2</td> <td>PZ</td> </tr> <tr> <td>VI1700A0</td> <td>18X6.4X1.5 STAINLESS STEEL FLAT WASHER</td> <td>2</td> <td>PZ</td> </tr> <tr> <td>VM1224A0</td> <td>65MY 220MM 2 COLOURS SHRINK TUBE</td> <td>0.200</td> <td>M</td> </tr> </tbody> </table>	Code	Description	Qty	UOM	VE1607A1	RUBBER MAGNETIC SUCTION CUP	2	PZ	VI1700A0	18X6.4X1.5 STAINLESS STEEL FLAT WASHER	2	PZ	VM1224A0	65MY 220MM 2 COLOURS SHRINK TUBE	0.200	M
Code	Description	Qty	UOM																		
VE1607A1	RUBBER MAGNETIC SUCTION CUP	2	PZ																		
VI1700A0	18X6.4X1.5 STAINLESS STEEL FLAT WASHER	2	PZ																		
VM1224A0	65MY 220MM 2 COLOURS SHRINK TUBE	0.200	M																		
CE1355A	CABLE 5 X 2,5 MMQ H07RNF L = 1,5 MT		KCE1355A	L=1.5M 5X2.5MMQ POWER CABLE KIT	<table border="1"> <thead> <tr> <th>Code</th> <th>Description</th> <th>Qty</th> <th>UOM</th> </tr> </thead> <tbody> <tr> <td>CE1355A1</td> <td>CABLE 5 X 2,5 MMQ H07RNF L = 1,5 MT</td> <td>1</td> <td>PZ</td> </tr> <tr> <td>VM1224A0</td> <td>65MY 220MM 2 COLOURS SHRINK TUBE</td> <td>0.350</td> <td>M</td> </tr> </tbody> </table>	Code	Description	Qty	UOM	CE1355A1	CABLE 5 X 2,5 MMQ H07RNF L = 1,5 MT	1	PZ	VM1224A0	65MY 220MM 2 COLOURS SHRINK TUBE	0.350	M				
Code	Description	Qty	UOM																		
CE1355A1	CABLE 5 X 2,5 MMQ H07RNF L = 1,5 MT	1	PZ																		
VM1224A0	65MY 220MM 2 COLOURS SHRINK TUBE	0.350	M																		
VM1222A	CABLE LOCKS SP ACCESSORIES EL CONNECTION		VM1222A0	CABLE LOCKS SP ACCESSORIES EL CONNECTION																	
VM1631A	PLUS INNER GLASS PUSHING CAP		KVM1631A	CAP FOR INTERNAL GLASS 10 PCS KIT	<table border="1"> <thead> <tr> <th>Code</th> <th>Description</th> <th>Qty</th> <th>UOM</th> </tr> </thead> <tbody> <tr> <td>VM1224A0</td> <td>65MY 220MM 2 COLOURS SHRINK TUBE</td> <td>0.200</td> <td>M</td> </tr> <tr> <td>VM1631A0</td> <td>PLUS INNER GLASS PUSHING CAP</td> <td>10</td> <td>PZ</td> </tr> </tbody> </table>	Code	Description	Qty	UOM	VM1224A0	65MY 220MM 2 COLOURS SHRINK TUBE	0.200	M	VM1631A0	PLUS INNER GLASS PUSHING CAP	10	PZ				
Code	Description	Qty	UOM																		
VM1224A0	65MY 220MM 2 COLOURS SHRINK TUBE	0.200	M																		
VM1631A0	PLUS INNER GLASS PUSHING CAP	10	PZ																		



COMPONENT			SPARE PART																																		
Code	Description	Image	Code	Description	Components list																																
VI1328A			VI1328A0																																		
TR1136A	330 °C 1 POLE SAFETY THERMOSTAT		KTR1136A	330 °C SAFETY THERMOSTAT KIT	<table border="1"> <thead> <tr> <th>Code</th> <th>Description</th> <th>Qty</th> <th>UOM</th> </tr> </thead> <tbody> <tr> <td>0H7030A0</td> <td>THERMOSTAT BULB INLET COVER</td> <td>1</td> <td>PZ</td> </tr> <tr> <td>GN1531A0</td> <td>THERMOSTAT BULB INLET SEALING</td> <td>1</td> <td>PZ</td> </tr> <tr> <td>MOV0011A0</td> <td>HOOD RING GASKET</td> <td>0.100</td> <td>PZ</td> </tr> <tr> <td>GN1110A2</td> <td></td> <td></td> <td></td> </tr> <tr> <td>SL1045A0</td> <td>S57 BLACK SILICONE - 80ML CARTRIDGE</td> <td>1</td> <td>PZ</td> </tr> <tr> <td>TR1136A0</td> <td>330 °C 1 POLE SAFETY THERMOSTAT</td> <td>1</td> <td>PZ</td> </tr> <tr> <td>VI1220A1</td> <td>4,2X12 TCB SELF-TAPPING SCREW</td> <td>3</td> <td>PZ</td> </tr> </tbody> </table>	Code	Description	Qty	UOM	0H7030A0	THERMOSTAT BULB INLET COVER	1	PZ	GN1531A0	THERMOSTAT BULB INLET SEALING	1	PZ	MOV0011A0	HOOD RING GASKET	0.100	PZ	GN1110A2				SL1045A0	S57 BLACK SILICONE - 80ML CARTRIDGE	1	PZ	TR1136A0	330 °C 1 POLE SAFETY THERMOSTAT	1	PZ	VI1220A1	4,2X12 TCB SELF-TAPPING SCREW	3	PZ
Code	Description	Qty	UOM																																		
0H7030A0	THERMOSTAT BULB INLET COVER	1	PZ																																		
GN1531A0	THERMOSTAT BULB INLET SEALING	1	PZ																																		
MOV0011A0	HOOD RING GASKET	0.100	PZ																																		
GN1110A2																																					
SL1045A0	S57 BLACK SILICONE - 80ML CARTRIDGE	1	PZ																																		
TR1136A0	330 °C 1 POLE SAFETY THERMOSTAT	1	PZ																																		
VI1220A1	4,2X12 TCB SELF-TAPPING SCREW	3	PZ																																		
0D2491A			0D2491A1																																		
0D2492A			0D2492A1																																		



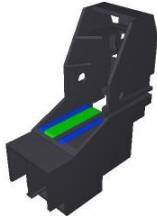

COMPONENT			SPARE PART		
Code	Description	Image	Code	Description	Components list
0D2493A			0D2493A1		
0H2919A			0H2919A0		
0H2597A			0H2597A0		
0H5254A			0H5254A1		
0H5255A			0H5255A1		

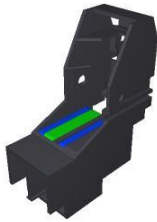



COMPONENT			SPARE PART																																		
Code	Description	Image	Code	Description	Components list																																
0H5256A			0H5256A1																																		
0H5258A			0H5258A1																																		
0H5274A			0H5274A1																																		
VE1820A			KVE1820A	SPEED.PRO DOOR MICROSWITCH 2PCS KIT	<table border="1"> <thead> <tr> <th>Code</th> <th>Description</th> <th>Qty</th> <th>UOM</th> </tr> </thead> <tbody> <tr> <td>0H5274A1</td> <td></td> <td>2</td> <td>PZ</td> </tr> <tr> <td>CE1030A0</td> <td>FEMALE FASTON COVER 6.3X0.8 0.5-1MMQ</td> <td>6</td> <td>PZ</td> </tr> <tr> <td>CE1205A0</td> <td>FEMALE INAR-LOCK END CONNECTOR</td> <td>9</td> <td>PZ</td> </tr> <tr> <td>CE1210A0</td> <td>5 WAYS FEMALE INAR-LOCK CONNECTOR</td> <td>1</td> <td>PZ</td> </tr> <tr> <td>CE1335A0</td> <td>4 WAYS MALE INAR-LOCK CONNECTOR</td> <td>1</td> <td>PZ</td> </tr> <tr> <td>CE1340A0</td> <td>5 WAYS MALE INAR-LOCK CONNECTOR</td> <td>1</td> <td>PZ</td> </tr> <tr> <td>CE1350A0</td> <td>MALE INAR-LOCK END CONNECTOR</td> <td>5</td> <td>PZ</td> </tr> </tbody> </table>	Code	Description	Qty	UOM	0H5274A1		2	PZ	CE1030A0	FEMALE FASTON COVER 6.3X0.8 0.5-1MMQ	6	PZ	CE1205A0	FEMALE INAR-LOCK END CONNECTOR	9	PZ	CE1210A0	5 WAYS FEMALE INAR-LOCK CONNECTOR	1	PZ	CE1335A0	4 WAYS MALE INAR-LOCK CONNECTOR	1	PZ	CE1340A0	5 WAYS MALE INAR-LOCK CONNECTOR	1	PZ	CE1350A0	MALE INAR-LOCK END CONNECTOR	5	PZ
Code	Description	Qty	UOM																																		
0H5274A1		2	PZ																																		
CE1030A0	FEMALE FASTON COVER 6.3X0.8 0.5-1MMQ	6	PZ																																		
CE1205A0	FEMALE INAR-LOCK END CONNECTOR	9	PZ																																		
CE1210A0	5 WAYS FEMALE INAR-LOCK CONNECTOR	1	PZ																																		
CE1335A0	4 WAYS MALE INAR-LOCK CONNECTOR	1	PZ																																		
CE1340A0	5 WAYS MALE INAR-LOCK CONNECTOR	1	PZ																																		
CE1350A0	MALE INAR-LOCK END CONNECTOR	5	PZ																																		

COMPONENT			SPARE PART																																																						
Code	Description	Image	Code	Description	Components list																																																				
VE1820A			KVE1820A	SPEED.PRO DOOR MICROSWITCH 2PCS KIT	<table border="1"> <thead> <tr> <th>Code</th> <th>Description</th> <th>Qty</th> <th>UOM</th> </tr> </thead> <tbody> <tr> <td>CE1540A0</td> <td>BROWN UNIP AWG18 ST.3135 WIRE</td> <td>0.500</td> <td>M</td> </tr> <tr> <td>CE1545A0</td> <td>BLUE UNIP AWG18 ST.3135 WIRE</td> <td>1.950</td> <td>M</td> </tr> <tr> <td>CE1555A0</td> <td>YELLOW UNIP AWG18 ST.3135 WIRE</td> <td>1.100</td> <td>M</td> </tr> <tr> <td>CE1560A0</td> <td>BALCK UNIP AWG18 ST.3135 WIRE</td> <td>1.900</td> <td>M</td> </tr> <tr> <td>CE1565A0</td> <td>RED UNIP AWG18 ST.3135 WIRE</td> <td>1</td> <td>M</td> </tr> <tr> <td>CE1660A0</td> <td>6,3X0,8 FEMALE FASTON COVE</td> <td>6</td> <td>PZ</td> </tr> <tr> <td>RC1130A0</td> <td>130X2,6 CLAM</td> <td>5</td> <td>PZ</td> </tr> <tr> <td>VE1820A0</td> <td></td> <td>1</td> <td>PZ</td> </tr> <tr> <td>VE1825A0</td> <td></td> <td>1</td> <td>PZ</td> </tr> <tr> <td>VI2037A1</td> <td>40X8 TORX SHEETTRACS SELF-THREAD SCREW</td> <td>4</td> <td>PZ</td> </tr> <tr> <td>VP1027A0</td> <td>MW MICROSWITC H SUPPORT</td> <td>2</td> <td>PZ</td> </tr> <tr> <td>VP1028A0</td> <td>MICRO MW FIXING CAP</td> <td>4</td> <td>PZ</td> </tr> </tbody> </table>	Code	Description	Qty	UOM	CE1540A0	BROWN UNIP AWG18 ST.3135 WIRE	0.500	M	CE1545A0	BLUE UNIP AWG18 ST.3135 WIRE	1.950	M	CE1555A0	YELLOW UNIP AWG18 ST.3135 WIRE	1.100	M	CE1560A0	BALCK UNIP AWG18 ST.3135 WIRE	1.900	M	CE1565A0	RED UNIP AWG18 ST.3135 WIRE	1	M	CE1660A0	6,3X0,8 FEMALE FASTON COVE	6	PZ	RC1130A0	130X2,6 CLAM	5	PZ	VE1820A0		1	PZ	VE1825A0		1	PZ	VI2037A1	40X8 TORX SHEETTRACS SELF-THREAD SCREW	4	PZ	VP1027A0	MW MICROSWITC H SUPPORT	2	PZ	VP1028A0	MICRO MW FIXING CAP	4	PZ
Code	Description	Qty	UOM																																																						
CE1540A0	BROWN UNIP AWG18 ST.3135 WIRE	0.500	M																																																						
CE1545A0	BLUE UNIP AWG18 ST.3135 WIRE	1.950	M																																																						
CE1555A0	YELLOW UNIP AWG18 ST.3135 WIRE	1.100	M																																																						
CE1560A0	BALCK UNIP AWG18 ST.3135 WIRE	1.900	M																																																						
CE1565A0	RED UNIP AWG18 ST.3135 WIRE	1	M																																																						
CE1660A0	6,3X0,8 FEMALE FASTON COVE	6	PZ																																																						
RC1130A0	130X2,6 CLAM	5	PZ																																																						
VE1820A0		1	PZ																																																						
VE1825A0		1	PZ																																																						
VI2037A1	40X8 TORX SHEETTRACS SELF-THREAD SCREW	4	PZ																																																						
VP1027A0	MW MICROSWITC H SUPPORT	2	PZ																																																						
VP1028A0	MICRO MW FIXING CAP	4	PZ																																																						
VP1027A	MW MICROSWITCH SUPPORT		KVP1027A	MW DOOR MICROSWITCH HOLDER 2 PCS KIT	<table border="1"> <thead> <tr> <th>Code</th> <th>Description</th> <th>Qty</th> <th>UOM</th> </tr> </thead> <tbody> <tr> <td>VI2037A1</td> <td>40X8 TORX SHEETTRACS SELF-THREAD SCREW</td> <td>4</td> <td>PZ</td> </tr> <tr> <td>VM1224A0</td> <td>65MY 220MM 2 COLOURS SHRINK TUBE</td> <td>0.200</td> <td>M</td> </tr> <tr> <td>VP1027A0</td> <td>MW MICROSWITC H SUPPORT</td> <td>2</td> <td>PZ</td> </tr> <tr> <td>VP1028A0</td> <td>MICRO MW FIXING CAP</td> <td>4</td> <td>PZ</td> </tr> </tbody> </table>	Code	Description	Qty	UOM	VI2037A1	40X8 TORX SHEETTRACS SELF-THREAD SCREW	4	PZ	VM1224A0	65MY 220MM 2 COLOURS SHRINK TUBE	0.200	M	VP1027A0	MW MICROSWITC H SUPPORT	2	PZ	VP1028A0	MICRO MW FIXING CAP	4	PZ																																
Code	Description	Qty	UOM																																																						
VI2037A1	40X8 TORX SHEETTRACS SELF-THREAD SCREW	4	PZ																																																						
VM1224A0	65MY 220MM 2 COLOURS SHRINK TUBE	0.200	M																																																						
VP1027A0	MW MICROSWITC H SUPPORT	2	PZ																																																						
VP1028A0	MICRO MW FIXING CAP	4	PZ																																																						
VP1028A	MICRO MW FIXING CAP		VP1028A0	MICRO MW FIXING CAP																																																					



COMPONENT			SPARE PART																														
Code	Description	Image	Code	Description	Components list																												
0H5274A			0H5274A1																														
VP1027A	MW MICROSWITCH SUPPORT		KVP1027A	MW DOOR MICROSWITCH HOLDER 2 PCS KIT	<table border="1"> <thead> <tr> <th>Code</th> <th>Description</th> <th>Qty</th> <th>UOM</th> </tr> </thead> <tbody> <tr> <td>VI2037A1</td> <td>40X8 TORX SHEETTRACS SELF-THREAD SCREW</td> <td>4</td> <td>PZ</td> </tr> <tr> <td>VM1224A0</td> <td>65MY 220MM 2 COLOURS SHRINK TUBE</td> <td>0.200</td> <td>M</td> </tr> <tr> <td>VP1027A0</td> <td>MW MICROSWITCH SUPPORT</td> <td>2</td> <td>PZ</td> </tr> <tr> <td>VP1028A0</td> <td>MICRO MW FIXING CAP</td> <td>4</td> <td>PZ</td> </tr> </tbody> </table>	Code	Description	Qty	UOM	VI2037A1	40X8 TORX SHEETTRACS SELF-THREAD SCREW	4	PZ	VM1224A0	65MY 220MM 2 COLOURS SHRINK TUBE	0.200	M	VP1027A0	MW MICROSWITCH SUPPORT	2	PZ	VP1028A0	MICRO MW FIXING CAP	4	PZ								
Code	Description	Qty	UOM																														
VI2037A1	40X8 TORX SHEETTRACS SELF-THREAD SCREW	4	PZ																														
VM1224A0	65MY 220MM 2 COLOURS SHRINK TUBE	0.200	M																														
VP1027A0	MW MICROSWITCH SUPPORT	2	PZ																														
VP1028A0	MICRO MW FIXING CAP	4	PZ																														
VP1028A	MICRO MW FIXING CAP		VP1028A0	MICRO MW FIXING CAP																													
VE1825A			KVE1820A	SPEED.PRO DOOR MICROSWITCH 2PCS KIT	<table border="1"> <thead> <tr> <th>Code</th> <th>Description</th> <th>Qty</th> <th>UOM</th> </tr> </thead> <tbody> <tr> <td>0H5274A1</td> <td></td> <td>2</td> <td>PZ</td> </tr> <tr> <td>CE1030A0</td> <td>FEMALE FASTON COVER 6.3X0.8 0.5-1MMQ</td> <td>6</td> <td>PZ</td> </tr> <tr> <td>CE1205A0</td> <td>FEMALE INAR-LOCK END CONNECTOR</td> <td>9</td> <td>PZ</td> </tr> <tr> <td>CE1210A0</td> <td>5 WAYS FEMALE INAR-LOCK CONNECTOR</td> <td>1</td> <td>PZ</td> </tr> <tr> <td>CE1335A0</td> <td>4 WAYS MALE INAR-LOCK CONNECTOR</td> <td>1</td> <td>PZ</td> </tr> <tr> <td>CE1340A0</td> <td>5 WAYS MALE INAR-LOCK CONNECTOR</td> <td>1</td> <td>PZ</td> </tr> </tbody> </table>	Code	Description	Qty	UOM	0H5274A1		2	PZ	CE1030A0	FEMALE FASTON COVER 6.3X0.8 0.5-1MMQ	6	PZ	CE1205A0	FEMALE INAR-LOCK END CONNECTOR	9	PZ	CE1210A0	5 WAYS FEMALE INAR-LOCK CONNECTOR	1	PZ	CE1335A0	4 WAYS MALE INAR-LOCK CONNECTOR	1	PZ	CE1340A0	5 WAYS MALE INAR-LOCK CONNECTOR	1	PZ
Code	Description	Qty	UOM																														
0H5274A1		2	PZ																														
CE1030A0	FEMALE FASTON COVER 6.3X0.8 0.5-1MMQ	6	PZ																														
CE1205A0	FEMALE INAR-LOCK END CONNECTOR	9	PZ																														
CE1210A0	5 WAYS FEMALE INAR-LOCK CONNECTOR	1	PZ																														
CE1335A0	4 WAYS MALE INAR-LOCK CONNECTOR	1	PZ																														
CE1340A0	5 WAYS MALE INAR-LOCK CONNECTOR	1	PZ																														



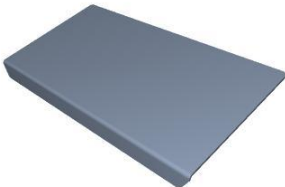

COMPONENT			SPARE PART																																																										
Code	Description	Image	Code	Description	Components list																																																								
VE1825A			KVE1820A	SPEED.PRO DOOR MICROSWITCH 2PCS KIT	<table border="1"> <thead> <tr> <th>Code</th> <th>Description</th> <th>Qty</th> <th>UOM</th> </tr> </thead> <tbody> <tr> <td>CE1350A0</td> <td>MALE INAR-LOCK END CONNECTOR</td> <td>5</td> <td>PZ</td> </tr> <tr> <td>CE1540A0</td> <td>BROWN UNIP AWG18 ST.3135 WIRE</td> <td>0.500</td> <td>M</td> </tr> <tr> <td>CE1545A0</td> <td>BLUE UNIP AWG18 ST.3135 WIRE</td> <td>1.950</td> <td>M</td> </tr> <tr> <td>CE1555A0</td> <td>YELLOW UNIP AWG18 ST.3135 WIRE</td> <td>1.100</td> <td>M</td> </tr> <tr> <td>CE1560A0</td> <td>BALCK UNIP AWG18 ST.3135 WIRE</td> <td>1.900</td> <td>M</td> </tr> <tr> <td>CE1565A0</td> <td>RED UNIP AWG18 ST.3135 WIRE</td> <td>1</td> <td>M</td> </tr> <tr> <td>CE1660A0</td> <td>6,3X0,8 FEMALE FASTON COVE</td> <td>6</td> <td>PZ</td> </tr> <tr> <td>RC1130A0</td> <td>130X2,6 CLAM</td> <td>5</td> <td>PZ</td> </tr> <tr> <td>VE1820A0</td> <td></td> <td>1</td> <td>PZ</td> </tr> <tr> <td>VE1825A0</td> <td></td> <td>1</td> <td>PZ</td> </tr> <tr> <td>VI2037A1</td> <td>40X8 TORX SHEETTRACS SELF-THREAD SCREW</td> <td>4</td> <td>PZ</td> </tr> <tr> <td>VP1027A0</td> <td>MW MICROSWITC H SUPPORT</td> <td>2</td> <td>PZ</td> </tr> <tr> <td>VP1028A0</td> <td>MICRO MW FIXING CAP</td> <td>4</td> <td>PZ</td> </tr> </tbody> </table>	Code	Description	Qty	UOM	CE1350A0	MALE INAR-LOCK END CONNECTOR	5	PZ	CE1540A0	BROWN UNIP AWG18 ST.3135 WIRE	0.500	M	CE1545A0	BLUE UNIP AWG18 ST.3135 WIRE	1.950	M	CE1555A0	YELLOW UNIP AWG18 ST.3135 WIRE	1.100	M	CE1560A0	BALCK UNIP AWG18 ST.3135 WIRE	1.900	M	CE1565A0	RED UNIP AWG18 ST.3135 WIRE	1	M	CE1660A0	6,3X0,8 FEMALE FASTON COVE	6	PZ	RC1130A0	130X2,6 CLAM	5	PZ	VE1820A0		1	PZ	VE1825A0		1	PZ	VI2037A1	40X8 TORX SHEETTRACS SELF-THREAD SCREW	4	PZ	VP1027A0	MW MICROSWITC H SUPPORT	2	PZ	VP1028A0	MICRO MW FIXING CAP	4	PZ
Code	Description	Qty	UOM																																																										
CE1350A0	MALE INAR-LOCK END CONNECTOR	5	PZ																																																										
CE1540A0	BROWN UNIP AWG18 ST.3135 WIRE	0.500	M																																																										
CE1545A0	BLUE UNIP AWG18 ST.3135 WIRE	1.950	M																																																										
CE1555A0	YELLOW UNIP AWG18 ST.3135 WIRE	1.100	M																																																										
CE1560A0	BALCK UNIP AWG18 ST.3135 WIRE	1.900	M																																																										
CE1565A0	RED UNIP AWG18 ST.3135 WIRE	1	M																																																										
CE1660A0	6,3X0,8 FEMALE FASTON COVE	6	PZ																																																										
RC1130A0	130X2,6 CLAM	5	PZ																																																										
VE1820A0		1	PZ																																																										
VE1825A0		1	PZ																																																										
VI2037A1	40X8 TORX SHEETTRACS SELF-THREAD SCREW	4	PZ																																																										
VP1027A0	MW MICROSWITC H SUPPORT	2	PZ																																																										
VP1028A0	MICRO MW FIXING CAP	4	PZ																																																										
VE1295A	MK 16A 230V DOOR MICROSWITCH		KVE1295A	16A 230V DOOR MICROSWITCH KIT	<table border="1"> <thead> <tr> <th>Code</th> <th>Description</th> <th>Qty</th> <th>UOM</th> </tr> </thead> <tbody> <tr> <td>VE1295A0</td> <td>MK 16A 230V DOOR MICROSWITC</td> <td>1</td> <td>PZ</td> </tr> <tr> <td>VM1224A0</td> <td>65MY 220MM 2 COLOURS SHRINK TUBE</td> <td>0.300</td> <td>M</td> </tr> </tbody> </table>	Code	Description	Qty	UOM	VE1295A0	MK 16A 230V DOOR MICROSWITC	1	PZ	VM1224A0	65MY 220MM 2 COLOURS SHRINK TUBE	0.300	M																																												
Code	Description	Qty	UOM																																																										
VE1295A0	MK 16A 230V DOOR MICROSWITC	1	PZ																																																										
VM1224A0	65MY 220MM 2 COLOURS SHRINK TUBE	0.300	M																																																										
VM1200A	DOOR MECHANIC MICROSWITCH SUPPORT PLATE		VM1200A0	DOOR MECHANIC MICROSWITCH SUPPORT PLATE																																																									

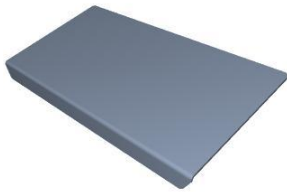

COMPONENT			SPARE PART																										
Code	Description	Image	Code	Description	Components list																								
VP1028A	MICRO MW FIXING CAP		VP1028A0	MICRO MW FIXING CAP																									
VP1049A	MW AIR EXHAUST GRID		KVP1049A	SPEED.PRO AIR OUTLET GRID KIT	<table border="1"> <thead> <tr> <th>Code</th> <th>Description</th> <th>Qty</th> <th>UOM</th> </tr> </thead> <tbody> <tr> <td>VI2037A1</td> <td>40X8 TORX SHEETTRACS SELF-THREAD SCREW</td> <td>1</td> <td>PZ</td> </tr> <tr> <td>VM1224A0</td> <td>65MY 220MM 2 COLOURS SHRINK TUBE</td> <td>0.200</td> <td>M</td> </tr> <tr> <td>VP1049A0</td> <td>MW AIR EXHAUST GRI</td> <td>1</td> <td>PZ</td> </tr> </tbody> </table>	Code	Description	Qty	UOM	VI2037A1	40X8 TORX SHEETTRACS SELF-THREAD SCREW	1	PZ	VM1224A0	65MY 220MM 2 COLOURS SHRINK TUBE	0.200	M	VP1049A0	MW AIR EXHAUST GRI	1	PZ								
Code	Description	Qty	UOM																										
VI2037A1	40X8 TORX SHEETTRACS SELF-THREAD SCREW	1	PZ																										
VM1224A0	65MY 220MM 2 COLOURS SHRINK TUBE	0.200	M																										
VP1049A0	MW AIR EXHAUST GRI	1	PZ																										
VN1165A	230VAC 50/60HZ COOLING DOWN FA		KVN1165A	S.5E ADVANCE/MM 230V COOLING FAN KIT	<table border="1"> <thead> <tr> <th>Code</th> <th>Description</th> <th>Qty</th> <th>UOM</th> </tr> </thead> <tbody> <tr> <td>MOV0017A0</td> <td>HOOD RING GASKET GN1110A2</td> <td>0.100</td> <td>PZ</td> </tr> <tr> <td>VI1099A0</td> <td>SELF-DRILLIN G SCREW 4.8X13 TGB+ Z</td> <td>4</td> <td>PZ</td> </tr> <tr> <td>VM1555A2</td> <td>CT BT COOLING FAN SUPPORT</td> <td>1</td> <td>PZ</td> </tr> <tr> <td>VN1165A0</td> <td>230VAC 50/60HZ COOLING DOWN FAN</td> <td>1</td> <td>PZ</td> </tr> <tr> <td>VN1165A0</td> <td>230VAC 50/60HZ COOLING DOWN FAN</td> <td>1</td> <td>PZ</td> </tr> </tbody> </table>	Code	Description	Qty	UOM	MOV0017A0	HOOD RING GASKET GN1110A2	0.100	PZ	VI1099A0	SELF-DRILLIN G SCREW 4.8X13 TGB+ Z	4	PZ	VM1555A2	CT BT COOLING FAN SUPPORT	1	PZ	VN1165A0	230VAC 50/60HZ COOLING DOWN FAN	1	PZ	VN1165A0	230VAC 50/60HZ COOLING DOWN FAN	1	PZ
Code	Description	Qty	UOM																										
MOV0017A0	HOOD RING GASKET GN1110A2	0.100	PZ																										
VI1099A0	SELF-DRILLIN G SCREW 4.8X13 TGB+ Z	4	PZ																										
VM1555A2	CT BT COOLING FAN SUPPORT	1	PZ																										
VN1165A0	230VAC 50/60HZ COOLING DOWN FAN	1	PZ																										
VN1165A0	230VAC 50/60HZ COOLING DOWN FAN	1	PZ																										
0H2598A			0H2598A0																										



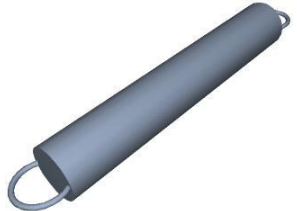

COMPONENT			SPARE PART																										
Code	Description	Image	Code	Description	Components list																								
GN1680A			GN1680A0																										
0H5260A			0H5260A1																										
VN1165A	230VAC 50/60HZ COOLING DOWN FA		KVN1165A	S.5E ADVANCE/MM 230V COOLING FAN KIT	<table border="1"> <thead> <tr> <th>Code</th> <th>Description</th> <th>Qty</th> <th>UOM</th> </tr> </thead> <tbody> <tr> <td>MOV0017A0</td> <td>HOOD RING GASKET GN1110A2</td> <td>0.100</td> <td>PZ</td> </tr> <tr> <td>VI1099A0</td> <td>SELF-DRILLIN G SCREW 4.8X13 TGB+ Z</td> <td>4</td> <td>PZ</td> </tr> <tr> <td>VM1555A2</td> <td>CT BT COOLING FAN SUPPORT</td> <td>1</td> <td>PZ</td> </tr> <tr> <td>VN1165A0</td> <td>230VAC 50/60HZ COOLING DOWN FAN</td> <td>1</td> <td>PZ</td> </tr> <tr> <td>VN1165A0</td> <td>230VAC 50/60HZ COOLING DOWN FAN</td> <td>1</td> <td>PZ</td> </tr> </tbody> </table>	Code	Description	Qty	UOM	MOV0017A0	HOOD RING GASKET GN1110A2	0.100	PZ	VI1099A0	SELF-DRILLIN G SCREW 4.8X13 TGB+ Z	4	PZ	VM1555A2	CT BT COOLING FAN SUPPORT	1	PZ	VN1165A0	230VAC 50/60HZ COOLING DOWN FAN	1	PZ	VN1165A0	230VAC 50/60HZ COOLING DOWN FAN	1	PZ
Code	Description	Qty	UOM																										
MOV0017A0	HOOD RING GASKET GN1110A2	0.100	PZ																										
VI1099A0	SELF-DRILLIN G SCREW 4.8X13 TGB+ Z	4	PZ																										
VM1555A2	CT BT COOLING FAN SUPPORT	1	PZ																										
VN1165A0	230VAC 50/60HZ COOLING DOWN FAN	1	PZ																										
VN1165A0	230VAC 50/60HZ COOLING DOWN FAN	1	PZ																										
0H2598A			0H2598A0																										

COMPONENT			SPARE PART																		
Code	Description	Image	Code	Description	Components list																
GN1680A			GN1680A0																		
0H5259A			0H5259A1																		
GN1431A			GN1431A1																		
ML1018A	L0 80 K0.32 DM 11.8 TRACTION SPRING		KML1019A	SPEED.PRO HINGE SPRINGS KIT	<table border="1"> <thead> <tr> <th>Code</th> <th>Description</th> <th>Qty</th> <th>UOM</th> </tr> </thead> <tbody> <tr> <td>ML1018B0</td> <td></td> <td>2</td> <td>PZ</td> </tr> <tr> <td>ML1019A0</td> <td>L0166 K0.38 DM21.8 TRACTION SPRING</td> <td>2</td> <td>PZ</td> </tr> <tr> <td>VM1224A0</td> <td>65MY 220MM 2 COLOURS SHRINK TUBE</td> <td>0.300</td> <td>M</td> </tr> </tbody> </table>	Code	Description	Qty	UOM	ML1018B0		2	PZ	ML1019A0	L0166 K0.38 DM21.8 TRACTION SPRING	2	PZ	VM1224A0	65MY 220MM 2 COLOURS SHRINK TUBE	0.300	M
Code	Description	Qty	UOM																		
ML1018B0		2	PZ																		
ML1019A0	L0166 K0.38 DM21.8 TRACTION SPRING	2	PZ																		
VM1224A0	65MY 220MM 2 COLOURS SHRINK TUBE	0.300	M																		
ML1019A	L0166 K0.38 DM21.8 TRACTION SPRING		KML1019A	SPEED.PRO HINGE SPRINGS KIT	<table border="1"> <thead> <tr> <th>Code</th> <th>Description</th> <th>Qty</th> <th>UOM</th> </tr> </thead> <tbody> <tr> <td>ML1018B0</td> <td></td> <td>2</td> <td>PZ</td> </tr> <tr> <td>ML1019A0</td> <td>L0166 K0.38 DM21.8 TRACTION SPRING</td> <td>2</td> <td>PZ</td> </tr> <tr> <td>VM1224A0</td> <td>65MY 220MM 2 COLOURS SHRINK TUBE</td> <td>0.300</td> <td>M</td> </tr> </tbody> </table>	Code	Description	Qty	UOM	ML1018B0		2	PZ	ML1019A0	L0166 K0.38 DM21.8 TRACTION SPRING	2	PZ	VM1224A0	65MY 220MM 2 COLOURS SHRINK TUBE	0.300	M
Code	Description	Qty	UOM																		
ML1018B0		2	PZ																		
ML1019A0	L0166 K0.38 DM21.8 TRACTION SPRING	2	PZ																		
VM1224A0	65MY 220MM 2 COLOURS SHRINK TUBE	0.300	M																		



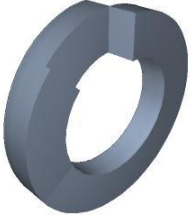







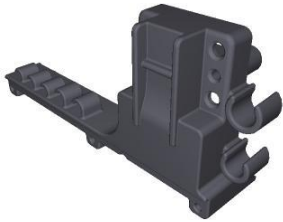

COMPONENT			SPARE PART																		
Code	Description	Image	Code	Description	Components list																
VI1136A	M5 UNI-1751 ST.STEEL SPRING WASHER		VI1136A0	M5 UNI-1751 ST.STEEL SPRING WASHER																	
VM2455A			KVM2455A	BL SP CONTR BOARD PASSAGE CABLE CLIP KIT	<table border="1"> <thead> <tr> <th>Code</th> <th>Description</th> <th>Qty</th> <th>UOM</th> </tr> </thead> <tbody> <tr> <td>VM1224A0</td> <td>65MY 220MM 2 COLOURS SHRINK TUBE</td> <td>0.150</td> <td>M</td> </tr> <tr> <td>VM2455A0</td> <td>BL SP CONTROL BOARD CABLE PASSAGE CLI</td> <td>1</td> <td>PZ</td> </tr> <tr> <td>VM2455A0</td> <td>BL SP CONTROL BOARD CABLE PASSAGE CLI</td> <td>1</td> <td>PZ</td> </tr> </tbody> </table>	Code	Description	Qty	UOM	VM1224A0	65MY 220MM 2 COLOURS SHRINK TUBE	0.150	M	VM2455A0	BL SP CONTROL BOARD CABLE PASSAGE CLI	1	PZ	VM2455A0	BL SP CONTROL BOARD CABLE PASSAGE CLI	1	PZ
Code	Description	Qty	UOM																		
VM1224A0	65MY 220MM 2 COLOURS SHRINK TUBE	0.150	M																		
VM2455A0	BL SP CONTROL BOARD CABLE PASSAGE CLI	1	PZ																		
VM2455A0	BL SP CONTROL BOARD CABLE PASSAGE CLI	1	PZ																		
0E1029A			0E1029A1																		
0H5285A			K0H5285A	SPEED.PRO FRONT AIR FILTER KIT	<table border="1"> <thead> <tr> <th>Code</th> <th>Description</th> <th>Qty</th> <th>UOM</th> </tr> </thead> <tbody> <tr> <td>0H5285A0</td> <td></td> <td>1</td> <td>PZ</td> </tr> </tbody> </table>	Code	Description	Qty	UOM	0H5285A0		1	PZ								
Code	Description	Qty	UOM																		
0H5285A0		1	PZ																		
VM1609A			KVM1609A	SPEED.PRO MOTOR ANTI VIBRATION KIT	<table border="1"> <thead> <tr> <th>Code</th> <th>Description</th> <th>Qty</th> <th>UOM</th> </tr> </thead> <tbody> <tr> <td>VI1220A1</td> <td>4,2X12 TCB SELF-TAPPIN G SCREW</td> <td>1</td> <td>PZ</td> </tr> <tr> <td>VM1120A0</td> <td>CONE-SHAPE D CAP TO CLOSE Ø30 PIPE</td> <td>1</td> <td>PZ</td> </tr> <tr> <td>VM1224A0</td> <td>65MY 220MM 2 COLOURS SHRINK TUBE</td> <td>0.200</td> <td>M</td> </tr> </tbody> </table>	Code	Description	Qty	UOM	VI1220A1	4,2X12 TCB SELF-TAPPIN G SCREW	1	PZ	VM1120A0	CONE-SHAPE D CAP TO CLOSE Ø30 PIPE	1	PZ	VM1224A0	65MY 220MM 2 COLOURS SHRINK TUBE	0.200	M
Code	Description	Qty	UOM																		
VI1220A1	4,2X12 TCB SELF-TAPPIN G SCREW	1	PZ																		
VM1120A0	CONE-SHAPE D CAP TO CLOSE Ø30 PIPE	1	PZ																		
VM1224A0	65MY 220MM 2 COLOURS SHRINK TUBE	0.200	M																		

COMPONENT			SPARE PART																																																						
Code	Description	Image	Code	Description	Components list																																																				
0F1038A			0F1038A3																																																						
VM1570A	SPEED.PRO RIGHT HINGE SET		KVM1570A		<table border="1"> <thead> <tr> <th>Code</th> <th>Description</th> <th>Qty</th> <th>UOM</th> </tr> </thead> <tbody> <tr> <td>0H2597A0</td> <td></td> <td>1</td> <td>PZ</td> </tr> <tr> <td>V1136A0</td> <td>M5 UNI-1751 ST.STEEL SPRING WASHER</td> <td>8</td> <td>PZ</td> </tr> <tr> <td>V11280A1</td> <td>SCREW M5X10 TC1/2T COMBI ZN 12</td> <td>8</td> <td>PZ</td> </tr> <tr> <td>VM1224A0</td> <td>65MY 220MM 2 COLOURS SHRINK TUBE</td> <td>0.250</td> <td>M</td> </tr> <tr> <td>VM1570A0</td> <td>SPEED.PRO RIGHT HINGE SET</td> <td>1</td> <td>PZ</td> </tr> </tbody> </table>	Code	Description	Qty	UOM	0H2597A0		1	PZ	V1136A0	M5 UNI-1751 ST.STEEL SPRING WASHER	8	PZ	V11280A1	SCREW M5X10 TC1/2T COMBI ZN 12	8	PZ	VM1224A0	65MY 220MM 2 COLOURS SHRINK TUBE	0.250	M	VM1570A0	SPEED.PRO RIGHT HINGE SET	1	PZ																												
Code	Description	Qty	UOM																																																						
0H2597A0		1	PZ																																																						
V1136A0	M5 UNI-1751 ST.STEEL SPRING WASHER	8	PZ																																																						
V11280A1	SCREW M5X10 TC1/2T COMBI ZN 12	8	PZ																																																						
VM1224A0	65MY 220MM 2 COLOURS SHRINK TUBE	0.250	M																																																						
VM1570A0	SPEED.PRO RIGHT HINGE SET	1	PZ																																																						
			KCR1131A	SPEED.PRO RIGHT HINGE KIT	<table border="1"> <thead> <tr> <th>Code</th> <th>Description</th> <th>Qty</th> <th>UOM</th> </tr> </thead> <tbody> <tr> <td>0H2574A0</td> <td></td> <td>1</td> <td>PZ</td> </tr> <tr> <td>0H2597A0</td> <td></td> <td>1</td> <td>PZ</td> </tr> <tr> <td>0H2918A0</td> <td></td> <td>1</td> <td>PZ</td> </tr> <tr> <td>0H2919A0</td> <td></td> <td>1</td> <td>PZ</td> </tr> <tr> <td>ML1018A0</td> <td>L0 80 K0.32 DM 11.8 TRACTION SPRING</td> <td>1</td> <td>PZ</td> </tr> <tr> <td>ML1019A0</td> <td>L0166 K0.38 DM21.8 TRACTION SPRING</td> <td>1</td> <td>PZ</td> </tr> <tr> <td>V11070A0</td> <td>SCREW M4X16 TSP/UNI7688 INOX</td> <td>2</td> <td>PZ</td> </tr> <tr> <td>V11074A0</td> <td>4X16 SCREW FOR PLASTIC</td> <td>3</td> <td>PZ</td> </tr> <tr> <td>V1136A0</td> <td>M5 UNI-1751 ST.STEEL SPRING WASHER</td> <td>8</td> <td>PZ</td> </tr> <tr> <td>V11280A1</td> <td>SCREW M5X10 TC1/2T COMBI ZN 12</td> <td>8</td> <td>PZ</td> </tr> <tr> <td>V11875A0</td> <td>SCREW M5X10 TC1/2T INOX</td> <td>7</td> <td>PZ</td> </tr> <tr> <td>VM1524A0</td> <td>D 24 D 8 B 8 MW HINGE BEARING</td> <td>2</td> <td>PZ</td> </tr> </tbody> </table>	Code	Description	Qty	UOM	0H2574A0		1	PZ	0H2597A0		1	PZ	0H2918A0		1	PZ	0H2919A0		1	PZ	ML1018A0	L0 80 K0.32 DM 11.8 TRACTION SPRING	1	PZ	ML1019A0	L0166 K0.38 DM21.8 TRACTION SPRING	1	PZ	V11070A0	SCREW M4X16 TSP/UNI7688 INOX	2	PZ	V11074A0	4X16 SCREW FOR PLASTIC	3	PZ	V1136A0	M5 UNI-1751 ST.STEEL SPRING WASHER	8	PZ	V11280A1	SCREW M5X10 TC1/2T COMBI ZN 12	8	PZ	V11875A0	SCREW M5X10 TC1/2T INOX	7	PZ	VM1524A0	D 24 D 8 B 8 MW HINGE BEARING	2	PZ
Code	Description	Qty	UOM																																																						
0H2574A0		1	PZ																																																						
0H2597A0		1	PZ																																																						
0H2918A0		1	PZ																																																						
0H2919A0		1	PZ																																																						
ML1018A0	L0 80 K0.32 DM 11.8 TRACTION SPRING	1	PZ																																																						
ML1019A0	L0166 K0.38 DM21.8 TRACTION SPRING	1	PZ																																																						
V11070A0	SCREW M4X16 TSP/UNI7688 INOX	2	PZ																																																						
V11074A0	4X16 SCREW FOR PLASTIC	3	PZ																																																						
V1136A0	M5 UNI-1751 ST.STEEL SPRING WASHER	8	PZ																																																						
V11280A1	SCREW M5X10 TC1/2T COMBI ZN 12	8	PZ																																																						
V11875A0	SCREW M5X10 TC1/2T INOX	7	PZ																																																						
VM1524A0	D 24 D 8 B 8 MW HINGE BEARING	2	PZ																																																						

COMPONENT			SPARE PART																																														
Code	Description	Image	Code	Description	Components list																																												
VM1570A	SPEED.PRO RIGHT HINGE SET		KCR1131A	SPEED.PRO RIGHT HINGE KIT	<table border="1"> <thead> <tr> <th>Code</th> <th>Description</th> <th>Qty</th> <th>UOM</th> </tr> </thead> <tbody> <tr> <td>VM1533A0</td> <td>SPEED.PRO DOOR FULCRUM PIN</td> <td>1</td> <td>PZ</td> </tr> <tr> <td>VM1534A0</td> <td>SPEED.PRO DOOR HOLDER BEARING PIN</td> <td>1</td> <td>PZ</td> </tr> <tr> <td>VM1570A0</td> <td>SPEED.PRO RIGHT HINGE SET</td> <td>1</td> <td>PZ</td> </tr> <tr> <td>VP1077A0</td> <td>MW HINGES BALL-BEARING CARRIER</td> <td>1</td> <td>PZ</td> </tr> </tbody> </table>	Code	Description	Qty	UOM	VM1533A0	SPEED.PRO DOOR FULCRUM PIN	1	PZ	VM1534A0	SPEED.PRO DOOR HOLDER BEARING PIN	1	PZ	VM1570A0	SPEED.PRO RIGHT HINGE SET	1	PZ	VP1077A0	MW HINGES BALL-BEARING CARRIER	1	PZ																								
					Code	Description	Qty	UOM																																									
VM1533A0	SPEED.PRO DOOR FULCRUM PIN	1	PZ																																														
VM1534A0	SPEED.PRO DOOR HOLDER BEARING PIN	1	PZ																																														
VM1570A0	SPEED.PRO RIGHT HINGE SET	1	PZ																																														
VP1077A0	MW HINGES BALL-BEARING CARRIER	1	PZ																																														
VM1571A	SPEED.PRO LEFT HINGE SET		KVM1571A	SPEED.PRO LEFT HINGE KIT	<table border="1"> <thead> <tr> <th>Code</th> <th>Description</th> <th>Qty</th> <th>UOM</th> </tr> </thead> <tbody> <tr> <td>0H2597A0</td> <td></td> <td>1</td> <td>PZ</td> </tr> <tr> <td>VI1136A0</td> <td>M5 UNI-1751 ST.STEEL SPRING WASHER</td> <td>8</td> <td>PZ</td> </tr> <tr> <td>VI1280A1</td> <td>SCREW M5X10 TC1/2T COMBI ZN 12</td> <td>8</td> <td>PZ</td> </tr> <tr> <td>VM1224A0</td> <td>65MY 220MM 2 COLOURS SHRINK TUBE</td> <td>0.250</td> <td>M</td> </tr> <tr> <td>VM1571A0</td> <td>SPEED.PRO LEFT HINGE SET</td> <td>1</td> <td>PZ</td> </tr> </tbody> </table>	Code	Description	Qty	UOM	0H2597A0		1	PZ	VI1136A0	M5 UNI-1751 ST.STEEL SPRING WASHER	8	PZ	VI1280A1	SCREW M5X10 TC1/2T COMBI ZN 12	8	PZ	VM1224A0	65MY 220MM 2 COLOURS SHRINK TUBE	0.250	M	VM1571A0	SPEED.PRO LEFT HINGE SET	1	PZ																				
					Code	Description	Qty	UOM																																									
0H2597A0		1	PZ																																														
VI1136A0	M5 UNI-1751 ST.STEEL SPRING WASHER	8	PZ																																														
VI1280A1	SCREW M5X10 TC1/2T COMBI ZN 12	8	PZ																																														
VM1224A0	65MY 220MM 2 COLOURS SHRINK TUBE	0.250	M																																														
VM1571A0	SPEED.PRO LEFT HINGE SET	1	PZ																																														
			KCR1130A	SPEED.PRO LEFT HINGE KIT	<table border="1"> <thead> <tr> <th>Code</th> <th>Description</th> <th>Qty</th> <th>UOM</th> </tr> </thead> <tbody> <tr> <td>0H2574A0</td> <td></td> <td>1</td> <td>PZ</td> </tr> <tr> <td>0H2597A0</td> <td></td> <td>1</td> <td>PZ</td> </tr> <tr> <td>0H2918A0</td> <td></td> <td>1</td> <td>PZ</td> </tr> <tr> <td>0H2919A0</td> <td></td> <td>1</td> <td>PZ</td> </tr> <tr> <td>ML1018A0</td> <td>L0 80 K0.32 DM 11.8 TRACTION SPRING</td> <td>1</td> <td>PZ</td> </tr> <tr> <td>ML1019A0</td> <td>L0166 K0.38 DM21.8 TRACTION SPRING</td> <td>1</td> <td>PZ</td> </tr> <tr> <td>VI1070A0</td> <td>SCREW M4X16 TSP/UNI7688 INOX</td> <td>2</td> <td>PZ</td> </tr> <tr> <td>VI1074A0</td> <td>4X16 SCREW FOR PLASTIC</td> <td>3</td> <td>PZ</td> </tr> <tr> <td>VI1136A0</td> <td>M5 UNI-1751 ST.STEEL SPRING WASHER</td> <td>8</td> <td>PZ</td> </tr> <tr> <td>VI1280A1</td> <td>SCREW M5X10 TC1/2T COMBI ZN 12</td> <td>8</td> <td>PZ</td> </tr> </tbody> </table>	Code	Description	Qty	UOM	0H2574A0		1	PZ	0H2597A0		1	PZ	0H2918A0		1	PZ	0H2919A0		1	PZ	ML1018A0	L0 80 K0.32 DM 11.8 TRACTION SPRING	1	PZ	ML1019A0	L0166 K0.38 DM21.8 TRACTION SPRING	1	PZ	VI1070A0	SCREW M4X16 TSP/UNI7688 INOX	2	PZ	VI1074A0	4X16 SCREW FOR PLASTIC	3	PZ	VI1136A0	M5 UNI-1751 ST.STEEL SPRING WASHER	8	PZ	VI1280A1	SCREW M5X10 TC1/2T COMBI ZN 12	8	PZ
Code	Description	Qty	UOM																																														
0H2574A0		1	PZ																																														
0H2597A0		1	PZ																																														
0H2918A0		1	PZ																																														
0H2919A0		1	PZ																																														
ML1018A0	L0 80 K0.32 DM 11.8 TRACTION SPRING	1	PZ																																														
ML1019A0	L0166 K0.38 DM21.8 TRACTION SPRING	1	PZ																																														
VI1070A0	SCREW M4X16 TSP/UNI7688 INOX	2	PZ																																														
VI1074A0	4X16 SCREW FOR PLASTIC	3	PZ																																														
VI1136A0	M5 UNI-1751 ST.STEEL SPRING WASHER	8	PZ																																														
VI1280A1	SCREW M5X10 TC1/2T COMBI ZN 12	8	PZ																																														

COMPONENT			SPARE PART																														
Code	Description	Image	Code	Description	Components list																												
VM1571A	SPEED.PRO LEFT HINGE SET		KCR1130A	SPEED.PRO LEFT HINGE KIT	<table border="1"> <thead> <tr> <th>Code</th> <th>Description</th> <th>Qty</th> <th>UOM</th> </tr> </thead> <tbody> <tr> <td>VI1875A0</td> <td>SCREW MSX10 TC1/2T INOX</td> <td>7</td> <td>PZ</td> </tr> <tr> <td>VM1524A0</td> <td>D 24 D 8 B 8 MW HINGE BEARING</td> <td>2</td> <td>PZ</td> </tr> <tr> <td>VM1533A0</td> <td>SPEED.PRO DOOR FULCRUM PIN</td> <td>1</td> <td>PZ</td> </tr> <tr> <td>VM1534A0</td> <td>SPEED.PRO DOOR HOLDER BEARING PIN</td> <td>1</td> <td>PZ</td> </tr> <tr> <td>VM1571A0</td> <td>SPEED.PRO LEFT HINGE SET</td> <td>1</td> <td>PZ</td> </tr> <tr> <td>VP1077A0</td> <td>MW HINGES BALL-BEARIN G CARRIER</td> <td>1</td> <td>PZ</td> </tr> </tbody> </table>	Code	Description	Qty	UOM	VI1875A0	SCREW MSX10 TC1/2T INOX	7	PZ	VM1524A0	D 24 D 8 B 8 MW HINGE BEARING	2	PZ	VM1533A0	SPEED.PRO DOOR FULCRUM PIN	1	PZ	VM1534A0	SPEED.PRO DOOR HOLDER BEARING PIN	1	PZ	VM1571A0	SPEED.PRO LEFT HINGE SET	1	PZ	VP1077A0	MW HINGES BALL-BEARIN G CARRIER	1	PZ
Code	Description	Qty	UOM																														
VI1875A0	SCREW MSX10 TC1/2T INOX	7	PZ																														
VM1524A0	D 24 D 8 B 8 MW HINGE BEARING	2	PZ																														
VM1533A0	SPEED.PRO DOOR FULCRUM PIN	1	PZ																														
VM1534A0	SPEED.PRO DOOR HOLDER BEARING PIN	1	PZ																														
VM1571A0	SPEED.PRO LEFT HINGE SET	1	PZ																														
VP1077A0	MW HINGES BALL-BEARIN G CARRIER	1	PZ																														
VM2484A	ELECTRICAL CONNECTION CABLE CLAMP		KVM2484A	CABLE LOCKS ELECTRICAL CONNECTION KIT	<table border="1"> <thead> <tr> <th>Code</th> <th>Description</th> <th>Qty</th> <th>UOM</th> </tr> </thead> <tbody> <tr> <td>VM1224A0</td> <td>65MY 220MM COLOURS SHRINK TUBE</td> <td>2 0.300</td> <td>M</td> </tr> <tr> <td>VM2484A0</td> <td>ELECTRICAL CONNECTION CABLE CLAMP</td> <td>1</td> <td>PZ</td> </tr> <tr> <td>VM2484A0</td> <td>ELECTRICAL CONNECTION CABLE CLAMP</td> <td>1</td> <td>PZ</td> </tr> </tbody> </table>	Code	Description	Qty	UOM	VM1224A0	65MY 220MM COLOURS SHRINK TUBE	2 0.300	M	VM2484A0	ELECTRICAL CONNECTION CABLE CLAMP	1	PZ	VM2484A0	ELECTRICAL CONNECTION CABLE CLAMP	1	PZ												
Code	Description	Qty	UOM																														
VM1224A0	65MY 220MM COLOURS SHRINK TUBE	2 0.300	M																														
VM2484A0	ELECTRICAL CONNECTION CABLE CLAMP	1	PZ																														
VM2484A0	ELECTRICAL CONNECTION CABLE CLAMP	1	PZ																														
			KVM2482A	BAKERLUX SP ELECTR COMPONENTS HOLDER KIT	<table border="1"> <thead> <tr> <th>Code</th> <th>Description</th> <th>Qty</th> <th>UOM</th> </tr> </thead> <tbody> <tr> <td>VM1224A0</td> <td>65MY 220MM COLOURS SHRINK TUBE</td> <td>2 0.300</td> <td>M</td> </tr> <tr> <td>VM2482A0</td> <td>ELECTR COMPONENT S HOLDER FRAME SHOP.PRO</td> <td>1</td> <td>PZ</td> </tr> <tr> <td>VM2482A0</td> <td>ELECTR COMPONENT S HOLDER FRAME SHOP.PRO</td> <td>1</td> <td>PZ</td> </tr> <tr> <td>VM2484A0</td> <td>ELECTRICAL CONNECTION CABLE CLAMP</td> <td>1</td> <td>PZ</td> </tr> <tr> <td>VM2484A0</td> <td>ELECTRICAL CONNECTION CABLE CLAMP</td> <td>1</td> <td>PZ</td> </tr> </tbody> </table>	Code	Description	Qty	UOM	VM1224A0	65MY 220MM COLOURS SHRINK TUBE	2 0.300	M	VM2482A0	ELECTR COMPONENT S HOLDER FRAME SHOP.PRO	1	PZ	VM2482A0	ELECTR COMPONENT S HOLDER FRAME SHOP.PRO	1	PZ	VM2484A0	ELECTRICAL CONNECTION CABLE CLAMP	1	PZ	VM2484A0	ELECTRICAL CONNECTION CABLE CLAMP	1	PZ				
Code	Description	Qty	UOM																														
VM1224A0	65MY 220MM COLOURS SHRINK TUBE	2 0.300	M																														
VM2482A0	ELECTR COMPONENT S HOLDER FRAME SHOP.PRO	1	PZ																														
VM2482A0	ELECTR COMPONENT S HOLDER FRAME SHOP.PRO	1	PZ																														
VM2484A0	ELECTRICAL CONNECTION CABLE CLAMP	1	PZ																														
VM2484A0	ELECTRICAL CONNECTION CABLE CLAMP	1	PZ																														

COMPONENT			SPARE PART																										
Code	Description	Image	Code	Description	Components list																								
VM2482A	ELECTR COMPONENTS HOLDER FRAME SHOP.PRO		KVM2482A	BAKERLUX SP ELECTR COMPONENTS HOLDER KIT	<table border="1"> <thead> <tr> <th>Code</th> <th>Description</th> <th>Qty</th> <th>UOM</th> </tr> </thead> <tbody> <tr> <td>VM1224A0</td> <td>65MY 220MM 2 COLOURS SHRINK TUBE</td> <td>0.300</td> <td>M</td> </tr> <tr> <td>VM2482A0</td> <td>ELECTR COMPONENT S HOLDER FRAME SHOP.PRO</td> <td>1</td> <td>PZ</td> </tr> <tr> <td>VM2482A0</td> <td>ELECTR COMPONENT S HOLDER FRAME SHOP.PRO</td> <td>1</td> <td>PZ</td> </tr> <tr> <td>VM2484A0</td> <td>ELECTRICAL CONNECTION CABLE CLAMP</td> <td>1</td> <td>PZ</td> </tr> <tr> <td>VM2484A0</td> <td>ELECTRICAL CONNECTION CABLE CLAMP</td> <td>1</td> <td>PZ</td> </tr> </tbody> </table>	Code	Description	Qty	UOM	VM1224A0	65MY 220MM 2 COLOURS SHRINK TUBE	0.300	M	VM2482A0	ELECTR COMPONENT S HOLDER FRAME SHOP.PRO	1	PZ	VM2482A0	ELECTR COMPONENT S HOLDER FRAME SHOP.PRO	1	PZ	VM2484A0	ELECTRICAL CONNECTION CABLE CLAMP	1	PZ	VM2484A0	ELECTRICAL CONNECTION CABLE CLAMP	1	PZ
Code	Description	Qty	UOM																										
VM1224A0	65MY 220MM 2 COLOURS SHRINK TUBE	0.300	M																										
VM2482A0	ELECTR COMPONENT S HOLDER FRAME SHOP.PRO	1	PZ																										
VM2482A0	ELECTR COMPONENT S HOLDER FRAME SHOP.PRO	1	PZ																										
VM2484A0	ELECTRICAL CONNECTION CABLE CLAMP	1	PZ																										
VM2484A0	ELECTRICAL CONNECTION CABLE CLAMP	1	PZ																										
VM2490A	460X330 SP EXT FRONT BOTTOM GASKET		KVM2490A	SP 460X330 EXT BOTTOM PANEL GASKET KIT	<table border="1"> <thead> <tr> <th>Code</th> <th>Description</th> <th>Qty</th> <th>UOM</th> </tr> </thead> <tbody> <tr> <td>VM1794A0</td> <td>250X4.8 PA66 BLACK CLAMP</td> <td>1</td> <td>PZ</td> </tr> <tr> <td>VM2103A0</td> <td>CLAMP LOCK</td> <td>1</td> <td>PZ</td> </tr> <tr> <td>VM2490A0</td> <td>460X330 SP EXT FRONT BOTTOM GASKET</td> <td>2</td> <td>PZ</td> </tr> <tr> <td>VM2490A0</td> <td>460X330 SP EXT FRONT BOTTOM GASKET</td> <td>2</td> <td>PZ</td> </tr> </tbody> </table>	Code	Description	Qty	UOM	VM1794A0	250X4.8 PA66 BLACK CLAMP	1	PZ	VM2103A0	CLAMP LOCK	1	PZ	VM2490A0	460X330 SP EXT FRONT BOTTOM GASKET	2	PZ	VM2490A0	460X330 SP EXT FRONT BOTTOM GASKET	2	PZ				
Code	Description	Qty	UOM																										
VM1794A0	250X4.8 PA66 BLACK CLAMP	1	PZ																										
VM2103A0	CLAMP LOCK	1	PZ																										
VM2490A0	460X330 SP EXT FRONT BOTTOM GASKET	2	PZ																										
VM2490A0	460X330 SP EXT FRONT BOTTOM GASKET	2	PZ																										
VM2483A	SHOP PRO COMPONENTS HOLDER COVER		KVM2483A	BL SHOP.PRO COMPONENTS HOLDER COVER KIT	<table border="1"> <thead> <tr> <th>Code</th> <th>Description</th> <th>Qty</th> <th>UOM</th> </tr> </thead> <tbody> <tr> <td>VM1224A0</td> <td>65MY 220MM 2 COLOURS SHRINK TUBE</td> <td>0.300</td> <td>M</td> </tr> <tr> <td>VM2483A0</td> <td>COMPONENT S HOLDER COVER SHOP.PRO</td> <td>1</td> <td>PZ</td> </tr> <tr> <td>VM2483A0</td> <td>COMPONENT S HOLDER COVER SHOP.PRO</td> <td>1</td> <td>PZ</td> </tr> <tr> <td>VM2483A1</td> <td>SHOP PRO COMPONENT S HOLDER COVER</td> <td>1</td> <td>PZ</td> </tr> </tbody> </table>	Code	Description	Qty	UOM	VM1224A0	65MY 220MM 2 COLOURS SHRINK TUBE	0.300	M	VM2483A0	COMPONENT S HOLDER COVER SHOP.PRO	1	PZ	VM2483A0	COMPONENT S HOLDER COVER SHOP.PRO	1	PZ	VM2483A1	SHOP PRO COMPONENT S HOLDER COVER	1	PZ				
Code	Description	Qty	UOM																										
VM1224A0	65MY 220MM 2 COLOURS SHRINK TUBE	0.300	M																										
VM2483A0	COMPONENT S HOLDER COVER SHOP.PRO	1	PZ																										
VM2483A0	COMPONENT S HOLDER COVER SHOP.PRO	1	PZ																										
VM2483A1	SHOP PRO COMPONENT S HOLDER COVER	1	PZ																										

COMPONENT			SPARE PART																														
Code	Description	Image	Code	Description	Components list																												
VM2491A	SP600 LATERAL BOTTOM PANEL GASKET		KVM2491A	SP 460X330 LAT BOTT PANEL GASKET 2PC KIT	<table border="1"> <thead> <tr> <th>Code</th> <th>Description</th> <th>Qty</th> <th>UOM</th> </tr> </thead> <tbody> <tr> <td>VM1631A0</td> <td>PLUS INNER GLASS PUSHING CAP</td> <td>4</td> <td>PZ</td> </tr> <tr> <td>VM1794A0</td> <td>250X4.8 PA66 BLACK CLAMP</td> <td>1</td> <td>PZ</td> </tr> <tr> <td>VM2103A0</td> <td>CLAMP LOCK</td> <td>1</td> <td>PZ</td> </tr> <tr> <td>VM2491A0</td> <td>460X330 BL SP LATER BOTTOM PANEL GASKE</td> <td>2</td> <td>PZ</td> </tr> <tr> <td>VM2491A0</td> <td>460X330 BL SP LATER BOTTOM PANEL GASKE</td> <td>2</td> <td>PZ</td> </tr> <tr> <td>VM2491A1</td> <td>SP600 LATERAL BOTTOM PANEL GASKE</td> <td>2</td> <td>PZ</td> </tr> </tbody> </table>	Code	Description	Qty	UOM	VM1631A0	PLUS INNER GLASS PUSHING CAP	4	PZ	VM1794A0	250X4.8 PA66 BLACK CLAMP	1	PZ	VM2103A0	CLAMP LOCK	1	PZ	VM2491A0	460X330 BL SP LATER BOTTOM PANEL GASKE	2	PZ	VM2491A0	460X330 BL SP LATER BOTTOM PANEL GASKE	2	PZ	VM2491A1	SP600 LATERAL BOTTOM PANEL GASKE	2	PZ
Code	Description	Qty	UOM																														
VM1631A0	PLUS INNER GLASS PUSHING CAP	4	PZ																														
VM1794A0	250X4.8 PA66 BLACK CLAMP	1	PZ																														
VM2103A0	CLAMP LOCK	1	PZ																														
VM2491A0	460X330 BL SP LATER BOTTOM PANEL GASKE	2	PZ																														
VM2491A0	460X330 BL SP LATER BOTTOM PANEL GASKE	2	PZ																														
VM2491A1	SP600 LATERAL BOTTOM PANEL GASKE	2	PZ																														
VP1029A			KVP1029A		<table border="1"> <thead> <tr> <th>Code</th> <th>Description</th> <th>Qty</th> <th>UOM</th> </tr> </thead> <tbody> <tr> <td>VM1224A0</td> <td>65MY 220MM 2 COLOURS SHRINK TUBE</td> <td>0.200</td> <td>M</td> </tr> <tr> <td>VP1029A0</td> <td></td> <td>2</td> <td>PZ</td> </tr> </tbody> </table>	Code	Description	Qty	UOM	VM1224A0	65MY 220MM 2 COLOURS SHRINK TUBE	0.200	M	VP1029A0		2	PZ																
Code	Description	Qty	UOM																														
VM1224A0	65MY 220MM 2 COLOURS SHRINK TUBE	0.200	M																														
VP1029A0		2	PZ																														
VP1074A			VP1074A0																														

**ASM3244A/0.D01 - Electrical system**

**FRONT**

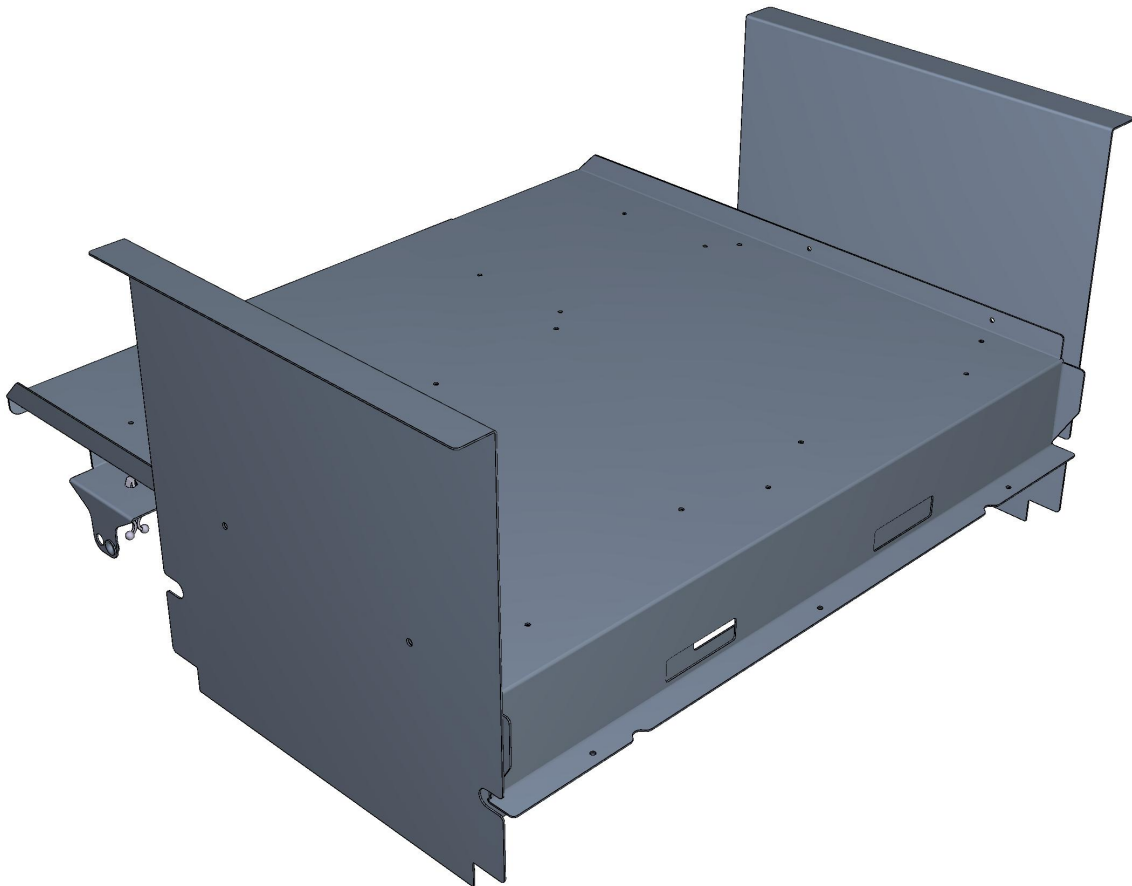



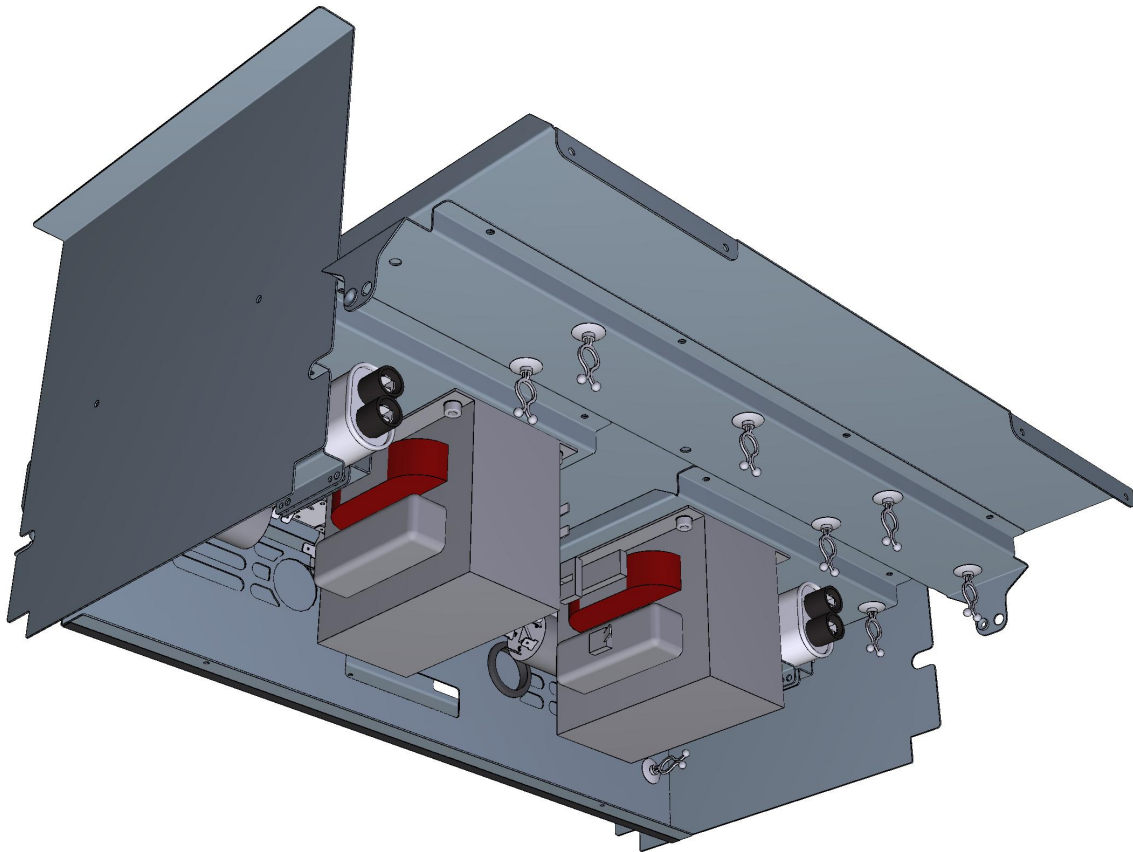

**ASM3244A/0.D01 - Electrical system**



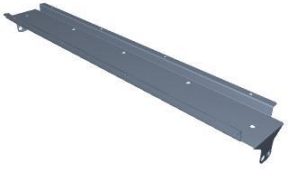

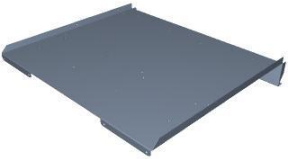
**REAR**





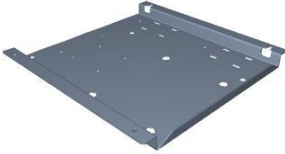
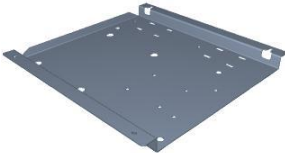

COMPONENT			SPARE PART		
Code	Description	Image	Code	Description	Components list
0H2828A			0H2828A0		
0H5287A			0H5287A0		
GN1681A			GN1681A0		
0H5261B			0H5261B0		
0H5275B			0H5275B0		

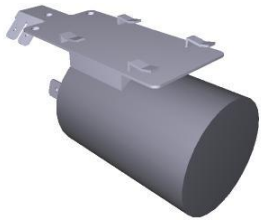

COMPONENT			SPARE PART										
Code	Description	Image	Code	Description	Components list								
VI1113A	ST.STEEL TCEI M6X12 SCREW		VI1113A0	ST.STEEL TCEI M6X12 SCREW									
0H5276A			0H5276A1										
0H5281A			0H5281A0										
0H5282A			0H5282A0										
VE1810A			KVE1810A	SPEED.PRO HV DIODE KIT	<table border="1"> <thead> <tr> <th>Code</th> <th>Description</th> <th>Qty</th> <th>UOM</th> </tr> </thead> <tbody> <tr> <td>VE1810A0</td> <td></td> <td>1</td> <td>PZ</td> </tr> </tbody> </table>	Code	Description	Qty	UOM	VE1810A0		1	PZ
Code	Description	Qty	UOM										
VE1810A0		1	PZ										

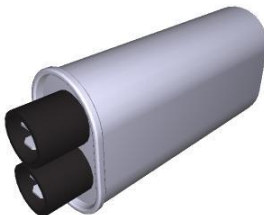
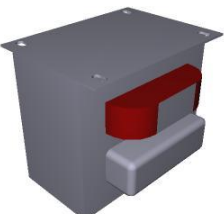
COMPONENT			SPARE PART										
Code	Description	Image	Code	Description	Components list								
VE1816A			KVE1816A	SPEED.PRO 16AMP EMI FILTER KIT	<table border="1"> <thead> <tr> <th>Code</th> <th>Description</th> <th>Qty</th> <th>UOM</th> </tr> </thead> <tbody> <tr> <td>VE1816A0</td> <td></td> <td>1</td> <td>PZ</td> </tr> </tbody> </table>	Code	Description	Qty	UOM	VE1816A0		1	PZ
Code	Description	Qty	UOM										
VE1816A0		1	PZ										
VI0502A			VI0502A1										
CN1015A			KCN1015A	HV 2500V 0.85UF MW CONDENSER KI	<table border="1"> <thead> <tr> <th>Code</th> <th>Description</th> <th>Qty</th> <th>UOM</th> </tr> </thead> <tbody> <tr> <td>CN1015A0</td> <td></td> <td>1</td> <td>PZ</td> </tr> </tbody> </table>	Code	Description	Qty	UOM	CN1015A0		1	PZ
Code	Description	Qty	UOM										
CN1015A0		1	PZ										
VE1805A	TRANSFORMER HV 230/2295/3.15V 1000VA		KVE1805A	SPEED.PRO 1000VA HV TRANSFORMER KIT	<table border="1"> <thead> <tr> <th>Code</th> <th>Description</th> <th>Qty</th> <th>UOM</th> </tr> </thead> <tbody> <tr> <td>VE1805A0</td> <td>TRANSFORME R HV 230/2295/3.15V 1000VA</td> <td>1</td> <td>PZ</td> </tr> </tbody> </table>	Code	Description	Qty	UOM	VE1805A0	TRANSFORME R HV 230/2295/3.15V 1000VA	1	PZ
Code	Description	Qty	UOM										
VE1805A0	TRANSFORME R HV 230/2295/3.15V 1000VA	1	PZ										