

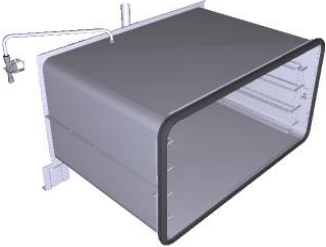

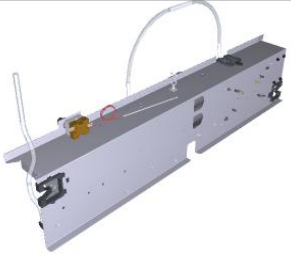

Assembly code	Assembly revision	Assembly image
ASM3404A/0.D00	Cooking chamber	
ASM3440A/0.D00	Electrical system	
ASM3431A/0.D00	Door	
ASM3416A/0.D01	External cover	

ASM3404A/0.D00 - Cooking chamber

FRONT

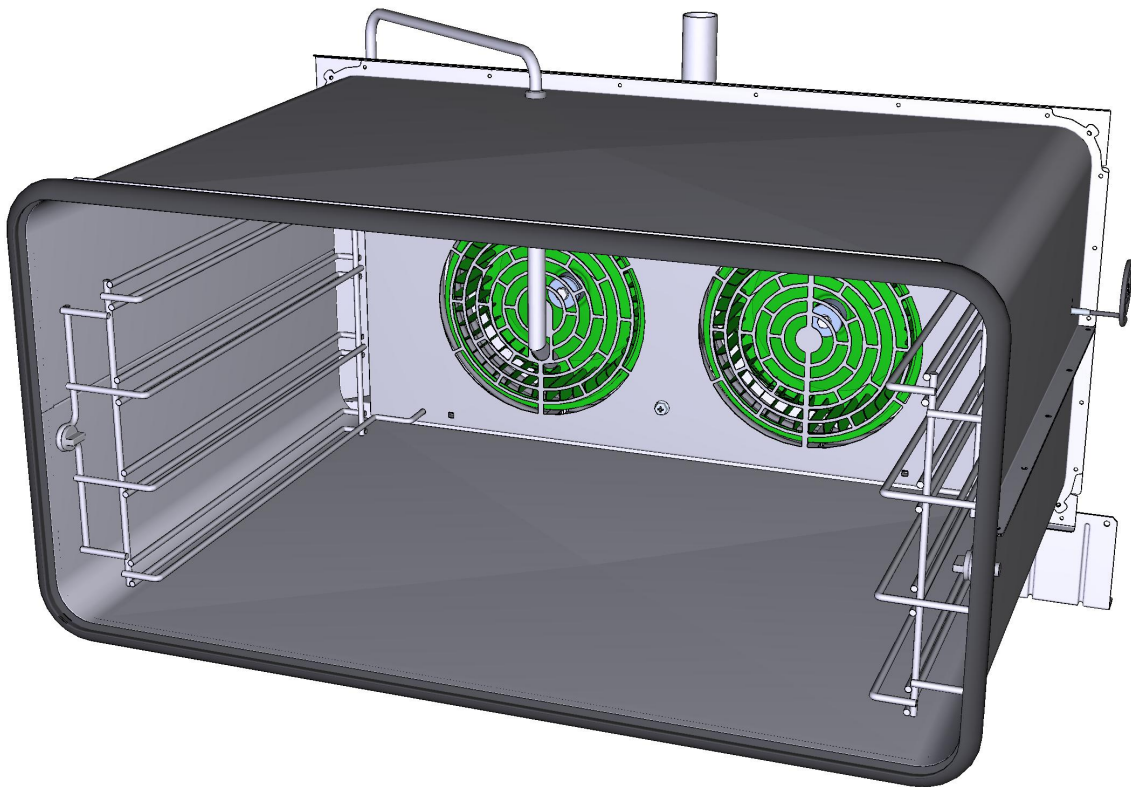



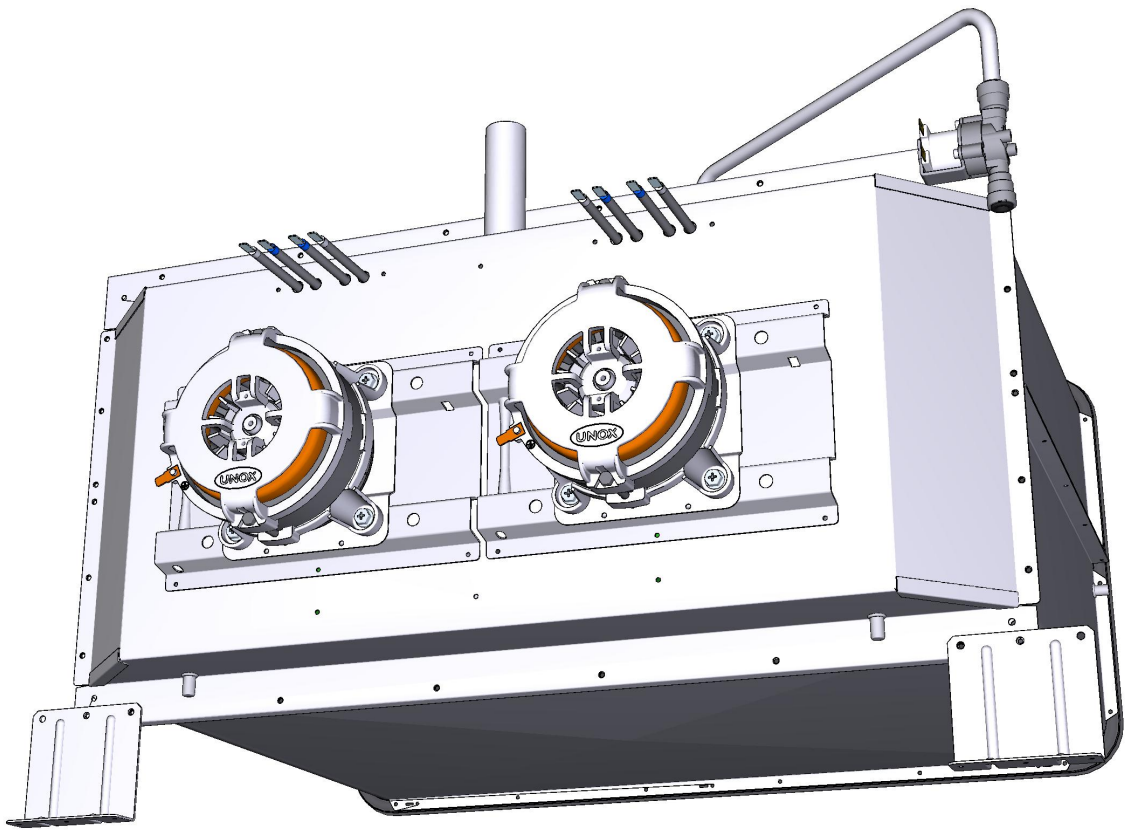

ASM3404A/0.D00 - Cooking chamber

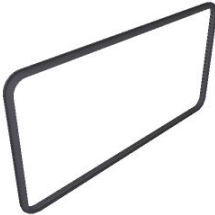
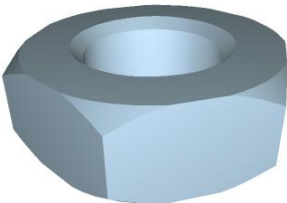

REAR





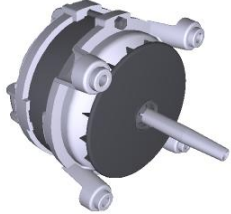

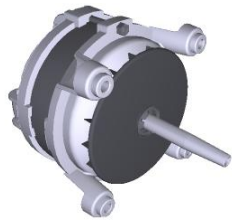



COMPONENT			SPARE PART																																														
Code	Description	Image	Code	Description	Components list																																												
TR1105A	L1000 PT100 TEMPERATURE PROBE		KTR1105A	PT100 L1000 TEMPERATURE PROBE KIT	<table border="1"> <thead> <tr> <th>Code</th> <th>Description</th> <th>Qty</th> <th>UOM</th> </tr> </thead> <tbody> <tr> <td>GN1120A0</td> <td>NTC TEMPERATUR E PROBE SEAL</td> <td>1</td> <td>PZ</td> </tr> <tr> <td>GN1120A1</td> <td>NTC TEMPERATUR E PROBE SEAL</td> <td>1</td> <td>PZ</td> </tr> <tr> <td>GN1285A0</td> <td>NTC TEMPERATUR E PROBE SEALING</td> <td>1</td> <td>PZ</td> </tr> <tr> <td>MOV0010A0</td> <td>HOOD RING GASKET GN1110A2</td> <td>0.100</td> <td>PZ</td> </tr> <tr> <td>SL1045A0</td> <td>S57 BLACK SILICONE - 80ML CARTRIDGE</td> <td>1</td> <td>PZ</td> </tr> <tr> <td>TR1105A4</td> <td>L1000 PT100 TEMPERATUR E PROBE</td> <td>1</td> <td>PZ</td> </tr> <tr> <td>VI1220A1</td> <td>4,2X12 TCB SELF-TAPPIN G SCREW</td> <td>2</td> <td>PZ</td> </tr> <tr> <td>VM1464A1</td> <td>CT BT TEMPERATUR E PROBE COVER</td> <td>1</td> <td>PZ</td> </tr> <tr> <td>VM1465A1</td> <td>CT BT TEMPERATUR E PROBE COVER</td> <td>1</td> <td>PZ</td> </tr> <tr> <td>VM2052A0</td> <td>LM CORE PROBE COVE</td> <td>1</td> <td>PZ</td> </tr> </tbody> </table>	Code	Description	Qty	UOM	GN1120A0	NTC TEMPERATUR E PROBE SEAL	1	PZ	GN1120A1	NTC TEMPERATUR E PROBE SEAL	1	PZ	GN1285A0	NTC TEMPERATUR E PROBE SEALING	1	PZ	MOV0010A0	HOOD RING GASKET GN1110A2	0.100	PZ	SL1045A0	S57 BLACK SILICONE - 80ML CARTRIDGE	1	PZ	TR1105A4	L1000 PT100 TEMPERATUR E PROBE	1	PZ	VI1220A1	4,2X12 TCB SELF-TAPPIN G SCREW	2	PZ	VM1464A1	CT BT TEMPERATUR E PROBE COVER	1	PZ	VM1465A1	CT BT TEMPERATUR E PROBE COVER	1	PZ	VM2052A0	LM CORE PROBE COVE	1	PZ
Code	Description	Qty	UOM																																														
GN1120A0	NTC TEMPERATUR E PROBE SEAL	1	PZ																																														
GN1120A1	NTC TEMPERATUR E PROBE SEAL	1	PZ																																														
GN1285A0	NTC TEMPERATUR E PROBE SEALING	1	PZ																																														
MOV0010A0	HOOD RING GASKET GN1110A2	0.100	PZ																																														
SL1045A0	S57 BLACK SILICONE - 80ML CARTRIDGE	1	PZ																																														
TR1105A4	L1000 PT100 TEMPERATUR E PROBE	1	PZ																																														
VI1220A1	4,2X12 TCB SELF-TAPPIN G SCREW	2	PZ																																														
VM1464A1	CT BT TEMPERATUR E PROBE COVER	1	PZ																																														
VM1465A1	CT BT TEMPERATUR E PROBE COVER	1	PZ																																														
VM2052A0	LM CORE PROBE COVE	1	PZ																																														
GN1354A	LINEMISS ROSSELLA DOOR GASKET - GN1110A		KGN1354A	LM ROSSELLA DOOR GASKET KIT	<table border="1"> <thead> <tr> <th>Code</th> <th>Description</th> <th>Qty</th> <th>UOM</th> </tr> </thead> <tbody> <tr> <td>GN1110A2</td> <td>LINE MISS/XVC105- 055/XK/XL DOOR GASKE</td> <td>2.020</td> <td>M</td> </tr> <tr> <td>VM1224A0</td> <td>65MY 220MM 2 COLOURS SHRINK TUBE</td> <td>0.350</td> <td>M</td> </tr> </tbody> </table>	Code	Description	Qty	UOM	GN1110A2	LINE MISS/XVC105- 055/XK/XL DOOR GASKE	2.020	M	VM1224A0	65MY 220MM 2 COLOURS SHRINK TUBE	0.350	M																																
Code	Description	Qty	UOM																																														
GN1110A2	LINE MISS/XVC105- 055/XK/XL DOOR GASKE	2.020	M																																														
VM1224A0	65MY 220MM 2 COLOURS SHRINK TUBE	0.350	M																																														
RC1170A	STAINLESS STEEL NUT M14 H=8 CH=22		KRC1170A	M14 H8 CH22 NUT - 10 PCS. KIT	<table border="1"> <thead> <tr> <th>Code</th> <th>Description</th> <th>Qty</th> <th>UOM</th> </tr> </thead> <tbody> <tr> <td>RC1170A1</td> <td>STAINLESS STEEL NUT M14 H=8 CH=2</td> <td>10</td> <td>PZ</td> </tr> <tr> <td>VM1224A0</td> <td>65MY 220MM 2 COLOURS SHRINK TUBE</td> <td>0.200</td> <td>M</td> </tr> </tbody> </table>	Code	Description	Qty	UOM	RC1170A1	STAINLESS STEEL NUT M14 H=8 CH=2	10	PZ	VM1224A0	65MY 220MM 2 COLOURS SHRINK TUBE	0.200	M																																
Code	Description	Qty	UOM																																														
RC1170A1	STAINLESS STEEL NUT M14 H=8 CH=2	10	PZ																																														
VM1224A0	65MY 220MM 2 COLOURS SHRINK TUBE	0.200	M																																														

COMPONENT			SPARE PART														
Code	Description	Image	Code	Description	Components list												
VM2331A	FAN GUARD-TRAYS HOLDER PIN		KVM2331A	KIT FAN GUARD-TRAYS HOLDER PIN	<table border="1"> <thead> <tr> <th>Code</th> <th>Description</th> <th>Qty</th> <th>UOM</th> </tr> </thead> <tbody> <tr> <td>VM1224A0</td> <td>65MY 220MM 2 COLOURS SHRINK TUBE</td> <td>0.200</td> <td>M</td> </tr> <tr> <td>VM2331A0</td> <td>FAN GUARD-TRAY S HOLDER PIN</td> <td>4</td> <td>PZ</td> </tr> </tbody> </table>	Code	Description	Qty	UOM	VM1224A0	65MY 220MM 2 COLOURS SHRINK TUBE	0.200	M	VM2331A0	FAN GUARD-TRAY S HOLDER PIN	4	PZ
Code	Description	Qty	UOM														
VM1224A0	65MY 220MM 2 COLOURS SHRINK TUBE	0.200	M														
VM2331A0	FAN GUARD-TRAY S HOLDER PIN	4	PZ														
0H7875A	MUFFLE SUPPORT BRACKET SHOP.PR		0H7875A0	MUFFLE SUPPORT BRACKET SHOP.PR													
EL1251A	1-WAY WATER SOLENOID VALVE		KEL1251A	JG D8-D10 1 WAY SOLENOID VALVE KI	<table border="1"> <thead> <tr> <th>Code</th> <th>Description</th> <th>Qty</th> <th>UOM</th> </tr> </thead> <tbody> <tr> <td>EL1251A0</td> <td>1-WAY WATER SOLENOID VALVE</td> <td>1</td> <td>PZ</td> </tr> <tr> <td>VM1224A0</td> <td>65MY 220MM 2 COLOURS SHRINK TUBE</td> <td>0.250</td> <td>M</td> </tr> </tbody> </table>	Code	Description	Qty	UOM	EL1251A0	1-WAY WATER SOLENOID VALVE	1	PZ	VM1224A0	65MY 220MM 2 COLOURS SHRINK TUBE	0.250	M
Code	Description	Qty	UOM														
EL1251A0	1-WAY WATER SOLENOID VALVE	1	PZ														
VM1224A0	65MY 220MM 2 COLOURS SHRINK TUBE	0.250	M														
TB1568A	ARI-STE-ROS SP WELDED EXT HUMIDITY PIPE		TB1568A0	ARI-STE-ROS SP WELDED EXT HUMIDITY PIPE													
0G1658A	ROSSELLA SHOP PRO FAN GUARD PARTITION		0G1658A0	ROSSELLA SHOP PRO FAN GUARD PARTITION													

COMPONENT			SPARE PART																																														
Code	Description	Image	Code	Description	Components list																																												
0H3020A	MOTOR SHAFT SEALING DISC		0H3020A1	MOTOR SHAFT SEALING DISC																																													
MT1012A	330W 230V MOTOR		KVN1130A	LUX =08.2017/S.5/S.5E 330W MOTOR KIT	<table border="1"> <thead> <tr> <th>Code</th> <th>Description</th> <th>Qty</th> <th>UOM</th> </tr> </thead> <tbody> <tr> <td>0H4305A1</td> <td>ST. STEEL MOTOR SHAFT SEALING DISC</td> <td>1</td> <td>PZ</td> </tr> <tr> <td>GN1140A2</td> <td>MOTOR HOLDER GASKET</td> <td>1</td> <td>PZ</td> </tr> <tr> <td>GN1140A3</td> <td>MOLDED MOTOR HOLDER GASKET</td> <td>1</td> <td>PZ</td> </tr> <tr> <td>VI1045A0</td> <td>16X8,4 TH=1,6 ST. STEEL WASHER</td> <td>1</td> <td>PZ</td> </tr> <tr> <td>VI1256A0</td> <td>M8 DIN 980M ST. STEEL SELF LOCKING NUT</td> <td>1</td> <td>PZ</td> </tr> <tr> <td>VM1794A0</td> <td>250X4,8 PA66 BLACK CLAMP</td> <td>4</td> <td>PZ</td> </tr> <tr> <td>VM2103A0</td> <td>CLAMP LOCK</td> <td>4</td> <td>PZ</td> </tr> <tr> <td>VM2196A0</td> <td>MOTOR NUT FASTENING BUSHING</td> <td>1</td> <td>PZ</td> </tr> <tr> <td>VN1130A1</td> <td>330W 230V 50/60HZ MOTO</td> <td>1</td> <td>PZ</td> </tr> <tr> <td>VN1130A1</td> <td>330W 230V 50/60HZ MOTO</td> <td>1</td> <td>PZ</td> </tr> </tbody> </table>	Code	Description	Qty	UOM	0H4305A1	ST. STEEL MOTOR SHAFT SEALING DISC	1	PZ	GN1140A2	MOTOR HOLDER GASKET	1	PZ	GN1140A3	MOLDED MOTOR HOLDER GASKET	1	PZ	VI1045A0	16X8,4 TH=1,6 ST. STEEL WASHER	1	PZ	VI1256A0	M8 DIN 980M ST. STEEL SELF LOCKING NUT	1	PZ	VM1794A0	250X4,8 PA66 BLACK CLAMP	4	PZ	VM2103A0	CLAMP LOCK	4	PZ	VM2196A0	MOTOR NUT FASTENING BUSHING	1	PZ	VN1130A1	330W 230V 50/60HZ MOTO	1	PZ	VN1130A1	330W 230V 50/60HZ MOTO	1	PZ
Code	Description	Qty	UOM																																														
0H4305A1	ST. STEEL MOTOR SHAFT SEALING DISC	1	PZ																																														
GN1140A2	MOTOR HOLDER GASKET	1	PZ																																														
GN1140A3	MOLDED MOTOR HOLDER GASKET	1	PZ																																														
VI1045A0	16X8,4 TH=1,6 ST. STEEL WASHER	1	PZ																																														
VI1256A0	M8 DIN 980M ST. STEEL SELF LOCKING NUT	1	PZ																																														
VM1794A0	250X4,8 PA66 BLACK CLAMP	4	PZ																																														
VM2103A0	CLAMP LOCK	4	PZ																																														
VM2196A0	MOTOR NUT FASTENING BUSHING	1	PZ																																														
VN1130A1	330W 230V 50/60HZ MOTO	1	PZ																																														
VN1130A1	330W 230V 50/60HZ MOTO	1	PZ																																														
			KMT1012A	MIND.MAPS 330W 230V MOTOR KIT	<table border="1"> <thead> <tr> <th>Code</th> <th>Description</th> <th>Qty</th> <th>UOM</th> </tr> </thead> <tbody> <tr> <td>0H2842A0</td> <td></td> <td>1</td> <td>PZ</td> </tr> <tr> <td>0H4305A1</td> <td>ST. STEEL MOTOR SHAFT SEALING DISC</td> <td>1</td> <td>PZ</td> </tr> <tr> <td>GN1140A2</td> <td>MOTOR HOLDER GASKET</td> <td>1</td> <td>PZ</td> </tr> <tr> <td>GN1140A3</td> <td>MOLDED MOTOR HOLDER GASKET</td> <td>1</td> <td>PZ</td> </tr> <tr> <td>MOV0007A0</td> <td>HOOD RING GASKET GN1110A2</td> <td>0.100</td> <td>PZ</td> </tr> </tbody> </table>	Code	Description	Qty	UOM	0H2842A0		1	PZ	0H4305A1	ST. STEEL MOTOR SHAFT SEALING DISC	1	PZ	GN1140A2	MOTOR HOLDER GASKET	1	PZ	GN1140A3	MOLDED MOTOR HOLDER GASKET	1	PZ	MOV0007A0	HOOD RING GASKET GN1110A2	0.100	PZ																				
Code	Description	Qty	UOM																																														
0H2842A0		1	PZ																																														
0H4305A1	ST. STEEL MOTOR SHAFT SEALING DISC	1	PZ																																														
GN1140A2	MOTOR HOLDER GASKET	1	PZ																																														
GN1140A3	MOLDED MOTOR HOLDER GASKET	1	PZ																																														
MOV0007A0	HOOD RING GASKET GN1110A2	0.100	PZ																																														

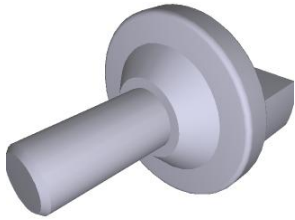
COMPONENT			SPARE PART																																						
Code	Description	Image	Code	Description	Components list																																				
MT1012A	330W 230V MOTOR		KMT1012A	MIND.MAPS 330W 230V MOTOR KIT	<table border="1"> <thead> <tr> <th>Code</th> <th>Description</th> <th>Qty</th> <th>UOM</th> </tr> </thead> <tbody> <tr> <td>MT1012A0</td> <td>330W 230V MOTOR</td> <td>1</td> <td>PZ</td> </tr> <tr> <td>VE1550A0</td> <td>5X3 MM NEODYMIUM MAGNET</td> <td>1</td> <td>PZ</td> </tr> <tr> <td>VI1077A1</td> <td>SCREW M6X12 TE INOX</td> <td>1</td> <td>PZ</td> </tr> <tr> <td>VI1521A0</td> <td>STAINLESS STEEL WASHER D=6 6592</td> <td>1</td> <td>PZ</td> </tr> <tr> <td>VI1966A0</td> <td>M4X14 FLATHEAD SCREW</td> <td>1</td> <td>PZ</td> </tr> <tr> <td>VM1635A0</td> <td>MAGNET HOLDING DIS</td> <td>1</td> <td>PZ</td> </tr> <tr> <td>VM1794A0</td> <td>250X4.8 PA66 BLACK CLAMP</td> <td>4</td> <td>PZ</td> </tr> <tr> <td>VM2103A0</td> <td>CLAMP LOCK</td> <td>4</td> <td>PZ</td> </tr> </tbody> </table>	Code	Description	Qty	UOM	MT1012A0	330W 230V MOTOR	1	PZ	VE1550A0	5X3 MM NEODYMIUM MAGNET	1	PZ	VI1077A1	SCREW M6X12 TE INOX	1	PZ	VI1521A0	STAINLESS STEEL WASHER D=6 6592	1	PZ	VI1966A0	M4X14 FLATHEAD SCREW	1	PZ	VM1635A0	MAGNET HOLDING DIS	1	PZ	VM1794A0	250X4.8 PA66 BLACK CLAMP	4	PZ	VM2103A0	CLAMP LOCK	4	PZ
					Code	Description	Qty	UOM																																	
					MT1012A0	330W 230V MOTOR	1	PZ																																	
					VE1550A0	5X3 MM NEODYMIUM MAGNET	1	PZ																																	
					VI1077A1	SCREW M6X12 TE INOX	1	PZ																																	
					VI1521A0	STAINLESS STEEL WASHER D=6 6592	1	PZ																																	
					VI1966A0	M4X14 FLATHEAD SCREW	1	PZ																																	
					VM1635A0	MAGNET HOLDING DIS	1	PZ																																	
					VM1794A0	250X4.8 PA66 BLACK CLAMP	4	PZ																																	
					VM2103A0	CLAMP LOCK	4	PZ																																	
GN1547A	SHAFT GASKET D11.8		KGN1547A	D11.6 MOTOR SHAFT GASKET 3PCS KIT	<table border="1"> <thead> <tr> <th>Code</th> <th>Description</th> <th>Qty</th> <th>UOM</th> </tr> </thead> <tbody> <tr> <td>GN1547A1</td> <td>SHAFT GASKET D11.8</td> <td>3</td> <td>PZ</td> </tr> <tr> <td>VM1224A0</td> <td>65MY 220MM 2 COLOURS SHRINK TUBE</td> <td>0.200</td> <td>M</td> </tr> </tbody> </table>	Code	Description	Qty	UOM	GN1547A1	SHAFT GASKET D11.8	3	PZ	VM1224A0	65MY 220MM 2 COLOURS SHRINK TUBE	0.200	M																								
					Code	Description	Qty	UOM																																	
GN1547A1	SHAFT GASKET D11.8	3	PZ																																						
VM1224A0	65MY 220MM 2 COLOURS SHRINK TUBE	0.200	M																																						
VN1181A	M6 NUT 39 BLADES H81 D196 FAN		KVN1181A	D196 H81 39 BLADES FAN+SCREW M6 KIT	<table border="1"> <thead> <tr> <th>Code</th> <th>Description</th> <th>Qty</th> <th>UOM</th> </tr> </thead> <tbody> <tr> <td>VI1077A1</td> <td>SCREW M6X12 TE INOX</td> <td>1</td> <td>PZ</td> </tr> <tr> <td>VI1521A0</td> <td>STAINLESS STEEL WASHER D=6 6592</td> <td>1</td> <td>PZ</td> </tr> <tr> <td>VN1181A0</td> <td>M6 NUT 39 BLADES H81 D196 FAN</td> <td>1</td> <td>PZ</td> </tr> </tbody> </table>	Code	Description	Qty	UOM	VI1077A1	SCREW M6X12 TE INOX	1	PZ	VI1521A0	STAINLESS STEEL WASHER D=6 6592	1	PZ	VN1181A0	M6 NUT 39 BLADES H81 D196 FAN	1	PZ																				
					Code	Description	Qty	UOM																																	
					VI1077A1	SCREW M6X12 TE INOX	1	PZ																																	
					VI1521A0	STAINLESS STEEL WASHER D=6 6592	1	PZ																																	
			VN1181A0	M6 NUT 39 BLADES H81 D196 FAN	1	PZ																																			
			KVN1030A	LUX =08.2017S.5/S.5E D196 FAN KIT	<table border="1"> <thead> <tr> <th>Code</th> <th>Description</th> <th>Qty</th> <th>UOM</th> </tr> </thead> <tbody> <tr> <td>VN1181A0</td> <td>M6 NUT 39 BLADES H81 D196 FAN</td> <td>1</td> <td>PZ</td> </tr> <tr> <td>VI1256A0</td> <td>M8 DIN 980M ST. STEEL SELF LOCKING NUT</td> <td>1</td> <td>PZ</td> </tr> <tr> <td>VM2196A0</td> <td>MOTOR NUT FASTENING BUSHING</td> <td>1</td> <td>PZ</td> </tr> </tbody> </table>	Code	Description	Qty	UOM	VN1181A0	M6 NUT 39 BLADES H81 D196 FAN	1	PZ	VI1256A0	M8 DIN 980M ST. STEEL SELF LOCKING NUT	1	PZ	VM2196A0	MOTOR NUT FASTENING BUSHING	1	PZ																				
					Code	Description	Qty	UOM																																	
					VN1181A0	M6 NUT 39 BLADES H81 D196 FAN	1	PZ																																	
VI1256A0	M8 DIN 980M ST. STEEL SELF LOCKING NUT	1			PZ																																				
VM2196A0	MOTOR NUT FASTENING BUSHING	1	PZ																																						

COMPONENT			SPARE PART																														
Code	Description	Image	Code	Description	Components list																												
VN1181A	M6 NUT 39 BLADES H81 D196 FAN		KVN1030A	LUX =08.2017S.5/S.5E D196 FAN KIT	<table border="1"> <thead> <tr> <th>Code</th> <th>Description</th> <th>Qty</th> <th>UOM</th> </tr> </thead> <tbody> <tr> <td>VN1030A5</td> <td>Ø196 H81 38 BLADES MOTOR FAN</td> <td>1</td> <td>PZ</td> </tr> <tr> <td>VN1030A5</td> <td>Ø196 H81 38 BLADES MOTOR FAN</td> <td>1</td> <td>PZ</td> </tr> </tbody> </table>	Code	Description	Qty	UOM	VN1030A5	Ø196 H81 38 BLADES MOTOR FAN	1	PZ	VN1030A5	Ø196 H81 38 BLADES MOTOR FAN	1	PZ																
Code	Description	Qty	UOM																														
VN1030A5	Ø196 H81 38 BLADES MOTOR FAN	1	PZ																														
VN1030A5	Ø196 H81 38 BLADES MOTOR FAN	1	PZ																														
0H7170A	MM MOTOR GLASS WOOL PLATE		0H7170A0	MM MOTOR GLASS WOOL PLATE																													
RS1284A	3200W 230V+400W 190V 4TURNS H80 ELEMENT		KRS1284A	4TURN 3200W 230V+400W 190V HEAT ELEM KIT	<table border="1"> <thead> <tr> <th>Code</th> <th>Description</th> <th>Qty</th> <th>UOM</th> </tr> </thead> <tbody> <tr> <td>GN1327A0</td> <td>HEATING ELEMENT GASKET</td> <td>1</td> <td>PZ</td> </tr> <tr> <td>RS1284A0</td> <td>3200W 230V+400W 190V 4TURNS H80 ELEMENT</td> <td>1</td> <td>PZ</td> </tr> <tr> <td>SL1045A0</td> <td>S57 BLACK SILICONE - 80ML CARTRIDGE</td> <td>1</td> <td>PZ</td> </tr> <tr> <td>VI1220A1</td> <td>4,2X12 TCB SELF-TAPPIN G SCREW</td> <td>1</td> <td>PZ</td> </tr> <tr> <td>VM1794A0</td> <td>250X4.8 PA66 BLACK CLAMP</td> <td>2</td> <td>PZ</td> </tr> <tr> <td>VM2103A0</td> <td>CLAMP LOCK</td> <td>2</td> <td>PZ</td> </tr> </tbody> </table>	Code	Description	Qty	UOM	GN1327A0	HEATING ELEMENT GASKET	1	PZ	RS1284A0	3200W 230V+400W 190V 4TURNS H80 ELEMENT	1	PZ	SL1045A0	S57 BLACK SILICONE - 80ML CARTRIDGE	1	PZ	VI1220A1	4,2X12 TCB SELF-TAPPIN G SCREW	1	PZ	VM1794A0	250X4.8 PA66 BLACK CLAMP	2	PZ	VM2103A0	CLAMP LOCK	2	PZ
Code	Description	Qty	UOM																														
GN1327A0	HEATING ELEMENT GASKET	1	PZ																														
RS1284A0	3200W 230V+400W 190V 4TURNS H80 ELEMENT	1	PZ																														
SL1045A0	S57 BLACK SILICONE - 80ML CARTRIDGE	1	PZ																														
VI1220A1	4,2X12 TCB SELF-TAPPIN G SCREW	1	PZ																														
VM1794A0	250X4.8 PA66 BLACK CLAMP	2	PZ																														
VM2103A0	CLAMP LOCK	2	PZ																														
GRL1025A	RIGHT/LEFT LAT.GRID CHROMIUM-PLATED		KGRL1025A	LM ROSSELLA 4X60X40 LAT. SUPPORT KIT	<table border="1"> <thead> <tr> <th>Code</th> <th>Description</th> <th>Qty</th> <th>UOM</th> </tr> </thead> <tbody> <tr> <td>GRL1025A1</td> <td>RIGHT/LEFT LAT.GRID CHROMIUM-P LATED</td> <td>2</td> <td>PZ</td> </tr> <tr> <td>IP1508A1</td> <td>POLYSTYREN E U SHAPED PROFILE 2000X60X60</td> <td>2</td> <td>M</td> </tr> <tr> <td>VM1059A1</td> <td>HEAT SHRINK FILM H800</td> <td>1.500</td> <td>M</td> </tr> </tbody> </table>	Code	Description	Qty	UOM	GRL1025A1	RIGHT/LEFT LAT.GRID CHROMIUM-P LATED	2	PZ	IP1508A1	POLYSTYREN E U SHAPED PROFILE 2000X60X60	2	M	VM1059A1	HEAT SHRINK FILM H800	1.500	M												
Code	Description	Qty	UOM																														
GRL1025A1	RIGHT/LEFT LAT.GRID CHROMIUM-P LATED	2	PZ																														
IP1508A1	POLYSTYREN E U SHAPED PROFILE 2000X60X60	2	M																														
VM1059A1	HEAT SHRINK FILM H800	1.500	M																														

COMPONENT			SPARE PART																						
Code	Description	Image	Code	Description	Components list																				
VM1815A	LATERAL SUPPORTS FIXING BOLT		KVM1815A	MISS/MICRO/S4/S3 THUMB SCREW 10 PCS KIT	<table border="1"> <thead> <tr> <th>Code</th> <th>Description</th> <th>Qty</th> <th>UOM</th> </tr> </thead> <tbody> <tr> <td>VM1224A0</td> <td>65MY 220MM 2 COLOURS SHRINK TUBE</td> <td>0.200</td> <td>M</td> </tr> <tr> <td>VM1815A0</td> <td>LATERAL SUPPORTS FIXING BOLT</td> <td>10</td> <td>PZ</td> </tr> </tbody> </table>	Code	Description	Qty	UOM	VM1224A0	65MY 220MM 2 COLOURS SHRINK TUBE	0.200	M	VM1815A0	LATERAL SUPPORTS FIXING BOLT	10	PZ								
Code	Description	Qty	UOM																						
VM1224A0	65MY 220MM 2 COLOURS SHRINK TUBE	0.200	M																						
VM1815A0	LATERAL SUPPORTS FIXING BOLT	10	PZ																						
TB1567A	ROSSELLA SHOP PRO FUME CHIMNEY D30		TB1567A0	ROSSELLA SHOP PRO FUME CHIMNEY D30																					
TB1581A	ROSSELLA SHOP PRO INTERNAL HUMIDITY PIPE		TB1581A0	ROSSELLA SHOP PRO INTERNAL HUMIDITY PIPE																					
0G1654A	ROSSELLA SHOP PRO FAN GUARD		K0G1654A	BLSP ROSSELLA LAT SUPP PLATE CARTER KIT	<table border="1"> <thead> <tr> <th>Code</th> <th>Description</th> <th>Qty</th> <th>UOM</th> </tr> </thead> <tbody> <tr> <td>0G1654A1</td> <td>ROSSELLA SHOP PRO FAN GUARD</td> <td>1</td> <td>PZ</td> </tr> <tr> <td>IP1385A1</td> <td>CORNER POLYSTYRENE PACKING 110X80X2000</td> <td>1.600</td> <td>M</td> </tr> <tr> <td>VI1982A0</td> <td>M6 ST. STEEL BLIND THREADED INSERT</td> <td>4</td> <td>PZ</td> </tr> <tr> <td>VM1059A1</td> <td>HEAT SHRINK FILM H800</td> <td>1</td> <td>M</td> </tr> </tbody> </table>	Code	Description	Qty	UOM	0G1654A1	ROSSELLA SHOP PRO FAN GUARD	1	PZ	IP1385A1	CORNER POLYSTYRENE PACKING 110X80X2000	1.600	M	VI1982A0	M6 ST. STEEL BLIND THREADED INSERT	4	PZ	VM1059A1	HEAT SHRINK FILM H800	1	M
Code	Description	Qty	UOM																						
0G1654A1	ROSSELLA SHOP PRO FAN GUARD	1	PZ																						
IP1385A1	CORNER POLYSTYRENE PACKING 110X80X2000	1.600	M																						
VI1982A0	M6 ST. STEEL BLIND THREADED INSERT	4	PZ																						
VM1059A1	HEAT SHRINK FILM H800	1	M																						

ASM3440A/0.D00 - Electrical system

FRONT

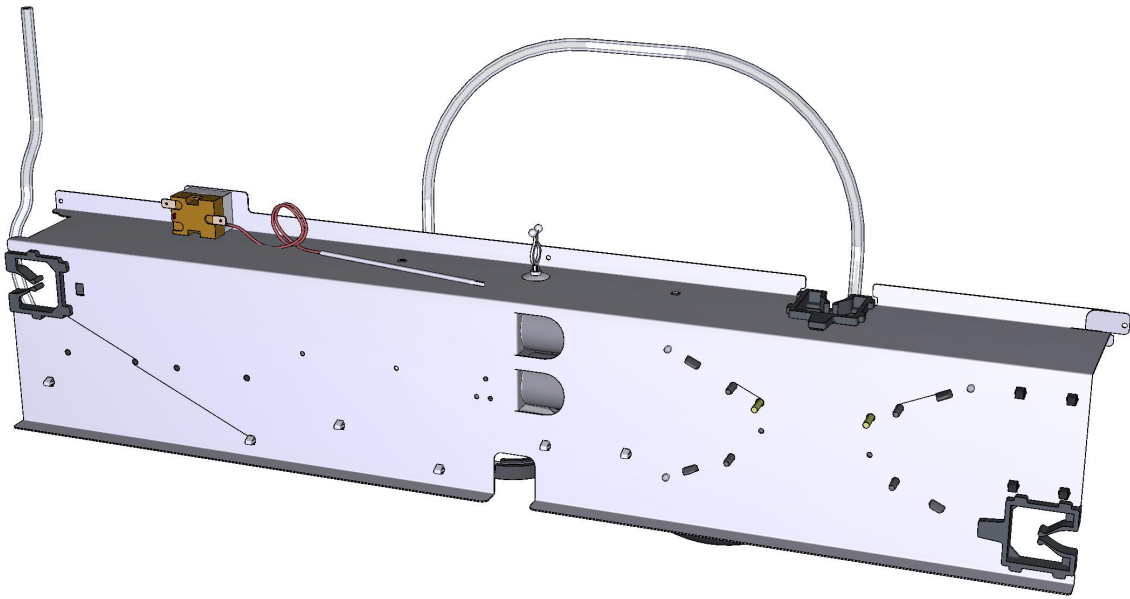



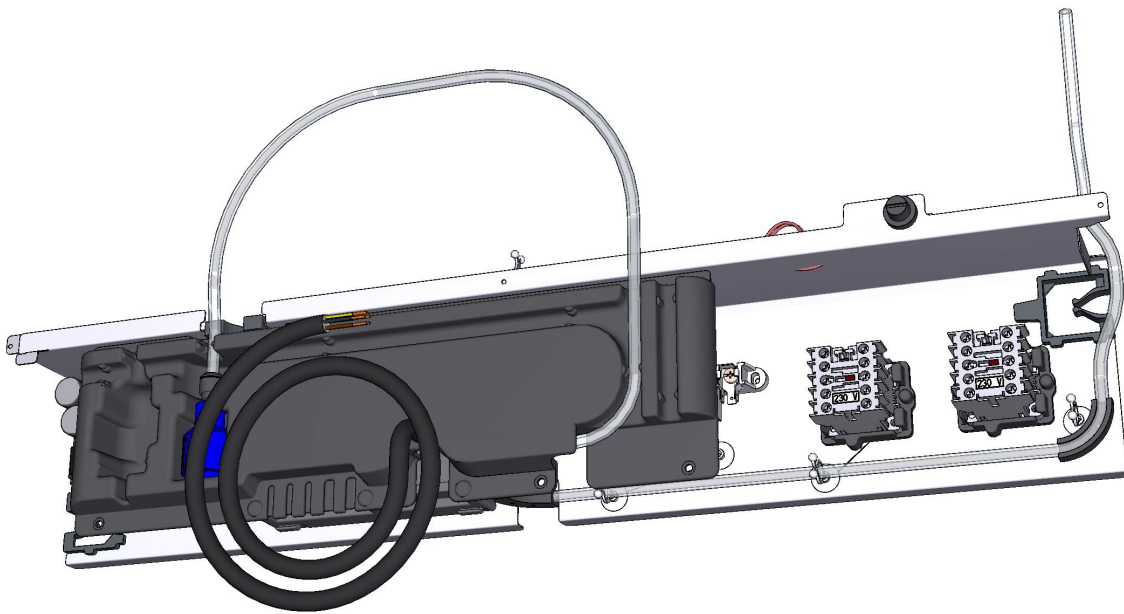

ASM3440A/0.D00 - Electrical system

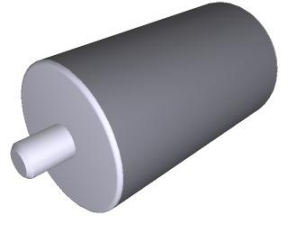
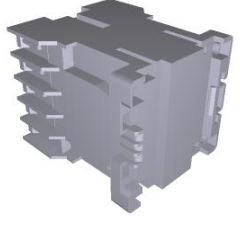

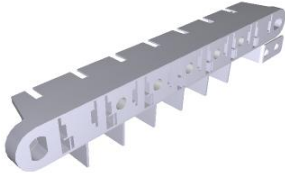

REAR



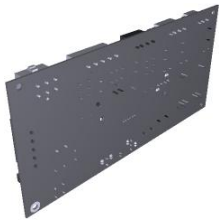
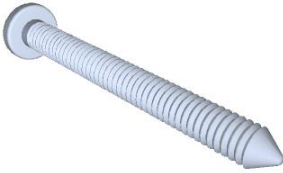
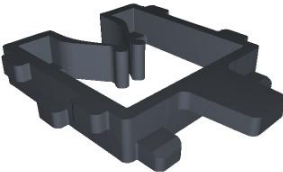
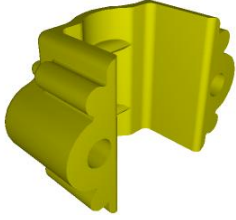

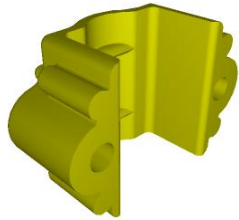
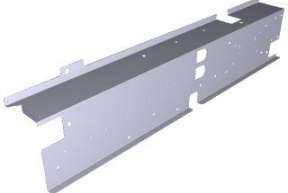
COMPONENT			SPARE PART																																		
Code	Description	Image	Code	Description	Components list																																
TR1136A	330 °C 1 POLE SAFETY THERMOSTAT		KTR1136A	330 °C SAFETY THERMOSTAT KIT	<table border="1"> <thead> <tr> <th>Code</th> <th>Description</th> <th>Qty</th> <th>UOM</th> </tr> </thead> <tbody> <tr> <td>0H7030A0</td> <td>THERMOSTAT BULB INLET COVER</td> <td>1</td> <td>PZ</td> </tr> <tr> <td>GN1531A0</td> <td>THERMOSTAT BULB INLET SEALING</td> <td>1</td> <td>PZ</td> </tr> <tr> <td>MOV0011A0</td> <td>HOOD RING GASKET</td> <td>0.100</td> <td>PZ</td> </tr> <tr> <td>GN1110A2</td> <td></td> <td></td> <td></td> </tr> <tr> <td>SL1045A0</td> <td>S57 BLACK SILICONE - 80ML CARTRIDGE</td> <td>1</td> <td>PZ</td> </tr> <tr> <td>TR1136A0</td> <td>330 °C 1 POLE SAFETY THERMOSTAT</td> <td>1</td> <td>PZ</td> </tr> <tr> <td>VI1220A1</td> <td>4,2X12 TCB SELF-TAPPING SCREW</td> <td>3</td> <td>PZ</td> </tr> </tbody> </table>	Code	Description	Qty	UOM	0H7030A0	THERMOSTAT BULB INLET COVER	1	PZ	GN1531A0	THERMOSTAT BULB INLET SEALING	1	PZ	MOV0011A0	HOOD RING GASKET	0.100	PZ	GN1110A2				SL1045A0	S57 BLACK SILICONE - 80ML CARTRIDGE	1	PZ	TR1136A0	330 °C 1 POLE SAFETY THERMOSTAT	1	PZ	VI1220A1	4,2X12 TCB SELF-TAPPING SCREW	3	PZ
Code	Description	Qty	UOM																																		
0H7030A0	THERMOSTAT BULB INLET COVER	1	PZ																																		
GN1531A0	THERMOSTAT BULB INLET SEALING	1	PZ																																		
MOV0011A0	HOOD RING GASKET	0.100	PZ																																		
GN1110A2																																					
SL1045A0	S57 BLACK SILICONE - 80ML CARTRIDGE	1	PZ																																		
TR1136A0	330 °C 1 POLE SAFETY THERMOSTAT	1	PZ																																		
VI1220A1	4,2X12 TCB SELF-TAPPING SCREW	3	PZ																																		
CN1003A	6,3 UF MOTOR CAPACITOR		KCN1003A	6,3 UF MOTOR CAPACITOR KIT	<table border="1"> <thead> <tr> <th>Code</th> <th>Description</th> <th>Qty</th> <th>UOM</th> </tr> </thead> <tbody> <tr> <td>CN1003A0</td> <td>6,3 UF MOTOR CAPACITOR</td> <td>1</td> <td>PZ</td> </tr> <tr> <td>VI1931A0</td> <td>M8 NUT+INDENTE D WASHER D=8 X COND.</td> <td>1</td> <td>PZ</td> </tr> <tr> <td>VI1932A0</td> <td>M8 NUT+INDENTE D WASHER D=8 X COND.</td> <td>1</td> <td>PZ</td> </tr> <tr> <td>VM1224A0</td> <td>65MY 220MM 2 COLOURS SHRINK TUBE</td> <td>0.200</td> <td>M</td> </tr> </tbody> </table>	Code	Description	Qty	UOM	CN1003A0	6,3 UF MOTOR CAPACITOR	1	PZ	VI1931A0	M8 NUT+INDENTE D WASHER D=8 X COND.	1	PZ	VI1932A0	M8 NUT+INDENTE D WASHER D=8 X COND.	1	PZ	VM1224A0	65MY 220MM 2 COLOURS SHRINK TUBE	0.200	M												
Code	Description	Qty	UOM																																		
CN1003A0	6,3 UF MOTOR CAPACITOR	1	PZ																																		
VI1931A0	M8 NUT+INDENTE D WASHER D=8 X COND.	1	PZ																																		
VI1932A0	M8 NUT+INDENTE D WASHER D=8 X COND.	1	PZ																																		
VM1224A0	65MY 220MM 2 COLOURS SHRINK TUBE	0.200	M																																		
VE1115A	20 A 230V 4 POLES MINICONTACTOR		KVE1115A	20A 230V 4 POLES MINICONTACTOR KI	<table border="1"> <thead> <tr> <th>Code</th> <th>Description</th> <th>Qty</th> <th>UOM</th> </tr> </thead> <tbody> <tr> <td>VE1115A0</td> <td>20 A 230V 4 POLES MINICONTACTOR</td> <td>1</td> <td>PZ</td> </tr> <tr> <td>VM1075A1</td> <td>PLASTIC CLIP TO FIX CONTACTORS</td> <td>4</td> <td>PZ</td> </tr> <tr> <td>VM1224A0</td> <td>65MY 220MM 2 COLOURS SHRINK TUBE</td> <td>0.250</td> <td>M</td> </tr> </tbody> </table>	Code	Description	Qty	UOM	VE1115A0	20 A 230V 4 POLES MINICONTACTOR	1	PZ	VM1075A1	PLASTIC CLIP TO FIX CONTACTORS	4	PZ	VM1224A0	65MY 220MM 2 COLOURS SHRINK TUBE	0.250	M																
Code	Description	Qty	UOM																																		
VE1115A0	20 A 230V 4 POLES MINICONTACTOR	1	PZ																																		
VM1075A1	PLASTIC CLIP TO FIX CONTACTORS	4	PZ																																		
VM1224A0	65MY 220MM 2 COLOURS SHRINK TUBE	0.250	M																																		

COMPONENT			SPARE PART																		
Code	Description	Image	Code	Description	Components list																
VM1056A	SMALL CONTACTOR BRACKET VE1115A		VM1056A0	SMALL CONTACTOR BRACKET VE1115A																	
RC1006A	D8 PET PIPE GUIDE BEND		KRC1006A	20 PCS. Ø8 PET PIPE GUIDE BEND KI	<table border="1"> <thead> <tr> <th>Code</th> <th>Description</th> <th>Qty</th> <th>UOM</th> </tr> </thead> <tbody> <tr> <td>RC1006A0</td> <td>D8 PET PIPE GUIDE BEND</td> <td>20</td> <td>PZ</td> </tr> <tr> <td>VM1224A0</td> <td>65MY 220MM 2 COLOURS SHRINK TUBE</td> <td>0.200</td> <td>M</td> </tr> </tbody> </table>	Code	Description	Qty	UOM	RC1006A0	D8 PET PIPE GUIDE BEND	20	PZ	VM1224A0	65MY 220MM 2 COLOURS SHRINK TUBE	0.200	M				
Code	Description	Qty	UOM																		
RC1006A0	D8 PET PIPE GUIDE BEND	20	PZ																		
VM1224A0	65MY 220MM 2 COLOURS SHRINK TUBE	0.200	M																		
MR1004A	41A 450V 7 POLES TERMINAL		KMR1004A	7FTW 1+2+3/4+5+6 TERMINAL BLOCK KIT	<table border="1"> <thead> <tr> <th>Code</th> <th>Description</th> <th>Qty</th> <th>UOM</th> </tr> </thead> <tbody> <tr> <td>MR1004A1</td> <td>41A 450V 7 POLES TERMINAL</td> <td>1</td> <td>PZ</td> </tr> <tr> <td>VM1224A0</td> <td>65MY 220MM 2 COLOURS SHRINK TUBE</td> <td>0.300</td> <td>M</td> </tr> </tbody> </table>	Code	Description	Qty	UOM	MR1004A1	41A 450V 7 POLES TERMINAL	1	PZ	VM1224A0	65MY 220MM 2 COLOURS SHRINK TUBE	0.300	M				
Code	Description	Qty	UOM																		
MR1004A1	41A 450V 7 POLES TERMINAL	1	PZ																		
VM1224A0	65MY 220MM 2 COLOURS SHRINK TUBE	0.300	M																		
VM1187A	POWER BOARD FRAME SHOP.PRO		VM1187A0	POWER BOARD FRAME SHOP.PRO																	
PE2102A	BL LED/TOUCH/PLUS 230 V POWER CARD		KPE2102A	BL LED/TOUCH/MASTE R 230V POWER CARD KIT	<table border="1"> <thead> <tr> <th>Code</th> <th>Description</th> <th>Qty</th> <th>UOM</th> </tr> </thead> <tbody> <tr> <td>PE2102A0</td> <td>BL LED/TOUCH/P LUS 230V POWER BOARD KIT</td> <td>1</td> <td>PZ</td> </tr> <tr> <td>PE2102A1</td> <td>BL LED/TOUCH/P LUS 230 V POWER CARD</td> <td>1</td> <td>PZ</td> </tr> <tr> <td>PE2102A2</td> <td>BL LED/TOUCH/P LUS 230V POWER BOAR</td> <td>1</td> <td>PZ</td> </tr> </tbody> </table>	Code	Description	Qty	UOM	PE2102A0	BL LED/TOUCH/P LUS 230V POWER BOARD KIT	1	PZ	PE2102A1	BL LED/TOUCH/P LUS 230 V POWER CARD	1	PZ	PE2102A2	BL LED/TOUCH/P LUS 230V POWER BOAR	1	PZ
Code	Description	Qty	UOM																		
PE2102A0	BL LED/TOUCH/P LUS 230V POWER BOARD KIT	1	PZ																		
PE2102A1	BL LED/TOUCH/P LUS 230 V POWER CARD	1	PZ																		
PE2102A2	BL LED/TOUCH/P LUS 230V POWER BOAR	1	PZ																		

COMPONENT			SPARE PART																		
Code	Description	Image	Code	Description	Components list																
PE2102A	BL LED/TOUCH/PLUS 230 V POWER CARD		KPE2102A	BL LED/TOUCH/MASTE R 230V POWER CARD KIT	<table border="1"> <thead> <tr> <th>Code</th> <th>Description</th> <th>Qty</th> <th>UOM</th> </tr> </thead> <tbody> <tr> <td>VI1988A0</td> <td>AUTOTHREAD ING SCREW 4,2X19 TCB+ INOX</td> <td>3</td> <td>PZ</td> </tr> <tr> <td>VM1187A0</td> <td>POWER BOARD FRAME SHOP.PRO</td> <td>1</td> <td>PZ</td> </tr> <tr> <td>VM2147A0</td> <td>410X343X15 MM PINK SMOOTH ESD SPONGE</td> <td>1</td> <td>PZ</td> </tr> </tbody> </table>	Code	Description	Qty	UOM	VI1988A0	AUTOTHREAD ING SCREW 4,2X19 TCB+ INOX	3	PZ	VM1187A0	POWER BOARD FRAME SHOP.PRO	1	PZ	VM2147A0	410X343X15 MM PINK SMOOTH ESD SPONGE	1	PZ
Code	Description	Qty	UOM																		
VI1988A0	AUTOTHREAD ING SCREW 4,2X19 TCB+ INOX	3	PZ																		
VM1187A0	POWER BOARD FRAME SHOP.PRO	1	PZ																		
VM2147A0	410X343X15 MM PINK SMOOTH ESD SPONGE	1	PZ																		
VI1328A			VI1328A0																		
VM1188A	BL SHOP.PRO POWER BOARD WIRE PASSAGE		KVM1188A	BL SP POWER BOARD WIRE PASSAGE 10 PC KIT	<table border="1"> <thead> <tr> <th>Code</th> <th>Description</th> <th>Qty</th> <th>UOM</th> </tr> </thead> <tbody> <tr> <td>VM1188A0</td> <td>BL SHOP.PRO POWER BOARD WIRE PASSAGE</td> <td>10</td> <td>PZ</td> </tr> <tr> <td>VM1224A0</td> <td>65MY 220MM 2 COLOURS SHRINK TUBE</td> <td>0.200</td> <td>M</td> </tr> </tbody> </table>	Code	Description	Qty	UOM	VM1188A0	BL SHOP.PRO POWER BOARD WIRE PASSAGE	10	PZ	VM1224A0	65MY 220MM 2 COLOURS SHRINK TUBE	0.200	M				
Code	Description	Qty	UOM																		
VM1188A0	BL SHOP.PRO POWER BOARD WIRE PASSAGE	10	PZ																		
VM1224A0	65MY 220MM 2 COLOURS SHRINK TUBE	0.200	M																		
VM2484A	ELECTRICAL CONNECTION CABLE CLAMP		KVM2484A	CABLE LOCKS ELECTRICAL CONNECTION KIT	<table border="1"> <thead> <tr> <th>Code</th> <th>Description</th> <th>Qty</th> <th>UOM</th> </tr> </thead> <tbody> <tr> <td>VM1224A0</td> <td>65MY 220MM 2 COLOURS SHRINK TUBE</td> <td>0.300</td> <td>M</td> </tr> <tr> <td>VM2484A0</td> <td>ELECTRICAL CONNECTION CABLE CLAMP</td> <td>1</td> <td>PZ</td> </tr> <tr> <td>VM2484A0</td> <td>ELECTRICAL CONNECTION CABLE CLAMP</td> <td>1</td> <td>PZ</td> </tr> </tbody> </table>	Code	Description	Qty	UOM	VM1224A0	65MY 220MM 2 COLOURS SHRINK TUBE	0.300	M	VM2484A0	ELECTRICAL CONNECTION CABLE CLAMP	1	PZ	VM2484A0	ELECTRICAL CONNECTION CABLE CLAMP	1	PZ
Code	Description	Qty	UOM																		
VM1224A0	65MY 220MM 2 COLOURS SHRINK TUBE	0.300	M																		
VM2484A0	ELECTRICAL CONNECTION CABLE CLAMP	1	PZ																		
VM2484A0	ELECTRICAL CONNECTION CABLE CLAMP	1	PZ																		
			KVM2482A	BAKERLUX SP ELECTR COMPONENTS HOLDER KIT	<table border="1"> <thead> <tr> <th>Code</th> <th>Description</th> <th>Qty</th> <th>UOM</th> </tr> </thead> <tbody> <tr> <td>VM1224A0</td> <td>65MY 220MM 2 COLOURS SHRINK TUBE</td> <td>0.300</td> <td>M</td> </tr> <tr> <td>VM2482A0</td> <td>ELECTR COMPONENT S HOLDER FRAME SHOP.PRO</td> <td>1</td> <td>PZ</td> </tr> </tbody> </table>	Code	Description	Qty	UOM	VM1224A0	65MY 220MM 2 COLOURS SHRINK TUBE	0.300	M	VM2482A0	ELECTR COMPONENT S HOLDER FRAME SHOP.PRO	1	PZ				
Code	Description	Qty	UOM																		
VM1224A0	65MY 220MM 2 COLOURS SHRINK TUBE	0.300	M																		
VM2482A0	ELECTR COMPONENT S HOLDER FRAME SHOP.PRO	1	PZ																		

COMPONENT			SPARE PART																		
Code	Description	Image	Code	Description	Components list																
VM2484A	ELECTRICAL CONNECTION CABLE CLAMP		KVM2482A	BAKERLUX SP ELECTR COMPONENTS HOLDER KIT	<table border="1"> <thead> <tr> <th>Code</th> <th>Description</th> <th>Qty</th> <th>UOM</th> </tr> </thead> <tbody> <tr> <td>VM2482A0</td> <td>ELECTR COMPONENTS HOLDER FRAME SHOP.PRO</td> <td>1</td> <td>PZ</td> </tr> <tr> <td>VM2484A0</td> <td>ELECTRICAL CONNECTION CABLE CLAMP</td> <td>1</td> <td>PZ</td> </tr> <tr> <td>VM2484A0</td> <td>ELECTRICAL CONNECTION CABLE CLAMP</td> <td>1</td> <td>PZ</td> </tr> </tbody> </table>	Code	Description	Qty	UOM	VM2482A0	ELECTR COMPONENTS HOLDER FRAME SHOP.PRO	1	PZ	VM2484A0	ELECTRICAL CONNECTION CABLE CLAMP	1	PZ	VM2484A0	ELECTRICAL CONNECTION CABLE CLAMP	1	PZ
Code	Description	Qty	UOM																		
VM2482A0	ELECTR COMPONENTS HOLDER FRAME SHOP.PRO	1	PZ																		
VM2484A0	ELECTRICAL CONNECTION CABLE CLAMP	1	PZ																		
VM2484A0	ELECTRICAL CONNECTION CABLE CLAMP	1	PZ																		
0P1022A	COMPONENTS HOLDING PANEL ELE-ROS SP		0P1022A0	COMPONENTS HOLDING PANEL ELE-ROS SP																	
CE1356A	5X1.5 MMQ L1.5 MT POWER SUPPLY WIRE		CE1356A0	5X1.5 MMQ L1.5 MT POWER SUPPLY WIRE																	
TB3283A			KTB1959A	7,93X4,75 PE TRANSPARENT PIPE 5M KIT	<table border="1"> <thead> <tr> <th>Code</th> <th>Description</th> <th>Qty</th> <th>UOM</th> </tr> </thead> <tbody> <tr> <td>TB1815A0</td> <td>7,93X4,75 PE TRANSP. PIPE (JG #PE08100N)</td> <td>5</td> <td>M</td> </tr> </tbody> </table>	Code	Description	Qty	UOM	TB1815A0	7,93X4,75 PE TRANSP. PIPE (JG #PE08100N)	5	M								
Code	Description	Qty	UOM																		
TB1815A0	7,93X4,75 PE TRANSP. PIPE (JG #PE08100N)	5	M																		
PE2117A	BLSP ELECTROMECHANICAL LOCK BOARD		KPE2117A	ELECTRIC LOCKING SYSTEM BOARD KIT 230V	<table border="1"> <thead> <tr> <th>Code</th> <th>Description</th> <th>Qty</th> <th>UOM</th> </tr> </thead> <tbody> <tr> <td>PE2117A0</td> <td>BLSP ELECTROMECHANICAL LOCK BOARD</td> <td>1</td> <td>PZ</td> </tr> <tr> <td>VI1850A0</td> <td>M4X6 NICKEL PLATED FIXING SCRE</td> <td>2</td> <td>PZ</td> </tr> <tr> <td>VM1746A0</td> <td>H10 M4 JOINT BOARD FASTENING CLIP</td> <td>2</td> <td>PZ</td> </tr> </tbody> </table>	Code	Description	Qty	UOM	PE2117A0	BLSP ELECTROMECHANICAL LOCK BOARD	1	PZ	VI1850A0	M4X6 NICKEL PLATED FIXING SCRE	2	PZ	VM1746A0	H10 M4 JOINT BOARD FASTENING CLIP	2	PZ
Code	Description	Qty	UOM																		
PE2117A0	BLSP ELECTROMECHANICAL LOCK BOARD	1	PZ																		
VI1850A0	M4X6 NICKEL PLATED FIXING SCRE	2	PZ																		
VM1746A0	H10 M4 JOINT BOARD FASTENING CLIP	2	PZ																		

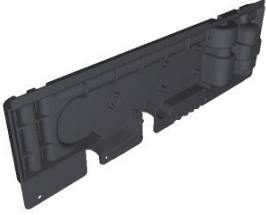
COMPONENT			SPARE PART																										
Code	Description	Image	Code	Description	Components list																								
PE2117A	BLSP ELECTROMECHANICAL LOCK BOARD		KPE2117A	ELECTRIC LOCKING SYSTEM BOARD KIT 230V	<table border="1"> <thead> <tr> <th>Code</th> <th>Description</th> <th>Qty</th> <th>UOM</th> </tr> </thead> <tbody> <tr> <td>VM1747A0</td> <td>JOINT-PIN H10 POWER BOARD FASTENING CLIP</td> <td>2</td> <td>PZ</td> </tr> <tr> <td>VM2147A0</td> <td>410X343X15 MM PINK SMOOTH ESD SPONGE</td> <td>0.500</td> <td>PZ</td> </tr> </tbody> </table>	Code	Description	Qty	UOM	VM1747A0	JOINT-PIN H10 POWER BOARD FASTENING CLIP	2	PZ	VM2147A0	410X343X15 MM PINK SMOOTH ESD SPONGE	0.500	PZ												
					Code	Description	Qty	UOM																					
VM1747A0	JOINT-PIN H10 POWER BOARD FASTENING CLIP	2	PZ																										
VM2147A0	410X343X15 MM PINK SMOOTH ESD SPONGE	0.500	PZ																										
<table border="1"> <thead> <tr> <th>Code</th> <th>Description</th> <th>Qty</th> <th>UOM</th> </tr> </thead> <tbody> <tr> <td>VM1224A0</td> <td>65MY 220MM 2 COLOURS SHRINK TUBE</td> <td>0.250</td> <td>M</td> </tr> <tr> <td>VM1746A0</td> <td>H10 M4 JOINT BOARD FASTENING CLIP</td> <td>10</td> <td>PZ</td> </tr> </tbody> </table>	Code	Description	Qty	UOM	VM1224A0	65MY 220MM 2 COLOURS SHRINK TUBE	0.250	M	VM1746A0	H10 M4 JOINT BOARD FASTENING CLIP	10	PZ																	
Code	Description	Qty	UOM																										
VM1224A0	65MY 220MM 2 COLOURS SHRINK TUBE	0.250	M																										
VM1746A0	H10 M4 JOINT BOARD FASTENING CLIP	10	PZ																										
VM1746A	H10 M4 JOINT BOARD FASTENING CLIP		KVM1746A	BOARD FIXING CLIP JOINT-M4 KIT	<table border="1"> <thead> <tr> <th>Code</th> <th>Description</th> <th>Qty</th> <th>UOM</th> </tr> </thead> <tbody> <tr> <td>VM1224A0</td> <td>65MY 220MM 2 COLOURS SHRINK TUBE</td> <td>0.250</td> <td>M</td> </tr> <tr> <td>VM1746A0</td> <td>H10 M4 JOINT BOARD FASTENING CLIP</td> <td>10</td> <td>PZ</td> </tr> </tbody> </table>	Code	Description	Qty	UOM	VM1224A0	65MY 220MM 2 COLOURS SHRINK TUBE	0.250	M	VM1746A0	H10 M4 JOINT BOARD FASTENING CLIP	10	PZ												
					Code	Description	Qty	UOM																					
VM1224A0	65MY 220MM 2 COLOURS SHRINK TUBE	0.250	M																										
VM1746A0	H10 M4 JOINT BOARD FASTENING CLIP	10	PZ																										
<table border="1"> <thead> <tr> <th>Code</th> <th>Description</th> <th>Qty</th> <th>UOM</th> </tr> </thead> <tbody> <tr> <td>VM1224A0</td> <td>65MY 220MM 2 COLOURS SHRINK TUBE</td> <td>0.250</td> <td>M</td> </tr> <tr> <td>VM1747A0</td> <td>JOINT-PIN H10 POWER BOARD FASTENING CLIP</td> <td>10</td> <td>PZ</td> </tr> </tbody> </table>	Code	Description	Qty	UOM	VM1224A0	65MY 220MM 2 COLOURS SHRINK TUBE	0.250	M	VM1747A0	JOINT-PIN H10 POWER BOARD FASTENING CLIP	10	PZ																	
Code	Description	Qty	UOM																										
VM1224A0	65MY 220MM 2 COLOURS SHRINK TUBE	0.250	M																										
VM1747A0	JOINT-PIN H10 POWER BOARD FASTENING CLIP	10	PZ																										
VM1747A	JOINT-PIN H10 POWER BOARD FASTENING CLIP		KVM1747A	BOARD FIXING CLIP JOINT-PIN KIT	<table border="1"> <thead> <tr> <th>Code</th> <th>Description</th> <th>Qty</th> <th>UOM</th> </tr> </thead> <tbody> <tr> <td>VM1224A0</td> <td>65MY 220MM 2 COLOURS SHRINK TUBE</td> <td>0.250</td> <td>M</td> </tr> <tr> <td>VM1747A0</td> <td>JOINT-PIN H10 POWER BOARD FASTENING CLIP</td> <td>10</td> <td>PZ</td> </tr> </tbody> </table>	Code	Description	Qty	UOM	VM1224A0	65MY 220MM 2 COLOURS SHRINK TUBE	0.250	M	VM1747A0	JOINT-PIN H10 POWER BOARD FASTENING CLIP	10	PZ												
					Code	Description	Qty	UOM																					
VM1224A0	65MY 220MM 2 COLOURS SHRINK TUBE	0.250	M																										
VM1747A0	JOINT-PIN H10 POWER BOARD FASTENING CLIP	10	PZ																										
<table border="1"> <thead> <tr> <th>Code</th> <th>Description</th> <th>Qty</th> <th>UOM</th> </tr> </thead> <tbody> <tr> <td>VM1224A0</td> <td>65MY 220MM 2 COLOURS SHRINK TUBE</td> <td>0.300</td> <td>M</td> </tr> <tr> <td>VM2482A0</td> <td>ELECTR COMPONENT S HOLDER FRAME SHOP.PRO</td> <td>1</td> <td>PZ</td> </tr> <tr> <td>VM2482A0</td> <td>ELECTR COMPONENT S HOLDER FRAME SHOP.PRO</td> <td>1</td> <td>PZ</td> </tr> <tr> <td>VM2484A0</td> <td>ELECTRICAL CONNECTION CABLE CLAMP</td> <td>1</td> <td>PZ</td> </tr> <tr> <td>VM2484A0</td> <td>ELECTRICAL CONNECTION CABLE CLAMP</td> <td>1</td> <td>PZ</td> </tr> </tbody> </table>	Code	Description	Qty	UOM	VM1224A0	65MY 220MM 2 COLOURS SHRINK TUBE	0.300	M	VM2482A0	ELECTR COMPONENT S HOLDER FRAME SHOP.PRO	1	PZ	VM2482A0	ELECTR COMPONENT S HOLDER FRAME SHOP.PRO	1	PZ	VM2484A0	ELECTRICAL CONNECTION CABLE CLAMP	1	PZ	VM2484A0	ELECTRICAL CONNECTION CABLE CLAMP	1	PZ					
Code	Description	Qty	UOM																										
VM1224A0	65MY 220MM 2 COLOURS SHRINK TUBE	0.300	M																										
VM2482A0	ELECTR COMPONENT S HOLDER FRAME SHOP.PRO	1	PZ																										
VM2482A0	ELECTR COMPONENT S HOLDER FRAME SHOP.PRO	1	PZ																										
VM2484A0	ELECTRICAL CONNECTION CABLE CLAMP	1	PZ																										
VM2484A0	ELECTRICAL CONNECTION CABLE CLAMP	1	PZ																										
VM2482A	ELECTR COMPONENTS HOLDER FRAME SHOP.PRO		KVM2482A	BAKERLUX SP ELECTR COMPONENTS HOLDER KIT	<table border="1"> <thead> <tr> <th>Code</th> <th>Description</th> <th>Qty</th> <th>UOM</th> </tr> </thead> <tbody> <tr> <td>VM1224A0</td> <td>65MY 220MM 2 COLOURS SHRINK TUBE</td> <td>0.300</td> <td>M</td> </tr> <tr> <td>VM2482A0</td> <td>ELECTR COMPONENT S HOLDER FRAME SHOP.PRO</td> <td>1</td> <td>PZ</td> </tr> <tr> <td>VM2482A0</td> <td>ELECTR COMPONENT S HOLDER FRAME SHOP.PRO</td> <td>1</td> <td>PZ</td> </tr> <tr> <td>VM2484A0</td> <td>ELECTRICAL CONNECTION CABLE CLAMP</td> <td>1</td> <td>PZ</td> </tr> <tr> <td>VM2484A0</td> <td>ELECTRICAL CONNECTION CABLE CLAMP</td> <td>1</td> <td>PZ</td> </tr> </tbody> </table>	Code	Description	Qty	UOM	VM1224A0	65MY 220MM 2 COLOURS SHRINK TUBE	0.300	M	VM2482A0	ELECTR COMPONENT S HOLDER FRAME SHOP.PRO	1	PZ	VM2482A0	ELECTR COMPONENT S HOLDER FRAME SHOP.PRO	1	PZ	VM2484A0	ELECTRICAL CONNECTION CABLE CLAMP	1	PZ	VM2484A0	ELECTRICAL CONNECTION CABLE CLAMP	1	PZ
					Code	Description	Qty	UOM																					
					VM1224A0	65MY 220MM 2 COLOURS SHRINK TUBE	0.300	M																					
					VM2482A0	ELECTR COMPONENT S HOLDER FRAME SHOP.PRO	1	PZ																					
					VM2482A0	ELECTR COMPONENT S HOLDER FRAME SHOP.PRO	1	PZ																					
VM2484A0	ELECTRICAL CONNECTION CABLE CLAMP	1	PZ																										
VM2484A0	ELECTRICAL CONNECTION CABLE CLAMP	1	PZ																										
<table border="1"> <thead> <tr> <th>Code</th> <th>Description</th> <th>Qty</th> <th>UOM</th> </tr> </thead> <tbody> <tr> <td>VM2482A0</td> <td>ELECTR COMPONENT S HOLDER FRAME SHOP.PRO</td> <td>1</td> <td>PZ</td> </tr> <tr> <td>VM2482A0</td> <td>ELECTR COMPONENT S HOLDER FRAME SHOP.PRO</td> <td>1</td> <td>PZ</td> </tr> <tr> <td>VM2484A0</td> <td>ELECTRICAL CONNECTION CABLE CLAMP</td> <td>1</td> <td>PZ</td> </tr> <tr> <td>VM2484A0</td> <td>ELECTRICAL CONNECTION CABLE CLAMP</td> <td>1</td> <td>PZ</td> </tr> </tbody> </table>	Code	Description	Qty	UOM	VM2482A0	ELECTR COMPONENT S HOLDER FRAME SHOP.PRO	1	PZ	VM2482A0	ELECTR COMPONENT S HOLDER FRAME SHOP.PRO	1	PZ	VM2484A0	ELECTRICAL CONNECTION CABLE CLAMP	1	PZ	VM2484A0	ELECTRICAL CONNECTION CABLE CLAMP	1	PZ									
Code	Description	Qty	UOM																										
VM2482A0	ELECTR COMPONENT S HOLDER FRAME SHOP.PRO	1	PZ																										
VM2482A0	ELECTR COMPONENT S HOLDER FRAME SHOP.PRO	1	PZ																										
VM2484A0	ELECTRICAL CONNECTION CABLE CLAMP	1	PZ																										
VM2484A0	ELECTRICAL CONNECTION CABLE CLAMP	1	PZ																										
<table border="1"> <thead> <tr> <th>Code</th> <th>Description</th> <th>Qty</th> <th>UOM</th> </tr> </thead> <tbody> <tr> <td>VM2482A0</td> <td>ELECTR COMPONENT S HOLDER FRAME SHOP.PRO</td> <td>1</td> <td>PZ</td> </tr> <tr> <td>VM2482A0</td> <td>ELECTR COMPONENT S HOLDER FRAME SHOP.PRO</td> <td>1</td> <td>PZ</td> </tr> <tr> <td>VM2484A0</td> <td>ELECTRICAL CONNECTION CABLE CLAMP</td> <td>1</td> <td>PZ</td> </tr> <tr> <td>VM2484A0</td> <td>ELECTRICAL CONNECTION CABLE CLAMP</td> <td>1</td> <td>PZ</td> </tr> </tbody> </table>	Code	Description	Qty	UOM	VM2482A0	ELECTR COMPONENT S HOLDER FRAME SHOP.PRO	1	PZ	VM2482A0	ELECTR COMPONENT S HOLDER FRAME SHOP.PRO	1	PZ	VM2484A0	ELECTRICAL CONNECTION CABLE CLAMP	1	PZ	VM2484A0	ELECTRICAL CONNECTION CABLE CLAMP	1	PZ									
Code	Description	Qty	UOM																										
VM2482A0	ELECTR COMPONENT S HOLDER FRAME SHOP.PRO	1	PZ																										
VM2482A0	ELECTR COMPONENT S HOLDER FRAME SHOP.PRO	1	PZ																										
VM2484A0	ELECTRICAL CONNECTION CABLE CLAMP	1	PZ																										
VM2484A0	ELECTRICAL CONNECTION CABLE CLAMP	1	PZ																										
<table border="1"> <thead> <tr> <th>Code</th> <th>Description</th> <th>Qty</th> <th>UOM</th> </tr> </thead> <tbody> <tr> <td>VM2482A0</td> <td>ELECTR COMPONENT S HOLDER FRAME SHOP.PRO</td> <td>1</td> <td>PZ</td> </tr> <tr> <td>VM2482A0</td> <td>ELECTR COMPONENT S HOLDER FRAME SHOP.PRO</td> <td>1</td> <td>PZ</td> </tr> <tr> <td>VM2484A0</td> <td>ELECTRICAL CONNECTION CABLE CLAMP</td> <td>1</td> <td>PZ</td> </tr> <tr> <td>VM2484A0</td> <td>ELECTRICAL CONNECTION CABLE CLAMP</td> <td>1</td> <td>PZ</td> </tr> </tbody> </table>	Code	Description	Qty	UOM	VM2482A0	ELECTR COMPONENT S HOLDER FRAME SHOP.PRO	1	PZ	VM2482A0	ELECTR COMPONENT S HOLDER FRAME SHOP.PRO	1	PZ	VM2484A0	ELECTRICAL CONNECTION CABLE CLAMP	1	PZ	VM2484A0	ELECTRICAL CONNECTION CABLE CLAMP	1	PZ									
Code	Description	Qty	UOM																										
VM2482A0	ELECTR COMPONENT S HOLDER FRAME SHOP.PRO	1	PZ																										
VM2482A0	ELECTR COMPONENT S HOLDER FRAME SHOP.PRO	1	PZ																										
VM2484A0	ELECTRICAL CONNECTION CABLE CLAMP	1	PZ																										
VM2484A0	ELECTRICAL CONNECTION CABLE CLAMP	1	PZ																										
<table border="1"> <thead> <tr> <th>Code</th> <th>Description</th> <th>Qty</th> <th>UOM</th> </tr> </thead> <tbody> <tr> <td>VM2482A0</td> <td>ELECTR COMPONENT S HOLDER FRAME SHOP.PRO</td> <td>1</td> <td>PZ</td> </tr> <tr> <td>VM2482A0</td> <td>ELECTR COMPONENT S HOLDER FRAME SHOP.PRO</td> <td>1</td> <td>PZ</td> </tr> <tr> <td>VM2484A0</td> <td>ELECTRICAL CONNECTION CABLE CLAMP</td> <td>1</td> <td>PZ</td> </tr> <tr> <td>VM2484A0</td> <td>ELECTRICAL CONNECTION CABLE CLAMP</td> <td>1</td> <td>PZ</td> </tr> </tbody> </table>	Code	Description	Qty	UOM	VM2482A0	ELECTR COMPONENT S HOLDER FRAME SHOP.PRO	1	PZ	VM2482A0	ELECTR COMPONENT S HOLDER FRAME SHOP.PRO	1	PZ	VM2484A0	ELECTRICAL CONNECTION CABLE CLAMP	1	PZ	VM2484A0	ELECTRICAL CONNECTION CABLE CLAMP	1	PZ									
Code	Description	Qty	UOM																										
VM2482A0	ELECTR COMPONENT S HOLDER FRAME SHOP.PRO	1	PZ																										
VM2482A0	ELECTR COMPONENT S HOLDER FRAME SHOP.PRO	1	PZ																										
VM2484A0	ELECTRICAL CONNECTION CABLE CLAMP	1	PZ																										
VM2484A0	ELECTRICAL CONNECTION CABLE CLAMP	1	PZ																										

COMPONENT			SPARE PART																						
Code	Description	Image	Code	Description	Components list																				
VM2483A	SHOP PRO COMPONENTS HOLDER COVER		KVM2483A	BL SHOP.PRO COMPONENTS HOLDER COVER KIT	<table border="1"> <thead> <tr> <th>Code</th> <th>Description</th> <th>Qty</th> <th>UOM</th> </tr> </thead> <tbody> <tr> <td>VM1224A0</td> <td>65MY 220MM 2 COLOURS SHRINK TUBE</td> <td>0.300</td> <td>M</td> </tr> <tr> <td>VM2483A0</td> <td>COMPONENT S HOLDER COVER SHOP.PRO</td> <td>1</td> <td>PZ</td> </tr> <tr> <td>VM2483A0</td> <td>COMPONENT S HOLDER COVER SHOP.PRO</td> <td>1</td> <td>PZ</td> </tr> <tr> <td>VM2483A1</td> <td>SHOP PRO COMPONENT S HOLDER COVER</td> <td>1</td> <td>PZ</td> </tr> </tbody> </table>	Code	Description	Qty	UOM	VM1224A0	65MY 220MM 2 COLOURS SHRINK TUBE	0.300	M	VM2483A0	COMPONENT S HOLDER COVER SHOP.PRO	1	PZ	VM2483A0	COMPONENT S HOLDER COVER SHOP.PRO	1	PZ	VM2483A1	SHOP PRO COMPONENT S HOLDER COVER	1	PZ
Code	Description	Qty	UOM																						
VM1224A0	65MY 220MM 2 COLOURS SHRINK TUBE	0.300	M																						
VM2483A0	COMPONENT S HOLDER COVER SHOP.PRO	1	PZ																						
VM2483A0	COMPONENT S HOLDER COVER SHOP.PRO	1	PZ																						
VM2483A1	SHOP PRO COMPONENT S HOLDER COVER	1	PZ																						
RC1365A	3/4"-10 JG FEMALE CONNECTION		KRC1365A	3/4"-10 OR 8 JG WATER CONNECTION KIT	<table border="1"> <thead> <tr> <th>Code</th> <th>Description</th> <th>Qty</th> <th>UOM</th> </tr> </thead> <tbody> <tr> <td>GN1200A1</td> <td>3/4 CONNECTION SEAL D=24 RUBBER+NET</td> <td>1</td> <td>PZ</td> </tr> <tr> <td>RC1002A0</td> <td>JG 10M-8F TERMINAL REDUCTION FITTING</td> <td>1</td> <td>PZ</td> </tr> <tr> <td>RC1365A0</td> <td>3/4"-10 JG FEMALE CONNECTION</td> <td>1</td> <td>PZ</td> </tr> <tr> <td>VM1224A0</td> <td>65MY 220MM 2 COLOURS SHRINK TUBE</td> <td>0.150</td> <td>M</td> </tr> </tbody> </table>	Code	Description	Qty	UOM	GN1200A1	3/4 CONNECTION SEAL D=24 RUBBER+NET	1	PZ	RC1002A0	JG 10M-8F TERMINAL REDUCTION FITTING	1	PZ	RC1365A0	3/4"-10 JG FEMALE CONNECTION	1	PZ	VM1224A0	65MY 220MM 2 COLOURS SHRINK TUBE	0.150	M
Code	Description	Qty	UOM																						
GN1200A1	3/4 CONNECTION SEAL D=24 RUBBER+NET	1	PZ																						
RC1002A0	JG 10M-8F TERMINAL REDUCTION FITTING	1	PZ																						
RC1365A0	3/4"-10 JG FEMALE CONNECTION	1	PZ																						
VM1224A0	65MY 220MM 2 COLOURS SHRINK TUBE	0.150	M																						
RC1002A	JG 10M-8F TERMINAL REDUCTION FITTIN		KRC1002A	JG Ø10M-Ø8F REDUCING SPIGOT 10 PCS KIT	<table border="1"> <thead> <tr> <th>Code</th> <th>Description</th> <th>Qty</th> <th>UOM</th> </tr> </thead> <tbody> <tr> <td>RC1002A0</td> <td>JG 10M-8F TERMINAL REDUCTION FITTING</td> <td>10</td> <td>PZ</td> </tr> <tr> <td>VM1224A0</td> <td>65MY 220MM 2 COLOURS SHRINK TUBE</td> <td>0.200</td> <td>M</td> </tr> </tbody> </table>	Code	Description	Qty	UOM	RC1002A0	JG 10M-8F TERMINAL REDUCTION FITTING	10	PZ	VM1224A0	65MY 220MM 2 COLOURS SHRINK TUBE	0.200	M								
Code	Description	Qty	UOM																						
RC1002A0	JG 10M-8F TERMINAL REDUCTION FITTING	10	PZ																						
VM1224A0	65MY 220MM 2 COLOURS SHRINK TUBE	0.200	M																						

ASM3431A/0.D00 - Door

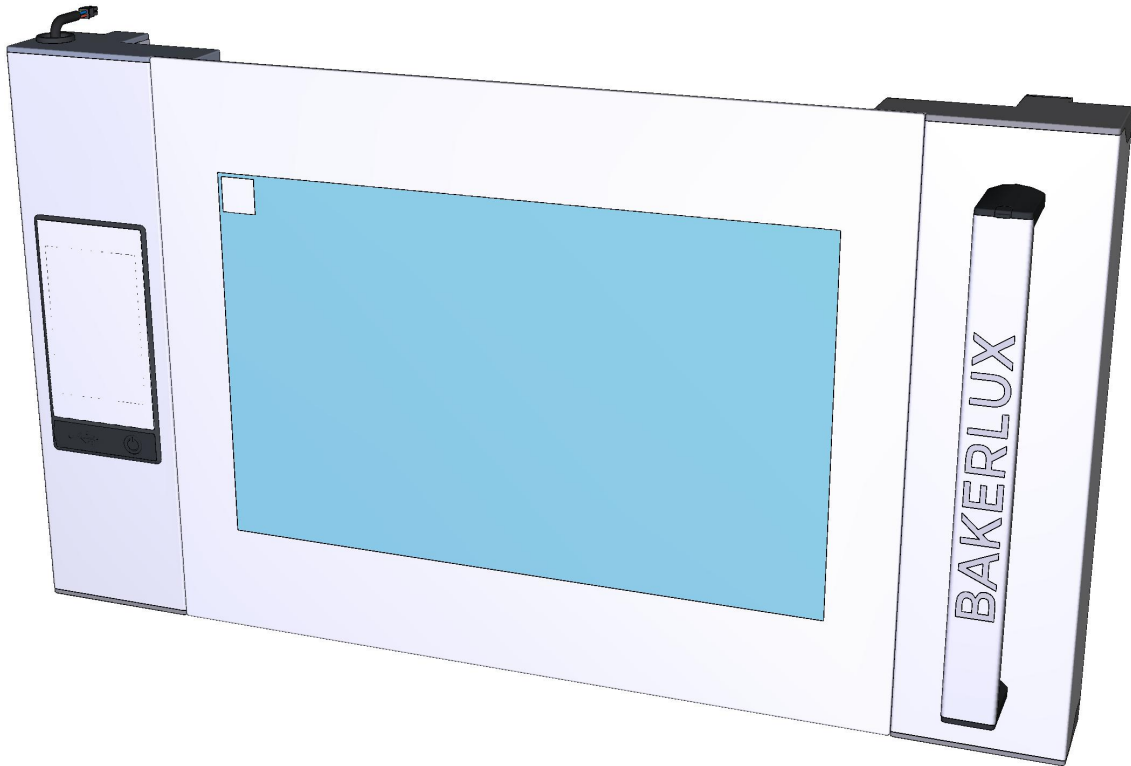

FRONT

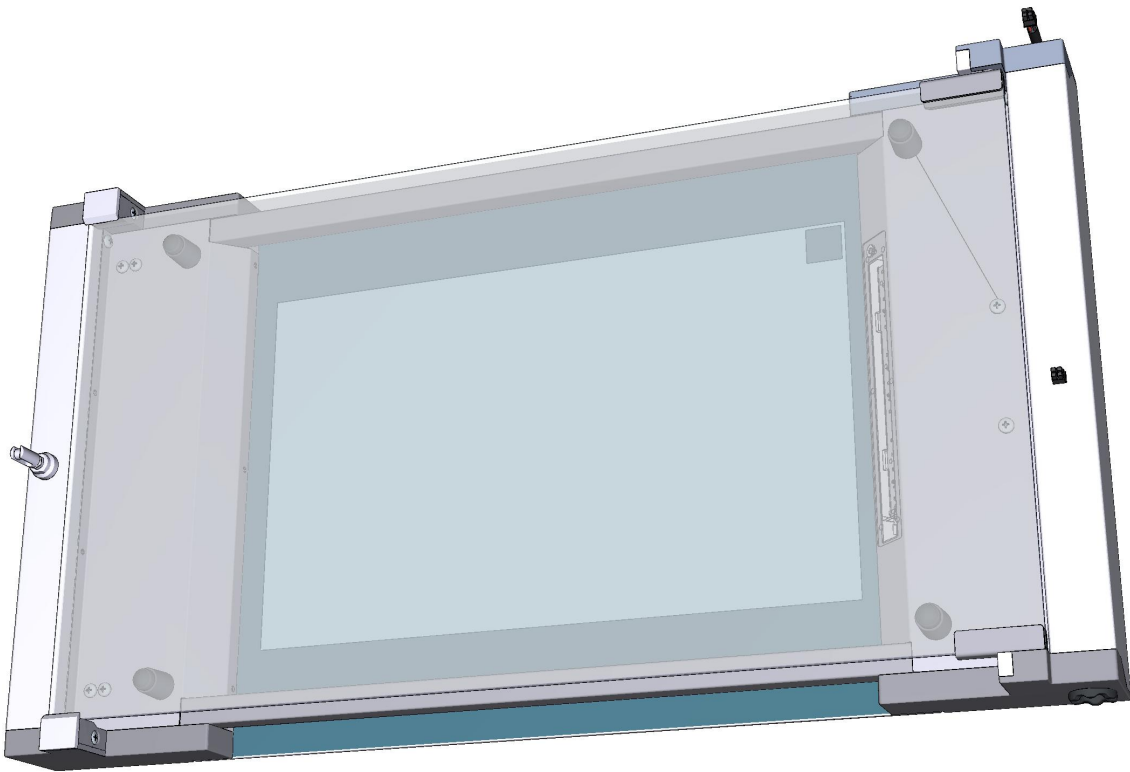

ASM3431A/0.D00 - Door

REAR

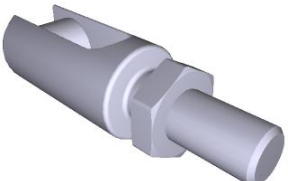



COMPONENT			SPARE PART																																																																		
Code	Description	Image	Code	Description	Components list																																																																
CR1040A	DOOR LATCH FOR EL.MECH. LOCKING SYSTEM		KCR1040A	LM MATIC DOOR LOCKING PIN KIT	<table border="1"> <thead> <tr> <th>Code</th> <th>Description</th> <th>Qty</th> <th>UOM</th> </tr> </thead> <tbody> <tr> <td>CR1040A0</td> <td>DOOR LATCH FOR EL.MECH. LOCKING SYSTEM</td> <td>1</td> <td>PZ</td> </tr> <tr> <td>VM1224A0</td> <td>65MY 220MM 2 COLOURS SHRINK TUBE</td> <td>0.150</td> <td>M</td> </tr> </tbody> </table>	Code	Description	Qty	UOM	CR1040A0	DOOR LATCH FOR EL.MECH. LOCKING SYSTEM	1	PZ	VM1224A0	65MY 220MM 2 COLOURS SHRINK TUBE	0.150	M																																																				
Code	Description	Qty	UOM																																																																		
CR1040A0	DOOR LATCH FOR EL.MECH. LOCKING SYSTEM	1	PZ																																																																		
VM1224A0	65MY 220MM 2 COLOURS SHRINK TUBE	0.150	M																																																																		
VM2274A	GROOVED BUSHING		KVM2274A K0B1126AR	GROOVED PIN BUSHING KIT BAKERTOP MM RIGHT DOOR LOWER BEAM KIT	<table border="1"> <thead> <tr> <th>Code</th> <th>Description</th> <th>Qty</th> <th>UOM</th> </tr> </thead> <tbody> <tr> <td>VM1224A0</td> <td>65MY 220MM 2 COLOURS SHRINK TUBE</td> <td>0.150</td> <td>M</td> </tr> <tr> <td>VM2274A0</td> <td>GROOVED BUSHING</td> <td>1</td> <td>PZ</td> </tr> <tr> <td>OB1126A0</td> <td>DOOR LOWER FRAME SHAPE 860 MM</td> <td>1</td> <td>PZ</td> </tr> <tr> <td>OB1126A1</td> <td></td> <td>1</td> <td>PZ</td> </tr> <tr> <td>RC1200A0</td> <td>ED=4 WIRE D.=0.5 COMPRESSIO N SPRING</td> <td>2</td> <td>PZ</td> </tr> <tr> <td>VI1220A1</td> <td>4,2X12 TCB SELF-TAPPIN G SCREW</td> <td>1</td> <td>PZ</td> </tr> <tr> <td>VI1996A0</td> <td>M5X35 SCREW</td> <td>7</td> <td>PZ</td> </tr> <tr> <td>VM1794A0</td> <td>250X4.8 PA66 BLACK CLAMP</td> <td>2</td> <td>PZ</td> </tr> <tr> <td>VM2103A0</td> <td>CLAMP LOCK</td> <td>2</td> <td>PZ</td> </tr> <tr> <td>VM2259A1</td> <td>6 SERIES DOOR LOWER LEFT CAP</td> <td>1</td> <td>PZ</td> </tr> <tr> <td>VM2261A1</td> <td>6 SERIES DOOR LOWER RIGHT CAP</td> <td>1</td> <td>PZ</td> </tr> <tr> <td>VM2267A0</td> <td>INTERNAL GLASS LOCKING SYSTEM SLIDER</td> <td>1</td> <td>PZ</td> </tr> <tr> <td>VM2269A0</td> <td>INTERNAL GLASS LOCKING SYSTEM CAP</td> <td>1</td> <td>PZ</td> </tr> <tr> <td>VM2274A0</td> <td>GROOVED BUSHING</td> <td>1</td> <td>PZ</td> </tr> <tr> <td>VM2305A0</td> <td>6 SERIES DOOR CAP FIXING PAWL</td> <td>7</td> <td>PZ</td> </tr> </tbody> </table>	Code	Description	Qty	UOM	VM1224A0	65MY 220MM 2 COLOURS SHRINK TUBE	0.150	M	VM2274A0	GROOVED BUSHING	1	PZ	OB1126A0	DOOR LOWER FRAME SHAPE 860 MM	1	PZ	OB1126A1		1	PZ	RC1200A0	ED=4 WIRE D.=0.5 COMPRESSIO N SPRING	2	PZ	VI1220A1	4,2X12 TCB SELF-TAPPIN G SCREW	1	PZ	VI1996A0	M5X35 SCREW	7	PZ	VM1794A0	250X4.8 PA66 BLACK CLAMP	2	PZ	VM2103A0	CLAMP LOCK	2	PZ	VM2259A1	6 SERIES DOOR LOWER LEFT CAP	1	PZ	VM2261A1	6 SERIES DOOR LOWER RIGHT CAP	1	PZ	VM2267A0	INTERNAL GLASS LOCKING SYSTEM SLIDER	1	PZ	VM2269A0	INTERNAL GLASS LOCKING SYSTEM CAP	1	PZ	VM2274A0	GROOVED BUSHING	1	PZ	VM2305A0	6 SERIES DOOR CAP FIXING PAWL	7	PZ
Code	Description	Qty	UOM																																																																		
VM1224A0	65MY 220MM 2 COLOURS SHRINK TUBE	0.150	M																																																																		
VM2274A0	GROOVED BUSHING	1	PZ																																																																		
OB1126A0	DOOR LOWER FRAME SHAPE 860 MM	1	PZ																																																																		
OB1126A1		1	PZ																																																																		
RC1200A0	ED=4 WIRE D.=0.5 COMPRESSIO N SPRING	2	PZ																																																																		
VI1220A1	4,2X12 TCB SELF-TAPPIN G SCREW	1	PZ																																																																		
VI1996A0	M5X35 SCREW	7	PZ																																																																		
VM1794A0	250X4.8 PA66 BLACK CLAMP	2	PZ																																																																		
VM2103A0	CLAMP LOCK	2	PZ																																																																		
VM2259A1	6 SERIES DOOR LOWER LEFT CAP	1	PZ																																																																		
VM2261A1	6 SERIES DOOR LOWER RIGHT CAP	1	PZ																																																																		
VM2267A0	INTERNAL GLASS LOCKING SYSTEM SLIDER	1	PZ																																																																		
VM2269A0	INTERNAL GLASS LOCKING SYSTEM CAP	1	PZ																																																																		
VM2274A0	GROOVED BUSHING	1	PZ																																																																		
VM2305A0	6 SERIES DOOR CAP FIXING PAWL	7	PZ																																																																		

COMPONENT			SPARE PART																																																																																					
Code	Description	Image	Code	Description	Components list																																																																																			
VM2274A	GROOVED BUSHING		K0B1126AL	EU AND 2/1 MM LEFT DOOR LOWER BEAM KIT	<table border="1"> <thead> <tr> <th>Code</th> <th>Description</th> <th>Qty</th> <th>UOM</th> </tr> </thead> <tbody> <tr> <td>0B1126A0</td> <td>DOOR LOWER FRAME SHAPE 860 MM</td> <td>1</td> <td>PZ</td> </tr> <tr> <td>0B1126A1</td> <td></td> <td>1</td> <td>PZ</td> </tr> <tr> <td>RC1200A0</td> <td>ED=4 WIRE D.=0.5 COMPRESSIO N SPRING</td> <td>2</td> <td>PZ</td> </tr> <tr> <td>VI1220A1</td> <td>4,2X12 TCB SELF-TAPPIN G SCREW</td> <td>1</td> <td>PZ</td> </tr> <tr> <td>VI1996A0</td> <td>M5X35 SCREW</td> <td>7</td> <td>PZ</td> </tr> <tr> <td>VM1794A0</td> <td>250X4.8 PA66 BLACK CLAMP</td> <td>2</td> <td>PZ</td> </tr> <tr> <td>VM2103A0</td> <td>CLAMP LOCK</td> <td>2</td> <td>PZ</td> </tr> <tr> <td>VM2267A0</td> <td>INTERNAL GLASS LOCKING SYSTEM SLIDER</td> <td>1</td> <td>PZ</td> </tr> <tr> <td>VM2269A0</td> <td>INTERNAL GLASS LOCKING SYSTEM CAP</td> <td>1</td> <td>PZ</td> </tr> <tr> <td>VM2274A0</td> <td>GROOVED BUSHING</td> <td>1</td> <td>PZ</td> </tr> <tr> <td>VM2305A0</td> <td>6 SERIES DOOR CAP FIXING PAWL</td> <td>7</td> <td>PZ</td> </tr> <tr> <td>VM2384A0</td> <td>MM LEFT DOOR RIGHT LOWER CAP</td> <td>1</td> <td>PZ</td> </tr> <tr> <td>VM2384A0</td> <td>MM LEFT DOOR RIGHT LOWER CAP</td> <td>1</td> <td>PZ</td> </tr> <tr> <td>VM2386A1</td> <td>LEFT MM DOOR LOWER LEFT CAP</td> <td>1</td> <td>PZ</td> </tr> <tr> <td>VM2386A1</td> <td>LEFT MM DOOR LOWER LEFT CAP</td> <td>1</td> <td>PZ</td> </tr> </tbody> </table>	Code	Description	Qty	UOM	0B1126A0	DOOR LOWER FRAME SHAPE 860 MM	1	PZ	0B1126A1		1	PZ	RC1200A0	ED=4 WIRE D.=0.5 COMPRESSIO N SPRING	2	PZ	VI1220A1	4,2X12 TCB SELF-TAPPIN G SCREW	1	PZ	VI1996A0	M5X35 SCREW	7	PZ	VM1794A0	250X4.8 PA66 BLACK CLAMP	2	PZ	VM2103A0	CLAMP LOCK	2	PZ	VM2267A0	INTERNAL GLASS LOCKING SYSTEM SLIDER	1	PZ	VM2269A0	INTERNAL GLASS LOCKING SYSTEM CAP	1	PZ	VM2274A0	GROOVED BUSHING	1	PZ	VM2305A0	6 SERIES DOOR CAP FIXING PAWL	7	PZ	VM2384A0	MM LEFT DOOR RIGHT LOWER CAP	1	PZ	VM2384A0	MM LEFT DOOR RIGHT LOWER CAP	1	PZ	VM2386A1	LEFT MM DOOR LOWER LEFT CAP	1	PZ	VM2386A1	LEFT MM DOOR LOWER LEFT CAP	1	PZ	K0B1122AR	CHEFTOP MM RIGHT DOOR LOWER BEAM KIT	<table border="1"> <thead> <tr> <th>Code</th> <th>Description</th> <th>Qty</th> <th>UOM</th> </tr> </thead> <tbody> <tr> <td>0B1122A0</td> <td>750MM DOOR LOWER FRAME SHAPE</td> <td>1</td> <td>PZ</td> </tr> <tr> <td>0B1122A1</td> <td>750MM DOOR LOWER FRAME SHAPE</td> <td>1</td> <td>PZ</td> </tr> <tr> <td>RC1200A0</td> <td>ED=4 WIRE D.=0.5 COMPRESSIO N SPRING</td> <td>2</td> <td>PZ</td> </tr> </tbody> </table>	Code	Description	Qty	UOM	0B1122A0	750MM DOOR LOWER FRAME SHAPE	1	PZ	0B1122A1	750MM DOOR LOWER FRAME SHAPE	1	PZ	RC1200A0	ED=4 WIRE D.=0.5 COMPRESSIO N SPRING	2	PZ
			Code	Description	Qty	UOM																																																																																		
0B1126A0	DOOR LOWER FRAME SHAPE 860 MM	1	PZ																																																																																					
0B1126A1		1	PZ																																																																																					
RC1200A0	ED=4 WIRE D.=0.5 COMPRESSIO N SPRING	2	PZ																																																																																					
VI1220A1	4,2X12 TCB SELF-TAPPIN G SCREW	1	PZ																																																																																					
VI1996A0	M5X35 SCREW	7	PZ																																																																																					
VM1794A0	250X4.8 PA66 BLACK CLAMP	2	PZ																																																																																					
VM2103A0	CLAMP LOCK	2	PZ																																																																																					
VM2267A0	INTERNAL GLASS LOCKING SYSTEM SLIDER	1	PZ																																																																																					
VM2269A0	INTERNAL GLASS LOCKING SYSTEM CAP	1	PZ																																																																																					
VM2274A0	GROOVED BUSHING	1	PZ																																																																																					
VM2305A0	6 SERIES DOOR CAP FIXING PAWL	7	PZ																																																																																					
VM2384A0	MM LEFT DOOR RIGHT LOWER CAP	1	PZ																																																																																					
VM2384A0	MM LEFT DOOR RIGHT LOWER CAP	1	PZ																																																																																					
VM2386A1	LEFT MM DOOR LOWER LEFT CAP	1	PZ																																																																																					
VM2386A1	LEFT MM DOOR LOWER LEFT CAP	1	PZ																																																																																					
Code	Description	Qty	UOM																																																																																					
0B1122A0	750MM DOOR LOWER FRAME SHAPE	1	PZ																																																																																					
0B1122A1	750MM DOOR LOWER FRAME SHAPE	1	PZ																																																																																					
RC1200A0	ED=4 WIRE D.=0.5 COMPRESSIO N SPRING	2	PZ																																																																																					



COMPONENT			SPARE PART																																														
Code	Description	Image	Code	Description	Components list																																												
VM2274A	GROOVED BUSHING		K0B1122AR	CHEFTOP MM RIGHT DOOR LOWER BEAM KIT	<table border="1"> <thead> <tr> <th>Code</th> <th>Description</th> <th>Qty</th> <th>UOM</th> </tr> </thead> <tbody> <tr> <td>VI1220A1</td> <td>4,2X12 TCB SELF-TAPPIN G SCREW</td> <td>1</td> <td>PZ</td> </tr> <tr> <td>VI1996A0</td> <td>M5X35 SCREW</td> <td>7</td> <td>PZ</td> </tr> <tr> <td>VM1794A0</td> <td>250X4.8 PA66 BLACK CLAMP</td> <td>2</td> <td>PZ</td> </tr> <tr> <td>VM2103A0</td> <td>CLAMP LOCK</td> <td>2</td> <td>PZ</td> </tr> <tr> <td>VM2259A1</td> <td>6 SERIES DOOR LOWER LEFT CAP</td> <td>1</td> <td>PZ</td> </tr> <tr> <td>VM2261A1</td> <td>6 SERIES DOOR LOWER RIGHT CAP</td> <td>1</td> <td>PZ</td> </tr> <tr> <td>VM2267A0</td> <td>INTERNAL GLASS LOCKING SYSTEM SLIDER</td> <td>1</td> <td>PZ</td> </tr> <tr> <td>VM2269A0</td> <td>INTERNAL GLASS LOCKING SYSTEM CAP</td> <td>1</td> <td>PZ</td> </tr> <tr> <td>VM2274A0</td> <td>GROOVED BUSHING</td> <td>1</td> <td>PZ</td> </tr> <tr> <td>VM2305A0</td> <td>6 SERIES DOOR CAP FIXING PAWL</td> <td>7</td> <td>PZ</td> </tr> </tbody> </table>	Code	Description	Qty	UOM	VI1220A1	4,2X12 TCB SELF-TAPPIN G SCREW	1	PZ	VI1996A0	M5X35 SCREW	7	PZ	VM1794A0	250X4.8 PA66 BLACK CLAMP	2	PZ	VM2103A0	CLAMP LOCK	2	PZ	VM2259A1	6 SERIES DOOR LOWER LEFT CAP	1	PZ	VM2261A1	6 SERIES DOOR LOWER RIGHT CAP	1	PZ	VM2267A0	INTERNAL GLASS LOCKING SYSTEM SLIDER	1	PZ	VM2269A0	INTERNAL GLASS LOCKING SYSTEM CAP	1	PZ	VM2274A0	GROOVED BUSHING	1	PZ	VM2305A0	6 SERIES DOOR CAP FIXING PAWL	7	PZ
			Code	Description	Qty	UOM																																											
VI1220A1	4,2X12 TCB SELF-TAPPIN G SCREW	1	PZ																																														
VI1996A0	M5X35 SCREW	7	PZ																																														
VM1794A0	250X4.8 PA66 BLACK CLAMP	2	PZ																																														
VM2103A0	CLAMP LOCK	2	PZ																																														
VM2259A1	6 SERIES DOOR LOWER LEFT CAP	1	PZ																																														
VM2261A1	6 SERIES DOOR LOWER RIGHT CAP	1	PZ																																														
VM2267A0	INTERNAL GLASS LOCKING SYSTEM SLIDER	1	PZ																																														
VM2269A0	INTERNAL GLASS LOCKING SYSTEM CAP	1	PZ																																														
VM2274A0	GROOVED BUSHING	1	PZ																																														
VM2305A0	6 SERIES DOOR CAP FIXING PAWL	7	PZ																																														
K0B1122AL	CHEFTOP MM LEFT DOOR LOWER BEAM KIT	<table border="1"> <thead> <tr> <th>Code</th> <th>Description</th> <th>Qty</th> <th>UOM</th> </tr> </thead> <tbody> <tr> <td>0B1122A0</td> <td>750MM DOOR LOWER FRAME SHAPE</td> <td>1</td> <td>PZ</td> </tr> <tr> <td>0B1122A1</td> <td>750MM DOOR LOWER FRAME SHAPE</td> <td>1</td> <td>PZ</td> </tr> <tr> <td>RC1200A0</td> <td>ED=4 WIRE D.=0.5 COMPRESSIO N SPRING</td> <td>2</td> <td>PZ</td> </tr> <tr> <td>VI1220A1</td> <td>4,2X12 TCB SELF-TAPPIN G SCREW</td> <td>1</td> <td>PZ</td> </tr> <tr> <td>VI1996A0</td> <td>M5X35 SCREW</td> <td>7</td> <td>PZ</td> </tr> <tr> <td>VM1794A0</td> <td>250X4.8 PA66 BLACK CLAMP</td> <td>2</td> <td>PZ</td> </tr> <tr> <td>VM2103A0</td> <td>CLAMP LOCK</td> <td>2</td> <td>PZ</td> </tr> <tr> <td>VM2267A0</td> <td>INTERNAL GLASS LOCKING SYSTEM SLIDER</td> <td>1</td> <td>PZ</td> </tr> <tr> <td>VM2269A0</td> <td>INTERNAL GLASS LOCKING SYSTEM CAP</td> <td>1</td> <td>PZ</td> </tr> </tbody> </table>	Code	Description	Qty	UOM	0B1122A0	750MM DOOR LOWER FRAME SHAPE	1	PZ	0B1122A1	750MM DOOR LOWER FRAME SHAPE	1	PZ	RC1200A0	ED=4 WIRE D.=0.5 COMPRESSIO N SPRING	2	PZ	VI1220A1	4,2X12 TCB SELF-TAPPIN G SCREW	1	PZ	VI1996A0	M5X35 SCREW	7	PZ	VM1794A0	250X4.8 PA66 BLACK CLAMP	2	PZ	VM2103A0	CLAMP LOCK	2	PZ	VM2267A0	INTERNAL GLASS LOCKING SYSTEM SLIDER	1	PZ	VM2269A0	INTERNAL GLASS LOCKING SYSTEM CAP	1	PZ							
Code	Description	Qty	UOM																																														
0B1122A0	750MM DOOR LOWER FRAME SHAPE	1	PZ																																														
0B1122A1	750MM DOOR LOWER FRAME SHAPE	1	PZ																																														
RC1200A0	ED=4 WIRE D.=0.5 COMPRESSIO N SPRING	2	PZ																																														
VI1220A1	4,2X12 TCB SELF-TAPPIN G SCREW	1	PZ																																														
VI1996A0	M5X35 SCREW	7	PZ																																														
VM1794A0	250X4.8 PA66 BLACK CLAMP	2	PZ																																														
VM2103A0	CLAMP LOCK	2	PZ																																														
VM2267A0	INTERNAL GLASS LOCKING SYSTEM SLIDER	1	PZ																																														
VM2269A0	INTERNAL GLASS LOCKING SYSTEM CAP	1	PZ																																														

COMPONENT			SPARE PART																														
Code	Description	Image	Code	Description	Components list																												
VM2274A	GROOVED BUSHING		K0B1122AL	CHEFTOP MM LEFT DOOR LOWER BEAM KIT	<table border="1"> <thead> <tr> <th>Code</th> <th>Description</th> <th>Qty</th> <th>UOM</th> </tr> </thead> <tbody> <tr> <td>VM2274A0</td> <td>GROOVED BUSHING</td> <td>1</td> <td>PZ</td> </tr> <tr> <td>VM2305A0</td> <td>6 SERIES DOOR CAP FIXING PAWL</td> <td>7</td> <td>PZ</td> </tr> <tr> <td>VM2384A0</td> <td>MM LEFT DOOR RIGHT LOWER CAP</td> <td>1</td> <td>PZ</td> </tr> <tr> <td>VM2384A0</td> <td>MM LEFT DOOR RIGHT LOWER CAP</td> <td>1</td> <td>PZ</td> </tr> <tr> <td>VM2386A1</td> <td>LEFT MM DOOR LOWER LEFT CAP</td> <td>1</td> <td>PZ</td> </tr> <tr> <td>VM2386A1</td> <td>LEFT MM DOOR LOWER LEFT CAP</td> <td>1</td> <td>PZ</td> </tr> </tbody> </table>	Code	Description	Qty	UOM	VM2274A0	GROOVED BUSHING	1	PZ	VM2305A0	6 SERIES DOOR CAP FIXING PAWL	7	PZ	VM2384A0	MM LEFT DOOR RIGHT LOWER CAP	1	PZ	VM2384A0	MM LEFT DOOR RIGHT LOWER CAP	1	PZ	VM2386A1	LEFT MM DOOR LOWER LEFT CAP	1	PZ	VM2386A1	LEFT MM DOOR LOWER LEFT CAP	1	PZ
Code	Description	Qty	UOM																														
VM2274A0	GROOVED BUSHING	1	PZ																														
VM2305A0	6 SERIES DOOR CAP FIXING PAWL	7	PZ																														
VM2384A0	MM LEFT DOOR RIGHT LOWER CAP	1	PZ																														
VM2384A0	MM LEFT DOOR RIGHT LOWER CAP	1	PZ																														
VM2386A1	LEFT MM DOOR LOWER LEFT CAP	1	PZ																														
VM2386A1	LEFT MM DOOR LOWER LEFT CAP	1	PZ																														
VM2275A	SMOOTH BUSHING		KVM2275A	SMOOTH PIN BUSHING KIT	<table border="1"> <thead> <tr> <th>Code</th> <th>Description</th> <th>Qty</th> <th>UOM</th> </tr> </thead> <tbody> <tr> <td>VM1224A0</td> <td>65MY 220MM 2 COLOURS SHRINK TUBE</td> <td>0.150</td> <td>M</td> </tr> <tr> <td>VM2275A0</td> <td>SMOOTH BUSHING</td> <td>1</td> <td>PZ</td> </tr> </tbody> </table>	Code	Description	Qty	UOM	VM1224A0	65MY 220MM 2 COLOURS SHRINK TUBE	0.150	M	VM2275A0	SMOOTH BUSHING	1	PZ																
Code	Description	Qty	UOM																														
VM1224A0	65MY 220MM 2 COLOURS SHRINK TUBE	0.150	M																														
VM2275A0	SMOOTH BUSHING	1	PZ																														
CE1285A	EMI ROUND FERRITE MOD.2643801502		CE1285A0	EMI ROUND FERRITE MOD.2643801502																													
LP1050A	BL SHOP.PRO L180 COMPLETE LED BA		KLP1050A	BAKERLUX SHOP.PRO L180 LED BAR KIT	<table border="1"> <thead> <tr> <th>Code</th> <th>Description</th> <th>Qty</th> <th>UOM</th> </tr> </thead> <tbody> <tr> <td>IP1385A1</td> <td>CORNER POLYSTYREN E PACKING 110X80X2000</td> <td>0.300</td> <td>M</td> </tr> <tr> <td>LP1050A0</td> <td>BL SHOP.PRO L180 COMPLETE LED BAR</td> <td>1</td> <td>PZ</td> </tr> <tr> <td>VI1014A0</td> <td>STAINLESS STEEL WASHER 4.5X9X0.8</td> <td>1</td> <td>PZ</td> </tr> <tr> <td>VI1220A1</td> <td>4,2X12 TCB SELF-TAPPING SCREW</td> <td>1</td> <td>PZ</td> </tr> <tr> <td>VM1059A1</td> <td>HEAT SHRINK FILM H800</td> <td>0.300</td> <td>M</td> </tr> </tbody> </table>	Code	Description	Qty	UOM	IP1385A1	CORNER POLYSTYREN E PACKING 110X80X2000	0.300	M	LP1050A0	BL SHOP.PRO L180 COMPLETE LED BAR	1	PZ	VI1014A0	STAINLESS STEEL WASHER 4.5X9X0.8	1	PZ	VI1220A1	4,2X12 TCB SELF-TAPPING SCREW	1	PZ	VM1059A1	HEAT SHRINK FILM H800	0.300	M				
Code	Description	Qty	UOM																														
IP1385A1	CORNER POLYSTYREN E PACKING 110X80X2000	0.300	M																														
LP1050A0	BL SHOP.PRO L180 COMPLETE LED BAR	1	PZ																														
VI1014A0	STAINLESS STEEL WASHER 4.5X9X0.8	1	PZ																														
VI1220A1	4,2X12 TCB SELF-TAPPING SCREW	1	PZ																														
VM1059A1	HEAT SHRINK FILM H800	0.300	M																														

COMPONENT			SPARE PART																														
Code	Description	Image	Code	Description	Components list																												
CE1095A	4 POLES MICROFIT 2 M BUS CABLE		KCE1095A	4POLES 2M BUS CABLE KIT POWER-CONTROL	<table border="1"> <thead> <tr> <th>Code</th> <th>Description</th> <th>Qty</th> <th>UOM</th> </tr> </thead> <tbody> <tr> <td>CE1095A0</td> <td>4 POLES MICROFIT 2 M BUS CABLE</td> <td>1</td> <td>PZ</td> </tr> <tr> <td>VM1224A0</td> <td>65MY 220MM 2 COLOURS SHRINK TUBE</td> <td>0.250</td> <td>M</td> </tr> </tbody> </table>	Code	Description	Qty	UOM	CE1095A0	4 POLES MICROFIT 2 M BUS CABLE	1	PZ	VM1224A0	65MY 220MM 2 COLOURS SHRINK TUBE	0.250	M																
Code	Description	Qty	UOM																														
CE1095A0	4 POLES MICROFIT 2 M BUS CABLE	1	PZ																														
VM1224A0	65MY 220MM 2 COLOURS SHRINK TUBE	0.250	M																														
VM2479A	BL SP GLASS H6 PUSHING BRACKET		KVM2479A	BL SHOP.PRO H6 GLASS SUPPORT 6 PCS KIT	<table border="1"> <thead> <tr> <th>Code</th> <th>Description</th> <th>Qty</th> <th>UOM</th> </tr> </thead> <tbody> <tr> <td>VM1224A0</td> <td>65MY 220MM 2 COLOURS SHRINK TUBE</td> <td>0.200</td> <td>M</td> </tr> <tr> <td>VM1630A0</td> <td>INTERNAL GLASS PUSHING CAP</td> <td>6</td> <td>PZ</td> </tr> <tr> <td>VM1630A1</td> <td>INTERNAL GLASS PUSHING CAP</td> <td>6</td> <td>PZ</td> </tr> <tr> <td>VM2479A0</td> <td>BL SP GLASS H6 PUSHING BRACKET</td> <td>6</td> <td>PZ</td> </tr> <tr> <td>VM2479A0</td> <td>BL SP GLASS H6 PUSHING BRACKET</td> <td>6</td> <td>PZ</td> </tr> </tbody> </table>	Code	Description	Qty	UOM	VM1224A0	65MY 220MM 2 COLOURS SHRINK TUBE	0.200	M	VM1630A0	INTERNAL GLASS PUSHING CAP	6	PZ	VM1630A1	INTERNAL GLASS PUSHING CAP	6	PZ	VM2479A0	BL SP GLASS H6 PUSHING BRACKET	6	PZ	VM2479A0	BL SP GLASS H6 PUSHING BRACKET	6	PZ				
Code	Description	Qty	UOM																														
VM1224A0	65MY 220MM 2 COLOURS SHRINK TUBE	0.200	M																														
VM1630A0	INTERNAL GLASS PUSHING CAP	6	PZ																														
VM1630A1	INTERNAL GLASS PUSHING CAP	6	PZ																														
VM2479A0	BL SP GLASS H6 PUSHING BRACKET	6	PZ																														
VM2479A0	BL SP GLASS H6 PUSHING BRACKET	6	PZ																														
VM1630A	INTERNAL GLASS PUSHING CAP		KVM1630A	CAP FOR INTERNAL GLASS 10 PCS KIT	<table border="1"> <thead> <tr> <th>Code</th> <th>Description</th> <th>Qty</th> <th>UOM</th> </tr> </thead> <tbody> <tr> <td>VM1224A0</td> <td>65MY 220MM 2 COLOURS SHRINK TUBE</td> <td>0.200</td> <td>M</td> </tr> <tr> <td>VM1630A0</td> <td>INTERNAL GLASS PUSHING CAP</td> <td>10</td> <td>PZ</td> </tr> <tr> <td>VM1630A1</td> <td>INTERNAL GLASS PUSHING CAP</td> <td>10</td> <td>PZ</td> </tr> </tbody> </table>	Code	Description	Qty	UOM	VM1224A0	65MY 220MM 2 COLOURS SHRINK TUBE	0.200	M	VM1630A0	INTERNAL GLASS PUSHING CAP	10	PZ	VM1630A1	INTERNAL GLASS PUSHING CAP	10	PZ												
Code	Description	Qty	UOM																														
VM1224A0	65MY 220MM 2 COLOURS SHRINK TUBE	0.200	M																														
VM1630A0	INTERNAL GLASS PUSHING CAP	10	PZ																														
VM1630A1	INTERNAL GLASS PUSHING CAP	10	PZ																														
VT1326A	SP ROSSELLA 557X439X4 EXTERNAL GLASS		KVT1326A	BL SHOP.PRO ROSSELLA EXTERNAL GLASS KIT	<table border="1"> <thead> <tr> <th>Code</th> <th>Description</th> <th>Qty</th> <th>UOM</th> </tr> </thead> <tbody> <tr> <td>0B0387A0</td> <td></td> <td>2</td> <td>PZ</td> </tr> <tr> <td>ED1240A0</td> <td>TECHNICAL DATA LABEL</td> <td>1</td> <td>PZ</td> </tr> <tr> <td>IP1385A1</td> <td>CORNER POLYSTYREN E PACKING 110X80X2000</td> <td>1</td> <td>M</td> </tr> <tr> <td>IP1508A1</td> <td>POLYSTYREN E U SHAPED PROFILE 2000X60X60</td> <td>1.200</td> <td>M</td> </tr> <tr> <td>SL1155A1</td> <td>LOCTITE BICOMPONEN T SILICON</td> <td>18</td> <td>ML</td> </tr> <tr> <td>VH1220A1</td> <td>4,2X12 TCB SELF-TAPPIN G SCREW</td> <td>6</td> <td>PZ</td> </tr> </tbody> </table>	Code	Description	Qty	UOM	0B0387A0		2	PZ	ED1240A0	TECHNICAL DATA LABEL	1	PZ	IP1385A1	CORNER POLYSTYREN E PACKING 110X80X2000	1	M	IP1508A1	POLYSTYREN E U SHAPED PROFILE 2000X60X60	1.200	M	SL1155A1	LOCTITE BICOMPONEN T SILICON	18	ML	VH1220A1	4,2X12 TCB SELF-TAPPIN G SCREW	6	PZ
Code	Description	Qty	UOM																														
0B0387A0		2	PZ																														
ED1240A0	TECHNICAL DATA LABEL	1	PZ																														
IP1385A1	CORNER POLYSTYREN E PACKING 110X80X2000	1	M																														
IP1508A1	POLYSTYREN E U SHAPED PROFILE 2000X60X60	1.200	M																														
SL1155A1	LOCTITE BICOMPONEN T SILICON	18	ML																														
VH1220A1	4,2X12 TCB SELF-TAPPIN G SCREW	6	PZ																														

COMPONENT			SPARE PART																																																															
Code	Description	Image	Code	Description	Components list																																																													
VT1326A	SP ROSSELLA 557X439X4 EXTERNAL GLASS		KVT1326A	BL SHOP.PRO ROSSELLA EXTERNAL GLASS KIT	<table border="1"> <thead> <tr> <th>Code</th> <th>Description</th> <th>Qty</th> <th>UOM</th> </tr> </thead> <tbody> <tr> <td>VM1059A1</td> <td>HEAT SHRINK FILM H800</td> <td>1.400</td> <td>M</td> </tr> <tr> <td>VT1326A1</td> <td>SP ROSSELLA 557X439X4 EXTERNAL GLASS</td> <td>1</td> <td>PZ</td> </tr> <tr> <td>VT1326A1</td> <td>SP ROSSELLA 557X439X4 EXTERNAL GLASS</td> <td>1</td> <td>PZ</td> </tr> </tbody> </table>	Code	Description	Qty	UOM	VM1059A1	HEAT SHRINK FILM H800	1.400	M	VT1326A1	SP ROSSELLA 557X439X4 EXTERNAL GLASS	1	PZ	VT1326A1	SP ROSSELLA 557X439X4 EXTERNAL GLASS	1	PZ																																													
			Code	Description	Qty	UOM																																																												
VM1059A1	HEAT SHRINK FILM H800	1.400	M																																																															
VT1326A1	SP ROSSELLA 557X439X4 EXTERNAL GLASS	1	PZ																																																															
VT1326A1	SP ROSSELLA 557X439X4 EXTERNAL GLASS	1	PZ																																																															
KDR1291A	BL SHOP.PRO ROSSELLA EXT LEFT DOOR KIT	<table border="1"> <thead> <tr> <th>Code</th> <th>Description</th> <th>Qty</th> <th>UOM</th> </tr> </thead> <tbody> <tr> <td>0B1297A0</td> <td></td> <td>1</td> <td>PZ</td> </tr> <tr> <td>0B1298A0</td> <td></td> <td>1</td> <td>PZ</td> </tr> <tr> <td>0B1299B0</td> <td></td> <td>1</td> <td>PZ</td> </tr> <tr> <td>0B1300A0</td> <td></td> <td>1</td> <td>PZ</td> </tr> <tr> <td>CE1095A0</td> <td>4 POLES MICROFIT 2 M BUS CABLE</td> <td>1</td> <td>PZ</td> </tr> <tr> <td>CE1285A0</td> <td>EMI ROUND FERRITE MOD.26438015 02</td> <td>1</td> <td>PZ</td> </tr> <tr> <td>CR1040A0</td> <td>DOOR LATCH FOR EL.MECH. LOCKING SYSTEM</td> <td>1</td> <td>PZ</td> </tr> <tr> <td>ED1240A0</td> <td>TECHNICAL DATA LABEL</td> <td>1</td> <td>PZ</td> </tr> <tr> <td>IP1325B0</td> <td>POLYSTYREN E CORNER PACKING D20</td> <td>0.800</td> <td>PZ</td> </tr> <tr> <td>IP1385A1</td> <td>CORNER POLYSTYREN E PACKING 110X80X2000</td> <td>0.400</td> <td>M</td> </tr> <tr> <td>IP1508A1</td> <td>POLYSTYREN E U SHAPED PROFILE 2000X60X60</td> <td>1.200</td> <td>M</td> </tr> <tr> <td>ML1005A0</td> <td>DE5 DF0.6 H18 COMPRESSIO N SPRING</td> <td>2</td> <td>PZ</td> </tr> <tr> <td>SL1155A1</td> <td>LOCTITE BICOMPONEN T SILICON</td> <td>18</td> <td>ML</td> </tr> <tr> <td>TB1563A0</td> <td>DOOR LATERAL BEAM SP800</td> <td>2</td> <td>PZ</td> </tr> <tr> <td>TB3304A0</td> <td>SHOP.PRO ARI-ROS FLAG DOOR HANDLE TUBE</td> <td>1</td> <td>PZ</td> </tr> </tbody> </table>	Code	Description	Qty	UOM	0B1297A0		1	PZ	0B1298A0		1	PZ	0B1299B0		1	PZ	0B1300A0		1	PZ	CE1095A0	4 POLES MICROFIT 2 M BUS CABLE	1	PZ	CE1285A0	EMI ROUND FERRITE MOD.26438015 02	1	PZ	CR1040A0	DOOR LATCH FOR EL.MECH. LOCKING SYSTEM	1	PZ	ED1240A0	TECHNICAL DATA LABEL	1	PZ	IP1325B0	POLYSTYREN E CORNER PACKING D20	0.800	PZ	IP1385A1	CORNER POLYSTYREN E PACKING 110X80X2000	0.400	M	IP1508A1	POLYSTYREN E U SHAPED PROFILE 2000X60X60	1.200	M	ML1005A0	DE5 DF0.6 H18 COMPRESSIO N SPRING	2	PZ	SL1155A1	LOCTITE BICOMPONEN T SILICON	18	ML	TB1563A0	DOOR LATERAL BEAM SP800	2	PZ	TB3304A0	SHOP.PRO ARI-ROS FLAG DOOR HANDLE TUBE	1	PZ
Code	Description	Qty	UOM																																																															
0B1297A0		1	PZ																																																															
0B1298A0		1	PZ																																																															
0B1299B0		1	PZ																																																															
0B1300A0		1	PZ																																																															
CE1095A0	4 POLES MICROFIT 2 M BUS CABLE	1	PZ																																																															
CE1285A0	EMI ROUND FERRITE MOD.26438015 02	1	PZ																																																															
CR1040A0	DOOR LATCH FOR EL.MECH. LOCKING SYSTEM	1	PZ																																																															
ED1240A0	TECHNICAL DATA LABEL	1	PZ																																																															
IP1325B0	POLYSTYREN E CORNER PACKING D20	0.800	PZ																																																															
IP1385A1	CORNER POLYSTYREN E PACKING 110X80X2000	0.400	M																																																															
IP1508A1	POLYSTYREN E U SHAPED PROFILE 2000X60X60	1.200	M																																																															
ML1005A0	DE5 DF0.6 H18 COMPRESSIO N SPRING	2	PZ																																																															
SL1155A1	LOCTITE BICOMPONEN T SILICON	18	ML																																																															
TB1563A0	DOOR LATERAL BEAM SP800	2	PZ																																																															
TB3304A0	SHOP.PRO ARI-ROS FLAG DOOR HANDLE TUBE	1	PZ																																																															





COMPONENT			SPARE PART																																																																						
Code	Description	Image	Code	Description	Components list																																																																				
VT1326A	SP ROSSELLA 557X439X4 EXTERNAL GLASS		KDR1291A	BL SHOP.PRO ROSSELLA EXT LEFT DOOR KIT	<table border="1"> <thead> <tr> <th>Code</th> <th>Description</th> <th>Qty</th> <th>UOM</th> </tr> </thead> <tbody> <tr> <td>VI1036A0</td> <td>ST STEEL STRIPED THREAD INSERT M10 FTT/C</td> <td>1</td> <td>PZ</td> </tr> <tr> <td>VI1220A1</td> <td>4,2X12 TCB SELF-TAPPIN G SCREW</td> <td>14</td> <td>PZ</td> </tr> <tr> <td>VI1930A0</td> <td>5X25 ST. STEEL SCREW CHIP</td> <td>22</td> <td>PZ</td> </tr> <tr> <td>VI1998A0</td> <td>ZINC PLATED SCREW 5X30 TCB</td> <td>2</td> <td>PZ</td> </tr> <tr> <td>VM1059A1</td> <td>HEAT SHRINK FILM H800</td> <td>1.200</td> <td>M</td> </tr> <tr> <td>VM1209A0</td> <td>SHOP.PRO LOCK PIN WASHER</td> <td>1</td> <td>PZ</td> </tr> <tr> <td>VM1630A0</td> <td>INTERNAL GLASS PUSHING CAP</td> <td>4</td> <td>PZ</td> </tr> <tr> <td>VM1630A1</td> <td>INTERNAL GLASS PUSHING CAP</td> <td>4</td> <td>PZ</td> </tr> <tr> <td>VM2274A0</td> <td>GROOVED BUSHING</td> <td>1</td> <td>PZ</td> </tr> <tr> <td>VM2275A0</td> <td>SMOOTH BUSHING</td> <td>1</td> <td>PZ</td> </tr> <tr> <td>VM2456A0</td> <td>BAKERLUX SHOP.PRO HANDLE END</td> <td>2</td> <td>PZ</td> </tr> <tr> <td>VM2456A0</td> <td>BAKERLUX SHOP.PRO HANDLE END</td> <td>2</td> <td>PZ</td> </tr> <tr> <td>VM2465A0</td> <td>SP SIDE-OPENIN G DOOR RIGHT LOWER CAP KIT</td> <td>1</td> <td>PZ</td> </tr> <tr> <td>VM2465A0</td> <td>SP SIDE-OPENIN G DOOR RIGHT LOWER CAP KIT</td> <td>1</td> <td>PZ</td> </tr> <tr> <td>VM2466A0</td> <td>BL SP LEFT LOWER LATERAL DOOR CAP</td> <td>1</td> <td>PZ</td> </tr> <tr> <td>VM2466A0</td> <td>BL SP LEFT LOWER LATERAL DOOR CAP</td> <td>1</td> <td>PZ</td> </tr> </tbody> </table>	Code	Description	Qty	UOM	VI1036A0	ST STEEL STRIPED THREAD INSERT M10 FTT/C	1	PZ	VI1220A1	4,2X12 TCB SELF-TAPPIN G SCREW	14	PZ	VI1930A0	5X25 ST. STEEL SCREW CHIP	22	PZ	VI1998A0	ZINC PLATED SCREW 5X30 TCB	2	PZ	VM1059A1	HEAT SHRINK FILM H800	1.200	M	VM1209A0	SHOP.PRO LOCK PIN WASHER	1	PZ	VM1630A0	INTERNAL GLASS PUSHING CAP	4	PZ	VM1630A1	INTERNAL GLASS PUSHING CAP	4	PZ	VM2274A0	GROOVED BUSHING	1	PZ	VM2275A0	SMOOTH BUSHING	1	PZ	VM2456A0	BAKERLUX SHOP.PRO HANDLE END	2	PZ	VM2456A0	BAKERLUX SHOP.PRO HANDLE END	2	PZ	VM2465A0	SP SIDE-OPENIN G DOOR RIGHT LOWER CAP KIT	1	PZ	VM2465A0	SP SIDE-OPENIN G DOOR RIGHT LOWER CAP KIT	1	PZ	VM2466A0	BL SP LEFT LOWER LATERAL DOOR CAP	1	PZ	VM2466A0	BL SP LEFT LOWER LATERAL DOOR CAP	1	PZ
Code	Description	Qty	UOM																																																																						
VI1036A0	ST STEEL STRIPED THREAD INSERT M10 FTT/C	1	PZ																																																																						
VI1220A1	4,2X12 TCB SELF-TAPPIN G SCREW	14	PZ																																																																						
VI1930A0	5X25 ST. STEEL SCREW CHIP	22	PZ																																																																						
VI1998A0	ZINC PLATED SCREW 5X30 TCB	2	PZ																																																																						
VM1059A1	HEAT SHRINK FILM H800	1.200	M																																																																						
VM1209A0	SHOP.PRO LOCK PIN WASHER	1	PZ																																																																						
VM1630A0	INTERNAL GLASS PUSHING CAP	4	PZ																																																																						
VM1630A1	INTERNAL GLASS PUSHING CAP	4	PZ																																																																						
VM2274A0	GROOVED BUSHING	1	PZ																																																																						
VM2275A0	SMOOTH BUSHING	1	PZ																																																																						
VM2456A0	BAKERLUX SHOP.PRO HANDLE END	2	PZ																																																																						
VM2456A0	BAKERLUX SHOP.PRO HANDLE END	2	PZ																																																																						
VM2465A0	SP SIDE-OPENIN G DOOR RIGHT LOWER CAP KIT	1	PZ																																																																						
VM2465A0	SP SIDE-OPENIN G DOOR RIGHT LOWER CAP KIT	1	PZ																																																																						
VM2466A0	BL SP LEFT LOWER LATERAL DOOR CAP	1	PZ																																																																						
VM2466A0	BL SP LEFT LOWER LATERAL DOOR CAP	1	PZ																																																																						





COMPONENT			SPARE PART																																																										
Code	Description	Image	Code	Description	Components list																																																								
VT1326A	SP ROSSELLA 557X439X4 EXTERNAL GLASS		KDR1291A	BL SHOP.PRO ROSSELLA EXT LEFT DOOR KIT	<table border="1"> <thead> <tr> <th>Code</th> <th>Description</th> <th>Qty</th> <th>UOM</th> </tr> </thead> <tbody> <tr> <td>VM2467A0</td> <td>SP SIDE-OPENIN G DOOR RIGHT UPPER CAP KIT</td> <td>1</td> <td>PZ</td> </tr> <tr> <td>VM2467A0</td> <td>SP SIDE-OPENIN G DOOR RIGHT UPPER CAP KIT</td> <td>1</td> <td>PZ</td> </tr> <tr> <td>VM2468A0</td> <td>BL SP LEFT UPPER LATERAL DOOR CAP</td> <td>1</td> <td>PZ</td> </tr> <tr> <td>VM2468A0</td> <td>BL SP LEFT UPPER LATERAL DOOR CAP</td> <td>1</td> <td>PZ</td> </tr> <tr> <td>VM2470A0</td> <td>SLIDE TO FIX INTERNAL GLASS SHOP.PRO</td> <td>2</td> <td>PZ</td> </tr> <tr> <td>VM2470A0</td> <td>SLIDE TO FIX INTERNAL GLASS SHOP.PRO</td> <td>2</td> <td>PZ</td> </tr> <tr> <td>VM2471A0</td> <td>BL SP LOWER CLAMP INT LOCK GLASS SLIDER</td> <td>1</td> <td>PZ</td> </tr> <tr> <td>VM2471A0</td> <td>BL SP LOWER CLAMP INT LOCK GLASS SLIDER</td> <td>1</td> <td>PZ</td> </tr> <tr> <td>VM2472A0</td> <td>BL SP UPPER CLAMP INT LOCK GLASS SLIDER</td> <td>1</td> <td>PZ</td> </tr> <tr> <td>VM2472A0</td> <td>BL SP UPPER CLAMP INT LOCK GLASS SLIDER</td> <td>1</td> <td>PZ</td> </tr> <tr> <td>VM2473A0</td> <td>BL SP INT GLASS HINGE LOWER LOCK PIN</td> <td>1</td> <td>PZ</td> </tr> <tr> <td>VM2473A0</td> <td>BL SP INT GLASS HINGE LOWER LOCK PIN</td> <td>1</td> <td>PZ</td> </tr> <tr> <td>VM2474A0</td> <td>BL SP INT GLASS HINGE UPPER LOCK PIN</td> <td>1</td> <td>PZ</td> </tr> </tbody> </table>	Code	Description	Qty	UOM	VM2467A0	SP SIDE-OPENIN G DOOR RIGHT UPPER CAP KIT	1	PZ	VM2467A0	SP SIDE-OPENIN G DOOR RIGHT UPPER CAP KIT	1	PZ	VM2468A0	BL SP LEFT UPPER LATERAL DOOR CAP	1	PZ	VM2468A0	BL SP LEFT UPPER LATERAL DOOR CAP	1	PZ	VM2470A0	SLIDE TO FIX INTERNAL GLASS SHOP.PRO	2	PZ	VM2470A0	SLIDE TO FIX INTERNAL GLASS SHOP.PRO	2	PZ	VM2471A0	BL SP LOWER CLAMP INT LOCK GLASS SLIDER	1	PZ	VM2471A0	BL SP LOWER CLAMP INT LOCK GLASS SLIDER	1	PZ	VM2472A0	BL SP UPPER CLAMP INT LOCK GLASS SLIDER	1	PZ	VM2472A0	BL SP UPPER CLAMP INT LOCK GLASS SLIDER	1	PZ	VM2473A0	BL SP INT GLASS HINGE LOWER LOCK PIN	1	PZ	VM2473A0	BL SP INT GLASS HINGE LOWER LOCK PIN	1	PZ	VM2474A0	BL SP INT GLASS HINGE UPPER LOCK PIN	1	PZ
Code	Description	Qty	UOM																																																										
VM2467A0	SP SIDE-OPENIN G DOOR RIGHT UPPER CAP KIT	1	PZ																																																										
VM2467A0	SP SIDE-OPENIN G DOOR RIGHT UPPER CAP KIT	1	PZ																																																										
VM2468A0	BL SP LEFT UPPER LATERAL DOOR CAP	1	PZ																																																										
VM2468A0	BL SP LEFT UPPER LATERAL DOOR CAP	1	PZ																																																										
VM2470A0	SLIDE TO FIX INTERNAL GLASS SHOP.PRO	2	PZ																																																										
VM2470A0	SLIDE TO FIX INTERNAL GLASS SHOP.PRO	2	PZ																																																										
VM2471A0	BL SP LOWER CLAMP INT LOCK GLASS SLIDER	1	PZ																																																										
VM2471A0	BL SP LOWER CLAMP INT LOCK GLASS SLIDER	1	PZ																																																										
VM2472A0	BL SP UPPER CLAMP INT LOCK GLASS SLIDER	1	PZ																																																										
VM2472A0	BL SP UPPER CLAMP INT LOCK GLASS SLIDER	1	PZ																																																										
VM2473A0	BL SP INT GLASS HINGE LOWER LOCK PIN	1	PZ																																																										
VM2473A0	BL SP INT GLASS HINGE LOWER LOCK PIN	1	PZ																																																										
VM2474A0	BL SP INT GLASS HINGE UPPER LOCK PIN	1	PZ																																																										

COMPONENT			SPARE PART																																														
Code	Description	Image	Code	Description	Components list																																												
VT1326A	SP ROSSELLA 557X439X4 EXTERNAL GLASS		KDR1291A	BL SHOP.PRO ROSSELLA EXT LEFT DOOR KIT	<table border="1"> <thead> <tr> <th>Code</th> <th>Description</th> <th>Qty</th> <th>UOM</th> </tr> </thead> <tbody> <tr> <td>VM2474A0</td> <td>BL SP INT GLASS HINGE UPPER LOCK PIN</td> <td>1</td> <td>PZ</td> </tr> <tr> <td>VM2479A0</td> <td>BL SP GLASS H6 PUSHING BRACKET</td> <td>4</td> <td>PZ</td> </tr> <tr> <td>VM2479A0</td> <td>BL SP GLASS H6 PUSHING BRACKET</td> <td>4</td> <td>PZ</td> </tr> <tr> <td>VM2489A0</td> <td>SP HANDLE END KIT + STYLUS KIT</td> <td>1</td> <td>PZ</td> </tr> <tr> <td>VM2504A0</td> <td>DOWEL TO GUIDE SLIDE SPRING SHOP.PRO</td> <td>2</td> <td>PZ</td> </tr> <tr> <td>VM2504A0</td> <td>DOWEL TO GUIDE SLIDE SPRING SHOP.PRO</td> <td>2</td> <td>PZ</td> </tr> <tr> <td>VM2527A0</td> <td>STYLUS PEN FOR SP</td> <td>1</td> <td>PZ</td> </tr> <tr> <td>VT1326A1</td> <td>SP ROSSELLA 557X439X4 EXTERNAL GLASS</td> <td></td> <td></td> <td>1</td> <td>PZ</td> </tr> <tr> <td>VT1326A1</td> <td>SP ROSSELLA 557X439X4 EXTERNAL GLASS</td> <td></td> <td></td> <td>1</td> <td>PZ</td> </tr> </tbody> </table>	Code	Description	Qty	UOM	VM2474A0	BL SP INT GLASS HINGE UPPER LOCK PIN	1	PZ	VM2479A0	BL SP GLASS H6 PUSHING BRACKET	4	PZ	VM2479A0	BL SP GLASS H6 PUSHING BRACKET	4	PZ	VM2489A0	SP HANDLE END KIT + STYLUS KIT	1	PZ	VM2504A0	DOWEL TO GUIDE SLIDE SPRING SHOP.PRO	2	PZ	VM2504A0	DOWEL TO GUIDE SLIDE SPRING SHOP.PRO	2	PZ	VM2527A0	STYLUS PEN FOR SP	1	PZ	VT1326A1	SP ROSSELLA 557X439X4 EXTERNAL GLASS			1	PZ	VT1326A1	SP ROSSELLA 557X439X4 EXTERNAL GLASS			1	PZ
			Code	Description	Qty	UOM																																											
VM2474A0	BL SP INT GLASS HINGE UPPER LOCK PIN	1	PZ																																														
VM2479A0	BL SP GLASS H6 PUSHING BRACKET	4	PZ																																														
VM2479A0	BL SP GLASS H6 PUSHING BRACKET	4	PZ																																														
VM2489A0	SP HANDLE END KIT + STYLUS KIT	1	PZ																																														
VM2504A0	DOWEL TO GUIDE SLIDE SPRING SHOP.PRO	2	PZ																																														
VM2504A0	DOWEL TO GUIDE SLIDE SPRING SHOP.PRO	2	PZ																																														
VM2527A0	STYLUS PEN FOR SP	1	PZ																																														
VT1326A1	SP ROSSELLA 557X439X4 EXTERNAL GLASS			1	PZ																																												
VT1326A1	SP ROSSELLA 557X439X4 EXTERNAL GLASS			1	PZ																																												
KDR1290A	BL SHOP.PRO ROSSELLA EXTERNAL DOOR KI	<table border="1"> <thead> <tr> <th>Code</th> <th>Description</th> <th>Qty</th> <th>UOM</th> </tr> </thead> <tbody> <tr> <td>0B1297A0</td> <td></td> <td>1</td> <td>PZ</td> </tr> <tr> <td>0B1298A0</td> <td></td> <td>1</td> <td>PZ</td> </tr> <tr> <td>0B1299B0</td> <td></td> <td>1</td> <td>PZ</td> </tr> <tr> <td>0B1300A0</td> <td></td> <td>1</td> <td>PZ</td> </tr> <tr> <td>CR1040A0</td> <td>DOOR LATCH FOR EL.MECH. LOCKING SYSTEM</td> <td>1</td> <td>PZ</td> </tr> <tr> <td>ED1240A0</td> <td>TECHNICAL DATA LABEL</td> <td>1</td> <td>PZ</td> </tr> <tr> <td>IP1325B0</td> <td>POLYSTYREN E CORNER PACKING D20</td> <td>0.800</td> <td>PZ</td> </tr> <tr> <td>IP1385A1</td> <td>CORNER POLYSTYREN E PACKING 110X80X2000</td> <td>0.400</td> <td>M</td> </tr> <tr> <td>IP1508A1</td> <td>POLYSTYREN E U SHAPED PROFILE 2000X60X60</td> <td>1.200</td> <td>M</td> </tr> </tbody> </table>	Code	Description	Qty	UOM	0B1297A0		1	PZ	0B1298A0		1	PZ	0B1299B0		1	PZ	0B1300A0		1	PZ	CR1040A0	DOOR LATCH FOR EL.MECH. LOCKING SYSTEM	1	PZ	ED1240A0	TECHNICAL DATA LABEL	1	PZ	IP1325B0	POLYSTYREN E CORNER PACKING D20	0.800	PZ	IP1385A1	CORNER POLYSTYREN E PACKING 110X80X2000	0.400	M	IP1508A1	POLYSTYREN E U SHAPED PROFILE 2000X60X60	1.200	M							
Code	Description	Qty	UOM																																														
0B1297A0		1	PZ																																														
0B1298A0		1	PZ																																														
0B1299B0		1	PZ																																														
0B1300A0		1	PZ																																														
CR1040A0	DOOR LATCH FOR EL.MECH. LOCKING SYSTEM	1	PZ																																														
ED1240A0	TECHNICAL DATA LABEL	1	PZ																																														
IP1325B0	POLYSTYREN E CORNER PACKING D20	0.800	PZ																																														
IP1385A1	CORNER POLYSTYREN E PACKING 110X80X2000	0.400	M																																														
IP1508A1	POLYSTYREN E U SHAPED PROFILE 2000X60X60	1.200	M																																														

COMPONENT			SPARE PART																																																																										
Code	Description	Image	Code	Description	Components list																																																																								
VT1326A	SP ROSSELLA 557X439X4 EXTERNAL GLASS		KDR1290A	BL SHOP.PRO ROSSELLA EXTERNAL DOOR KI	<table border="1"> <thead> <tr> <th>Code</th> <th>Description</th> <th>Qty</th> <th>UOM</th> </tr> </thead> <tbody> <tr> <td>ML1005A0</td> <td>DES DF0.6 H18 COMPRESSIO N SPRING</td> <td>2</td> <td>PZ</td> </tr> <tr> <td>SL1155A1</td> <td>LOCTITE BICOMPONEN T SILICON</td> <td>18</td> <td>ML</td> </tr> <tr> <td>TB1563A0</td> <td>DOOR LATERAL BEAM SP800</td> <td>2</td> <td>PZ</td> </tr> <tr> <td>TB3304A0</td> <td>SHOP.PRO ARI-ROS FLAG DOOR HANDLE TUBE</td> <td>1</td> <td>PZ</td> </tr> <tr> <td>VI1036A0</td> <td>ST STEEL STRIPED THREAD INSERT M10 FTT/C</td> <td>1</td> <td>PZ</td> </tr> <tr> <td>VI1220A1</td> <td>4,2X12 TCB SELF-TAPPIN G SCREW</td> <td>14</td> <td>PZ</td> </tr> <tr> <td>VI1930A0</td> <td>5X25 ST. STEEL SCREW CHIP</td> <td>22</td> <td>PZ</td> </tr> <tr> <td>VI1998A0</td> <td>ZINC PLATED SCREW 5X30 TCB</td> <td>2</td> <td>PZ</td> </tr> <tr> <td>VM1059A1</td> <td>HEAT SHRINK FILM H800</td> <td>1.200</td> <td>M</td> </tr> <tr> <td>VM1209A0</td> <td>SHOP.PRO LOCK PIN WASHER</td> <td>1</td> <td>PZ</td> </tr> <tr> <td>VM1630A0</td> <td>INTERNAL GLASS PUSHING CAP</td> <td>4</td> <td>PZ</td> </tr> <tr> <td>VM1630A1</td> <td>INTERNAL GLASS PUSHING CAP</td> <td>4</td> <td>PZ</td> </tr> <tr> <td>VM2274A0</td> <td>GROOVED BUSHING</td> <td>1</td> <td>PZ</td> </tr> <tr> <td>VM2275A0</td> <td>SMOOTH BUSHING</td> <td>1</td> <td>PZ</td> </tr> <tr> <td>VM2456A0</td> <td>BAKERLUX SHOP.PRO HANDLE END</td> <td>2</td> <td>PZ</td> </tr> <tr> <td>VM2456A0</td> <td>BAKERLUX SHOP.PRO HANDLE END</td> <td>2</td> <td>PZ</td> </tr> <tr> <td>VM2465A0</td> <td>SP SIDE-OPENIN G DOOR RIGHT LOWER CAP KIT</td> <td>1</td> <td>PZ</td> </tr> </tbody> </table>	Code	Description	Qty	UOM	ML1005A0	DES DF0.6 H18 COMPRESSIO N SPRING	2	PZ	SL1155A1	LOCTITE BICOMPONEN T SILICON	18	ML	TB1563A0	DOOR LATERAL BEAM SP800	2	PZ	TB3304A0	SHOP.PRO ARI-ROS FLAG DOOR HANDLE TUBE	1	PZ	VI1036A0	ST STEEL STRIPED THREAD INSERT M10 FTT/C	1	PZ	VI1220A1	4,2X12 TCB SELF-TAPPIN G SCREW	14	PZ	VI1930A0	5X25 ST. STEEL SCREW CHIP	22	PZ	VI1998A0	ZINC PLATED SCREW 5X30 TCB	2	PZ	VM1059A1	HEAT SHRINK FILM H800	1.200	M	VM1209A0	SHOP.PRO LOCK PIN WASHER	1	PZ	VM1630A0	INTERNAL GLASS PUSHING CAP	4	PZ	VM1630A1	INTERNAL GLASS PUSHING CAP	4	PZ	VM2274A0	GROOVED BUSHING	1	PZ	VM2275A0	SMOOTH BUSHING	1	PZ	VM2456A0	BAKERLUX SHOP.PRO HANDLE END	2	PZ	VM2456A0	BAKERLUX SHOP.PRO HANDLE END	2	PZ	VM2465A0	SP SIDE-OPENIN G DOOR RIGHT LOWER CAP KIT	1	PZ
Code	Description	Qty	UOM																																																																										
ML1005A0	DES DF0.6 H18 COMPRESSIO N SPRING	2	PZ																																																																										
SL1155A1	LOCTITE BICOMPONEN T SILICON	18	ML																																																																										
TB1563A0	DOOR LATERAL BEAM SP800	2	PZ																																																																										
TB3304A0	SHOP.PRO ARI-ROS FLAG DOOR HANDLE TUBE	1	PZ																																																																										
VI1036A0	ST STEEL STRIPED THREAD INSERT M10 FTT/C	1	PZ																																																																										
VI1220A1	4,2X12 TCB SELF-TAPPIN G SCREW	14	PZ																																																																										
VI1930A0	5X25 ST. STEEL SCREW CHIP	22	PZ																																																																										
VI1998A0	ZINC PLATED SCREW 5X30 TCB	2	PZ																																																																										
VM1059A1	HEAT SHRINK FILM H800	1.200	M																																																																										
VM1209A0	SHOP.PRO LOCK PIN WASHER	1	PZ																																																																										
VM1630A0	INTERNAL GLASS PUSHING CAP	4	PZ																																																																										
VM1630A1	INTERNAL GLASS PUSHING CAP	4	PZ																																																																										
VM2274A0	GROOVED BUSHING	1	PZ																																																																										
VM2275A0	SMOOTH BUSHING	1	PZ																																																																										
VM2456A0	BAKERLUX SHOP.PRO HANDLE END	2	PZ																																																																										
VM2456A0	BAKERLUX SHOP.PRO HANDLE END	2	PZ																																																																										
VM2465A0	SP SIDE-OPENIN G DOOR RIGHT LOWER CAP KIT	1	PZ																																																																										



COMPONENT			SPARE PART																																																										
Code	Description	Image	Code	Description	Components list																																																								
VT1326A	SP ROSSELLA 557X439X4 EXTERNAL GLASS		KDR1290A	BL SHOP.PRO ROSSELLA EXTERNAL DOOR KI	<table border="1"> <thead> <tr> <th>Code</th> <th>Description</th> <th>Qty</th> <th>UOM</th> </tr> </thead> <tbody> <tr> <td>VM2465A0</td> <td>SP SIDE-OPENIN G DOOR RIGHT LOWER CAP KIT</td> <td>1</td> <td>PZ</td> </tr> <tr> <td>VM2466A0</td> <td>BL SP LEFT LOWER LATERAL DOOR CAP</td> <td>1</td> <td>PZ</td> </tr> <tr> <td>VM2466A0</td> <td>BL SP LEFT LOWER LATERAL DOOR CAP</td> <td>1</td> <td>PZ</td> </tr> <tr> <td>VM2467A0</td> <td>SP SIDE-OPENIN G DOOR RIGHT UPPER CAP KIT</td> <td>1</td> <td>PZ</td> </tr> <tr> <td>VM2467A0</td> <td>SP SIDE-OPENIN G DOOR RIGHT UPPER CAP KIT</td> <td>1</td> <td>PZ</td> </tr> <tr> <td>VM2468A0</td> <td>BL SP LEFT UPPER LATERAL DOOR CAP</td> <td>1</td> <td>PZ</td> </tr> <tr> <td>VM2468A0</td> <td>BL SP LEFT UPPER LATERAL DOOR CAP</td> <td>1</td> <td>PZ</td> </tr> <tr> <td>VM2470A0</td> <td>SLIDE TO FIX INTERNAL GLASS SHOP.PRO</td> <td>2</td> <td>PZ</td> </tr> <tr> <td>VM2470A0</td> <td>SLIDE TO FIX INTERNAL GLASS SHOP.PRO</td> <td>2</td> <td>PZ</td> </tr> <tr> <td>VM2471A0</td> <td>BL SP LOWER CLAMP INT LOCK GLASS SLIDER</td> <td>1</td> <td>PZ</td> </tr> <tr> <td>VM2471A0</td> <td>BL SP LOWER CLAMP INT LOCK GLASS SLIDER</td> <td>1</td> <td>PZ</td> </tr> <tr> <td>VM2472A0</td> <td>BL SP UPPER CLAMP INT LOCK GLASS SLIDER</td> <td>1</td> <td>PZ</td> </tr> <tr> <td>VM2472A0</td> <td>BL SP UPPER CLAMP INT LOCK GLASS SLIDER</td> <td>1</td> <td>PZ</td> </tr> </tbody> </table>	Code	Description	Qty	UOM	VM2465A0	SP SIDE-OPENIN G DOOR RIGHT LOWER CAP KIT	1	PZ	VM2466A0	BL SP LEFT LOWER LATERAL DOOR CAP	1	PZ	VM2466A0	BL SP LEFT LOWER LATERAL DOOR CAP	1	PZ	VM2467A0	SP SIDE-OPENIN G DOOR RIGHT UPPER CAP KIT	1	PZ	VM2467A0	SP SIDE-OPENIN G DOOR RIGHT UPPER CAP KIT	1	PZ	VM2468A0	BL SP LEFT UPPER LATERAL DOOR CAP	1	PZ	VM2468A0	BL SP LEFT UPPER LATERAL DOOR CAP	1	PZ	VM2470A0	SLIDE TO FIX INTERNAL GLASS SHOP.PRO	2	PZ	VM2470A0	SLIDE TO FIX INTERNAL GLASS SHOP.PRO	2	PZ	VM2471A0	BL SP LOWER CLAMP INT LOCK GLASS SLIDER	1	PZ	VM2471A0	BL SP LOWER CLAMP INT LOCK GLASS SLIDER	1	PZ	VM2472A0	BL SP UPPER CLAMP INT LOCK GLASS SLIDER	1	PZ	VM2472A0	BL SP UPPER CLAMP INT LOCK GLASS SLIDER	1	PZ
Code	Description	Qty	UOM																																																										
VM2465A0	SP SIDE-OPENIN G DOOR RIGHT LOWER CAP KIT	1	PZ																																																										
VM2466A0	BL SP LEFT LOWER LATERAL DOOR CAP	1	PZ																																																										
VM2466A0	BL SP LEFT LOWER LATERAL DOOR CAP	1	PZ																																																										
VM2467A0	SP SIDE-OPENIN G DOOR RIGHT UPPER CAP KIT	1	PZ																																																										
VM2467A0	SP SIDE-OPENIN G DOOR RIGHT UPPER CAP KIT	1	PZ																																																										
VM2468A0	BL SP LEFT UPPER LATERAL DOOR CAP	1	PZ																																																										
VM2468A0	BL SP LEFT UPPER LATERAL DOOR CAP	1	PZ																																																										
VM2470A0	SLIDE TO FIX INTERNAL GLASS SHOP.PRO	2	PZ																																																										
VM2470A0	SLIDE TO FIX INTERNAL GLASS SHOP.PRO	2	PZ																																																										
VM2471A0	BL SP LOWER CLAMP INT LOCK GLASS SLIDER	1	PZ																																																										
VM2471A0	BL SP LOWER CLAMP INT LOCK GLASS SLIDER	1	PZ																																																										
VM2472A0	BL SP UPPER CLAMP INT LOCK GLASS SLIDER	1	PZ																																																										
VM2472A0	BL SP UPPER CLAMP INT LOCK GLASS SLIDER	1	PZ																																																										

COMPONENT			SPARE PART																																																																																					
Code	Description	Image	Code	Description	Components list																																																																																			
VT1326A	SP ROSSELLA 557X439X4 EXTERNAL GLASS		KDR1290A	BL SHOP.PRO ROSSELLA EXTERNAL DOOR KI	<table border="1"> <thead> <tr> <th>Code</th> <th>Description</th> <th>Qty</th> <th>UOM</th> </tr> </thead> <tbody> <tr> <td>VM2473A0</td> <td>BL SP INT GLASS HINGE LOWER LOCK PIN</td> <td>1</td> <td>PZ</td> </tr> <tr> <td>VM2473A0</td> <td>BL SP INT GLASS HINGE LOWER LOCK PIN</td> <td>1</td> <td>PZ</td> </tr> <tr> <td>VM2474A0</td> <td>BL SP INT GLASS HINGE UPPER LOCK PIN</td> <td>1</td> <td>PZ</td> </tr> <tr> <td>VM2474A0</td> <td>BL SP INT GLASS HINGE UPPER LOCK PIN</td> <td>1</td> <td>PZ</td> </tr> <tr> <td>VM2479A0</td> <td>BL SP GLASS H6 PUSHING BRACKET</td> <td>4</td> <td>PZ</td> </tr> <tr> <td>VM2479A0</td> <td>BL SP GLASS H6 PUSHING BRACKET</td> <td>4</td> <td>PZ</td> </tr> <tr> <td>VM2489A0</td> <td>SP HANDLE END KIT + STYLUS KIT</td> <td>1</td> <td>PZ</td> </tr> <tr> <td>VM2504A0</td> <td>DOWEL TO GUIDE SLIDE SPRING SHOP.PRO</td> <td>2</td> <td>PZ</td> </tr> <tr> <td>VM2504A0</td> <td>DOWEL TO GUIDE SLIDE SPRING SHOP.PRO</td> <td>2</td> <td>PZ</td> </tr> <tr> <td>VM2527A0</td> <td>STYLUS PEN FOR SP</td> <td>1</td> <td>PZ</td> </tr> <tr> <td>VT1326A1</td> <td>SP ROSSELLA 557X439X4 EXTERNAL GLASS</td> <td></td> <td></td> <td>1</td> <td>PZ</td> </tr> <tr> <td>VT1326A1</td> <td>SP ROSSELLA 557X439X4 EXTERNAL GLASS</td> <td></td> <td></td> <td>1</td> <td>PZ</td> </tr> </tbody> </table>	Code	Description	Qty	UOM	VM2473A0	BL SP INT GLASS HINGE LOWER LOCK PIN	1	PZ	VM2473A0	BL SP INT GLASS HINGE LOWER LOCK PIN	1	PZ	VM2474A0	BL SP INT GLASS HINGE UPPER LOCK PIN	1	PZ	VM2474A0	BL SP INT GLASS HINGE UPPER LOCK PIN	1	PZ	VM2479A0	BL SP GLASS H6 PUSHING BRACKET	4	PZ	VM2479A0	BL SP GLASS H6 PUSHING BRACKET	4	PZ	VM2489A0	SP HANDLE END KIT + STYLUS KIT	1	PZ	VM2504A0	DOWEL TO GUIDE SLIDE SPRING SHOP.PRO	2	PZ	VM2504A0	DOWEL TO GUIDE SLIDE SPRING SHOP.PRO	2	PZ	VM2527A0	STYLUS PEN FOR SP	1	PZ	VT1326A1	SP ROSSELLA 557X439X4 EXTERNAL GLASS			1	PZ	VT1326A1	SP ROSSELLA 557X439X4 EXTERNAL GLASS			1	PZ	KDR1283A	BL SHOP.PRO ROSSELLA COMPLETE DOOR KIT	<table border="1"> <thead> <tr> <th>Code</th> <th>Description</th> <th>Qty</th> <th>UOM</th> </tr> </thead> <tbody> <tr> <td>0B1289A0</td> <td></td> <td>1</td> <td>PZ</td> </tr> <tr> <td>0B1290A0</td> <td></td> <td>1</td> <td>PZ</td> </tr> <tr> <td>0B1291A0</td> <td></td> <td>1</td> <td>PZ</td> </tr> <tr> <td>0B1292A0</td> <td></td> <td>1</td> <td>PZ</td> </tr> <tr> <td>CR1114A0</td> <td>BLSP ROSSELLA DROPDOWN DOOR HINGE</td> <td>2</td> <td>PZ</td> </tr> </tbody> </table>	Code	Description	Qty	UOM	0B1289A0		1	PZ	0B1290A0		1	PZ	0B1291A0		1	PZ	0B1292A0		1	PZ	CR1114A0	BLSP ROSSELLA DROPDOWN DOOR HINGE	2	PZ
			Code	Description	Qty	UOM																																																																																		
VM2473A0	BL SP INT GLASS HINGE LOWER LOCK PIN	1	PZ																																																																																					
VM2473A0	BL SP INT GLASS HINGE LOWER LOCK PIN	1	PZ																																																																																					
VM2474A0	BL SP INT GLASS HINGE UPPER LOCK PIN	1	PZ																																																																																					
VM2474A0	BL SP INT GLASS HINGE UPPER LOCK PIN	1	PZ																																																																																					
VM2479A0	BL SP GLASS H6 PUSHING BRACKET	4	PZ																																																																																					
VM2479A0	BL SP GLASS H6 PUSHING BRACKET	4	PZ																																																																																					
VM2489A0	SP HANDLE END KIT + STYLUS KIT	1	PZ																																																																																					
VM2504A0	DOWEL TO GUIDE SLIDE SPRING SHOP.PRO	2	PZ																																																																																					
VM2504A0	DOWEL TO GUIDE SLIDE SPRING SHOP.PRO	2	PZ																																																																																					
VM2527A0	STYLUS PEN FOR SP	1	PZ																																																																																					
VT1326A1	SP ROSSELLA 557X439X4 EXTERNAL GLASS			1	PZ																																																																																			
VT1326A1	SP ROSSELLA 557X439X4 EXTERNAL GLASS			1	PZ																																																																																			
Code	Description	Qty	UOM																																																																																					
0B1289A0		1	PZ																																																																																					
0B1290A0		1	PZ																																																																																					
0B1291A0		1	PZ																																																																																					
0B1292A0		1	PZ																																																																																					
CR1114A0	BLSP ROSSELLA DROPDOWN DOOR HINGE	2	PZ																																																																																					

COMPONENT			SPARE PART																																																																										
Code	Description	Image	Code	Description	Components list																																																																								
VT1326A	SP ROSSELLA 557X439X4 EXTERNAL GLASS		KDR1283A	BL SHOP.PRO ROSSELLA COMPLETE DOOR KIT	<table border="1"> <thead> <tr> <th>Code</th> <th>Description</th> <th>Qty</th> <th>UOM</th> </tr> </thead> <tbody> <tr> <td>IP1508A1</td> <td>POLYSTYREN E U SHAPED PROFILE 2000X60X60</td> <td>1.500</td> <td>M</td> </tr> <tr> <td>LP1050A0</td> <td>BL SHOP.PRO L180 COMPLETE LED BAR</td> <td>1</td> <td>PZ</td> </tr> <tr> <td>SL1155A1</td> <td>LOCTITE BICOMPONEN T SILICON</td> <td>18</td> <td>ML</td> </tr> <tr> <td>TB1563A0</td> <td>DOOR LATERAL BEAM SP800</td> <td>1</td> <td>PZ</td> </tr> <tr> <td>TB3302A0</td> <td></td> <td>1</td> <td>PZ</td> </tr> <tr> <td>VI1014A0</td> <td>STAINLESS STEEL WASHER 4.5X9X0.8</td> <td>1</td> <td>PZ</td> </tr> <tr> <td>VI1220A1</td> <td>4,2X12 TCB SELF-TAPPIN G SCREW</td> <td>10</td> <td>PZ</td> </tr> <tr> <td>VI1875A0</td> <td>SCREW M5X10 TC1/2T INOX</td> <td>6</td> <td>PZ</td> </tr> <tr> <td>VI1930A0</td> <td>5X25 ST. STEEL SCREW CHIP</td> <td>12</td> <td>PZ</td> </tr> <tr> <td>VI1998A0</td> <td>ZINC PLATED SCREW 5X30 TCB</td> <td>2</td> <td>PZ</td> </tr> <tr> <td>VM1059A1</td> <td>HEAT SHRINK FILM H800</td> <td>0.700</td> <td>M</td> </tr> <tr> <td>VM1630A0</td> <td>INTERNAL GLASS PUSHING CAP</td> <td>1</td> <td>PZ</td> </tr> <tr> <td>VM1630A1</td> <td>INTERNAL GLASS PUSHING CAP</td> <td>1</td> <td>PZ</td> </tr> <tr> <td>VM2456A0</td> <td>BAKERLUX SHOP.PRO HANDLE END</td> <td>2</td> <td>PZ</td> </tr> <tr> <td>VM2456A0</td> <td>BAKERLUX SHOP.PRO HANDLE END</td> <td>2</td> <td>PZ</td> </tr> <tr> <td>VM2461A0</td> <td>BL SP RIGHT LOWER DROPDOWN DOOR CAP KIT</td> <td>1</td> <td>PZ</td> </tr> <tr> <td>VM2461A0</td> <td>BL SP RIGHT LOWER DROPDOWN DOOR CAP KIT</td> <td>1</td> <td>PZ</td> </tr> </tbody> </table>	Code	Description	Qty	UOM	IP1508A1	POLYSTYREN E U SHAPED PROFILE 2000X60X60	1.500	M	LP1050A0	BL SHOP.PRO L180 COMPLETE LED BAR	1	PZ	SL1155A1	LOCTITE BICOMPONEN T SILICON	18	ML	TB1563A0	DOOR LATERAL BEAM SP800	1	PZ	TB3302A0		1	PZ	VI1014A0	STAINLESS STEEL WASHER 4.5X9X0.8	1	PZ	VI1220A1	4,2X12 TCB SELF-TAPPIN G SCREW	10	PZ	VI1875A0	SCREW M5X10 TC1/2T INOX	6	PZ	VI1930A0	5X25 ST. STEEL SCREW CHIP	12	PZ	VI1998A0	ZINC PLATED SCREW 5X30 TCB	2	PZ	VM1059A1	HEAT SHRINK FILM H800	0.700	M	VM1630A0	INTERNAL GLASS PUSHING CAP	1	PZ	VM1630A1	INTERNAL GLASS PUSHING CAP	1	PZ	VM2456A0	BAKERLUX SHOP.PRO HANDLE END	2	PZ	VM2456A0	BAKERLUX SHOP.PRO HANDLE END	2	PZ	VM2461A0	BL SP RIGHT LOWER DROPDOWN DOOR CAP KIT	1	PZ	VM2461A0	BL SP RIGHT LOWER DROPDOWN DOOR CAP KIT	1	PZ
Code	Description	Qty	UOM																																																																										
IP1508A1	POLYSTYREN E U SHAPED PROFILE 2000X60X60	1.500	M																																																																										
LP1050A0	BL SHOP.PRO L180 COMPLETE LED BAR	1	PZ																																																																										
SL1155A1	LOCTITE BICOMPONEN T SILICON	18	ML																																																																										
TB1563A0	DOOR LATERAL BEAM SP800	1	PZ																																																																										
TB3302A0		1	PZ																																																																										
VI1014A0	STAINLESS STEEL WASHER 4.5X9X0.8	1	PZ																																																																										
VI1220A1	4,2X12 TCB SELF-TAPPIN G SCREW	10	PZ																																																																										
VI1875A0	SCREW M5X10 TC1/2T INOX	6	PZ																																																																										
VI1930A0	5X25 ST. STEEL SCREW CHIP	12	PZ																																																																										
VI1998A0	ZINC PLATED SCREW 5X30 TCB	2	PZ																																																																										
VM1059A1	HEAT SHRINK FILM H800	0.700	M																																																																										
VM1630A0	INTERNAL GLASS PUSHING CAP	1	PZ																																																																										
VM1630A1	INTERNAL GLASS PUSHING CAP	1	PZ																																																																										
VM2456A0	BAKERLUX SHOP.PRO HANDLE END	2	PZ																																																																										
VM2456A0	BAKERLUX SHOP.PRO HANDLE END	2	PZ																																																																										
VM2461A0	BL SP RIGHT LOWER DROPDOWN DOOR CAP KIT	1	PZ																																																																										
VM2461A0	BL SP RIGHT LOWER DROPDOWN DOOR CAP KIT	1	PZ																																																																										

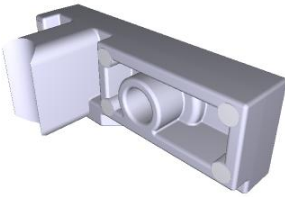
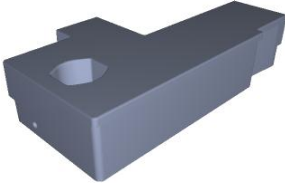

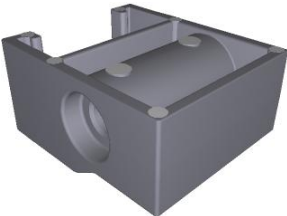
COMPONENT			SPARE PART																																																														
Code	Description	Image	Code	Description	Components list																																																												
VT1326A	SP ROSSELLA 557X439X4 EXTERNAL GLASS		KDR1283A	BL SHOP.PRO ROSSELLA COMPLETE DOOR KIT	<table border="1"> <thead> <tr> <th>Code</th> <th>Description</th> <th>Qty</th> <th>UOM</th> </tr> </thead> <tbody> <tr> <td>VM2462A0</td> <td>BL SP LEFT LOWER DROPDOWN DOOR CAP</td> <td>1</td> <td>PZ</td> </tr> <tr> <td>VM2462A0</td> <td>BL SP LEFT LOWER DROPDOWN DOOR CAP</td> <td>1</td> <td>PZ</td> </tr> <tr> <td>VM2463A0</td> <td>SHOP.PRO RIGHT UPPER CAP DROP DOWN DOOR</td> <td>1</td> <td>PZ</td> </tr> <tr> <td>VM2463A0</td> <td>SHOP.PRO RIGHT UPPER CAP DROP DOWN DOOR</td> <td>1</td> <td>PZ</td> </tr> <tr> <td>VM2464A0</td> <td>SHOP.PRO LEFT UPPER CAP DROP DOWN DOOR</td> <td>1</td> <td>PZ</td> </tr> <tr> <td>VM2464A0</td> <td>SHOP.PRO LEFT UPPER CAP DROP DOWN DOOR</td> <td>1</td> <td>PZ</td> </tr> <tr> <td>VM2471A0</td> <td>BL SP LOWER CLAMP INT LOCK GLASS SLIDER</td> <td>1</td> <td>PZ</td> </tr> <tr> <td>VM2471A0</td> <td>BL SP LOWER CLAMP INT LOCK GLASS SLIDER</td> <td>1</td> <td>PZ</td> </tr> <tr> <td>VM2472A0</td> <td>BL SP UPPER CLAMP INT LOCK GLASS SLIDER</td> <td>1</td> <td>PZ</td> </tr> <tr> <td>VM2472A0</td> <td>BL SP UPPER CLAMP INT LOCK GLASS SLIDER</td> <td>1</td> <td>PZ</td> </tr> <tr> <td>VM2479A0</td> <td>BL SP GLASS H6 PUSHING BRACKET</td> <td>1</td> <td>PZ</td> </tr> <tr> <td>VM2479A0</td> <td>BL SP GLASS H6 PUSHING BRACKET</td> <td>1</td> <td>PZ</td> </tr> <tr> <td>VM2489A0</td> <td>SP HANDLE END KIT + STYLUS KIT</td> <td>1</td> <td>PZ</td> </tr> <tr> <td>VM2503A0</td> <td>SLIDE TO FIX INTERNAL NON REMOV GLASS SP</td> <td>2</td> <td>PZ</td> </tr> </tbody> </table>	Code	Description	Qty	UOM	VM2462A0	BL SP LEFT LOWER DROPDOWN DOOR CAP	1	PZ	VM2462A0	BL SP LEFT LOWER DROPDOWN DOOR CAP	1	PZ	VM2463A0	SHOP.PRO RIGHT UPPER CAP DROP DOWN DOOR	1	PZ	VM2463A0	SHOP.PRO RIGHT UPPER CAP DROP DOWN DOOR	1	PZ	VM2464A0	SHOP.PRO LEFT UPPER CAP DROP DOWN DOOR	1	PZ	VM2464A0	SHOP.PRO LEFT UPPER CAP DROP DOWN DOOR	1	PZ	VM2471A0	BL SP LOWER CLAMP INT LOCK GLASS SLIDER	1	PZ	VM2471A0	BL SP LOWER CLAMP INT LOCK GLASS SLIDER	1	PZ	VM2472A0	BL SP UPPER CLAMP INT LOCK GLASS SLIDER	1	PZ	VM2472A0	BL SP UPPER CLAMP INT LOCK GLASS SLIDER	1	PZ	VM2479A0	BL SP GLASS H6 PUSHING BRACKET	1	PZ	VM2479A0	BL SP GLASS H6 PUSHING BRACKET	1	PZ	VM2489A0	SP HANDLE END KIT + STYLUS KIT	1	PZ	VM2503A0	SLIDE TO FIX INTERNAL NON REMOV GLASS SP	2	PZ
Code	Description	Qty	UOM																																																														
VM2462A0	BL SP LEFT LOWER DROPDOWN DOOR CAP	1	PZ																																																														
VM2462A0	BL SP LEFT LOWER DROPDOWN DOOR CAP	1	PZ																																																														
VM2463A0	SHOP.PRO RIGHT UPPER CAP DROP DOWN DOOR	1	PZ																																																														
VM2463A0	SHOP.PRO RIGHT UPPER CAP DROP DOWN DOOR	1	PZ																																																														
VM2464A0	SHOP.PRO LEFT UPPER CAP DROP DOWN DOOR	1	PZ																																																														
VM2464A0	SHOP.PRO LEFT UPPER CAP DROP DOWN DOOR	1	PZ																																																														
VM2471A0	BL SP LOWER CLAMP INT LOCK GLASS SLIDER	1	PZ																																																														
VM2471A0	BL SP LOWER CLAMP INT LOCK GLASS SLIDER	1	PZ																																																														
VM2472A0	BL SP UPPER CLAMP INT LOCK GLASS SLIDER	1	PZ																																																														
VM2472A0	BL SP UPPER CLAMP INT LOCK GLASS SLIDER	1	PZ																																																														
VM2479A0	BL SP GLASS H6 PUSHING BRACKET	1	PZ																																																														
VM2479A0	BL SP GLASS H6 PUSHING BRACKET	1	PZ																																																														
VM2489A0	SP HANDLE END KIT + STYLUS KIT	1	PZ																																																														
VM2503A0	SLIDE TO FIX INTERNAL NON REMOV GLASS SP	2	PZ																																																														

COMPONENT			SPARE PART																																										
Code	Description	Image	Code	Description	Components list																																								
VT1326A	SP ROSSELLA 557X439X4 EXTERNAL GLASS		KDR1283A	BL SHOP.PRO ROSSELLA COMPLETE DOOR KIT	<table border="1"> <thead> <tr> <th>Code</th> <th>Description</th> <th>Qty</th> <th>UOM</th> </tr> </thead> <tbody> <tr> <td>VM2503A0</td> <td>SLIDE TO FIX INTERNAL NON REMOV GLASS SP</td> <td>2</td> <td>PZ</td> </tr> <tr> <td>VM2512A0</td> <td>BL SP DOOR-MICRO SWITCH SOFT CLOSING</td> <td>1</td> <td>PZ</td> </tr> <tr> <td>VM2512A0</td> <td>BL SP DOOR-MICRO SWITCH SOFT CLOSING</td> <td>1</td> <td>PZ</td> </tr> <tr> <td>VM2527A0</td> <td>STYLUS PEN FOR SP</td> <td>1</td> <td>PZ</td> </tr> <tr> <td>VT1326A1</td> <td>SP ROSSELLA 557X439X4 EXTERNAL GLASS</td> <td>1</td> <td>PZ</td> </tr> <tr> <td>VT1326A1</td> <td>SP ROSSELLA 557X439X4 EXTERNAL GLASS</td> <td>1</td> <td>PZ</td> </tr> <tr> <td>VT1332A0</td> <td>SP ROSSELLA 715X393.5X6 INNER GLASS</td> <td>1</td> <td>PZ</td> </tr> <tr> <td>VT1353A0</td> <td></td> <td>1</td> <td>PZ</td> </tr> <tr> <td>VT1353A0</td> <td></td> <td>1</td> <td>PZ</td> </tr> </tbody> </table>	Code	Description	Qty	UOM	VM2503A0	SLIDE TO FIX INTERNAL NON REMOV GLASS SP	2	PZ	VM2512A0	BL SP DOOR-MICRO SWITCH SOFT CLOSING	1	PZ	VM2512A0	BL SP DOOR-MICRO SWITCH SOFT CLOSING	1	PZ	VM2527A0	STYLUS PEN FOR SP	1	PZ	VT1326A1	SP ROSSELLA 557X439X4 EXTERNAL GLASS	1	PZ	VT1326A1	SP ROSSELLA 557X439X4 EXTERNAL GLASS	1	PZ	VT1332A0	SP ROSSELLA 715X393.5X6 INNER GLASS	1	PZ	VT1353A0		1	PZ	VT1353A0		1	PZ
Code	Description	Qty	UOM																																										
VM2503A0	SLIDE TO FIX INTERNAL NON REMOV GLASS SP	2	PZ																																										
VM2512A0	BL SP DOOR-MICRO SWITCH SOFT CLOSING	1	PZ																																										
VM2512A0	BL SP DOOR-MICRO SWITCH SOFT CLOSING	1	PZ																																										
VM2527A0	STYLUS PEN FOR SP	1	PZ																																										
VT1326A1	SP ROSSELLA 557X439X4 EXTERNAL GLASS	1	PZ																																										
VT1326A1	SP ROSSELLA 557X439X4 EXTERNAL GLASS	1	PZ																																										
VT1332A0	SP ROSSELLA 715X393.5X6 INNER GLASS	1	PZ																																										
VT1353A0		1	PZ																																										
VT1353A0		1	PZ																																										
VM2474A	BL SP INT GLASS HINGE UPPER LOCK PIN		KVM2474A	BL SP INT GLASS HINGE UPPER LOCK PIN KIT	<table border="1"> <thead> <tr> <th>Code</th> <th>Description</th> <th>Qty</th> <th>UOM</th> </tr> </thead> <tbody> <tr> <td>VM1224A0</td> <td>65MY 220MM 2 COLOURS SHRINK TUBE</td> <td>0.150</td> <td>M</td> </tr> <tr> <td>VM2474A0</td> <td>BL SP INT GLASS HINGE UPPER LOCK PIN</td> <td>1</td> <td>PZ</td> </tr> <tr> <td>VM2474A0</td> <td>BL SP INT GLASS HINGE UPPER LOCK PIN</td> <td>1</td> <td>PZ</td> </tr> </tbody> </table>	Code	Description	Qty	UOM	VM1224A0	65MY 220MM 2 COLOURS SHRINK TUBE	0.150	M	VM2474A0	BL SP INT GLASS HINGE UPPER LOCK PIN	1	PZ	VM2474A0	BL SP INT GLASS HINGE UPPER LOCK PIN	1	PZ																								
Code	Description	Qty	UOM																																										
VM1224A0	65MY 220MM 2 COLOURS SHRINK TUBE	0.150	M																																										
VM2474A0	BL SP INT GLASS HINGE UPPER LOCK PIN	1	PZ																																										
VM2474A0	BL SP INT GLASS HINGE UPPER LOCK PIN	1	PZ																																										
VM2468A	BL SP LEFT UPPER LATERAL DOOR CA		KVM2468A	BL SP LEFT UPPER LATERAL DOOR CAP KIT	<table border="1"> <thead> <tr> <th>Code</th> <th>Description</th> <th>Qty</th> <th>UOM</th> </tr> </thead> <tbody> <tr> <td>VM1224A0</td> <td>65MY 220MM 2 COLOURS SHRINK TUBE</td> <td>0.300</td> <td>M</td> </tr> <tr> <td>VM2468A0</td> <td>BL SP LEFT UPPER LATERAL DOOR CAP</td> <td>1</td> <td>PZ</td> </tr> <tr> <td>VM2468A0</td> <td>BL SP LEFT UPPER LATERAL DOOR CAP</td> <td>1</td> <td>PZ</td> </tr> </tbody> </table>	Code	Description	Qty	UOM	VM1224A0	65MY 220MM 2 COLOURS SHRINK TUBE	0.300	M	VM2468A0	BL SP LEFT UPPER LATERAL DOOR CAP	1	PZ	VM2468A0	BL SP LEFT UPPER LATERAL DOOR CAP	1	PZ																								
Code	Description	Qty	UOM																																										
VM1224A0	65MY 220MM 2 COLOURS SHRINK TUBE	0.300	M																																										
VM2468A0	BL SP LEFT UPPER LATERAL DOOR CAP	1	PZ																																										
VM2468A0	BL SP LEFT UPPER LATERAL DOOR CAP	1	PZ																																										

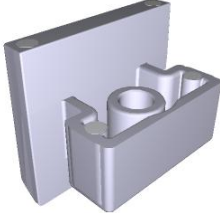

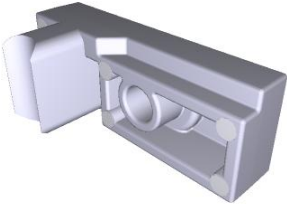
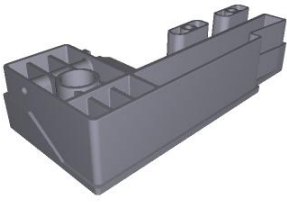

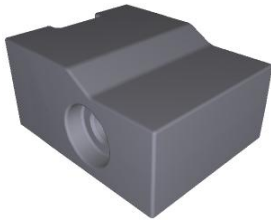
COMPONENT			SPARE PART																																		
Code	Description	Image	Code	Description	Components list																																
VM2472A	BL SP UPPER CLAMP INT LOCK GLASS SLIDER		KVM2471A	BL SP INTERNAL GLASS LOCK HOLDER KIT	<table border="1"> <thead> <tr> <th>Code</th> <th>Description</th> <th>Qty</th> <th>UOM</th> </tr> </thead> <tbody> <tr> <td>VI1930A0</td> <td>5X25 ST. STEEL SCREW CHIP</td> <td>2</td> <td>PZ</td> </tr> <tr> <td>VI1998A0</td> <td>ZINC PLATED SCREW 5X30 TCB</td> <td>2</td> <td>PZ</td> </tr> <tr> <td>VM1224A0</td> <td>65MY 220MM 2 COLOURS SHRINK TUBE</td> <td>0.150</td> <td>M</td> </tr> <tr> <td>VM2471A0</td> <td>BL SP LOWER CLAMP INT LOCK GLASS SLIDER</td> <td>1</td> <td>PZ</td> </tr> <tr> <td>VM2471A0</td> <td>BL SP LOWER CLAMP INT LOCK GLASS SLIDER</td> <td>1</td> <td>PZ</td> </tr> <tr> <td>VM2472A0</td> <td>BL SP UPPER CLAMP INT LOCK GLASS SLIDER</td> <td>1</td> <td>PZ</td> </tr> <tr> <td>VM2472A0</td> <td>BL SP UPPER CLAMP INT LOCK GLASS SLIDER</td> <td>1</td> <td>PZ</td> </tr> </tbody> </table>	Code	Description	Qty	UOM	VI1930A0	5X25 ST. STEEL SCREW CHIP	2	PZ	VI1998A0	ZINC PLATED SCREW 5X30 TCB	2	PZ	VM1224A0	65MY 220MM 2 COLOURS SHRINK TUBE	0.150	M	VM2471A0	BL SP LOWER CLAMP INT LOCK GLASS SLIDER	1	PZ	VM2471A0	BL SP LOWER CLAMP INT LOCK GLASS SLIDER	1	PZ	VM2472A0	BL SP UPPER CLAMP INT LOCK GLASS SLIDER	1	PZ	VM2472A0	BL SP UPPER CLAMP INT LOCK GLASS SLIDER	1	PZ
Code	Description	Qty	UOM																																		
VI1930A0	5X25 ST. STEEL SCREW CHIP	2	PZ																																		
VI1998A0	ZINC PLATED SCREW 5X30 TCB	2	PZ																																		
VM1224A0	65MY 220MM 2 COLOURS SHRINK TUBE	0.150	M																																		
VM2471A0	BL SP LOWER CLAMP INT LOCK GLASS SLIDER	1	PZ																																		
VM2471A0	BL SP LOWER CLAMP INT LOCK GLASS SLIDER	1	PZ																																		
VM2472A0	BL SP UPPER CLAMP INT LOCK GLASS SLIDER	1	PZ																																		
VM2472A0	BL SP UPPER CLAMP INT LOCK GLASS SLIDER	1	PZ																																		
ML1005A	DE5 DF0.6 H18 COMPRESSION SPRING		KVM2470A	BL SHOP.PRO INTERNAL GLASS LOCK 2PCS KIT	<table border="1"> <thead> <tr> <th>Code</th> <th>Description</th> <th>Qty</th> <th>UOM</th> </tr> </thead> <tbody> <tr> <td>ML1005A0</td> <td>DE5 DF0.6 H18 COMPRESSION N SPRING</td> <td>2</td> <td>PZ</td> </tr> <tr> <td>VM1224A0</td> <td>65MY 220MM 2 COLOURS SHRINK TUBE</td> <td>0.200</td> <td>M</td> </tr> <tr> <td>VM2470A0</td> <td>SLIDE TO FIX INTERNAL GLASS SHOP.PRO</td> <td>2</td> <td>PZ</td> </tr> <tr> <td>VM2470A0</td> <td>SLIDE TO FIX INTERNAL GLASS SHOP.PRO</td> <td>2</td> <td>PZ</td> </tr> <tr> <td>VM2504A0</td> <td>DOWEL TO GUIDE SLIDE SPRING SHOP.PRO</td> <td>2</td> <td>PZ</td> </tr> <tr> <td>VM2504A0</td> <td>DOWEL TO GUIDE SLIDE SPRING SHOP.PRO</td> <td>2</td> <td>PZ</td> </tr> </tbody> </table>	Code	Description	Qty	UOM	ML1005A0	DE5 DF0.6 H18 COMPRESSION N SPRING	2	PZ	VM1224A0	65MY 220MM 2 COLOURS SHRINK TUBE	0.200	M	VM2470A0	SLIDE TO FIX INTERNAL GLASS SHOP.PRO	2	PZ	VM2470A0	SLIDE TO FIX INTERNAL GLASS SHOP.PRO	2	PZ	VM2504A0	DOWEL TO GUIDE SLIDE SPRING SHOP.PRO	2	PZ	VM2504A0	DOWEL TO GUIDE SLIDE SPRING SHOP.PRO	2	PZ				
Code	Description	Qty	UOM																																		
ML1005A0	DE5 DF0.6 H18 COMPRESSION N SPRING	2	PZ																																		
VM1224A0	65MY 220MM 2 COLOURS SHRINK TUBE	0.200	M																																		
VM2470A0	SLIDE TO FIX INTERNAL GLASS SHOP.PRO	2	PZ																																		
VM2470A0	SLIDE TO FIX INTERNAL GLASS SHOP.PRO	2	PZ																																		
VM2504A0	DOWEL TO GUIDE SLIDE SPRING SHOP.PRO	2	PZ																																		
VM2504A0	DOWEL TO GUIDE SLIDE SPRING SHOP.PRO	2	PZ																																		

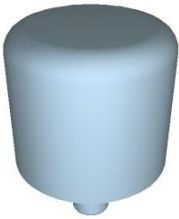

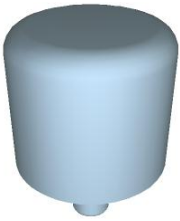
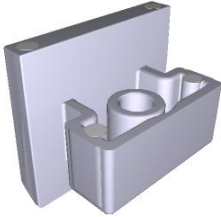
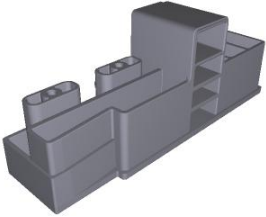
COMPONENT			SPARE PART																														
Code	Description	Image	Code	Description	Components list																												
VM2504A	DOWEL TO GUIDE SLIDE SPRING SHOP.PRO		KVM2470A	BL SHOP.PRO INTERNAL GLASS LOCK 2PCS KIT	<table border="1"> <thead> <tr> <th>Code</th> <th>Description</th> <th>Qty</th> <th>UOM</th> </tr> </thead> <tbody> <tr> <td>ML1005A0</td> <td>DES DF0.6 H18 COMPRESSIO N SPRING</td> <td>2</td> <td>PZ</td> </tr> <tr> <td>VM1224A0</td> <td>65MY 220MM 2 COLOURS SHRINK TUBE</td> <td>0.200</td> <td>M</td> </tr> <tr> <td>VM2470A0</td> <td>SLIDE TO FIX INTERNAL GLASS SHOP.PRO</td> <td>2</td> <td>PZ</td> </tr> <tr> <td>VM2470A0</td> <td>SLIDE TO FIX INTERNAL GLASS SHOP.PRO</td> <td>2</td> <td>PZ</td> </tr> <tr> <td>VM2504A0</td> <td>DOWEL TO GUIDE SLIDE SPRING SHOP.PRO</td> <td>2</td> <td>PZ</td> </tr> <tr> <td>VM2504A0</td> <td>DOWEL TO GUIDE SLIDE SPRING SHOP.PRO</td> <td>2</td> <td>PZ</td> </tr> </tbody> </table>	Code	Description	Qty	UOM	ML1005A0	DES DF0.6 H18 COMPRESSIO N SPRING	2	PZ	VM1224A0	65MY 220MM 2 COLOURS SHRINK TUBE	0.200	M	VM2470A0	SLIDE TO FIX INTERNAL GLASS SHOP.PRO	2	PZ	VM2470A0	SLIDE TO FIX INTERNAL GLASS SHOP.PRO	2	PZ	VM2504A0	DOWEL TO GUIDE SLIDE SPRING SHOP.PRO	2	PZ	VM2504A0	DOWEL TO GUIDE SLIDE SPRING SHOP.PRO	2	PZ
Code	Description	Qty	UOM																														
ML1005A0	DES DF0.6 H18 COMPRESSIO N SPRING	2	PZ																														
VM1224A0	65MY 220MM 2 COLOURS SHRINK TUBE	0.200	M																														
VM2470A0	SLIDE TO FIX INTERNAL GLASS SHOP.PRO	2	PZ																														
VM2470A0	SLIDE TO FIX INTERNAL GLASS SHOP.PRO	2	PZ																														
VM2504A0	DOWEL TO GUIDE SLIDE SPRING SHOP.PRO	2	PZ																														
VM2504A0	DOWEL TO GUIDE SLIDE SPRING SHOP.PRO	2	PZ																														
VM2470A	SLIDE TO FIX INTERNAL GLASS SHOP.PRO		KVM2470A	BL SHOP.PRO INTERNAL GLASS LOCK 2PCS KIT	<table border="1"> <thead> <tr> <th>Code</th> <th>Description</th> <th>Qty</th> <th>UOM</th> </tr> </thead> <tbody> <tr> <td>ML1005A0</td> <td>DES DF0.6 H18 COMPRESSIO N SPRING</td> <td>2</td> <td>PZ</td> </tr> <tr> <td>VM1224A0</td> <td>65MY 220MM 2 COLOURS SHRINK TUBE</td> <td>0.200</td> <td>M</td> </tr> <tr> <td>VM2470A0</td> <td>SLIDE TO FIX INTERNAL GLASS SHOP.PRO</td> <td>2</td> <td>PZ</td> </tr> <tr> <td>VM2470A0</td> <td>SLIDE TO FIX INTERNAL GLASS SHOP.PRO</td> <td>2</td> <td>PZ</td> </tr> <tr> <td>VM2504A0</td> <td>DOWEL TO GUIDE SLIDE SPRING SHOP.PRO</td> <td>2</td> <td>PZ</td> </tr> <tr> <td>VM2504A0</td> <td>DOWEL TO GUIDE SLIDE SPRING SHOP.PRO</td> <td>2</td> <td>PZ</td> </tr> </tbody> </table>	Code	Description	Qty	UOM	ML1005A0	DES DF0.6 H18 COMPRESSIO N SPRING	2	PZ	VM1224A0	65MY 220MM 2 COLOURS SHRINK TUBE	0.200	M	VM2470A0	SLIDE TO FIX INTERNAL GLASS SHOP.PRO	2	PZ	VM2470A0	SLIDE TO FIX INTERNAL GLASS SHOP.PRO	2	PZ	VM2504A0	DOWEL TO GUIDE SLIDE SPRING SHOP.PRO	2	PZ	VM2504A0	DOWEL TO GUIDE SLIDE SPRING SHOP.PRO	2	PZ
Code	Description	Qty	UOM																														
ML1005A0	DES DF0.6 H18 COMPRESSIO N SPRING	2	PZ																														
VM1224A0	65MY 220MM 2 COLOURS SHRINK TUBE	0.200	M																														
VM2470A0	SLIDE TO FIX INTERNAL GLASS SHOP.PRO	2	PZ																														
VM2470A0	SLIDE TO FIX INTERNAL GLASS SHOP.PRO	2	PZ																														
VM2504A0	DOWEL TO GUIDE SLIDE SPRING SHOP.PRO	2	PZ																														
VM2504A0	DOWEL TO GUIDE SLIDE SPRING SHOP.PRO	2	PZ																														

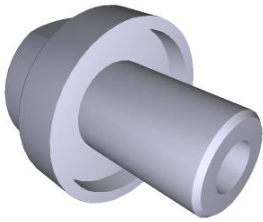
COMPONENT			SPARE PART																						
Code	Description	Image	Code	Description	Components list																				
VM2467A	SP SIDE-OPENING DOOR RIGHT UPPER CAP KIT		KVM2467A	BL SP RIGHT UPPER LATERAL DOOR CAP KIT	<table border="1"> <thead> <tr> <th>Code</th> <th>Description</th> <th>Qty</th> <th>UOM</th> </tr> </thead> <tbody> <tr> <td>VM1224A0</td> <td>65MY 220MM 2 COLOURS SHRINK TUBE</td> <td>0.300</td> <td>M</td> </tr> <tr> <td>VM2467A0</td> <td>SP SIDE-OPENIN G DOOR RIGHT UPPER CAP KIT</td> <td>1</td> <td>PZ</td> </tr> <tr> <td>VM2467A0</td> <td>SP SIDE-OPENIN G DOOR RIGHT UPPER CAP KIT</td> <td>1</td> <td>PZ</td> </tr> </tbody> </table>	Code	Description	Qty	UOM	VM1224A0	65MY 220MM 2 COLOURS SHRINK TUBE	0.300	M	VM2467A0	SP SIDE-OPENIN G DOOR RIGHT UPPER CAP KIT	1	PZ	VM2467A0	SP SIDE-OPENIN G DOOR RIGHT UPPER CAP KIT	1	PZ				
Code	Description	Qty	UOM																						
VM1224A0	65MY 220MM 2 COLOURS SHRINK TUBE	0.300	M																						
VM2467A0	SP SIDE-OPENIN G DOOR RIGHT UPPER CAP KIT	1	PZ																						
VM2467A0	SP SIDE-OPENIN G DOOR RIGHT UPPER CAP KIT	1	PZ																						
VM2473A	BL SP INT GLASS HINGE LOWER LOCK PIN		KVM2473A	BL SP INT GLASS HINGE LOWER LOCK PIN KIT	<table border="1"> <thead> <tr> <th>Code</th> <th>Description</th> <th>Qty</th> <th>UOM</th> </tr> </thead> <tbody> <tr> <td>VM1224A0</td> <td>65MY 220MM 2 COLOURS SHRINK TUBE</td> <td>0.150</td> <td>M</td> </tr> <tr> <td>VM2473A0</td> <td>BL SP INT GLASS HINGE LOWER LOCK PIN</td> <td>1</td> <td>PZ</td> </tr> <tr> <td>VM2473A0</td> <td>BL SP INT GLASS HINGE LOWER LOCK PIN</td> <td>1</td> <td>PZ</td> </tr> </tbody> </table>	Code	Description	Qty	UOM	VM1224A0	65MY 220MM 2 COLOURS SHRINK TUBE	0.150	M	VM2473A0	BL SP INT GLASS HINGE LOWER LOCK PIN	1	PZ	VM2473A0	BL SP INT GLASS HINGE LOWER LOCK PIN	1	PZ				
Code	Description	Qty	UOM																						
VM1224A0	65MY 220MM 2 COLOURS SHRINK TUBE	0.150	M																						
VM2473A0	BL SP INT GLASS HINGE LOWER LOCK PIN	1	PZ																						
VM2473A0	BL SP INT GLASS HINGE LOWER LOCK PIN	1	PZ																						
VM2466A	BL SP LEFT LOWER LATERAL DOOR CA		KVM2466A	BL SP LEFT LOWER LATERAL DOOR CAP KIT	<table border="1"> <thead> <tr> <th>Code</th> <th>Description</th> <th>Qty</th> <th>UOM</th> </tr> </thead> <tbody> <tr> <td>VM1224A0</td> <td>65MY 220MM 2 COLOURS SHRINK TUBE</td> <td>0.300</td> <td>M</td> </tr> <tr> <td>VM2466A0</td> <td>BL SP LEFT LOWER LATERAL DOOR CAP</td> <td>1</td> <td>PZ</td> </tr> <tr> <td>VM2466A0</td> <td>BL SP LEFT LOWER LATERAL DOOR CAP</td> <td>1</td> <td>PZ</td> </tr> </tbody> </table>	Code	Description	Qty	UOM	VM1224A0	65MY 220MM 2 COLOURS SHRINK TUBE	0.300	M	VM2466A0	BL SP LEFT LOWER LATERAL DOOR CAP	1	PZ	VM2466A0	BL SP LEFT LOWER LATERAL DOOR CAP	1	PZ				
Code	Description	Qty	UOM																						
VM1224A0	65MY 220MM 2 COLOURS SHRINK TUBE	0.300	M																						
VM2466A0	BL SP LEFT LOWER LATERAL DOOR CAP	1	PZ																						
VM2466A0	BL SP LEFT LOWER LATERAL DOOR CAP	1	PZ																						
VM2471A	BL SP LOWER CLAMP INT LOCK GLASS SLIDER		KVM2471A	BL SP INTERNAL GLASS LOCK HOLDER KIT	<table border="1"> <thead> <tr> <th>Code</th> <th>Description</th> <th>Qty</th> <th>UOM</th> </tr> </thead> <tbody> <tr> <td>VI1930A0</td> <td>5X25 ST. STEEL SCREW CHIP</td> <td>2</td> <td>PZ</td> </tr> <tr> <td>VI1998A0</td> <td>ZINC PLATED SCREW 5X30 TCB</td> <td>2</td> <td>PZ</td> </tr> <tr> <td>VM1224A0</td> <td>65MY 220MM 2 COLOURS SHRINK TUBE</td> <td>0.150</td> <td>M</td> </tr> <tr> <td>VM2471A0</td> <td>BL SP LOWER CLAMP INT LOCK GLASS SLIDER</td> <td>1</td> <td>PZ</td> </tr> </tbody> </table>	Code	Description	Qty	UOM	VI1930A0	5X25 ST. STEEL SCREW CHIP	2	PZ	VI1998A0	ZINC PLATED SCREW 5X30 TCB	2	PZ	VM1224A0	65MY 220MM 2 COLOURS SHRINK TUBE	0.150	M	VM2471A0	BL SP LOWER CLAMP INT LOCK GLASS SLIDER	1	PZ
Code	Description	Qty	UOM																						
VI1930A0	5X25 ST. STEEL SCREW CHIP	2	PZ																						
VI1998A0	ZINC PLATED SCREW 5X30 TCB	2	PZ																						
VM1224A0	65MY 220MM 2 COLOURS SHRINK TUBE	0.150	M																						
VM2471A0	BL SP LOWER CLAMP INT LOCK GLASS SLIDER	1	PZ																						



COMPONENT			SPARE PART																														
Code	Description	Image	Code	Description	Components list																												
VM2471A	BL SP LOWER CLAMP INT LOCK GLASS SLIDER		KVM2471A	BL SP INTERNAL GLASS LOCK HOLDER KIT	<table border="1"> <thead> <tr> <th>Code</th> <th>Description</th> <th>Qty</th> <th>UOM</th> </tr> </thead> <tbody> <tr> <td>VM2471A0</td> <td>BL SP LOWER CLAMP INT LOCK GLASS SLIDER</td> <td>1</td> <td>PZ</td> </tr> <tr> <td>VM2472A0</td> <td>BL SP UPPER CLAMP INT LOCK GLASS SLIDER</td> <td>1</td> <td>PZ</td> </tr> <tr> <td>VM2472A0</td> <td>BL SP UPPER CLAMP INT LOCK GLASS SLIDER</td> <td>1</td> <td>PZ</td> </tr> </tbody> </table>	Code	Description	Qty	UOM	VM2471A0	BL SP LOWER CLAMP INT LOCK GLASS SLIDER	1	PZ	VM2472A0	BL SP UPPER CLAMP INT LOCK GLASS SLIDER	1	PZ	VM2472A0	BL SP UPPER CLAMP INT LOCK GLASS SLIDER	1	PZ												
Code	Description	Qty	UOM																														
VM2471A0	BL SP LOWER CLAMP INT LOCK GLASS SLIDER	1	PZ																														
VM2472A0	BL SP UPPER CLAMP INT LOCK GLASS SLIDER	1	PZ																														
VM2472A0	BL SP UPPER CLAMP INT LOCK GLASS SLIDER	1	PZ																														
ML1005A	DE5 DF0.6 H18 COMPRESSION SPRING		KVM2470A	BL SHOP.PRO INTERNAL GLASS LOCK 2PCS KIT	<table border="1"> <thead> <tr> <th>Code</th> <th>Description</th> <th>Qty</th> <th>UOM</th> </tr> </thead> <tbody> <tr> <td>ML1005A0</td> <td>DE5 DF0.6 H18 COMPRESSION N SPRING</td> <td>2</td> <td>PZ</td> </tr> <tr> <td>VM1224A0</td> <td>65MY 220MM 2 COLOURS SHRINK TUBE</td> <td>0.200</td> <td>M</td> </tr> <tr> <td>VM2470A0</td> <td>SLIDE TO FIX INTERNAL GLASS SHOP.PRO</td> <td>2</td> <td>PZ</td> </tr> <tr> <td>VM2470A0</td> <td>SLIDE TO FIX INTERNAL GLASS SHOP.PRO</td> <td>2</td> <td>PZ</td> </tr> <tr> <td>VM2504A0</td> <td>DOWEL TO GUIDE SLIDE SPRING SHOP.PRO</td> <td>2</td> <td>PZ</td> </tr> <tr> <td>VM2504A0</td> <td>DOWEL TO GUIDE SLIDE SPRING SHOP.PRO</td> <td>2</td> <td>PZ</td> </tr> </tbody> </table>	Code	Description	Qty	UOM	ML1005A0	DE5 DF0.6 H18 COMPRESSION N SPRING	2	PZ	VM1224A0	65MY 220MM 2 COLOURS SHRINK TUBE	0.200	M	VM2470A0	SLIDE TO FIX INTERNAL GLASS SHOP.PRO	2	PZ	VM2470A0	SLIDE TO FIX INTERNAL GLASS SHOP.PRO	2	PZ	VM2504A0	DOWEL TO GUIDE SLIDE SPRING SHOP.PRO	2	PZ	VM2504A0	DOWEL TO GUIDE SLIDE SPRING SHOP.PRO	2	PZ
Code	Description	Qty	UOM																														
ML1005A0	DE5 DF0.6 H18 COMPRESSION N SPRING	2	PZ																														
VM1224A0	65MY 220MM 2 COLOURS SHRINK TUBE	0.200	M																														
VM2470A0	SLIDE TO FIX INTERNAL GLASS SHOP.PRO	2	PZ																														
VM2470A0	SLIDE TO FIX INTERNAL GLASS SHOP.PRO	2	PZ																														
VM2504A0	DOWEL TO GUIDE SLIDE SPRING SHOP.PRO	2	PZ																														
VM2504A0	DOWEL TO GUIDE SLIDE SPRING SHOP.PRO	2	PZ																														
VM2504A	DOWEL TO GUIDE SLIDE SPRING SHOP.PRO		KVM2470A	BL SHOP.PRO INTERNAL GLASS LOCK 2PCS KIT	<table border="1"> <thead> <tr> <th>Code</th> <th>Description</th> <th>Qty</th> <th>UOM</th> </tr> </thead> <tbody> <tr> <td>ML1005A0</td> <td>DE5 DF0.6 H18 COMPRESSION N SPRING</td> <td>2</td> <td>PZ</td> </tr> <tr> <td>VM1224A0</td> <td>65MY 220MM 2 COLOURS SHRINK TUBE</td> <td>0.200</td> <td>M</td> </tr> <tr> <td>VM2470A0</td> <td>SLIDE TO FIX INTERNAL GLASS SHOP.PRO</td> <td>2</td> <td>PZ</td> </tr> <tr> <td>VM2470A0</td> <td>SLIDE TO FIX INTERNAL GLASS SHOP.PRO</td> <td>2</td> <td>PZ</td> </tr> </tbody> </table>	Code	Description	Qty	UOM	ML1005A0	DE5 DF0.6 H18 COMPRESSION N SPRING	2	PZ	VM1224A0	65MY 220MM 2 COLOURS SHRINK TUBE	0.200	M	VM2470A0	SLIDE TO FIX INTERNAL GLASS SHOP.PRO	2	PZ	VM2470A0	SLIDE TO FIX INTERNAL GLASS SHOP.PRO	2	PZ								
Code	Description	Qty	UOM																														
ML1005A0	DE5 DF0.6 H18 COMPRESSION N SPRING	2	PZ																														
VM1224A0	65MY 220MM 2 COLOURS SHRINK TUBE	0.200	M																														
VM2470A0	SLIDE TO FIX INTERNAL GLASS SHOP.PRO	2	PZ																														
VM2470A0	SLIDE TO FIX INTERNAL GLASS SHOP.PRO	2	PZ																														

COMPONENT			SPARE PART																														
Code	Description	Image	Code	Description	Components list																												
VM2504A	DOWEL TO GUIDE SLIDE SPRING SHOP.PRO		KVM2470A	BL SHOP.PRO INTERNAL GLASS LOCK 2PCS KIT	<table border="1"> <thead> <tr> <th>Code</th> <th>Description</th> <th>Qty</th> <th>UOM</th> </tr> </thead> <tbody> <tr> <td>VM2504A0</td> <td>DOWEL TO GUIDE SLIDE SPRING SHOP.PRO</td> <td>2</td> <td>PZ</td> </tr> <tr> <td>VM2504A0</td> <td>DOWEL TO GUIDE SLIDE SPRING SHOP.PRO</td> <td>2</td> <td>PZ</td> </tr> </tbody> </table>	Code	Description	Qty	UOM	VM2504A0	DOWEL TO GUIDE SLIDE SPRING SHOP.PRO	2	PZ	VM2504A0	DOWEL TO GUIDE SLIDE SPRING SHOP.PRO	2	PZ																
Code	Description	Qty	UOM																														
VM2504A0	DOWEL TO GUIDE SLIDE SPRING SHOP.PRO	2	PZ																														
VM2504A0	DOWEL TO GUIDE SLIDE SPRING SHOP.PRO	2	PZ																														
VM2470A	SLIDE TO FIX INTERNAL GLASS SHOP.PRO		KVM2470A	BL SHOP.PRO INTERNAL GLASS LOCK 2PCS KIT	<table border="1"> <thead> <tr> <th>Code</th> <th>Description</th> <th>Qty</th> <th>UOM</th> </tr> </thead> <tbody> <tr> <td>ML1005A0</td> <td>DE5 DF0.6 H18 COMPRESSIO N SPRING</td> <td>2</td> <td>PZ</td> </tr> <tr> <td>VM1224A0</td> <td>65MY 220MM 2 COLOURS SHRINK TUBE</td> <td>0.200</td> <td>M</td> </tr> <tr> <td>VM2470A0</td> <td>SLIDE TO FIX INTERNAL GLASS SHOP.PRO</td> <td>2</td> <td>PZ</td> </tr> <tr> <td>VM2470A0</td> <td>SLIDE TO FIX INTERNAL GLASS SHOP.PRO</td> <td>2</td> <td>PZ</td> </tr> <tr> <td>VM2504A0</td> <td>DOWEL TO GUIDE SLIDE SPRING SHOP.PRO</td> <td>2</td> <td>PZ</td> </tr> <tr> <td>VM2504A0</td> <td>DOWEL TO GUIDE SLIDE SPRING SHOP.PRO</td> <td>2</td> <td>PZ</td> </tr> </tbody> </table>	Code	Description	Qty	UOM	ML1005A0	DE5 DF0.6 H18 COMPRESSIO N SPRING	2	PZ	VM1224A0	65MY 220MM 2 COLOURS SHRINK TUBE	0.200	M	VM2470A0	SLIDE TO FIX INTERNAL GLASS SHOP.PRO	2	PZ	VM2470A0	SLIDE TO FIX INTERNAL GLASS SHOP.PRO	2	PZ	VM2504A0	DOWEL TO GUIDE SLIDE SPRING SHOP.PRO	2	PZ	VM2504A0	DOWEL TO GUIDE SLIDE SPRING SHOP.PRO	2	PZ
Code	Description	Qty	UOM																														
ML1005A0	DE5 DF0.6 H18 COMPRESSIO N SPRING	2	PZ																														
VM1224A0	65MY 220MM 2 COLOURS SHRINK TUBE	0.200	M																														
VM2470A0	SLIDE TO FIX INTERNAL GLASS SHOP.PRO	2	PZ																														
VM2470A0	SLIDE TO FIX INTERNAL GLASS SHOP.PRO	2	PZ																														
VM2504A0	DOWEL TO GUIDE SLIDE SPRING SHOP.PRO	2	PZ																														
VM2504A0	DOWEL TO GUIDE SLIDE SPRING SHOP.PRO	2	PZ																														
VM2465A	SP SIDE-OPENING DOOR RIGHT LOWER CAP KIT		KVM2465A	BL SP RIGHT LOWER LATERAL DOOR CAP KIT	<table border="1"> <thead> <tr> <th>Code</th> <th>Description</th> <th>Qty</th> <th>UOM</th> </tr> </thead> <tbody> <tr> <td>VM1224A0</td> <td>65MY 220MM 2 COLOURS SHRINK TUBE</td> <td>0.300</td> <td>M</td> </tr> <tr> <td>VM2465A0</td> <td>SP SIDE-OPENIN G DOOR RIGHT LOWER CAP KIT</td> <td>1</td> <td>PZ</td> </tr> <tr> <td>VM2465A0</td> <td>SP SIDE-OPENIN G DOOR RIGHT LOWER CAP KIT</td> <td>1</td> <td>PZ</td> </tr> </tbody> </table>	Code	Description	Qty	UOM	VM1224A0	65MY 220MM 2 COLOURS SHRINK TUBE	0.300	M	VM2465A0	SP SIDE-OPENIN G DOOR RIGHT LOWER CAP KIT	1	PZ	VM2465A0	SP SIDE-OPENIN G DOOR RIGHT LOWER CAP KIT	1	PZ												
Code	Description	Qty	UOM																														
VM1224A0	65MY 220MM 2 COLOURS SHRINK TUBE	0.300	M																														
VM2465A0	SP SIDE-OPENIN G DOOR RIGHT LOWER CAP KIT	1	PZ																														
VM2465A0	SP SIDE-OPENIN G DOOR RIGHT LOWER CAP KIT	1	PZ																														

COMPONENT			SPARE PART																														
Code	Description	Image	Code	Description	Components list																												
VM1209A	SHOP.PRO LOCK PIN WASHER		KVM1209A	BAKERLUX SHOP.PRO PIN BUSHING LOCK KIT	<table border="1"> <thead> <tr> <th>Code</th> <th>Description</th> <th>Qty</th> <th>UOM</th> </tr> </thead> <tbody> <tr> <td>VM1209A0</td> <td>SHOP.PRO LOCK PIN WASHER</td> <td>1</td> <td>PZ</td> </tr> <tr> <td>VM1224A0</td> <td>65MY 220MM 2 COLOURS SHRINK TUBE</td> <td>0.150</td> <td>M</td> </tr> </tbody> </table>	Code	Description	Qty	UOM	VM1209A0	SHOP.PRO LOCK PIN WASHER	1	PZ	VM1224A0	65MY 220MM 2 COLOURS SHRINK TUBE	0.150	M																
Code	Description	Qty	UOM																														
VM1209A0	SHOP.PRO LOCK PIN WASHER	1	PZ																														
VM1224A0	65MY 220MM 2 COLOURS SHRINK TUBE	0.150	M																														
OB1298A			OB1298A0																														
OB1300A			OB1300A0																														
VT1347A	SP ROSSELLA FLAG DOOR INNER GLASS+HINGES		KVT1347A	BL SP ROSSELLA INT LATERAL GLASS KIT	<table border="1"> <thead> <tr> <th>Code</th> <th>Description</th> <th>Qty</th> <th>UOM</th> </tr> </thead> <tbody> <tr> <td>CR1103A0</td> <td>INTERNAL GLASS ST. STEEL UPPER HINGE</td> <td>1</td> <td>PZ</td> </tr> <tr> <td>CR1104A0</td> <td>INTERNAL GLASS ST. STEEL LOWER HINGE</td> <td>1</td> <td>PZ</td> </tr> <tr> <td>IP1385A1</td> <td>CORNER POLYSTYREN E PACKING 110X80X2000</td> <td>1</td> <td>M</td> </tr> <tr> <td>VI1810A0</td> <td>M6X6 STAINLESS STEEL FLATHEAD SCREW</td> <td>6</td> <td>PZ</td> </tr> <tr> <td>VM1059A1</td> <td>HEAT SHRINK FILM H800</td> <td>1</td> <td>M</td> </tr> <tr> <td>VM2399A0</td> <td>DOOR HINGES HEADLESS SCREWS COVER</td> <td>2</td> <td>PZ</td> </tr> </tbody> </table>	Code	Description	Qty	UOM	CR1103A0	INTERNAL GLASS ST. STEEL UPPER HINGE	1	PZ	CR1104A0	INTERNAL GLASS ST. STEEL LOWER HINGE	1	PZ	IP1385A1	CORNER POLYSTYREN E PACKING 110X80X2000	1	M	VI1810A0	M6X6 STAINLESS STEEL FLATHEAD SCREW	6	PZ	VM1059A1	HEAT SHRINK FILM H800	1	M	VM2399A0	DOOR HINGES HEADLESS SCREWS COVER	2	PZ
Code	Description	Qty	UOM																														
CR1103A0	INTERNAL GLASS ST. STEEL UPPER HINGE	1	PZ																														
CR1104A0	INTERNAL GLASS ST. STEEL LOWER HINGE	1	PZ																														
IP1385A1	CORNER POLYSTYREN E PACKING 110X80X2000	1	M																														
VI1810A0	M6X6 STAINLESS STEEL FLATHEAD SCREW	6	PZ																														
VM1059A1	HEAT SHRINK FILM H800	1	M																														
VM2399A0	DOOR HINGES HEADLESS SCREWS COVER	2	PZ																														

COMPONENT			SPARE PART																														
Code	Description	Image	Code	Description	Components list																												
VT1347A	SP ROSSELLA FLAG DOOR INNER GLASS+HINGES		KVT1347A	BL SP ROSSELLA INT LATERAL GLASS KIT	<table border="1"> <thead> <tr> <th>Code</th> <th>Description</th> <th>Qty</th> <th>UOM</th> </tr> </thead> <tbody> <tr> <td>VM2399A0</td> <td>DOOR HINGES HEADLESS SCREWS COVER</td> <td>2</td> <td>PZ</td> </tr> <tr> <td>VM2476A0</td> <td>BL SP H6 INTERNAL GLASS HINGE GASKET</td> <td>2</td> <td>PZ</td> </tr> <tr> <td>VM2476A0</td> <td>BL SP H6 INTERNAL GLASS HINGE GASKET</td> <td>2</td> <td>PZ</td> </tr> <tr> <td>VT1332A0</td> <td>SP ROSSELLA 715X393.5X6 INNER GLASS</td> <td>1</td> <td>PZ</td> </tr> <tr> <td>VT1332A0</td> <td>SP ROSSELLA 715X393.5X6 INNER GLASS</td> <td>1</td> <td>PZ</td> </tr> </tbody> </table>	Code	Description	Qty	UOM	VM2399A0	DOOR HINGES HEADLESS SCREWS COVER	2	PZ	VM2476A0	BL SP H6 INTERNAL GLASS HINGE GASKET	2	PZ	VM2476A0	BL SP H6 INTERNAL GLASS HINGE GASKET	2	PZ	VT1332A0	SP ROSSELLA 715X393.5X6 INNER GLASS	1	PZ	VT1332A0	SP ROSSELLA 715X393.5X6 INNER GLASS	1	PZ				
Code	Description	Qty	UOM																														
VM2399A0	DOOR HINGES HEADLESS SCREWS COVER	2	PZ																														
VM2476A0	BL SP H6 INTERNAL GLASS HINGE GASKET	2	PZ																														
VM2476A0	BL SP H6 INTERNAL GLASS HINGE GASKET	2	PZ																														
VT1332A0	SP ROSSELLA 715X393.5X6 INNER GLASS	1	PZ																														
VT1332A0	SP ROSSELLA 715X393.5X6 INNER GLASS	1	PZ																														
VM2456A	BAKERLUX SHOP.PRO HANDLE END		KVM2456A	2 PCS BAKERLUX SHOP.PRO HANDLE END KIT	<table border="1"> <thead> <tr> <th>Code</th> <th>Description</th> <th>Qty</th> <th>UOM</th> </tr> </thead> <tbody> <tr> <td>VI1930A0</td> <td>5X25 ST. STEEL SCREW CHIP</td> <td>4</td> <td>PZ</td> </tr> <tr> <td>VM1224A0</td> <td>65MY 220MM 2 COLOURS SHRINK TUBE</td> <td>0.300</td> <td>M</td> </tr> <tr> <td>VM2456A0</td> <td>BAKERLUX SHOP.PRO HANDLE END</td> <td>2</td> <td>PZ</td> </tr> <tr> <td>VM2456A0</td> <td>BAKERLUX SHOP.PRO HANDLE END</td> <td>2</td> <td>PZ</td> </tr> <tr> <td>VM2489A0</td> <td>SP HANDLE END KIT + STYLUS KIT</td> <td>1</td> <td>PZ</td> </tr> <tr> <td>VM2527A0</td> <td>STYLUS PEN FOR SP</td> <td>1</td> <td>PZ</td> </tr> </tbody> </table>	Code	Description	Qty	UOM	VI1930A0	5X25 ST. STEEL SCREW CHIP	4	PZ	VM1224A0	65MY 220MM 2 COLOURS SHRINK TUBE	0.300	M	VM2456A0	BAKERLUX SHOP.PRO HANDLE END	2	PZ	VM2456A0	BAKERLUX SHOP.PRO HANDLE END	2	PZ	VM2489A0	SP HANDLE END KIT + STYLUS KIT	1	PZ	VM2527A0	STYLUS PEN FOR SP	1	PZ
Code	Description	Qty	UOM																														
VI1930A0	5X25 ST. STEEL SCREW CHIP	4	PZ																														
VM1224A0	65MY 220MM 2 COLOURS SHRINK TUBE	0.300	M																														
VM2456A0	BAKERLUX SHOP.PRO HANDLE END	2	PZ																														
VM2456A0	BAKERLUX SHOP.PRO HANDLE END	2	PZ																														
VM2489A0	SP HANDLE END KIT + STYLUS KIT	1	PZ																														
VM2527A0	STYLUS PEN FOR SP	1	PZ																														
TB3304A	SHOP.PRO ARI-ROS FLAG DOOR HANDLE TUBE		KTB3304A	BL SP ARI-ROS LATER DOOR HANDLE TUBE KIT	<table border="1"> <thead> <tr> <th>Code</th> <th>Description</th> <th>Qty</th> <th>UOM</th> </tr> </thead> <tbody> <tr> <td>TB3304A0</td> <td>SHOP.PRO ARI-ROS FLAG DOOR HANDLE TUBE</td> <td>1</td> <td>PZ</td> </tr> <tr> <td>VI1930A0</td> <td>5X25 ST. STEEL SCREW CHIP</td> <td>4</td> <td>PZ</td> </tr> <tr> <td>VM2456A0</td> <td>BAKERLUX SHOP.PRO HANDLE END</td> <td>2</td> <td>PZ</td> </tr> <tr> <td>VM2456A0</td> <td>BAKERLUX SHOP.PRO HANDLE END</td> <td>2</td> <td>PZ</td> </tr> <tr> <td>VM2489A0</td> <td>SP HANDLE END KIT + STYLUS KIT</td> <td>1</td> <td>PZ</td> </tr> <tr> <td>VM2527A0</td> <td>STYLUS PEN FOR SP</td> <td>1</td> <td>PZ</td> </tr> </tbody> </table>	Code	Description	Qty	UOM	TB3304A0	SHOP.PRO ARI-ROS FLAG DOOR HANDLE TUBE	1	PZ	VI1930A0	5X25 ST. STEEL SCREW CHIP	4	PZ	VM2456A0	BAKERLUX SHOP.PRO HANDLE END	2	PZ	VM2456A0	BAKERLUX SHOP.PRO HANDLE END	2	PZ	VM2489A0	SP HANDLE END KIT + STYLUS KIT	1	PZ	VM2527A0	STYLUS PEN FOR SP	1	PZ
Code	Description	Qty	UOM																														
TB3304A0	SHOP.PRO ARI-ROS FLAG DOOR HANDLE TUBE	1	PZ																														
VI1930A0	5X25 ST. STEEL SCREW CHIP	4	PZ																														
VM2456A0	BAKERLUX SHOP.PRO HANDLE END	2	PZ																														
VM2456A0	BAKERLUX SHOP.PRO HANDLE END	2	PZ																														
VM2489A0	SP HANDLE END KIT + STYLUS KIT	1	PZ																														
VM2527A0	STYLUS PEN FOR SP	1	PZ																														



COMPONENT			SPARE PART																						
Code	Description	Image	Code	Description	Components list																				
VM2527A	STYLUS PEN FOR S		KVM2527A	EVEREO-BLSP TOUCH STYLUS 5 PCS KIT	<table border="1"> <thead> <tr> <th>Code</th> <th>Description</th> <th>Qty</th> <th>UOM</th> </tr> </thead> <tbody> <tr> <td>VM1224A0</td> <td>65MY 220MM 2 COLOURS SHRINK TUBE</td> <td>0.150</td> <td>M</td> </tr> <tr> <td>VM2527A0</td> <td>STYLUS PEN FOR SP</td> <td>5</td> <td>PZ</td> </tr> </tbody> </table>	Code	Description	Qty	UOM	VM1224A0	65MY 220MM 2 COLOURS SHRINK TUBE	0.150	M	VM2527A0	STYLUS PEN FOR SP	5	PZ								
Code	Description	Qty	UOM																						
VM1224A0	65MY 220MM 2 COLOURS SHRINK TUBE	0.150	M																						
VM2527A0	STYLUS PEN FOR SP	5	PZ																						
PE2112A	BL SHOP.PRO MASTER COMPLETE CONTROL		KPE2112A	BAKERLUX SP MASTER CONTROL BOARD KIT	<table border="1"> <thead> <tr> <th>Code</th> <th>Description</th> <th>Qty</th> <th>UOM</th> </tr> </thead> <tbody> <tr> <td>PE2112A0</td> <td>BAKERLUX SP MASTER COMPLETE CONTROL</td> <td>1</td> <td>PZ</td> </tr> <tr> <td>PE2112A1</td> <td>BL SHOP.PRO MASTER COMPLETE CONTROL</td> <td>1</td> <td>PZ</td> </tr> <tr> <td>VI1930A0</td> <td>5X25 ST. STEEL SCREW CHIP</td> <td>2</td> <td>PZ</td> </tr> <tr> <td>VM2147A0</td> <td>410X343X15 MM PINK SMOOTH ESD SPONGE</td> <td>1</td> <td>PZ</td> </tr> </tbody> </table>	Code	Description	Qty	UOM	PE2112A0	BAKERLUX SP MASTER COMPLETE CONTROL	1	PZ	PE2112A1	BL SHOP.PRO MASTER COMPLETE CONTROL	1	PZ	VI1930A0	5X25 ST. STEEL SCREW CHIP	2	PZ	VM2147A0	410X343X15 MM PINK SMOOTH ESD SPONGE	1	PZ
Code	Description	Qty	UOM																						
PE2112A0	BAKERLUX SP MASTER COMPLETE CONTROL	1	PZ																						
PE2112A1	BL SHOP.PRO MASTER COMPLETE CONTROL	1	PZ																						
VI1930A0	5X25 ST. STEEL SCREW CHIP	2	PZ																						
VM2147A0	410X343X15 MM PINK SMOOTH ESD SPONGE	1	PZ																						



ASM3416A/0.D01 - External cover



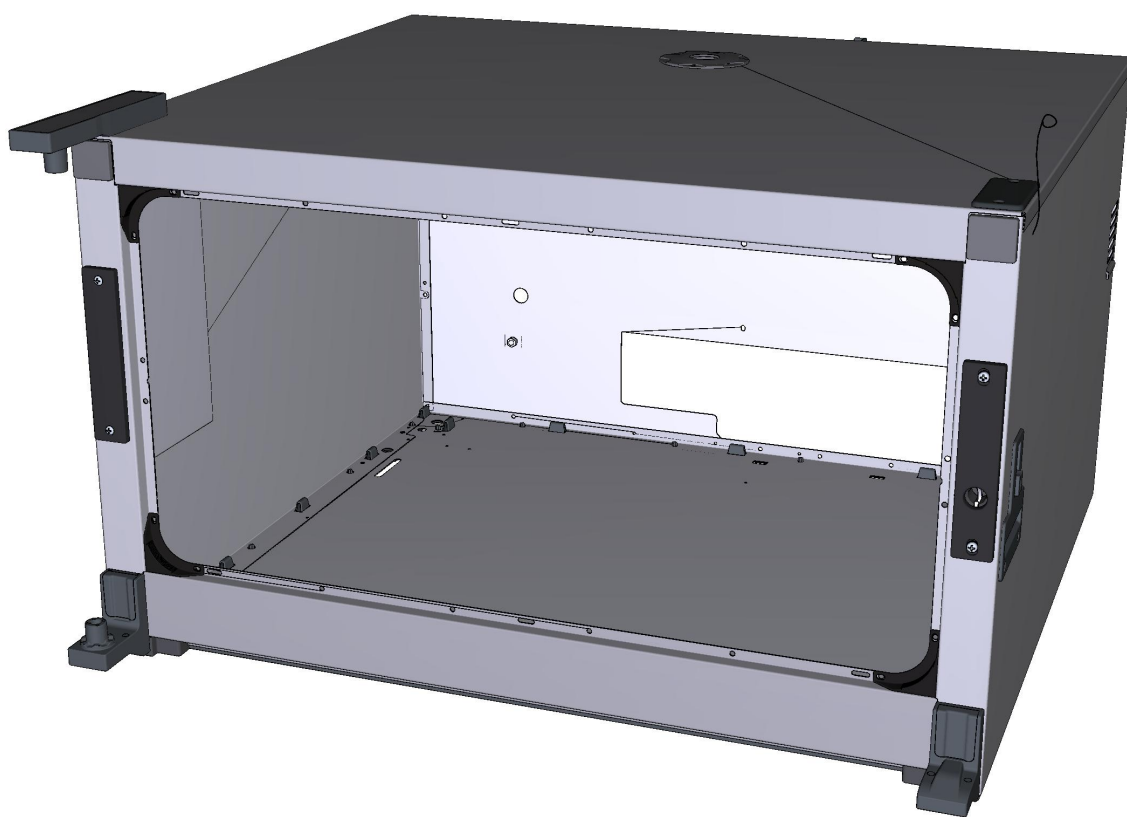

FRONT



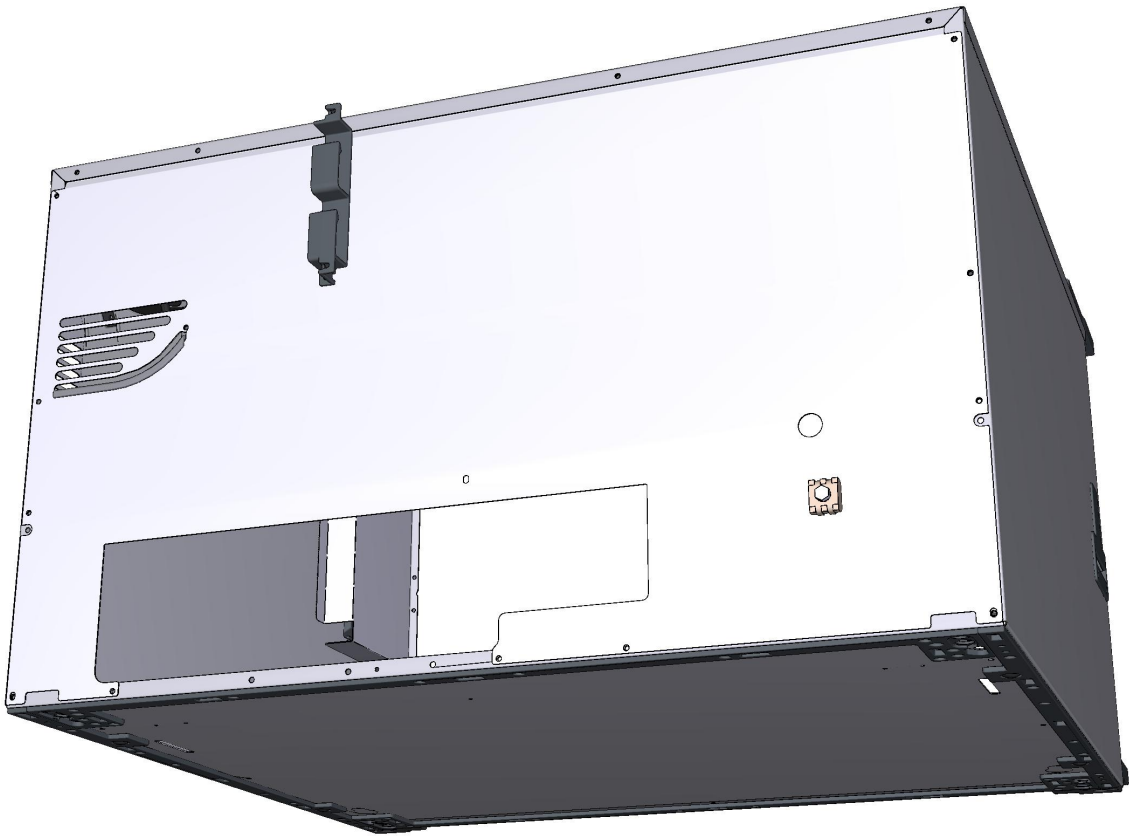



ASM3416A/0.D01 - External cover





REAR



COMPONENT			SPARE PART																		
Code	Description	Image	Code	Description	Components list																
VM1750A	BRASS COMB CLAM		KVM1750A	COMB TERMINAL BLOCK KIT	<table border="1"> <thead> <tr> <th>Code</th> <th>Description</th> <th>Qty</th> <th>UOM</th> </tr> </thead> <tbody> <tr> <td>VM1224A0</td> <td>65MY 220MM 2 COLOURS SHRINK TUBE</td> <td>0.150</td> <td>M</td> </tr> <tr> <td>VM1750A0</td> <td>BRASS COMB CLAMP</td> <td>1</td> <td>PZ</td> </tr> </tbody> </table>	Code	Description	Qty	UOM	VM1224A0	65MY 220MM 2 COLOURS SHRINK TUBE	0.150	M	VM1750A0	BRASS COMB CLAMP	1	PZ				
Code	Description	Qty	UOM																		
VM1224A0	65MY 220MM 2 COLOURS SHRINK TUBE	0.150	M																		
VM1750A0	BRASS COMB CLAMP	1	PZ																		
VM2249A	COOKING CHAMBER FRONT CORNER		KVM2249A	CHAMBER FRONT PROFILE CORNER KIT	<table border="1"> <thead> <tr> <th>Code</th> <th>Description</th> <th>Qty</th> <th>UOM</th> </tr> </thead> <tbody> <tr> <td>VM1224A0</td> <td>65MY 220MM 2 COLOURS SHRINK TUBE</td> <td>0.150</td> <td>M</td> </tr> <tr> <td>VM2249A0</td> <td>COOKING CHAMBER FRONT CORNER</td> <td>1</td> <td>PZ</td> </tr> </tbody> </table>	Code	Description	Qty	UOM	VM1224A0	65MY 220MM 2 COLOURS SHRINK TUBE	0.150	M	VM2249A0	COOKING CHAMBER FRONT CORNER	1	PZ				
Code	Description	Qty	UOM																		
VM1224A0	65MY 220MM 2 COLOURS SHRINK TUBE	0.150	M																		
VM2249A0	COOKING CHAMBER FRONT CORNER	1	PZ																		
VM2502A	BAKERLUX SHOP.PRO CHIMNEY RING		KVM2502A	BAKERLUX SHOP.PRO CHIMNEY RING KIT	<table border="1"> <thead> <tr> <th>Code</th> <th>Description</th> <th>Qty</th> <th>UOM</th> </tr> </thead> <tbody> <tr> <td>VM1224A0</td> <td>65MY 220MM 2 COLOURS SHRINK TUBE</td> <td>0.300</td> <td>M</td> </tr> <tr> <td>VM2502A0</td> <td>BAKERLUX SHOP.PRO CHIMNEY RIN</td> <td>1</td> <td>PZ</td> </tr> <tr> <td>VM2502A0</td> <td>BAKERLUX SHOP.PRO CHIMNEY RIN</td> <td>1</td> <td>PZ</td> </tr> </tbody> </table>	Code	Description	Qty	UOM	VM1224A0	65MY 220MM 2 COLOURS SHRINK TUBE	0.300	M	VM2502A0	BAKERLUX SHOP.PRO CHIMNEY RIN	1	PZ	VM2502A0	BAKERLUX SHOP.PRO CHIMNEY RIN	1	PZ
Code	Description	Qty	UOM																		
VM1224A0	65MY 220MM 2 COLOURS SHRINK TUBE	0.300	M																		
VM2502A0	BAKERLUX SHOP.PRO CHIMNEY RIN	1	PZ																		
VM2502A0	BAKERLUX SHOP.PRO CHIMNEY RIN	1	PZ																		
VM2481A	FRONT EXTERNAL COVER LEFT CAP S		KVM2481A	BL SP LEFT EXT COVER FRONT PANEL CAP KIT	<table border="1"> <thead> <tr> <th>Code</th> <th>Description</th> <th>Qty</th> <th>UOM</th> </tr> </thead> <tbody> <tr> <td>VM1224A0</td> <td>65MY 220MM 2 COLOURS SHRINK TUBE</td> <td>0.150</td> <td>M</td> </tr> <tr> <td>VM2481A0</td> <td>FRONT EXTERNAL COVER LEFT CAP SP</td> <td>1</td> <td>PZ</td> </tr> <tr> <td>VM2481A0</td> <td>FRONT EXTERNAL COVER LEFT CAP SP</td> <td>1</td> <td>PZ</td> </tr> </tbody> </table>	Code	Description	Qty	UOM	VM1224A0	65MY 220MM 2 COLOURS SHRINK TUBE	0.150	M	VM2481A0	FRONT EXTERNAL COVER LEFT CAP SP	1	PZ	VM2481A0	FRONT EXTERNAL COVER LEFT CAP SP	1	PZ
Code	Description	Qty	UOM																		
VM1224A0	65MY 220MM 2 COLOURS SHRINK TUBE	0.150	M																		
VM2481A0	FRONT EXTERNAL COVER LEFT CAP SP	1	PZ																		
VM2481A0	FRONT EXTERNAL COVER LEFT CAP SP	1	PZ																		
VM2480A	FRONT EXTERNAL COVER RIGHT CAP SP		KVM2480A	BL SP RIGHT EXT COVER FRONT PANEL CAP	<table border="1"> <thead> <tr> <th>Code</th> <th>Description</th> <th>Qty</th> <th>UOM</th> </tr> </thead> <tbody> <tr> <td>VM1224A0</td> <td>65MY 220MM 2 COLOURS SHRINK TUBE</td> <td>0.150</td> <td>M</td> </tr> <tr> <td>VM2480A0</td> <td>FRONT EXTERNAL COVER RIGHT CAP SP</td> <td>1</td> <td>PZ</td> </tr> <tr> <td>VM2480A0</td> <td>FRONT EXTERNAL COVER RIGHT CAP SP</td> <td>1</td> <td>PZ</td> </tr> </tbody> </table>	Code	Description	Qty	UOM	VM1224A0	65MY 220MM 2 COLOURS SHRINK TUBE	0.150	M	VM2480A0	FRONT EXTERNAL COVER RIGHT CAP SP	1	PZ	VM2480A0	FRONT EXTERNAL COVER RIGHT CAP SP	1	PZ
Code	Description	Qty	UOM																		
VM1224A0	65MY 220MM 2 COLOURS SHRINK TUBE	0.150	M																		
VM2480A0	FRONT EXTERNAL COVER RIGHT CAP SP	1	PZ																		
VM2480A0	FRONT EXTERNAL COVER RIGHT CAP SP	1	PZ																		



COMPONENT			SPARE PART																														
Code	Description	Image	Code	Description	Components list																												
VM1222A	CABLE LOCKS SP ACCESSORIES EL CONNECTION		VM1222A0	CABLE LOCKS SP ACCESSORIES EL CONNECTION																													
VM1631A	PLUS INNER GLASS PUSHING CAP		KVM1631A	CAP FOR INTERNAL GLASS 10 PCS KIT	<table border="1"> <thead> <tr> <th>Code</th> <th>Description</th> <th>Qty</th> <th>UOM</th> </tr> </thead> <tbody> <tr> <td>VM1224A0</td> <td>65MY 220MM 2 COLOURS SHRINK TUBE</td> <td>0.200</td> <td>M</td> </tr> <tr> <td>VM1631A0</td> <td>PLUS INNER GLASS PUSHING CAP</td> <td>10</td> <td>PZ</td> </tr> </tbody> </table>	Code	Description	Qty	UOM	VM1224A0	65MY 220MM 2 COLOURS SHRINK TUBE	0.200	M	VM1631A0	PLUS INNER GLASS PUSHING CAP	10	PZ																
Code	Description	Qty	UOM																														
VM1224A0	65MY 220MM 2 COLOURS SHRINK TUBE	0.200	M																														
VM1631A0	PLUS INNER GLASS PUSHING CAP	10	PZ																														
VM2492A	BL SP 600X400 EXT BOTTOM PANEL GASKET		KVM2492A	SP 600X400 EXT BOT PANEL GASKET 2PC KIT	<table border="1"> <thead> <tr> <th>Code</th> <th>Description</th> <th>Qty</th> <th>UOM</th> </tr> </thead> <tbody> <tr> <td>VM1794A0</td> <td>250X4.8 PA66 BLACK CLAMP</td> <td>1</td> <td>PZ</td> </tr> <tr> <td>VM2103A0</td> <td>CLAMP LOCK</td> <td>1</td> <td>PZ</td> </tr> <tr> <td>VM2492A0</td> <td>BL SP 600X400 EXT BOTTOM PANEL GASKE</td> <td>2</td> <td>PZ</td> </tr> <tr> <td>VM2492A0</td> <td>BL SP 600X400 EXT BOTTOM PANEL GASKE</td> <td>2</td> <td>PZ</td> </tr> </tbody> </table>	Code	Description	Qty	UOM	VM1794A0	250X4.8 PA66 BLACK CLAMP	1	PZ	VM2103A0	CLAMP LOCK	1	PZ	VM2492A0	BL SP 600X400 EXT BOTTOM PANEL GASKE	2	PZ	VM2492A0	BL SP 600X400 EXT BOTTOM PANEL GASKE	2	PZ								
Code	Description	Qty	UOM																														
VM1794A0	250X4.8 PA66 BLACK CLAMP	1	PZ																														
VM2103A0	CLAMP LOCK	1	PZ																														
VM2492A0	BL SP 600X400 EXT BOTTOM PANEL GASKE	2	PZ																														
VM2492A0	BL SP 600X400 EXT BOTTOM PANEL GASKE	2	PZ																														
VM2493A	BL SP 600X400 EX LAT BOTTOM PANEL GASKET		KVM2493A	SP 600X400 BOT LAT PANEL GASKET 2PC KIT	<table border="1"> <thead> <tr> <th>Code</th> <th>Description</th> <th>Qty</th> <th>UOM</th> </tr> </thead> <tbody> <tr> <td>VM1631A0</td> <td>PLUS INNER GLASS PUSHING CAP</td> <td>4</td> <td>PZ</td> </tr> <tr> <td>VM1794A0</td> <td>250X4.8 PA66 BLACK CLAMP</td> <td>1</td> <td>PZ</td> </tr> <tr> <td>VM2103A0</td> <td>CLAMP LOCK</td> <td>1</td> <td>PZ</td> </tr> <tr> <td>VM2493A0</td> <td>BL SP 600X400 EX LAT BOTTOM PANEL GASKE</td> <td>2</td> <td>PZ</td> </tr> <tr> <td>VM2493A0</td> <td>BL SP 600X400 EX LAT BOTTOM PANEL GASKE</td> <td>2</td> <td>PZ</td> </tr> <tr> <td>VM2493A1</td> <td>EXT. LATERAL BACK GASKET SP800</td> <td>2</td> <td>PZ</td> </tr> </tbody> </table>	Code	Description	Qty	UOM	VM1631A0	PLUS INNER GLASS PUSHING CAP	4	PZ	VM1794A0	250X4.8 PA66 BLACK CLAMP	1	PZ	VM2103A0	CLAMP LOCK	1	PZ	VM2493A0	BL SP 600X400 EX LAT BOTTOM PANEL GASKE	2	PZ	VM2493A0	BL SP 600X400 EX LAT BOTTOM PANEL GASKE	2	PZ	VM2493A1	EXT. LATERAL BACK GASKET SP800	2	PZ
Code	Description	Qty	UOM																														
VM1631A0	PLUS INNER GLASS PUSHING CAP	4	PZ																														
VM1794A0	250X4.8 PA66 BLACK CLAMP	1	PZ																														
VM2103A0	CLAMP LOCK	1	PZ																														
VM2493A0	BL SP 600X400 EX LAT BOTTOM PANEL GASKE	2	PZ																														
VM2493A0	BL SP 600X400 EX LAT BOTTOM PANEL GASKE	2	PZ																														
VM2493A1	EXT. LATERAL BACK GASKET SP800	2	PZ																														

COMPONENT			SPARE PART																										
Code	Description	Image	Code	Description	Components list																								
CR1035A	L.MISS MATIC ELECTROMECHANICAL LOCK		KCR1035A	LM MATIC ELECTROMECHANICAL LOCK KIT	<table border="1"> <thead> <tr> <th>Code</th> <th>Description</th> <th>Qty</th> <th>UOM</th> </tr> </thead> <tbody> <tr> <td>CR1035A0</td> <td>L.MISS MATIC ELECTROMECHANICAL LOCK</td> <td>1</td> <td>PZ</td> </tr> <tr> <td>VM1224A0</td> <td>65MY 220MM 2 COLOURS SHRINK TUBE</td> <td>0.200</td> <td>M</td> </tr> </tbody> </table>	Code	Description	Qty	UOM	CR1035A0	L.MISS MATIC ELECTROMECHANICAL LOCK	1	PZ	VM1224A0	65MY 220MM 2 COLOURS SHRINK TUBE	0.200	M												
Code	Description	Qty	UOM																										
CR1035A0	L.MISS MATIC ELECTROMECHANICAL LOCK	1	PZ																										
VM1224A0	65MY 220MM 2 COLOURS SHRINK TUBE	0.200	M																										
CE1297A			KCE1297A	BL SHOP.PRO CABLE LOCK KIT	<table border="1"> <thead> <tr> <th>Code</th> <th>Description</th> <th>Qty</th> <th>UOM</th> </tr> </thead> <tbody> <tr> <td>CE1295A1</td> <td>CABLE FOR ELECTROMAGNETIC LOCKING SYSTEM</td> <td>1</td> <td>PZ</td> </tr> <tr> <td>CE1735A0</td> <td>MINIFIT FEMALE END FITTING</td> <td>4</td> <td>PZ</td> </tr> <tr> <td>CE1746A0</td> <td>2 WAYS MALE MINIFIT CONNECTOR</td> <td>1</td> <td>PZ</td> </tr> <tr> <td>CE1750A0</td> <td>3 WAYS MALE MINIFIT CONNECTOR</td> <td>1</td> <td>PZ</td> </tr> <tr> <td>VM1224A0</td> <td>65MY 220MM 2 COLOURS SHRINK TUBE</td> <td>0.250</td> <td>M</td> </tr> </tbody> </table>	Code	Description	Qty	UOM	CE1295A1	CABLE FOR ELECTROMAGNETIC LOCKING SYSTEM	1	PZ	CE1735A0	MINIFIT FEMALE END FITTING	4	PZ	CE1746A0	2 WAYS MALE MINIFIT CONNECTOR	1	PZ	CE1750A0	3 WAYS MALE MINIFIT CONNECTOR	1	PZ	VM1224A0	65MY 220MM 2 COLOURS SHRINK TUBE	0.250	M
Code	Description	Qty	UOM																										
CE1295A1	CABLE FOR ELECTROMAGNETIC LOCKING SYSTEM	1	PZ																										
CE1735A0	MINIFIT FEMALE END FITTING	4	PZ																										
CE1746A0	2 WAYS MALE MINIFIT CONNECTOR	1	PZ																										
CE1750A0	3 WAYS MALE MINIFIT CONNECTOR	1	PZ																										
VM1224A0	65MY 220MM 2 COLOURS SHRINK TUBE	0.250	M																										
VM2154A	ELECTRIC LOCKING COVER		KVM2154A	LINEMISS MATIC-TOP LOCKING COVER KI	<table border="1"> <thead> <tr> <th>Code</th> <th>Description</th> <th>Qty</th> <th>UOM</th> </tr> </thead> <tbody> <tr> <td>0H1234A0</td> <td>DOOR LOCK PANEL</td> <td>1</td> <td>PZ</td> </tr> <tr> <td>VM1224A0</td> <td>65MY 220MM 2 COLOURS SHRINK TUBE</td> <td>0.300</td> <td>M</td> </tr> <tr> <td>VM2154A0</td> <td>LINE MISS TOP ELECTRONIC LOCK COVER</td> <td>1</td> <td>PZ</td> </tr> <tr> <td>VM2154A1</td> <td>ELECTRIC LOCKING COVER</td> <td>1</td> <td>PZ</td> </tr> </tbody> </table>	Code	Description	Qty	UOM	0H1234A0	DOOR LOCK PANEL	1	PZ	VM1224A0	65MY 220MM 2 COLOURS SHRINK TUBE	0.300	M	VM2154A0	LINE MISS TOP ELECTRONIC LOCK COVER	1	PZ	VM2154A1	ELECTRIC LOCKING COVER	1	PZ				
Code	Description	Qty	UOM																										
0H1234A0	DOOR LOCK PANEL	1	PZ																										
VM1224A0	65MY 220MM 2 COLOURS SHRINK TUBE	0.300	M																										
VM2154A0	LINE MISS TOP ELECTRONIC LOCK COVER	1	PZ																										
VM2154A1	ELECTRIC LOCKING COVER	1	PZ																										
0H1234A	DOOR LOCK PANEL		KVM2154A	LINEMISS MATIC-TOP LOCKING COVER KI	<table border="1"> <thead> <tr> <th>Code</th> <th>Description</th> <th>Qty</th> <th>UOM</th> </tr> </thead> <tbody> <tr> <td>0H1234A0</td> <td>DOOR LOCK PANEL</td> <td>1</td> <td>PZ</td> </tr> <tr> <td>VM1224A0</td> <td>65MY 220MM 2 COLOURS SHRINK TUBE</td> <td>0.300</td> <td>M</td> </tr> <tr> <td>VM2154A0</td> <td>LINE MISS TOP ELECTRONIC LOCK COVER</td> <td>1</td> <td>PZ</td> </tr> <tr> <td>VM2154A1</td> <td>ELECTRIC LOCKING COVER</td> <td>1</td> <td>PZ</td> </tr> </tbody> </table>	Code	Description	Qty	UOM	0H1234A0	DOOR LOCK PANEL	1	PZ	VM1224A0	65MY 220MM 2 COLOURS SHRINK TUBE	0.300	M	VM2154A0	LINE MISS TOP ELECTRONIC LOCK COVER	1	PZ	VM2154A1	ELECTRIC LOCKING COVER	1	PZ				
Code	Description	Qty	UOM																										
0H1234A0	DOOR LOCK PANEL	1	PZ																										
VM1224A0	65MY 220MM 2 COLOURS SHRINK TUBE	0.300	M																										
VM2154A0	LINE MISS TOP ELECTRONIC LOCK COVER	1	PZ																										
VM2154A1	ELECTRIC LOCKING COVER	1	PZ																										



COMPONENT			SPARE PART																		
Code	Description	Image	Code	Description	Components list																
VM2290A	ELECTRIC LOCKING BLIND COVER		KVM2290A	BLSP BLIND LOCKING COVER KI	<table border="1"> <thead> <tr> <th>Code</th> <th>Description</th> <th>Qty</th> <th>UOM</th> </tr> </thead> <tbody> <tr> <td>VI1024A0</td> <td>SCREW M4X12 TCB + INOX DIN 7985</td> <td>2</td> <td>PZ</td> </tr> <tr> <td>VM1224A0</td> <td>65MY 220MM 2 COLOURS SHRINK TUBE</td> <td>0.300</td> <td>M</td> </tr> <tr> <td>VM2290A0</td> <td>ELECTRIC LOCKING BLIND COVER</td> <td>1</td> <td>PZ</td> </tr> </tbody> </table>	Code	Description	Qty	UOM	VI1024A0	SCREW M4X12 TCB + INOX DIN 7985	2	PZ	VM1224A0	65MY 220MM 2 COLOURS SHRINK TUBE	0.300	M	VM2290A0	ELECTRIC LOCKING BLIND COVER	1	PZ
Code	Description	Qty	UOM																		
VI1024A0	SCREW M4X12 TCB + INOX DIN 7985	2	PZ																		
VM1224A0	65MY 220MM 2 COLOURS SHRINK TUBE	0.300	M																		
VM2290A0	ELECTRIC LOCKING BLIND COVER	1	PZ																		
VI1995A	M5X25 ST.STEEL SCREW		VI1995A0	M5X25 ST.STEEL SCREW																	
VM1240A	NYLON SUPPORT CAP		KVM1240A	4 PCS COUNTER BRACKET SUPPORT CAP KIT	<table border="1"> <thead> <tr> <th>Code</th> <th>Description</th> <th>Qty</th> <th>UOM</th> </tr> </thead> <tbody> <tr> <td>VM1224A0</td> <td>65MY 220MM 2 COLOURS SHRINK TUBE</td> <td>0.200</td> <td>M</td> </tr> <tr> <td>VM1240A0</td> <td>NYLON SUPPORT CAP</td> <td>4</td> <td>PZ</td> </tr> </tbody> </table>	Code	Description	Qty	UOM	VM1224A0	65MY 220MM 2 COLOURS SHRINK TUBE	0.200	M	VM1240A0	NYLON SUPPORT CAP	4	PZ				
Code	Description	Qty	UOM																		
VM1224A0	65MY 220MM 2 COLOURS SHRINK TUBE	0.200	M																		
VM1240A0	NYLON SUPPORT CAP	4	PZ																		
0H7850A	SHOP PRO DOOR COUNTERBRACKET		0H7850A0	SHOP PRO DOOR COUNTERBRACKET																	
VI0515A	STAINLESS STEEL WASHER D=5 6592		VI0515A0	STAINLESS STEEL WASHER D=5 6592																	









COMPONENT			SPARE PART																																		
Code	Description	Image	Code	Description	Components list																																
VM2460A	BL SP LATERAL DOOR UPPER BRACKET COVER		KVM2460A	BL SP LAT DOOR UPP BRACKET COVER 2PC KIT	<table border="1"> <thead> <tr> <th>Code</th> <th>Description</th> <th>Qty</th> <th>UOM</th> </tr> </thead> <tbody> <tr> <td>VM1224A0</td> <td>65MY 220MM 2 COLOURS SHRINK TUBE</td> <td>0.250</td> <td>M</td> </tr> <tr> <td>VM2460A0</td> <td>BL SP LATERAL DOOR UPPER BRACKET COVER</td> <td>1</td> <td>PZ</td> </tr> <tr> <td>VM2460A0</td> <td>BL SP LATERAL DOOR UPPER BRACKET COVER</td> <td>1</td> <td>PZ</td> </tr> </tbody> </table>	Code	Description	Qty	UOM	VM1224A0	65MY 220MM 2 COLOURS SHRINK TUBE	0.250	M	VM2460A0	BL SP LATERAL DOOR UPPER BRACKET COVER	1	PZ	VM2460A0	BL SP LATERAL DOOR UPPER BRACKET COVER	1	PZ																
Code	Description	Qty	UOM																																		
VM1224A0	65MY 220MM 2 COLOURS SHRINK TUBE	0.250	M																																		
VM2460A0	BL SP LATERAL DOOR UPPER BRACKET COVER	1	PZ																																		
VM2460A0	BL SP LATERAL DOOR UPPER BRACKET COVER	1	PZ																																		
VM2459A	SP LATERAL DOOR UPPER BRACKET		KVM2459A	BL SP LATERAL DOOR UPPER BRACKET KIT	<table border="1"> <thead> <tr> <th>Code</th> <th>Description</th> <th>Qty</th> <th>UOM</th> </tr> </thead> <tbody> <tr> <td>VI0515A0</td> <td>STAINLESS STEEL WASHER D=5 6592</td> <td>4</td> <td>PZ</td> </tr> <tr> <td>VI1995A0</td> <td>M5X25 ST.STEEL SCREW</td> <td>4</td> <td>PZ</td> </tr> <tr> <td>VM1224A0</td> <td>65MY 220MM 2 COLOURS SHRINK TUBE</td> <td>0.300</td> <td>M</td> </tr> <tr> <td>VM2459A1</td> <td>SP LATERAL DOOR UPPER BRACKET</td> <td>1</td> <td>PZ</td> </tr> <tr> <td>VM2459A1</td> <td>SP LATERAL DOOR UPPER BRACKET</td> <td>1</td> <td>PZ</td> </tr> <tr> <td>VM2460A0</td> <td>BL SP LATERAL DOOR UPPER BRACKET COVER</td> <td>1</td> <td>PZ</td> </tr> <tr> <td>VM2460A0</td> <td>BL SP LATERAL DOOR UPPER BRACKET COVER</td> <td>1</td> <td>PZ</td> </tr> </tbody> </table>	Code	Description	Qty	UOM	VI0515A0	STAINLESS STEEL WASHER D=5 6592	4	PZ	VI1995A0	M5X25 ST.STEEL SCREW	4	PZ	VM1224A0	65MY 220MM 2 COLOURS SHRINK TUBE	0.300	M	VM2459A1	SP LATERAL DOOR UPPER BRACKET	1	PZ	VM2459A1	SP LATERAL DOOR UPPER BRACKET	1	PZ	VM2460A0	BL SP LATERAL DOOR UPPER BRACKET COVER	1	PZ	VM2460A0	BL SP LATERAL DOOR UPPER BRACKET COVER	1	PZ
Code	Description	Qty	UOM																																		
VI0515A0	STAINLESS STEEL WASHER D=5 6592	4	PZ																																		
VI1995A0	M5X25 ST.STEEL SCREW	4	PZ																																		
VM1224A0	65MY 220MM 2 COLOURS SHRINK TUBE	0.300	M																																		
VM2459A1	SP LATERAL DOOR UPPER BRACKET	1	PZ																																		
VM2459A1	SP LATERAL DOOR UPPER BRACKET	1	PZ																																		
VM2460A0	BL SP LATERAL DOOR UPPER BRACKET COVER	1	PZ																																		
VM2460A0	BL SP LATERAL DOOR UPPER BRACKET COVER	1	PZ																																		
VI1995A	M5X25 ST.STEEL SCREW		VI1995A0	M5X25 ST.STEEL SCREW																																	



COMPONENT			SPARE PART																																		
Code	Description	Image	Code	Description	Components list																																
VM1240A	NYLON SUPPORT CAP		KVM1240A	4 PCS COUNTER BRACKET SUPPORT CAP KIT	<table border="1"> <thead> <tr> <th>Code</th> <th>Description</th> <th>Qty</th> <th>UOM</th> </tr> </thead> <tbody> <tr> <td>VM1224A0</td> <td>65MY 220MM 2 COLOURS SHRINK TUBE</td> <td>0.200</td> <td>M</td> </tr> <tr> <td>VM1240A0</td> <td>NYLON SUPPORT CAP</td> <td>4</td> <td>PZ</td> </tr> </tbody> </table>	Code	Description	Qty	UOM	VM1224A0	65MY 220MM 2 COLOURS SHRINK TUBE	0.200	M	VM1240A0	NYLON SUPPORT CAP	4	PZ																				
Code	Description	Qty	UOM																																		
VM1224A0	65MY 220MM 2 COLOURS SHRINK TUBE	0.200	M																																		
VM1240A0	NYLON SUPPORT CAP	4	PZ																																		
0H7850A	SHOP PRO DOOR COUNTERBRACKET		0H7850A0	SHOP PRO DOOR COUNTERBRACKET																																	
VI0515A	STAINLESS STEEL WASHER D=5 6592		VI0515A0	STAINLESS STEEL WASHER D=5 6592																																	
VM2457A	BL SP LATERAL DOOR LOWER BRACKET		KVM2457A	BL SP LATERAL DOOR LOWER BRACKET KIT	<table border="1"> <thead> <tr> <th>Code</th> <th>Description</th> <th>Qty</th> <th>UOM</th> </tr> </thead> <tbody> <tr> <td>VI0515A0</td> <td>STAINLESS STEEL WASHER D=5 6592</td> <td>2</td> <td>PZ</td> </tr> <tr> <td>VI1995A0</td> <td>M5X25 ST.STEEL SCREW</td> <td>2</td> <td>PZ</td> </tr> <tr> <td>VM1224A0</td> <td>65MY 220MM 2 COLOURS SHRINK TUBE</td> <td>0.300</td> <td>M</td> </tr> <tr> <td>VM2457A0</td> <td>BL SP LATERAL DOOR LOWER BRACKET</td> <td>1</td> <td>PZ</td> </tr> <tr> <td>VM2457A0</td> <td>BL SP LATERAL DOOR LOWER BRACKET</td> <td>1</td> <td>PZ</td> </tr> <tr> <td>VM2458A0</td> <td>BL SP LATERAL DOOR LOW BRACKET COVER</td> <td>1</td> <td>PZ</td> </tr> <tr> <td>VM2458A0</td> <td>BL SP LATERAL DOOR LOW BRACKET COVER</td> <td>1</td> <td>PZ</td> </tr> </tbody> </table>	Code	Description	Qty	UOM	VI0515A0	STAINLESS STEEL WASHER D=5 6592	2	PZ	VI1995A0	M5X25 ST.STEEL SCREW	2	PZ	VM1224A0	65MY 220MM 2 COLOURS SHRINK TUBE	0.300	M	VM2457A0	BL SP LATERAL DOOR LOWER BRACKET	1	PZ	VM2457A0	BL SP LATERAL DOOR LOWER BRACKET	1	PZ	VM2458A0	BL SP LATERAL DOOR LOW BRACKET COVER	1	PZ	VM2458A0	BL SP LATERAL DOOR LOW BRACKET COVER	1	PZ
Code	Description	Qty	UOM																																		
VI0515A0	STAINLESS STEEL WASHER D=5 6592	2	PZ																																		
VI1995A0	M5X25 ST.STEEL SCREW	2	PZ																																		
VM1224A0	65MY 220MM 2 COLOURS SHRINK TUBE	0.300	M																																		
VM2457A0	BL SP LATERAL DOOR LOWER BRACKET	1	PZ																																		
VM2457A0	BL SP LATERAL DOOR LOWER BRACKET	1	PZ																																		
VM2458A0	BL SP LATERAL DOOR LOW BRACKET COVER	1	PZ																																		
VM2458A0	BL SP LATERAL DOOR LOW BRACKET COVER	1	PZ																																		



COMPONENT			SPARE PART																		
Code	Description	Image	Code	Description	Components list																
VM2458A	BL SP LATERAL DOOR LOW BRACKET COVER		KVM2458A	BL SP LAT DOOR LOW BRACKET COVER 2PC KIT	<table border="1"> <thead> <tr> <th>Code</th> <th>Description</th> <th>Qty</th> <th>UOM</th> </tr> </thead> <tbody> <tr> <td>VM1224A0</td> <td>65MY 220MM 2 COLOURS SHRINK TUBE</td> <td>0.200</td> <td>M</td> </tr> <tr> <td>VM2458A0</td> <td>BL SP LATERAL DOOR LOW BRACKET COVER</td> <td>2</td> <td>PZ</td> </tr> <tr> <td>VM2458A0</td> <td>BL SP LATERAL DOOR LOW BRACKET COVER</td> <td>2</td> <td>PZ</td> </tr> </tbody> </table>	Code	Description	Qty	UOM	VM1224A0	65MY 220MM 2 COLOURS SHRINK TUBE	0.200	M	VM2458A0	BL SP LATERAL DOOR LOW BRACKET COVER	2	PZ	VM2458A0	BL SP LATERAL DOOR LOW BRACKET COVER	2	PZ
Code	Description	Qty	UOM																		
VM1224A0	65MY 220MM 2 COLOURS SHRINK TUBE	0.200	M																		
VM2458A0	BL SP LATERAL DOOR LOW BRACKET COVER	2	PZ																		
VM2458A0	BL SP LATERAL DOOR LOW BRACKET COVER	2	PZ																		
VM1240A	NYLON SUPPORT CAP		KVM1240A	4 PCS COUNTER BRACKET SUPPORT CAP KIT	<table border="1"> <thead> <tr> <th>Code</th> <th>Description</th> <th>Qty</th> <th>UOM</th> </tr> </thead> <tbody> <tr> <td>VM1224A0</td> <td>65MY 220MM 2 COLOURS SHRINK TUBE</td> <td>0.200</td> <td>M</td> </tr> <tr> <td>VM1240A0</td> <td>NYLON SUPPORT CAP</td> <td>4</td> <td>PZ</td> </tr> </tbody> </table>	Code	Description	Qty	UOM	VM1224A0	65MY 220MM 2 COLOURS SHRINK TUBE	0.200	M	VM1240A0	NYLON SUPPORT CAP	4	PZ				
Code	Description	Qty	UOM																		
VM1224A0	65MY 220MM 2 COLOURS SHRINK TUBE	0.200	M																		
VM1240A0	NYLON SUPPORT CAP	4	PZ																		
VM1195A	HOLES BLANKING PLATE XVC204/304/504/704		VM1195A0	HOLES BLANKING PLATE XVC204/304/504/704																	
0H7850A	SHOP PRO DOOR COUNTERBRACKET		0H7850A0	SHOP PRO DOOR COUNTERBRACKET																	
VM2511A	SP FRONT PANEL HOLE PLATE COVER		KVM2511A	SP FRONT PANEL HOLE PLATE COVER 2PCS KIT	<table border="1"> <thead> <tr> <th>Code</th> <th>Description</th> <th>Qty</th> <th>UOM</th> </tr> </thead> <tbody> <tr> <td>VM1224A0</td> <td>65MY 220MM 2 COLOURS SHRINK TUBE</td> <td>0.150</td> <td>M</td> </tr> <tr> <td>VM2511A0</td> <td>SP FRONT PANEL HOLE PLATE COVER</td> <td>2</td> <td>PZ</td> </tr> <tr> <td>VM2511A0</td> <td>SP FRONT PANEL HOLE PLATE COVER</td> <td>2</td> <td>PZ</td> </tr> </tbody> </table>	Code	Description	Qty	UOM	VM1224A0	65MY 220MM 2 COLOURS SHRINK TUBE	0.150	M	VM2511A0	SP FRONT PANEL HOLE PLATE COVER	2	PZ	VM2511A0	SP FRONT PANEL HOLE PLATE COVER	2	PZ
Code	Description	Qty	UOM																		
VM1224A0	65MY 220MM 2 COLOURS SHRINK TUBE	0.150	M																		
VM2511A0	SP FRONT PANEL HOLE PLATE COVER	2	PZ																		
VM2511A0	SP FRONT PANEL HOLE PLATE COVER	2	PZ																		

COMPONENT			SPARE PART																																		
Code	Description	Image	Code	Description	Components list																																
0H7992A			0H7992A0																																		
0H7996A			0H7996A0																																		
VM2509A	BL SHOP.PRO BLIND LOCK VENTILATION		KVM2509A	BL SHOP.PRO BLIND LOCK VENTILATION KIT	<table border="1"> <thead> <tr> <th>Code</th> <th>Description</th> <th>Qty</th> <th>UOM</th> </tr> </thead> <tbody> <tr> <td>VM1224A0</td> <td>65MY 220MM 2 COLOURS SHRINK TUBE</td> <td>0.300</td> <td>M</td> </tr> <tr> <td>VM2509A1</td> <td>BL SHOP.PRO BLIND LOCK VENTILATION</td> <td>1</td> <td>PZ</td> </tr> <tr> <td>VM2509A1</td> <td>BL SHOP.PRO BLIND LOCK VENTILATION</td> <td>1</td> <td>PZ</td> </tr> </tbody> </table>	Code	Description	Qty	UOM	VM1224A0	65MY 220MM 2 COLOURS SHRINK TUBE	0.300	M	VM2509A1	BL SHOP.PRO BLIND LOCK VENTILATION	1	PZ	VM2509A1	BL SHOP.PRO BLIND LOCK VENTILATION	1	PZ																
Code	Description	Qty	UOM																																		
VM1224A0	65MY 220MM 2 COLOURS SHRINK TUBE	0.300	M																																		
VM2509A1	BL SHOP.PRO BLIND LOCK VENTILATION	1	PZ																																		
VM2509A1	BL SHOP.PRO BLIND LOCK VENTILATION	1	PZ																																		
VM2488A	BL SHOP.PRO MANUAL UNLOCK SYSTEM		KVM2488A	BL SHOP.PRO MANUAL UNLOCK SYSTEM KIT	<table border="1"> <thead> <tr> <th>Code</th> <th>Description</th> <th>Qty</th> <th>UOM</th> </tr> </thead> <tbody> <tr> <td>VI1220A1</td> <td>4,2X12 TCB SELF-TAPPIN G SCREW</td> <td>2</td> <td>PZ</td> </tr> <tr> <td>VI1950A0</td> <td>ST. STEEL 4,2X13 TCB SELF-DRILLIN G SCREW</td> <td>2</td> <td>PZ</td> </tr> <tr> <td>VM1224A0</td> <td>65MY 220MM 2 COLOURS SHRINK TUBE</td> <td>0.300</td> <td>M</td> </tr> <tr> <td>VM2488A1</td> <td>BL SHOP.PRO MANUAL UNLOCK SYSTEM</td> <td>1</td> <td>PZ</td> </tr> <tr> <td>VM2488A1</td> <td>BL SHOP.PRO MANUAL UNLOCK SYSTEM</td> <td>1</td> <td>PZ</td> </tr> <tr> <td>VM2501A0</td> <td>BL SHOP.PRO UNLOCK SCREW</td> <td>1</td> <td>PZ</td> </tr> <tr> <td>VM2501A0</td> <td>BL SHOP.PRO UNLOCK SCREW</td> <td>1</td> <td>PZ</td> </tr> </tbody> </table>	Code	Description	Qty	UOM	VI1220A1	4,2X12 TCB SELF-TAPPIN G SCREW	2	PZ	VI1950A0	ST. STEEL 4,2X13 TCB SELF-DRILLIN G SCREW	2	PZ	VM1224A0	65MY 220MM 2 COLOURS SHRINK TUBE	0.300	M	VM2488A1	BL SHOP.PRO MANUAL UNLOCK SYSTEM	1	PZ	VM2488A1	BL SHOP.PRO MANUAL UNLOCK SYSTEM	1	PZ	VM2501A0	BL SHOP.PRO UNLOCK SCREW	1	PZ	VM2501A0	BL SHOP.PRO UNLOCK SCREW	1	PZ
Code	Description	Qty	UOM																																		
VI1220A1	4,2X12 TCB SELF-TAPPIN G SCREW	2	PZ																																		
VI1950A0	ST. STEEL 4,2X13 TCB SELF-DRILLIN G SCREW	2	PZ																																		
VM1224A0	65MY 220MM 2 COLOURS SHRINK TUBE	0.300	M																																		
VM2488A1	BL SHOP.PRO MANUAL UNLOCK SYSTEM	1	PZ																																		
VM2488A1	BL SHOP.PRO MANUAL UNLOCK SYSTEM	1	PZ																																		
VM2501A0	BL SHOP.PRO UNLOCK SCREW	1	PZ																																		
VM2501A0	BL SHOP.PRO UNLOCK SCREW	1	PZ																																		







COMPONENT			SPARE PART														
Code	Description	Image	Code	Description	Components list												
0E1382A	SP800 EXTERNAL BOTTOM PANEL		0E1382A1	SP800 EXTERNAL BOTTOM PANEL													
0D2412A	SP800 INF FRONT PROFILE RIGHT-LEFT DOOR		0D2412A1	SP800 INF FRONT PROFILE RIGHT-LEFT DOOR													
VI1995A	M5X25 ST.STEEL SCREW		VI1995A0	M5X25 ST.STEEL SCREW													
VM1240A	NYLON SUPPORT CAP		KVM1240A	4 PCS COUNTER BRACKET SUPPORT CAP KIT	<table border="1"> <thead> <tr> <th>Code</th> <th>Description</th> <th>Qty</th> <th>UOM</th> </tr> </thead> <tbody> <tr> <td>VM1224A0</td> <td>65MY 220MM 2 COLOURS SHRINK TUBE</td> <td>0.200</td> <td>M</td> </tr> <tr> <td>VM1240A0</td> <td>NYLON SUPPORT CAP</td> <td>4</td> <td>PZ</td> </tr> </tbody> </table>	Code	Description	Qty	UOM	VM1224A0	65MY 220MM 2 COLOURS SHRINK TUBE	0.200	M	VM1240A0	NYLON SUPPORT CAP	4	PZ
Code	Description	Qty	UOM														
VM1224A0	65MY 220MM 2 COLOURS SHRINK TUBE	0.200	M														
VM1240A0	NYLON SUPPORT CAP	4	PZ														
0H7850A	SHOP PRO DOOR COUNTERBRACKET		0H7850A0	SHOP PRO DOOR COUNTERBRACKET													



COMPONENT			SPARE PART																																		
Code	Description	Image	Code	Description	Components list																																
VI0515A	STAINLESS STEEL WASHER D=5 6592		VI0515A0	STAINLESS STEEL WASHER D=5 6592																																	
VM2458A	BL SP LATERAL DOOR LOW BRACKET COVER		KVM2458A	BL SP LAT DOOR LOW BRACKET COVER 2PC KIT	<table border="1"> <thead> <tr> <th>Code</th> <th>Description</th> <th>Qty</th> <th>UOM</th> </tr> </thead> <tbody> <tr> <td>VM1224A0</td> <td>65MY 220MM 2 COLOURS SHRINK TUBE</td> <td>0.200</td> <td>M</td> </tr> <tr> <td>VM2458A0</td> <td>BL SP LATERAL DOOR LOW BRACKET COVER</td> <td>2</td> <td>PZ</td> </tr> <tr> <td>VM2458A0</td> <td>BL SP LATERAL DOOR LOW BRACKET COVER</td> <td>2</td> <td>PZ</td> </tr> </tbody> </table>	Code	Description	Qty	UOM	VM1224A0	65MY 220MM 2 COLOURS SHRINK TUBE	0.200	M	VM2458A0	BL SP LATERAL DOOR LOW BRACKET COVER	2	PZ	VM2458A0	BL SP LATERAL DOOR LOW BRACKET COVER	2	PZ																
Code	Description	Qty	UOM																																		
VM1224A0	65MY 220MM 2 COLOURS SHRINK TUBE	0.200	M																																		
VM2458A0	BL SP LATERAL DOOR LOW BRACKET COVER	2	PZ																																		
VM2458A0	BL SP LATERAL DOOR LOW BRACKET COVER	2	PZ																																		
VM2469A	BL SP LATERAL DOOR HOLDER BRACKET		KVM2469A	BL SP LATERAL DOOR HOLDER BRACKET KIT	<table border="1"> <thead> <tr> <th>Code</th> <th>Description</th> <th>Qty</th> <th>UOM</th> </tr> </thead> <tbody> <tr> <td>VI0515A0</td> <td>STAINLESS STEEL WASHER D=5 6592</td> <td>2</td> <td>PZ</td> </tr> <tr> <td>VI1995A0</td> <td>M5X25 ST.STEEL SCREW</td> <td>2</td> <td>PZ</td> </tr> <tr> <td>VM1224A0</td> <td>65MY 220MM 2 COLOURS SHRINK TUBE</td> <td>0.200</td> <td>M</td> </tr> <tr> <td>VM2458A0</td> <td>BL SP LATERAL DOOR LOW BRACKET COVER</td> <td>1</td> <td>PZ</td> </tr> <tr> <td>VM2458A0</td> <td>BL SP LATERAL DOOR LOW BRACKET COVER</td> <td>1</td> <td>PZ</td> </tr> <tr> <td>VM2469A0</td> <td>BL SP LATERAL DOOR HOLDER BRACKET</td> <td>1</td> <td>PZ</td> </tr> <tr> <td>VM2469A0</td> <td>BL SP LATERAL DOOR HOLDER BRACKET</td> <td>1</td> <td>PZ</td> </tr> </tbody> </table>	Code	Description	Qty	UOM	VI0515A0	STAINLESS STEEL WASHER D=5 6592	2	PZ	VI1995A0	M5X25 ST.STEEL SCREW	2	PZ	VM1224A0	65MY 220MM 2 COLOURS SHRINK TUBE	0.200	M	VM2458A0	BL SP LATERAL DOOR LOW BRACKET COVER	1	PZ	VM2458A0	BL SP LATERAL DOOR LOW BRACKET COVER	1	PZ	VM2469A0	BL SP LATERAL DOOR HOLDER BRACKET	1	PZ	VM2469A0	BL SP LATERAL DOOR HOLDER BRACKET	1	PZ
Code	Description	Qty	UOM																																		
VI0515A0	STAINLESS STEEL WASHER D=5 6592	2	PZ																																		
VI1995A0	M5X25 ST.STEEL SCREW	2	PZ																																		
VM1224A0	65MY 220MM 2 COLOURS SHRINK TUBE	0.200	M																																		
VM2458A0	BL SP LATERAL DOOR LOW BRACKET COVER	1	PZ																																		
VM2458A0	BL SP LATERAL DOOR LOW BRACKET COVER	1	PZ																																		
VM2469A0	BL SP LATERAL DOOR HOLDER BRACKET	1	PZ																																		
VM2469A0	BL SP LATERAL DOOR HOLDER BRACKET	1	PZ																																		



COMPONENT			SPARE PART														
Code	Description	Image	Code	Description	Components list												
VN1175A	230V 50/60HZ 120X120 COOLING DOWN FAN		KVN1175A	120X120 230V 50/60HZ COOLING FAN KIT	<table border="1"> <thead> <tr> <th>Code</th> <th>Description</th> <th>Qty</th> <th>UOM</th> </tr> </thead> <tbody> <tr> <td>VN1175A0</td> <td>230V 50/60HZ 120X120 COOLING DOWN FAN</td> <td>1</td> <td>PZ</td> </tr> <tr> <td>VN1175A0</td> <td>230V 50/60HZ 120X120 COOLING DOWN FAN</td> <td>1</td> <td>PZ</td> </tr> </tbody> </table>	Code	Description	Qty	UOM	VN1175A0	230V 50/60HZ 120X120 COOLING DOWN FAN	1	PZ	VN1175A0	230V 50/60HZ 120X120 COOLING DOWN FAN	1	PZ
Code	Description	Qty	UOM														
VN1175A0	230V 50/60HZ 120X120 COOLING DOWN FAN	1	PZ														
VN1175A0	230V 50/60HZ 120X120 COOLING DOWN FAN	1	PZ														
VM2495A	SP COOLING FAN SUPPORT		KVM2495A	COOLING FAN SUPPORT KIT	<table border="1"> <thead> <tr> <th>Code</th> <th>Description</th> <th>Qty</th> <th>UOM</th> </tr> </thead> <tbody> <tr> <td>VH1220A1</td> <td>4,2X12 TCB SELF-TAPPIN G SCREW</td> <td>2</td> <td>PZ</td> </tr> <tr> <td>VM2495A0</td> <td>SP COOLING FAN SUPPORT</td> <td>1</td> <td>PZ</td> </tr> </tbody> </table>	Code	Description	Qty	UOM	VH1220A1	4,2X12 TCB SELF-TAPPIN G SCREW	2	PZ	VM2495A0	SP COOLING FAN SUPPORT	1	PZ
Code	Description	Qty	UOM														
VH1220A1	4,2X12 TCB SELF-TAPPIN G SCREW	2	PZ														
VM2495A0	SP COOLING FAN SUPPORT	1	PZ														
0F1544B	ROSSELLA SHOP PRO BACK PANEL		0F1544B1	ROSSELLA SHOP PRO BACK PANEL													
0D2413A	ROSSELLA SHOP PRO COVER		0D2413A1	ROSSELLA SHOP PRO COVER													
0D2417B	ROSSELLA SHOP PRO LEFT SIDE		0D2417B0	ROSSELLA SHOP PRO LEFT SIDE													



COMPONENT			SPARE PART		
<i>Code</i>	<i>Description</i>	<i>Image</i>	<i>Code</i>	<i>Description</i>	<i>Components list</i>
0D2418B	ROSSELLA SHOP PRO RIGHT SIDE		0D2418B0	ROSSELLA SHOP PRO RIGHT SIDE	