

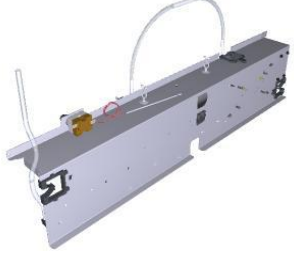

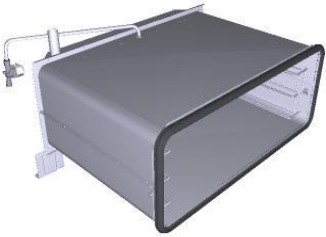

| Assembly code | Assembly revision | Assembly image |
|----------------|-------------------|---|
| ASM3440A/0.D00 | Electrical system |  |
| ASM3403A/0.D00 | Cooking chamber |  |
| ASM3429A/0.D01 | Door |  |
| ASM3415A/0.D01 | External cover |  |

ASM3440A/0.D00 - Electrical system

FRONT

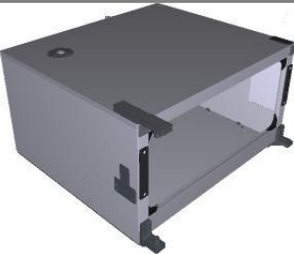
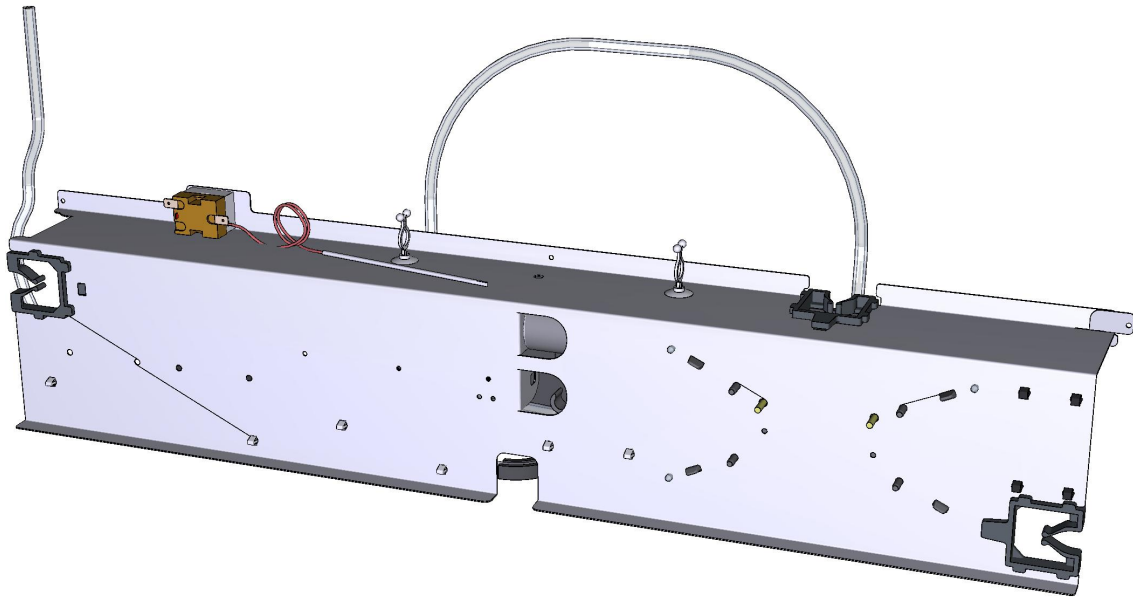



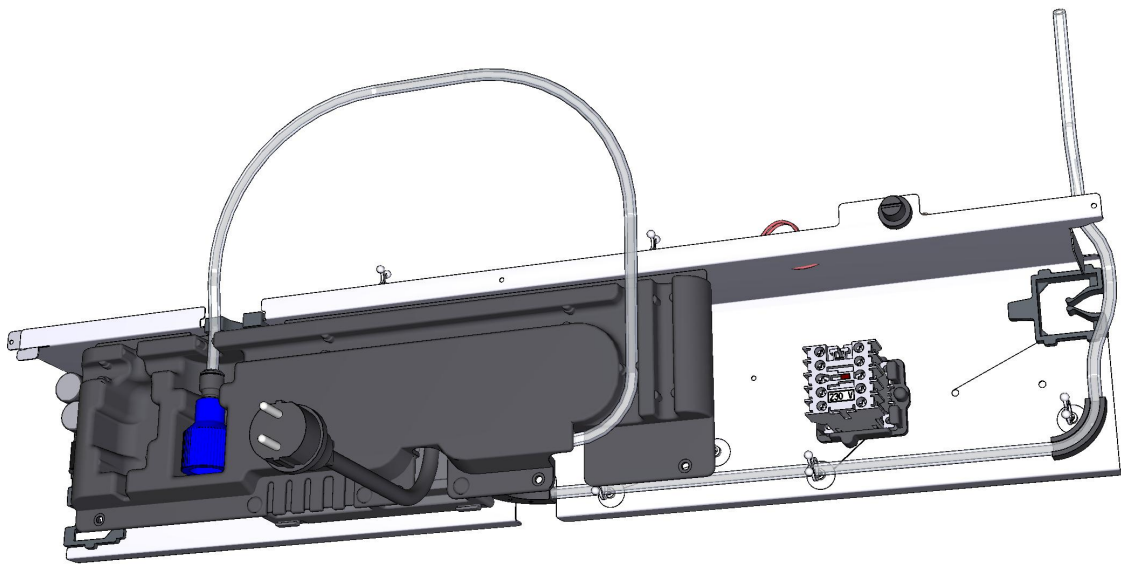

ASM3440A/0.D00 - Electrical system

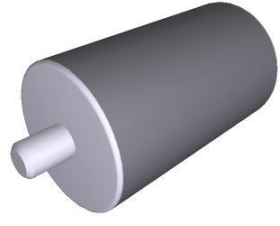
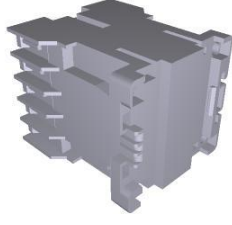

REAR





| COMPONENT | | | SPARE PART | | | | | | | | | | | | | | | | | | | | | | | | | | | | | | | | | | |
|-----------|-------------------------------------|---|------------|-----------------------------------|---|------|-------------|-----|-----|----------|---------------------------------|---|----|----------|-------------------------------------|---|----|-----------|-------------------------------------|-------|----|----------|----------------------------------|-------|---|----------|--------------------------------|---|----|----------|---------------------------------|---|----|----------|-------------------------------|---|----|
| Code | Description | Image | Code | Description | Components list | | | | | | | | | | | | | | | | | | | | | | | | | | | | | | | | |
| TR1136A | 330 °C 1 POLE SAFETY THERMOSTAT |  | KTR1136A | 330 °C SAFETY THERMOSTAT KIT | <table border="1"> <thead> <tr> <th>Code</th> <th>Description</th> <th>Qty</th> <th>UOM</th> </tr> </thead> <tbody> <tr> <td>0H7030A0</td> <td>THERMOSTAT BULB INLET COVER</td> <td>1</td> <td>PZ</td> </tr> <tr> <td>GN1531A0</td> <td>THERMOSTAT BULB INLET SEALING</td> <td>1</td> <td>PZ</td> </tr> <tr> <td>MOV0011A0</td> <td>HOOD RING GASKET</td> <td>0.100</td> <td>PZ</td> </tr> <tr> <td>GN1110A2</td> <td></td> <td></td> <td></td> </tr> <tr> <td>SL1045A0</td> <td>S57 BLACK SILICONE - CARTRIDGE</td> <td>1</td> <td>PZ</td> </tr> <tr> <td>TR1136A0</td> <td>330 °C 1 POLE SAFETY THERMOSTAT</td> <td>1</td> <td>PZ</td> </tr> <tr> <td>VI1220A1</td> <td>4,2X12 TCB SELF-TAPPING SCREW</td> <td>3</td> <td>PZ</td> </tr> </tbody> </table> | Code | Description | Qty | UOM | 0H7030A0 | THERMOSTAT BULB INLET COVER | 1 | PZ | GN1531A0 | THERMOSTAT BULB INLET SEALING | 1 | PZ | MOV0011A0 | HOOD RING GASKET | 0.100 | PZ | GN1110A2 | | | | SL1045A0 | S57 BLACK SILICONE - CARTRIDGE | 1 | PZ | TR1136A0 | 330 °C 1 POLE SAFETY THERMOSTAT | 1 | PZ | VI1220A1 | 4,2X12 TCB SELF-TAPPING SCREW | 3 | PZ |
| Code | Description | Qty | UOM | | | | | | | | | | | | | | | | | | | | | | | | | | | | | | | | | | |
| 0H7030A0 | THERMOSTAT BULB INLET COVER | 1 | PZ | | | | | | | | | | | | | | | | | | | | | | | | | | | | | | | | | | |
| GN1531A0 | THERMOSTAT BULB INLET SEALING | 1 | PZ | | | | | | | | | | | | | | | | | | | | | | | | | | | | | | | | | | |
| MOV0011A0 | HOOD RING GASKET | 0.100 | PZ | | | | | | | | | | | | | | | | | | | | | | | | | | | | | | | | | | |
| GN1110A2 | | | | | | | | | | | | | | | | | | | | | | | | | | | | | | | | | | | | | |
| SL1045A0 | S57 BLACK SILICONE - CARTRIDGE | 1 | PZ | | | | | | | | | | | | | | | | | | | | | | | | | | | | | | | | | | |
| TR1136A0 | 330 °C 1 POLE SAFETY THERMOSTAT | 1 | PZ | | | | | | | | | | | | | | | | | | | | | | | | | | | | | | | | | | |
| VI1220A1 | 4,2X12 TCB SELF-TAPPING SCREW | 3 | PZ | | | | | | | | | | | | | | | | | | | | | | | | | | | | | | | | | | |
| CN1003A | 6,3 UF MOTOR CAPACITOR |  | KCN1003A | 6,3 UF MOTOR CAPACITOR KIT | <table border="1"> <thead> <tr> <th>Code</th> <th>Description</th> <th>Qty</th> <th>UOM</th> </tr> </thead> <tbody> <tr> <td>CN1003A0</td> <td>6,3 UF MOTOR CAPACITOR</td> <td>1</td> <td>PZ</td> </tr> <tr> <td>VI1931A0</td> <td>M8 NUT+INDENTE D WASHER D=8 X COND.</td> <td>1</td> <td>PZ</td> </tr> <tr> <td>VI1932A0</td> <td>M8 NUT+INDENTE D WASHER D=8 X COND.</td> <td>1</td> <td>PZ</td> </tr> <tr> <td>VM1224A0</td> <td>65MY 220MM 2 COLOURS SHRINK TUBE</td> <td>0.200</td> <td>M</td> </tr> </tbody> </table> | Code | Description | Qty | UOM | CN1003A0 | 6,3 UF MOTOR CAPACITOR | 1 | PZ | VI1931A0 | M8 NUT+INDENTE D WASHER D=8 X COND. | 1 | PZ | VI1932A0 | M8 NUT+INDENTE D WASHER D=8 X COND. | 1 | PZ | VM1224A0 | 65MY 220MM 2 COLOURS SHRINK TUBE | 0.200 | M | | | | | | | | | | | | |
| Code | Description | Qty | UOM | | | | | | | | | | | | | | | | | | | | | | | | | | | | | | | | | | |
| CN1003A0 | 6,3 UF MOTOR CAPACITOR | 1 | PZ | | | | | | | | | | | | | | | | | | | | | | | | | | | | | | | | | | |
| VI1931A0 | M8 NUT+INDENTE D WASHER D=8 X COND. | 1 | PZ | | | | | | | | | | | | | | | | | | | | | | | | | | | | | | | | | | |
| VI1932A0 | M8 NUT+INDENTE D WASHER D=8 X COND. | 1 | PZ | | | | | | | | | | | | | | | | | | | | | | | | | | | | | | | | | | |
| VM1224A0 | 65MY 220MM 2 COLOURS SHRINK TUBE | 0.200 | M | | | | | | | | | | | | | | | | | | | | | | | | | | | | | | | | | | |
| VE1115A | 20 A 230V 4 POLES MINICONTACTOR |  | KVE1115A | 20A 230V 4 POLES MINICONTACTOR KI | <table border="1"> <thead> <tr> <th>Code</th> <th>Description</th> <th>Qty</th> <th>UOM</th> </tr> </thead> <tbody> <tr> <td>VE1115A0</td> <td>20 A 230V 4 POLES MINICONTACTOR</td> <td>1</td> <td>PZ</td> </tr> <tr> <td>VM1075A1</td> <td>PLASTIC CLIP TO FIX CONTACTORS</td> <td>4</td> <td>PZ</td> </tr> <tr> <td>VM1224A0</td> <td>65MY 220MM 2 COLOURS SHRINK TUBE</td> <td>0.250</td> <td>M</td> </tr> </tbody> </table> | Code | Description | Qty | UOM | VE1115A0 | 20 A 230V 4 POLES MINICONTACTOR | 1 | PZ | VM1075A1 | PLASTIC CLIP TO FIX CONTACTORS | 4 | PZ | VM1224A0 | 65MY 220MM 2 COLOURS SHRINK TUBE | 0.250 | M | | | | | | | | | | | | | | | | |
| Code | Description | Qty | UOM | | | | | | | | | | | | | | | | | | | | | | | | | | | | | | | | | | |
| VE1115A0 | 20 A 230V 4 POLES MINICONTACTOR | 1 | PZ | | | | | | | | | | | | | | | | | | | | | | | | | | | | | | | | | | |
| VM1075A1 | PLASTIC CLIP TO FIX CONTACTORS | 4 | PZ | | | | | | | | | | | | | | | | | | | | | | | | | | | | | | | | | | |
| VM1224A0 | 65MY 220MM 2 COLOURS SHRINK TUBE | 0.250 | M | | | | | | | | | | | | | | | | | | | | | | | | | | | | | | | | | | |

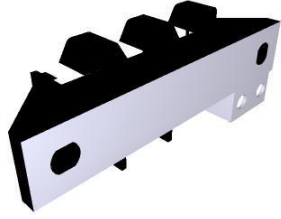

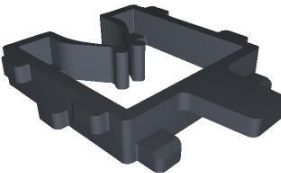
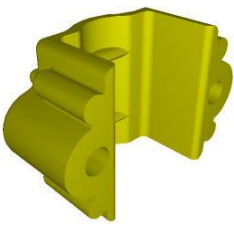

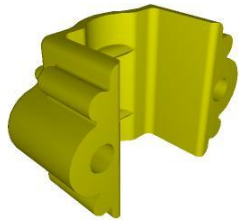
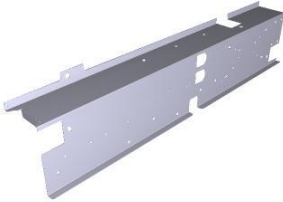
| COMPONENT | | | SPARE PART | | | | | | | | | | | | | | | | | | | | | | | | | | | | | | |
|-----------|---|---|------------|--|--|------|-------------|-----|-----|----------|---|----|----|----------|-------------------------------------|-------|----|----------|------------------------------------|---|----|----------|---------------------------------------|---|----|----------|----------------------------|---|----|----------|--------------------------------------|---|----|
| Code | Description | Image | Code | Description | Components list | | | | | | | | | | | | | | | | | | | | | | | | | | | | |
| VM1056A | SMALL CONTACTOR BRACKET VE1115A |  | VM1056A0 | SMALL CONTACTOR BRACKET VE1115A | | | | | | | | | | | | | | | | | | | | | | | | | | | | | |
| RC1006A | D8 PET PIPE GUIDE BEND |  | KRC1006A | 20 PCS. Ø8 PET PIPE GUIDE BEND KI | <table border="1"> <thead> <tr> <th>Code</th> <th>Description</th> <th>Qty</th> <th>UOM</th> </tr> </thead> <tbody> <tr> <td>RC1006A0</td> <td>D8 PET PIPE GUIDE BEND</td> <td>20</td> <td>PZ</td> </tr> <tr> <td>VM1224A0</td> <td>65MY 220MM 2 COLOURS SHRINK TUBE</td> <td>0.200</td> <td>M</td> </tr> </tbody> </table> | Code | Description | Qty | UOM | RC1006A0 | D8 PET PIPE GUIDE BEND | 20 | PZ | VM1224A0 | 65MY 220MM 2 COLOURS SHRINK TUBE | 0.200 | M | | | | | | | | | | | | | | | | |
| Code | Description | Qty | UOM | | | | | | | | | | | | | | | | | | | | | | | | | | | | | | |
| RC1006A0 | D8 PET PIPE GUIDE BEND | 20 | PZ | | | | | | | | | | | | | | | | | | | | | | | | | | | | | | |
| VM1224A0 | 65MY 220MM 2 COLOURS SHRINK TUBE | 0.200 | M | | | | | | | | | | | | | | | | | | | | | | | | | | | | | | |
| VM1187A | POWER BOARD FRAME SHOP.PRO |  | VM1187A0 | POWER BOARD FRAME SHOP.PRO | | | | | | | | | | | | | | | | | | | | | | | | | | | | | |
| PE2102A | BL LED/TOUCH/PLUS 230 V POWER CARD |  | KPE2102A | BL LED/TOUCH/MASTE R 230V POWER CARD KIT | <table border="1"> <thead> <tr> <th>Code</th> <th>Description</th> <th>Qty</th> <th>UOM</th> </tr> </thead> <tbody> <tr> <td>PE2102A0</td> <td>BL LED/TOUCH/P LUS 230V POWER BOARD KIT</td> <td>1</td> <td>PZ</td> </tr> <tr> <td>PE2102A1</td> <td>BL LED/TOUCH/P LUS 230 V POWER CARD</td> <td>1</td> <td>PZ</td> </tr> <tr> <td>PE2102A2</td> <td>BL LED/TOUCH/P LUS 230V POWER BOAR</td> <td>1</td> <td>PZ</td> </tr> <tr> <td>VI1988A0</td> <td>AUTOTHREAD ING SCREW 4,2X19 TCB+ INOX</td> <td>3</td> <td>PZ</td> </tr> <tr> <td>VM1187A0</td> <td>POWER BOARD FRAME SHOP.PRO</td> <td>1</td> <td>PZ</td> </tr> <tr> <td>VM2147A0</td> <td>410X343X15 MM PINK SMOOTH ESD SPONGE</td> <td>1</td> <td>PZ</td> </tr> </tbody> </table> | Code | Description | Qty | UOM | PE2102A0 | BL LED/TOUCH/P LUS 230V POWER BOARD KIT | 1 | PZ | PE2102A1 | BL LED/TOUCH/P LUS 230 V POWER CARD | 1 | PZ | PE2102A2 | BL LED/TOUCH/P LUS 230V POWER BOAR | 1 | PZ | VI1988A0 | AUTOTHREAD ING SCREW 4,2X19 TCB+ INOX | 3 | PZ | VM1187A0 | POWER BOARD FRAME SHOP.PRO | 1 | PZ | VM2147A0 | 410X343X15 MM PINK SMOOTH ESD SPONGE | 1 | PZ |
| Code | Description | Qty | UOM | | | | | | | | | | | | | | | | | | | | | | | | | | | | | | |
| PE2102A0 | BL LED/TOUCH/P LUS 230V POWER BOARD KIT | 1 | PZ | | | | | | | | | | | | | | | | | | | | | | | | | | | | | | |
| PE2102A1 | BL LED/TOUCH/P LUS 230 V POWER CARD | 1 | PZ | | | | | | | | | | | | | | | | | | | | | | | | | | | | | | |
| PE2102A2 | BL LED/TOUCH/P LUS 230V POWER BOAR | 1 | PZ | | | | | | | | | | | | | | | | | | | | | | | | | | | | | | |
| VI1988A0 | AUTOTHREAD ING SCREW 4,2X19 TCB+ INOX | 3 | PZ | | | | | | | | | | | | | | | | | | | | | | | | | | | | | | |
| VM1187A0 | POWER BOARD FRAME SHOP.PRO | 1 | PZ | | | | | | | | | | | | | | | | | | | | | | | | | | | | | | |
| VM2147A0 | 410X343X15 MM PINK SMOOTH ESD SPONGE | 1 | PZ | | | | | | | | | | | | | | | | | | | | | | | | | | | | | | |

| COMPONENT | | | SPARE PART | | | | | | | | | | | | | | | | | | |
|--|---|---|------------|--|--|---|-------------|-----|----------|--|---|-------|----|----------|---|-------|----|----------|---|---|----|
| Code | Description | Image | Code | Description | Components list | | | | | | | | | | | | | | | | |
| CE1581A | CABLE H07RNF 3G1.5 L1.5MT+K1/6+SCHU KO |  | KCE1581A | H07RNF 3G1.5 L1.5 MT + SHUKO PLUG KIT | <table border="1"> <thead> <tr> <th>Code</th> <th>Description</th> <th>Qty</th> <th>UOM</th> </tr> </thead> <tbody> <tr> <td>CE1581A0</td> <td>CABLE H07RNF 3G1.5 L1.5MT+K1/6+ SCHUKO</td> <td>1</td> <td>PZ</td> </tr> <tr> <td>VM1224A0</td> <td>65MY 220MM 2 COLOURS SHRINK TUBE</td> <td>0.300</td> <td>M</td> </tr> </tbody> </table> | Code | Description | Qty | UOM | CE1581A0 | CABLE H07RNF 3G1.5 L1.5MT+K1/6+ SCHUKO | 1 | PZ | VM1224A0 | 65MY 220MM 2 COLOURS SHRINK TUBE | 0.300 | M | | | | |
| | | | | | Code | Description | Qty | UOM | | | | | | | | | | | | | |
| CE1581A0 | CABLE H07RNF 3G1.5 L1.5MT+K1/6+ SCHUKO | 1 | PZ | | | | | | | | | | | | | | | | | | |
| VM1224A0 | 65MY 220MM 2 COLOURS SHRINK TUBE | 0.300 | M | | | | | | | | | | | | | | | | | | |
| <table border="1"> <thead> <tr> <th>Code</th> <th>Description</th> <th>Qty</th> <th>UOM</th> </tr> </thead> <tbody> <tr> <td>MR1025A1</td> <td>3 POLES 450V 41A+GROUND TERMINAL BLOCK</td> <td>1</td> <td>PZ</td> </tr> <tr> <td>VM1224A0</td> <td>65MY 220MM 2 COLOURS SHRINK TUBE</td> <td>0.150</td> <td>M</td> </tr> </tbody> </table> | Code | Description | Qty | UOM | MR1025A1 | 3 POLES 450V 41A+GROUND TERMINAL BLOCK | 1 | PZ | VM1224A0 | 65MY 220MM 2 COLOURS SHRINK TUBE | 0.150 | M | | | | | | | | | |
| Code | Description | Qty | UOM | | | | | | | | | | | | | | | | | | |
| MR1025A1 | 3 POLES 450V 41A+GROUND TERMINAL BLOCK | 1 | PZ | | | | | | | | | | | | | | | | | | |
| VM1224A0 | 65MY 220MM 2 COLOURS SHRINK TUBE | 0.150 | M | | | | | | | | | | | | | | | | | | |
| MR1025A | 3 POLES 450V 41A+GROUND TERMINAL BLOCK |  | KMR1025A | 3 POLES TERMINAL BLOCK KIT | <table border="1"> <thead> <tr> <th>Code</th> <th>Description</th> <th>Qty</th> <th>UOM</th> </tr> </thead> <tbody> <tr> <td>MR1025A1</td> <td>3 POLES 450V 41A+GROUND TERMINAL BLOCK</td> <td>1</td> <td>PZ</td> </tr> <tr> <td>VM1224A0</td> <td>65MY 220MM 2 COLOURS SHRINK TUBE</td> <td>0.150</td> <td>M</td> </tr> </tbody> </table> | Code | Description | Qty | UOM | MR1025A1 | 3 POLES 450V 41A+GROUND TERMINAL BLOCK | 1 | PZ | VM1224A0 | 65MY 220MM 2 COLOURS SHRINK TUBE | 0.150 | M | | | | |
| Code | Description | Qty | UOM | | | | | | | | | | | | | | | | | | |
| MR1025A1 | 3 POLES 450V 41A+GROUND TERMINAL BLOCK | 1 | PZ | | | | | | | | | | | | | | | | | | |
| VM1224A0 | 65MY 220MM 2 COLOURS SHRINK TUBE | 0.150 | M | | | | | | | | | | | | | | | | | | |
| VI1328A | |  | VI1328A0 | | | | | | | | | | | | | | | | | | |
| VM1188A | BL SHOP.PRO POWER BOARD WIRE PASSAGE |  | KVM1188A | BL SP POWER BOARD WIRE PASSAGE 10 PC KIT | <table border="1"> <thead> <tr> <th>Code</th> <th>Description</th> <th>Qty</th> <th>UOM</th> </tr> </thead> <tbody> <tr> <td>VM1188A0</td> <td>BL SHOP.PRO POWER BOARD WIRE PASSAGE</td> <td>10</td> <td>PZ</td> </tr> <tr> <td>VM1224A0</td> <td>65MY 220MM 2 COLOURS SHRINK TUBE</td> <td>0.200</td> <td>M</td> </tr> </tbody> </table> | Code | Description | Qty | UOM | VM1188A0 | BL SHOP.PRO POWER BOARD WIRE PASSAGE | 10 | PZ | VM1224A0 | 65MY 220MM 2 COLOURS SHRINK TUBE | 0.200 | M | | | | |
| | | | | | Code | Description | Qty | UOM | | | | | | | | | | | | | |
| VM1188A0 | BL SHOP.PRO POWER BOARD WIRE PASSAGE | 10 | PZ | | | | | | | | | | | | | | | | | | |
| VM1224A0 | 65MY 220MM 2 COLOURS SHRINK TUBE | 0.200 | M | | | | | | | | | | | | | | | | | | |
| <table border="1"> <thead> <tr> <th>Code</th> <th>Description</th> <th>Qty</th> <th>UOM</th> </tr> </thead> <tbody> <tr> <td>VM1224A0</td> <td>65MY 220MM 2 COLOURS SHRINK TUBE</td> <td>0.200</td> <td>M</td> </tr> </tbody> </table> | Code | Description | Qty | UOM | VM1224A0 | 65MY 220MM 2 COLOURS SHRINK TUBE | 0.200 | M | | | | | | | | | | | | | |
| Code | Description | Qty | UOM | | | | | | | | | | | | | | | | | | |
| VM1224A0 | 65MY 220MM 2 COLOURS SHRINK TUBE | 0.200 | M | | | | | | | | | | | | | | | | | | |
| VM2484A | ELECTRICAL CONNECTION CABLE CLAMP |  | KVM2484A | CABLE LOCKS ELECTRICAL CONNECTION KIT | <table border="1"> <thead> <tr> <th>Code</th> <th>Description</th> <th>Qty</th> <th>UOM</th> </tr> </thead> <tbody> <tr> <td>VM1224A0</td> <td>65MY 220MM 2 COLOURS SHRINK TUBE</td> <td>0.300</td> <td>M</td> </tr> <tr> <td>VM2484A0</td> <td>ELECTRICAL CONNECTION CABLE CLAMP</td> <td>1</td> <td>PZ</td> </tr> <tr> <td>VM2484A0</td> <td>ELECTRICAL CONNECTION CABLE CLAMP</td> <td>1</td> <td>PZ</td> </tr> </tbody> </table> | Code | Description | Qty | UOM | VM1224A0 | 65MY 220MM 2 COLOURS SHRINK TUBE | 0.300 | M | VM2484A0 | ELECTRICAL CONNECTION CABLE CLAMP | 1 | PZ | VM2484A0 | ELECTRICAL CONNECTION CABLE CLAMP | 1 | PZ |
| | | | | | Code | Description | Qty | UOM | | | | | | | | | | | | | |
| | | | | | VM1224A0 | 65MY 220MM 2 COLOURS SHRINK TUBE | 0.300 | M | | | | | | | | | | | | | |
| VM2484A0 | ELECTRICAL CONNECTION CABLE CLAMP | 1 | PZ | | | | | | | | | | | | | | | | | | |
| VM2484A0 | ELECTRICAL CONNECTION CABLE CLAMP | 1 | PZ | | | | | | | | | | | | | | | | | | |
| <table border="1"> <thead> <tr> <th>Code</th> <th>Description</th> <th>Qty</th> <th>UOM</th> </tr> </thead> <tbody> <tr> <td>VM1224A0</td> <td>65MY 220MM 2 COLOURS SHRINK TUBE</td> <td>0.300</td> <td>M</td> </tr> </tbody> </table> | Code | Description | Qty | UOM | VM1224A0 | 65MY 220MM 2 COLOURS SHRINK TUBE | 0.300 | M | | | | | | | | | | | | | |
| Code | Description | Qty | UOM | | | | | | | | | | | | | | | | | | |
| VM1224A0 | 65MY 220MM 2 COLOURS SHRINK TUBE | 0.300 | M | | | | | | | | | | | | | | | | | | |
| <table border="1"> <thead> <tr> <th>Code</th> <th>Description</th> <th>Qty</th> <th>UOM</th> </tr> </thead> <tbody> <tr> <td>VM2484A0</td> <td>ELECTRICAL CONNECTION CABLE CLAMP</td> <td>1</td> <td>PZ</td> </tr> </tbody> </table> | Code | Description | Qty | UOM | VM2484A0 | ELECTRICAL CONNECTION CABLE CLAMP | 1 | PZ | | | | | | | | | | | | | |
| Code | Description | Qty | UOM | | | | | | | | | | | | | | | | | | |
| VM2484A0 | ELECTRICAL CONNECTION CABLE CLAMP | 1 | PZ | | | | | | | | | | | | | | | | | | |

| COMPONENT | | | SPARE PART | | | | | | | | | | | | | | | | | | | | | | | | | | |
|-----------|--|---|------------|---|--|------|-------------|-----|-----|----------|---|-------|----|----------|--|---|----|----------|--|---|----|----------|---|---|----|----------|---|---|----|
| Code | Description | Image | Code | Description | Components list | | | | | | | | | | | | | | | | | | | | | | | | |
| VM2484A | ELECTRICAL CONNECTION CABLE CLAMP |  | KVM2482A | BAKERLUX SP ELECTR COMPONENTS HOLDER KIT | <table border="1"> <thead> <tr> <th>Code</th> <th>Description</th> <th>Qty</th> <th>UOM</th> </tr> </thead> <tbody> <tr> <td>VM1224A0</td> <td>65MY 220MM 2 COLOURS SHRINK TUBE</td> <td>0.300</td> <td>M</td> </tr> <tr> <td>VM2482A0</td> <td>ELECTR COMPONENT S HOLDER FRAME SHOP.PRO</td> <td>1</td> <td>PZ</td> </tr> <tr> <td>VM2482A0</td> <td>ELECTR COMPONENT S HOLDER FRAME SHOP.PRO</td> <td>1</td> <td>PZ</td> </tr> <tr> <td>VM2484A0</td> <td>ELECTRICAL CONNECTION CABLE CLAMP</td> <td>1</td> <td>PZ</td> </tr> <tr> <td>VM2484A0</td> <td>ELECTRICAL CONNECTION CABLE CLAMP</td> <td>1</td> <td>PZ</td> </tr> </tbody> </table> | Code | Description | Qty | UOM | VM1224A0 | 65MY 220MM 2 COLOURS SHRINK TUBE | 0.300 | M | VM2482A0 | ELECTR COMPONENT S HOLDER FRAME SHOP.PRO | 1 | PZ | VM2482A0 | ELECTR COMPONENT S HOLDER FRAME SHOP.PRO | 1 | PZ | VM2484A0 | ELECTRICAL CONNECTION CABLE CLAMP | 1 | PZ | VM2484A0 | ELECTRICAL CONNECTION CABLE CLAMP | 1 | PZ |
| Code | Description | Qty | UOM | | | | | | | | | | | | | | | | | | | | | | | | | | |
| VM1224A0 | 65MY 220MM 2 COLOURS SHRINK TUBE | 0.300 | M | | | | | | | | | | | | | | | | | | | | | | | | | | |
| VM2482A0 | ELECTR COMPONENT S HOLDER FRAME SHOP.PRO | 1 | PZ | | | | | | | | | | | | | | | | | | | | | | | | | | |
| VM2482A0 | ELECTR COMPONENT S HOLDER FRAME SHOP.PRO | 1 | PZ | | | | | | | | | | | | | | | | | | | | | | | | | | |
| VM2484A0 | ELECTRICAL CONNECTION CABLE CLAMP | 1 | PZ | | | | | | | | | | | | | | | | | | | | | | | | | | |
| VM2484A0 | ELECTRICAL CONNECTION CABLE CLAMP | 1 | PZ | | | | | | | | | | | | | | | | | | | | | | | | | | |
| OP1022A | COMPONENTS HOLDING PANEL ELE-ROS SP |  | OP1022A0 | COMPONENTS HOLDING PANEL ELE-ROS SP | | | | | | | | | | | | | | | | | | | | | | | | | |
| TB3283A | |  | KTB1959A | 7,93X4,75 PE TRANSPARENT PIPE 5M KIT | <table border="1"> <thead> <tr> <th>Code</th> <th>Description</th> <th>Qty</th> <th>UOM</th> </tr> </thead> <tbody> <tr> <td>TB1815A0</td> <td>7,93X4,75 PE TRANSP. PIPE (JG #PE08100N)</td> <td>5</td> <td>M</td> </tr> </tbody> </table> | Code | Description | Qty | UOM | TB1815A0 | 7,93X4,75 PE TRANSP. PIPE (JG #PE08100N) | 5 | M | | | | | | | | | | | | | | | | |
| Code | Description | Qty | UOM | | | | | | | | | | | | | | | | | | | | | | | | | | |
| TB1815A0 | 7,93X4,75 PE TRANSP. PIPE (JG #PE08100N) | 5 | M | | | | | | | | | | | | | | | | | | | | | | | | | | |
| PE2117A | BLSP ELECTROMECHANICAL LOCK BOARD |  | KPE2117A | ELECTRIC LOCKING SYSTEM BOARD KIT 230V | <table border="1"> <thead> <tr> <th>Code</th> <th>Description</th> <th>Qty</th> <th>UOM</th> </tr> </thead> <tbody> <tr> <td>PE2117A0</td> <td>BLSP ELECTROMECHANICAL LOCK BOARD</td> <td>1</td> <td>PZ</td> </tr> <tr> <td>VI1850A0</td> <td>M4X6 NICKEL PLATED FIXING SCREW</td> <td>2</td> <td>PZ</td> </tr> <tr> <td>VM1746A0</td> <td>H10 M4 JOINT BOARD FASTENING CLIP</td> <td>2</td> <td>PZ</td> </tr> </tbody> </table> | Code | Description | Qty | UOM | PE2117A0 | BLSP ELECTROMECHANICAL LOCK BOARD | 1 | PZ | VI1850A0 | M4X6 NICKEL PLATED FIXING SCREW | 2 | PZ | VM1746A0 | H10 M4 JOINT BOARD FASTENING CLIP | 2 | PZ | | | | | | | | |
| Code | Description | Qty | UOM | | | | | | | | | | | | | | | | | | | | | | | | | | |
| PE2117A0 | BLSP ELECTROMECHANICAL LOCK BOARD | 1 | PZ | | | | | | | | | | | | | | | | | | | | | | | | | | |
| VI1850A0 | M4X6 NICKEL PLATED FIXING SCREW | 2 | PZ | | | | | | | | | | | | | | | | | | | | | | | | | | |
| VM1746A0 | H10 M4 JOINT BOARD FASTENING CLIP | 2 | PZ | | | | | | | | | | | | | | | | | | | | | | | | | | |

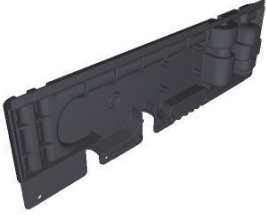
| COMPONENT | | | SPARE PART | | | | | | | | | | | | | | | | | | | | | | | | | | |
|--|--|---|------------|--|--|--|-------------|-----|----------|--|--|-------|----------|--|--|-------|----------|-----------------------------------|--|----|----------|-----------------------------------|-----------------------------------|----|----|----------|-----------------------------------|---|----|
| Code | Description | Image | Code | Description | Components list | | | | | | | | | | | | | | | | | | | | | | | | |
| PE2117A | BLSP ELECTROMECHANICAL LOCK BOARD |  | KPE2117A | ELECTRIC LOCKING SYSTEM BOARD KIT 230V | <table border="1"> <thead> <tr> <th>Code</th> <th>Description</th> <th>Qty</th> <th>UOM</th> </tr> </thead> <tbody> <tr> <td>VM1747A0</td> <td>JOINT-PIN H10 POWER BOARD FASTENING CLIP</td> <td>2</td> <td>PZ</td> </tr> <tr> <td>VM2147A0</td> <td>410X343X15 MM PINK SMOOTH ESD SPONGE</td> <td>0.500</td> <td>PZ</td> </tr> </tbody> </table> | Code | Description | Qty | UOM | VM1747A0 | JOINT-PIN H10 POWER BOARD FASTENING CLIP | 2 | PZ | VM2147A0 | 410X343X15 MM PINK SMOOTH ESD SPONGE | 0.500 | PZ | | | | | | | | | | | | |
| | | | | | Code | Description | Qty | UOM | | | | | | | | | | | | | | | | | | | | | |
| VM1747A0 | JOINT-PIN H10 POWER BOARD FASTENING CLIP | 2 | PZ | | | | | | | | | | | | | | | | | | | | | | | | | | |
| VM2147A0 | 410X343X15 MM PINK SMOOTH ESD SPONGE | 0.500 | PZ | | | | | | | | | | | | | | | | | | | | | | | | | | |
| <table border="1"> <thead> <tr> <th>Code</th> <th>Description</th> <th>Qty</th> <th>UOM</th> </tr> </thead> <tbody> <tr> <td>VM1224A0</td> <td>65MY 220MM 2 COLOURS SHRINK TUBE</td> <td>0.250</td> <td>M</td> </tr> <tr> <td>VM1746A0</td> <td>H10 M4 JOINT BOARD FASTENING CLIP</td> <td>10</td> <td>PZ</td> </tr> </tbody> </table> | Code | Description | Qty | UOM | VM1224A0 | 65MY 220MM 2 COLOURS SHRINK TUBE | 0.250 | M | VM1746A0 | H10 M4 JOINT BOARD FASTENING CLIP | 10 | PZ | | | | | | | | | | | | | | | | | |
| Code | Description | Qty | UOM | | | | | | | | | | | | | | | | | | | | | | | | | | |
| VM1224A0 | 65MY 220MM 2 COLOURS SHRINK TUBE | 0.250 | M | | | | | | | | | | | | | | | | | | | | | | | | | | |
| VM1746A0 | H10 M4 JOINT BOARD FASTENING CLIP | 10 | PZ | | | | | | | | | | | | | | | | | | | | | | | | | | |
| VM1746A | H10 M4 JOINT BOARD FASTENING CLIP |  | KVM1746A | BOARD FIXING CLIP JOINT-M4 KIT | <table border="1"> <thead> <tr> <th>Code</th> <th>Description</th> <th>Qty</th> <th>UOM</th> </tr> </thead> <tbody> <tr> <td>VM1224A0</td> <td>65MY 220MM 2 COLOURS SHRINK TUBE</td> <td>0.250</td> <td>M</td> </tr> <tr> <td>VM1746A0</td> <td>H10 M4 JOINT BOARD FASTENING CLIP</td> <td>10</td> <td>PZ</td> </tr> </tbody> </table> | Code | Description | Qty | UOM | VM1224A0 | 65MY 220MM 2 COLOURS SHRINK TUBE | 0.250 | M | VM1746A0 | H10 M4 JOINT BOARD FASTENING CLIP | 10 | PZ | | | | | | | | | | | | |
| | | | | | Code | Description | Qty | UOM | | | | | | | | | | | | | | | | | | | | | |
| VM1224A0 | 65MY 220MM 2 COLOURS SHRINK TUBE | 0.250 | M | | | | | | | | | | | | | | | | | | | | | | | | | | |
| VM1746A0 | H10 M4 JOINT BOARD FASTENING CLIP | 10 | PZ | | | | | | | | | | | | | | | | | | | | | | | | | | |
| <table border="1"> <thead> <tr> <th>Code</th> <th>Description</th> <th>Qty</th> <th>UOM</th> </tr> </thead> <tbody> <tr> <td>VM1224A0</td> <td>65MY 220MM 2 COLOURS SHRINK TUBE</td> <td>0.250</td> <td>M</td> </tr> <tr> <td>VM1747A0</td> <td>JOINT-PIN H10 POWER BOARD FASTENING CLIP</td> <td>10</td> <td>PZ</td> </tr> </tbody> </table> | Code | Description | Qty | UOM | VM1224A0 | 65MY 220MM 2 COLOURS SHRINK TUBE | 0.250 | M | VM1747A0 | JOINT-PIN H10 POWER BOARD FASTENING CLIP | 10 | PZ | | | | | | | | | | | | | | | | | |
| Code | Description | Qty | UOM | | | | | | | | | | | | | | | | | | | | | | | | | | |
| VM1224A0 | 65MY 220MM 2 COLOURS SHRINK TUBE | 0.250 | M | | | | | | | | | | | | | | | | | | | | | | | | | | |
| VM1747A0 | JOINT-PIN H10 POWER BOARD FASTENING CLIP | 10 | PZ | | | | | | | | | | | | | | | | | | | | | | | | | | |
| VM1747A | JOINT-PIN H10 POWER BOARD FASTENING CLIP |  | KVM1747A | BOARD FIXING CLIP JOINT-PIN KIT | <table border="1"> <thead> <tr> <th>Code</th> <th>Description</th> <th>Qty</th> <th>UOM</th> </tr> </thead> <tbody> <tr> <td>VM1224A0</td> <td>65MY 220MM 2 COLOURS SHRINK TUBE</td> <td>0.250</td> <td>M</td> </tr> <tr> <td>VM1747A0</td> <td>JOINT-PIN H10 POWER BOARD FASTENING CLIP</td> <td>10</td> <td>PZ</td> </tr> </tbody> </table> | Code | Description | Qty | UOM | VM1224A0 | 65MY 220MM 2 COLOURS SHRINK TUBE | 0.250 | M | VM1747A0 | JOINT-PIN H10 POWER BOARD FASTENING CLIP | 10 | PZ | | | | | | | | | | | | |
| | | | | | Code | Description | Qty | UOM | | | | | | | | | | | | | | | | | | | | | |
| VM1224A0 | 65MY 220MM 2 COLOURS SHRINK TUBE | 0.250 | M | | | | | | | | | | | | | | | | | | | | | | | | | | |
| VM1747A0 | JOINT-PIN H10 POWER BOARD FASTENING CLIP | 10 | PZ | | | | | | | | | | | | | | | | | | | | | | | | | | |
| <table border="1"> <thead> <tr> <th>Code</th> <th>Description</th> <th>Qty</th> <th>UOM</th> </tr> </thead> <tbody> <tr> <td>VM1224A0</td> <td>65MY 220MM 2 COLOURS SHRINK TUBE</td> <td>0.300</td> <td>M</td> </tr> <tr> <td>VM2482A0</td> <td>ELECTR COMPONENT S HOLDER FRAME SHOP.PRO</td> <td>1</td> <td>PZ</td> </tr> <tr> <td>VM2482A0</td> <td>ELECTR COMPONENT S HOLDER FRAME SHOP.PRO</td> <td>1</td> <td>PZ</td> </tr> <tr> <td>VM2484A0</td> <td>ELECTRICAL CONNECTION CABLE CLAMP</td> <td>1</td> <td>PZ</td> </tr> <tr> <td>VM2484A0</td> <td>ELECTRICAL CONNECTION CABLE CLAMP</td> <td>1</td> <td>PZ</td> </tr> </tbody> </table> | Code | Description | Qty | UOM | VM1224A0 | 65MY 220MM 2 COLOURS SHRINK TUBE | 0.300 | M | VM2482A0 | ELECTR COMPONENT S HOLDER FRAME SHOP.PRO | 1 | PZ | VM2482A0 | ELECTR COMPONENT S HOLDER FRAME SHOP.PRO | 1 | PZ | VM2484A0 | ELECTRICAL CONNECTION CABLE CLAMP | 1 | PZ | VM2484A0 | ELECTRICAL CONNECTION CABLE CLAMP | 1 | PZ | | | | | |
| Code | Description | Qty | UOM | | | | | | | | | | | | | | | | | | | | | | | | | | |
| VM1224A0 | 65MY 220MM 2 COLOURS SHRINK TUBE | 0.300 | M | | | | | | | | | | | | | | | | | | | | | | | | | | |
| VM2482A0 | ELECTR COMPONENT S HOLDER FRAME SHOP.PRO | 1 | PZ | | | | | | | | | | | | | | | | | | | | | | | | | | |
| VM2482A0 | ELECTR COMPONENT S HOLDER FRAME SHOP.PRO | 1 | PZ | | | | | | | | | | | | | | | | | | | | | | | | | | |
| VM2484A0 | ELECTRICAL CONNECTION CABLE CLAMP | 1 | PZ | | | | | | | | | | | | | | | | | | | | | | | | | | |
| VM2484A0 | ELECTRICAL CONNECTION CABLE CLAMP | 1 | PZ | | | | | | | | | | | | | | | | | | | | | | | | | | |
| VM2482A | ELECTR COMPONENTS HOLDER FRAME SHOP.PRO |  | KVM2482A | BAKERLUX SP ELECTR COMPONENTS HOLDER KIT | <table border="1"> <thead> <tr> <th>Code</th> <th>Description</th> <th>Qty</th> <th>UOM</th> </tr> </thead> <tbody> <tr> <td>VM1224A0</td> <td>65MY 220MM 2 COLOURS SHRINK TUBE</td> <td>0.300</td> <td>M</td> </tr> <tr> <td>VM2482A0</td> <td>ELECTR COMPONENT S HOLDER FRAME SHOP.PRO</td> <td>1</td> <td>PZ</td> </tr> <tr> <td>VM2482A0</td> <td>ELECTR COMPONENT S HOLDER FRAME SHOP.PRO</td> <td>1</td> <td>PZ</td> </tr> <tr> <td>VM2484A0</td> <td>ELECTRICAL CONNECTION CABLE CLAMP</td> <td>1</td> <td>PZ</td> </tr> <tr> <td>VM2484A0</td> <td>ELECTRICAL CONNECTION CABLE CLAMP</td> <td>1</td> <td>PZ</td> </tr> </tbody> </table> | Code | Description | Qty | UOM | VM1224A0 | 65MY 220MM 2 COLOURS SHRINK TUBE | 0.300 | M | VM2482A0 | ELECTR COMPONENT S HOLDER FRAME SHOP.PRO | 1 | PZ | VM2482A0 | ELECTR COMPONENT S HOLDER FRAME SHOP.PRO | 1 | PZ | VM2484A0 | ELECTRICAL CONNECTION CABLE CLAMP | 1 | PZ | VM2484A0 | ELECTRICAL CONNECTION CABLE CLAMP | 1 | PZ |
| | | | | | Code | Description | Qty | UOM | | | | | | | | | | | | | | | | | | | | | |
| | | | | | VM1224A0 | 65MY 220MM 2 COLOURS SHRINK TUBE | 0.300 | M | | | | | | | | | | | | | | | | | | | | | |
| | | | | | VM2482A0 | ELECTR COMPONENT S HOLDER FRAME SHOP.PRO | 1 | PZ | | | | | | | | | | | | | | | | | | | | | |
| | | | | | VM2482A0 | ELECTR COMPONENT S HOLDER FRAME SHOP.PRO | 1 | PZ | | | | | | | | | | | | | | | | | | | | | |
| VM2484A0 | ELECTRICAL CONNECTION CABLE CLAMP | 1 | PZ | | | | | | | | | | | | | | | | | | | | | | | | | | |
| VM2484A0 | ELECTRICAL CONNECTION CABLE CLAMP | 1 | PZ | | | | | | | | | | | | | | | | | | | | | | | | | | |
| <table border="1"> <thead> <tr> <th>Code</th> <th>Description</th> <th>Qty</th> <th>UOM</th> </tr> </thead> <tbody> <tr> <td>VM2482A0</td> <td>ELECTR COMPONENT S HOLDER FRAME SHOP.PRO</td> <td>1</td> <td>PZ</td> </tr> </tbody> </table> | Code | Description | Qty | UOM | VM2482A0 | ELECTR COMPONENT S HOLDER FRAME SHOP.PRO | 1 | PZ | | | | | | | | | | | | | | | | | | | | | |
| Code | Description | Qty | UOM | | | | | | | | | | | | | | | | | | | | | | | | | | |
| VM2482A0 | ELECTR COMPONENT S HOLDER FRAME SHOP.PRO | 1 | PZ | | | | | | | | | | | | | | | | | | | | | | | | | | |
| <table border="1"> <thead> <tr> <th>Code</th> <th>Description</th> <th>Qty</th> <th>UOM</th> </tr> </thead> <tbody> <tr> <td>VM2482A0</td> <td>ELECTR COMPONENT S HOLDER FRAME SHOP.PRO</td> <td>1</td> <td>PZ</td> </tr> </tbody> </table> | Code | Description | Qty | UOM | VM2482A0 | ELECTR COMPONENT S HOLDER FRAME SHOP.PRO | 1 | PZ | | | | | | | | | | | | | | | | | | | | | |
| Code | Description | Qty | UOM | | | | | | | | | | | | | | | | | | | | | | | | | | |
| VM2482A0 | ELECTR COMPONENT S HOLDER FRAME SHOP.PRO | 1 | PZ | | | | | | | | | | | | | | | | | | | | | | | | | | |
| <table border="1"> <thead> <tr> <th>Code</th> <th>Description</th> <th>Qty</th> <th>UOM</th> </tr> </thead> <tbody> <tr> <td>VM2484A0</td> <td>ELECTRICAL CONNECTION CABLE CLAMP</td> <td>1</td> <td>PZ</td> </tr> </tbody> </table> | Code | Description | Qty | UOM | VM2484A0 | ELECTRICAL CONNECTION CABLE CLAMP | 1 | PZ | | | | | | | | | | | | | | | | | | | | | |
| Code | Description | Qty | UOM | | | | | | | | | | | | | | | | | | | | | | | | | | |
| VM2484A0 | ELECTRICAL CONNECTION CABLE CLAMP | 1 | PZ | | | | | | | | | | | | | | | | | | | | | | | | | | |
| <table border="1"> <thead> <tr> <th>Code</th> <th>Description</th> <th>Qty</th> <th>UOM</th> </tr> </thead> <tbody> <tr> <td>VM2484A0</td> <td>ELECTRICAL CONNECTION CABLE CLAMP</td> <td>1</td> <td>PZ</td> </tr> </tbody> </table> | Code | Description | Qty | UOM | VM2484A0 | ELECTRICAL CONNECTION CABLE CLAMP | 1 | PZ | | | | | | | | | | | | | | | | | | | | | |
| Code | Description | Qty | UOM | | | | | | | | | | | | | | | | | | | | | | | | | | |
| VM2484A0 | ELECTRICAL CONNECTION CABLE CLAMP | 1 | PZ | | | | | | | | | | | | | | | | | | | | | | | | | | |

| COMPONENT | | | SPARE PART | | | | | | | | | | | | | | | | | | | | | | |
|-----------|---|--|------------|---|---|------|-------------|-----|-----|----------|---|-------|----|----------|---|-------|----|----------|--|---|----|----------|--|-------|----|
| Code | Description | Image | Code | Description | Components list | | | | | | | | | | | | | | | | | | | | |
| VM2483A | SHOP PRO COMPONENTS HOLDER COVER |  | KVM2483A | BL SHOP.PRO COMPONENTS HOLDER COVER KIT | <table border="1"> <thead> <tr> <th>Code</th> <th>Description</th> <th>Qty</th> <th>UOM</th> </tr> </thead> <tbody> <tr> <td>VM1224A0</td> <td>65MY 220MM 2 COLOURS SHRINK TUBE</td> <td>0.300</td> <td>M</td> </tr> <tr> <td>VM2483A0</td> <td>COMPONENT S HOLDER COVER SHOP.PRO</td> <td>1</td> <td>PZ</td> </tr> <tr> <td>VM2483A0</td> <td>COMPONENT S HOLDER COVER SHOP.PRO</td> <td>1</td> <td>PZ</td> </tr> <tr> <td>VM2483A1</td> <td>SHOP PRO COMPONENT S HOLDER COVER</td> <td>1</td> <td>PZ</td> </tr> </tbody> </table> | Code | Description | Qty | UOM | VM1224A0 | 65MY 220MM 2 COLOURS SHRINK TUBE | 0.300 | M | VM2483A0 | COMPONENT S HOLDER COVER SHOP.PRO | 1 | PZ | VM2483A0 | COMPONENT S HOLDER COVER SHOP.PRO | 1 | PZ | VM2483A1 | SHOP PRO COMPONENT S HOLDER COVER | 1 | PZ |
| Code | Description | Qty | UOM | | | | | | | | | | | | | | | | | | | | | | |
| VM1224A0 | 65MY 220MM 2 COLOURS SHRINK TUBE | 0.300 | M | | | | | | | | | | | | | | | | | | | | | | |
| VM2483A0 | COMPONENT S HOLDER COVER SHOP.PRO | 1 | PZ | | | | | | | | | | | | | | | | | | | | | | |
| VM2483A0 | COMPONENT S HOLDER COVER SHOP.PRO | 1 | PZ | | | | | | | | | | | | | | | | | | | | | | |
| VM2483A1 | SHOP PRO COMPONENT S HOLDER COVER | 1 | PZ | | | | | | | | | | | | | | | | | | | | | | |
| RC1365A | 3/4"-10 JG FEMALE CONNECTION |  | KRC1365A | 3/4"-10 OR 8 JG WATER CONNECTION KIT | <table border="1"> <thead> <tr> <th>Code</th> <th>Description</th> <th>Qty</th> <th>UOM</th> </tr> </thead> <tbody> <tr> <td>GN1200A1</td> <td>3/4 CONNECTION SEAL D=24 RUBBER+NET</td> <td>1</td> <td>PZ</td> </tr> <tr> <td>RC1002A0</td> <td>JG 10M-8F TERMINAL REDUCTION FITTING</td> <td>1</td> <td>PZ</td> </tr> <tr> <td>RC1365A0</td> <td>3/4"-10 JG FEMALE CONNECTION</td> <td>1</td> <td>PZ</td> </tr> <tr> <td>VM1224A0</td> <td>65MY 220MM 2 COLOURS SHRINK TUBE</td> <td>0.150</td> <td>M</td> </tr> </tbody> </table> | Code | Description | Qty | UOM | GN1200A1 | 3/4 CONNECTION SEAL D=24 RUBBER+NET | 1 | PZ | RC1002A0 | JG 10M-8F TERMINAL REDUCTION FITTING | 1 | PZ | RC1365A0 | 3/4"-10 JG FEMALE CONNECTION | 1 | PZ | VM1224A0 | 65MY 220MM 2 COLOURS SHRINK TUBE | 0.150 | M |
| Code | Description | Qty | UOM | | | | | | | | | | | | | | | | | | | | | | |
| GN1200A1 | 3/4 CONNECTION SEAL D=24 RUBBER+NET | 1 | PZ | | | | | | | | | | | | | | | | | | | | | | |
| RC1002A0 | JG 10M-8F TERMINAL REDUCTION FITTING | 1 | PZ | | | | | | | | | | | | | | | | | | | | | | |
| RC1365A0 | 3/4"-10 JG FEMALE CONNECTION | 1 | PZ | | | | | | | | | | | | | | | | | | | | | | |
| VM1224A0 | 65MY 220MM 2 COLOURS SHRINK TUBE | 0.150 | M | | | | | | | | | | | | | | | | | | | | | | |
| RC1002A | JG 10M-8F TERMINAL REDUCTION FITTIN |  | KRC1002A | JG Ø10M-Ø8F REDUCING SPIGOT 10 PCS KIT | <table border="1"> <thead> <tr> <th>Code</th> <th>Description</th> <th>Qty</th> <th>UOM</th> </tr> </thead> <tbody> <tr> <td>RC1002A0</td> <td>JG 10M-8F TERMINAL REDUCTION FITTING</td> <td>10</td> <td>PZ</td> </tr> <tr> <td>VM1224A0</td> <td>65MY 220MM 2 COLOURS SHRINK TUBE</td> <td>0.200</td> <td>M</td> </tr> </tbody> </table> | Code | Description | Qty | UOM | RC1002A0 | JG 10M-8F TERMINAL REDUCTION FITTING | 10 | PZ | VM1224A0 | 65MY 220MM 2 COLOURS SHRINK TUBE | 0.200 | M | | | | | | | | |
| Code | Description | Qty | UOM | | | | | | | | | | | | | | | | | | | | | | |
| RC1002A0 | JG 10M-8F TERMINAL REDUCTION FITTING | 10 | PZ | | | | | | | | | | | | | | | | | | | | | | |
| VM1224A0 | 65MY 220MM 2 COLOURS SHRINK TUBE | 0.200 | M | | | | | | | | | | | | | | | | | | | | | | |

ASM3403A/0.D00 - Cooking chamber

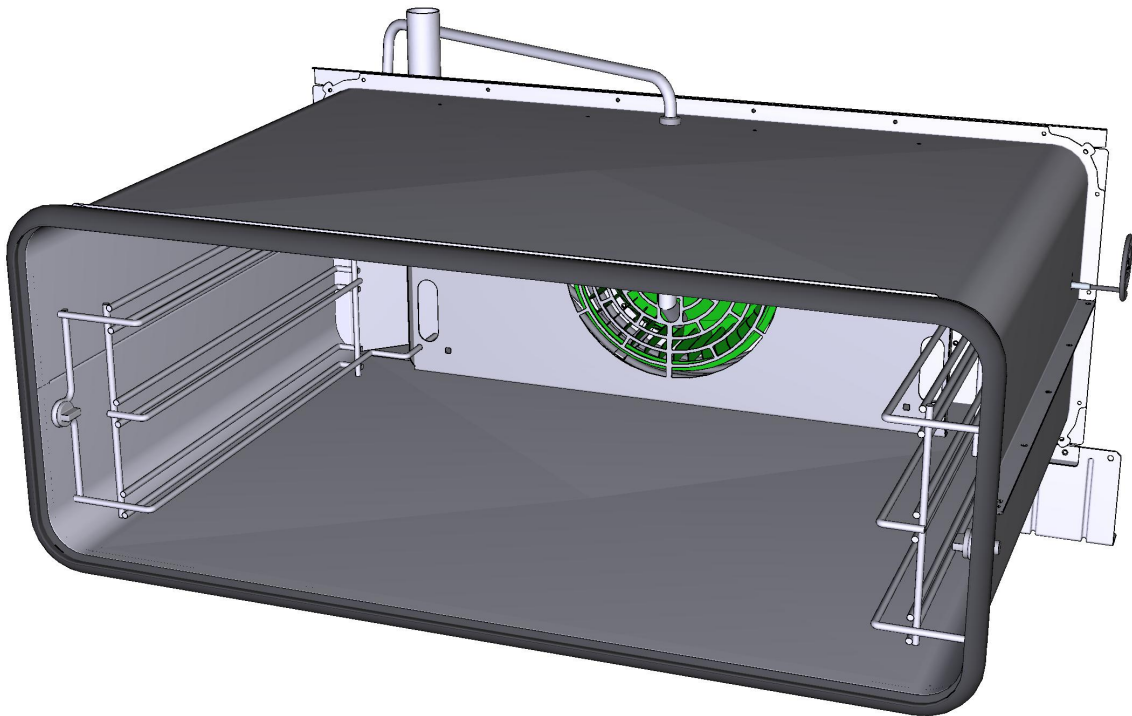

FRONT





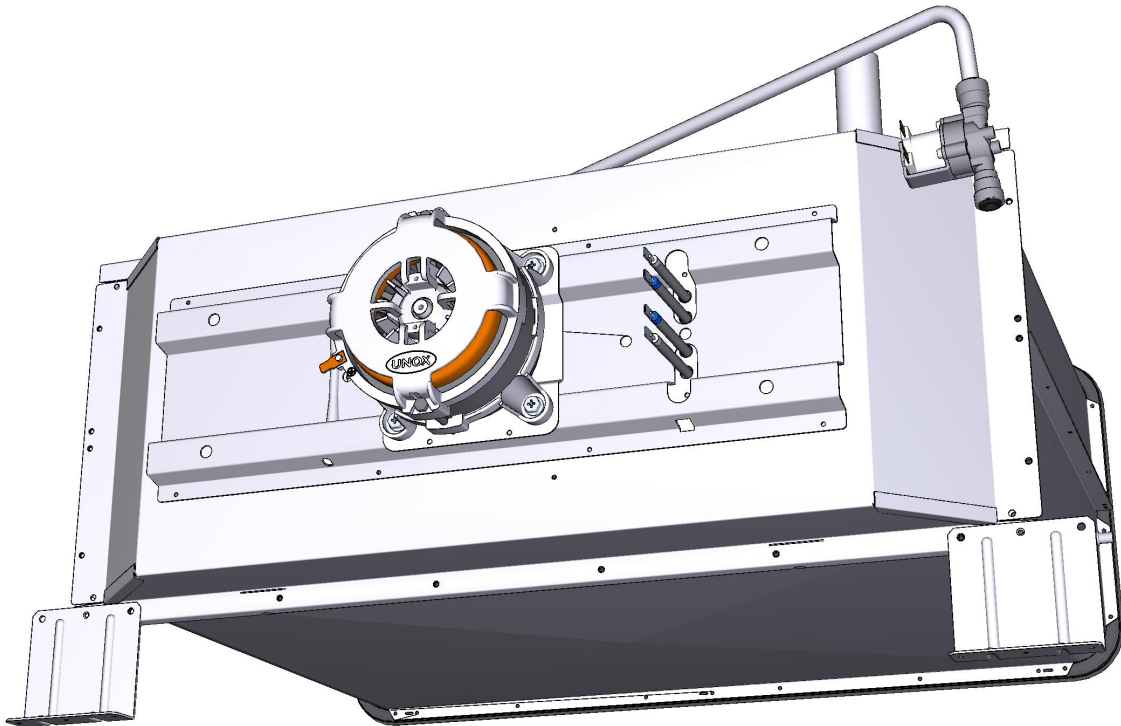

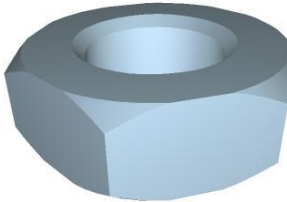
ASM3403A/0.D00 - Cooking chamber



REAR



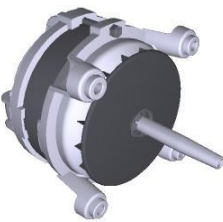

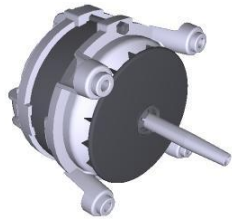
| COMPONENT | | | SPARE PART | | | | | | | | | | | | | | | | | | | | | | | | | | | | | | | | | | | | | | | | | | | | | | |
|-----------|--|---|------------|---|--|------|-------------|-----|-----|----------|--|-------|----|----------|--|-------|----|----------|---|---|----|-----------|---------------------------------|-------|----|----------|--|---|----|----------|--------------------------------------|---|----|----------|--------------------------------------|---|----|----------|---|---|----|----------|---|---|----|----------|-----------------------|---|----|
| Code | Description | Image | Code | Description | Components list | | | | | | | | | | | | | | | | | | | | | | | | | | | | | | | | | | | | | | | | | | | | |
| TR1105A | L1000 PT100 TEMPERATURE PROBE |  | KTR1105A | PT100 L1000 TEMPERATURE PROBE KIT | <table border="1"> <thead> <tr> <th>Code</th> <th>Description</th> <th>Qty</th> <th>UOM</th> </tr> </thead> <tbody> <tr> <td>GN1120A0</td> <td>NTC TEMPERATUR E PROBE SEAL</td> <td>1</td> <td>PZ</td> </tr> <tr> <td>GN1120A1</td> <td>NTC TEMPERATUR E PROBE SEAL</td> <td>1</td> <td>PZ</td> </tr> <tr> <td>GN1285A0</td> <td>NTC TEMPERATUR E PROBE SEALING</td> <td>1</td> <td>PZ</td> </tr> <tr> <td>MOV0010A0</td> <td>HOOD RING GASKET GN1110A2</td> <td>0.100</td> <td>PZ</td> </tr> <tr> <td>SL1045A0</td> <td>S57 BLACK SILICONE - 80ML CARTRIDGE</td> <td>1</td> <td>PZ</td> </tr> <tr> <td>TR1105A4</td> <td>L1000 PT100 TEMPERATUR E PROBE</td> <td>1</td> <td>PZ</td> </tr> <tr> <td>VI1220A1</td> <td>4,2X12 TCB SELF-TAPPIN G SCREW</td> <td>2</td> <td>PZ</td> </tr> <tr> <td>VM1464A1</td> <td>CT BT TEMPERATUR E PROBE COVER</td> <td>1</td> <td>PZ</td> </tr> <tr> <td>VM1465A1</td> <td>CT BT TEMPERATUR E PROBE COVER</td> <td>1</td> <td>PZ</td> </tr> <tr> <td>VM2052A0</td> <td>LM CORE PROBE COVE</td> <td>1</td> <td>PZ</td> </tr> </tbody> </table> | Code | Description | Qty | UOM | GN1120A0 | NTC TEMPERATUR E PROBE SEAL | 1 | PZ | GN1120A1 | NTC TEMPERATUR E PROBE SEAL | 1 | PZ | GN1285A0 | NTC TEMPERATUR E PROBE SEALING | 1 | PZ | MOV0010A0 | HOOD RING GASKET GN1110A2 | 0.100 | PZ | SL1045A0 | S57 BLACK SILICONE - 80ML CARTRIDGE | 1 | PZ | TR1105A4 | L1000 PT100 TEMPERATUR E PROBE | 1 | PZ | VI1220A1 | 4,2X12 TCB SELF-TAPPIN G SCREW | 2 | PZ | VM1464A1 | CT BT TEMPERATUR E PROBE COVER | 1 | PZ | VM1465A1 | CT BT TEMPERATUR E PROBE COVER | 1 | PZ | VM2052A0 | LM CORE PROBE COVE | 1 | PZ |
| Code | Description | Qty | UOM | | | | | | | | | | | | | | | | | | | | | | | | | | | | | | | | | | | | | | | | | | | | | | |
| GN1120A0 | NTC TEMPERATUR E PROBE SEAL | 1 | PZ | | | | | | | | | | | | | | | | | | | | | | | | | | | | | | | | | | | | | | | | | | | | | | |
| GN1120A1 | NTC TEMPERATUR E PROBE SEAL | 1 | PZ | | | | | | | | | | | | | | | | | | | | | | | | | | | | | | | | | | | | | | | | | | | | | | |
| GN1285A0 | NTC TEMPERATUR E PROBE SEALING | 1 | PZ | | | | | | | | | | | | | | | | | | | | | | | | | | | | | | | | | | | | | | | | | | | | | | |
| MOV0010A0 | HOOD RING GASKET GN1110A2 | 0.100 | PZ | | | | | | | | | | | | | | | | | | | | | | | | | | | | | | | | | | | | | | | | | | | | | | |
| SL1045A0 | S57 BLACK SILICONE - 80ML CARTRIDGE | 1 | PZ | | | | | | | | | | | | | | | | | | | | | | | | | | | | | | | | | | | | | | | | | | | | | | |
| TR1105A4 | L1000 PT100 TEMPERATUR E PROBE | 1 | PZ | | | | | | | | | | | | | | | | | | | | | | | | | | | | | | | | | | | | | | | | | | | | | | |
| VI1220A1 | 4,2X12 TCB SELF-TAPPIN G SCREW | 2 | PZ | | | | | | | | | | | | | | | | | | | | | | | | | | | | | | | | | | | | | | | | | | | | | | |
| VM1464A1 | CT BT TEMPERATUR E PROBE COVER | 1 | PZ | | | | | | | | | | | | | | | | | | | | | | | | | | | | | | | | | | | | | | | | | | | | | | |
| VM1465A1 | CT BT TEMPERATUR E PROBE COVER | 1 | PZ | | | | | | | | | | | | | | | | | | | | | | | | | | | | | | | | | | | | | | | | | | | | | | |
| VM2052A0 | LM CORE PROBE COVE | 1 | PZ | | | | | | | | | | | | | | | | | | | | | | | | | | | | | | | | | | | | | | | | | | | | | | |
| RC1170A | STAINLESS STEEL NUT M14 H=8 CH=22 |  | KRC1170A | M14 H8 CH22 NUT - 10 PCS. KIT | <table border="1"> <thead> <tr> <th>Code</th> <th>Description</th> <th>Qty</th> <th>UOM</th> </tr> </thead> <tbody> <tr> <td>RC1170A1</td> <td>STAINLESS STEEL NUT M14 H=8 CH=2</td> <td>10</td> <td>PZ</td> </tr> <tr> <td>VM1224A0</td> <td>65MY 220MM 2 COLOURS SHRINK TUBE</td> <td>0.200</td> <td>M</td> </tr> </tbody> </table> | Code | Description | Qty | UOM | RC1170A1 | STAINLESS STEEL NUT M14 H=8 CH=2 | 10 | PZ | VM1224A0 | 65MY 220MM 2 COLOURS SHRINK TUBE | 0.200 | M | | | | | | | | | | | | | | | | | | | | | | | | | | | | | | | | |
| Code | Description | Qty | UOM | | | | | | | | | | | | | | | | | | | | | | | | | | | | | | | | | | | | | | | | | | | | | | |
| RC1170A1 | STAINLESS STEEL NUT M14 H=8 CH=2 | 10 | PZ | | | | | | | | | | | | | | | | | | | | | | | | | | | | | | | | | | | | | | | | | | | | | | |
| VM1224A0 | 65MY 220MM 2 COLOURS SHRINK TUBE | 0.200 | M | | | | | | | | | | | | | | | | | | | | | | | | | | | | | | | | | | | | | | | | | | | | | | |
| VM2331A | FAN GUARD-TRAYS HOLDER PIN |  | KVM2331A | KIT FAN GUARD-TRAYS HOLDER PIN | <table border="1"> <thead> <tr> <th>Code</th> <th>Description</th> <th>Qty</th> <th>UOM</th> </tr> </thead> <tbody> <tr> <td>VM1224A0</td> <td>65MY 220MM 2 COLOURS SHRINK TUBE</td> <td>0.200</td> <td>M</td> </tr> <tr> <td>VM2331A0</td> <td>FAN GUARD-TRAY S HOLDER PIN</td> <td>4</td> <td>PZ</td> </tr> </tbody> </table> | Code | Description | Qty | UOM | VM1224A0 | 65MY 220MM 2 COLOURS SHRINK TUBE | 0.200 | M | VM2331A0 | FAN GUARD-TRAY S HOLDER PIN | 4 | PZ | | | | | | | | | | | | | | | | | | | | | | | | | | | | | | | | |
| Code | Description | Qty | UOM | | | | | | | | | | | | | | | | | | | | | | | | | | | | | | | | | | | | | | | | | | | | | | |
| VM1224A0 | 65MY 220MM 2 COLOURS SHRINK TUBE | 0.200 | M | | | | | | | | | | | | | | | | | | | | | | | | | | | | | | | | | | | | | | | | | | | | | | |
| VM2331A0 | FAN GUARD-TRAY S HOLDER PIN | 4 | PZ | | | | | | | | | | | | | | | | | | | | | | | | | | | | | | | | | | | | | | | | | | | | | | |

| COMPONENT | | | SPARE PART | | | | | | | | | | | | | | | | | | | | | | |
|-----------|------------------------------------|---|------------|--------------------------------------|---|------|-------------|-----|-----|----------|------------------------------------|---|----|----------|----------------------------------|-------|----|----------|----------------------------|---|----|----------|-------------------------------|---|----|
| Code | Description | Image | Code | Description | Components list | | | | | | | | | | | | | | | | | | | | |
| 0H7875A | MUFFLE SUPPORT BRACKET SHOP.PR |  | 0H7875A0 | MUFFLE SUPPORT BRACKET SHOP.PR | | | | | | | | | | | | | | | | | | | | | |
| EL1251A | 1-WAY WATER SOLENOID VALVE |  | KEL1251A | JG D8-D10 1 WAY SOLENOID VALVE KI | <table border="1"> <thead> <tr> <th>Code</th> <th>Description</th> <th>Qty</th> <th>UOM</th> </tr> </thead> <tbody> <tr> <td>EL1251A0</td> <td>1-WAY WATER SOLENOID VALVE</td> <td>1</td> <td>PZ</td> </tr> <tr> <td>VM1224A0</td> <td>65MY 220MM 2 COLOURS SHRINK TUBE</td> <td>0.250</td> <td>M</td> </tr> </tbody> </table> | Code | Description | Qty | UOM | EL1251A0 | 1-WAY WATER SOLENOID VALVE | 1 | PZ | VM1224A0 | 65MY 220MM 2 COLOURS SHRINK TUBE | 0.250 | M | | | | | | | | |
| Code | Description | Qty | UOM | | | | | | | | | | | | | | | | | | | | | | |
| EL1251A0 | 1-WAY WATER SOLENOID VALVE | 1 | PZ | | | | | | | | | | | | | | | | | | | | | | |
| VM1224A0 | 65MY 220MM 2 COLOURS SHRINK TUBE | 0.250 | M | | | | | | | | | | | | | | | | | | | | | | |
| TB1574A | FUME CHIMNEY D30 SHOP PRO |  | TB1574A0 | FUME CHIMNEY D30 SHOP PRO | | | | | | | | | | | | | | | | | | | | | |
| 0H3020A | MOTOR SHAFT SEALING DISC |  | 0H3020A1 | MOTOR SHAFT SEALING DISC | | | | | | | | | | | | | | | | | | | | | |
| MT1012A | 330W 230V MOTOR |  | KVN1130A | LUX =08.2017/S.5/S.5E 330W MOTOR KIT | <table border="1"> <thead> <tr> <th>Code</th> <th>Description</th> <th>Qty</th> <th>UOM</th> </tr> </thead> <tbody> <tr> <td>0H4305A1</td> <td>ST. STEEL MOTOR SHAFT SEALING DISC</td> <td>1</td> <td>PZ</td> </tr> <tr> <td>GN1140A2</td> <td>MOTOR HOLDER GASKET</td> <td>1</td> <td>PZ</td> </tr> <tr> <td>GN1140A3</td> <td>MOLDED MOTOR HOLDER GASKET</td> <td>1</td> <td>PZ</td> </tr> <tr> <td>VI1045A0</td> <td>16X8,4 TH=1,6 ST.STEEL WASHER</td> <td>1</td> <td>PZ</td> </tr> </tbody> </table> | Code | Description | Qty | UOM | 0H4305A1 | ST. STEEL MOTOR SHAFT SEALING DISC | 1 | PZ | GN1140A2 | MOTOR HOLDER GASKET | 1 | PZ | GN1140A3 | MOLDED MOTOR HOLDER GASKET | 1 | PZ | VI1045A0 | 16X8,4 TH=1,6 ST.STEEL WASHER | 1 | PZ |
| Code | Description | Qty | UOM | | | | | | | | | | | | | | | | | | | | | | |
| 0H4305A1 | ST. STEEL MOTOR SHAFT SEALING DISC | 1 | PZ | | | | | | | | | | | | | | | | | | | | | | |
| GN1140A2 | MOTOR HOLDER GASKET | 1 | PZ | | | | | | | | | | | | | | | | | | | | | | |
| GN1140A3 | MOLDED MOTOR HOLDER GASKET | 1 | PZ | | | | | | | | | | | | | | | | | | | | | | |
| VI1045A0 | 16X8,4 TH=1,6 ST.STEEL WASHER | 1 | PZ | | | | | | | | | | | | | | | | | | | | | | |

| COMPONENT | | | SPARE PART | | | | | | | | | | | | | | | | | | | | | | | | | | | | | | | | | | | | | | | | | | | | | | | | | | | | | | | |
|-----------|---|--|------------|--|--|------|-------------|-----|-----|----------|---|---|----|----------|-----------------------------|---------------------------|----|----------|------------|-------------------------------------|----|----------|-----------------------------------|---------------------------------|-------|----------|---------------------------|--------------------|----|----------|---------------------------|-------------------------------|----|----|----------|------------------------|---|----|----------|--|---|----|----------|----------------------------|---|----|----------|-----------------------|---|----|----------|-----------------------------|---|----|----------|------------|---|----|
| Code | Description | Image | Code | Description | Components list | | | | | | | | | | | | | | | | | | | | | | | | | | | | | | | | | | | | | | | | | | | | | | | | | | | | | |
| MT1012A | 330W 230V MOTOR |  | KVN1130A | LUX =08.2017/S.5/S.5E 330W MOTOR KIT | <table border="1"> <thead> <tr> <th>Code</th> <th>Description</th> <th>Qty</th> <th>UOM</th> </tr> </thead> <tbody> <tr> <td>VI1256A0</td> <td>M8 DIN 980M ST. STEEL SELF LOCKING NUT</td> <td>1</td> <td>PZ</td> </tr> <tr> <td>VM1794A0</td> <td>250X4.8 PA66 BLACK CLAMP</td> <td>4</td> <td>PZ</td> </tr> <tr> <td>VM2103A0</td> <td>CLAMP LOCK</td> <td>4</td> <td>PZ</td> </tr> <tr> <td>VM2196A0</td> <td>MOTOR NUT FASTENING BUSHING</td> <td>1</td> <td>PZ</td> </tr> <tr> <td>VN1130A1</td> <td>330W 230V 50/60HZ MOTO</td> <td>1</td> <td>PZ</td> </tr> <tr> <td>VN1130A1</td> <td>330W 230V 50/60HZ MOTO</td> <td>1</td> <td>PZ</td> </tr> </tbody> </table> | Code | Description | Qty | UOM | VI1256A0 | M8 DIN 980M ST. STEEL SELF LOCKING NUT | 1 | PZ | VM1794A0 | 250X4.8 PA66 BLACK CLAMP | 4 | PZ | VM2103A0 | CLAMP LOCK | 4 | PZ | VM2196A0 | MOTOR NUT FASTENING BUSHING | 1 | PZ | VN1130A1 | 330W 230V 50/60HZ MOTO | 1 | PZ | VN1130A1 | 330W 230V 50/60HZ MOTO | 1 | PZ | | | | | | | | | | | | | | | | | | | | | | | | | |
| | | | Code | Description | Qty | UOM | | | | | | | | | | | | | | | | | | | | | | | | | | | | | | | | | | | | | | | | | | | | | | | | | | | | |
| VI1256A0 | M8 DIN 980M ST. STEEL SELF LOCKING NUT | 1 | PZ | | | | | | | | | | | | | | | | | | | | | | | | | | | | | | | | | | | | | | | | | | | | | | | | | | | | | | | |
| VM1794A0 | 250X4.8 PA66 BLACK CLAMP | 4 | PZ | | | | | | | | | | | | | | | | | | | | | | | | | | | | | | | | | | | | | | | | | | | | | | | | | | | | | | | |
| VM2103A0 | CLAMP LOCK | 4 | PZ | | | | | | | | | | | | | | | | | | | | | | | | | | | | | | | | | | | | | | | | | | | | | | | | | | | | | | | |
| VM2196A0 | MOTOR NUT FASTENING BUSHING | 1 | PZ | | | | | | | | | | | | | | | | | | | | | | | | | | | | | | | | | | | | | | | | | | | | | | | | | | | | | | | |
| VN1130A1 | 330W 230V 50/60HZ MOTO | 1 | PZ | | | | | | | | | | | | | | | | | | | | | | | | | | | | | | | | | | | | | | | | | | | | | | | | | | | | | | | |
| VN1130A1 | 330W 230V 50/60HZ MOTO | 1 | PZ | | | | | | | | | | | | | | | | | | | | | | | | | | | | | | | | | | | | | | | | | | | | | | | | | | | | | | | |
| KMT1012A | MIND.MAPS 330W 230V MOTOR KIT | <table border="1"> <thead> <tr> <th>Code</th> <th>Description</th> <th>Qty</th> <th>UOM</th> </tr> </thead> <tbody> <tr> <td>0H2842A0</td> <td></td> <td>1</td> <td>PZ</td> </tr> <tr> <td>0H4305A1</td> <td>ST. STEEL MOTOR SHAFT SEALING DISC</td> <td>1</td> <td>PZ</td> </tr> <tr> <td>GN1140A2</td> <td>MOTOR HOLDER GASKET</td> <td>1</td> <td>PZ</td> </tr> <tr> <td>GN1140A3</td> <td>MOLDED MOTOR HOLDER GASKET</td> <td>1</td> <td>PZ</td> </tr> <tr> <td>MOV0007A0</td> <td>HOOD RING GASKET GN1110A2</td> <td>0.100</td> <td>PZ</td> </tr> <tr> <td>MT1012A0</td> <td>330W 230V MOTOR</td> <td>1</td> <td>PZ</td> </tr> <tr> <td>VE1550A0</td> <td>5X3 MM NEODYMIUM MAGNET</td> <td>1</td> <td>PZ</td> </tr> <tr> <td>VI1077A1</td> <td>SCREW M6X12 TE INOX</td> <td>1</td> <td>PZ</td> </tr> <tr> <td>VI1521A0</td> <td>STAINLESS STEEL WASHER D=6 6592</td> <td>1</td> <td>PZ</td> </tr> <tr> <td>VI1966A0</td> <td>M4X14 FLATHEAD SCREW</td> <td>1</td> <td>PZ</td> </tr> <tr> <td>VM1635A0</td> <td>MAGNET HOLDING DIS</td> <td>1</td> <td>PZ</td> </tr> <tr> <td>VM1794A0</td> <td>250X4.8 PA66 BLACK CLAMP</td> <td>4</td> <td>PZ</td> </tr> <tr> <td>VM2103A0</td> <td>CLAMP LOCK</td> <td>4</td> <td>PZ</td> </tr> </tbody> </table> | Code | Description | Qty | UOM | 0H2842A0 | | 1 | PZ | 0H4305A1 | ST. STEEL MOTOR SHAFT SEALING DISC | 1 | PZ | GN1140A2 | MOTOR HOLDER GASKET | 1 | PZ | GN1140A3 | MOLDED MOTOR HOLDER GASKET | 1 | PZ | MOV0007A0 | HOOD RING GASKET GN1110A2 | 0.100 | PZ | MT1012A0 | 330W 230V MOTOR | 1 | PZ | VE1550A0 | 5X3 MM NEODYMIUM MAGNET | 1 | PZ | VI1077A1 | SCREW M6X12 TE INOX | 1 | PZ | VI1521A0 | STAINLESS STEEL WASHER D=6 6592 | 1 | PZ | VI1966A0 | M4X14 FLATHEAD SCREW | 1 | PZ | VM1635A0 | MAGNET HOLDING DIS | 1 | PZ | VM1794A0 | 250X4.8 PA66 BLACK CLAMP | 4 | PZ | VM2103A0 | CLAMP LOCK | 4 | PZ |
| Code | Description | Qty | UOM | | | | | | | | | | | | | | | | | | | | | | | | | | | | | | | | | | | | | | | | | | | | | | | | | | | | | | | |
| 0H2842A0 | | 1 | PZ | | | | | | | | | | | | | | | | | | | | | | | | | | | | | | | | | | | | | | | | | | | | | | | | | | | | | | | |
| 0H4305A1 | ST. STEEL MOTOR SHAFT SEALING DISC | 1 | PZ | | | | | | | | | | | | | | | | | | | | | | | | | | | | | | | | | | | | | | | | | | | | | | | | | | | | | | | |
| GN1140A2 | MOTOR HOLDER GASKET | 1 | PZ | | | | | | | | | | | | | | | | | | | | | | | | | | | | | | | | | | | | | | | | | | | | | | | | | | | | | | | |
| GN1140A3 | MOLDED MOTOR HOLDER GASKET | 1 | PZ | | | | | | | | | | | | | | | | | | | | | | | | | | | | | | | | | | | | | | | | | | | | | | | | | | | | | | | |
| MOV0007A0 | HOOD RING GASKET GN1110A2 | 0.100 | PZ | | | | | | | | | | | | | | | | | | | | | | | | | | | | | | | | | | | | | | | | | | | | | | | | | | | | | | | |
| MT1012A0 | 330W 230V MOTOR | 1 | PZ | | | | | | | | | | | | | | | | | | | | | | | | | | | | | | | | | | | | | | | | | | | | | | | | | | | | | | | |
| VE1550A0 | 5X3 MM NEODYMIUM MAGNET | 1 | PZ | | | | | | | | | | | | | | | | | | | | | | | | | | | | | | | | | | | | | | | | | | | | | | | | | | | | | | | |
| VI1077A1 | SCREW M6X12 TE INOX | 1 | PZ | | | | | | | | | | | | | | | | | | | | | | | | | | | | | | | | | | | | | | | | | | | | | | | | | | | | | | | |
| VI1521A0 | STAINLESS STEEL WASHER D=6 6592 | 1 | PZ | | | | | | | | | | | | | | | | | | | | | | | | | | | | | | | | | | | | | | | | | | | | | | | | | | | | | | | |
| VI1966A0 | M4X14 FLATHEAD SCREW | 1 | PZ | | | | | | | | | | | | | | | | | | | | | | | | | | | | | | | | | | | | | | | | | | | | | | | | | | | | | | | |
| VM1635A0 | MAGNET HOLDING DIS | 1 | PZ | | | | | | | | | | | | | | | | | | | | | | | | | | | | | | | | | | | | | | | | | | | | | | | | | | | | | | | |
| VM1794A0 | 250X4.8 PA66 BLACK CLAMP | 4 | PZ | | | | | | | | | | | | | | | | | | | | | | | | | | | | | | | | | | | | | | | | | | | | | | | | | | | | | | | |
| VM2103A0 | CLAMP LOCK | 4 | PZ | | | | | | | | | | | | | | | | | | | | | | | | | | | | | | | | | | | | | | | | | | | | | | | | | | | | | | | |

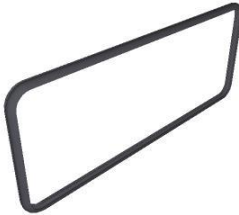
| COMPONENT | | | SPARE PART | | | | | | | | | | | | | | | | | | | | | | |
|-----------|--|---|------------|---|--|------|-------------|-----|-----|----------|--|---|----|----------|----------------------------------|-------|----|----------|-------------------------------|---|----|----------|-------------------------------|---|----|
| Code | Description | Image | Code | Description | Components list | | | | | | | | | | | | | | | | | | | | |
| GN1547A | SHAFT GASKET D11.8 |  | KG1547A | D11.6 MOTOR SHAFT GASKET 3PCS KIT | <table border="1"> <thead> <tr> <th>Code</th> <th>Description</th> <th>Qty</th> <th>UOM</th> </tr> </thead> <tbody> <tr> <td>GN1547A1</td> <td>SHAFT GASKET D11.8</td> <td>3</td> <td>PZ</td> </tr> <tr> <td>VM1224A0</td> <td>65MY 220MM 2 COLOURS SHRINK TUBE</td> <td>0.200</td> <td>M</td> </tr> </tbody> </table> | Code | Description | Qty | UOM | GN1547A1 | SHAFT GASKET D11.8 | 3 | PZ | VM1224A0 | 65MY 220MM 2 COLOURS SHRINK TUBE | 0.200 | M | | | | | | | | |
| Code | Description | Qty | UOM | | | | | | | | | | | | | | | | | | | | | | |
| GN1547A1 | SHAFT GASKET D11.8 | 3 | PZ | | | | | | | | | | | | | | | | | | | | | | |
| VM1224A0 | 65MY 220MM 2 COLOURS SHRINK TUBE | 0.200 | M | | | | | | | | | | | | | | | | | | | | | | |
| VN1181A | M6 NUT 39 BLADES H81 D196 FAN |  | KVN1181A | D196 H81 39 BLADES FAN+SCREW M6 KIT | <table border="1"> <thead> <tr> <th>Code</th> <th>Description</th> <th>Qty</th> <th>UOM</th> </tr> </thead> <tbody> <tr> <td>V11077A1</td> <td>SCREW M6X12 TE INOX</td> <td>1</td> <td>PZ</td> </tr> <tr> <td>V11521A0</td> <td>STAINLESS STEEL WASHER D=6 6592</td> <td>1</td> <td>PZ</td> </tr> <tr> <td>VN1181A0</td> <td>M6 NUT 39 BLADES H81 D196 FAN</td> <td>1</td> <td>PZ</td> </tr> <tr> <td>VN1181A0</td> <td>M6 NUT 39 BLADES H81 D196 FAN</td> <td>1</td> <td>PZ</td> </tr> </tbody> </table> | Code | Description | Qty | UOM | V11077A1 | SCREW M6X12 TE INOX | 1 | PZ | V11521A0 | STAINLESS STEEL WASHER D=6 6592 | 1 | PZ | VN1181A0 | M6 NUT 39 BLADES H81 D196 FAN | 1 | PZ | VN1181A0 | M6 NUT 39 BLADES H81 D196 FAN | 1 | PZ |
| Code | Description | Qty | UOM | | | | | | | | | | | | | | | | | | | | | | |
| V11077A1 | SCREW M6X12 TE INOX | 1 | PZ | | | | | | | | | | | | | | | | | | | | | | |
| V11521A0 | STAINLESS STEEL WASHER D=6 6592 | 1 | PZ | | | | | | | | | | | | | | | | | | | | | | |
| VN1181A0 | M6 NUT 39 BLADES H81 D196 FAN | 1 | PZ | | | | | | | | | | | | | | | | | | | | | | |
| VN1181A0 | M6 NUT 39 BLADES H81 D196 FAN | 1 | PZ | | | | | | | | | | | | | | | | | | | | | | |
| | | | KVN1030A | LUX =08.2017S.5/S.5E D196 FAN KIT | <table border="1"> <thead> <tr> <th>Code</th> <th>Description</th> <th>Qty</th> <th>UOM</th> </tr> </thead> <tbody> <tr> <td>V11256A0</td> <td>M8 DIN 980M ST. STEEL SELF LOCKING NUT</td> <td>1</td> <td>PZ</td> </tr> <tr> <td>VM2196A0</td> <td>MOTOR NUT FASTENING BUSHING</td> <td>1</td> <td>PZ</td> </tr> <tr> <td>VN1030A5</td> <td>Ø196 H81 38 BLADES MOTOR FAN</td> <td>1</td> <td>PZ</td> </tr> <tr> <td>VN1030A5</td> <td>Ø196 H81 38 BLADES MOTOR FAN</td> <td>1</td> <td>PZ</td> </tr> </tbody> </table> | Code | Description | Qty | UOM | V11256A0 | M8 DIN 980M ST. STEEL SELF LOCKING NUT | 1 | PZ | VM2196A0 | MOTOR NUT FASTENING BUSHING | 1 | PZ | VN1030A5 | Ø196 H81 38 BLADES MOTOR FAN | 1 | PZ | VN1030A5 | Ø196 H81 38 BLADES MOTOR FAN | 1 | PZ |
| Code | Description | Qty | UOM | | | | | | | | | | | | | | | | | | | | | | |
| V11256A0 | M8 DIN 980M ST. STEEL SELF LOCKING NUT | 1 | PZ | | | | | | | | | | | | | | | | | | | | | | |
| VM2196A0 | MOTOR NUT FASTENING BUSHING | 1 | PZ | | | | | | | | | | | | | | | | | | | | | | |
| VN1030A5 | Ø196 H81 38 BLADES MOTOR FAN | 1 | PZ | | | | | | | | | | | | | | | | | | | | | | |
| VN1030A5 | Ø196 H81 38 BLADES MOTOR FAN | 1 | PZ | | | | | | | | | | | | | | | | | | | | | | |
| 0H7170A | MM MOTOR GLASS WOOL PLATE |  | 0H7170A0 | MM MOTOR GLASS WOOL PLATE | | | | | | | | | | | | | | | | | | | | | |

| COMPONENT | | | SPARE PART | | | | | | | | | | | | | | | | | | | | | | | | | | | | | | |
|-----------|--|---|------------|--|---|------|-------------|-----|-----|----------|---|-------|----|----------|--|-------|----|----------|--|---|----|----------|--------------------------------------|---|----|----------|-----------------------------|---|----|----------|------------|---|----|
| Code | Description | Image | Code | Description | Components list | | | | | | | | | | | | | | | | | | | | | | | | | | | | |
| RS1284A | 3200W 230V+400W 190V 4TURNS H80 ELEMENT |  | KRS1284A | 4TURN 3200W 230V+400W 190V HEAT ELEM KIT | <table border="1"> <thead> <tr> <th>Code</th> <th>Description</th> <th>Qty</th> <th>UOM</th> </tr> </thead> <tbody> <tr> <td>GN1327A0</td> <td>HEATING ELEMENT GASKET</td> <td>1</td> <td>PZ</td> </tr> <tr> <td>RS1284A0</td> <td>3200W 230V+400W 190V 4TURNS H80 ELEMENT</td> <td>1</td> <td>PZ</td> </tr> <tr> <td>SL1045A0</td> <td>S57 BLACK SILICONE - 80ML CARTRIDGE</td> <td>1</td> <td>PZ</td> </tr> <tr> <td>VI1220A1</td> <td>4,2X12 TCB SELF-TAPPIN G SCREW</td> <td>1</td> <td>PZ</td> </tr> <tr> <td>VM1794A0</td> <td>250X4.8 PA66 BLACK CLAMP</td> <td>2</td> <td>PZ</td> </tr> <tr> <td>VM2103A0</td> <td>CLAMP LOCK</td> <td>2</td> <td>PZ</td> </tr> </tbody> </table> | Code | Description | Qty | UOM | GN1327A0 | HEATING ELEMENT GASKET | 1 | PZ | RS1284A0 | 3200W 230V+400W 190V 4TURNS H80 ELEMENT | 1 | PZ | SL1045A0 | S57 BLACK SILICONE - 80ML CARTRIDGE | 1 | PZ | VI1220A1 | 4,2X12 TCB SELF-TAPPIN G SCREW | 1 | PZ | VM1794A0 | 250X4.8 PA66 BLACK CLAMP | 2 | PZ | VM2103A0 | CLAMP LOCK | 2 | PZ |
| Code | Description | Qty | UOM | | | | | | | | | | | | | | | | | | | | | | | | | | | | | | |
| GN1327A0 | HEATING ELEMENT GASKET | 1 | PZ | | | | | | | | | | | | | | | | | | | | | | | | | | | | | | |
| RS1284A0 | 3200W 230V+400W 190V 4TURNS H80 ELEMENT | 1 | PZ | | | | | | | | | | | | | | | | | | | | | | | | | | | | | | |
| SL1045A0 | S57 BLACK SILICONE - 80ML CARTRIDGE | 1 | PZ | | | | | | | | | | | | | | | | | | | | | | | | | | | | | | |
| VI1220A1 | 4,2X12 TCB SELF-TAPPIN G SCREW | 1 | PZ | | | | | | | | | | | | | | | | | | | | | | | | | | | | | | |
| VM1794A0 | 250X4.8 PA66 BLACK CLAMP | 2 | PZ | | | | | | | | | | | | | | | | | | | | | | | | | | | | | | |
| VM2103A0 | CLAMP LOCK | 2 | PZ | | | | | | | | | | | | | | | | | | | | | | | | | | | | | | |
| GN1597A | |  | KG1597A | BL SHOP.PRO ELENA DOOR GASKET KIT | <table border="1"> <thead> <tr> <th>Code</th> <th>Description</th> <th>Qty</th> <th>UOM</th> </tr> </thead> <tbody> <tr> <td>GN1110A2</td> <td>LINE MISS/XVC105- 055/XK/XL DOOR GASKE</td> <td>1.870</td> <td>M</td> </tr> <tr> <td>VM1224A0</td> <td>65MY 220MM 2 COLOURS SHRINK TUBE</td> <td>0.350</td> <td>M</td> </tr> </tbody> </table> | Code | Description | Qty | UOM | GN1110A2 | LINE MISS/XVC105- 055/XK/XL DOOR GASKE | 1.870 | M | VM1224A0 | 65MY 220MM 2 COLOURS SHRINK TUBE | 0.350 | M | | | | | | | | | | | | | | | | |
| Code | Description | Qty | UOM | | | | | | | | | | | | | | | | | | | | | | | | | | | | | | |
| GN1110A2 | LINE MISS/XVC105- 055/XK/XL DOOR GASKE | 1.870 | M | | | | | | | | | | | | | | | | | | | | | | | | | | | | | | |
| VM1224A0 | 65MY 220MM 2 COLOURS SHRINK TUBE | 0.350 | M | | | | | | | | | | | | | | | | | | | | | | | | | | | | | | |
| 0G1653A | ELENA SHOP PRO FAN GUARD |  | 0G1653A0 | ELENA SHOP PRO FAN GUARD | | | | | | | | | | | | | | | | | | | | | | | | | | | | | |
| TB1579A | ELENA SHOP PRO INTERNAL HUMIDITY PIPE |  | TB1579A0 | ELENA SHOP PRO INTERNAL HUMIDITY PIPE | | | | | | | | | | | | | | | | | | | | | | | | | | | | | |



| COMPONENT | | | SPARE PART | | |
|-------------|---|---|-------------|---|------------------------|
| <i>Code</i> | <i>Description</i> | <i>Image</i> | <i>Code</i> | <i>Description</i> | <i>Components list</i> |
| TB1638A | ELE-VIT-CAM SP WELDED EXT HUMIDITY PIPE |  | TB1638A0 | ELE-VIT-CAM SP WELDED EXT HUMIDITY PIPE | |

ASM3429A/0.D01 - Door

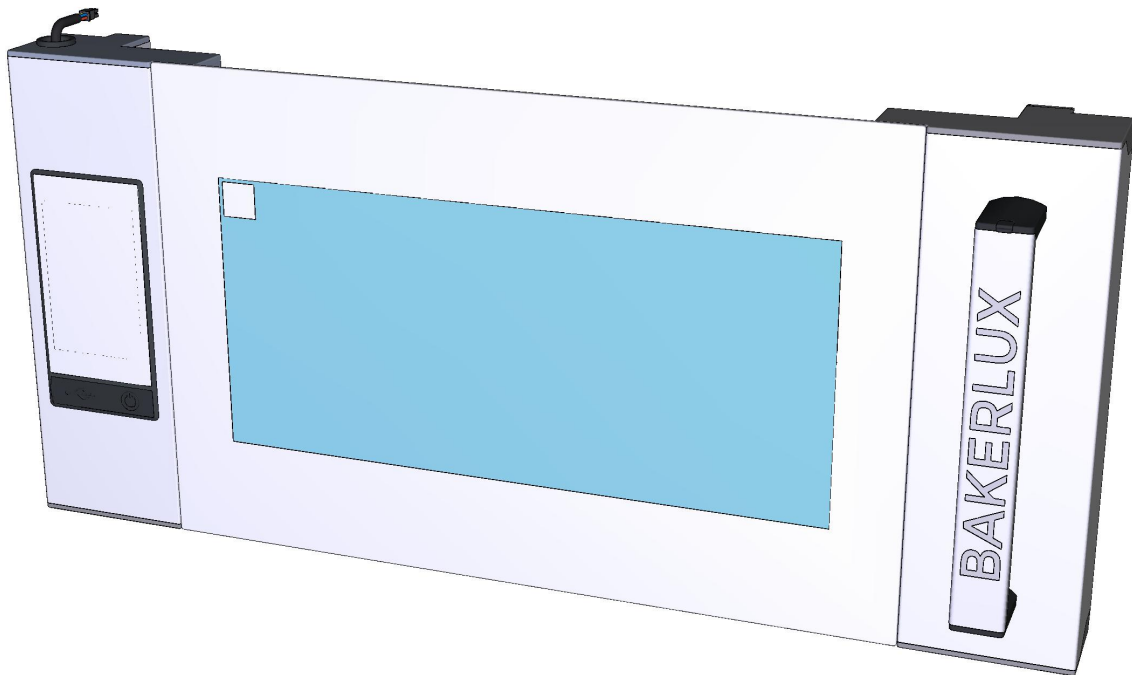

FRONT

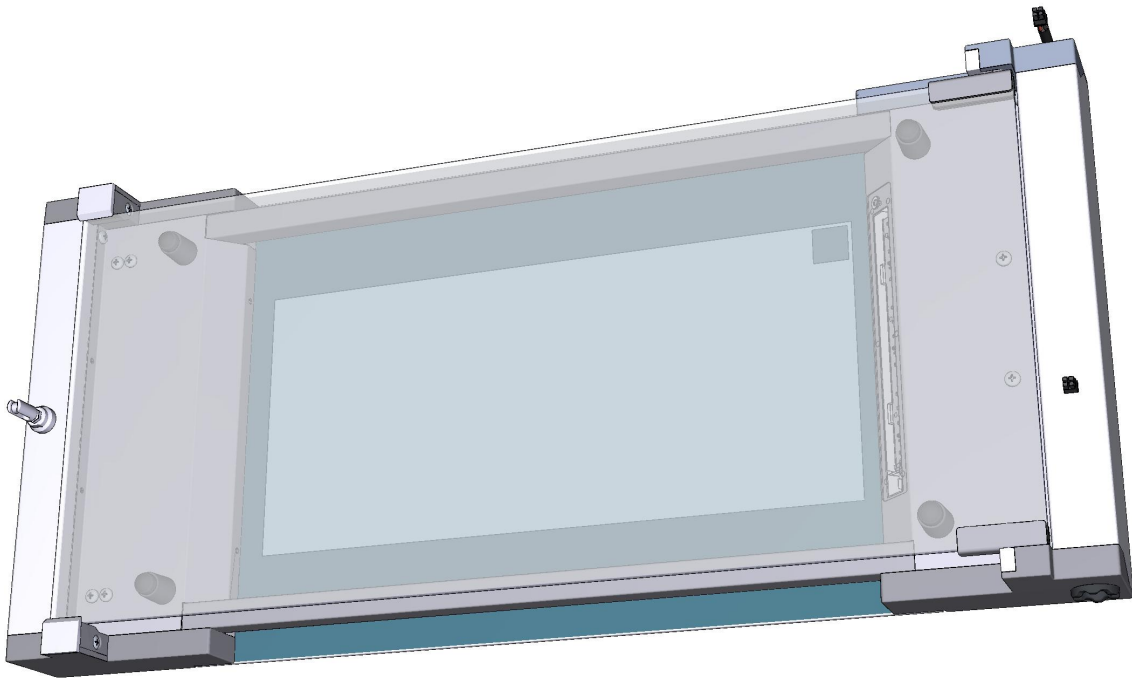

ASM3429A/0.D01 - Door

REAR

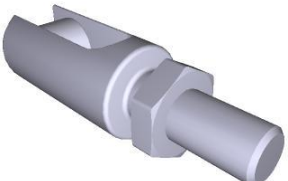







| COMPONENT | | | SPARE PART | | | | | | | | | | | | | | | | | | | | | | | | | | | | | | | | | | | | | | | | | | | | | | | | | | | | | | | | | | | | | | | | | | |
|-----------|--|---|---------------------------|--|---|------|-------------|-----|-----|----------|--|---|----|----------|--------------------------------|---|----|----------|-------------------------------|---|----|----------|--|---|----|----------|--------------------------------------|---|----|----------|--------------------------------|---|----|----------|-------------|---|----|----------|--------------------------|---|----|----------|------------|---|----|----------|------------------------------|---|----|----------|-------------------------------|---|----|----------|--------------------------------------|---|----|----------|-----------------------------------|---|----|----------|-----------------|---|----|----------|-------------------------------|---|----|
| Code | Description | Image | Code | Description | Components list | | | | | | | | | | | | | | | | | | | | | | | | | | | | | | | | | | | | | | | | | | | | | | | | | | | | | | | | | | | | | | | | |
| CR1040A | DOOR LATCH FOR EL.MECH. LOCKING SYSTEM |  | KCR1040A | LM MATIC DOOR LOCKING PIN KIT | <table border="1"> <thead> <tr> <th>Code</th> <th>Description</th> <th>Qty</th> <th>UOM</th> </tr> </thead> <tbody> <tr> <td>CR1040A0</td> <td>DOOR LATCH FOR EL.MECH. LOCKING SYSTEM</td> <td>1</td> <td>PZ</td> </tr> <tr> <td>VM1224A0</td> <td>65MY 220MM COLOURS SHRINK TUBE</td> <td>2</td> <td>M</td> </tr> </tbody> </table> | Code | Description | Qty | UOM | CR1040A0 | DOOR LATCH FOR EL.MECH. LOCKING SYSTEM | 1 | PZ | VM1224A0 | 65MY 220MM COLOURS SHRINK TUBE | 2 | M | | | | | | | | | | | | | | | | | | | | | | | | | | | | | | | | | | | | | | | | | | | | | | | | | | | | |
| Code | Description | Qty | UOM | | | | | | | | | | | | | | | | | | | | | | | | | | | | | | | | | | | | | | | | | | | | | | | | | | | | | | | | | | | | | | | | | | |
| CR1040A0 | DOOR LATCH FOR EL.MECH. LOCKING SYSTEM | 1 | PZ | | | | | | | | | | | | | | | | | | | | | | | | | | | | | | | | | | | | | | | | | | | | | | | | | | | | | | | | | | | | | | | | | | |
| VM1224A0 | 65MY 220MM COLOURS SHRINK TUBE | 2 | M | | | | | | | | | | | | | | | | | | | | | | | | | | | | | | | | | | | | | | | | | | | | | | | | | | | | | | | | | | | | | | | | | | |
| VM2274A | GROOVED BUSHING |  | KVM2274A K0B1126AR | GROOVED PIN BUSHING KIT BAKERTOP MM RIGHT DOOR LOWER BEAM KIT | <table border="1"> <thead> <tr> <th>Code</th> <th>Description</th> <th>Qty</th> <th>UOM</th> </tr> </thead> <tbody> <tr> <td>VM1224A0</td> <td>65MY 220MM COLOURS SHRINK TUBE</td> <td>2</td> <td>M</td> </tr> <tr> <td>VM2274A0</td> <td>GROOVED BUSHING</td> <td>1</td> <td>PZ</td> </tr> <tr> <td>OB1126A0</td> <td>DOOR LOWER FRAME SHAPE 860 MM</td> <td>1</td> <td>PZ</td> </tr> <tr> <td>OB1126A1</td> <td></td> <td>1</td> <td>PZ</td> </tr> <tr> <td>RC1200A0</td> <td>ED=4 WIRE D.=0.5 COMPRESSIO N SPRING</td> <td>2</td> <td>PZ</td> </tr> <tr> <td>VI1220A1</td> <td>4,2X12 TCB SELF-TAPPIN G SCREW</td> <td>1</td> <td>PZ</td> </tr> <tr> <td>VI1996A0</td> <td>M5X35 SCREW</td> <td>7</td> <td>PZ</td> </tr> <tr> <td>VM1794A0</td> <td>250X4.8 PA66 BLACK CLAMP</td> <td>2</td> <td>PZ</td> </tr> <tr> <td>VM2103A0</td> <td>CLAMP LOCK</td> <td>2</td> <td>PZ</td> </tr> <tr> <td>VM2259A1</td> <td>6 SERIES DOOR LOWER LEFT CAP</td> <td>1</td> <td>PZ</td> </tr> <tr> <td>VM2261A1</td> <td>6 SERIES DOOR LOWER RIGHT CAP</td> <td>1</td> <td>PZ</td> </tr> <tr> <td>VM2267A0</td> <td>INTERNAL GLASS LOCKING SYSTEM SLIDER</td> <td>1</td> <td>PZ</td> </tr> <tr> <td>VM2269A0</td> <td>INTERNAL GLASS LOCKING SYSTEM CAP</td> <td>1</td> <td>PZ</td> </tr> <tr> <td>VM2274A0</td> <td>GROOVED BUSHING</td> <td>1</td> <td>PZ</td> </tr> <tr> <td>VM2305A0</td> <td>6 SERIES DOOR CAP FIXING PAWL</td> <td>7</td> <td>PZ</td> </tr> </tbody> </table> | Code | Description | Qty | UOM | VM1224A0 | 65MY 220MM COLOURS SHRINK TUBE | 2 | M | VM2274A0 | GROOVED BUSHING | 1 | PZ | OB1126A0 | DOOR LOWER FRAME SHAPE 860 MM | 1 | PZ | OB1126A1 | | 1 | PZ | RC1200A0 | ED=4 WIRE D.=0.5 COMPRESSIO N SPRING | 2 | PZ | VI1220A1 | 4,2X12 TCB SELF-TAPPIN G SCREW | 1 | PZ | VI1996A0 | M5X35 SCREW | 7 | PZ | VM1794A0 | 250X4.8 PA66 BLACK CLAMP | 2 | PZ | VM2103A0 | CLAMP LOCK | 2 | PZ | VM2259A1 | 6 SERIES DOOR LOWER LEFT CAP | 1 | PZ | VM2261A1 | 6 SERIES DOOR LOWER RIGHT CAP | 1 | PZ | VM2267A0 | INTERNAL GLASS LOCKING SYSTEM SLIDER | 1 | PZ | VM2269A0 | INTERNAL GLASS LOCKING SYSTEM CAP | 1 | PZ | VM2274A0 | GROOVED BUSHING | 1 | PZ | VM2305A0 | 6 SERIES DOOR CAP FIXING PAWL | 7 | PZ |
| Code | Description | Qty | UOM | | | | | | | | | | | | | | | | | | | | | | | | | | | | | | | | | | | | | | | | | | | | | | | | | | | | | | | | | | | | | | | | | | |
| VM1224A0 | 65MY 220MM COLOURS SHRINK TUBE | 2 | M | | | | | | | | | | | | | | | | | | | | | | | | | | | | | | | | | | | | | | | | | | | | | | | | | | | | | | | | | | | | | | | | | | |
| VM2274A0 | GROOVED BUSHING | 1 | PZ | | | | | | | | | | | | | | | | | | | | | | | | | | | | | | | | | | | | | | | | | | | | | | | | | | | | | | | | | | | | | | | | | | |
| OB1126A0 | DOOR LOWER FRAME SHAPE 860 MM | 1 | PZ | | | | | | | | | | | | | | | | | | | | | | | | | | | | | | | | | | | | | | | | | | | | | | | | | | | | | | | | | | | | | | | | | | |
| OB1126A1 | | 1 | PZ | | | | | | | | | | | | | | | | | | | | | | | | | | | | | | | | | | | | | | | | | | | | | | | | | | | | | | | | | | | | | | | | | | |
| RC1200A0 | ED=4 WIRE D.=0.5 COMPRESSIO N SPRING | 2 | PZ | | | | | | | | | | | | | | | | | | | | | | | | | | | | | | | | | | | | | | | | | | | | | | | | | | | | | | | | | | | | | | | | | | |
| VI1220A1 | 4,2X12 TCB SELF-TAPPIN G SCREW | 1 | PZ | | | | | | | | | | | | | | | | | | | | | | | | | | | | | | | | | | | | | | | | | | | | | | | | | | | | | | | | | | | | | | | | | | |
| VI1996A0 | M5X35 SCREW | 7 | PZ | | | | | | | | | | | | | | | | | | | | | | | | | | | | | | | | | | | | | | | | | | | | | | | | | | | | | | | | | | | | | | | | | | |
| VM1794A0 | 250X4.8 PA66 BLACK CLAMP | 2 | PZ | | | | | | | | | | | | | | | | | | | | | | | | | | | | | | | | | | | | | | | | | | | | | | | | | | | | | | | | | | | | | | | | | | |
| VM2103A0 | CLAMP LOCK | 2 | PZ | | | | | | | | | | | | | | | | | | | | | | | | | | | | | | | | | | | | | | | | | | | | | | | | | | | | | | | | | | | | | | | | | | |
| VM2259A1 | 6 SERIES DOOR LOWER LEFT CAP | 1 | PZ | | | | | | | | | | | | | | | | | | | | | | | | | | | | | | | | | | | | | | | | | | | | | | | | | | | | | | | | | | | | | | | | | | |
| VM2261A1 | 6 SERIES DOOR LOWER RIGHT CAP | 1 | PZ | | | | | | | | | | | | | | | | | | | | | | | | | | | | | | | | | | | | | | | | | | | | | | | | | | | | | | | | | | | | | | | | | | |
| VM2267A0 | INTERNAL GLASS LOCKING SYSTEM SLIDER | 1 | PZ | | | | | | | | | | | | | | | | | | | | | | | | | | | | | | | | | | | | | | | | | | | | | | | | | | | | | | | | | | | | | | | | | | |
| VM2269A0 | INTERNAL GLASS LOCKING SYSTEM CAP | 1 | PZ | | | | | | | | | | | | | | | | | | | | | | | | | | | | | | | | | | | | | | | | | | | | | | | | | | | | | | | | | | | | | | | | | | |
| VM2274A0 | GROOVED BUSHING | 1 | PZ | | | | | | | | | | | | | | | | | | | | | | | | | | | | | | | | | | | | | | | | | | | | | | | | | | | | | | | | | | | | | | | | | | |
| VM2305A0 | 6 SERIES DOOR CAP FIXING PAWL | 7 | PZ | | | | | | | | | | | | | | | | | | | | | | | | | | | | | | | | | | | | | | | | | | | | | | | | | | | | | | | | | | | | | | | | | | |

| COMPONENT | | | SPARE PART | | | | | | | | | | | | | | | | | | | | | | | | | | | | | | | | | | | | | | | | | | | | | | | | | | | | | | | | | | | | | | | | | | | | | | | | | | | | | | | | | | | | | |
|-----------|--|---|------------|--|--|------|-------------|-----|-----|----------|-------------------------------------|---|----|----------|--|---|----|----------|---|---|----|----------|--------------------------------------|---|----|----------|-------------|---|----|----------|-----------------------------|---|----|----------|------------|---|----|----------|--|---|----|----------|--|---|----|----------|--------------------|---|----|----------|-------------------------------------|---|----|----------|------------------------------------|---|----|----------|------------------------------------|---|----|----------|-----------------------------------|---|----|----------|-----------------------------------|---|----|-----------|--|---|------|-------------|-----|-----|----------|------------------------------------|---|----|----------|------------------------------------|---|----|----------|---|---|----|
| Code | Description | Image | Code | Description | Components list | | | | | | | | | | | | | | | | | | | | | | | | | | | | | | | | | | | | | | | | | | | | | | | | | | | | | | | | | | | | | | | | | | | | | | | | | | | | | | | | | | | |
| VM2274A | GROOVED BUSHING |  | K0B1126AL | EU AND 2/1 MM LEFT DOOR LOWER BEAM KIT | <table border="1"> <thead> <tr> <th>Code</th> <th>Description</th> <th>Qty</th> <th>UOM</th> </tr> </thead> <tbody> <tr> <td>0B1126A0</td> <td>DOOR LOWER FRAME SHAPE 860 MM</td> <td>1</td> <td>PZ</td> </tr> <tr> <td>0B1126A1</td> <td></td> <td>1</td> <td>PZ</td> </tr> <tr> <td>RC1200A0</td> <td>ED=4 WIRE D.=0.5 COMPRESSIO N SPRING</td> <td>2</td> <td>PZ</td> </tr> <tr> <td>VI1220A1</td> <td>4,2X12 TCB SELF-TAPPIN G SCREW</td> <td>1</td> <td>PZ</td> </tr> <tr> <td>VI1996A0</td> <td>M5X35 SCREW</td> <td>7</td> <td>PZ</td> </tr> <tr> <td>VM1794A0</td> <td>250X4.8 PA66 BLACK CLAMP</td> <td>2</td> <td>PZ</td> </tr> <tr> <td>VM2103A0</td> <td>CLAMP LOCK</td> <td>2</td> <td>PZ</td> </tr> <tr> <td>VM2267A0</td> <td>INTERNAL GLASS LOCKING SYSTEM SLIDER</td> <td>1</td> <td>PZ</td> </tr> <tr> <td>VM2269A0</td> <td>INTERNAL GLASS LOCKING SYSTEM CAP</td> <td>1</td> <td>PZ</td> </tr> <tr> <td>VM2274A0</td> <td>GROOVED BUSHING</td> <td>1</td> <td>PZ</td> </tr> <tr> <td>VM2305A0</td> <td>6 SERIES DOOR CAP FIXING PAWL</td> <td>7</td> <td>PZ</td> </tr> <tr> <td>VM2384A0</td> <td>MM LEFT DOOR RIGHT LOWER CAP</td> <td>1</td> <td>PZ</td> </tr> <tr> <td>VM2384A0</td> <td>MM LEFT DOOR RIGHT LOWER CAP</td> <td>1</td> <td>PZ</td> </tr> <tr> <td>VM2386A1</td> <td>LEFT MM DOOR LOWER LEFT CAP</td> <td>1</td> <td>PZ</td> </tr> <tr> <td>VM2386A1</td> <td>LEFT MM DOOR LOWER LEFT CAP</td> <td>1</td> <td>PZ</td> </tr> </tbody> </table> | Code | Description | Qty | UOM | 0B1126A0 | DOOR LOWER FRAME SHAPE 860 MM | 1 | PZ | 0B1126A1 | | 1 | PZ | RC1200A0 | ED=4 WIRE D.=0.5 COMPRESSIO N SPRING | 2 | PZ | VI1220A1 | 4,2X12 TCB SELF-TAPPIN G SCREW | 1 | PZ | VI1996A0 | M5X35 SCREW | 7 | PZ | VM1794A0 | 250X4.8 PA66 BLACK CLAMP | 2 | PZ | VM2103A0 | CLAMP LOCK | 2 | PZ | VM2267A0 | INTERNAL GLASS LOCKING SYSTEM SLIDER | 1 | PZ | VM2269A0 | INTERNAL GLASS LOCKING SYSTEM CAP | 1 | PZ | VM2274A0 | GROOVED BUSHING | 1 | PZ | VM2305A0 | 6 SERIES DOOR CAP FIXING PAWL | 7 | PZ | VM2384A0 | MM LEFT DOOR RIGHT LOWER CAP | 1 | PZ | VM2384A0 | MM LEFT DOOR RIGHT LOWER CAP | 1 | PZ | VM2386A1 | LEFT MM DOOR LOWER LEFT CAP | 1 | PZ | VM2386A1 | LEFT MM DOOR LOWER LEFT CAP | 1 | PZ | K0B1122AR | CHEFTOP MM RIGHT DOOR LOWER BEAM KIT | <table border="1"> <thead> <tr> <th>Code</th> <th>Description</th> <th>Qty</th> <th>UOM</th> </tr> </thead> <tbody> <tr> <td>0B1122A0</td> <td>750MM DOOR LOWER FRAME SHAPE</td> <td>1</td> <td>PZ</td> </tr> <tr> <td>0B1122A1</td> <td>750MM DOOR LOWER FRAME SHAPE</td> <td>1</td> <td>PZ</td> </tr> <tr> <td>RC1200A0</td> <td>ED=4 WIRE D.=0.5 COMPRESSIO N SPRING</td> <td>2</td> <td>PZ</td> </tr> </tbody> </table> | Code | Description | Qty | UOM | 0B1122A0 | 750MM DOOR LOWER FRAME SHAPE | 1 | PZ | 0B1122A1 | 750MM DOOR LOWER FRAME SHAPE | 1 | PZ | RC1200A0 | ED=4 WIRE D.=0.5 COMPRESSIO N SPRING | 2 | PZ |
| | | | Code | Description | Qty | UOM | | | | | | | | | | | | | | | | | | | | | | | | | | | | | | | | | | | | | | | | | | | | | | | | | | | | | | | | | | | | | | | | | | | | | | | | | | | | | | | | | | |
| 0B1126A0 | DOOR LOWER FRAME SHAPE 860 MM | 1 | PZ | | | | | | | | | | | | | | | | | | | | | | | | | | | | | | | | | | | | | | | | | | | | | | | | | | | | | | | | | | | | | | | | | | | | | | | | | | | | | | | | | | | | | |
| 0B1126A1 | | 1 | PZ | | | | | | | | | | | | | | | | | | | | | | | | | | | | | | | | | | | | | | | | | | | | | | | | | | | | | | | | | | | | | | | | | | | | | | | | | | | | | | | | | | | | | |
| RC1200A0 | ED=4 WIRE D.=0.5 COMPRESSIO N SPRING | 2 | PZ | | | | | | | | | | | | | | | | | | | | | | | | | | | | | | | | | | | | | | | | | | | | | | | | | | | | | | | | | | | | | | | | | | | | | | | | | | | | | | | | | | | | | |
| VI1220A1 | 4,2X12 TCB SELF-TAPPIN G SCREW | 1 | PZ | | | | | | | | | | | | | | | | | | | | | | | | | | | | | | | | | | | | | | | | | | | | | | | | | | | | | | | | | | | | | | | | | | | | | | | | | | | | | | | | | | | | | |
| VI1996A0 | M5X35 SCREW | 7 | PZ | | | | | | | | | | | | | | | | | | | | | | | | | | | | | | | | | | | | | | | | | | | | | | | | | | | | | | | | | | | | | | | | | | | | | | | | | | | | | | | | | | | | | |
| VM1794A0 | 250X4.8 PA66 BLACK CLAMP | 2 | PZ | | | | | | | | | | | | | | | | | | | | | | | | | | | | | | | | | | | | | | | | | | | | | | | | | | | | | | | | | | | | | | | | | | | | | | | | | | | | | | | | | | | | | |
| VM2103A0 | CLAMP LOCK | 2 | PZ | | | | | | | | | | | | | | | | | | | | | | | | | | | | | | | | | | | | | | | | | | | | | | | | | | | | | | | | | | | | | | | | | | | | | | | | | | | | | | | | | | | | | |
| VM2267A0 | INTERNAL GLASS LOCKING SYSTEM SLIDER | 1 | PZ | | | | | | | | | | | | | | | | | | | | | | | | | | | | | | | | | | | | | | | | | | | | | | | | | | | | | | | | | | | | | | | | | | | | | | | | | | | | | | | | | | | | | |
| VM2269A0 | INTERNAL GLASS LOCKING SYSTEM CAP | 1 | PZ | | | | | | | | | | | | | | | | | | | | | | | | | | | | | | | | | | | | | | | | | | | | | | | | | | | | | | | | | | | | | | | | | | | | | | | | | | | | | | | | | | | | | |
| VM2274A0 | GROOVED BUSHING | 1 | PZ | | | | | | | | | | | | | | | | | | | | | | | | | | | | | | | | | | | | | | | | | | | | | | | | | | | | | | | | | | | | | | | | | | | | | | | | | | | | | | | | | | | | | |
| VM2305A0 | 6 SERIES DOOR CAP FIXING PAWL | 7 | PZ | | | | | | | | | | | | | | | | | | | | | | | | | | | | | | | | | | | | | | | | | | | | | | | | | | | | | | | | | | | | | | | | | | | | | | | | | | | | | | | | | | | | | |
| VM2384A0 | MM LEFT DOOR RIGHT LOWER CAP | 1 | PZ | | | | | | | | | | | | | | | | | | | | | | | | | | | | | | | | | | | | | | | | | | | | | | | | | | | | | | | | | | | | | | | | | | | | | | | | | | | | | | | | | | | | | |
| VM2384A0 | MM LEFT DOOR RIGHT LOWER CAP | 1 | PZ | | | | | | | | | | | | | | | | | | | | | | | | | | | | | | | | | | | | | | | | | | | | | | | | | | | | | | | | | | | | | | | | | | | | | | | | | | | | | | | | | | | | | |
| VM2386A1 | LEFT MM DOOR LOWER LEFT CAP | 1 | PZ | | | | | | | | | | | | | | | | | | | | | | | | | | | | | | | | | | | | | | | | | | | | | | | | | | | | | | | | | | | | | | | | | | | | | | | | | | | | | | | | | | | | | |
| VM2386A1 | LEFT MM DOOR LOWER LEFT CAP | 1 | PZ | | | | | | | | | | | | | | | | | | | | | | | | | | | | | | | | | | | | | | | | | | | | | | | | | | | | | | | | | | | | | | | | | | | | | | | | | | | | | | | | | | | | | |
| Code | Description | Qty | UOM | | | | | | | | | | | | | | | | | | | | | | | | | | | | | | | | | | | | | | | | | | | | | | | | | | | | | | | | | | | | | | | | | | | | | | | | | | | | | | | | | | | | | |
| 0B1122A0 | 750MM DOOR LOWER FRAME SHAPE | 1 | PZ | | | | | | | | | | | | | | | | | | | | | | | | | | | | | | | | | | | | | | | | | | | | | | | | | | | | | | | | | | | | | | | | | | | | | | | | | | | | | | | | | | | | | |
| 0B1122A1 | 750MM DOOR LOWER FRAME SHAPE | 1 | PZ | | | | | | | | | | | | | | | | | | | | | | | | | | | | | | | | | | | | | | | | | | | | | | | | | | | | | | | | | | | | | | | | | | | | | | | | | | | | | | | | | | | | | |
| RC1200A0 | ED=4 WIRE D.=0.5 COMPRESSIO N SPRING | 2 | PZ | | | | | | | | | | | | | | | | | | | | | | | | | | | | | | | | | | | | | | | | | | | | | | | | | | | | | | | | | | | | | | | | | | | | | | | | | | | | | | | | | | | | | |

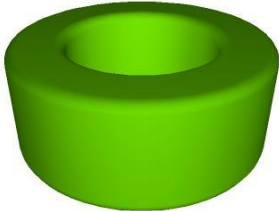

| COMPONENT | | | SPARE PART | | | | | | | | | | | | | | | | | | | | | | | | | | | | | | | | | | | | | | | | | | | | | | |
|-----------|--|---|------------|--|--|------|-------------|------------------------------------|-----|----------|--------------------------------------|------------------------------------|----|----------|-------------|---|----|----------|-----------------------------|--------------------------------------|----|----------|------------|-------------|----|----------|------------------------------------|-----------------------------|----|----------|-------------------------------------|------------|----|----------|--|--|----|----------|--|--|----|----------|--------------------|---|----|----------|-------------------------------------|---|----|
| Code | Description | Image | Code | Description | Components list | | | | | | | | | | | | | | | | | | | | | | | | | | | | | | | | | | | | | | | | | | | | |
| VM2274A | GROOVED BUSHING |  | K0B1122AR | CHEFTOP MM RIGHT DOOR LOWER BEAM KIT | <table border="1"> <thead> <tr> <th>Code</th> <th>Description</th> <th>Qty</th> <th>UOM</th> </tr> </thead> <tbody> <tr> <td>VI1220A1</td> <td>4,2X12 TCB SELF-TAPPIN G SCREW</td> <td>1</td> <td>PZ</td> </tr> <tr> <td>VI1996A0</td> <td>M5X35 SCREW</td> <td>7</td> <td>PZ</td> </tr> <tr> <td>VM1794A0</td> <td>250X4.8 PA66 BLACK CLAMP</td> <td>2</td> <td>PZ</td> </tr> <tr> <td>VM2103A0</td> <td>CLAMP LOCK</td> <td>2</td> <td>PZ</td> </tr> <tr> <td>VM2259A1</td> <td>6 SERIES DOOR LOWER LEFT CAP</td> <td>1</td> <td>PZ</td> </tr> <tr> <td>VM2261A1</td> <td>6 SERIES DOOR LOWER RIGHT CAP</td> <td>1</td> <td>PZ</td> </tr> <tr> <td>VM2267A0</td> <td>INTERNAL GLASS LOCKING SYSTEM SLIDER</td> <td>1</td> <td>PZ</td> </tr> <tr> <td>VM2269A0</td> <td>INTERNAL GLASS LOCKING SYSTEM CAP</td> <td>1</td> <td>PZ</td> </tr> <tr> <td>VM2274A0</td> <td>GROOVED BUSHING</td> <td>1</td> <td>PZ</td> </tr> <tr> <td>VM2305A0</td> <td>6 SERIES DOOR CAP FIXING PAWL</td> <td>7</td> <td>PZ</td> </tr> </tbody> </table> | Code | Description | Qty | UOM | VI1220A1 | 4,2X12 TCB SELF-TAPPIN G SCREW | 1 | PZ | VI1996A0 | M5X35 SCREW | 7 | PZ | VM1794A0 | 250X4.8 PA66 BLACK CLAMP | 2 | PZ | VM2103A0 | CLAMP LOCK | 2 | PZ | VM2259A1 | 6 SERIES DOOR LOWER LEFT CAP | 1 | PZ | VM2261A1 | 6 SERIES DOOR LOWER RIGHT CAP | 1 | PZ | VM2267A0 | INTERNAL GLASS LOCKING SYSTEM SLIDER | 1 | PZ | VM2269A0 | INTERNAL GLASS LOCKING SYSTEM CAP | 1 | PZ | VM2274A0 | GROOVED BUSHING | 1 | PZ | VM2305A0 | 6 SERIES DOOR CAP FIXING PAWL | 7 | PZ |
| | | | Code | Description | Qty | UOM | | | | | | | | | | | | | | | | | | | | | | | | | | | | | | | | | | | | | | | | | | | |
| VI1220A1 | 4,2X12 TCB SELF-TAPPIN G SCREW | 1 | PZ | | | | | | | | | | | | | | | | | | | | | | | | | | | | | | | | | | | | | | | | | | | | | | |
| VI1996A0 | M5X35 SCREW | 7 | PZ | | | | | | | | | | | | | | | | | | | | | | | | | | | | | | | | | | | | | | | | | | | | | | |
| VM1794A0 | 250X4.8 PA66 BLACK CLAMP | 2 | PZ | | | | | | | | | | | | | | | | | | | | | | | | | | | | | | | | | | | | | | | | | | | | | | |
| VM2103A0 | CLAMP LOCK | 2 | PZ | | | | | | | | | | | | | | | | | | | | | | | | | | | | | | | | | | | | | | | | | | | | | | |
| VM2259A1 | 6 SERIES DOOR LOWER LEFT CAP | 1 | PZ | | | | | | | | | | | | | | | | | | | | | | | | | | | | | | | | | | | | | | | | | | | | | | |
| VM2261A1 | 6 SERIES DOOR LOWER RIGHT CAP | 1 | PZ | | | | | | | | | | | | | | | | | | | | | | | | | | | | | | | | | | | | | | | | | | | | | | |
| VM2267A0 | INTERNAL GLASS LOCKING SYSTEM SLIDER | 1 | PZ | | | | | | | | | | | | | | | | | | | | | | | | | | | | | | | | | | | | | | | | | | | | | | |
| VM2269A0 | INTERNAL GLASS LOCKING SYSTEM CAP | 1 | PZ | | | | | | | | | | | | | | | | | | | | | | | | | | | | | | | | | | | | | | | | | | | | | | |
| VM2274A0 | GROOVED BUSHING | 1 | PZ | | | | | | | | | | | | | | | | | | | | | | | | | | | | | | | | | | | | | | | | | | | | | | |
| VM2305A0 | 6 SERIES DOOR CAP FIXING PAWL | 7 | PZ | | | | | | | | | | | | | | | | | | | | | | | | | | | | | | | | | | | | | | | | | | | | | | |
| K0B1122AL | CHEFTOP MM LEFT DOOR LOWER BEAM KIT | <table border="1"> <thead> <tr> <th>Code</th> <th>Description</th> <th>Qty</th> <th>UOM</th> </tr> </thead> <tbody> <tr> <td>0B1122A0</td> <td>750MM DOOR LOWER FRAME SHAPE</td> <td>1</td> <td>PZ</td> </tr> <tr> <td>0B1122A1</td> <td>750MM DOOR LOWER FRAME SHAPE</td> <td>1</td> <td>PZ</td> </tr> <tr> <td>RC1200A0</td> <td>ED=4 WIRE D.=0.5 COMPRESSIO N SPRING</td> <td>2</td> <td>PZ</td> </tr> <tr> <td>VI1220A1</td> <td>4,2X12 TCB SELF-TAPPIN G SCREW</td> <td>1</td> <td>PZ</td> </tr> <tr> <td>VI1996A0</td> <td>M5X35 SCREW</td> <td>7</td> <td>PZ</td> </tr> <tr> <td>VM1794A0</td> <td>250X4.8 PA66 BLACK CLAMP</td> <td>2</td> <td>PZ</td> </tr> <tr> <td>VM2103A0</td> <td>CLAMP LOCK</td> <td>2</td> <td>PZ</td> </tr> <tr> <td>VM2267A0</td> <td>INTERNAL GLASS LOCKING SYSTEM SLIDER</td> <td>1</td> <td>PZ</td> </tr> <tr> <td>VM2269A0</td> <td>INTERNAL GLASS LOCKING SYSTEM CAP</td> <td>1</td> <td>PZ</td> </tr> </tbody> </table> | Code | Description | Qty | UOM | 0B1122A0 | 750MM DOOR LOWER FRAME SHAPE | 1 | PZ | 0B1122A1 | 750MM DOOR LOWER FRAME SHAPE | 1 | PZ | RC1200A0 | ED=4 WIRE D.=0.5 COMPRESSIO N SPRING | 2 | PZ | VI1220A1 | 4,2X12 TCB SELF-TAPPIN G SCREW | 1 | PZ | VI1996A0 | M5X35 SCREW | 7 | PZ | VM1794A0 | 250X4.8 PA66 BLACK CLAMP | 2 | PZ | VM2103A0 | CLAMP LOCK | 2 | PZ | VM2267A0 | INTERNAL GLASS LOCKING SYSTEM SLIDER | 1 | PZ | VM2269A0 | INTERNAL GLASS LOCKING SYSTEM CAP | 1 | PZ | | | | | | | |
| Code | Description | Qty | UOM | | | | | | | | | | | | | | | | | | | | | | | | | | | | | | | | | | | | | | | | | | | | | | |
| 0B1122A0 | 750MM DOOR LOWER FRAME SHAPE | 1 | PZ | | | | | | | | | | | | | | | | | | | | | | | | | | | | | | | | | | | | | | | | | | | | | | |
| 0B1122A1 | 750MM DOOR LOWER FRAME SHAPE | 1 | PZ | | | | | | | | | | | | | | | | | | | | | | | | | | | | | | | | | | | | | | | | | | | | | | |
| RC1200A0 | ED=4 WIRE D.=0.5 COMPRESSIO N SPRING | 2 | PZ | | | | | | | | | | | | | | | | | | | | | | | | | | | | | | | | | | | | | | | | | | | | | | |
| VI1220A1 | 4,2X12 TCB SELF-TAPPIN G SCREW | 1 | PZ | | | | | | | | | | | | | | | | | | | | | | | | | | | | | | | | | | | | | | | | | | | | | | |
| VI1996A0 | M5X35 SCREW | 7 | PZ | | | | | | | | | | | | | | | | | | | | | | | | | | | | | | | | | | | | | | | | | | | | | | |
| VM1794A0 | 250X4.8 PA66 BLACK CLAMP | 2 | PZ | | | | | | | | | | | | | | | | | | | | | | | | | | | | | | | | | | | | | | | | | | | | | | |
| VM2103A0 | CLAMP LOCK | 2 | PZ | | | | | | | | | | | | | | | | | | | | | | | | | | | | | | | | | | | | | | | | | | | | | | |
| VM2267A0 | INTERNAL GLASS LOCKING SYSTEM SLIDER | 1 | PZ | | | | | | | | | | | | | | | | | | | | | | | | | | | | | | | | | | | | | | | | | | | | | | |
| VM2269A0 | INTERNAL GLASS LOCKING SYSTEM CAP | 1 | PZ | | | | | | | | | | | | | | | | | | | | | | | | | | | | | | | | | | | | | | | | | | | | | | |

| COMPONENT | | | SPARE PART | | | | | | | | | | | | | | | | | | | | | | | | | | | | | | |
|-----------|---|---|------------|-------------------------------------|---|------|-------------|-----|-----|----------|---|-------|----|----------|-----------------------------------|---|----|----------|----------------------------------|---|----|----------|-------------------------------|---|----|----------|-----------------------------|-------|----|----------|-----------------------------|---|----|
| Code | Description | Image | Code | Description | Components list | | | | | | | | | | | | | | | | | | | | | | | | | | | | |
| VM2274A | GROOVED BUSHING |  | K0B1122AL | CHEFTOP MM LEFT DOOR LOWER BEAM KIT | <table border="1"> <thead> <tr> <th>Code</th> <th>Description</th> <th>Qty</th> <th>UOM</th> </tr> </thead> <tbody> <tr> <td>VM2274A0</td> <td>GROOVED BUSHING</td> <td>1</td> <td>PZ</td> </tr> <tr> <td>VM2305A0</td> <td>6 SERIES DOOR CAP FIXING PAWL</td> <td>7</td> <td>PZ</td> </tr> <tr> <td>VM2384A0</td> <td>MM LEFT DOOR RIGHT LOWER CAP</td> <td>1</td> <td>PZ</td> </tr> <tr> <td>VM2384A0</td> <td>MM LEFT DOOR RIGHT LOWER CAP</td> <td>1</td> <td>PZ</td> </tr> <tr> <td>VM2386A1</td> <td>LEFT MM DOOR LOWER LEFT CAP</td> <td>1</td> <td>PZ</td> </tr> <tr> <td>VM2386A1</td> <td>LEFT MM DOOR LOWER LEFT CAP</td> <td>1</td> <td>PZ</td> </tr> </tbody> </table> | Code | Description | Qty | UOM | VM2274A0 | GROOVED BUSHING | 1 | PZ | VM2305A0 | 6 SERIES DOOR CAP FIXING PAWL | 7 | PZ | VM2384A0 | MM LEFT DOOR RIGHT LOWER CAP | 1 | PZ | VM2384A0 | MM LEFT DOOR RIGHT LOWER CAP | 1 | PZ | VM2386A1 | LEFT MM DOOR LOWER LEFT CAP | 1 | PZ | VM2386A1 | LEFT MM DOOR LOWER LEFT CAP | 1 | PZ |
| Code | Description | Qty | UOM | | | | | | | | | | | | | | | | | | | | | | | | | | | | | | |
| VM2274A0 | GROOVED BUSHING | 1 | PZ | | | | | | | | | | | | | | | | | | | | | | | | | | | | | | |
| VM2305A0 | 6 SERIES DOOR CAP FIXING PAWL | 7 | PZ | | | | | | | | | | | | | | | | | | | | | | | | | | | | | | |
| VM2384A0 | MM LEFT DOOR RIGHT LOWER CAP | 1 | PZ | | | | | | | | | | | | | | | | | | | | | | | | | | | | | | |
| VM2384A0 | MM LEFT DOOR RIGHT LOWER CAP | 1 | PZ | | | | | | | | | | | | | | | | | | | | | | | | | | | | | | |
| VM2386A1 | LEFT MM DOOR LOWER LEFT CAP | 1 | PZ | | | | | | | | | | | | | | | | | | | | | | | | | | | | | | |
| VM2386A1 | LEFT MM DOOR LOWER LEFT CAP | 1 | PZ | | | | | | | | | | | | | | | | | | | | | | | | | | | | | | |
| VM2275A | SMOOTH BUSHING |  | KVM2275A | SMOOTH PIN BUSHING KIT | <table border="1"> <thead> <tr> <th>Code</th> <th>Description</th> <th>Qty</th> <th>UOM</th> </tr> </thead> <tbody> <tr> <td>VM1224A0</td> <td>65MY 220MM 2 COLOURS SHRINK TUBE</td> <td>0.150</td> <td>M</td> </tr> <tr> <td>VM2275A0</td> <td>SMOOTH BUSHING</td> <td>1</td> <td>PZ</td> </tr> </tbody> </table> | Code | Description | Qty | UOM | VM1224A0 | 65MY 220MM 2 COLOURS SHRINK TUBE | 0.150 | M | VM2275A0 | SMOOTH BUSHING | 1 | PZ | | | | | | | | | | | | | | | | |
| Code | Description | Qty | UOM | | | | | | | | | | | | | | | | | | | | | | | | | | | | | | |
| VM1224A0 | 65MY 220MM 2 COLOURS SHRINK TUBE | 0.150 | M | | | | | | | | | | | | | | | | | | | | | | | | | | | | | | |
| VM2275A0 | SMOOTH BUSHING | 1 | PZ | | | | | | | | | | | | | | | | | | | | | | | | | | | | | | |
| CE1285A | EMI ROUND FERRITE MOD.2643801502 |  | CE1285A0 | EMI ROUND FERRITE MOD.2643801502 | | | | | | | | | | | | | | | | | | | | | | | | | | | | | |
| LP1050A | BL SHOP.PRO L180 COMPLETE LED BA |  | KLP1050A | BAKERLUX SHOP.PRO L180 LED BAR KIT | <table border="1"> <thead> <tr> <th>Code</th> <th>Description</th> <th>Qty</th> <th>UOM</th> </tr> </thead> <tbody> <tr> <td>IP1385A1</td> <td>CORNER POLYSTYREN E PACKING 110X80X2000</td> <td>0.300</td> <td>M</td> </tr> <tr> <td>LP1050A0</td> <td>BL SHOP.PRO L180 COMPLETE LED BAR</td> <td>1</td> <td>PZ</td> </tr> <tr> <td>VI1014A0</td> <td>STAINLESS STEEL WASHER 4.5X9X0.8</td> <td>1</td> <td>PZ</td> </tr> <tr> <td>VI1220A1</td> <td>4,2X12 TCB SELF-TAPPING SCREW</td> <td>1</td> <td>PZ</td> </tr> <tr> <td>VM1059A1</td> <td>HEAT SHRINK FILM H800</td> <td>0.300</td> <td>M</td> </tr> </tbody> </table> | Code | Description | Qty | UOM | IP1385A1 | CORNER POLYSTYREN E PACKING 110X80X2000 | 0.300 | M | LP1050A0 | BL SHOP.PRO L180 COMPLETE LED BAR | 1 | PZ | VI1014A0 | STAINLESS STEEL WASHER 4.5X9X0.8 | 1 | PZ | VI1220A1 | 4,2X12 TCB SELF-TAPPING SCREW | 1 | PZ | VM1059A1 | HEAT SHRINK FILM H800 | 0.300 | M | | | | |
| Code | Description | Qty | UOM | | | | | | | | | | | | | | | | | | | | | | | | | | | | | | |
| IP1385A1 | CORNER POLYSTYREN E PACKING 110X80X2000 | 0.300 | M | | | | | | | | | | | | | | | | | | | | | | | | | | | | | | |
| LP1050A0 | BL SHOP.PRO L180 COMPLETE LED BAR | 1 | PZ | | | | | | | | | | | | | | | | | | | | | | | | | | | | | | |
| VI1014A0 | STAINLESS STEEL WASHER 4.5X9X0.8 | 1 | PZ | | | | | | | | | | | | | | | | | | | | | | | | | | | | | | |
| VI1220A1 | 4,2X12 TCB SELF-TAPPING SCREW | 1 | PZ | | | | | | | | | | | | | | | | | | | | | | | | | | | | | | |
| VM1059A1 | HEAT SHRINK FILM H800 | 0.300 | M | | | | | | | | | | | | | | | | | | | | | | | | | | | | | | |

| COMPONENT | | | SPARE PART | | | | | | | | | | | | | | | | | | | | | | | | | | | | | | |
|-----------|---|---|------------|--|---|------|-------------|-----|-----|----------|--|-------|----|----------|--|-------|----|----------|--|-------|----|----------|---|-------|----|----------|--------------------------------------|----|----|----------|--------------------------------------|---|----|
| Code | Description | Image | Code | Description | Components list | | | | | | | | | | | | | | | | | | | | | | | | | | | | |
| CE1095A | 4 POLES MICROFIT 2 M BUS CABLE |  | KCE1095A | 4POLES 2M BUS CABLE KIT POWER-CONTROL | <table border="1"> <thead> <tr> <th>Code</th> <th>Description</th> <th>Qty</th> <th>UOM</th> </tr> </thead> <tbody> <tr> <td>CE1095A0</td> <td>4 POLES MICROFIT 2 M BUS CABLE</td> <td>1</td> <td>PZ</td> </tr> <tr> <td>VM1224A0</td> <td>65MY 220MM 2 COLOURS SHRINK TUBE</td> <td>0.250</td> <td>M</td> </tr> </tbody> </table> | Code | Description | Qty | UOM | CE1095A0 | 4 POLES MICROFIT 2 M BUS CABLE | 1 | PZ | VM1224A0 | 65MY 220MM 2 COLOURS SHRINK TUBE | 0.250 | M | | | | | | | | | | | | | | | | |
| Code | Description | Qty | UOM | | | | | | | | | | | | | | | | | | | | | | | | | | | | | | |
| CE1095A0 | 4 POLES MICROFIT 2 M BUS CABLE | 1 | PZ | | | | | | | | | | | | | | | | | | | | | | | | | | | | | | |
| VM1224A0 | 65MY 220MM 2 COLOURS SHRINK TUBE | 0.250 | M | | | | | | | | | | | | | | | | | | | | | | | | | | | | | | |
| VM2479A | BL SP GLASS H6 PUSHING BRACKET |  | KVM2479A | BL SHOP.PRO H6 GLASS SUPPORT 6 PCS KIT | <table border="1"> <thead> <tr> <th>Code</th> <th>Description</th> <th>Qty</th> <th>UOM</th> </tr> </thead> <tbody> <tr> <td>VM1224A0</td> <td>65MY 220MM 2 COLOURS SHRINK TUBE</td> <td>0.200</td> <td>M</td> </tr> <tr> <td>VM1630A0</td> <td>INTERNAL GLASS PUSHING CAP</td> <td>6</td> <td>PZ</td> </tr> <tr> <td>VM1630A1</td> <td>INTERNAL GLASS PUSHING CAP</td> <td>6</td> <td>PZ</td> </tr> <tr> <td>VM2479A0</td> <td>BL SP GLASS H6 PUSHING BRACKET</td> <td>6</td> <td>PZ</td> </tr> <tr> <td>VM2479A0</td> <td>BL SP GLASS H6 PUSHING BRACKET</td> <td>6</td> <td>PZ</td> </tr> </tbody> </table> | Code | Description | Qty | UOM | VM1224A0 | 65MY 220MM 2 COLOURS SHRINK TUBE | 0.200 | M | VM1630A0 | INTERNAL GLASS PUSHING CAP | 6 | PZ | VM1630A1 | INTERNAL GLASS PUSHING CAP | 6 | PZ | VM2479A0 | BL SP GLASS H6 PUSHING BRACKET | 6 | PZ | VM2479A0 | BL SP GLASS H6 PUSHING BRACKET | 6 | PZ | | | | |
| Code | Description | Qty | UOM | | | | | | | | | | | | | | | | | | | | | | | | | | | | | | |
| VM1224A0 | 65MY 220MM 2 COLOURS SHRINK TUBE | 0.200 | M | | | | | | | | | | | | | | | | | | | | | | | | | | | | | | |
| VM1630A0 | INTERNAL GLASS PUSHING CAP | 6 | PZ | | | | | | | | | | | | | | | | | | | | | | | | | | | | | | |
| VM1630A1 | INTERNAL GLASS PUSHING CAP | 6 | PZ | | | | | | | | | | | | | | | | | | | | | | | | | | | | | | |
| VM2479A0 | BL SP GLASS H6 PUSHING BRACKET | 6 | PZ | | | | | | | | | | | | | | | | | | | | | | | | | | | | | | |
| VM2479A0 | BL SP GLASS H6 PUSHING BRACKET | 6 | PZ | | | | | | | | | | | | | | | | | | | | | | | | | | | | | | |
| VM1630A | INTERNAL GLASS PUSHING CAP |  | KVM1630A | CAP FOR INTERNAL GLASS 10 PCS KIT | <table border="1"> <thead> <tr> <th>Code</th> <th>Description</th> <th>Qty</th> <th>UOM</th> </tr> </thead> <tbody> <tr> <td>VM1224A0</td> <td>65MY 220MM 2 COLOURS SHRINK TUBE</td> <td>0.200</td> <td>M</td> </tr> <tr> <td>VM1630A0</td> <td>INTERNAL GLASS PUSHING CAP</td> <td>10</td> <td>PZ</td> </tr> <tr> <td>VM1630A1</td> <td>INTERNAL GLASS PUSHING CAP</td> <td>10</td> <td>PZ</td> </tr> </tbody> </table> | Code | Description | Qty | UOM | VM1224A0 | 65MY 220MM 2 COLOURS SHRINK TUBE | 0.200 | M | VM1630A0 | INTERNAL GLASS PUSHING CAP | 10 | PZ | VM1630A1 | INTERNAL GLASS PUSHING CAP | 10 | PZ | | | | | | | | | | | | |
| Code | Description | Qty | UOM | | | | | | | | | | | | | | | | | | | | | | | | | | | | | | |
| VM1224A0 | 65MY 220MM 2 COLOURS SHRINK TUBE | 0.200 | M | | | | | | | | | | | | | | | | | | | | | | | | | | | | | | |
| VM1630A0 | INTERNAL GLASS PUSHING CAP | 10 | PZ | | | | | | | | | | | | | | | | | | | | | | | | | | | | | | |
| VM1630A1 | INTERNAL GLASS PUSHING CAP | 10 | PZ | | | | | | | | | | | | | | | | | | | | | | | | | | | | | | |
| VT1325A | SP ELENA 557X364X4 EXTERNAL GLASS |  | KVT1325A | BL SHOP.PRO ELENA EXTERNAL GLASS KIT | <table border="1"> <thead> <tr> <th>Code</th> <th>Description</th> <th>Qty</th> <th>UOM</th> </tr> </thead> <tbody> <tr> <td>0B0386A0</td> <td></td> <td>2</td> <td>PZ</td> </tr> <tr> <td>ED1240A0</td> <td>TECHNICAL DATA LABEL</td> <td>1</td> <td>PZ</td> </tr> <tr> <td>IP1385A1</td> <td>CORNER POLYSTYREN E PACKING 110X80X2000</td> <td>1.200</td> <td>M</td> </tr> <tr> <td>IP1508A1</td> <td>POLYSTYREN E U SHAPED PROFILE 2000X60X60</td> <td>0.800</td> <td>M</td> </tr> <tr> <td>SL1155A1</td> <td>LOCTITE BICOMPONEN T SILICON</td> <td>14</td> <td>ML</td> </tr> <tr> <td>VH1220A1</td> <td>4,2X12 TCB SELF-TAPPIN G SCREW</td> <td>6</td> <td>PZ</td> </tr> </tbody> </table> | Code | Description | Qty | UOM | 0B0386A0 | | 2 | PZ | ED1240A0 | TECHNICAL DATA LABEL | 1 | PZ | IP1385A1 | CORNER POLYSTYREN E PACKING 110X80X2000 | 1.200 | M | IP1508A1 | POLYSTYREN E U SHAPED PROFILE 2000X60X60 | 0.800 | M | SL1155A1 | LOCTITE BICOMPONEN T SILICON | 14 | ML | VH1220A1 | 4,2X12 TCB SELF-TAPPIN G SCREW | 6 | PZ |
| Code | Description | Qty | UOM | | | | | | | | | | | | | | | | | | | | | | | | | | | | | | |
| 0B0386A0 | | 2 | PZ | | | | | | | | | | | | | | | | | | | | | | | | | | | | | | |
| ED1240A0 | TECHNICAL DATA LABEL | 1 | PZ | | | | | | | | | | | | | | | | | | | | | | | | | | | | | | |
| IP1385A1 | CORNER POLYSTYREN E PACKING 110X80X2000 | 1.200 | M | | | | | | | | | | | | | | | | | | | | | | | | | | | | | | |
| IP1508A1 | POLYSTYREN E U SHAPED PROFILE 2000X60X60 | 0.800 | M | | | | | | | | | | | | | | | | | | | | | | | | | | | | | | |
| SL1155A1 | LOCTITE BICOMPONEN T SILICON | 14 | ML | | | | | | | | | | | | | | | | | | | | | | | | | | | | | | |
| VH1220A1 | 4,2X12 TCB SELF-TAPPIN G SCREW | 6 | PZ | | | | | | | | | | | | | | | | | | | | | | | | | | | | | | |



| COMPONENT | | | SPARE PART | | | | | | | | | | | | | | | | | | | | | | | | | | | | | | | | | | | | | | | | | | | | | | | | | | | | | | | | | | | | | | | |
|-----------|--|---|------------|--|---|------|-------------|-----|-----|----------|--------------------------|-------|---|----------|--|---|----|----------|--|---|----|----|----------|---|---|----|----------|-------------------------|---|----|----------|---------------------------------------|-------|----|----------|--|-------|---|----------|---|-------|---|----------|---|---|----|----------|------------------------------------|----|----|----------|-------------------------------|---|----|----------|---|---|----|----------|--|---|----|----------|--------------------------------------|----|----|
| Code | Description | Image | Code | Description | Components list | | | | | | | | | | | | | | | | | | | | | | | | | | | | | | | | | | | | | | | | | | | | | | | | | | | | | | | | | | | | | |
| VT1325A | SP ELENA 557X364X4 EXTERNAL GLASS |  | KVT1325A | BL SHOP.PRO ELENA EXTERNAL GLASS KIT | <table border="1"> <thead> <tr> <th>Code</th> <th>Description</th> <th>Qty</th> <th>UOM</th> </tr> </thead> <tbody> <tr> <td>VM1059A1</td> <td>HEAT SHRINK FILM H800</td> <td>1.200</td> <td>M</td> </tr> <tr> <td>VT1325A0</td> <td>SP ELENA 557X364X4 EXTERNAL GLASS</td> <td>1</td> <td>PZ</td> </tr> <tr> <td>VT1325A0</td> <td>SP ELENA 557X364X4 EXTERNAL GLASS</td> <td>1</td> <td>PZ</td> </tr> </tbody> </table> | Code | Description | Qty | UOM | VM1059A1 | HEAT SHRINK FILM H800 | 1.200 | M | VT1325A0 | SP ELENA 557X364X4 EXTERNAL GLASS | 1 | PZ | VT1325A0 | SP ELENA 557X364X4 EXTERNAL GLASS | 1 | PZ | | | | | | | | | | | | | | | | | | | | | | | | | | | | | | | | | | | | | | | | | | | | | |
| | | | Code | Description | Qty | UOM | | | | | | | | | | | | | | | | | | | | | | | | | | | | | | | | | | | | | | | | | | | | | | | | | | | | | | | | | | | | |
| VM1059A1 | HEAT SHRINK FILM H800 | 1.200 | M | | | | | | | | | | | | | | | | | | | | | | | | | | | | | | | | | | | | | | | | | | | | | | | | | | | | | | | | | | | | | | | |
| VT1325A0 | SP ELENA 557X364X4 EXTERNAL GLASS | 1 | PZ | | | | | | | | | | | | | | | | | | | | | | | | | | | | | | | | | | | | | | | | | | | | | | | | | | | | | | | | | | | | | | | |
| VT1325A0 | SP ELENA 557X364X4 EXTERNAL GLASS | 1 | PZ | | | | | | | | | | | | | | | | | | | | | | | | | | | | | | | | | | | | | | | | | | | | | | | | | | | | | | | | | | | | | | | |
| KDR1289A | BL SHOP.PRO ELENA EXTERNAL LEFT DOOR KIT | <table border="1"> <thead> <tr> <th>Code</th> <th>Description</th> <th>Qty</th> <th>UOM</th> </tr> </thead> <tbody> <tr> <td>0B1293A0</td> <td></td> <td>1</td> <td>PZ</td> </tr> <tr> <td>0B1294A0</td> <td></td> <td>1</td> <td>PZ</td> </tr> <tr> <td>0B1295B0</td> <td></td> <td>1</td> <td>PZ</td> </tr> <tr> <td>0B1296B0</td> <td></td> <td>1</td> <td>PZ</td> </tr> <tr> <td>CR1040A0</td> <td>DOOR LATCH FOR EL.MECH. LOCKING SYSTEM</td> <td>1</td> <td>PZ</td> </tr> <tr> <td>ED1240A0</td> <td>TECHNICAL DATA LABEL</td> <td>1</td> <td>PZ</td> </tr> <tr> <td>IP1325B0</td> <td>POLYSTYREN E CORNER PACKING D20</td> <td>0.650</td> <td>PZ</td> </tr> <tr> <td>IP1385A1</td> <td>CORNER POLYSTYREN E PACKING 110X80X2000</td> <td>0.400</td> <td>M</td> </tr> <tr> <td>IP1508A1</td> <td>POLYSTYREN E U SHAPED PROFILE 2000X60X60</td> <td>1.200</td> <td>M</td> </tr> <tr> <td>ML1005A0</td> <td>DES DF0.6 H18 COMPRESSIO N SPRING</td> <td>2</td> <td>PZ</td> </tr> <tr> <td>SL1155A1</td> <td>LOCTITE BICOMPONEN T SILICON</td> <td>14</td> <td>ML</td> </tr> <tr> <td>TB1563A0</td> <td>DOOR LATERAL BEAM SP800</td> <td>2</td> <td>PZ</td> </tr> <tr> <td>TB3303A0</td> <td>SHOP.PRO STE-ELE FLAG DOOR HANDLE TUBE</td> <td>1</td> <td>PZ</td> </tr> <tr> <td>VI1036A0</td> <td>ST STEEL STRIPED THREAD INSERT M10 FTT/C</td> <td>1</td> <td>PZ</td> </tr> <tr> <td>VI1220A1</td> <td>4,2X12 TCB SELF-TAPPIN G SCREW</td> <td>12</td> <td>PZ</td> </tr> </tbody> </table> | Code | Description | Qty | UOM | 0B1293A0 | | 1 | PZ | 0B1294A0 | | 1 | PZ | 0B1295B0 | | 1 | PZ | 0B1296B0 | | 1 | PZ | CR1040A0 | DOOR LATCH FOR EL.MECH. LOCKING SYSTEM | 1 | PZ | ED1240A0 | TECHNICAL DATA LABEL | 1 | PZ | IP1325B0 | POLYSTYREN E CORNER PACKING D20 | 0.650 | PZ | IP1385A1 | CORNER POLYSTYREN E PACKING 110X80X2000 | 0.400 | M | IP1508A1 | POLYSTYREN E U SHAPED PROFILE 2000X60X60 | 1.200 | M | ML1005A0 | DES DF0.6 H18 COMPRESSIO N SPRING | 2 | PZ | SL1155A1 | LOCTITE BICOMPONEN T SILICON | 14 | ML | TB1563A0 | DOOR LATERAL BEAM SP800 | 2 | PZ | TB3303A0 | SHOP.PRO STE-ELE FLAG DOOR HANDLE TUBE | 1 | PZ | VI1036A0 | ST STEEL STRIPED THREAD INSERT M10 FTT/C | 1 | PZ | VI1220A1 | 4,2X12 TCB SELF-TAPPIN G SCREW | 12 | PZ |
| Code | Description | Qty | UOM | | | | | | | | | | | | | | | | | | | | | | | | | | | | | | | | | | | | | | | | | | | | | | | | | | | | | | | | | | | | | | | |
| 0B1293A0 | | 1 | PZ | | | | | | | | | | | | | | | | | | | | | | | | | | | | | | | | | | | | | | | | | | | | | | | | | | | | | | | | | | | | | | | |
| 0B1294A0 | | 1 | PZ | | | | | | | | | | | | | | | | | | | | | | | | | | | | | | | | | | | | | | | | | | | | | | | | | | | | | | | | | | | | | | | |
| 0B1295B0 | | 1 | PZ | | | | | | | | | | | | | | | | | | | | | | | | | | | | | | | | | | | | | | | | | | | | | | | | | | | | | | | | | | | | | | | |
| 0B1296B0 | | 1 | PZ | | | | | | | | | | | | | | | | | | | | | | | | | | | | | | | | | | | | | | | | | | | | | | | | | | | | | | | | | | | | | | | |
| CR1040A0 | DOOR LATCH FOR EL.MECH. LOCKING SYSTEM | 1 | PZ | | | | | | | | | | | | | | | | | | | | | | | | | | | | | | | | | | | | | | | | | | | | | | | | | | | | | | | | | | | | | | | |
| ED1240A0 | TECHNICAL DATA LABEL | 1 | PZ | | | | | | | | | | | | | | | | | | | | | | | | | | | | | | | | | | | | | | | | | | | | | | | | | | | | | | | | | | | | | | | |
| IP1325B0 | POLYSTYREN E CORNER PACKING D20 | 0.650 | PZ | | | | | | | | | | | | | | | | | | | | | | | | | | | | | | | | | | | | | | | | | | | | | | | | | | | | | | | | | | | | | | | |
| IP1385A1 | CORNER POLYSTYREN E PACKING 110X80X2000 | 0.400 | M | | | | | | | | | | | | | | | | | | | | | | | | | | | | | | | | | | | | | | | | | | | | | | | | | | | | | | | | | | | | | | | |
| IP1508A1 | POLYSTYREN E U SHAPED PROFILE 2000X60X60 | 1.200 | M | | | | | | | | | | | | | | | | | | | | | | | | | | | | | | | | | | | | | | | | | | | | | | | | | | | | | | | | | | | | | | | |
| ML1005A0 | DES DF0.6 H18 COMPRESSIO N SPRING | 2 | PZ | | | | | | | | | | | | | | | | | | | | | | | | | | | | | | | | | | | | | | | | | | | | | | | | | | | | | | | | | | | | | | | |
| SL1155A1 | LOCTITE BICOMPONEN T SILICON | 14 | ML | | | | | | | | | | | | | | | | | | | | | | | | | | | | | | | | | | | | | | | | | | | | | | | | | | | | | | | | | | | | | | | |
| TB1563A0 | DOOR LATERAL BEAM SP800 | 2 | PZ | | | | | | | | | | | | | | | | | | | | | | | | | | | | | | | | | | | | | | | | | | | | | | | | | | | | | | | | | | | | | | | |
| TB3303A0 | SHOP.PRO STE-ELE FLAG DOOR HANDLE TUBE | 1 | PZ | | | | | | | | | | | | | | | | | | | | | | | | | | | | | | | | | | | | | | | | | | | | | | | | | | | | | | | | | | | | | | | |
| VI1036A0 | ST STEEL STRIPED THREAD INSERT M10 FTT/C | 1 | PZ | | | | | | | | | | | | | | | | | | | | | | | | | | | | | | | | | | | | | | | | | | | | | | | | | | | | | | | | | | | | | | | |
| VI1220A1 | 4,2X12 TCB SELF-TAPPIN G SCREW | 12 | PZ | | | | | | | | | | | | | | | | | | | | | | | | | | | | | | | | | | | | | | | | | | | | | | | | | | | | | | | | | | | | | | | |



| COMPONENT | | | SPARE PART | | | | | | | | | | | | | | | | | | | | | | | | | | | | | | | | | | | | | | | | | | | | | | | | | | | | | | | | | | | | | | | | | | | | | | |
|-----------|---|---|------------|--|--|------|-------------|-----|-----|----------|---------------------------------|----|----|----------|----------------------------------|---|----|----------|--------------------------|-------|---|----------|--------------------------------|---|----|----------|----------------------------------|---|----|----------|----------------------------------|---|----|----------|--------------------|---|----|----------|-------------------|---|----|----------|------------------------------------|---|----|----------|------------------------------------|---|----|----------|---|---|----|----------|---|---|----|----------|--|---|----|----------|--|---|----|----------|---|---|----|----------|---|---|----|
| Code | Description | Image | Code | Description | Components list | | | | | | | | | | | | | | | | | | | | | | | | | | | | | | | | | | | | | | | | | | | | | | | | | | | | | | | | | | | | | | | | | | | | |
| VT1325A | SP ELENA 557X364X4 EXTERNAL GLASS |  | KDR1289A | BL SHOP.PRO ELENA EXTERNAL LEFT DOOR KIT | <table border="1"> <thead> <tr> <th>Code</th> <th>Description</th> <th>Qty</th> <th>UOM</th> </tr> </thead> <tbody> <tr> <td>VI1930A0</td> <td>5X25 ST. STEEL SCREW CHIP</td> <td>22</td> <td>PZ</td> </tr> <tr> <td>VI1998A0</td> <td>ZINC PLATED SCREW 5X30 TCB</td> <td>2</td> <td>PZ</td> </tr> <tr> <td>VM1059A1</td> <td>HEAT SHRINK FILM H800</td> <td>1.200</td> <td>M</td> </tr> <tr> <td>VM1209A0</td> <td>SHOP.PRO LOCK PIN WASHER</td> <td>1</td> <td>PZ</td> </tr> <tr> <td>VM1630A0</td> <td>INTERNAL GLASS PUSHING CAP</td> <td>4</td> <td>PZ</td> </tr> <tr> <td>VM1630A1</td> <td>INTERNAL GLASS PUSHING CAP</td> <td>4</td> <td>PZ</td> </tr> <tr> <td>VM2274A0</td> <td>GROOVED BUSHING</td> <td>1</td> <td>PZ</td> </tr> <tr> <td>VM2275A0</td> <td>SMOOTH BUSHING</td> <td>1</td> <td>PZ</td> </tr> <tr> <td>VM2456A0</td> <td>BAKERLUX SHOP.PRO HANDLE END</td> <td>2</td> <td>PZ</td> </tr> <tr> <td>VM2456A0</td> <td>BAKERLUX SHOP.PRO HANDLE END</td> <td>2</td> <td>PZ</td> </tr> <tr> <td>VM2465A0</td> <td>SP SIDE-OPENIN G DOOR RIGHT LOWER CAP KIT</td> <td>1</td> <td>PZ</td> </tr> <tr> <td>VM2465A0</td> <td>SP SIDE-OPENIN G DOOR RIGHT LOWER CAP KIT</td> <td>1</td> <td>PZ</td> </tr> <tr> <td>VM2466A0</td> <td>BL SP LEFT LOWER LATERAL DOOR CAP</td> <td>1</td> <td>PZ</td> </tr> <tr> <td>VM2466A0</td> <td>BL SP LEFT LOWER LATERAL DOOR CAP</td> <td>1</td> <td>PZ</td> </tr> <tr> <td>VM2467A0</td> <td>SP SIDE-OPENIN G DOOR RIGHT UPPER CAP KIT</td> <td>1</td> <td>PZ</td> </tr> <tr> <td>VM2467A0</td> <td>SP SIDE-OPENIN G DOOR RIGHT UPPER CAP KIT</td> <td>1</td> <td>PZ</td> </tr> </tbody> </table> | Code | Description | Qty | UOM | VI1930A0 | 5X25 ST. STEEL SCREW CHIP | 22 | PZ | VI1998A0 | ZINC PLATED SCREW 5X30 TCB | 2 | PZ | VM1059A1 | HEAT SHRINK FILM H800 | 1.200 | M | VM1209A0 | SHOP.PRO LOCK PIN WASHER | 1 | PZ | VM1630A0 | INTERNAL GLASS PUSHING CAP | 4 | PZ | VM1630A1 | INTERNAL GLASS PUSHING CAP | 4 | PZ | VM2274A0 | GROOVED BUSHING | 1 | PZ | VM2275A0 | SMOOTH BUSHING | 1 | PZ | VM2456A0 | BAKERLUX SHOP.PRO HANDLE END | 2 | PZ | VM2456A0 | BAKERLUX SHOP.PRO HANDLE END | 2 | PZ | VM2465A0 | SP SIDE-OPENIN G DOOR RIGHT LOWER CAP KIT | 1 | PZ | VM2465A0 | SP SIDE-OPENIN G DOOR RIGHT LOWER CAP KIT | 1 | PZ | VM2466A0 | BL SP LEFT LOWER LATERAL DOOR CAP | 1 | PZ | VM2466A0 | BL SP LEFT LOWER LATERAL DOOR CAP | 1 | PZ | VM2467A0 | SP SIDE-OPENIN G DOOR RIGHT UPPER CAP KIT | 1 | PZ | VM2467A0 | SP SIDE-OPENIN G DOOR RIGHT UPPER CAP KIT | 1 | PZ |
| Code | Description | Qty | UOM | | | | | | | | | | | | | | | | | | | | | | | | | | | | | | | | | | | | | | | | | | | | | | | | | | | | | | | | | | | | | | | | | | | | | | |
| VI1930A0 | 5X25 ST. STEEL SCREW CHIP | 22 | PZ | | | | | | | | | | | | | | | | | | | | | | | | | | | | | | | | | | | | | | | | | | | | | | | | | | | | | | | | | | | | | | | | | | | | | | |
| VI1998A0 | ZINC PLATED SCREW 5X30 TCB | 2 | PZ | | | | | | | | | | | | | | | | | | | | | | | | | | | | | | | | | | | | | | | | | | | | | | | | | | | | | | | | | | | | | | | | | | | | | | |
| VM1059A1 | HEAT SHRINK FILM H800 | 1.200 | M | | | | | | | | | | | | | | | | | | | | | | | | | | | | | | | | | | | | | | | | | | | | | | | | | | | | | | | | | | | | | | | | | | | | | | |
| VM1209A0 | SHOP.PRO LOCK PIN WASHER | 1 | PZ | | | | | | | | | | | | | | | | | | | | | | | | | | | | | | | | | | | | | | | | | | | | | | | | | | | | | | | | | | | | | | | | | | | | | | |
| VM1630A0 | INTERNAL GLASS PUSHING CAP | 4 | PZ | | | | | | | | | | | | | | | | | | | | | | | | | | | | | | | | | | | | | | | | | | | | | | | | | | | | | | | | | | | | | | | | | | | | | | |
| VM1630A1 | INTERNAL GLASS PUSHING CAP | 4 | PZ | | | | | | | | | | | | | | | | | | | | | | | | | | | | | | | | | | | | | | | | | | | | | | | | | | | | | | | | | | | | | | | | | | | | | | |
| VM2274A0 | GROOVED BUSHING | 1 | PZ | | | | | | | | | | | | | | | | | | | | | | | | | | | | | | | | | | | | | | | | | | | | | | | | | | | | | | | | | | | | | | | | | | | | | | |
| VM2275A0 | SMOOTH BUSHING | 1 | PZ | | | | | | | | | | | | | | | | | | | | | | | | | | | | | | | | | | | | | | | | | | | | | | | | | | | | | | | | | | | | | | | | | | | | | | |
| VM2456A0 | BAKERLUX SHOP.PRO HANDLE END | 2 | PZ | | | | | | | | | | | | | | | | | | | | | | | | | | | | | | | | | | | | | | | | | | | | | | | | | | | | | | | | | | | | | | | | | | | | | | |
| VM2456A0 | BAKERLUX SHOP.PRO HANDLE END | 2 | PZ | | | | | | | | | | | | | | | | | | | | | | | | | | | | | | | | | | | | | | | | | | | | | | | | | | | | | | | | | | | | | | | | | | | | | | |
| VM2465A0 | SP SIDE-OPENIN G DOOR RIGHT LOWER CAP KIT | 1 | PZ | | | | | | | | | | | | | | | | | | | | | | | | | | | | | | | | | | | | | | | | | | | | | | | | | | | | | | | | | | | | | | | | | | | | | | |
| VM2465A0 | SP SIDE-OPENIN G DOOR RIGHT LOWER CAP KIT | 1 | PZ | | | | | | | | | | | | | | | | | | | | | | | | | | | | | | | | | | | | | | | | | | | | | | | | | | | | | | | | | | | | | | | | | | | | | | |
| VM2466A0 | BL SP LEFT LOWER LATERAL DOOR CAP | 1 | PZ | | | | | | | | | | | | | | | | | | | | | | | | | | | | | | | | | | | | | | | | | | | | | | | | | | | | | | | | | | | | | | | | | | | | | | |
| VM2466A0 | BL SP LEFT LOWER LATERAL DOOR CAP | 1 | PZ | | | | | | | | | | | | | | | | | | | | | | | | | | | | | | | | | | | | | | | | | | | | | | | | | | | | | | | | | | | | | | | | | | | | | | |
| VM2467A0 | SP SIDE-OPENIN G DOOR RIGHT UPPER CAP KIT | 1 | PZ | | | | | | | | | | | | | | | | | | | | | | | | | | | | | | | | | | | | | | | | | | | | | | | | | | | | | | | | | | | | | | | | | | | | | | |
| VM2467A0 | SP SIDE-OPENIN G DOOR RIGHT UPPER CAP KIT | 1 | PZ | | | | | | | | | | | | | | | | | | | | | | | | | | | | | | | | | | | | | | | | | | | | | | | | | | | | | | | | | | | | | | | | | | | | | | |



| COMPONENT | | | SPARE PART | | | | | | | | | | | | | | | | | | | | | | | | | | | | | | | | | | | | | | | | | | | | | | | | | | | | | | | | | | | | | | |
|-----------|--|---|------------|--|---|------|-------------|-----|-----|----------|--|---|----|----------|--|---|----|----------|---|---|----|----------|---|---|----|----------|--|---|----|----------|--|---|----|----------|--|---|----|----------|--|---|----|----------|---|---|----|----------|---|---|----|----------|---|---|----|----------|---|---|----|----------|--------------------------------------|---|----|----------|--------------------------------------|---|----|
| Code | Description | Image | Code | Description | Components list | | | | | | | | | | | | | | | | | | | | | | | | | | | | | | | | | | | | | | | | | | | | | | | | | | | | | | | | | | | | |
| VT1325A | SP ELENA 557X364X4 EXTERNAL GLASS |  | KDR1289A | BL SHOP.PRO ELENA EXTERNAL LEFT DOOR KIT | <table border="1"> <thead> <tr> <th>Code</th> <th>Description</th> <th>Qty</th> <th>UOM</th> </tr> </thead> <tbody> <tr> <td>VM2468A0</td> <td>BL SP LEFT UPPER LATERAL DOOR CAP</td> <td>1</td> <td>PZ</td> </tr> <tr> <td>VM2468A0</td> <td>BL SP LEFT UPPER LATERAL DOOR CAP</td> <td>1</td> <td>PZ</td> </tr> <tr> <td>VM2470A0</td> <td>SLIDE TO FIX INTERNAL GLASS SHOP.PRO</td> <td>2</td> <td>PZ</td> </tr> <tr> <td>VM2470A0</td> <td>SLIDE TO FIX INTERNAL GLASS SHOP.PRO</td> <td>2</td> <td>PZ</td> </tr> <tr> <td>VM2471A0</td> <td>BL SP LOWER CLAMP INT LOCK GLASS SLIDER</td> <td>1</td> <td>PZ</td> </tr> <tr> <td>VM2471A0</td> <td>BL SP LOWER CLAMP INT LOCK GLASS SLIDER</td> <td>1</td> <td>PZ</td> </tr> <tr> <td>VM2472A0</td> <td>BL SP UPPER CLAMP INT LOCK GLASS SLIDER</td> <td>1</td> <td>PZ</td> </tr> <tr> <td>VM2472A0</td> <td>BL SP UPPER CLAMP INT LOCK GLASS SLIDER</td> <td>1</td> <td>PZ</td> </tr> <tr> <td>VM2473A0</td> <td>BL SP INT GLASS HINGE LOWER LOCK PIN</td> <td>1</td> <td>PZ</td> </tr> <tr> <td>VM2473A0</td> <td>BL SP INT GLASS HINGE LOWER LOCK PIN</td> <td>1</td> <td>PZ</td> </tr> <tr> <td>VM2474A0</td> <td>BL SP INT GLASS HINGE UPPER LOCK PIN</td> <td>1</td> <td>PZ</td> </tr> <tr> <td>VM2474A0</td> <td>BL SP INT GLASS HINGE UPPER LOCK PIN</td> <td>1</td> <td>PZ</td> </tr> <tr> <td>VM2479A0</td> <td>BL SP GLASS H6 PUSHING BRACKET</td> <td>4</td> <td>PZ</td> </tr> <tr> <td>VM2479A0</td> <td>BL SP GLASS H6 PUSHING BRACKET</td> <td>4</td> <td>PZ</td> </tr> </tbody> </table> | Code | Description | Qty | UOM | VM2468A0 | BL SP LEFT UPPER LATERAL DOOR CAP | 1 | PZ | VM2468A0 | BL SP LEFT UPPER LATERAL DOOR CAP | 1 | PZ | VM2470A0 | SLIDE TO FIX INTERNAL GLASS SHOP.PRO | 2 | PZ | VM2470A0 | SLIDE TO FIX INTERNAL GLASS SHOP.PRO | 2 | PZ | VM2471A0 | BL SP LOWER CLAMP INT LOCK GLASS SLIDER | 1 | PZ | VM2471A0 | BL SP LOWER CLAMP INT LOCK GLASS SLIDER | 1 | PZ | VM2472A0 | BL SP UPPER CLAMP INT LOCK GLASS SLIDER | 1 | PZ | VM2472A0 | BL SP UPPER CLAMP INT LOCK GLASS SLIDER | 1 | PZ | VM2473A0 | BL SP INT GLASS HINGE LOWER LOCK PIN | 1 | PZ | VM2473A0 | BL SP INT GLASS HINGE LOWER LOCK PIN | 1 | PZ | VM2474A0 | BL SP INT GLASS HINGE UPPER LOCK PIN | 1 | PZ | VM2474A0 | BL SP INT GLASS HINGE UPPER LOCK PIN | 1 | PZ | VM2479A0 | BL SP GLASS H6 PUSHING BRACKET | 4 | PZ | VM2479A0 | BL SP GLASS H6 PUSHING BRACKET | 4 | PZ |
| Code | Description | Qty | UOM | | | | | | | | | | | | | | | | | | | | | | | | | | | | | | | | | | | | | | | | | | | | | | | | | | | | | | | | | | | | | | |
| VM2468A0 | BL SP LEFT UPPER LATERAL DOOR CAP | 1 | PZ | | | | | | | | | | | | | | | | | | | | | | | | | | | | | | | | | | | | | | | | | | | | | | | | | | | | | | | | | | | | | | |
| VM2468A0 | BL SP LEFT UPPER LATERAL DOOR CAP | 1 | PZ | | | | | | | | | | | | | | | | | | | | | | | | | | | | | | | | | | | | | | | | | | | | | | | | | | | | | | | | | | | | | | |
| VM2470A0 | SLIDE TO FIX INTERNAL GLASS SHOP.PRO | 2 | PZ | | | | | | | | | | | | | | | | | | | | | | | | | | | | | | | | | | | | | | | | | | | | | | | | | | | | | | | | | | | | | | |
| VM2470A0 | SLIDE TO FIX INTERNAL GLASS SHOP.PRO | 2 | PZ | | | | | | | | | | | | | | | | | | | | | | | | | | | | | | | | | | | | | | | | | | | | | | | | | | | | | | | | | | | | | | |
| VM2471A0 | BL SP LOWER CLAMP INT LOCK GLASS SLIDER | 1 | PZ | | | | | | | | | | | | | | | | | | | | | | | | | | | | | | | | | | | | | | | | | | | | | | | | | | | | | | | | | | | | | | |
| VM2471A0 | BL SP LOWER CLAMP INT LOCK GLASS SLIDER | 1 | PZ | | | | | | | | | | | | | | | | | | | | | | | | | | | | | | | | | | | | | | | | | | | | | | | | | | | | | | | | | | | | | | |
| VM2472A0 | BL SP UPPER CLAMP INT LOCK GLASS SLIDER | 1 | PZ | | | | | | | | | | | | | | | | | | | | | | | | | | | | | | | | | | | | | | | | | | | | | | | | | | | | | | | | | | | | | | |
| VM2472A0 | BL SP UPPER CLAMP INT LOCK GLASS SLIDER | 1 | PZ | | | | | | | | | | | | | | | | | | | | | | | | | | | | | | | | | | | | | | | | | | | | | | | | | | | | | | | | | | | | | | |
| VM2473A0 | BL SP INT GLASS HINGE LOWER LOCK PIN | 1 | PZ | | | | | | | | | | | | | | | | | | | | | | | | | | | | | | | | | | | | | | | | | | | | | | | | | | | | | | | | | | | | | | |
| VM2473A0 | BL SP INT GLASS HINGE LOWER LOCK PIN | 1 | PZ | | | | | | | | | | | | | | | | | | | | | | | | | | | | | | | | | | | | | | | | | | | | | | | | | | | | | | | | | | | | | | |
| VM2474A0 | BL SP INT GLASS HINGE UPPER LOCK PIN | 1 | PZ | | | | | | | | | | | | | | | | | | | | | | | | | | | | | | | | | | | | | | | | | | | | | | | | | | | | | | | | | | | | | | |
| VM2474A0 | BL SP INT GLASS HINGE UPPER LOCK PIN | 1 | PZ | | | | | | | | | | | | | | | | | | | | | | | | | | | | | | | | | | | | | | | | | | | | | | | | | | | | | | | | | | | | | | |
| VM2479A0 | BL SP GLASS H6 PUSHING BRACKET | 4 | PZ | | | | | | | | | | | | | | | | | | | | | | | | | | | | | | | | | | | | | | | | | | | | | | | | | | | | | | | | | | | | | | |
| VM2479A0 | BL SP GLASS H6 PUSHING BRACKET | 4 | PZ | | | | | | | | | | | | | | | | | | | | | | | | | | | | | | | | | | | | | | | | | | | | | | | | | | | | | | | | | | | | | | |



| COMPONENT | | | SPARE PART | | | | | | | | | | | | | | | | | | | | | | | | | | | | | | | | | | | | | | | | | | | | | | | | | | | |
|-----------|---|--|------------|--|--|------|-------------|-----|-----|----------|--------------------------------------|---|----|----------|---|---|----|----------|---|---|----|----------|----------------------|---|----|----------|--|-------------------------|----|----------|--|---------------------------------------|-------|----|----------|--|-------|---|----------|---|-------|---|----------|---|---|----|----------|------------------------------------|----|----|----------|-------------------------------|---|----|
| Code | Description | Image | Code | Description | Components list | | | | | | | | | | | | | | | | | | | | | | | | | | | | | | | | | | | | | | | | | | | | | | | | | |
| VT1325A | SP ELENA 557X364X4 EXTERNAL GLASS |  | KDR1289A | BL SHOP.PRO ELENA EXTERNAL LEFT DOOR KIT | <table border="1"> <thead> <tr> <th>Code</th> <th>Description</th> <th>Qty</th> <th>UOM</th> </tr> </thead> <tbody> <tr> <td>VM2489A0</td> <td>SP HANDLE END KIT + STYLUS KIT</td> <td>1</td> <td>PZ</td> </tr> <tr> <td>VM2504A0</td> <td>DOWEL TO GUIDE SLIDE SPRING SHOP.PRO</td> <td>2</td> <td>PZ</td> </tr> <tr> <td>VM2504A0</td> <td>DOWEL TO GUIDE SLIDE SPRING SHOP.PRO</td> <td>2</td> <td>PZ</td> </tr> <tr> <td>VM2527A0</td> <td>STYLUS PEN FOR SP</td> <td>1</td> <td>PZ</td> </tr> <tr> <td>VT1325A0</td> <td>SP ELENA 557X364X4 EXTERNAL GLASS</td> <td>1</td> <td>PZ</td> </tr> <tr> <td>VT1325A0</td> <td>SP ELENA 557X364X4 EXTERNAL GLASS</td> <td>1</td> <td>PZ</td> </tr> </tbody> </table> | Code | Description | Qty | UOM | VM2489A0 | SP HANDLE END KIT + STYLUS KIT | 1 | PZ | VM2504A0 | DOWEL TO GUIDE SLIDE SPRING SHOP.PRO | 2 | PZ | VM2504A0 | DOWEL TO GUIDE SLIDE SPRING SHOP.PRO | 2 | PZ | VM2527A0 | STYLUS PEN FOR SP | 1 | PZ | VT1325A0 | SP ELENA 557X364X4 EXTERNAL GLASS | 1 | PZ | VT1325A0 | SP ELENA 557X364X4 EXTERNAL GLASS | 1 | PZ | | | | | | | | | | | | | | | | | | | | | |
| | | | Code | Description | Qty | UOM | | | | | | | | | | | | | | | | | | | | | | | | | | | | | | | | | | | | | | | | | | | | | | | | |
| VM2489A0 | SP HANDLE END KIT + STYLUS KIT | 1 | PZ | | | | | | | | | | | | | | | | | | | | | | | | | | | | | | | | | | | | | | | | | | | | | | | | | | | |
| VM2504A0 | DOWEL TO GUIDE SLIDE SPRING SHOP.PRO | 2 | PZ | | | | | | | | | | | | | | | | | | | | | | | | | | | | | | | | | | | | | | | | | | | | | | | | | | | |
| VM2504A0 | DOWEL TO GUIDE SLIDE SPRING SHOP.PRO | 2 | PZ | | | | | | | | | | | | | | | | | | | | | | | | | | | | | | | | | | | | | | | | | | | | | | | | | | | |
| VM2527A0 | STYLUS PEN FOR SP | 1 | PZ | | | | | | | | | | | | | | | | | | | | | | | | | | | | | | | | | | | | | | | | | | | | | | | | | | | |
| VT1325A0 | SP ELENA 557X364X4 EXTERNAL GLASS | 1 | PZ | | | | | | | | | | | | | | | | | | | | | | | | | | | | | | | | | | | | | | | | | | | | | | | | | | | |
| VT1325A0 | SP ELENA 557X364X4 EXTERNAL GLASS | 1 | PZ | | | | | | | | | | | | | | | | | | | | | | | | | | | | | | | | | | | | | | | | | | | | | | | | | | | |
| KDR1288A | BL SHOP.PRO ELENA EXTERNAL DOOR KIT | <table border="1"> <thead> <tr> <th>Code</th> <th>Description</th> <th>Qty</th> <th>UOM</th> </tr> </thead> <tbody> <tr> <td>0B1293A0</td> <td></td> <td>1</td> <td>PZ</td> </tr> <tr> <td>0B1294A0</td> <td></td> <td>1</td> <td>PZ</td> </tr> <tr> <td>0B1295B0</td> <td></td> <td>1</td> <td>PZ</td> </tr> <tr> <td>0B1296B0</td> <td></td> <td>1</td> <td>PZ</td> </tr> <tr> <td>CR1040A0</td> <td>DOOR LATCH FOR EL.MECH. LOCKING SYSTEM</td> <td>1</td> <td>PZ</td> </tr> <tr> <td>ED1240A0</td> <td>TECHNICAL DATA LABEL</td> <td>1</td> <td>PZ</td> </tr> <tr> <td>IP1325B0</td> <td>POLYSTYREN E CORNER PACKING D20</td> <td>0.650</td> <td>PZ</td> </tr> <tr> <td>IP1385A1</td> <td>CORNER POLYSTYREN E PACKING 110X80X2000</td> <td>0.400</td> <td>M</td> </tr> <tr> <td>IP1508A1</td> <td>POLYSTYREN E U SHAPED PROFILE 2000X60X60</td> <td>1.200</td> <td>M</td> </tr> <tr> <td>ML1005A0</td> <td>DE5 DF0.6 H18 COMPRESSIO N SPRING</td> <td>2</td> <td>PZ</td> </tr> <tr> <td>SL1155A1</td> <td>LOCTITE BICOMPONEN T SILICON</td> <td>14</td> <td>ML</td> </tr> <tr> <td>TB1563A0</td> <td>DOOR LATERAL BEAM SP800</td> <td>2</td> <td>PZ</td> </tr> </tbody> </table> | Code | Description | Qty | UOM | 0B1293A0 | | 1 | PZ | 0B1294A0 | | 1 | PZ | 0B1295B0 | | 1 | PZ | 0B1296B0 | | 1 | PZ | CR1040A0 | DOOR LATCH FOR EL.MECH. LOCKING SYSTEM | 1 | PZ | ED1240A0 | TECHNICAL DATA LABEL | 1 | PZ | IP1325B0 | POLYSTYREN E CORNER PACKING D20 | 0.650 | PZ | IP1385A1 | CORNER POLYSTYREN E PACKING 110X80X2000 | 0.400 | M | IP1508A1 | POLYSTYREN E U SHAPED PROFILE 2000X60X60 | 1.200 | M | ML1005A0 | DE5 DF0.6 H18 COMPRESSIO N SPRING | 2 | PZ | SL1155A1 | LOCTITE BICOMPONEN T SILICON | 14 | ML | TB1563A0 | DOOR LATERAL BEAM SP800 | 2 | PZ |
| Code | Description | Qty | UOM | | | | | | | | | | | | | | | | | | | | | | | | | | | | | | | | | | | | | | | | | | | | | | | | | | | |
| 0B1293A0 | | 1 | PZ | | | | | | | | | | | | | | | | | | | | | | | | | | | | | | | | | | | | | | | | | | | | | | | | | | | |
| 0B1294A0 | | 1 | PZ | | | | | | | | | | | | | | | | | | | | | | | | | | | | | | | | | | | | | | | | | | | | | | | | | | | |
| 0B1295B0 | | 1 | PZ | | | | | | | | | | | | | | | | | | | | | | | | | | | | | | | | | | | | | | | | | | | | | | | | | | | |
| 0B1296B0 | | 1 | PZ | | | | | | | | | | | | | | | | | | | | | | | | | | | | | | | | | | | | | | | | | | | | | | | | | | | |
| CR1040A0 | DOOR LATCH FOR EL.MECH. LOCKING SYSTEM | 1 | PZ | | | | | | | | | | | | | | | | | | | | | | | | | | | | | | | | | | | | | | | | | | | | | | | | | | | |
| ED1240A0 | TECHNICAL DATA LABEL | 1 | PZ | | | | | | | | | | | | | | | | | | | | | | | | | | | | | | | | | | | | | | | | | | | | | | | | | | | |
| IP1325B0 | POLYSTYREN E CORNER PACKING D20 | 0.650 | PZ | | | | | | | | | | | | | | | | | | | | | | | | | | | | | | | | | | | | | | | | | | | | | | | | | | | |
| IP1385A1 | CORNER POLYSTYREN E PACKING 110X80X2000 | 0.400 | M | | | | | | | | | | | | | | | | | | | | | | | | | | | | | | | | | | | | | | | | | | | | | | | | | | | |
| IP1508A1 | POLYSTYREN E U SHAPED PROFILE 2000X60X60 | 1.200 | M | | | | | | | | | | | | | | | | | | | | | | | | | | | | | | | | | | | | | | | | | | | | | | | | | | | |
| ML1005A0 | DE5 DF0.6 H18 COMPRESSIO N SPRING | 2 | PZ | | | | | | | | | | | | | | | | | | | | | | | | | | | | | | | | | | | | | | | | | | | | | | | | | | | |
| SL1155A1 | LOCTITE BICOMPONEN T SILICON | 14 | ML | | | | | | | | | | | | | | | | | | | | | | | | | | | | | | | | | | | | | | | | | | | | | | | | | | | |
| TB1563A0 | DOOR LATERAL BEAM SP800 | 2 | PZ | | | | | | | | | | | | | | | | | | | | | | | | | | | | | | | | | | | | | | | | | | | | | | | | | | | |





| COMPONENT | | | SPARE PART | | | | | | | | | | | | | | | | | | | | | | | | | | | | | | | | | | | | | | | | | | | | | | | | | | | | | | | | | | | | | | | | | | | | | | |
|-----------|---|---|------------|---|--|------|-------------|-----|-----|----------|---|---|----|----------|--|---|----|----------|--------------------------------------|----|----|----------|---------------------------------|----|----|----------|----------------------------------|---|----|----------|--------------------------|-------|---|----------|--------------------------------|---|----|----------|----------------------------------|---|----|----------|----------------------------------|---|----|----------|--------------------|---|----|----------|-------------------|---|----|----------|------------------------------------|---|----|----------|------------------------------------|---|----|----------|---|---|----|----------|---|---|----|----------|--|---|----|
| Code | Description | Image | Code | Description | Components list | | | | | | | | | | | | | | | | | | | | | | | | | | | | | | | | | | | | | | | | | | | | | | | | | | | | | | | | | | | | | | | | | | | | |
| VT1325A | SP ELENA 557X364X4 EXTERNAL GLASS |  | KDR1288A | BL SHOP.PRO ELENA EXTERNAL DOOR KIT | <table border="1"> <thead> <tr> <th>Code</th> <th>Description</th> <th>Qty</th> <th>UOM</th> </tr> </thead> <tbody> <tr> <td>TB3303A0</td> <td>SHOP.PRO STE-ELE FLAG DOOR HANDLE TUBE</td> <td>1</td> <td>PZ</td> </tr> <tr> <td>VI1036A0</td> <td>ST STEEL STRIPED THREAD INSERT M10 FTT/C</td> <td>1</td> <td>PZ</td> </tr> <tr> <td>VI1220A1</td> <td>4,2X12 TCB SELF-TAPPIN G SCREW</td> <td>12</td> <td>PZ</td> </tr> <tr> <td>VI1930A0</td> <td>5X25 ST. STEEL SCREW CHIP</td> <td>22</td> <td>PZ</td> </tr> <tr> <td>VI1998A0</td> <td>ZINC PLATED SCREW 5X30 TCB</td> <td>2</td> <td>PZ</td> </tr> <tr> <td>VM1059A1</td> <td>HEAT SHRINK FILM H800</td> <td>1.200</td> <td>M</td> </tr> <tr> <td>VM1209A0</td> <td>SHOP.PRO LOCK PIN WASHER</td> <td>1</td> <td>PZ</td> </tr> <tr> <td>VM1630A0</td> <td>INTERNAL GLASS PUSHING CAP</td> <td>4</td> <td>PZ</td> </tr> <tr> <td>VM1630A1</td> <td>INTERNAL GLASS PUSHING CAP</td> <td>4</td> <td>PZ</td> </tr> <tr> <td>VM2274A0</td> <td>GROOVED BUSHING</td> <td>1</td> <td>PZ</td> </tr> <tr> <td>VM2275A0</td> <td>SMOOTH BUSHING</td> <td>1</td> <td>PZ</td> </tr> <tr> <td>VM2456A0</td> <td>BAKERLUX SHOP.PRO HANDLE END</td> <td>2</td> <td>PZ</td> </tr> <tr> <td>VM2456A0</td> <td>BAKERLUX SHOP.PRO HANDLE END</td> <td>2</td> <td>PZ</td> </tr> <tr> <td>VM2465A0</td> <td>SP SIDE-OPENIN G DOOR RIGHT LOWER CAP KIT</td> <td>1</td> <td>PZ</td> </tr> <tr> <td>VM2465A0</td> <td>SP SIDE-OPENIN G DOOR RIGHT LOWER CAP KIT</td> <td>1</td> <td>PZ</td> </tr> <tr> <td>VM2466A0</td> <td>BL SP LEFT LOWER LATERAL DOOR CAP</td> <td>1</td> <td>PZ</td> </tr> </tbody> </table> | Code | Description | Qty | UOM | TB3303A0 | SHOP.PRO STE-ELE FLAG DOOR HANDLE TUBE | 1 | PZ | VI1036A0 | ST STEEL STRIPED THREAD INSERT M10 FTT/C | 1 | PZ | VI1220A1 | 4,2X12 TCB SELF-TAPPIN G SCREW | 12 | PZ | VI1930A0 | 5X25 ST. STEEL SCREW CHIP | 22 | PZ | VI1998A0 | ZINC PLATED SCREW 5X30 TCB | 2 | PZ | VM1059A1 | HEAT SHRINK FILM H800 | 1.200 | M | VM1209A0 | SHOP.PRO LOCK PIN WASHER | 1 | PZ | VM1630A0 | INTERNAL GLASS PUSHING CAP | 4 | PZ | VM1630A1 | INTERNAL GLASS PUSHING CAP | 4 | PZ | VM2274A0 | GROOVED BUSHING | 1 | PZ | VM2275A0 | SMOOTH BUSHING | 1 | PZ | VM2456A0 | BAKERLUX SHOP.PRO HANDLE END | 2 | PZ | VM2456A0 | BAKERLUX SHOP.PRO HANDLE END | 2 | PZ | VM2465A0 | SP SIDE-OPENIN G DOOR RIGHT LOWER CAP KIT | 1 | PZ | VM2465A0 | SP SIDE-OPENIN G DOOR RIGHT LOWER CAP KIT | 1 | PZ | VM2466A0 | BL SP LEFT LOWER LATERAL DOOR CAP | 1 | PZ |
| Code | Description | Qty | UOM | | | | | | | | | | | | | | | | | | | | | | | | | | | | | | | | | | | | | | | | | | | | | | | | | | | | | | | | | | | | | | | | | | | | | | |
| TB3303A0 | SHOP.PRO STE-ELE FLAG DOOR HANDLE TUBE | 1 | PZ | | | | | | | | | | | | | | | | | | | | | | | | | | | | | | | | | | | | | | | | | | | | | | | | | | | | | | | | | | | | | | | | | | | | | | |
| VI1036A0 | ST STEEL STRIPED THREAD INSERT M10 FTT/C | 1 | PZ | | | | | | | | | | | | | | | | | | | | | | | | | | | | | | | | | | | | | | | | | | | | | | | | | | | | | | | | | | | | | | | | | | | | | | |
| VI1220A1 | 4,2X12 TCB SELF-TAPPIN G SCREW | 12 | PZ | | | | | | | | | | | | | | | | | | | | | | | | | | | | | | | | | | | | | | | | | | | | | | | | | | | | | | | | | | | | | | | | | | | | | | |
| VI1930A0 | 5X25 ST. STEEL SCREW CHIP | 22 | PZ | | | | | | | | | | | | | | | | | | | | | | | | | | | | | | | | | | | | | | | | | | | | | | | | | | | | | | | | | | | | | | | | | | | | | | |
| VI1998A0 | ZINC PLATED SCREW 5X30 TCB | 2 | PZ | | | | | | | | | | | | | | | | | | | | | | | | | | | | | | | | | | | | | | | | | | | | | | | | | | | | | | | | | | | | | | | | | | | | | | |
| VM1059A1 | HEAT SHRINK FILM H800 | 1.200 | M | | | | | | | | | | | | | | | | | | | | | | | | | | | | | | | | | | | | | | | | | | | | | | | | | | | | | | | | | | | | | | | | | | | | | | |
| VM1209A0 | SHOP.PRO LOCK PIN WASHER | 1 | PZ | | | | | | | | | | | | | | | | | | | | | | | | | | | | | | | | | | | | | | | | | | | | | | | | | | | | | | | | | | | | | | | | | | | | | | |
| VM1630A0 | INTERNAL GLASS PUSHING CAP | 4 | PZ | | | | | | | | | | | | | | | | | | | | | | | | | | | | | | | | | | | | | | | | | | | | | | | | | | | | | | | | | | | | | | | | | | | | | | |
| VM1630A1 | INTERNAL GLASS PUSHING CAP | 4 | PZ | | | | | | | | | | | | | | | | | | | | | | | | | | | | | | | | | | | | | | | | | | | | | | | | | | | | | | | | | | | | | | | | | | | | | | |
| VM2274A0 | GROOVED BUSHING | 1 | PZ | | | | | | | | | | | | | | | | | | | | | | | | | | | | | | | | | | | | | | | | | | | | | | | | | | | | | | | | | | | | | | | | | | | | | | |
| VM2275A0 | SMOOTH BUSHING | 1 | PZ | | | | | | | | | | | | | | | | | | | | | | | | | | | | | | | | | | | | | | | | | | | | | | | | | | | | | | | | | | | | | | | | | | | | | | |
| VM2456A0 | BAKERLUX SHOP.PRO HANDLE END | 2 | PZ | | | | | | | | | | | | | | | | | | | | | | | | | | | | | | | | | | | | | | | | | | | | | | | | | | | | | | | | | | | | | | | | | | | | | | |
| VM2456A0 | BAKERLUX SHOP.PRO HANDLE END | 2 | PZ | | | | | | | | | | | | | | | | | | | | | | | | | | | | | | | | | | | | | | | | | | | | | | | | | | | | | | | | | | | | | | | | | | | | | | |
| VM2465A0 | SP SIDE-OPENIN G DOOR RIGHT LOWER CAP KIT | 1 | PZ | | | | | | | | | | | | | | | | | | | | | | | | | | | | | | | | | | | | | | | | | | | | | | | | | | | | | | | | | | | | | | | | | | | | | | |
| VM2465A0 | SP SIDE-OPENIN G DOOR RIGHT LOWER CAP KIT | 1 | PZ | | | | | | | | | | | | | | | | | | | | | | | | | | | | | | | | | | | | | | | | | | | | | | | | | | | | | | | | | | | | | | | | | | | | | | |
| VM2466A0 | BL SP LEFT LOWER LATERAL DOOR CAP | 1 | PZ | | | | | | | | | | | | | | | | | | | | | | | | | | | | | | | | | | | | | | | | | | | | | | | | | | | | | | | | | | | | | | | | | | | | | | |



| COMPONENT | | | SPARE PART | | | | | | | | | | | | | | | | | | | | | | | | | | | | | | | | | | | | | | | | | | | | | | | | | | | | | | | | | | |
|-----------|---|---|------------|---|--|------|-------------|-----|-----|----------|--|---|----|----------|---|---|----|----------|---|---|----|----------|--|---|----|----------|--|---|----|----------|---|---|----|----------|---|---|----|----------|--|---|----|----------|--|---|----|----------|--|---|----|----------|--|---|----|----------|---|---|----|----------|---|---|----|
| Code | Description | Image | Code | Description | Components list | | | | | | | | | | | | | | | | | | | | | | | | | | | | | | | | | | | | | | | | | | | | | | | | | | | | | | | | |
| VT1325A | SP ELENA 557X364X4 EXTERNAL GLASS |  | KDR1288A | BL SHOP.PRO ELENA EXTERNAL DOOR KIT | <table border="1"> <thead> <tr> <th>Code</th> <th>Description</th> <th>Qty</th> <th>UOM</th> </tr> </thead> <tbody> <tr> <td>VM2466A0</td> <td>BL SP LEFT LOWER LATERAL DOOR CAP</td> <td>1</td> <td>PZ</td> </tr> <tr> <td>VM2467A0</td> <td>SP SIDE-OPENIN G DOOR RIGHT UPPER CAP KIT</td> <td>1</td> <td>PZ</td> </tr> <tr> <td>VM2467A0</td> <td>SP SIDE-OPENIN G DOOR RIGHT UPPER CAP KIT</td> <td>1</td> <td>PZ</td> </tr> <tr> <td>VM2468A0</td> <td>BL SP LEFT UPPER LATERAL DOOR CAP</td> <td>1</td> <td>PZ</td> </tr> <tr> <td>VM2468A0</td> <td>BL SP LEFT UPPER LATERAL DOOR CAP</td> <td>1</td> <td>PZ</td> </tr> <tr> <td>VM2470A0</td> <td>SLIDE TO FIX INTERNAL GLASS SHOP.PRO</td> <td>2</td> <td>PZ</td> </tr> <tr> <td>VM2470A0</td> <td>SLIDE TO FIX INTERNAL GLASS SHOP.PRO</td> <td>2</td> <td>PZ</td> </tr> <tr> <td>VM2471A0</td> <td>BL SP LOWER CLAMP INT LOCK GLASS SLIDER</td> <td>1</td> <td>PZ</td> </tr> <tr> <td>VM2471A0</td> <td>BL SP LOWER CLAMP INT LOCK GLASS SLIDER</td> <td>1</td> <td>PZ</td> </tr> <tr> <td>VM2472A0</td> <td>BL SP UPPER CLAMP INT LOCK GLASS SLIDER</td> <td>1</td> <td>PZ</td> </tr> <tr> <td>VM2472A0</td> <td>BL SP UPPER CLAMP INT LOCK GLASS SLIDER</td> <td>1</td> <td>PZ</td> </tr> <tr> <td>VM2473A0</td> <td>BL SP INT GLASS HINGE LOWER LOCK PIN</td> <td>1</td> <td>PZ</td> </tr> <tr> <td>VM2473A0</td> <td>BL SP INT GLASS HINGE LOWER LOCK PIN</td> <td>1</td> <td>PZ</td> </tr> </tbody> </table> | Code | Description | Qty | UOM | VM2466A0 | BL SP LEFT LOWER LATERAL DOOR CAP | 1 | PZ | VM2467A0 | SP SIDE-OPENIN G DOOR RIGHT UPPER CAP KIT | 1 | PZ | VM2467A0 | SP SIDE-OPENIN G DOOR RIGHT UPPER CAP KIT | 1 | PZ | VM2468A0 | BL SP LEFT UPPER LATERAL DOOR CAP | 1 | PZ | VM2468A0 | BL SP LEFT UPPER LATERAL DOOR CAP | 1 | PZ | VM2470A0 | SLIDE TO FIX INTERNAL GLASS SHOP.PRO | 2 | PZ | VM2470A0 | SLIDE TO FIX INTERNAL GLASS SHOP.PRO | 2 | PZ | VM2471A0 | BL SP LOWER CLAMP INT LOCK GLASS SLIDER | 1 | PZ | VM2471A0 | BL SP LOWER CLAMP INT LOCK GLASS SLIDER | 1 | PZ | VM2472A0 | BL SP UPPER CLAMP INT LOCK GLASS SLIDER | 1 | PZ | VM2472A0 | BL SP UPPER CLAMP INT LOCK GLASS SLIDER | 1 | PZ | VM2473A0 | BL SP INT GLASS HINGE LOWER LOCK PIN | 1 | PZ | VM2473A0 | BL SP INT GLASS HINGE LOWER LOCK PIN | 1 | PZ |
| Code | Description | Qty | UOM | | | | | | | | | | | | | | | | | | | | | | | | | | | | | | | | | | | | | | | | | | | | | | | | | | | | | | | | | | |
| VM2466A0 | BL SP LEFT LOWER LATERAL DOOR CAP | 1 | PZ | | | | | | | | | | | | | | | | | | | | | | | | | | | | | | | | | | | | | | | | | | | | | | | | | | | | | | | | | | |
| VM2467A0 | SP SIDE-OPENIN G DOOR RIGHT UPPER CAP KIT | 1 | PZ | | | | | | | | | | | | | | | | | | | | | | | | | | | | | | | | | | | | | | | | | | | | | | | | | | | | | | | | | | |
| VM2467A0 | SP SIDE-OPENIN G DOOR RIGHT UPPER CAP KIT | 1 | PZ | | | | | | | | | | | | | | | | | | | | | | | | | | | | | | | | | | | | | | | | | | | | | | | | | | | | | | | | | | |
| VM2468A0 | BL SP LEFT UPPER LATERAL DOOR CAP | 1 | PZ | | | | | | | | | | | | | | | | | | | | | | | | | | | | | | | | | | | | | | | | | | | | | | | | | | | | | | | | | | |
| VM2468A0 | BL SP LEFT UPPER LATERAL DOOR CAP | 1 | PZ | | | | | | | | | | | | | | | | | | | | | | | | | | | | | | | | | | | | | | | | | | | | | | | | | | | | | | | | | | |
| VM2470A0 | SLIDE TO FIX INTERNAL GLASS SHOP.PRO | 2 | PZ | | | | | | | | | | | | | | | | | | | | | | | | | | | | | | | | | | | | | | | | | | | | | | | | | | | | | | | | | | |
| VM2470A0 | SLIDE TO FIX INTERNAL GLASS SHOP.PRO | 2 | PZ | | | | | | | | | | | | | | | | | | | | | | | | | | | | | | | | | | | | | | | | | | | | | | | | | | | | | | | | | | |
| VM2471A0 | BL SP LOWER CLAMP INT LOCK GLASS SLIDER | 1 | PZ | | | | | | | | | | | | | | | | | | | | | | | | | | | | | | | | | | | | | | | | | | | | | | | | | | | | | | | | | | |
| VM2471A0 | BL SP LOWER CLAMP INT LOCK GLASS SLIDER | 1 | PZ | | | | | | | | | | | | | | | | | | | | | | | | | | | | | | | | | | | | | | | | | | | | | | | | | | | | | | | | | | |
| VM2472A0 | BL SP UPPER CLAMP INT LOCK GLASS SLIDER | 1 | PZ | | | | | | | | | | | | | | | | | | | | | | | | | | | | | | | | | | | | | | | | | | | | | | | | | | | | | | | | | | |
| VM2472A0 | BL SP UPPER CLAMP INT LOCK GLASS SLIDER | 1 | PZ | | | | | | | | | | | | | | | | | | | | | | | | | | | | | | | | | | | | | | | | | | | | | | | | | | | | | | | | | | |
| VM2473A0 | BL SP INT GLASS HINGE LOWER LOCK PIN | 1 | PZ | | | | | | | | | | | | | | | | | | | | | | | | | | | | | | | | | | | | | | | | | | | | | | | | | | | | | | | | | | |
| VM2473A0 | BL SP INT GLASS HINGE LOWER LOCK PIN | 1 | PZ | | | | | | | | | | | | | | | | | | | | | | | | | | | | | | | | | | | | | | | | | | | | | | | | | | | | | | | | | | |







| COMPONENT | | | SPARE PART | | | | | | | | | | | | | | | | | | | | | | | | | | | | | | | | | | | | | | | | | | | | | | | | | | |
|-----------|---|--|------------|---|--|------|-------------|-----|-----|----------|---|---|----|----------|---|---|----|----------|--------------------------------------|---|----|----------|--------------------------------------|---|----|----------|--------------------------------------|---|-------|----------|---|--|----|----------|---|---|----|----------|----------------------|---|----|----------|--|--|--|---|----|----------|--|--|--|---|----|
| Code | Description | Image | Code | Description | Components list | | | | | | | | | | | | | | | | | | | | | | | | | | | | | | | | | | | | | | | | | | | | | | | | |
| VT1325A | SP ELENA 557X364X4 EXTERNAL GLASS |  | KDR1288A | BL SHOP.PRO ELENA EXTERNAL DOOR KIT | <table border="1"> <thead> <tr> <th>Code</th> <th>Description</th> <th>Qty</th> <th>UOM</th> </tr> </thead> <tbody> <tr> <td>VM2474A0</td> <td>BL SP INT GLASS HINGE UPPER LOCK PIN</td> <td>1</td> <td>PZ</td> </tr> <tr> <td>VM2474A0</td> <td>BL SP INT GLASS HINGE UPPER LOCK PIN</td> <td>1</td> <td>PZ</td> </tr> <tr> <td>VM2479A0</td> <td>BL SP GLASS H6 PUSHING BRACKET</td> <td>4</td> <td>PZ</td> </tr> <tr> <td>VM2479A0</td> <td>BL SP GLASS H6 PUSHING BRACKET</td> <td>4</td> <td>PZ</td> </tr> <tr> <td>VM2489A0</td> <td>SP HANDLE END KIT + STYLUS KIT</td> <td>1</td> <td>PZ</td> </tr> <tr> <td>VM2504A0</td> <td>DOWEL TO GUIDE SLIDE SPRING SHOP.PRO</td> <td>2</td> <td>PZ</td> </tr> <tr> <td>VM2504A0</td> <td>DOWEL TO GUIDE SLIDE SPRING SHOP.PRO</td> <td>2</td> <td>PZ</td> </tr> <tr> <td>VM2527A0</td> <td>STYLUS PEN FOR SP</td> <td>1</td> <td>PZ</td> </tr> <tr> <td>VT1325A0</td> <td>SP ELENA 557X364X4 EXTERNAL GLASS</td> <td></td> <td></td> <td>1</td> <td>PZ</td> </tr> <tr> <td>VT1325A0</td> <td>SP ELENA 557X364X4 EXTERNAL GLASS</td> <td></td> <td></td> <td>1</td> <td>PZ</td> </tr> </tbody> </table> | Code | Description | Qty | UOM | VM2474A0 | BL SP INT GLASS HINGE UPPER LOCK PIN | 1 | PZ | VM2474A0 | BL SP INT GLASS HINGE UPPER LOCK PIN | 1 | PZ | VM2479A0 | BL SP GLASS H6 PUSHING BRACKET | 4 | PZ | VM2479A0 | BL SP GLASS H6 PUSHING BRACKET | 4 | PZ | VM2489A0 | SP HANDLE END KIT + STYLUS KIT | 1 | PZ | VM2504A0 | DOWEL TO GUIDE SLIDE SPRING SHOP.PRO | 2 | PZ | VM2504A0 | DOWEL TO GUIDE SLIDE SPRING SHOP.PRO | 2 | PZ | VM2527A0 | STYLUS PEN FOR SP | 1 | PZ | VT1325A0 | SP ELENA 557X364X4 EXTERNAL GLASS | | | 1 | PZ | VT1325A0 | SP ELENA 557X364X4 EXTERNAL GLASS | | | 1 | PZ |
| | | | Code | Description | Qty | UOM | | | | | | | | | | | | | | | | | | | | | | | | | | | | | | | | | | | | | | | | | | | | | | | |
| VM2474A0 | BL SP INT GLASS HINGE UPPER LOCK PIN | 1 | PZ | | | | | | | | | | | | | | | | | | | | | | | | | | | | | | | | | | | | | | | | | | | | | | | | | | |
| VM2474A0 | BL SP INT GLASS HINGE UPPER LOCK PIN | 1 | PZ | | | | | | | | | | | | | | | | | | | | | | | | | | | | | | | | | | | | | | | | | | | | | | | | | | |
| VM2479A0 | BL SP GLASS H6 PUSHING BRACKET | 4 | PZ | | | | | | | | | | | | | | | | | | | | | | | | | | | | | | | | | | | | | | | | | | | | | | | | | | |
| VM2479A0 | BL SP GLASS H6 PUSHING BRACKET | 4 | PZ | | | | | | | | | | | | | | | | | | | | | | | | | | | | | | | | | | | | | | | | | | | | | | | | | | |
| VM2489A0 | SP HANDLE END KIT + STYLUS KIT | 1 | PZ | | | | | | | | | | | | | | | | | | | | | | | | | | | | | | | | | | | | | | | | | | | | | | | | | | |
| VM2504A0 | DOWEL TO GUIDE SLIDE SPRING SHOP.PRO | 2 | PZ | | | | | | | | | | | | | | | | | | | | | | | | | | | | | | | | | | | | | | | | | | | | | | | | | | |
| VM2504A0 | DOWEL TO GUIDE SLIDE SPRING SHOP.PRO | 2 | PZ | | | | | | | | | | | | | | | | | | | | | | | | | | | | | | | | | | | | | | | | | | | | | | | | | | |
| VM2527A0 | STYLUS PEN FOR SP | 1 | PZ | | | | | | | | | | | | | | | | | | | | | | | | | | | | | | | | | | | | | | | | | | | | | | | | | | |
| VT1325A0 | SP ELENA 557X364X4 EXTERNAL GLASS | | | 1 | PZ | | | | | | | | | | | | | | | | | | | | | | | | | | | | | | | | | | | | | | | | | | | | | | | | |
| VT1325A0 | SP ELENA 557X364X4 EXTERNAL GLASS | | | 1 | PZ | | | | | | | | | | | | | | | | | | | | | | | | | | | | | | | | | | | | | | | | | | | | | | | | |
| KDR1282A | BL SHOP.PRO ELENA COMPLETE DOOR KIT | <table border="1"> <thead> <tr> <th>Code</th> <th>Description</th> <th>Qty</th> <th>UOM</th> </tr> </thead> <tbody> <tr> <td>OB1285A0</td> <td></td> <td>1</td> <td>PZ</td> </tr> <tr> <td>OB1286A0</td> <td></td> <td>1</td> <td>PZ</td> </tr> <tr> <td>OB1287A0</td> <td></td> <td>1</td> <td>PZ</td> </tr> <tr> <td>OB1288A0</td> <td></td> <td>1</td> <td>PZ</td> </tr> <tr> <td>CR1112A0</td> <td>BLSP ARIANNA-ELE NA DROPDOWN DOOR HINGE</td> <td>2</td> <td>PZ</td> </tr> <tr> <td>IP1508A1</td> <td>POLYSTYREN E U SHAPED PROFILE 2000X60X60</td> <td>1.500</td> <td>M</td> </tr> <tr> <td>LP1050A0</td> <td>BL SHOP.PRO L180 COMPLETE LED BAR</td> <td>1</td> <td>PZ</td> </tr> </tbody> </table> | Code | Description | Qty | UOM | OB1285A0 | | 1 | PZ | OB1286A0 | | 1 | PZ | OB1287A0 | | 1 | PZ | OB1288A0 | | 1 | PZ | CR1112A0 | BLSP ARIANNA-ELE NA DROPDOWN DOOR HINGE | 2 | PZ | IP1508A1 | POLYSTYREN E U SHAPED PROFILE 2000X60X60 | 1.500 | M | LP1050A0 | BL SHOP.PRO L180 COMPLETE LED BAR | 1 | PZ | | | | | | | | | | | | | | | | | | | |
| Code | Description | Qty | UOM | | | | | | | | | | | | | | | | | | | | | | | | | | | | | | | | | | | | | | | | | | | | | | | | | | |
| OB1285A0 | | 1 | PZ | | | | | | | | | | | | | | | | | | | | | | | | | | | | | | | | | | | | | | | | | | | | | | | | | | |
| OB1286A0 | | 1 | PZ | | | | | | | | | | | | | | | | | | | | | | | | | | | | | | | | | | | | | | | | | | | | | | | | | | |
| OB1287A0 | | 1 | PZ | | | | | | | | | | | | | | | | | | | | | | | | | | | | | | | | | | | | | | | | | | | | | | | | | | |
| OB1288A0 | | 1 | PZ | | | | | | | | | | | | | | | | | | | | | | | | | | | | | | | | | | | | | | | | | | | | | | | | | | |
| CR1112A0 | BLSP ARIANNA-ELE NA DROPDOWN DOOR HINGE | 2 | PZ | | | | | | | | | | | | | | | | | | | | | | | | | | | | | | | | | | | | | | | | | | | | | | | | | | |
| IP1508A1 | POLYSTYREN E U SHAPED PROFILE 2000X60X60 | 1.500 | M | | | | | | | | | | | | | | | | | | | | | | | | | | | | | | | | | | | | | | | | | | | | | | | | | | |
| LP1050A0 | BL SHOP.PRO L180 COMPLETE LED BAR | 1 | PZ | | | | | | | | | | | | | | | | | | | | | | | | | | | | | | | | | | | | | | | | | | | | | | | | | | |

| COMPONENT | | | SPARE PART | | | | | | | | | | | | | | | | | | | | | | | | | | | | | | | | | | | | | | | | | | | | | | | | | | | | | | | | | | | | | | | | | | | | | | | | | | |
|-----------|--|---|------------|---|---|------|-------------|-----|-----|----------|------------------------------------|----|----|----------|-------------------------------|---|----|----------|--|---|----|----------|---|---|----|----------|--------------------------------------|----|----|----------|----------------------------|---|----|----------|---------------------------------|----|----|----------|----------------------------------|---|----|----------|--------------------------|-------|---|----------|----------------------------------|---|----|----------|----------------------------------|---|----|----------|------------------------------------|---|----|----------|------------------------------------|---|----|----------|--|---|----|----------|--|---|----|----------|---|---|----|----------|---|---|----|
| Code | Description | Image | Code | Description | Components list | | | | | | | | | | | | | | | | | | | | | | | | | | | | | | | | | | | | | | | | | | | | | | | | | | | | | | | | | | | | | | | | | | | | | | | | |
| VT1325A | SP ELENA 557X364X4 EXTERNAL GLASS |  | KDR1282A | BL SHOP.PRO ELENA COMPLETE DOOR KIT | <table border="1"> <thead> <tr> <th>Code</th> <th>Description</th> <th>Qty</th> <th>UOM</th> </tr> </thead> <tbody> <tr> <td>SL1155A1</td> <td>LOCTITE BICOMPONEN T SILICON</td> <td>14</td> <td>ML</td> </tr> <tr> <td>TB1563A0</td> <td>DOOR LATERAL BEAM SP800</td> <td>1</td> <td>PZ</td> </tr> <tr> <td>TB3302A0</td> <td></td> <td>1</td> <td>PZ</td> </tr> <tr> <td>VI1014A0</td> <td>STAINLESS STEEL WASHER 4.5X9X0.8</td> <td>1</td> <td>PZ</td> </tr> <tr> <td>VI1220A1</td> <td>4,2X12 TCB SELF-TAPPIN G SCREW</td> <td>10</td> <td>PZ</td> </tr> <tr> <td>VI1875A0</td> <td>SCREW M5X10 TC1/2T INOX</td> <td>6</td> <td>PZ</td> </tr> <tr> <td>VI1930A0</td> <td>5X25 ST. STEEL SCREW CHIP</td> <td>12</td> <td>PZ</td> </tr> <tr> <td>VI1998A0</td> <td>ZINC PLATED SCREW 5X30 TCB</td> <td>2</td> <td>PZ</td> </tr> <tr> <td>VM1059A1</td> <td>HEAT SHRINK FILM H800</td> <td>0.700</td> <td>M</td> </tr> <tr> <td>VM1630A0</td> <td>INTERNAL GLASS PUSHING CAP</td> <td>1</td> <td>PZ</td> </tr> <tr> <td>VM1630A1</td> <td>INTERNAL GLASS PUSHING CAP</td> <td>1</td> <td>PZ</td> </tr> <tr> <td>VM2456A0</td> <td>BAKERLUX SHOP.PRO HANDLE END</td> <td>2</td> <td>PZ</td> </tr> <tr> <td>VM2456A0</td> <td>BAKERLUX SHOP.PRO HANDLE END</td> <td>2</td> <td>PZ</td> </tr> <tr> <td>VM2461A0</td> <td>BL SP RIGHT LOWER DROPDOWN DOOR CAP KIT</td> <td>1</td> <td>PZ</td> </tr> <tr> <td>VM2461A0</td> <td>BL SP RIGHT LOWER DROPDOWN DOOR CAP KIT</td> <td>1</td> <td>PZ</td> </tr> <tr> <td>VM2462A0</td> <td>BL SP LEFT LOWER DROPDOWN DOOR CAP</td> <td>1</td> <td>PZ</td> </tr> <tr> <td>VM2462A0</td> <td>BL SP LEFT LOWER DROPDOWN DOOR CAP</td> <td>1</td> <td>PZ</td> </tr> </tbody> </table> | Code | Description | Qty | UOM | SL1155A1 | LOCTITE BICOMPONEN T SILICON | 14 | ML | TB1563A0 | DOOR LATERAL BEAM SP800 | 1 | PZ | TB3302A0 | | 1 | PZ | VI1014A0 | STAINLESS STEEL WASHER 4.5X9X0.8 | 1 | PZ | VI1220A1 | 4,2X12 TCB SELF-TAPPIN G SCREW | 10 | PZ | VI1875A0 | SCREW M5X10 TC1/2T INOX | 6 | PZ | VI1930A0 | 5X25 ST. STEEL SCREW CHIP | 12 | PZ | VI1998A0 | ZINC PLATED SCREW 5X30 TCB | 2 | PZ | VM1059A1 | HEAT SHRINK FILM H800 | 0.700 | M | VM1630A0 | INTERNAL GLASS PUSHING CAP | 1 | PZ | VM1630A1 | INTERNAL GLASS PUSHING CAP | 1 | PZ | VM2456A0 | BAKERLUX SHOP.PRO HANDLE END | 2 | PZ | VM2456A0 | BAKERLUX SHOP.PRO HANDLE END | 2 | PZ | VM2461A0 | BL SP RIGHT LOWER DROPDOWN DOOR CAP KIT | 1 | PZ | VM2461A0 | BL SP RIGHT LOWER DROPDOWN DOOR CAP KIT | 1 | PZ | VM2462A0 | BL SP LEFT LOWER DROPDOWN DOOR CAP | 1 | PZ | VM2462A0 | BL SP LEFT LOWER DROPDOWN DOOR CAP | 1 | PZ |
| Code | Description | Qty | UOM | | | | | | | | | | | | | | | | | | | | | | | | | | | | | | | | | | | | | | | | | | | | | | | | | | | | | | | | | | | | | | | | | | | | | | | | | | |
| SL1155A1 | LOCTITE BICOMPONEN T SILICON | 14 | ML | | | | | | | | | | | | | | | | | | | | | | | | | | | | | | | | | | | | | | | | | | | | | | | | | | | | | | | | | | | | | | | | | | | | | | | | | | |
| TB1563A0 | DOOR LATERAL BEAM SP800 | 1 | PZ | | | | | | | | | | | | | | | | | | | | | | | | | | | | | | | | | | | | | | | | | | | | | | | | | | | | | | | | | | | | | | | | | | | | | | | | | | |
| TB3302A0 | | 1 | PZ | | | | | | | | | | | | | | | | | | | | | | | | | | | | | | | | | | | | | | | | | | | | | | | | | | | | | | | | | | | | | | | | | | | | | | | | | | |
| VI1014A0 | STAINLESS STEEL WASHER 4.5X9X0.8 | 1 | PZ | | | | | | | | | | | | | | | | | | | | | | | | | | | | | | | | | | | | | | | | | | | | | | | | | | | | | | | | | | | | | | | | | | | | | | | | | | |
| VI1220A1 | 4,2X12 TCB SELF-TAPPIN G SCREW | 10 | PZ | | | | | | | | | | | | | | | | | | | | | | | | | | | | | | | | | | | | | | | | | | | | | | | | | | | | | | | | | | | | | | | | | | | | | | | | | | |
| VI1875A0 | SCREW M5X10 TC1/2T INOX | 6 | PZ | | | | | | | | | | | | | | | | | | | | | | | | | | | | | | | | | | | | | | | | | | | | | | | | | | | | | | | | | | | | | | | | | | | | | | | | | | |
| VI1930A0 | 5X25 ST. STEEL SCREW CHIP | 12 | PZ | | | | | | | | | | | | | | | | | | | | | | | | | | | | | | | | | | | | | | | | | | | | | | | | | | | | | | | | | | | | | | | | | | | | | | | | | | |
| VI1998A0 | ZINC PLATED SCREW 5X30 TCB | 2 | PZ | | | | | | | | | | | | | | | | | | | | | | | | | | | | | | | | | | | | | | | | | | | | | | | | | | | | | | | | | | | | | | | | | | | | | | | | | | |
| VM1059A1 | HEAT SHRINK FILM H800 | 0.700 | M | | | | | | | | | | | | | | | | | | | | | | | | | | | | | | | | | | | | | | | | | | | | | | | | | | | | | | | | | | | | | | | | | | | | | | | | | | |
| VM1630A0 | INTERNAL GLASS PUSHING CAP | 1 | PZ | | | | | | | | | | | | | | | | | | | | | | | | | | | | | | | | | | | | | | | | | | | | | | | | | | | | | | | | | | | | | | | | | | | | | | | | | | |
| VM1630A1 | INTERNAL GLASS PUSHING CAP | 1 | PZ | | | | | | | | | | | | | | | | | | | | | | | | | | | | | | | | | | | | | | | | | | | | | | | | | | | | | | | | | | | | | | | | | | | | | | | | | | |
| VM2456A0 | BAKERLUX SHOP.PRO HANDLE END | 2 | PZ | | | | | | | | | | | | | | | | | | | | | | | | | | | | | | | | | | | | | | | | | | | | | | | | | | | | | | | | | | | | | | | | | | | | | | | | | | |
| VM2456A0 | BAKERLUX SHOP.PRO HANDLE END | 2 | PZ | | | | | | | | | | | | | | | | | | | | | | | | | | | | | | | | | | | | | | | | | | | | | | | | | | | | | | | | | | | | | | | | | | | | | | | | | | |
| VM2461A0 | BL SP RIGHT LOWER DROPDOWN DOOR CAP KIT | 1 | PZ | | | | | | | | | | | | | | | | | | | | | | | | | | | | | | | | | | | | | | | | | | | | | | | | | | | | | | | | | | | | | | | | | | | | | | | | | | |
| VM2461A0 | BL SP RIGHT LOWER DROPDOWN DOOR CAP KIT | 1 | PZ | | | | | | | | | | | | | | | | | | | | | | | | | | | | | | | | | | | | | | | | | | | | | | | | | | | | | | | | | | | | | | | | | | | | | | | | | | |
| VM2462A0 | BL SP LEFT LOWER DROPDOWN DOOR CAP | 1 | PZ | | | | | | | | | | | | | | | | | | | | | | | | | | | | | | | | | | | | | | | | | | | | | | | | | | | | | | | | | | | | | | | | | | | | | | | | | | |
| VM2462A0 | BL SP LEFT LOWER DROPDOWN DOOR CAP | 1 | PZ | | | | | | | | | | | | | | | | | | | | | | | | | | | | | | | | | | | | | | | | | | | | | | | | | | | | | | | | | | | | | | | | | | | | | | | | | | |



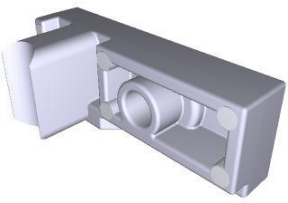
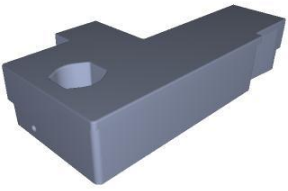

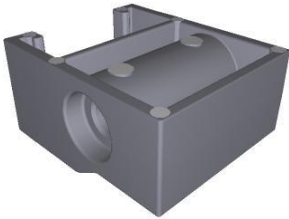
| COMPONENT | | | SPARE PART | | | | | | | | | | | | | | | | | | | | | | | | | | | | | | | | | | | | | | | | | | | | | | | | | | | | | | | | | | | | | | |
|-----------|---|---|------------|---|---|------|-------------|-----|-----|----------|--|---|----|----------|--|---|----|----------|---|---|----|----------|---|---|----|----------|--|---|----|----------|--|---|----|----------|--|---|----|----------|--|---|----|----------|--------------------------------------|---|----|----------|--------------------------------------|---|----|----------|--------------------------------------|---|----|----------|---|---|----|----------|---|---|----|----------|---|---|----|
| Code | Description | Image | Code | Description | Components list | | | | | | | | | | | | | | | | | | | | | | | | | | | | | | | | | | | | | | | | | | | | | | | | | | | | | | | | | | | | |
| VT1325A | SP ELENA 557X364X4 EXTERNAL GLASS |  | KDR1282A | BL SHOP.PRO ELENA COMPLETE DOOR KIT | <table border="1"> <thead> <tr> <th>Code</th> <th>Description</th> <th>Qty</th> <th>UOM</th> </tr> </thead> <tbody> <tr> <td>VM2463A0</td> <td>SHOP.PRO RIGHT UPPER CAP DROP DOWN DOOR</td> <td>1</td> <td>PZ</td> </tr> <tr> <td>VM2463A0</td> <td>SHOP.PRO RIGHT UPPER CAP DROP DOWN DOOR</td> <td>1</td> <td>PZ</td> </tr> <tr> <td>VM2464A0</td> <td>SHOP.PRO LEFT UPPER CAP DROP DOWN DOOR</td> <td>1</td> <td>PZ</td> </tr> <tr> <td>VM2464A0</td> <td>SHOP.PRO LEFT UPPER CAP DROP DOWN DOOR</td> <td>1</td> <td>PZ</td> </tr> <tr> <td>VM2471A0</td> <td>BL SP LOWER CLAMP INT LOCK GLASS SLIDER</td> <td>1</td> <td>PZ</td> </tr> <tr> <td>VM2471A0</td> <td>BL SP LOWER CLAMP INT LOCK GLASS SLIDER</td> <td>1</td> <td>PZ</td> </tr> <tr> <td>VM2472A0</td> <td>BL SP UPPER CLAMP INT LOCK GLASS SLIDER</td> <td>1</td> <td>PZ</td> </tr> <tr> <td>VM2472A0</td> <td>BL SP UPPER CLAMP INT LOCK GLASS SLIDER</td> <td>1</td> <td>PZ</td> </tr> <tr> <td>VM2479A0</td> <td>BL SP GLASS H6 PUSHING BRACKET</td> <td>1</td> <td>PZ</td> </tr> <tr> <td>VM2479A0</td> <td>BL SP GLASS H6 PUSHING BRACKET</td> <td>1</td> <td>PZ</td> </tr> <tr> <td>VM2489A0</td> <td>SP HANDLE END KIT + STYLUS KIT</td> <td>1</td> <td>PZ</td> </tr> <tr> <td>VM2503A0</td> <td>SLIDE TO FIX INTERNAL NON REMOV GLASS SP</td> <td>2</td> <td>PZ</td> </tr> <tr> <td>VM2503A0</td> <td>SLIDE TO FIX INTERNAL NON REMOV GLASS SP</td> <td>2</td> <td>PZ</td> </tr> <tr> <td>VM2512A0</td> <td>BL SP DOOR-MICRO SWITCH SOFT CLOSING</td> <td>1</td> <td>PZ</td> </tr> </tbody> </table> | Code | Description | Qty | UOM | VM2463A0 | SHOP.PRO RIGHT UPPER CAP DROP DOWN DOOR | 1 | PZ | VM2463A0 | SHOP.PRO RIGHT UPPER CAP DROP DOWN DOOR | 1 | PZ | VM2464A0 | SHOP.PRO LEFT UPPER CAP DROP DOWN DOOR | 1 | PZ | VM2464A0 | SHOP.PRO LEFT UPPER CAP DROP DOWN DOOR | 1 | PZ | VM2471A0 | BL SP LOWER CLAMP INT LOCK GLASS SLIDER | 1 | PZ | VM2471A0 | BL SP LOWER CLAMP INT LOCK GLASS SLIDER | 1 | PZ | VM2472A0 | BL SP UPPER CLAMP INT LOCK GLASS SLIDER | 1 | PZ | VM2472A0 | BL SP UPPER CLAMP INT LOCK GLASS SLIDER | 1 | PZ | VM2479A0 | BL SP GLASS H6 PUSHING BRACKET | 1 | PZ | VM2479A0 | BL SP GLASS H6 PUSHING BRACKET | 1 | PZ | VM2489A0 | SP HANDLE END KIT + STYLUS KIT | 1 | PZ | VM2503A0 | SLIDE TO FIX INTERNAL NON REMOV GLASS SP | 2 | PZ | VM2503A0 | SLIDE TO FIX INTERNAL NON REMOV GLASS SP | 2 | PZ | VM2512A0 | BL SP DOOR-MICRO SWITCH SOFT CLOSING | 1 | PZ |
| Code | Description | Qty | UOM | | | | | | | | | | | | | | | | | | | | | | | | | | | | | | | | | | | | | | | | | | | | | | | | | | | | | | | | | | | | | | |
| VM2463A0 | SHOP.PRO RIGHT UPPER CAP DROP DOWN DOOR | 1 | PZ | | | | | | | | | | | | | | | | | | | | | | | | | | | | | | | | | | | | | | | | | | | | | | | | | | | | | | | | | | | | | | |
| VM2463A0 | SHOP.PRO RIGHT UPPER CAP DROP DOWN DOOR | 1 | PZ | | | | | | | | | | | | | | | | | | | | | | | | | | | | | | | | | | | | | | | | | | | | | | | | | | | | | | | | | | | | | | |
| VM2464A0 | SHOP.PRO LEFT UPPER CAP DROP DOWN DOOR | 1 | PZ | | | | | | | | | | | | | | | | | | | | | | | | | | | | | | | | | | | | | | | | | | | | | | | | | | | | | | | | | | | | | | |
| VM2464A0 | SHOP.PRO LEFT UPPER CAP DROP DOWN DOOR | 1 | PZ | | | | | | | | | | | | | | | | | | | | | | | | | | | | | | | | | | | | | | | | | | | | | | | | | | | | | | | | | | | | | | |
| VM2471A0 | BL SP LOWER CLAMP INT LOCK GLASS SLIDER | 1 | PZ | | | | | | | | | | | | | | | | | | | | | | | | | | | | | | | | | | | | | | | | | | | | | | | | | | | | | | | | | | | | | | |
| VM2471A0 | BL SP LOWER CLAMP INT LOCK GLASS SLIDER | 1 | PZ | | | | | | | | | | | | | | | | | | | | | | | | | | | | | | | | | | | | | | | | | | | | | | | | | | | | | | | | | | | | | | |
| VM2472A0 | BL SP UPPER CLAMP INT LOCK GLASS SLIDER | 1 | PZ | | | | | | | | | | | | | | | | | | | | | | | | | | | | | | | | | | | | | | | | | | | | | | | | | | | | | | | | | | | | | | |
| VM2472A0 | BL SP UPPER CLAMP INT LOCK GLASS SLIDER | 1 | PZ | | | | | | | | | | | | | | | | | | | | | | | | | | | | | | | | | | | | | | | | | | | | | | | | | | | | | | | | | | | | | | |
| VM2479A0 | BL SP GLASS H6 PUSHING BRACKET | 1 | PZ | | | | | | | | | | | | | | | | | | | | | | | | | | | | | | | | | | | | | | | | | | | | | | | | | | | | | | | | | | | | | | |
| VM2479A0 | BL SP GLASS H6 PUSHING BRACKET | 1 | PZ | | | | | | | | | | | | | | | | | | | | | | | | | | | | | | | | | | | | | | | | | | | | | | | | | | | | | | | | | | | | | | |
| VM2489A0 | SP HANDLE END KIT + STYLUS KIT | 1 | PZ | | | | | | | | | | | | | | | | | | | | | | | | | | | | | | | | | | | | | | | | | | | | | | | | | | | | | | | | | | | | | | |
| VM2503A0 | SLIDE TO FIX INTERNAL NON REMOV GLASS SP | 2 | PZ | | | | | | | | | | | | | | | | | | | | | | | | | | | | | | | | | | | | | | | | | | | | | | | | | | | | | | | | | | | | | | |
| VM2503A0 | SLIDE TO FIX INTERNAL NON REMOV GLASS SP | 2 | PZ | | | | | | | | | | | | | | | | | | | | | | | | | | | | | | | | | | | | | | | | | | | | | | | | | | | | | | | | | | | | | | |
| VM2512A0 | BL SP DOOR-MICRO SWITCH SOFT CLOSING | 1 | PZ | | | | | | | | | | | | | | | | | | | | | | | | | | | | | | | | | | | | | | | | | | | | | | | | | | | | | | | | | | | | | | |

| COMPONENT | | | SPARE PART | | | | | | | | | | | | | | | | | | | | | | | | | | | | | | |
|-----------|---|---|------------|--|--|------|-------------|-----|-----|----------|---|-------|----|----------|---|---|----|----------|---|---|----|----------|--|---|----|----------|--|---|----|----------|--|---|----|
| Code | Description | Image | Code | Description | Components list | | | | | | | | | | | | | | | | | | | | | | | | | | | | |
| VT1325A | SP ELENA 557X364X4 EXTERNAL GLASS |  | KDR1282A | BL SHOP.PRO ELENA COMPLETE DOOR KIT | <table border="1"> <thead> <tr> <th>Code</th> <th>Description</th> <th>Qty</th> <th>UOM</th> </tr> </thead> <tbody> <tr> <td>VM2512A0</td> <td>BL SP DOOR-MICRO SWITCH SOFT CLOSING</td> <td>1</td> <td>PZ</td> </tr> <tr> <td>VM2527A0</td> <td>STYLUS PEN FOR SP</td> <td>1</td> <td>PZ</td> </tr> <tr> <td>VT1325A0</td> <td>SP ELENA 557X364X4 EXTERNAL GLASS</td> <td>1</td> <td>PZ</td> </tr> <tr> <td>VT1325A0</td> <td>SP ELENA 557X364X4 EXTERNAL GLASS</td> <td>1</td> <td>PZ</td> </tr> <tr> <td>VT1331A0</td> <td>SP ELENA 715X318.5X6 INNER GLASS</td> <td>1</td> <td>PZ</td> </tr> <tr> <td>VT1331A0</td> <td>SP ELENA 715X318.5X6 INNER GLASS</td> <td>1</td> <td>PZ</td> </tr> </tbody> </table> | Code | Description | Qty | UOM | VM2512A0 | BL SP DOOR-MICRO SWITCH SOFT CLOSING | 1 | PZ | VM2527A0 | STYLUS PEN FOR SP | 1 | PZ | VT1325A0 | SP ELENA 557X364X4 EXTERNAL GLASS | 1 | PZ | VT1325A0 | SP ELENA 557X364X4 EXTERNAL GLASS | 1 | PZ | VT1331A0 | SP ELENA 715X318.5X6 INNER GLASS | 1 | PZ | VT1331A0 | SP ELENA 715X318.5X6 INNER GLASS | 1 | PZ |
| Code | Description | Qty | UOM | | | | | | | | | | | | | | | | | | | | | | | | | | | | | | |
| VM2512A0 | BL SP DOOR-MICRO SWITCH SOFT CLOSING | 1 | PZ | | | | | | | | | | | | | | | | | | | | | | | | | | | | | | |
| VM2527A0 | STYLUS PEN FOR SP | 1 | PZ | | | | | | | | | | | | | | | | | | | | | | | | | | | | | | |
| VT1325A0 | SP ELENA 557X364X4 EXTERNAL GLASS | 1 | PZ | | | | | | | | | | | | | | | | | | | | | | | | | | | | | | |
| VT1325A0 | SP ELENA 557X364X4 EXTERNAL GLASS | 1 | PZ | | | | | | | | | | | | | | | | | | | | | | | | | | | | | | |
| VT1331A0 | SP ELENA 715X318.5X6 INNER GLASS | 1 | PZ | | | | | | | | | | | | | | | | | | | | | | | | | | | | | | |
| VT1331A0 | SP ELENA 715X318.5X6 INNER GLASS | 1 | PZ | | | | | | | | | | | | | | | | | | | | | | | | | | | | | | |
| 0B1294A | |  | 0B1294A0 | | | | | | | | | | | | | | | | | | | | | | | | | | | | | | |
| VM2474A | BL SP INT GLASS HINGE UPPER LOCK PIN |  | KVM2474A | BL SP INT GLASS HINGE UPPER LOCK PIN KIT | <table border="1"> <thead> <tr> <th>Code</th> <th>Description</th> <th>Qty</th> <th>UOM</th> </tr> </thead> <tbody> <tr> <td>VM1224A0</td> <td>65MY 220MM 2 COLOURS SHRINK TUBE</td> <td>0.150</td> <td>M</td> </tr> <tr> <td>VM2474A0</td> <td>BL SP INT GLASS HINGE UPPER LOCK PIN</td> <td>1</td> <td>PZ</td> </tr> <tr> <td>VM2474A0</td> <td>BL SP INT GLASS HINGE UPPER LOCK PIN</td> <td>1</td> <td>PZ</td> </tr> </tbody> </table> | Code | Description | Qty | UOM | VM1224A0 | 65MY 220MM 2 COLOURS SHRINK TUBE | 0.150 | M | VM2474A0 | BL SP INT GLASS HINGE UPPER LOCK PIN | 1 | PZ | VM2474A0 | BL SP INT GLASS HINGE UPPER LOCK PIN | 1 | PZ | | | | | | | | | | | | |
| Code | Description | Qty | UOM | | | | | | | | | | | | | | | | | | | | | | | | | | | | | | |
| VM1224A0 | 65MY 220MM 2 COLOURS SHRINK TUBE | 0.150 | M | | | | | | | | | | | | | | | | | | | | | | | | | | | | | | |
| VM2474A0 | BL SP INT GLASS HINGE UPPER LOCK PIN | 1 | PZ | | | | | | | | | | | | | | | | | | | | | | | | | | | | | | |
| VM2474A0 | BL SP INT GLASS HINGE UPPER LOCK PIN | 1 | PZ | | | | | | | | | | | | | | | | | | | | | | | | | | | | | | |
| VM2468A | BL SP LEFT UPPER LATERAL DOOR CA |  | KVM2468A | BL SP LEFT UPPER LATERAL DOOR CAP KIT | <table border="1"> <thead> <tr> <th>Code</th> <th>Description</th> <th>Qty</th> <th>UOM</th> </tr> </thead> <tbody> <tr> <td>VM1224A0</td> <td>65MY 220MM 2 COLOURS SHRINK TUBE</td> <td>0.300</td> <td>M</td> </tr> <tr> <td>VM2468A0</td> <td>BL SP LEFT UPPER LATERAL DOOR CAP</td> <td>1</td> <td>PZ</td> </tr> <tr> <td>VM2468A0</td> <td>BL SP LEFT UPPER LATERAL DOOR CAP</td> <td>1</td> <td>PZ</td> </tr> </tbody> </table> | Code | Description | Qty | UOM | VM1224A0 | 65MY 220MM 2 COLOURS SHRINK TUBE | 0.300 | M | VM2468A0 | BL SP LEFT UPPER LATERAL DOOR CAP | 1 | PZ | VM2468A0 | BL SP LEFT UPPER LATERAL DOOR CAP | 1 | PZ | | | | | | | | | | | | |
| Code | Description | Qty | UOM | | | | | | | | | | | | | | | | | | | | | | | | | | | | | | |
| VM1224A0 | 65MY 220MM 2 COLOURS SHRINK TUBE | 0.300 | M | | | | | | | | | | | | | | | | | | | | | | | | | | | | | | |
| VM2468A0 | BL SP LEFT UPPER LATERAL DOOR CAP | 1 | PZ | | | | | | | | | | | | | | | | | | | | | | | | | | | | | | |
| VM2468A0 | BL SP LEFT UPPER LATERAL DOOR CAP | 1 | PZ | | | | | | | | | | | | | | | | | | | | | | | | | | | | | | |

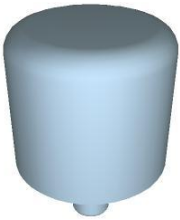
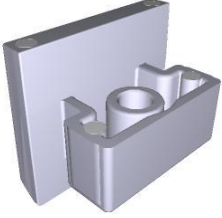

| COMPONENT | | | SPARE PART | | | | | | | | | | | | | | | | | | | | | | | | | | | | | | | | | | |
|-----------|--|---|------------|--|---|--|-------------|-----|-----|----------|--|---|----|----------|--|-------|----|----------|---|-------|----|----------|--|---|----|----------|--|---|----|----------|--|---|----|----------|--|---|----|
| Code | Description | Image | Code | Description | Components list | | | | | | | | | | | | | | | | | | | | | | | | | | | | | | | | |
| VM2472A | BL SP UPPER CLAMP INT LOCK GLASS SLIDER |  | KVM2471A | BL SP INTERNAL GLASS LOCK HOLDER KIT | <table border="1"> <thead> <tr> <th>Code</th> <th>Description</th> <th>Qty</th> <th>UOM</th> </tr> </thead> <tbody> <tr> <td>VI1930A0</td> <td>5X25 ST. STEEL SCREW CHIP</td> <td>2</td> <td>PZ</td> </tr> <tr> <td>VI1998A0</td> <td>ZINC PLATED SCREW 5X30 TCB</td> <td>2</td> <td>PZ</td> </tr> <tr> <td>VM1224A0</td> <td>65MY 220MM 2 COLOURS SHRINK TUBE</td> <td>0.150</td> <td>M</td> </tr> <tr> <td>VM2471A0</td> <td>BL SP LOWER CLAMP INT LOCK GLASS SLIDER</td> <td>1</td> <td>PZ</td> </tr> <tr> <td>VM2471A0</td> <td>BL SP LOWER CLAMP INT LOCK GLASS SLIDER</td> <td>1</td> <td>PZ</td> </tr> <tr> <td>VM2472A0</td> <td>BL SP UPPER CLAMP INT LOCK GLASS SLIDER</td> <td>1</td> <td>PZ</td> </tr> <tr> <td>VM2472A0</td> <td>BL SP UPPER CLAMP INT LOCK GLASS SLIDER</td> <td>1</td> <td>PZ</td> </tr> </tbody> </table> | Code | Description | Qty | UOM | VI1930A0 | 5X25 ST. STEEL SCREW CHIP | 2 | PZ | VI1998A0 | ZINC PLATED SCREW 5X30 TCB | 2 | PZ | VM1224A0 | 65MY 220MM 2 COLOURS SHRINK TUBE | 0.150 | M | VM2471A0 | BL SP LOWER CLAMP INT LOCK GLASS SLIDER | 1 | PZ | VM2471A0 | BL SP LOWER CLAMP INT LOCK GLASS SLIDER | 1 | PZ | VM2472A0 | BL SP UPPER CLAMP INT LOCK GLASS SLIDER | 1 | PZ | VM2472A0 | BL SP UPPER CLAMP INT LOCK GLASS SLIDER | 1 | PZ |
| | | | | | Code | Description | Qty | UOM | | | | | | | | | | | | | | | | | | | | | | | | | | | | | |
| | | | | | VI1930A0 | 5X25 ST. STEEL SCREW CHIP | 2 | PZ | | | | | | | | | | | | | | | | | | | | | | | | | | | | | |
| | | | | | VI1998A0 | ZINC PLATED SCREW 5X30 TCB | 2 | PZ | | | | | | | | | | | | | | | | | | | | | | | | | | | | | |
| | | | | | VM1224A0 | 65MY 220MM 2 COLOURS SHRINK TUBE | 0.150 | M | | | | | | | | | | | | | | | | | | | | | | | | | | | | | |
| | | | | | VM2471A0 | BL SP LOWER CLAMP INT LOCK GLASS SLIDER | 1 | PZ | | | | | | | | | | | | | | | | | | | | | | | | | | | | | |
| | | | | | VM2471A0 | BL SP LOWER CLAMP INT LOCK GLASS SLIDER | 1 | PZ | | | | | | | | | | | | | | | | | | | | | | | | | | | | | |
| | | | | | VM2472A0 | BL SP UPPER CLAMP INT LOCK GLASS SLIDER | 1 | PZ | | | | | | | | | | | | | | | | | | | | | | | | | | | | | |
| VM2472A0 | BL SP UPPER CLAMP INT LOCK GLASS SLIDER | 1 | PZ | | | | | | | | | | | | | | | | | | | | | | | | | | | | | | | | | | |
| ML1005A | DE5 DF0.6 H18 COMPRESSION SPRING |  | KVM2470A | BL SHOP.PRO INTERNAL GLASS LOCK 2PCS KIT | <table border="1"> <thead> <tr> <th>Code</th> <th>Description</th> <th>Qty</th> <th>UOM</th> </tr> </thead> <tbody> <tr> <td>ML1005A0</td> <td>DE5 DF0.6 H18 COMPRESSION N SPRING</td> <td>2</td> <td>PZ</td> </tr> <tr> <td>VM1224A0</td> <td>65MY 220MM 2 COLOURS SHRINK TUBE</td> <td>0.200</td> <td>M</td> </tr> <tr> <td>VM2470A0</td> <td>SLIDE TO FIX INTERNAL GLASS SHOP.PRO</td> <td>2</td> <td>PZ</td> </tr> <tr> <td>VM2470A0</td> <td>SLIDE TO FIX INTERNAL GLASS SHOP.PRO</td> <td>2</td> <td>PZ</td> </tr> <tr> <td>VM2504A0</td> <td>DOWEL TO GUIDE SLIDE SPRING SHOP.PRO</td> <td>2</td> <td>PZ</td> </tr> <tr> <td>VM2504A0</td> <td>DOWEL TO GUIDE SLIDE SPRING SHOP.PRO</td> <td>2</td> <td>PZ</td> </tr> </tbody> </table> | Code | Description | Qty | UOM | ML1005A0 | DE5 DF0.6 H18 COMPRESSION N SPRING | 2 | PZ | VM1224A0 | 65MY 220MM 2 COLOURS SHRINK TUBE | 0.200 | M | VM2470A0 | SLIDE TO FIX INTERNAL GLASS SHOP.PRO | 2 | PZ | VM2470A0 | SLIDE TO FIX INTERNAL GLASS SHOP.PRO | 2 | PZ | VM2504A0 | DOWEL TO GUIDE SLIDE SPRING SHOP.PRO | 2 | PZ | VM2504A0 | DOWEL TO GUIDE SLIDE SPRING SHOP.PRO | 2 | PZ | | | | |
| | | | | | Code | Description | Qty | UOM | | | | | | | | | | | | | | | | | | | | | | | | | | | | | |
| | | | | | ML1005A0 | DE5 DF0.6 H18 COMPRESSION N SPRING | 2 | PZ | | | | | | | | | | | | | | | | | | | | | | | | | | | | | |
| | | | | | VM1224A0 | 65MY 220MM 2 COLOURS SHRINK TUBE | 0.200 | M | | | | | | | | | | | | | | | | | | | | | | | | | | | | | |
| | | | | | VM2470A0 | SLIDE TO FIX INTERNAL GLASS SHOP.PRO | 2 | PZ | | | | | | | | | | | | | | | | | | | | | | | | | | | | | |
| | | | | | VM2470A0 | SLIDE TO FIX INTERNAL GLASS SHOP.PRO | 2 | PZ | | | | | | | | | | | | | | | | | | | | | | | | | | | | | |
| | | | | | VM2504A0 | DOWEL TO GUIDE SLIDE SPRING SHOP.PRO | 2 | PZ | | | | | | | | | | | | | | | | | | | | | | | | | | | | | |
| | | | | | VM2504A0 | DOWEL TO GUIDE SLIDE SPRING SHOP.PRO | 2 | PZ | | | | | | | | | | | | | | | | | | | | | | | | | | | | | |

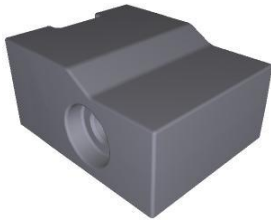

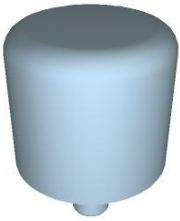
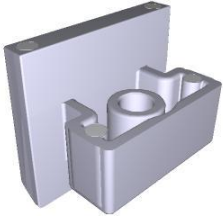
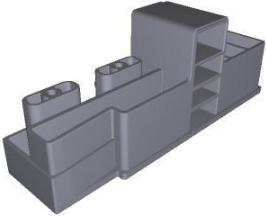

| COMPONENT | | | SPARE PART | | | | | | | | | | | | | | | | | | | | | | | | | | | | | | |
|-----------|---|---|------------|--|---|------|-------------|-----|-----|----------|---|---|----|----------|--|-------|---|----------|---|---|----|----------|---|---|----|----------|---|---|----|----------|---|---|----|
| Code | Description | Image | Code | Description | Components list | | | | | | | | | | | | | | | | | | | | | | | | | | | | |
| VM2504A | DOWEL TO GUIDE SLIDE SPRING SHOP.PRO |  | KVM2470A | BL SHOP.PRO INTERNAL GLASS LOCK 2PCS KIT | <table border="1"> <thead> <tr> <th>Code</th> <th>Description</th> <th>Qty</th> <th>UOM</th> </tr> </thead> <tbody> <tr> <td>ML1005A0</td> <td>DES DF0.6 H18 COMPRESSIO N SPRING</td> <td>2</td> <td>PZ</td> </tr> <tr> <td>VM1224A0</td> <td>65MY 220MM 2 COLOURS SHRINK TUBE</td> <td>0.200</td> <td>M</td> </tr> <tr> <td>VM2470A0</td> <td>SLIDE TO FIX INTERNAL GLASS SHOP.PRO</td> <td>2</td> <td>PZ</td> </tr> <tr> <td>VM2470A0</td> <td>SLIDE TO FIX INTERNAL GLASS SHOP.PRO</td> <td>2</td> <td>PZ</td> </tr> <tr> <td>VM2504A0</td> <td>DOWEL TO GUIDE SLIDE SPRING SHOP.PRO</td> <td>2</td> <td>PZ</td> </tr> <tr> <td>VM2504A0</td> <td>DOWEL TO GUIDE SLIDE SPRING SHOP.PRO</td> <td>2</td> <td>PZ</td> </tr> </tbody> </table> | Code | Description | Qty | UOM | ML1005A0 | DES DF0.6 H18 COMPRESSIO N SPRING | 2 | PZ | VM1224A0 | 65MY 220MM 2 COLOURS SHRINK TUBE | 0.200 | M | VM2470A0 | SLIDE TO FIX INTERNAL GLASS SHOP.PRO | 2 | PZ | VM2470A0 | SLIDE TO FIX INTERNAL GLASS SHOP.PRO | 2 | PZ | VM2504A0 | DOWEL TO GUIDE SLIDE SPRING SHOP.PRO | 2 | PZ | VM2504A0 | DOWEL TO GUIDE SLIDE SPRING SHOP.PRO | 2 | PZ |
| Code | Description | Qty | UOM | | | | | | | | | | | | | | | | | | | | | | | | | | | | | | |
| ML1005A0 | DES DF0.6 H18 COMPRESSIO N SPRING | 2 | PZ | | | | | | | | | | | | | | | | | | | | | | | | | | | | | | |
| VM1224A0 | 65MY 220MM 2 COLOURS SHRINK TUBE | 0.200 | M | | | | | | | | | | | | | | | | | | | | | | | | | | | | | | |
| VM2470A0 | SLIDE TO FIX INTERNAL GLASS SHOP.PRO | 2 | PZ | | | | | | | | | | | | | | | | | | | | | | | | | | | | | | |
| VM2470A0 | SLIDE TO FIX INTERNAL GLASS SHOP.PRO | 2 | PZ | | | | | | | | | | | | | | | | | | | | | | | | | | | | | | |
| VM2504A0 | DOWEL TO GUIDE SLIDE SPRING SHOP.PRO | 2 | PZ | | | | | | | | | | | | | | | | | | | | | | | | | | | | | | |
| VM2504A0 | DOWEL TO GUIDE SLIDE SPRING SHOP.PRO | 2 | PZ | | | | | | | | | | | | | | | | | | | | | | | | | | | | | | |
| VM2470A | SLIDE TO FIX INTERNAL GLASS SHOP.PRO |  | KVM2470A | BL SHOP.PRO INTERNAL GLASS LOCK 2PCS KIT | <table border="1"> <thead> <tr> <th>Code</th> <th>Description</th> <th>Qty</th> <th>UOM</th> </tr> </thead> <tbody> <tr> <td>ML1005A0</td> <td>DES DF0.6 H18 COMPRESSIO N SPRING</td> <td>2</td> <td>PZ</td> </tr> <tr> <td>VM1224A0</td> <td>65MY 220MM 2 COLOURS SHRINK TUBE</td> <td>0.200</td> <td>M</td> </tr> <tr> <td>VM2470A0</td> <td>SLIDE TO FIX INTERNAL GLASS SHOP.PRO</td> <td>2</td> <td>PZ</td> </tr> <tr> <td>VM2470A0</td> <td>SLIDE TO FIX INTERNAL GLASS SHOP.PRO</td> <td>2</td> <td>PZ</td> </tr> <tr> <td>VM2504A0</td> <td>DOWEL TO GUIDE SLIDE SPRING SHOP.PRO</td> <td>2</td> <td>PZ</td> </tr> <tr> <td>VM2504A0</td> <td>DOWEL TO GUIDE SLIDE SPRING SHOP.PRO</td> <td>2</td> <td>PZ</td> </tr> </tbody> </table> | Code | Description | Qty | UOM | ML1005A0 | DES DF0.6 H18 COMPRESSIO N SPRING | 2 | PZ | VM1224A0 | 65MY 220MM 2 COLOURS SHRINK TUBE | 0.200 | M | VM2470A0 | SLIDE TO FIX INTERNAL GLASS SHOP.PRO | 2 | PZ | VM2470A0 | SLIDE TO FIX INTERNAL GLASS SHOP.PRO | 2 | PZ | VM2504A0 | DOWEL TO GUIDE SLIDE SPRING SHOP.PRO | 2 | PZ | VM2504A0 | DOWEL TO GUIDE SLIDE SPRING SHOP.PRO | 2 | PZ |
| Code | Description | Qty | UOM | | | | | | | | | | | | | | | | | | | | | | | | | | | | | | |
| ML1005A0 | DES DF0.6 H18 COMPRESSIO N SPRING | 2 | PZ | | | | | | | | | | | | | | | | | | | | | | | | | | | | | | |
| VM1224A0 | 65MY 220MM 2 COLOURS SHRINK TUBE | 0.200 | M | | | | | | | | | | | | | | | | | | | | | | | | | | | | | | |
| VM2470A0 | SLIDE TO FIX INTERNAL GLASS SHOP.PRO | 2 | PZ | | | | | | | | | | | | | | | | | | | | | | | | | | | | | | |
| VM2470A0 | SLIDE TO FIX INTERNAL GLASS SHOP.PRO | 2 | PZ | | | | | | | | | | | | | | | | | | | | | | | | | | | | | | |
| VM2504A0 | DOWEL TO GUIDE SLIDE SPRING SHOP.PRO | 2 | PZ | | | | | | | | | | | | | | | | | | | | | | | | | | | | | | |
| VM2504A0 | DOWEL TO GUIDE SLIDE SPRING SHOP.PRO | 2 | PZ | | | | | | | | | | | | | | | | | | | | | | | | | | | | | | |

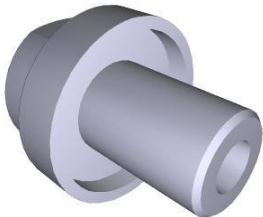
| COMPONENT | | | SPARE PART | | | | | | | | | | | | | | | | | | | | | | |
|-----------|--|---|------------|--|--|------|-------------|-----|-----|----------|----------------------------------|-------|----|----------|--|---|----|----------|--|-------|----|----------|---|---|----|
| Code | Description | Image | Code | Description | Components list | | | | | | | | | | | | | | | | | | | | |
| VM2467A | SP SIDE-OPENING DOOR RIGHT UPPER CAP KIT |  | KVM2467A | BL SP RIGHT UPPER LATERAL DOOR CAP KIT | <table border="1"> <thead> <tr> <th>Code</th> <th>Description</th> <th>Qty</th> <th>UOM</th> </tr> </thead> <tbody> <tr> <td>VM1224A0</td> <td>65MY 220MM 2 COLOURS SHRINK TUBE</td> <td>0.300</td> <td>M</td> </tr> <tr> <td>VM2467A0</td> <td>SP SIDE-OPENING DOOR RIGHT UPPER CAP KIT</td> <td>1</td> <td>PZ</td> </tr> <tr> <td>VM2467A0</td> <td>SP SIDE-OPENING DOOR RIGHT UPPER CAP KIT</td> <td>1</td> <td>PZ</td> </tr> </tbody> </table> | Code | Description | Qty | UOM | VM1224A0 | 65MY 220MM 2 COLOURS SHRINK TUBE | 0.300 | M | VM2467A0 | SP SIDE-OPENING DOOR RIGHT UPPER CAP KIT | 1 | PZ | VM2467A0 | SP SIDE-OPENING DOOR RIGHT UPPER CAP KIT | 1 | PZ | | | | |
| Code | Description | Qty | UOM | | | | | | | | | | | | | | | | | | | | | | |
| VM1224A0 | 65MY 220MM 2 COLOURS SHRINK TUBE | 0.300 | M | | | | | | | | | | | | | | | | | | | | | | |
| VM2467A0 | SP SIDE-OPENING DOOR RIGHT UPPER CAP KIT | 1 | PZ | | | | | | | | | | | | | | | | | | | | | | |
| VM2467A0 | SP SIDE-OPENING DOOR RIGHT UPPER CAP KIT | 1 | PZ | | | | | | | | | | | | | | | | | | | | | | |
| VM2473A | BL SP INT GLASS HINGE LOWER LOCK PIN |  | KVM2473A | BL SP INT GLASS HINGE LOWER LOCK PIN KIT | <table border="1"> <thead> <tr> <th>Code</th> <th>Description</th> <th>Qty</th> <th>UOM</th> </tr> </thead> <tbody> <tr> <td>VM1224A0</td> <td>65MY 220MM 2 COLOURS SHRINK TUBE</td> <td>0.150</td> <td>M</td> </tr> <tr> <td>VM2473A0</td> <td>BL SP INT GLASS HINGE LOWER LOCK PIN</td> <td>1</td> <td>PZ</td> </tr> <tr> <td>VM2473A0</td> <td>BL SP INT GLASS HINGE LOWER LOCK PIN</td> <td>1</td> <td>PZ</td> </tr> </tbody> </table> | Code | Description | Qty | UOM | VM1224A0 | 65MY 220MM 2 COLOURS SHRINK TUBE | 0.150 | M | VM2473A0 | BL SP INT GLASS HINGE LOWER LOCK PIN | 1 | PZ | VM2473A0 | BL SP INT GLASS HINGE LOWER LOCK PIN | 1 | PZ | | | | |
| Code | Description | Qty | UOM | | | | | | | | | | | | | | | | | | | | | | |
| VM1224A0 | 65MY 220MM 2 COLOURS SHRINK TUBE | 0.150 | M | | | | | | | | | | | | | | | | | | | | | | |
| VM2473A0 | BL SP INT GLASS HINGE LOWER LOCK PIN | 1 | PZ | | | | | | | | | | | | | | | | | | | | | | |
| VM2473A0 | BL SP INT GLASS HINGE LOWER LOCK PIN | 1 | PZ | | | | | | | | | | | | | | | | | | | | | | |
| VM2466A | BL SP LEFT LOWER LATERAL DOOR CA |  | KVM2466A | BL SP LEFT LOWER LATERAL DOOR CAP KIT | <table border="1"> <thead> <tr> <th>Code</th> <th>Description</th> <th>Qty</th> <th>UOM</th> </tr> </thead> <tbody> <tr> <td>VM1224A0</td> <td>65MY 220MM 2 COLOURS SHRINK TUBE</td> <td>0.300</td> <td>M</td> </tr> <tr> <td>VM2466A0</td> <td>BL SP LEFT LOWER LATERAL DOOR CAP</td> <td>1</td> <td>PZ</td> </tr> <tr> <td>VM2466A0</td> <td>BL SP LEFT LOWER LATERAL DOOR CAP</td> <td>1</td> <td>PZ</td> </tr> </tbody> </table> | Code | Description | Qty | UOM | VM1224A0 | 65MY 220MM 2 COLOURS SHRINK TUBE | 0.300 | M | VM2466A0 | BL SP LEFT LOWER LATERAL DOOR CAP | 1 | PZ | VM2466A0 | BL SP LEFT LOWER LATERAL DOOR CAP | 1 | PZ | | | | |
| Code | Description | Qty | UOM | | | | | | | | | | | | | | | | | | | | | | |
| VM1224A0 | 65MY 220MM 2 COLOURS SHRINK TUBE | 0.300 | M | | | | | | | | | | | | | | | | | | | | | | |
| VM2466A0 | BL SP LEFT LOWER LATERAL DOOR CAP | 1 | PZ | | | | | | | | | | | | | | | | | | | | | | |
| VM2466A0 | BL SP LEFT LOWER LATERAL DOOR CAP | 1 | PZ | | | | | | | | | | | | | | | | | | | | | | |
| VM2471A | BL SP LOWER CLAMP INT LOCK GLASS SLIDER |  | KVM2471A | BL SP INTERNAL GLASS LOCK HOLDER KIT | <table border="1"> <thead> <tr> <th>Code</th> <th>Description</th> <th>Qty</th> <th>UOM</th> </tr> </thead> <tbody> <tr> <td>VI1930A0</td> <td>5X25 ST. STEEL SCREW CHIP</td> <td>2</td> <td>PZ</td> </tr> <tr> <td>VI1998A0</td> <td>ZINC PLATED SCREW 5X30 TCB</td> <td>2</td> <td>PZ</td> </tr> <tr> <td>VM1224A0</td> <td>65MY 220MM 2 COLOURS SHRINK TUBE</td> <td>0.150</td> <td>M</td> </tr> <tr> <td>VM2471A0</td> <td>BL SP LOWER CLAMP INT LOCK GLASS SLIDER</td> <td>1</td> <td>PZ</td> </tr> </tbody> </table> | Code | Description | Qty | UOM | VI1930A0 | 5X25 ST. STEEL SCREW CHIP | 2 | PZ | VI1998A0 | ZINC PLATED SCREW 5X30 TCB | 2 | PZ | VM1224A0 | 65MY 220MM 2 COLOURS SHRINK TUBE | 0.150 | M | VM2471A0 | BL SP LOWER CLAMP INT LOCK GLASS SLIDER | 1 | PZ |
| Code | Description | Qty | UOM | | | | | | | | | | | | | | | | | | | | | | |
| VI1930A0 | 5X25 ST. STEEL SCREW CHIP | 2 | PZ | | | | | | | | | | | | | | | | | | | | | | |
| VI1998A0 | ZINC PLATED SCREW 5X30 TCB | 2 | PZ | | | | | | | | | | | | | | | | | | | | | | |
| VM1224A0 | 65MY 220MM 2 COLOURS SHRINK TUBE | 0.150 | M | | | | | | | | | | | | | | | | | | | | | | |
| VM2471A0 | BL SP LOWER CLAMP INT LOCK GLASS SLIDER | 1 | PZ | | | | | | | | | | | | | | | | | | | | | | |



| COMPONENT | | | SPARE PART | | | | | | | | | | | | | | | | | | | | | | | | | | | | | | |
|-----------|--|---|------------|--|--|------|-------------|-----|-----|----------|--|---|----|----------|--|-------|----|----------|--|---|----|----------|---|---|----|----------|---|---|----|----------|---|---|----|
| Code | Description | Image | Code | Description | Components list | | | | | | | | | | | | | | | | | | | | | | | | | | | | |
| VM2471A | BL SP LOWER CLAMP INT LOCK GLASS SLIDER |  | KVM2471A | BL SP INTERNAL GLASS LOCK HOLDER KIT | <table border="1"> <thead> <tr> <th>Code</th> <th>Description</th> <th>Qty</th> <th>UOM</th> </tr> </thead> <tbody> <tr> <td>VM2471A0</td> <td>BL SP LOWER CLAMP INT LOCK GLASS SLIDER</td> <td>1</td> <td>PZ</td> </tr> <tr> <td>VM2472A0</td> <td>BL SP UPPER CLAMP INT LOCK GLASS SLIDER</td> <td>1</td> <td>PZ</td> </tr> <tr> <td>VM2472A0</td> <td>BL SP UPPER CLAMP INT LOCK GLASS SLIDER</td> <td>1</td> <td>PZ</td> </tr> </tbody> </table> | Code | Description | Qty | UOM | VM2471A0 | BL SP LOWER CLAMP INT LOCK GLASS SLIDER | 1 | PZ | VM2472A0 | BL SP UPPER CLAMP INT LOCK GLASS SLIDER | 1 | PZ | VM2472A0 | BL SP UPPER CLAMP INT LOCK GLASS SLIDER | 1 | PZ | | | | | | | | | | | | |
| Code | Description | Qty | UOM | | | | | | | | | | | | | | | | | | | | | | | | | | | | | | |
| VM2471A0 | BL SP LOWER CLAMP INT LOCK GLASS SLIDER | 1 | PZ | | | | | | | | | | | | | | | | | | | | | | | | | | | | | | |
| VM2472A0 | BL SP UPPER CLAMP INT LOCK GLASS SLIDER | 1 | PZ | | | | | | | | | | | | | | | | | | | | | | | | | | | | | | |
| VM2472A0 | BL SP UPPER CLAMP INT LOCK GLASS SLIDER | 1 | PZ | | | | | | | | | | | | | | | | | | | | | | | | | | | | | | |
| ML1005A | DE5 DF0.6 H18 COMPRESSION SPRING |  | KVM2470A | BL SHOP.PRO INTERNAL GLASS LOCK 2PCS KIT | <table border="1"> <thead> <tr> <th>Code</th> <th>Description</th> <th>Qty</th> <th>UOM</th> </tr> </thead> <tbody> <tr> <td>ML1005A0</td> <td>DE5 DF0.6 H18 COMPRESSION N SPRING</td> <td>2</td> <td>PZ</td> </tr> <tr> <td>VM1224A0</td> <td>65MY 220MM 2 COLOURS SHRINK TUBE</td> <td>0.200</td> <td>M</td> </tr> <tr> <td>VM2470A0</td> <td>SLIDE TO FIX INTERNAL GLASS SHOP.PRO</td> <td>2</td> <td>PZ</td> </tr> <tr> <td>VM2470A0</td> <td>SLIDE TO FIX INTERNAL GLASS SHOP.PRO</td> <td>2</td> <td>PZ</td> </tr> <tr> <td>VM2504A0</td> <td>DOWEL TO GUIDE SLIDE SPRING SHOP.PRO</td> <td>2</td> <td>PZ</td> </tr> <tr> <td>VM2504A0</td> <td>DOWEL TO GUIDE SLIDE SPRING SHOP.PRO</td> <td>2</td> <td>PZ</td> </tr> </tbody> </table> | Code | Description | Qty | UOM | ML1005A0 | DE5 DF0.6 H18 COMPRESSION N SPRING | 2 | PZ | VM1224A0 | 65MY 220MM 2 COLOURS SHRINK TUBE | 0.200 | M | VM2470A0 | SLIDE TO FIX INTERNAL GLASS SHOP.PRO | 2 | PZ | VM2470A0 | SLIDE TO FIX INTERNAL GLASS SHOP.PRO | 2 | PZ | VM2504A0 | DOWEL TO GUIDE SLIDE SPRING SHOP.PRO | 2 | PZ | VM2504A0 | DOWEL TO GUIDE SLIDE SPRING SHOP.PRO | 2 | PZ |
| Code | Description | Qty | UOM | | | | | | | | | | | | | | | | | | | | | | | | | | | | | | |
| ML1005A0 | DE5 DF0.6 H18 COMPRESSION N SPRING | 2 | PZ | | | | | | | | | | | | | | | | | | | | | | | | | | | | | | |
| VM1224A0 | 65MY 220MM 2 COLOURS SHRINK TUBE | 0.200 | M | | | | | | | | | | | | | | | | | | | | | | | | | | | | | | |
| VM2470A0 | SLIDE TO FIX INTERNAL GLASS SHOP.PRO | 2 | PZ | | | | | | | | | | | | | | | | | | | | | | | | | | | | | | |
| VM2470A0 | SLIDE TO FIX INTERNAL GLASS SHOP.PRO | 2 | PZ | | | | | | | | | | | | | | | | | | | | | | | | | | | | | | |
| VM2504A0 | DOWEL TO GUIDE SLIDE SPRING SHOP.PRO | 2 | PZ | | | | | | | | | | | | | | | | | | | | | | | | | | | | | | |
| VM2504A0 | DOWEL TO GUIDE SLIDE SPRING SHOP.PRO | 2 | PZ | | | | | | | | | | | | | | | | | | | | | | | | | | | | | | |
| VM2504A | DOWEL TO GUIDE SLIDE SPRING SHOP.PRO |  | KVM2470A | BL SHOP.PRO INTERNAL GLASS LOCK 2PCS KIT | <table border="1"> <thead> <tr> <th>Code</th> <th>Description</th> <th>Qty</th> <th>UOM</th> </tr> </thead> <tbody> <tr> <td>ML1005A0</td> <td>DE5 DF0.6 H18 COMPRESSION N SPRING</td> <td>2</td> <td>PZ</td> </tr> <tr> <td>VM1224A0</td> <td>65MY 220MM 2 COLOURS SHRINK TUBE</td> <td>0.200</td> <td>M</td> </tr> <tr> <td>VM2470A0</td> <td>SLIDE TO FIX INTERNAL GLASS SHOP.PRO</td> <td>2</td> <td>PZ</td> </tr> <tr> <td>VM2470A0</td> <td>SLIDE TO FIX INTERNAL GLASS SHOP.PRO</td> <td>2</td> <td>PZ</td> </tr> </tbody> </table> | Code | Description | Qty | UOM | ML1005A0 | DE5 DF0.6 H18 COMPRESSION N SPRING | 2 | PZ | VM1224A0 | 65MY 220MM 2 COLOURS SHRINK TUBE | 0.200 | M | VM2470A0 | SLIDE TO FIX INTERNAL GLASS SHOP.PRO | 2 | PZ | VM2470A0 | SLIDE TO FIX INTERNAL GLASS SHOP.PRO | 2 | PZ | | | | | | | | |
| Code | Description | Qty | UOM | | | | | | | | | | | | | | | | | | | | | | | | | | | | | | |
| ML1005A0 | DE5 DF0.6 H18 COMPRESSION N SPRING | 2 | PZ | | | | | | | | | | | | | | | | | | | | | | | | | | | | | | |
| VM1224A0 | 65MY 220MM 2 COLOURS SHRINK TUBE | 0.200 | M | | | | | | | | | | | | | | | | | | | | | | | | | | | | | | |
| VM2470A0 | SLIDE TO FIX INTERNAL GLASS SHOP.PRO | 2 | PZ | | | | | | | | | | | | | | | | | | | | | | | | | | | | | | |
| VM2470A0 | SLIDE TO FIX INTERNAL GLASS SHOP.PRO | 2 | PZ | | | | | | | | | | | | | | | | | | | | | | | | | | | | | | |

| COMPONENT | | | SPARE PART | | | | | | | | | | | | | | | | | | | | | | | | | | | | | | |
|-----------|---|---|------------|--|---|------|-------------|-----|-----|----------|---|-------|----|----------|---|-------|----|----------|---|---|----|----------|---|---|----|----------|---|---|----|----------|---|---|----|
| Code | Description | Image | Code | Description | Components list | | | | | | | | | | | | | | | | | | | | | | | | | | | | |
| VM2504A | DOWEL TO GUIDE SLIDE SPRING SHOP.PRO |  | KVM2470A | BL SHOP.PRO INTERNAL GLASS LOCK 2PCS KIT | <table border="1"> <thead> <tr> <th>Code</th> <th>Description</th> <th>Qty</th> <th>UOM</th> </tr> </thead> <tbody> <tr> <td>VM2504A0</td> <td>DOWEL TO GUIDE SLIDE SPRING SHOP.PRO</td> <td>2</td> <td>PZ</td> </tr> <tr> <td>VM2504A0</td> <td>DOWEL TO GUIDE SLIDE SPRING SHOP.PRO</td> <td>2</td> <td>PZ</td> </tr> </tbody> </table> | Code | Description | Qty | UOM | VM2504A0 | DOWEL TO GUIDE SLIDE SPRING SHOP.PRO | 2 | PZ | VM2504A0 | DOWEL TO GUIDE SLIDE SPRING SHOP.PRO | 2 | PZ | | | | | | | | | | | | | | | | |
| Code | Description | Qty | UOM | | | | | | | | | | | | | | | | | | | | | | | | | | | | | | |
| VM2504A0 | DOWEL TO GUIDE SLIDE SPRING SHOP.PRO | 2 | PZ | | | | | | | | | | | | | | | | | | | | | | | | | | | | | | |
| VM2504A0 | DOWEL TO GUIDE SLIDE SPRING SHOP.PRO | 2 | PZ | | | | | | | | | | | | | | | | | | | | | | | | | | | | | | |
| VM2470A | SLIDE TO FIX INTERNAL GLASS SHOP.PRO |  | KVM2470A | BL SHOP.PRO INTERNAL GLASS LOCK 2PCS KIT | <table border="1"> <thead> <tr> <th>Code</th> <th>Description</th> <th>Qty</th> <th>UOM</th> </tr> </thead> <tbody> <tr> <td>ML1005A0</td> <td>DE5 DF0.6 H18 COMPRESSIO N SPRING</td> <td>2</td> <td>PZ</td> </tr> <tr> <td>VM1224A0</td> <td>65MY 220MM 2 COLOURS SHRINK TUBE</td> <td>0.200</td> <td>M</td> </tr> <tr> <td>VM2470A0</td> <td>SLIDE TO FIX INTERNAL GLASS SHOP.PRO</td> <td>2</td> <td>PZ</td> </tr> <tr> <td>VM2470A0</td> <td>SLIDE TO FIX INTERNAL GLASS SHOP.PRO</td> <td>2</td> <td>PZ</td> </tr> <tr> <td>VM2504A0</td> <td>DOWEL TO GUIDE SLIDE SPRING SHOP.PRO</td> <td>2</td> <td>PZ</td> </tr> <tr> <td>VM2504A0</td> <td>DOWEL TO GUIDE SLIDE SPRING SHOP.PRO</td> <td>2</td> <td>PZ</td> </tr> </tbody> </table> | Code | Description | Qty | UOM | ML1005A0 | DE5 DF0.6 H18 COMPRESSIO N SPRING | 2 | PZ | VM1224A0 | 65MY 220MM 2 COLOURS SHRINK TUBE | 0.200 | M | VM2470A0 | SLIDE TO FIX INTERNAL GLASS SHOP.PRO | 2 | PZ | VM2470A0 | SLIDE TO FIX INTERNAL GLASS SHOP.PRO | 2 | PZ | VM2504A0 | DOWEL TO GUIDE SLIDE SPRING SHOP.PRO | 2 | PZ | VM2504A0 | DOWEL TO GUIDE SLIDE SPRING SHOP.PRO | 2 | PZ |
| Code | Description | Qty | UOM | | | | | | | | | | | | | | | | | | | | | | | | | | | | | | |
| ML1005A0 | DE5 DF0.6 H18 COMPRESSIO N SPRING | 2 | PZ | | | | | | | | | | | | | | | | | | | | | | | | | | | | | | |
| VM1224A0 | 65MY 220MM 2 COLOURS SHRINK TUBE | 0.200 | M | | | | | | | | | | | | | | | | | | | | | | | | | | | | | | |
| VM2470A0 | SLIDE TO FIX INTERNAL GLASS SHOP.PRO | 2 | PZ | | | | | | | | | | | | | | | | | | | | | | | | | | | | | | |
| VM2470A0 | SLIDE TO FIX INTERNAL GLASS SHOP.PRO | 2 | PZ | | | | | | | | | | | | | | | | | | | | | | | | | | | | | | |
| VM2504A0 | DOWEL TO GUIDE SLIDE SPRING SHOP.PRO | 2 | PZ | | | | | | | | | | | | | | | | | | | | | | | | | | | | | | |
| VM2504A0 | DOWEL TO GUIDE SLIDE SPRING SHOP.PRO | 2 | PZ | | | | | | | | | | | | | | | | | | | | | | | | | | | | | | |
| VM2465A | SP SIDE-OPENING DOOR RIGHT LOWER CAP KIT |  | KVM2465A | BL SP RIGHT LOWER LATERAL DOOR CAP KIT | <table border="1"> <thead> <tr> <th>Code</th> <th>Description</th> <th>Qty</th> <th>UOM</th> </tr> </thead> <tbody> <tr> <td>VM1224A0</td> <td>65MY 220MM 2 COLOURS SHRINK TUBE</td> <td>0.300</td> <td>M</td> </tr> <tr> <td>VM2465A0</td> <td>SP SIDE-OPENIN G DOOR RIGHT LOWER CAP KIT</td> <td>1</td> <td>PZ</td> </tr> <tr> <td>VM2465A0</td> <td>SP SIDE-OPENIN G DOOR RIGHT LOWER CAP KIT</td> <td>1</td> <td>PZ</td> </tr> </tbody> </table> | Code | Description | Qty | UOM | VM1224A0 | 65MY 220MM 2 COLOURS SHRINK TUBE | 0.300 | M | VM2465A0 | SP SIDE-OPENIN G DOOR RIGHT LOWER CAP KIT | 1 | PZ | VM2465A0 | SP SIDE-OPENIN G DOOR RIGHT LOWER CAP KIT | 1 | PZ | | | | | | | | | | | | |
| Code | Description | Qty | UOM | | | | | | | | | | | | | | | | | | | | | | | | | | | | | | |
| VM1224A0 | 65MY 220MM 2 COLOURS SHRINK TUBE | 0.300 | M | | | | | | | | | | | | | | | | | | | | | | | | | | | | | | |
| VM2465A0 | SP SIDE-OPENIN G DOOR RIGHT LOWER CAP KIT | 1 | PZ | | | | | | | | | | | | | | | | | | | | | | | | | | | | | | |
| VM2465A0 | SP SIDE-OPENIN G DOOR RIGHT LOWER CAP KIT | 1 | PZ | | | | | | | | | | | | | | | | | | | | | | | | | | | | | | |

| COMPONENT | | | SPARE PART | | | | | | | | | | | | | | | | | | | | | | | | | | | | | | | | | | | | | | | | | | | | | | | | | | |
|-----------|--|---|------------|--|--|------|-------------|-----|-----|----------|---|---|----|----------|---|-------|----|----------|--|---|---|----------|---|---|----|----------|--------------------------|---|---|----------|--|---|----|----------|--|---|----|----------|---|---|----|----------|---|---|----|----------|--|---|----|----------|--|---|----|
| Code | Description | Image | Code | Description | Components list | | | | | | | | | | | | | | | | | | | | | | | | | | | | | | | | | | | | | | | | | | | | | | | | |
| VM1209A | SHOP.PRO LOCK PIN WASHER |  | KVM1209A | BAKERLUX SHOP.PRO PIN BUSHING LOCK KIT | <table border="1"> <thead> <tr> <th>Code</th> <th>Description</th> <th>Qty</th> <th>UOM</th> </tr> </thead> <tbody> <tr> <td>VM1209A0</td> <td>SHOP.PRO LOCK PIN WASHER</td> <td>1</td> <td>PZ</td> </tr> <tr> <td>VM1224A0</td> <td>65MY 220MM 2 COLOURS SHRINK TUBE</td> <td>0.150</td> <td>M</td> </tr> </tbody> </table> | Code | Description | Qty | UOM | VM1209A0 | SHOP.PRO LOCK PIN WASHER | 1 | PZ | VM1224A0 | 65MY 220MM 2 COLOURS SHRINK TUBE | 0.150 | M | | | | | | | | | | | | | | | | | | | | | | | | | | | | | | | | | | | | |
| Code | Description | Qty | UOM | | | | | | | | | | | | | | | | | | | | | | | | | | | | | | | | | | | | | | | | | | | | | | | | | | |
| VM1209A0 | SHOP.PRO LOCK PIN WASHER | 1 | PZ | | | | | | | | | | | | | | | | | | | | | | | | | | | | | | | | | | | | | | | | | | | | | | | | | | |
| VM1224A0 | 65MY 220MM 2 COLOURS SHRINK TUBE | 0.150 | M | | | | | | | | | | | | | | | | | | | | | | | | | | | | | | | | | | | | | | | | | | | | | | | | | | |
| VT1346A | SP ELENA FLAG DOOR INNER GLASS+HINGES |  | KVT1346A | BL SP ELENA INT LATERAL GLASS KIT | <table border="1"> <thead> <tr> <th>Code</th> <th>Description</th> <th>Qty</th> <th>UOM</th> </tr> </thead> <tbody> <tr> <td>CR1103A0</td> <td>INTERNAL GLASS ST. STEEL UPPER HINGE</td> <td>1</td> <td>PZ</td> </tr> <tr> <td>CR1104A0</td> <td>INTERNAL GLASS ST. STEEL LOWER HINGE</td> <td>1</td> <td>PZ</td> </tr> <tr> <td>IP1385A1</td> <td>CORNER POLYSTYREN E PACKING 110X80X2000</td> <td>1</td> <td>M</td> </tr> <tr> <td>VI1810A0</td> <td>M6X6 STAINLESS STEEL FLATHEAD SCREW</td> <td>6</td> <td>PZ</td> </tr> <tr> <td>VM1059A1</td> <td>HEAT SHRINK FILM H800</td> <td>1</td> <td>M</td> </tr> <tr> <td>VM2399A0</td> <td>DOOR HINGES HEADLESS SCREWS COVER</td> <td>2</td> <td>PZ</td> </tr> <tr> <td>VM2399A0</td> <td>DOOR HINGES HEADLESS SCREWS COVER</td> <td>2</td> <td>PZ</td> </tr> <tr> <td>VM2476A0</td> <td>BL SP H6 INTERNAL GLASS HINGE GASKET</td> <td>2</td> <td>PZ</td> </tr> <tr> <td>VM2476A0</td> <td>BL SP H6 INTERNAL GLASS HINGE GASKET</td> <td>2</td> <td>PZ</td> </tr> <tr> <td>VT1331A0</td> <td>SP ELENA 715X318.5X6 INNER GLASS</td> <td>1</td> <td>PZ</td> </tr> <tr> <td>VT1331A0</td> <td>SP ELENA 715X318.5X6 INNER GLASS</td> <td>1</td> <td>PZ</td> </tr> </tbody> </table> | Code | Description | Qty | UOM | CR1103A0 | INTERNAL GLASS ST. STEEL UPPER HINGE | 1 | PZ | CR1104A0 | INTERNAL GLASS ST. STEEL LOWER HINGE | 1 | PZ | IP1385A1 | CORNER POLYSTYREN E PACKING 110X80X2000 | 1 | M | VI1810A0 | M6X6 STAINLESS STEEL FLATHEAD SCREW | 6 | PZ | VM1059A1 | HEAT SHRINK FILM H800 | 1 | M | VM2399A0 | DOOR HINGES HEADLESS SCREWS COVER | 2 | PZ | VM2399A0 | DOOR HINGES HEADLESS SCREWS COVER | 2 | PZ | VM2476A0 | BL SP H6 INTERNAL GLASS HINGE GASKET | 2 | PZ | VM2476A0 | BL SP H6 INTERNAL GLASS HINGE GASKET | 2 | PZ | VT1331A0 | SP ELENA 715X318.5X6 INNER GLASS | 1 | PZ | VT1331A0 | SP ELENA 715X318.5X6 INNER GLASS | 1 | PZ |
| Code | Description | Qty | UOM | | | | | | | | | | | | | | | | | | | | | | | | | | | | | | | | | | | | | | | | | | | | | | | | | | |
| CR1103A0 | INTERNAL GLASS ST. STEEL UPPER HINGE | 1 | PZ | | | | | | | | | | | | | | | | | | | | | | | | | | | | | | | | | | | | | | | | | | | | | | | | | | |
| CR1104A0 | INTERNAL GLASS ST. STEEL LOWER HINGE | 1 | PZ | | | | | | | | | | | | | | | | | | | | | | | | | | | | | | | | | | | | | | | | | | | | | | | | | | |
| IP1385A1 | CORNER POLYSTYREN E PACKING 110X80X2000 | 1 | M | | | | | | | | | | | | | | | | | | | | | | | | | | | | | | | | | | | | | | | | | | | | | | | | | | |
| VI1810A0 | M6X6 STAINLESS STEEL FLATHEAD SCREW | 6 | PZ | | | | | | | | | | | | | | | | | | | | | | | | | | | | | | | | | | | | | | | | | | | | | | | | | | |
| VM1059A1 | HEAT SHRINK FILM H800 | 1 | M | | | | | | | | | | | | | | | | | | | | | | | | | | | | | | | | | | | | | | | | | | | | | | | | | | |
| VM2399A0 | DOOR HINGES HEADLESS SCREWS COVER | 2 | PZ | | | | | | | | | | | | | | | | | | | | | | | | | | | | | | | | | | | | | | | | | | | | | | | | | | |
| VM2399A0 | DOOR HINGES HEADLESS SCREWS COVER | 2 | PZ | | | | | | | | | | | | | | | | | | | | | | | | | | | | | | | | | | | | | | | | | | | | | | | | | | |
| VM2476A0 | BL SP H6 INTERNAL GLASS HINGE GASKET | 2 | PZ | | | | | | | | | | | | | | | | | | | | | | | | | | | | | | | | | | | | | | | | | | | | | | | | | | |
| VM2476A0 | BL SP H6 INTERNAL GLASS HINGE GASKET | 2 | PZ | | | | | | | | | | | | | | | | | | | | | | | | | | | | | | | | | | | | | | | | | | | | | | | | | | |
| VT1331A0 | SP ELENA 715X318.5X6 INNER GLASS | 1 | PZ | | | | | | | | | | | | | | | | | | | | | | | | | | | | | | | | | | | | | | | | | | | | | | | | | | |
| VT1331A0 | SP ELENA 715X318.5X6 INNER GLASS | 1 | PZ | | | | | | | | | | | | | | | | | | | | | | | | | | | | | | | | | | | | | | | | | | | | | | | | | | |

| COMPONENT | | | SPARE PART | | | | | | | | | | | | | | | | | | | | | | | | | | | | | | |
|-----------|--|---|------------|--|--|------|-------------|-----|-----|----------|--|---|----|----------|----------------------------------|-------|----|----------|------------------------------|---|----|----------|--------------------------------------|---|----|----------|--------------------------------|---|----|----------|-------------------|---|----|
| Code | Description | Image | Code | Description | Components list | | | | | | | | | | | | | | | | | | | | | | | | | | | | |
| 0B1296B | |  | 0B1296B0 | | | | | | | | | | | | | | | | | | | | | | | | | | | | | | |
| PE2109A | SP TOUCH COMPLETE CONTROL BOARD |  | KPE2109A | BL SHOP.PRO TOUCH CONTROL BOARD KIT | <table border="1"> <thead> <tr> <th>Code</th> <th>Description</th> <th>Qty</th> <th>UOM</th> </tr> </thead> <tbody> <tr> <td>PE2109A2</td> <td>BL SHOP.PRO TOUCH CONTROL BOARD</td> <td>1</td> <td>PZ</td> </tr> <tr> <td>PE2109A3</td> <td>SP TOUCH COMPLETE CONTROL BOARD</td> <td>1</td> <td>PZ</td> </tr> <tr> <td>VI1930A0</td> <td>5X25 ST. STEEL SCREW CHIP</td> <td>2</td> <td>PZ</td> </tr> <tr> <td>VM2147A0</td> <td>410X343X15 MM PINK SMOOTH ESD SPONGE</td> <td>1</td> <td>PZ</td> </tr> </tbody> </table> | Code | Description | Qty | UOM | PE2109A2 | BL SHOP.PRO TOUCH CONTROL BOARD | 1 | PZ | PE2109A3 | SP TOUCH COMPLETE CONTROL BOARD | 1 | PZ | VI1930A0 | 5X25 ST. STEEL SCREW CHIP | 2 | PZ | VM2147A0 | 410X343X15 MM PINK SMOOTH ESD SPONGE | 1 | PZ | | | | | | | | |
| Code | Description | Qty | UOM | | | | | | | | | | | | | | | | | | | | | | | | | | | | | | |
| PE2109A2 | BL SHOP.PRO TOUCH CONTROL BOARD | 1 | PZ | | | | | | | | | | | | | | | | | | | | | | | | | | | | | | |
| PE2109A3 | SP TOUCH COMPLETE CONTROL BOARD | 1 | PZ | | | | | | | | | | | | | | | | | | | | | | | | | | | | | | |
| VI1930A0 | 5X25 ST. STEEL SCREW CHIP | 2 | PZ | | | | | | | | | | | | | | | | | | | | | | | | | | | | | | |
| VM2147A0 | 410X343X15 MM PINK SMOOTH ESD SPONGE | 1 | PZ | | | | | | | | | | | | | | | | | | | | | | | | | | | | | | |
| VM2456A | BAKERLUX SHOP.PRO HANDLE END |  | KVM2456A | 2 PCS BAKERLUX SHOP.PRO HANDLE END KIT | <table border="1"> <thead> <tr> <th>Code</th> <th>Description</th> <th>Qty</th> <th>UOM</th> </tr> </thead> <tbody> <tr> <td>VI1930A0</td> <td>5X25 ST. STEEL SCREW CHIP</td> <td>4</td> <td>PZ</td> </tr> <tr> <td>VM1224A0</td> <td>65MY 220MM 2 COLOURS SHRINK TUBE</td> <td>0.300</td> <td>M</td> </tr> <tr> <td>VM2456A0</td> <td>BAKERLUX SHOP.PRO HANDLE END</td> <td>2</td> <td>PZ</td> </tr> <tr> <td>VM2456A0</td> <td>BAKERLUX SHOP.PRO HANDLE END</td> <td>2</td> <td>PZ</td> </tr> <tr> <td>VM2489A0</td> <td>SP HANDLE END KIT + STYLUS KIT</td> <td>1</td> <td>PZ</td> </tr> <tr> <td>VM2527A0</td> <td>STYLUS PEN FOR SP</td> <td>1</td> <td>PZ</td> </tr> </tbody> </table> | Code | Description | Qty | UOM | VI1930A0 | 5X25 ST. STEEL SCREW CHIP | 4 | PZ | VM1224A0 | 65MY 220MM 2 COLOURS SHRINK TUBE | 0.300 | M | VM2456A0 | BAKERLUX SHOP.PRO HANDLE END | 2 | PZ | VM2456A0 | BAKERLUX SHOP.PRO HANDLE END | 2 | PZ | VM2489A0 | SP HANDLE END KIT + STYLUS KIT | 1 | PZ | VM2527A0 | STYLUS PEN FOR SP | 1 | PZ |
| Code | Description | Qty | UOM | | | | | | | | | | | | | | | | | | | | | | | | | | | | | | |
| VI1930A0 | 5X25 ST. STEEL SCREW CHIP | 4 | PZ | | | | | | | | | | | | | | | | | | | | | | | | | | | | | | |
| VM1224A0 | 65MY 220MM 2 COLOURS SHRINK TUBE | 0.300 | M | | | | | | | | | | | | | | | | | | | | | | | | | | | | | | |
| VM2456A0 | BAKERLUX SHOP.PRO HANDLE END | 2 | PZ | | | | | | | | | | | | | | | | | | | | | | | | | | | | | | |
| VM2456A0 | BAKERLUX SHOP.PRO HANDLE END | 2 | PZ | | | | | | | | | | | | | | | | | | | | | | | | | | | | | | |
| VM2489A0 | SP HANDLE END KIT + STYLUS KIT | 1 | PZ | | | | | | | | | | | | | | | | | | | | | | | | | | | | | | |
| VM2527A0 | STYLUS PEN FOR SP | 1 | PZ | | | | | | | | | | | | | | | | | | | | | | | | | | | | | | |
| TB3303A | SHOP.PRO STE-ELE FLAG DOOR HANDLE TUBE |  | KTB3303A | BL SP STE-ELE LATER DOOR HANDLE TUBE KIT | <table border="1"> <thead> <tr> <th>Code</th> <th>Description</th> <th>Qty</th> <th>UOM</th> </tr> </thead> <tbody> <tr> <td>TB3303A0</td> <td>SHOP.PRO STE-ELE FLAG DOOR HANDLE TUBE</td> <td>1</td> <td>PZ</td> </tr> <tr> <td>VI1930A0</td> <td>5X25 ST. STEEL SCREW CHIP</td> <td>4</td> <td>PZ</td> </tr> </tbody> </table> | Code | Description | Qty | UOM | TB3303A0 | SHOP.PRO STE-ELE FLAG DOOR HANDLE TUBE | 1 | PZ | VI1930A0 | 5X25 ST. STEEL SCREW CHIP | 4 | PZ | | | | | | | | | | | | | | | | |
| Code | Description | Qty | UOM | | | | | | | | | | | | | | | | | | | | | | | | | | | | | | |
| TB3303A0 | SHOP.PRO STE-ELE FLAG DOOR HANDLE TUBE | 1 | PZ | | | | | | | | | | | | | | | | | | | | | | | | | | | | | | |
| VI1930A0 | 5X25 ST. STEEL SCREW CHIP | 4 | PZ | | | | | | | | | | | | | | | | | | | | | | | | | | | | | | |



| COMPONENT | | | SPARE PART | | | | | | | | | | | | | | | | | | | | | | |
|---|--|--|------------|--|--|--|-------------|-----|----------|----------------------|------------------------------------|----|----|----------|------------------------------------|---|----|----------|--------------------------------------|---|----|----------|----------------------|---|----|
| Code | Description | Image | Code | Description | Components list | | | | | | | | | | | | | | | | | | | | |
| TB3303A | SHOP.PRO STE-ELE FLAG DOOR HANDLE TUBE |  | KTB3303A | BL SP STE-ELE LATER DOOR HANDLE TUBE KIT | <table border="1"> <thead> <tr> <th>Code</th> <th>Description</th> <th>Qty</th> <th>UOM</th> </tr> </thead> <tbody> <tr> <td>VM2456A0</td> <td>BAKERLUX SHOP.PRO HANDLE END</td> <td>2</td> <td>PZ</td> </tr> <tr> <td>VM2456A0</td> <td>BAKERLUX SHOP.PRO HANDLE END</td> <td>2</td> <td>PZ</td> </tr> <tr> <td>VM2489A0</td> <td>SP HANDLE END KIT + STYLUS KIT</td> <td>1</td> <td>PZ</td> </tr> <tr> <td>VM2527A0</td> <td>STYLUS PEN FOR SP</td> <td>1</td> <td>PZ</td> </tr> </tbody> </table> | Code | Description | Qty | UOM | VM2456A0 | BAKERLUX SHOP.PRO HANDLE END | 2 | PZ | VM2456A0 | BAKERLUX SHOP.PRO HANDLE END | 2 | PZ | VM2489A0 | SP HANDLE END KIT + STYLUS KIT | 1 | PZ | VM2527A0 | STYLUS PEN FOR SP | 1 | PZ |
| | | | | | Code | Description | Qty | UOM | | | | | | | | | | | | | | | | | |
| | | | | | VM2456A0 | BAKERLUX SHOP.PRO HANDLE END | 2 | PZ | | | | | | | | | | | | | | | | | |
| | | | | | VM2456A0 | BAKERLUX SHOP.PRO HANDLE END | 2 | PZ | | | | | | | | | | | | | | | | | |
| VM2489A0 | SP HANDLE END KIT + STYLUS KIT | 1 | PZ | | | | | | | | | | | | | | | | | | | | | | |
| VM2527A0 | STYLUS PEN FOR SP | 1 | PZ | | | | | | | | | | | | | | | | | | | | | | |
| <table border="1"> <thead> <tr> <th>Code</th> <th>Description</th> <th>Qty</th> <th>UOM</th> </tr> </thead> <tbody> <tr> <td>VM1224A0</td> <td>65MY 220MM 2 COLOURS SHRINK TUBE</td> <td>0.150</td> <td>M</td> </tr> <tr> <td>VM2527A0</td> <td>STYLUS PEN FOR SP</td> <td>5</td> <td>PZ</td> </tr> </tbody> </table> | Code | Description | Qty | UOM | VM1224A0 | 65MY 220MM 2 COLOURS SHRINK TUBE | 0.150 | M | VM2527A0 | STYLUS PEN FOR SP | 5 | PZ | | | | | | | | | | | | | |
| Code | Description | Qty | UOM | | | | | | | | | | | | | | | | | | | | | | |
| VM1224A0 | 65MY 220MM 2 COLOURS SHRINK TUBE | 0.150 | M | | | | | | | | | | | | | | | | | | | | | | |
| VM2527A0 | STYLUS PEN FOR SP | 5 | PZ | | | | | | | | | | | | | | | | | | | | | | |
| <table border="1"> <thead> <tr> <th>Code</th> <th>Description</th> <th>Qty</th> <th>UOM</th> </tr> </thead> <tbody> <tr> <td>VM2527A0</td> <td>STYLUS PEN FOR SP</td> <td>5</td> <td>PZ</td> </tr> </tbody> </table> | Code | Description | Qty | UOM | VM2527A0 | STYLUS PEN FOR SP | 5 | PZ | | | | | | | | | | | | | | | | | |
| Code | Description | Qty | UOM | | | | | | | | | | | | | | | | | | | | | | |
| VM2527A0 | STYLUS PEN FOR SP | 5 | PZ | | | | | | | | | | | | | | | | | | | | | | |
| <table border="1"> <thead> <tr> <th>Code</th> <th>Description</th> <th>Qty</th> <th>UOM</th> </tr> </thead> <tbody> <tr> <td>VM2527A0</td> <td>STYLUS PEN FOR SP</td> <td>5</td> <td>PZ</td> </tr> </tbody> </table> | Code | Description | Qty | UOM | VM2527A0 | STYLUS PEN FOR SP | 5 | PZ | | | | | | | | | | | | | | | | | |
| Code | Description | Qty | UOM | | | | | | | | | | | | | | | | | | | | | | |
| VM2527A0 | STYLUS PEN FOR SP | 5 | PZ | | | | | | | | | | | | | | | | | | | | | | |
| VM2527A | STYLUS PEN FOR S |  | KVM2527A | EVEREO-BLSP TOUCH STYLUS 5 PCS KIT | | | | | | | | | | | | | | | | | | | | | |



ASM3415A/0.D01 - External cover

FRONT

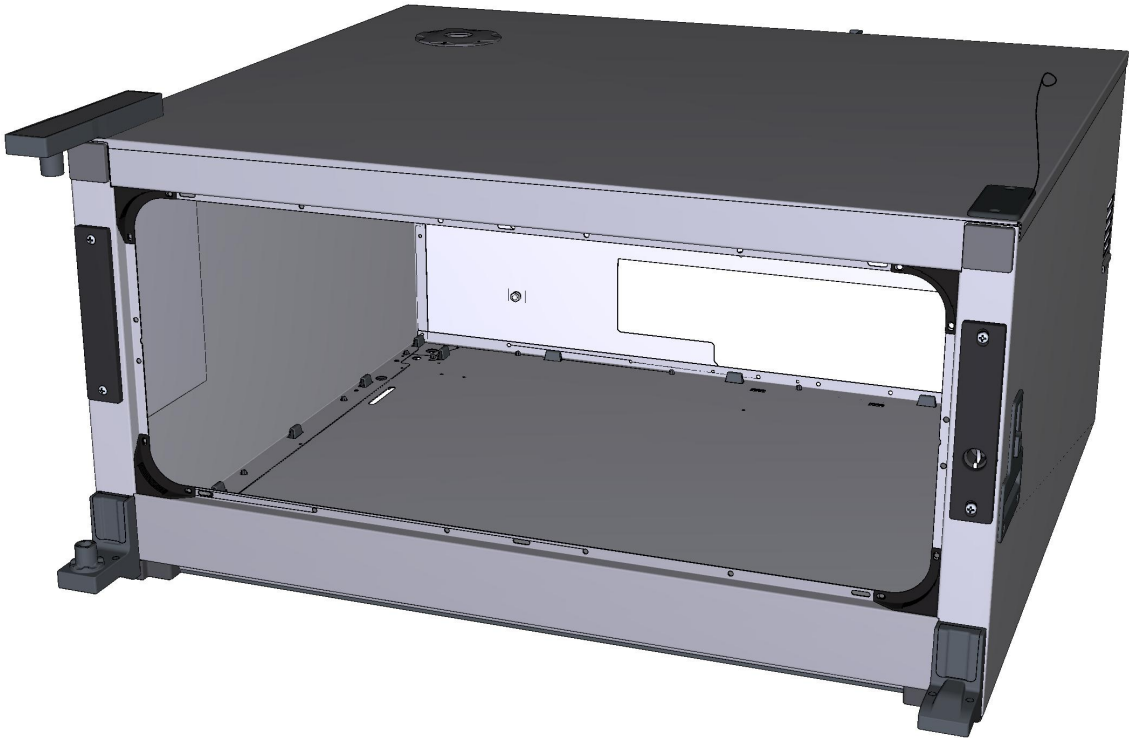





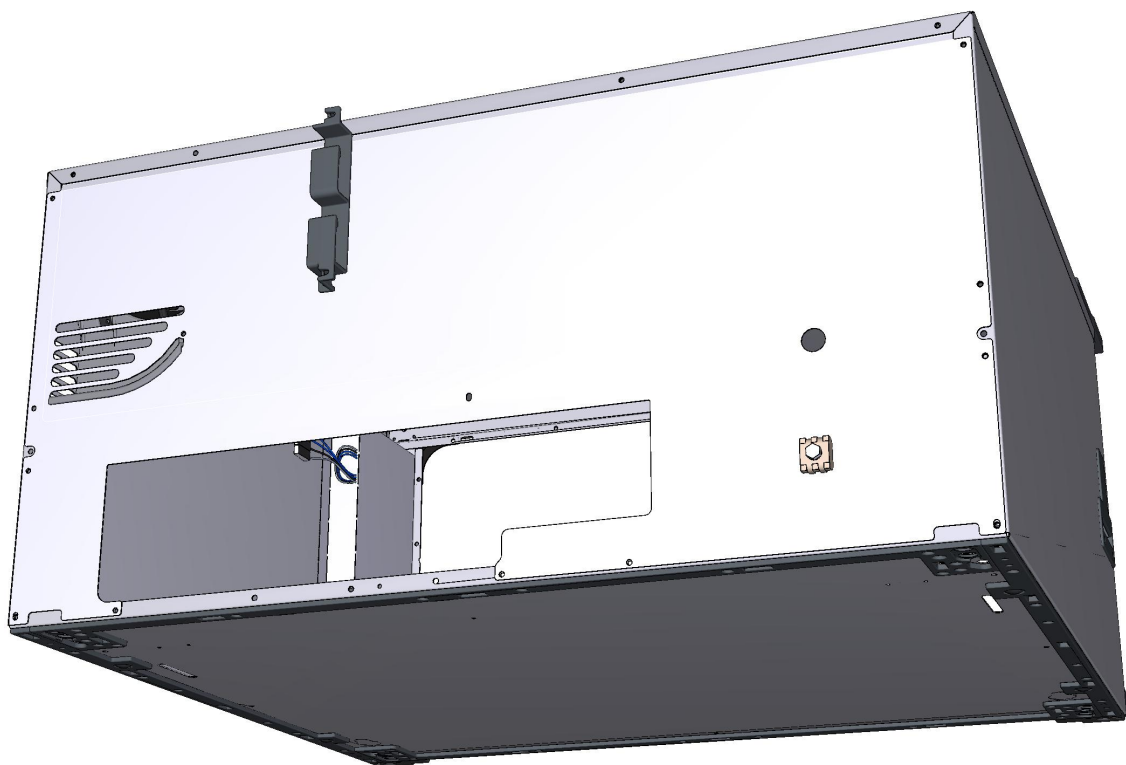

ASM3415A/0.D01 - External cover





REAR







| COMPONENT | | | SPARE PART | | | | | | | | | | | | | | | | | | |
|-----------|-----------------------------------|---|------------|--|--|------|-------------|-----|-----|----------|----------------------------------|-------|---|----------|-----------------------------------|---|----|----------|-----------------------------------|---|----|
| Code | Description | Image | Code | Description | Components list | | | | | | | | | | | | | | | | |
| VM1750A | BRASS COMB CLAM |  | KVM1750A | COMB TERMINAL BLOCK KIT | <table border="1"> <thead> <tr> <th>Code</th> <th>Description</th> <th>Qty</th> <th>UOM</th> </tr> </thead> <tbody> <tr> <td>VM1224A0</td> <td>65MY 220MM 2 COLOURS SHRINK TUBE</td> <td>0.150</td> <td>M</td> </tr> <tr> <td>VM1750A0</td> <td>BRASS COMB CLAMP</td> <td>1</td> <td>PZ</td> </tr> </tbody> </table> | Code | Description | Qty | UOM | VM1224A0 | 65MY 220MM 2 COLOURS SHRINK TUBE | 0.150 | M | VM1750A0 | BRASS COMB CLAMP | 1 | PZ | | | | |
| Code | Description | Qty | UOM | | | | | | | | | | | | | | | | | | |
| VM1224A0 | 65MY 220MM 2 COLOURS SHRINK TUBE | 0.150 | M | | | | | | | | | | | | | | | | | | |
| VM1750A0 | BRASS COMB CLAMP | 1 | PZ | | | | | | | | | | | | | | | | | | |
| VM2249A | COOKING CHAMBER FRONT CORNER |  | KVM2249A | CHAMBER FRONT PROFILE CORNER KIT | <table border="1"> <thead> <tr> <th>Code</th> <th>Description</th> <th>Qty</th> <th>UOM</th> </tr> </thead> <tbody> <tr> <td>VM1224A0</td> <td>65MY 220MM 2 COLOURS SHRINK TUBE</td> <td>0.150</td> <td>M</td> </tr> <tr> <td>VM2249A0</td> <td>COOKING CHAMBER FRONT CORNER</td> <td>1</td> <td>PZ</td> </tr> </tbody> </table> | Code | Description | Qty | UOM | VM1224A0 | 65MY 220MM 2 COLOURS SHRINK TUBE | 0.150 | M | VM2249A0 | COOKING CHAMBER FRONT CORNER | 1 | PZ | | | | |
| Code | Description | Qty | UOM | | | | | | | | | | | | | | | | | | |
| VM1224A0 | 65MY 220MM 2 COLOURS SHRINK TUBE | 0.150 | M | | | | | | | | | | | | | | | | | | |
| VM2249A0 | COOKING CHAMBER FRONT CORNER | 1 | PZ | | | | | | | | | | | | | | | | | | |
| VM2502A | BAKERLUX SHOP.PRO CHIMNEY RING |  | KVM2502A | BAKERLUX SHOP.PRO CHIMNEY RING KIT | <table border="1"> <thead> <tr> <th>Code</th> <th>Description</th> <th>Qty</th> <th>UOM</th> </tr> </thead> <tbody> <tr> <td>VM1224A0</td> <td>65MY 220MM 2 COLOURS SHRINK TUBE</td> <td>0.300</td> <td>M</td> </tr> <tr> <td>VM2502A0</td> <td>BAKERLUX SHOP.PRO CHIMNEY RIN</td> <td>1</td> <td>PZ</td> </tr> <tr> <td>VM2502A0</td> <td>BAKERLUX SHOP.PRO CHIMNEY RIN</td> <td>1</td> <td>PZ</td> </tr> </tbody> </table> | Code | Description | Qty | UOM | VM1224A0 | 65MY 220MM 2 COLOURS SHRINK TUBE | 0.300 | M | VM2502A0 | BAKERLUX SHOP.PRO CHIMNEY RIN | 1 | PZ | VM2502A0 | BAKERLUX SHOP.PRO CHIMNEY RIN | 1 | PZ |
| Code | Description | Qty | UOM | | | | | | | | | | | | | | | | | | |
| VM1224A0 | 65MY 220MM 2 COLOURS SHRINK TUBE | 0.300 | M | | | | | | | | | | | | | | | | | | |
| VM2502A0 | BAKERLUX SHOP.PRO CHIMNEY RIN | 1 | PZ | | | | | | | | | | | | | | | | | | |
| VM2502A0 | BAKERLUX SHOP.PRO CHIMNEY RIN | 1 | PZ | | | | | | | | | | | | | | | | | | |
| VM2481A | FRONT EXTERNAL COVER LEFT CAP S |  | KVM2481A | BL SP LEFT EXT COVER FRONT PANEL CAP KIT | <table border="1"> <thead> <tr> <th>Code</th> <th>Description</th> <th>Qty</th> <th>UOM</th> </tr> </thead> <tbody> <tr> <td>VM1224A0</td> <td>65MY 220MM 2 COLOURS SHRINK TUBE</td> <td>0.150</td> <td>M</td> </tr> <tr> <td>VM2481A0</td> <td>FRONT EXTERNAL COVER LEFT CAP SP</td> <td>1</td> <td>PZ</td> </tr> <tr> <td>VM2481A0</td> <td>FRONT EXTERNAL COVER LEFT CAP SP</td> <td>1</td> <td>PZ</td> </tr> </tbody> </table> | Code | Description | Qty | UOM | VM1224A0 | 65MY 220MM 2 COLOURS SHRINK TUBE | 0.150 | M | VM2481A0 | FRONT EXTERNAL COVER LEFT CAP SP | 1 | PZ | VM2481A0 | FRONT EXTERNAL COVER LEFT CAP SP | 1 | PZ |
| Code | Description | Qty | UOM | | | | | | | | | | | | | | | | | | |
| VM1224A0 | 65MY 220MM 2 COLOURS SHRINK TUBE | 0.150 | M | | | | | | | | | | | | | | | | | | |
| VM2481A0 | FRONT EXTERNAL COVER LEFT CAP SP | 1 | PZ | | | | | | | | | | | | | | | | | | |
| VM2481A0 | FRONT EXTERNAL COVER LEFT CAP SP | 1 | PZ | | | | | | | | | | | | | | | | | | |
| VM2480A | FRONT EXTERNAL COVER RIGHT CAP SP |  | KVM2480A | BL SP RIGHT EXT COVER FRONT PANEL CAP | <table border="1"> <thead> <tr> <th>Code</th> <th>Description</th> <th>Qty</th> <th>UOM</th> </tr> </thead> <tbody> <tr> <td>VM1224A0</td> <td>65MY 220MM 2 COLOURS SHRINK TUBE</td> <td>0.150</td> <td>M</td> </tr> <tr> <td>VM2480A0</td> <td>FRONT EXTERNAL COVER RIGHT CAP SP</td> <td>1</td> <td>PZ</td> </tr> <tr> <td>VM2480A0</td> <td>FRONT EXTERNAL COVER RIGHT CAP SP</td> <td>1</td> <td>PZ</td> </tr> </tbody> </table> | Code | Description | Qty | UOM | VM1224A0 | 65MY 220MM 2 COLOURS SHRINK TUBE | 0.150 | M | VM2480A0 | FRONT EXTERNAL COVER RIGHT CAP SP | 1 | PZ | VM2480A0 | FRONT EXTERNAL COVER RIGHT CAP SP | 1 | PZ |
| Code | Description | Qty | UOM | | | | | | | | | | | | | | | | | | |
| VM1224A0 | 65MY 220MM 2 COLOURS SHRINK TUBE | 0.150 | M | | | | | | | | | | | | | | | | | | |
| VM2480A0 | FRONT EXTERNAL COVER RIGHT CAP SP | 1 | PZ | | | | | | | | | | | | | | | | | | |
| VM2480A0 | FRONT EXTERNAL COVER RIGHT CAP SP | 1 | PZ | | | | | | | | | | | | | | | | | | |



| COMPONENT | | | SPARE PART | | | | | | | | | | | | | | | | | | | | | | | | | | | | | | |
|-----------|--|---|------------|--|---|------|-------------|-----|-----|----------|----------------------------------|-------|----|----------|------------------------------|----|----|----------|--------------------------------------|---|----|----------|---|---|----|----------|---|---|----|----------|--------------------------------|---|----|
| Code | Description | Image | Code | Description | Components list | | | | | | | | | | | | | | | | | | | | | | | | | | | | |
| VM1222A | CABLE LOCKS SP ACCESSORIES EL CONNECTION |  | VM1222A0 | CABLE LOCKS SP ACCESSORIES EL CONNECTION | | | | | | | | | | | | | | | | | | | | | | | | | | | | | |
| VM1631A | PLUS INNER GLASS PUSHING CAP |  | KVM1631A | CAP FOR INTERNAL GLASS 10 PCS KIT | <table border="1"> <thead> <tr> <th>Code</th> <th>Description</th> <th>Qty</th> <th>UOM</th> </tr> </thead> <tbody> <tr> <td>VM1224A0</td> <td>65MY 220MM 2 COLOURS SHRINK TUBE</td> <td>0.200</td> <td>M</td> </tr> <tr> <td>VM1631A0</td> <td>PLUS INNER GLASS PUSHING CAP</td> <td>10</td> <td>PZ</td> </tr> </tbody> </table> | Code | Description | Qty | UOM | VM1224A0 | 65MY 220MM 2 COLOURS SHRINK TUBE | 0.200 | M | VM1631A0 | PLUS INNER GLASS PUSHING CAP | 10 | PZ | | | | | | | | | | | | | | | | |
| Code | Description | Qty | UOM | | | | | | | | | | | | | | | | | | | | | | | | | | | | | | |
| VM1224A0 | 65MY 220MM 2 COLOURS SHRINK TUBE | 0.200 | M | | | | | | | | | | | | | | | | | | | | | | | | | | | | | | |
| VM1631A0 | PLUS INNER GLASS PUSHING CAP | 10 | PZ | | | | | | | | | | | | | | | | | | | | | | | | | | | | | | |
| VM2492A | BL SP 600X400 EXT BOTTOM PANEL GASKET |  | KVM2492A | SP 600X400 EXT BOT PANEL GASKET 2PC KIT | <table border="1"> <thead> <tr> <th>Code</th> <th>Description</th> <th>Qty</th> <th>UOM</th> </tr> </thead> <tbody> <tr> <td>VM1794A0</td> <td>250X4.8 PA66 BLACK CLAMP</td> <td>1</td> <td>PZ</td> </tr> <tr> <td>VM2103A0</td> <td>CLAMP LOCK</td> <td>1</td> <td>PZ</td> </tr> <tr> <td>VM2492A0</td> <td>BL SP 600X400 EXT BOTTOM PANEL GASKE</td> <td>2</td> <td>PZ</td> </tr> <tr> <td>VM2492A0</td> <td>BL SP 600X400 EXT BOTTOM PANEL GASKE</td> <td>2</td> <td>PZ</td> </tr> </tbody> </table> | Code | Description | Qty | UOM | VM1794A0 | 250X4.8 PA66 BLACK CLAMP | 1 | PZ | VM2103A0 | CLAMP LOCK | 1 | PZ | VM2492A0 | BL SP 600X400 EXT BOTTOM PANEL GASKE | 2 | PZ | VM2492A0 | BL SP 600X400 EXT BOTTOM PANEL GASKE | 2 | PZ | | | | | | | | |
| Code | Description | Qty | UOM | | | | | | | | | | | | | | | | | | | | | | | | | | | | | | |
| VM1794A0 | 250X4.8 PA66 BLACK CLAMP | 1 | PZ | | | | | | | | | | | | | | | | | | | | | | | | | | | | | | |
| VM2103A0 | CLAMP LOCK | 1 | PZ | | | | | | | | | | | | | | | | | | | | | | | | | | | | | | |
| VM2492A0 | BL SP 600X400 EXT BOTTOM PANEL GASKE | 2 | PZ | | | | | | | | | | | | | | | | | | | | | | | | | | | | | | |
| VM2492A0 | BL SP 600X400 EXT BOTTOM PANEL GASKE | 2 | PZ | | | | | | | | | | | | | | | | | | | | | | | | | | | | | | |
| VM2493A | BL SP 600X400 EX LAT BOTTOM PANEL GASKET |  | KVM2493A | SP 600X400 BOT LAT PANEL GASKET 2PC KIT | <table border="1"> <thead> <tr> <th>Code</th> <th>Description</th> <th>Qty</th> <th>UOM</th> </tr> </thead> <tbody> <tr> <td>VM1631A0</td> <td>PLUS INNER GLASS PUSHING CAP</td> <td>4</td> <td>PZ</td> </tr> <tr> <td>VM1794A0</td> <td>250X4.8 PA66 BLACK CLAMP</td> <td>1</td> <td>PZ</td> </tr> <tr> <td>VM2103A0</td> <td>CLAMP LOCK</td> <td>1</td> <td>PZ</td> </tr> <tr> <td>VM2493A0</td> <td>BL SP 600X400 EX LAT BOTTOM PANEL GASKE</td> <td>2</td> <td>PZ</td> </tr> <tr> <td>VM2493A0</td> <td>BL SP 600X400 EX LAT BOTTOM PANEL GASKE</td> <td>2</td> <td>PZ</td> </tr> <tr> <td>VM2493A1</td> <td>EXT. LATERAL BACK GASKET SP800</td> <td>2</td> <td>PZ</td> </tr> </tbody> </table> | Code | Description | Qty | UOM | VM1631A0 | PLUS INNER GLASS PUSHING CAP | 4 | PZ | VM1794A0 | 250X4.8 PA66 BLACK CLAMP | 1 | PZ | VM2103A0 | CLAMP LOCK | 1 | PZ | VM2493A0 | BL SP 600X400 EX LAT BOTTOM PANEL GASKE | 2 | PZ | VM2493A0 | BL SP 600X400 EX LAT BOTTOM PANEL GASKE | 2 | PZ | VM2493A1 | EXT. LATERAL BACK GASKET SP800 | 2 | PZ |
| Code | Description | Qty | UOM | | | | | | | | | | | | | | | | | | | | | | | | | | | | | | |
| VM1631A0 | PLUS INNER GLASS PUSHING CAP | 4 | PZ | | | | | | | | | | | | | | | | | | | | | | | | | | | | | | |
| VM1794A0 | 250X4.8 PA66 BLACK CLAMP | 1 | PZ | | | | | | | | | | | | | | | | | | | | | | | | | | | | | | |
| VM2103A0 | CLAMP LOCK | 1 | PZ | | | | | | | | | | | | | | | | | | | | | | | | | | | | | | |
| VM2493A0 | BL SP 600X400 EX LAT BOTTOM PANEL GASKE | 2 | PZ | | | | | | | | | | | | | | | | | | | | | | | | | | | | | | |
| VM2493A0 | BL SP 600X400 EX LAT BOTTOM PANEL GASKE | 2 | PZ | | | | | | | | | | | | | | | | | | | | | | | | | | | | | | |
| VM2493A1 | EXT. LATERAL BACK GASKET SP800 | 2 | PZ | | | | | | | | | | | | | | | | | | | | | | | | | | | | | | |

| COMPONENT | | | SPARE PART | | | | | | | | | | | | | | | | | | | | | | | | | | |
|-----------|--|---|------------|--|--|------|-------------|-----|-----|----------|--|---|----|----------|----------------------------------|-------|----|----------|-------------------------------|---|----|----------|-------------------------------|---|----|----------|----------------------------------|-------|---|
| Code | Description | Image | Code | Description | Components list | | | | | | | | | | | | | | | | | | | | | | | | |
| 0H7991A | |  | K0H7991A | STE-ELE SP RIGHT LOCKING VENTILATION KIT | <table border="1"> <thead> <tr> <th>Code</th> <th>Description</th> <th>Qty</th> <th>UOM</th> </tr> </thead> <tbody> <tr> <td>0H7909A0</td> <td>STE-ELE SP LOCK COOLING DOWN PASS</td> <td>1</td> <td>PZ</td> </tr> </tbody> </table> | Code | Description | Qty | UOM | 0H7909A0 | STE-ELE SP LOCK COOLING DOWN PASS | 1 | PZ | | | | | | | | | | | | | | | | |
| Code | Description | Qty | UOM | | | | | | | | | | | | | | | | | | | | | | | | | | |
| 0H7909A0 | STE-ELE SP LOCK COOLING DOWN PASS | 1 | PZ | | | | | | | | | | | | | | | | | | | | | | | | | | |
| 0H7995A | |  | 0H7995A0 | | | | | | | | | | | | | | | | | | | | | | | | | | |
| CR1035A | L.MISS MATIC ELECTROMECHANICAL LOCK |  | KCR1035A | LM MATIC ELECTROMECHANICAL LOCK KIT | <table border="1"> <thead> <tr> <th>Code</th> <th>Description</th> <th>Qty</th> <th>UOM</th> </tr> </thead> <tbody> <tr> <td>CR1035A0</td> <td>L.MISS MATIC ELECTROMECHANICAL LOCK</td> <td>1</td> <td>PZ</td> </tr> <tr> <td>VM1224A0</td> <td>65MY 220MM 2 COLOURS SHRINK TUBE</td> <td>0.200</td> <td>M</td> </tr> </tbody> </table> | Code | Description | Qty | UOM | CR1035A0 | L.MISS MATIC ELECTROMECHANICAL LOCK | 1 | PZ | VM1224A0 | 65MY 220MM 2 COLOURS SHRINK TUBE | 0.200 | M | | | | | | | | | | | | |
| Code | Description | Qty | UOM | | | | | | | | | | | | | | | | | | | | | | | | | | |
| CR1035A0 | L.MISS MATIC ELECTROMECHANICAL LOCK | 1 | PZ | | | | | | | | | | | | | | | | | | | | | | | | | | |
| VM1224A0 | 65MY 220MM 2 COLOURS SHRINK TUBE | 0.200 | M | | | | | | | | | | | | | | | | | | | | | | | | | | |
| CE1297A | |  | KCE1297A | BL SHOP.PRO CABLE LOCK KIT | <table border="1"> <thead> <tr> <th>Code</th> <th>Description</th> <th>Qty</th> <th>UOM</th> </tr> </thead> <tbody> <tr> <td>CE1295A1</td> <td>CABLE FOR ELECTROMAGNETIC LOCKING SYSTEM</td> <td>1</td> <td>PZ</td> </tr> <tr> <td>CE1735A0</td> <td>MINIFIT FEMALE END FITTING</td> <td>4</td> <td>PZ</td> </tr> <tr> <td>CE1746A0</td> <td>2 WAYS MALE MINIFIT CONNECTOR</td> <td>1</td> <td>PZ</td> </tr> <tr> <td>CE1750A0</td> <td>3 WAYS MALE MINIFIT CONNECTOR</td> <td>1</td> <td>PZ</td> </tr> <tr> <td>VM1224A0</td> <td>65MY 220MM 2 COLOURS SHRINK TUBE</td> <td>0.250</td> <td>M</td> </tr> </tbody> </table> | Code | Description | Qty | UOM | CE1295A1 | CABLE FOR ELECTROMAGNETIC LOCKING SYSTEM | 1 | PZ | CE1735A0 | MINIFIT FEMALE END FITTING | 4 | PZ | CE1746A0 | 2 WAYS MALE MINIFIT CONNECTOR | 1 | PZ | CE1750A0 | 3 WAYS MALE MINIFIT CONNECTOR | 1 | PZ | VM1224A0 | 65MY 220MM 2 COLOURS SHRINK TUBE | 0.250 | M |
| Code | Description | Qty | UOM | | | | | | | | | | | | | | | | | | | | | | | | | | |
| CE1295A1 | CABLE FOR ELECTROMAGNETIC LOCKING SYSTEM | 1 | PZ | | | | | | | | | | | | | | | | | | | | | | | | | | |
| CE1735A0 | MINIFIT FEMALE END FITTING | 4 | PZ | | | | | | | | | | | | | | | | | | | | | | | | | | |
| CE1746A0 | 2 WAYS MALE MINIFIT CONNECTOR | 1 | PZ | | | | | | | | | | | | | | | | | | | | | | | | | | |
| CE1750A0 | 3 WAYS MALE MINIFIT CONNECTOR | 1 | PZ | | | | | | | | | | | | | | | | | | | | | | | | | | |
| VM1224A0 | 65MY 220MM 2 COLOURS SHRINK TUBE | 0.250 | M | | | | | | | | | | | | | | | | | | | | | | | | | | |

| COMPONENT | | | SPARE PART | | | | | | | | | | | | | | | | | | | | | | |
|-----------|-------------------------------------|---|------------|-------------------------------------|--|------|-------------|-----|-----|----------|---------------------------------|---|----|----------|----------------------------------|-------|---|----------|-------------------------------------|---|----|----------|------------------------|---|----|
| Code | Description | Image | Code | Description | Components list | | | | | | | | | | | | | | | | | | | | |
| VM2154A | ELECTRIC LOCKING COVER |  | KVM2154A | LINEMISS MATIC-TOP LOCKING COVER KI | <table border="1"> <thead> <tr> <th>Code</th> <th>Description</th> <th>Qty</th> <th>UOM</th> </tr> </thead> <tbody> <tr> <td>0H1234A0</td> <td>DOOR LOCK PANEL</td> <td>1</td> <td>PZ</td> </tr> <tr> <td>VM1224A0</td> <td>65MY 220MM 2 COLOURS SHRINK TUBE</td> <td>0.300</td> <td>M</td> </tr> <tr> <td>VM2154A0</td> <td>LINE MISS TOP ELECTRONIC LOCK COVER</td> <td>1</td> <td>PZ</td> </tr> <tr> <td>VM2154A1</td> <td>ELECTRIC LOCKING COVER</td> <td>1</td> <td>PZ</td> </tr> </tbody> </table> | Code | Description | Qty | UOM | 0H1234A0 | DOOR LOCK PANEL | 1 | PZ | VM1224A0 | 65MY 220MM 2 COLOURS SHRINK TUBE | 0.300 | M | VM2154A0 | LINE MISS TOP ELECTRONIC LOCK COVER | 1 | PZ | VM2154A1 | ELECTRIC LOCKING COVER | 1 | PZ |
| Code | Description | Qty | UOM | | | | | | | | | | | | | | | | | | | | | | |
| 0H1234A0 | DOOR LOCK PANEL | 1 | PZ | | | | | | | | | | | | | | | | | | | | | | |
| VM1224A0 | 65MY 220MM 2 COLOURS SHRINK TUBE | 0.300 | M | | | | | | | | | | | | | | | | | | | | | | |
| VM2154A0 | LINE MISS TOP ELECTRONIC LOCK COVER | 1 | PZ | | | | | | | | | | | | | | | | | | | | | | |
| VM2154A1 | ELECTRIC LOCKING COVER | 1 | PZ | | | | | | | | | | | | | | | | | | | | | | |
| 0H1234A | DOOR LOCK PANEL |  | KVM2154A | LINEMISS MATIC-TOP LOCKING COVER KI | <table border="1"> <thead> <tr> <th>Code</th> <th>Description</th> <th>Qty</th> <th>UOM</th> </tr> </thead> <tbody> <tr> <td>0H1234A0</td> <td>DOOR LOCK PANEL</td> <td>1</td> <td>PZ</td> </tr> <tr> <td>VM1224A0</td> <td>65MY 220MM 2 COLOURS SHRINK TUBE</td> <td>0.300</td> <td>M</td> </tr> <tr> <td>VM2154A0</td> <td>LINE MISS TOP ELECTRONIC LOCK COVER</td> <td>1</td> <td>PZ</td> </tr> <tr> <td>VM2154A1</td> <td>ELECTRIC LOCKING COVER</td> <td>1</td> <td>PZ</td> </tr> </tbody> </table> | Code | Description | Qty | UOM | 0H1234A0 | DOOR LOCK PANEL | 1 | PZ | VM1224A0 | 65MY 220MM 2 COLOURS SHRINK TUBE | 0.300 | M | VM2154A0 | LINE MISS TOP ELECTRONIC LOCK COVER | 1 | PZ | VM2154A1 | ELECTRIC LOCKING COVER | 1 | PZ |
| Code | Description | Qty | UOM | | | | | | | | | | | | | | | | | | | | | | |
| 0H1234A0 | DOOR LOCK PANEL | 1 | PZ | | | | | | | | | | | | | | | | | | | | | | |
| VM1224A0 | 65MY 220MM 2 COLOURS SHRINK TUBE | 0.300 | M | | | | | | | | | | | | | | | | | | | | | | |
| VM2154A0 | LINE MISS TOP ELECTRONIC LOCK COVER | 1 | PZ | | | | | | | | | | | | | | | | | | | | | | |
| VM2154A1 | ELECTRIC LOCKING COVER | 1 | PZ | | | | | | | | | | | | | | | | | | | | | | |
| VM2290A | ELECTRIC LOCKING BLIND COVER |  | KVM2290A | BLSP BLIND LOCKING COVER KI | <table border="1"> <thead> <tr> <th>Code</th> <th>Description</th> <th>Qty</th> <th>UOM</th> </tr> </thead> <tbody> <tr> <td>V11024A0</td> <td>SCREW M4X12 TCB + INOX DIN 7985</td> <td>2</td> <td>PZ</td> </tr> <tr> <td>VM1224A0</td> <td>65MY 220MM 2 COLOURS SHRINK TUBE</td> <td>0.300</td> <td>M</td> </tr> <tr> <td>VM2290A0</td> <td>ELECTRIC LOCKING BLIND COVER</td> <td>1</td> <td>PZ</td> </tr> </tbody> </table> | Code | Description | Qty | UOM | V11024A0 | SCREW M4X12 TCB + INOX DIN 7985 | 2 | PZ | VM1224A0 | 65MY 220MM 2 COLOURS SHRINK TUBE | 0.300 | M | VM2290A0 | ELECTRIC LOCKING BLIND COVER | 1 | PZ | | | | |
| Code | Description | Qty | UOM | | | | | | | | | | | | | | | | | | | | | | |
| V11024A0 | SCREW M4X12 TCB + INOX DIN 7985 | 2 | PZ | | | | | | | | | | | | | | | | | | | | | | |
| VM1224A0 | 65MY 220MM 2 COLOURS SHRINK TUBE | 0.300 | M | | | | | | | | | | | | | | | | | | | | | | |
| VM2290A0 | ELECTRIC LOCKING BLIND COVER | 1 | PZ | | | | | | | | | | | | | | | | | | | | | | |
| VI1995A | M5X25 ST.STEEL SCREW |  | VI1995A0 | M5X25 ST.STEEL SCREW | | | | | | | | | | | | | | | | | | | | | |





| COMPONENT | | | SPARE PART | | | | | | | | | | | | | | | | | | |
|-----------|--|---|------------|--|--|------|-------------|-----|-----|----------|----------------------------------|-------|----|----------|--|---|----|----------|--|---|----|
| Code | Description | Image | Code | Description | Components list | | | | | | | | | | | | | | | | |
| VM1240A | NYLON SUPPORT CAP |  | KVM1240A | 4 PCS COUNTER BRACKET SUPPORT CAP KIT | <table border="1"> <thead> <tr> <th>Code</th> <th>Description</th> <th>Qty</th> <th>UOM</th> </tr> </thead> <tbody> <tr> <td>VM1224A0</td> <td>65MY 220MM 2 COLOURS SHRINK TUBE</td> <td>0.200</td> <td>M</td> </tr> <tr> <td>VM1240A0</td> <td>NYLON SUPPORT CAP</td> <td>4</td> <td>PZ</td> </tr> </tbody> </table> | Code | Description | Qty | UOM | VM1224A0 | 65MY 220MM 2 COLOURS SHRINK TUBE | 0.200 | M | VM1240A0 | NYLON SUPPORT CAP | 4 | PZ | | | | |
| Code | Description | Qty | UOM | | | | | | | | | | | | | | | | | | |
| VM1224A0 | 65MY 220MM 2 COLOURS SHRINK TUBE | 0.200 | M | | | | | | | | | | | | | | | | | | |
| VM1240A0 | NYLON SUPPORT CAP | 4 | PZ | | | | | | | | | | | | | | | | | | |
| 0H7850A | SHOP PRO DOOR COUNTERBRACKET |  | 0H7850A0 | SHOP PRO DOOR COUNTERBRACKET | | | | | | | | | | | | | | | | | |
| VI0515A | STAINLESS STEEL WASHER D=5 6592 |  | VI0515A0 | STAINLESS STEEL WASHER D=5 6592 | | | | | | | | | | | | | | | | | |
| VM2460A | BL SP LATERAL DOOR UPPER BRACKET COVER |  | KVM2460A | BL SP LAT DOOR UPP BRACKET COVER 2PC KIT | <table border="1"> <thead> <tr> <th>Code</th> <th>Description</th> <th>Qty</th> <th>UOM</th> </tr> </thead> <tbody> <tr> <td>VM1224A0</td> <td>65MY 220MM 2 COLOURS SHRINK TUBE</td> <td>0.250</td> <td>M</td> </tr> <tr> <td>VM2460A0</td> <td>BL SP LATERAL DOOR UPPER BRACKET COVER</td> <td>1</td> <td>PZ</td> </tr> <tr> <td>VM2460A0</td> <td>BL SP LATERAL DOOR UPPER BRACKET COVER</td> <td>1</td> <td>PZ</td> </tr> </tbody> </table> | Code | Description | Qty | UOM | VM1224A0 | 65MY 220MM 2 COLOURS SHRINK TUBE | 0.250 | M | VM2460A0 | BL SP LATERAL DOOR UPPER BRACKET COVER | 1 | PZ | VM2460A0 | BL SP LATERAL DOOR UPPER BRACKET COVER | 1 | PZ |
| Code | Description | Qty | UOM | | | | | | | | | | | | | | | | | | |
| VM1224A0 | 65MY 220MM 2 COLOURS SHRINK TUBE | 0.250 | M | | | | | | | | | | | | | | | | | | |
| VM2460A0 | BL SP LATERAL DOOR UPPER BRACKET COVER | 1 | PZ | | | | | | | | | | | | | | | | | | |
| VM2460A0 | BL SP LATERAL DOOR UPPER BRACKET COVER | 1 | PZ | | | | | | | | | | | | | | | | | | |
| VM2459A | SP LATERAL DOOR UPPER BRACKET |  | KVM2459A | BL SP LATERAL DOOR UPPER BRACKET KIT | <table border="1"> <thead> <tr> <th>Code</th> <th>Description</th> <th>Qty</th> <th>UOM</th> </tr> </thead> <tbody> <tr> <td>VI0515A0</td> <td>STAINLESS STEEL WASHER D=5 6592</td> <td>4</td> <td>PZ</td> </tr> <tr> <td>VI1995A0</td> <td>M5X25 ST.STEEL SCREW</td> <td>4</td> <td>PZ</td> </tr> </tbody> </table> | Code | Description | Qty | UOM | VI0515A0 | STAINLESS STEEL WASHER D=5 6592 | 4 | PZ | VI1995A0 | M5X25 ST.STEEL SCREW | 4 | PZ | | | | |
| Code | Description | Qty | UOM | | | | | | | | | | | | | | | | | | |
| VI0515A0 | STAINLESS STEEL WASHER D=5 6592 | 4 | PZ | | | | | | | | | | | | | | | | | | |
| VI1995A0 | M5X25 ST.STEEL SCREW | 4 | PZ | | | | | | | | | | | | | | | | | | |



| COMPONENT | | | SPARE PART | | | | | | | | | | | | | | | | | | | | | | | | | | |
|-----------|--|---|------------|---------------------------------------|--|------|-------------|-----|-----|----------|----------------------------------|-------|---|----------|-------------------------------|---|----|----------|-------------------------------|---|----|----------|--|---|----|----------|--|---|----|
| Code | Description | Image | Code | Description | Components list | | | | | | | | | | | | | | | | | | | | | | | | |
| VM2459A | SP LATERAL DOOR UPPER BRACKET |  | KVM2459A | BL SP LATERAL DOOR UPPER BRACKET KIT | <table border="1"> <thead> <tr> <th>Code</th> <th>Description</th> <th>Qty</th> <th>UOM</th> </tr> </thead> <tbody> <tr> <td>VM1224A0</td> <td>65MY 220MM 2 COLOURS SHRINK TUBE</td> <td>0.300</td> <td>M</td> </tr> <tr> <td>VM2459A1</td> <td>SP LATERAL DOOR UPPER BRACKET</td> <td>1</td> <td>PZ</td> </tr> <tr> <td>VM2459A1</td> <td>SP LATERAL DOOR UPPER BRACKET</td> <td>1</td> <td>PZ</td> </tr> <tr> <td>VM2460A0</td> <td>BL SP LATERAL DOOR UPPER BRACKET COVER</td> <td>1</td> <td>PZ</td> </tr> <tr> <td>VM2460A0</td> <td>BL SP LATERAL DOOR UPPER BRACKET COVER</td> <td>1</td> <td>PZ</td> </tr> </tbody> </table> | Code | Description | Qty | UOM | VM1224A0 | 65MY 220MM 2 COLOURS SHRINK TUBE | 0.300 | M | VM2459A1 | SP LATERAL DOOR UPPER BRACKET | 1 | PZ | VM2459A1 | SP LATERAL DOOR UPPER BRACKET | 1 | PZ | VM2460A0 | BL SP LATERAL DOOR UPPER BRACKET COVER | 1 | PZ | VM2460A0 | BL SP LATERAL DOOR UPPER BRACKET COVER | 1 | PZ |
| Code | Description | Qty | UOM | | | | | | | | | | | | | | | | | | | | | | | | | | |
| VM1224A0 | 65MY 220MM 2 COLOURS SHRINK TUBE | 0.300 | M | | | | | | | | | | | | | | | | | | | | | | | | | | |
| VM2459A1 | SP LATERAL DOOR UPPER BRACKET | 1 | PZ | | | | | | | | | | | | | | | | | | | | | | | | | | |
| VM2459A1 | SP LATERAL DOOR UPPER BRACKET | 1 | PZ | | | | | | | | | | | | | | | | | | | | | | | | | | |
| VM2460A0 | BL SP LATERAL DOOR UPPER BRACKET COVER | 1 | PZ | | | | | | | | | | | | | | | | | | | | | | | | | | |
| VM2460A0 | BL SP LATERAL DOOR UPPER BRACKET COVER | 1 | PZ | | | | | | | | | | | | | | | | | | | | | | | | | | |
| VI1995A | M5X25 ST.STEEL SCREW |  | VI1995A0 | M5X25 ST.STEEL SCREW | | | | | | | | | | | | | | | | | | | | | | | | | |
| VM1240A | NYLON SUPPORT CAP |  | KVM1240A | 4 PCS COUNTER BRACKET SUPPORT CAP KIT | <table border="1"> <thead> <tr> <th>Code</th> <th>Description</th> <th>Qty</th> <th>UOM</th> </tr> </thead> <tbody> <tr> <td>VM1224A0</td> <td>65MY 220MM 2 COLOURS SHRINK TUBE</td> <td>0.200</td> <td>M</td> </tr> <tr> <td>VM1240A0</td> <td>NYLON SUPPORT CAP</td> <td>4</td> <td>PZ</td> </tr> </tbody> </table> | Code | Description | Qty | UOM | VM1224A0 | 65MY 220MM 2 COLOURS SHRINK TUBE | 0.200 | M | VM1240A0 | NYLON SUPPORT CAP | 4 | PZ | | | | | | | | | | | | |
| Code | Description | Qty | UOM | | | | | | | | | | | | | | | | | | | | | | | | | | |
| VM1224A0 | 65MY 220MM 2 COLOURS SHRINK TUBE | 0.200 | M | | | | | | | | | | | | | | | | | | | | | | | | | | |
| VM1240A0 | NYLON SUPPORT CAP | 4 | PZ | | | | | | | | | | | | | | | | | | | | | | | | | | |
| 0H7850A | SHOP PRO DOOR COUNTERBRACKET |  | 0H7850A0 | SHOP PRO DOOR COUNTERBRACKET | | | | | | | | | | | | | | | | | | | | | | | | | |





| COMPONENT | | | SPARE PART | | | | | | | | | | | | | | | | | | | | | | | | | | | | | | | | | | |
|-----------|--|---|------------|--|---|------|-------------|-----|-----|----------|--|-------|----|----------|--|---|----|----------|--|-------|----|----------|---|---|----|----------|---|---|----|----------|--|---|----|----------|--|---|----|
| Code | Description | Image | Code | Description | Components list | | | | | | | | | | | | | | | | | | | | | | | | | | | | | | | | |
| VI0515A | STAINLESS STEEL WASHER D=5 6592 |  | VI0515A0 | STAINLESS STEEL WASHER D=5 6592 | | | | | | | | | | | | | | | | | | | | | | | | | | | | | | | | | |
| VM2457A | BL SP LATERAL DOOR LOWER BRACKET |  | KVM2457A | BL SP LATERAL DOOR LOWER BRACKET KIT | <table border="1"> <thead> <tr> <th>Code</th> <th>Description</th> <th>Qty</th> <th>UOM</th> </tr> </thead> <tbody> <tr> <td>VI0515A0</td> <td>STAINLESS STEEL WASHER D=5 6592</td> <td>2</td> <td>PZ</td> </tr> <tr> <td>VI1995A0</td> <td>M5X25 ST.STEEL SCREW</td> <td>2</td> <td>PZ</td> </tr> <tr> <td>VM1224A0</td> <td>65MY 220MM 2 COLOURS SHRINK TUBE</td> <td>0.300</td> <td>M</td> </tr> <tr> <td>VM2457A0</td> <td>BL SP LATERAL DOOR LOWER BRACKET</td> <td>1</td> <td>PZ</td> </tr> <tr> <td>VM2457A0</td> <td>BL SP LATERAL DOOR LOWER BRACKET</td> <td>1</td> <td>PZ</td> </tr> <tr> <td>VM2458A0</td> <td>BL SP LATERAL DOOR LOW BRACKET COVER</td> <td>1</td> <td>PZ</td> </tr> <tr> <td>VM2458A0</td> <td>BL SP LATERAL DOOR LOW BRACKET COVER</td> <td>1</td> <td>PZ</td> </tr> </tbody> </table> | Code | Description | Qty | UOM | VI0515A0 | STAINLESS STEEL WASHER D=5 6592 | 2 | PZ | VI1995A0 | M5X25 ST.STEEL SCREW | 2 | PZ | VM1224A0 | 65MY 220MM 2 COLOURS SHRINK TUBE | 0.300 | M | VM2457A0 | BL SP LATERAL DOOR LOWER BRACKET | 1 | PZ | VM2457A0 | BL SP LATERAL DOOR LOWER BRACKET | 1 | PZ | VM2458A0 | BL SP LATERAL DOOR LOW BRACKET COVER | 1 | PZ | VM2458A0 | BL SP LATERAL DOOR LOW BRACKET COVER | 1 | PZ |
| Code | Description | Qty | UOM | | | | | | | | | | | | | | | | | | | | | | | | | | | | | | | | | | |
| VI0515A0 | STAINLESS STEEL WASHER D=5 6592 | 2 | PZ | | | | | | | | | | | | | | | | | | | | | | | | | | | | | | | | | | |
| VI1995A0 | M5X25 ST.STEEL SCREW | 2 | PZ | | | | | | | | | | | | | | | | | | | | | | | | | | | | | | | | | | |
| VM1224A0 | 65MY 220MM 2 COLOURS SHRINK TUBE | 0.300 | M | | | | | | | | | | | | | | | | | | | | | | | | | | | | | | | | | | |
| VM2457A0 | BL SP LATERAL DOOR LOWER BRACKET | 1 | PZ | | | | | | | | | | | | | | | | | | | | | | | | | | | | | | | | | | |
| VM2457A0 | BL SP LATERAL DOOR LOWER BRACKET | 1 | PZ | | | | | | | | | | | | | | | | | | | | | | | | | | | | | | | | | | |
| VM2458A0 | BL SP LATERAL DOOR LOW BRACKET COVER | 1 | PZ | | | | | | | | | | | | | | | | | | | | | | | | | | | | | | | | | | |
| VM2458A0 | BL SP LATERAL DOOR LOW BRACKET COVER | 1 | PZ | | | | | | | | | | | | | | | | | | | | | | | | | | | | | | | | | | |
| VM2458A | BL SP LATERAL DOOR LOW BRACKET COVER |  | KVM2458A | BL SP LAT DOOR LOW BRACKET COVER 2PC KIT | <table border="1"> <thead> <tr> <th>Code</th> <th>Description</th> <th>Qty</th> <th>UOM</th> </tr> </thead> <tbody> <tr> <td>VM1224A0</td> <td>65MY 220MM 2 COLOURS SHRINK TUBE</td> <td>0.200</td> <td>M</td> </tr> <tr> <td>VM2458A0</td> <td>BL SP LATERAL DOOR LOW BRACKET COVER</td> <td>2</td> <td>PZ</td> </tr> <tr> <td>VM2458A0</td> <td>BL SP LATERAL DOOR LOW BRACKET COVER</td> <td>2</td> <td>PZ</td> </tr> </tbody> </table> | Code | Description | Qty | UOM | VM1224A0 | 65MY 220MM 2 COLOURS SHRINK TUBE | 0.200 | M | VM2458A0 | BL SP LATERAL DOOR LOW BRACKET COVER | 2 | PZ | VM2458A0 | BL SP LATERAL DOOR LOW BRACKET COVER | 2 | PZ | | | | | | | | | | | | | | | | |
| Code | Description | Qty | UOM | | | | | | | | | | | | | | | | | | | | | | | | | | | | | | | | | | |
| VM1224A0 | 65MY 220MM 2 COLOURS SHRINK TUBE | 0.200 | M | | | | | | | | | | | | | | | | | | | | | | | | | | | | | | | | | | |
| VM2458A0 | BL SP LATERAL DOOR LOW BRACKET COVER | 2 | PZ | | | | | | | | | | | | | | | | | | | | | | | | | | | | | | | | | | |
| VM2458A0 | BL SP LATERAL DOOR LOW BRACKET COVER | 2 | PZ | | | | | | | | | | | | | | | | | | | | | | | | | | | | | | | | | | |



| COMPONENT | | | SPARE PART | | | | | | | | | | | | | | | | | | |
|-----------|--|---|------------|--|--|------|-------------|-----|-----|----------|----------------------------------|-------|---|----------|------------------------------------|---|----|----------|------------------------------------|---|----|
| Code | Description | Image | Code | Description | Components list | | | | | | | | | | | | | | | | |
| VM1240A | NYLON SUPPORT CAP |  | KVM1240A | 4 PCS COUNTER BRACKET SUPPORT CAP KIT | <table border="1"> <thead> <tr> <th>Code</th> <th>Description</th> <th>Qty</th> <th>UOM</th> </tr> </thead> <tbody> <tr> <td>VM1224A0</td> <td>65MY 220MM 2 COLOURS SHRINK TUBE</td> <td>0.200</td> <td>M</td> </tr> <tr> <td>VM1240A0</td> <td>NYLON SUPPORT CAP</td> <td>4</td> <td>PZ</td> </tr> </tbody> </table> | Code | Description | Qty | UOM | VM1224A0 | 65MY 220MM 2 COLOURS SHRINK TUBE | 0.200 | M | VM1240A0 | NYLON SUPPORT CAP | 4 | PZ | | | | |
| Code | Description | Qty | UOM | | | | | | | | | | | | | | | | | | |
| VM1224A0 | 65MY 220MM 2 COLOURS SHRINK TUBE | 0.200 | M | | | | | | | | | | | | | | | | | | |
| VM1240A0 | NYLON SUPPORT CAP | 4 | PZ | | | | | | | | | | | | | | | | | | |
| VM1195A | HOLES BLANKING PLATE XVC204/304/504/704 |  | VM1195A0 | HOLES BLANKING PLATE XVC204/304/504/704 | | | | | | | | | | | | | | | | | |
| 0H7850A | SHOP PRO DOOR COUNTERBRACKET |  | 0H7850A0 | SHOP PRO DOOR COUNTERBRACKET | | | | | | | | | | | | | | | | | |
| VM2511A | SP FRONT PANEL HOLE PLATE COVER |  | KVM2511A | SP FRONT PANEL HOLE PLATE COVER 2PCS KIT | <table border="1"> <thead> <tr> <th>Code</th> <th>Description</th> <th>Qty</th> <th>UOM</th> </tr> </thead> <tbody> <tr> <td>VM1224A0</td> <td>65MY 220MM 2 COLOURS SHRINK TUBE</td> <td>0.150</td> <td>M</td> </tr> <tr> <td>VM2511A0</td> <td>SP FRONT PANEL HOLE PLATE COVER</td> <td>2</td> <td>PZ</td> </tr> <tr> <td>VM2511A0</td> <td>SP FRONT PANEL HOLE PLATE COVER</td> <td>2</td> <td>PZ</td> </tr> </tbody> </table> | Code | Description | Qty | UOM | VM1224A0 | 65MY 220MM 2 COLOURS SHRINK TUBE | 0.150 | M | VM2511A0 | SP FRONT PANEL HOLE PLATE COVER | 2 | PZ | VM2511A0 | SP FRONT PANEL HOLE PLATE COVER | 2 | PZ |
| Code | Description | Qty | UOM | | | | | | | | | | | | | | | | | | |
| VM1224A0 | 65MY 220MM 2 COLOURS SHRINK TUBE | 0.150 | M | | | | | | | | | | | | | | | | | | |
| VM2511A0 | SP FRONT PANEL HOLE PLATE COVER | 2 | PZ | | | | | | | | | | | | | | | | | | |
| VM2511A0 | SP FRONT PANEL HOLE PLATE COVER | 2 | PZ | | | | | | | | | | | | | | | | | | |
| VM2509A | BL SHOP.PRO BLIND LOCK VENTILATION |  | KVM2509A | BL SHOP.PRO BLIND LOCK VENTILATION KIT | <table border="1"> <thead> <tr> <th>Code</th> <th>Description</th> <th>Qty</th> <th>UOM</th> </tr> </thead> <tbody> <tr> <td>VM1224A0</td> <td>65MY 220MM 2 COLOURS SHRINK TUBE</td> <td>0.300</td> <td>M</td> </tr> <tr> <td>VM2509A1</td> <td>BL SHOP.PRO BLIND LOCK VENTILATION</td> <td>1</td> <td>PZ</td> </tr> <tr> <td>VM2509A1</td> <td>BL SHOP.PRO BLIND LOCK VENTILATION</td> <td>1</td> <td>PZ</td> </tr> </tbody> </table> | Code | Description | Qty | UOM | VM1224A0 | 65MY 220MM 2 COLOURS SHRINK TUBE | 0.300 | M | VM2509A1 | BL SHOP.PRO BLIND LOCK VENTILATION | 1 | PZ | VM2509A1 | BL SHOP.PRO BLIND LOCK VENTILATION | 1 | PZ |
| Code | Description | Qty | UOM | | | | | | | | | | | | | | | | | | |
| VM1224A0 | 65MY 220MM 2 COLOURS SHRINK TUBE | 0.300 | M | | | | | | | | | | | | | | | | | | |
| VM2509A1 | BL SHOP.PRO BLIND LOCK VENTILATION | 1 | PZ | | | | | | | | | | | | | | | | | | |
| VM2509A1 | BL SHOP.PRO BLIND LOCK VENTILATION | 1 | PZ | | | | | | | | | | | | | | | | | | |

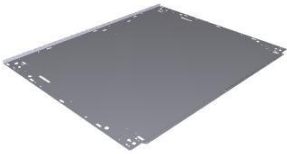



| COMPONENT | | | SPARE PART | | | | | | | | | | | | | | | | | | | | | | | | | | | | | | | | | | |
|-----------|--|---|------------|---|---|------|-------------|-----|-----|----------|--------------------------------------|---|----|----------|--|---|----|----------|--|-------|---|----------|---|---|----|----------|---|---|----|----------|--------------------------------|---|----|----------|--------------------------------|---|----|
| Code | Description | Image | Code | Description | Components list | | | | | | | | | | | | | | | | | | | | | | | | | | | | | | | | |
| VM2488A | BL SHOP.PRO MANUAL UNLOCK SYSTEM |  | KVM2488A | BL SHOP.PRO MANUAL UNLOCK SYSTEM KIT | <table border="1"> <thead> <tr> <th>Code</th> <th>Description</th> <th>Qty</th> <th>UOM</th> </tr> </thead> <tbody> <tr> <td>VI1220A1</td> <td>4,2X12 TCB SELF-TAPPIN G SCREW</td> <td>2</td> <td>PZ</td> </tr> <tr> <td>VI1950A0</td> <td>ST. STEEL 4,2X13 TCB SELF-DRILLIN G SCREW</td> <td>2</td> <td>PZ</td> </tr> <tr> <td>VM1224A0</td> <td>65MY 220MM 2 COLOURS SHRINK TUBE</td> <td>0.300</td> <td>M</td> </tr> <tr> <td>VM2488A1</td> <td>BL SHOP.PRO MANUAL UNLOCK SYSTEM</td> <td>1</td> <td>PZ</td> </tr> <tr> <td>VM2488A1</td> <td>BL SHOP.PRO MANUAL UNLOCK SYSTEM</td> <td>1</td> <td>PZ</td> </tr> <tr> <td>VM2501A0</td> <td>BL SHOP.PRO UNLOCK SCREW</td> <td>1</td> <td>PZ</td> </tr> <tr> <td>VM2501A0</td> <td>BL SHOP.PRO UNLOCK SCREW</td> <td>1</td> <td>PZ</td> </tr> </tbody> </table> | Code | Description | Qty | UOM | VI1220A1 | 4,2X12 TCB SELF-TAPPIN G SCREW | 2 | PZ | VI1950A0 | ST. STEEL 4,2X13 TCB SELF-DRILLIN G SCREW | 2 | PZ | VM1224A0 | 65MY 220MM 2 COLOURS SHRINK TUBE | 0.300 | M | VM2488A1 | BL SHOP.PRO MANUAL UNLOCK SYSTEM | 1 | PZ | VM2488A1 | BL SHOP.PRO MANUAL UNLOCK SYSTEM | 1 | PZ | VM2501A0 | BL SHOP.PRO UNLOCK SCREW | 1 | PZ | VM2501A0 | BL SHOP.PRO UNLOCK SCREW | 1 | PZ |
| Code | Description | Qty | UOM | | | | | | | | | | | | | | | | | | | | | | | | | | | | | | | | | | |
| VI1220A1 | 4,2X12 TCB SELF-TAPPIN G SCREW | 2 | PZ | | | | | | | | | | | | | | | | | | | | | | | | | | | | | | | | | | |
| VI1950A0 | ST. STEEL 4,2X13 TCB SELF-DRILLIN G SCREW | 2 | PZ | | | | | | | | | | | | | | | | | | | | | | | | | | | | | | | | | | |
| VM1224A0 | 65MY 220MM 2 COLOURS SHRINK TUBE | 0.300 | M | | | | | | | | | | | | | | | | | | | | | | | | | | | | | | | | | | |
| VM2488A1 | BL SHOP.PRO MANUAL UNLOCK SYSTEM | 1 | PZ | | | | | | | | | | | | | | | | | | | | | | | | | | | | | | | | | | |
| VM2488A1 | BL SHOP.PRO MANUAL UNLOCK SYSTEM | 1 | PZ | | | | | | | | | | | | | | | | | | | | | | | | | | | | | | | | | | |
| VM2501A0 | BL SHOP.PRO UNLOCK SCREW | 1 | PZ | | | | | | | | | | | | | | | | | | | | | | | | | | | | | | | | | | |
| VM2501A0 | BL SHOP.PRO UNLOCK SCREW | 1 | PZ | | | | | | | | | | | | | | | | | | | | | | | | | | | | | | | | | | |
| 0E1382A | SP800 EXTERNAL BOTTOM PANEL |  | 0E1382A1 | SP800 EXTERNAL BOTTOM PANEL | | | | | | | | | | | | | | | | | | | | | | | | | | | | | | | | | |
| 0D2412A | SP800 INF FRONT PROFILE RIGHT-LEFT DOOR |  | 0D2412A1 | SP800 INF FRONT PROFILE RIGHT-LEFT DOOR | | | | | | | | | | | | | | | | | | | | | | | | | | | | | | | | | |







| COMPONENT | | | SPARE PART | | | | | | | | | | | | | | |
|-----------|----------------------------------|---|------------|---------------------------------------|---|------|-------------|-----|-----|----------|----------------------------------|-------|---|----------|-------------------|---|----|
| Code | Description | Image | Code | Description | Components list | | | | | | | | | | | | |
| 0D2414A | SP800 COVER |  | 0D2414A1 | SP800 COVER | | | | | | | | | | | | | |
| VI1995A | M5X25 ST.STEEL SCREW |  | VI1995A0 | M5X25 ST.STEEL SCREW | | | | | | | | | | | | | |
| VM1240A | NYLON SUPPORT CAP |  | KVM1240A | 4 PCS COUNTER BRACKET SUPPORT CAP KIT | <table border="1"> <thead> <tr> <th>Code</th> <th>Description</th> <th>Qty</th> <th>UOM</th> </tr> </thead> <tbody> <tr> <td>VM1224A0</td> <td>65MY 220MM 2 COLOURS SHRINK TUBE</td> <td>0.200</td> <td>M</td> </tr> <tr> <td>VM1240A0</td> <td>NYLON SUPPORT CAP</td> <td>4</td> <td>PZ</td> </tr> </tbody> </table> | Code | Description | Qty | UOM | VM1224A0 | 65MY 220MM 2 COLOURS SHRINK TUBE | 0.200 | M | VM1240A0 | NYLON SUPPORT CAP | 4 | PZ |
| Code | Description | Qty | UOM | | | | | | | | | | | | | | |
| VM1224A0 | 65MY 220MM 2 COLOURS SHRINK TUBE | 0.200 | M | | | | | | | | | | | | | | |
| VM1240A0 | NYLON SUPPORT CAP | 4 | PZ | | | | | | | | | | | | | | |
| 0H7850A | SHOP PRO DOOR COUNTERBRACKET |  | 0H7850A0 | SHOP PRO DOOR COUNTERBRACKET | | | | | | | | | | | | | |
| VI0515A | STAINLESS STEEL WASHER D=5 6592 |  | VI0515A0 | STAINLESS STEEL WASHER D=5 6592 | | | | | | | | | | | | | |



| COMPONENT | | | SPARE PART | | | | | | | | | | | | | | | | | | | | | | | | | | | | | | | | | | |
|-----------|--------------------------------------|--|------------|--|---|------|-------------|-----|-----|----------|----------------------------------|-------|----|----------|--------------------------------------|---|----|----------|--------------------------------------|-------|----|----------|--------------------------------------|---|----|----------|--------------------------------------|---|----|----------|-----------------------------------|---|----|----------|-----------------------------------|---|----|
| Code | Description | Image | Code | Description | Components list | | | | | | | | | | | | | | | | | | | | | | | | | | | | | | | | |
| VM2458A | BL SP LATERAL DOOR LOW BRACKET COVER |  | KVM2458A | BL SP LAT DOOR LOW BRACKET COVER 2PC KIT | <table border="1"> <thead> <tr> <th>Code</th> <th>Description</th> <th>Qty</th> <th>UOM</th> </tr> </thead> <tbody> <tr> <td>VM1224A0</td> <td>65MY 220MM 2 COLOURS SHRINK TUBE</td> <td>0.200</td> <td>M</td> </tr> <tr> <td>VM2458A0</td> <td>BL SP LATERAL DOOR LOW BRACKET COVER</td> <td>2</td> <td>PZ</td> </tr> <tr> <td>VM2458A0</td> <td>BL SP LATERAL DOOR LOW BRACKET COVER</td> <td>2</td> <td>PZ</td> </tr> </tbody> </table> | Code | Description | Qty | UOM | VM1224A0 | 65MY 220MM 2 COLOURS SHRINK TUBE | 0.200 | M | VM2458A0 | BL SP LATERAL DOOR LOW BRACKET COVER | 2 | PZ | VM2458A0 | BL SP LATERAL DOOR LOW BRACKET COVER | 2 | PZ | | | | | | | | | | | | | | | | |
| Code | Description | Qty | UOM | | | | | | | | | | | | | | | | | | | | | | | | | | | | | | | | | | |
| VM1224A0 | 65MY 220MM 2 COLOURS SHRINK TUBE | 0.200 | M | | | | | | | | | | | | | | | | | | | | | | | | | | | | | | | | | | |
| VM2458A0 | BL SP LATERAL DOOR LOW BRACKET COVER | 2 | PZ | | | | | | | | | | | | | | | | | | | | | | | | | | | | | | | | | | |
| VM2458A0 | BL SP LATERAL DOOR LOW BRACKET COVER | 2 | PZ | | | | | | | | | | | | | | | | | | | | | | | | | | | | | | | | | | |
| VM2469A | BL SP LATERAL DOOR HOLDER BRACKET |  | KVM2469A | BL SP LATERAL DOOR HOLDER BRACKET KIT | <table border="1"> <thead> <tr> <th>Code</th> <th>Description</th> <th>Qty</th> <th>UOM</th> </tr> </thead> <tbody> <tr> <td>VI0515A0</td> <td>STAINLESS STEEL WASHER D=5 6592</td> <td>2</td> <td>PZ</td> </tr> <tr> <td>VI1995A0</td> <td>M5X25 ST.STEEL SCREW</td> <td>2</td> <td>PZ</td> </tr> <tr> <td>VM1224A0</td> <td>65MY 220MM 2 COLOURS SHRINK TUBE</td> <td>0.200</td> <td>M</td> </tr> <tr> <td>VM2458A0</td> <td>BL SP LATERAL DOOR LOW BRACKET COVER</td> <td>1</td> <td>PZ</td> </tr> <tr> <td>VM2458A0</td> <td>BL SP LATERAL DOOR LOW BRACKET COVER</td> <td>1</td> <td>PZ</td> </tr> <tr> <td>VM2469A0</td> <td>BL SP LATERAL DOOR HOLDER BRACKET</td> <td>1</td> <td>PZ</td> </tr> <tr> <td>VM2469A0</td> <td>BL SP LATERAL DOOR HOLDER BRACKET</td> <td>1</td> <td>PZ</td> </tr> </tbody> </table> | Code | Description | Qty | UOM | VI0515A0 | STAINLESS STEEL WASHER D=5 6592 | 2 | PZ | VI1995A0 | M5X25 ST.STEEL SCREW | 2 | PZ | VM1224A0 | 65MY 220MM 2 COLOURS SHRINK TUBE | 0.200 | M | VM2458A0 | BL SP LATERAL DOOR LOW BRACKET COVER | 1 | PZ | VM2458A0 | BL SP LATERAL DOOR LOW BRACKET COVER | 1 | PZ | VM2469A0 | BL SP LATERAL DOOR HOLDER BRACKET | 1 | PZ | VM2469A0 | BL SP LATERAL DOOR HOLDER BRACKET | 1 | PZ |
| Code | Description | Qty | UOM | | | | | | | | | | | | | | | | | | | | | | | | | | | | | | | | | | |
| VI0515A0 | STAINLESS STEEL WASHER D=5 6592 | 2 | PZ | | | | | | | | | | | | | | | | | | | | | | | | | | | | | | | | | | |
| VI1995A0 | M5X25 ST.STEEL SCREW | 2 | PZ | | | | | | | | | | | | | | | | | | | | | | | | | | | | | | | | | | |
| VM1224A0 | 65MY 220MM 2 COLOURS SHRINK TUBE | 0.200 | M | | | | | | | | | | | | | | | | | | | | | | | | | | | | | | | | | | |
| VM2458A0 | BL SP LATERAL DOOR LOW BRACKET COVER | 1 | PZ | | | | | | | | | | | | | | | | | | | | | | | | | | | | | | | | | | |
| VM2458A0 | BL SP LATERAL DOOR LOW BRACKET COVER | 1 | PZ | | | | | | | | | | | | | | | | | | | | | | | | | | | | | | | | | | |
| VM2469A0 | BL SP LATERAL DOOR HOLDER BRACKET | 1 | PZ | | | | | | | | | | | | | | | | | | | | | | | | | | | | | | | | | | |
| VM2469A0 | BL SP LATERAL DOOR HOLDER BRACKET | 1 | PZ | | | | | | | | | | | | | | | | | | | | | | | | | | | | | | | | | | |



| COMPONENT | | | SPARE PART | | | | | | | | | | | | | | |
|-----------|--|---|------------|--|---|------|-------------|-----|-----|----------|--|---|----|----------|--|---|----|
| Code | Description | Image | Code | Description | Components list | | | | | | | | | | | | |
| VN1175A | 230V 50/60HZ 120X120 COOLING DOWN FAN |  | KVN1175A | 120X120 230V 50/60HZ COOLING FAN KIT | <table border="1"> <thead> <tr> <th>Code</th> <th>Description</th> <th>Qty</th> <th>UOM</th> </tr> </thead> <tbody> <tr> <td>VN1175A0</td> <td>230V 50/60HZ 120X120 COOLING DOWN FAN</td> <td>1</td> <td>PZ</td> </tr> <tr> <td>VN1175A0</td> <td>230V 50/60HZ 120X120 COOLING DOWN FAN</td> <td>1</td> <td>PZ</td> </tr> </tbody> </table> | Code | Description | Qty | UOM | VN1175A0 | 230V 50/60HZ 120X120 COOLING DOWN FAN | 1 | PZ | VN1175A0 | 230V 50/60HZ 120X120 COOLING DOWN FAN | 1 | PZ |
| Code | Description | Qty | UOM | | | | | | | | | | | | | | |
| VN1175A0 | 230V 50/60HZ 120X120 COOLING DOWN FAN | 1 | PZ | | | | | | | | | | | | | | |
| VN1175A0 | 230V 50/60HZ 120X120 COOLING DOWN FAN | 1 | PZ | | | | | | | | | | | | | | |
| VM2495A | SP COOLING FAN SUPPORT |  | KVM2495A | COOLING FAN SUPPORT KIT | <table border="1"> <thead> <tr> <th>Code</th> <th>Description</th> <th>Qty</th> <th>UOM</th> </tr> </thead> <tbody> <tr> <td>VH1220A1</td> <td>4,2X12 TCB SELF-TAPPIN G SCREW</td> <td>2</td> <td>PZ</td> </tr> <tr> <td>VM2495A0</td> <td>SP COOLING FAN SUPPORT</td> <td>1</td> <td>PZ</td> </tr> </tbody> </table> | Code | Description | Qty | UOM | VH1220A1 | 4,2X12 TCB SELF-TAPPIN G SCREW | 2 | PZ | VM2495A0 | SP COOLING FAN SUPPORT | 1 | PZ |
| Code | Description | Qty | UOM | | | | | | | | | | | | | | |
| VH1220A1 | 4,2X12 TCB SELF-TAPPIN G SCREW | 2 | PZ | | | | | | | | | | | | | | |
| VM2495A0 | SP COOLING FAN SUPPORT | 1 | PZ | | | | | | | | | | | | | | |
| 0F1543B | ELENA SP BACK PANEL |  | 0F1543B0 | ELENA SP BACK PANEL | | | | | | | | | | | | | |
| 0D2415B | |  | 0D2415B0 | | | | | | | | | | | | | | |
| 0D2416B | |  | 0D2416B0 | | | | | | | | | | | | | | |