

**33 100**

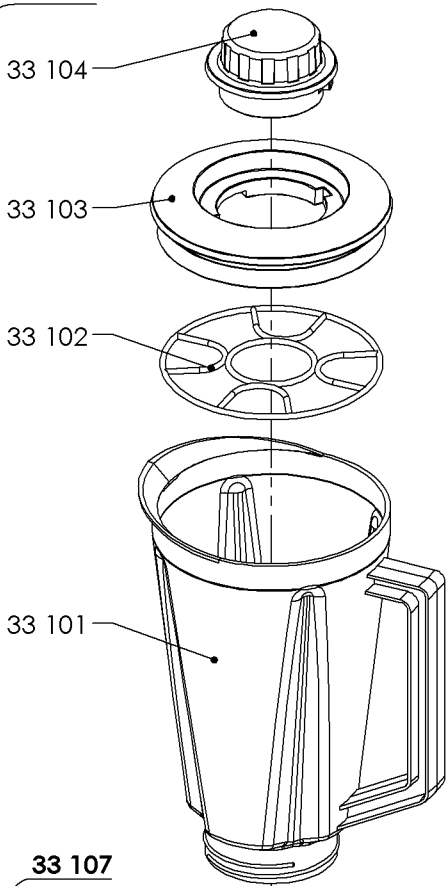

**33 107**

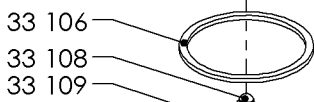

**33 145**

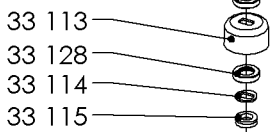
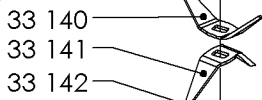

**33 123**

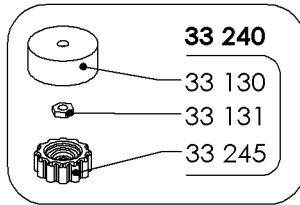
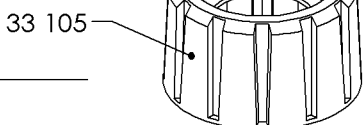
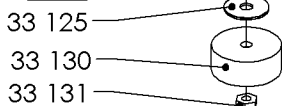
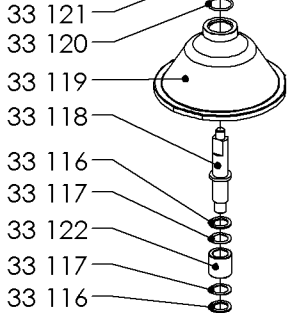

**SANTOS Blender #33**

From date: 06/2016  
from serial number: 977586

**33 200  
33 200E**

