



pumps

wash and rinse pumps

FIR

pumps

→ electric components



1			
GEV No.	499004	Ref. No.	1291.1670
description	pump inlet ø 28mm outlet ø 26mm type 1291.1670 230V 50Hz 1 phase 0,07kW 0,1HP L 195mm rotation direction right capacitor 5µF FIR		
spare parts for	499004		
	GEV No.	365017	Ref. No. —
	operating capacitor capacity 5µF 450V		



1			
GEV No.	500387	Ref. No.	2211.1408
description	pump inlet ø 28mm outlet ø 26mm type 2211.1408 220V 50Hz 1 phase 0,074kW 0,1HP L 190mm rotation direction left capacitor 5µF FIR 2600rpm		
spare parts for	500387		
	GEV No.	365017	Ref. No. —
	operating capacitor capacity 5µF 450V		
	GEV No.	510384	Ref. No. N/A
	pump cover inlet ø 28 mm outlet ø 26 mm ø 100 mm		
	GEV No.	510695	Ref. No. N/A
	mechanical shaft seal height counter ring 5,5 mm		

spare parts for	500387		
	GEV No.	521203	Ref. No. N/A
	impellor ø 72 mm H 18 mm thread M7 shaft ø 11 mm		
	GEV No.	521703	Ref. No. N/A
	pump cover gasket EPDM thickness 2,5 mm ID ø 75 mm		



1			
GEV No.	500037	Ref. No.	2211.1402 2211.1410
description	pump inlet ø 28mm outlet ø 26mm type 2211.1410 230V 50Hz 1 phase 0.074kW 0,1HP L 190mm rotation direction left capacitor 5µF FIR		

spare parts for	500037		
	GEV No.	365017	Ref. No. —
	operating capacitor capacity 5µF 450V		
	GEV No.	510384	Ref. No. N/A
	pump cover inlet ø 28 mm outlet ø 26 mm ø 100 mm		
	GEV No.	510695	Ref. No. N/A
	mechanical shaft seal height counter ring 5,5 mm		
	GEV No.	521203	Ref. No. N/A
	impellor ø 72 mm H 18 mm thread M7 shaft ø 11 mm		
	GEV No.	521703	Ref. No. N/A
	pump cover gasket EPDM thickness 2,5 mm ID ø 75 mm		



1

GEV No.	499079	Ref. No.	2211.1610
description	pump inlet ø 28mm outlet ø 26mm type 2211.1610 220-240V 50Hz 1 phase 0,07kW 0,1HP rotation direction left capacitor 5µF FIR		
spare parts for	499079		
	GEV No.	365017	Ref. No. —
	operating capacitor capacity 5µF 450V		
	GEV No.	510384	Ref. No. N/A
	pump cover inlet ø 28 mm outlet ø 26 mm ø 100 mm		
	GEV No.	510695	Ref. No. N/A
	mechanical shaft seal height counter ring 5,5 mm		
	GEV No.	521203	Ref. No. N/A
	impellor ø 72 mm H 18 mm thread M7 shaft ø 11 mm		
	GEV No.	521703	Ref. No. N/A
	pump cover gasket EPDM thickness 2,5 mm ID ø 75 mm		



1

GEV No.	500457	Ref. No.	2213.1417
description	pump inlet ø 28mm outlet ø 26mm type 2213.1417 230V 50Hz 1 phase 0,15kW 0,2HP L 198mm rotation direction left capacitor 6,3µF FIR		
spare parts for	500457		
	GEV No.	365012	Ref. No. —
	operating capacitor capacity 6,3µF 450V		

spare parts for	500457		
	GEV No.	510384	Ref. No. N/A
	pump cover inlet ø 28 mm outlet ø 26 mm ø 100 mm		
	GEV No.	510695	Ref. No. N/A
	mechanical shaft seal height counter ring 5,5 mm		
	GEV No.	521703	Ref. No. N/A
	pump cover gasket EPDM thickness 2,5 mm ID ø 75 mm		



1

GEV No.	500465	Ref. No.	2213.1601
description	pump inlet ø 28mm outlet ø 26mm type 2213.1601 230V 50Hz 1 phase 0,11kW 0,15HP L 195mm rotation direction left capacitor 5µF FIR		
spare parts for	500465		
	GEV No.	365017	Ref. No. —
	operating capacitor capacity 5µF 450V		
	GEV No.	510384	Ref. No. N/A
	pump cover inlet ø 28 mm outlet ø 26 mm ø 100 mm		
	GEV No.	510695	Ref. No. N/A
	mechanical shaft seal height counter ring 5,5 mm		
	GEV No.	511711	Ref. No. —
	O-ring EPDM thickness 3,53mm ID ø 78,97mm		
	GEV No.	521266	Ref. No. N/A
	impellor ø 67 mm H 18 mm thread M7 shaft ø 11 mm		





1



GEV No.	500028	Ref. No.	2213.1912
description	pump inlet ø 28mm outlet ø 26mm type 2213.1912 230V 50Hz 1 phase 0,11kW 0,15HP L 195mm rotation direction left capacitor 6,3µF FIR		
spare parts for	500028		
	GEV No.	365012	Ref. No. —
	operating capacitor capacity 6,3µF 450V		
	GEV No.	510384	Ref. No. N/A
	pump cover inlet ø 28 mm outlet ø 26 mm ø 100 mm		
	GEV No.	510695	Ref. No. N/A
	mechanical shaft seal height counter ring 5,5 mm		
	GEV No.	521203	Ref. No. N/A
	impellor ø 72 mm H 18 mm thread M7 shaft ø 11 mm		
	GEV No.	521703	Ref. No. N/A
	pump cover gasket EPDM thickness 2,5 mm ID ø 75 mm		



1

GEV No.	500685	Ref. No.	2214.1403
description	pump inlet ø 28mm outlet ø 26mm type 2214.1403 230V 50Hz 1 phase 0,11kW 0,15HP L 197mm rotation direction right capacitor 6,3µF FIR		
spare parts for	500685		
	GEV No.	365012	Ref. No. —
	operating capacitor capacity 6,3µF 450V		
	GEV No.	510510	Ref. No. X2212-HP,0,10_ (1)
	pump cover pump type 2212/2228/2229/2211		
	GEV No.	510695	Ref. No. N/A
	mechanical shaft seal height counter ring 5,5 mm		

spare parts for 500685

	GEV No.	521203	Ref. No.	N/A
	impellor ø 72 mm H 18 mm thread M7 shaft ø 11 mm			
	GEV No.	521703	Ref. No.	N/A
	pump cover gasket EPDM thickness 2,5 mm ID ø 75 mm			





1

GEV No.	500948	Ref. No.	2214.1600
description	pump inlet ø 28mm outlet ø 26mm type 2214.1600 230V 50Hz 1 phase 0,11kW 0,15HP L 197mm rotation direction right capacitor 6,3µF FIR		
spare parts for	500948		
	GEV No.	365012	Ref. No. —
	operating capacitor capacity 6,3µF 450V		
	GEV No.	510510	Ref. No. X2212-HP,0,10_ (1)
	pump cover pump type 2212/2228/2229/2211		
	GEV No.	510695	Ref. No. N/A
	mechanical shaft seal height counter ring 5,5 mm		
	GEV No.	521203	Ref. No. N/A
	impellor ø 72 mm H 18 mm thread M7 shaft ø 11 mm		
	GEV No.	521703	Ref. No. N/A
	pump cover gasket EPDM thickness 2,5 mm ID ø 75 mm		







1

GEV No.	499090	Ref. No.	2222.1900
description	pump inlet ø 28mm outlet ø 26mm type 2222.1900 230V 50Hz 1 phase 0,22kW 0,3HP L 191mm rotation direction left capacitor 5µF FIR		
spare parts for	499090		
	GEV No.	365017	Ref. No. —
	operating capacitor capacity 5µF 450V		
	GEV No.	510384	Ref. No. N/A
	pump cover inlet ø 28 mm outlet ø 26 mm ø 100 mm		
	GEV No.	510532	Ref. No. X2228-HP0,20_(1)
	impellor ø 72 mm H 22 mm pump type B229 thread M7		
	GEV No.	510695	Ref. No. N/A
	mechanical shaft seal height counter ring 5,5 mm		
	GEV No.	521703	Ref. No. N/A
	pump cover gasket EPDM thickness 2,5 mm ID ø 75 mm		



1

GEV No.	500015	Ref. No.	2228.1900
description	pump inlet ø 28mm outlet ø 26mm type 2228.1900 230V 50Hz 1 phase 0,15kW 0,2HP L 190mm rotation direction right capacitor 5µF FIR		
spare parts for	500015		
	GEV No.	365017	Ref. No. —
	operating capacitor capacity 5µF 450V		
	GEV No.	510510	Ref. No. X2212-HP0,10_(1)
	pump cover pump type 2212/2228/2229/2211		
	GEV No.	510532	Ref. No. X2228-HP0,20_(1)
	impellor ø 72 mm H 22 mm pump type B229 thread M7		

spare parts for	500015		
	GEV No.	510695	Ref. No. N/A
	mechanical shaft seal height counter ring 5,5 mm		
	GEV No.	521703	Ref. No. N/A
	pump cover gasket EPDM thickness 2,5 mm ID ø 75 mm		



1

GEV No.	500399	Ref. No.	4208.1910
description	pump inlet ø 28mm outlet ø 26mm type 4208.1910 230V 50Hz 1 phase 0,075kW 0,1HP L 190mm rotation direction left capacitor 5µF FIR		
spare parts for	500399		
	GEV No.	365017	Ref. No. —
	operating capacitor capacity 5µF 450V		
	GEV No.	510384	Ref. No. N/A
	pump cover inlet ø 28 mm outlet ø 26 mm ø 100 mm		
	GEV No.	510695	Ref. No. N/A
	mechanical shaft seal height counter ring 5,5 mm		
	GEV No.	521203	Ref. No. N/A
	impellor ø 72 mm H 18 mm thread M7 shaft ø 11 mm		
	GEV No.	521703	Ref. No. N/A
	pump cover gasket EPDM thickness 2,5 mm ID ø 75 mm		





1



GEV No.	500394	Ref. No.	4213.1500
description	pump inlet ø 28mm outlet ø 26mm type 4213.1500 230V 50Hz 1 phase 0,28kW 0,38HP L 195mm rotation direction left capacitor 6,3µF FIR		
spare parts for	500394		
	GEV No.	365012	Ref. No. —
	operating capacitor capacity 6,3µF 450V		
	GEV No.	510384	Ref. No. N/A
	pump cover inlet ø 28 mm outlet ø 26 mm ø 100 mm		
	GEV No.	510532	Ref. No. X2228-HP,0,20_(1)
	impellor ø 72 mm H 22 mm pump type B229 thread M7		
	GEV No.	510695	Ref. No. N/A
	mechanical shaft seal height counter ring 5,5 mm		
	GEV No.	521703	Ref. No. N/A
	pump cover gasket EPDM thickness 2,5 mm ID ø 75 mm		



1





GEV No.	501446	Ref. No.	4213E2250
description	pump inlet ø 28mm outlet ø 26mm type 4213E2250 220-240V 50Hz 1 phase 0,19kW 0,26HP L 190mm rotation direction left capacitor 5µF FIR		
spare parts for	501446		
	GEV No.	365017	Ref. No. —
	operating capacitor capacity 5µF 450V		
	GEV No.	510384	Ref. No. N/A
	pump cover inlet ø 28 mm outlet ø 26 mm ø 100 mm		
	GEV No.	510695	Ref. No. N/A
	mechanical shaft seal height counter ring 5,5 mm		

spare parts for 501446

	GEV No.	521203	Ref. No.	N/A
	impellor ø 72 mm H 18 mm thread M7 shaft ø 11 mm			
	GEV No.	521703	Ref. No.	N/A
	pump cover gasket EPDM thickness 2,5 mm ID ø 75 mm			







1

GEV No.	500030	Ref. No.	4226.2540
description	pump inlet ø 28mm outlet ø 26mm type 4226.2540 230/400V 50Hz 3 phase 0,35kW 0,5HP L 260mm rotation direction right FIR		
spare parts for	500030		
	GEV No.	510510	Ref. No. X2212-HP,0,10_(1)
	pump cover pump type 2212/2228/2229/2211		
	GEV No.	510690	Ref. No. N/A
	mechanical shaft seal for shaft ø 8 mm ED ø 24 mm		
	GEV No.	521202	Ref. No. N/A
	impellor ø 72 mm H 17 mm thread M5L		
	GEV No.	521703	Ref. No. N/A
	pump cover gasket EPDM thickness 2,5 mm ID ø 75 mm		







1

GEV No.	500999	Ref. No.	4226.2541
description	pump inlet ø 28mm outlet ø 26mm type 4226.2541 230/400V 50Hz 3 phase 0,35kW 0,5HP L 260mm rotation direction right FIR		
spare parts for	500999		
	GEV No.	510510	Ref. No. X2212-HP0,10_(1)
	pump cover pump type 2212/2228/2229/2211		
	GEV No.	510690	Ref. No. N/A
	mechanical shaft seal for shaft ø 8 mm ED ø 24 mm		
	GEV No.	521279	Ref. No. N/A
	impellor ø 64 mm H 17 mm thread M5L blades 3		
	GEV No.	521703	Ref. No. N/A
	pump cover gasket EPDM thickness 2,5 mm ID ø 75 mm		



1

GEV No.	500019	Ref. No.	B229.1405
description	pump inlet ø 28mm outlet ø 26mm type B229.1405 230V 50Hz 1 phase 0,22kW 0,3HP L 200mm rotation direction right capacitor 5µF FIR		
spare parts for	500019		
	GEV No.	365017	Ref. No. —
	operating capacitor capacity 5µF 450V		
	GEV No.	510510	Ref. No. X2212-HP0,10_(1)
	pump cover pump type 2212/2228/2229/2211		
	GEV No.	510532	Ref. No. X2228-HP0,20_(1)
	impellor ø 72 mm H 22 mm pump type B229 thread M7		





spare parts for	500019		
	GEV No.	510695	Ref. No. N/A
	mechanical shaft seal height counter ring 5,5 mm		
	GEV No.	521703	Ref. No. N/A
	pump cover gasket EPDM thickness 2,5 mm ID ø 75 mm		



1

GEV No.	499227	Ref. No.	B236.1400
description	pump inlet ø 28mm outlet ø 26mm type B236.1400 220-240V 50Hz 1 phase 0,14kW 0,2HP L 200mm rotation direction left capacitor 6,3µF FIR		
spare parts for	499227		
	GEV No.	365012	Ref. No. —
	operating capacitor capacity 6,3µF 450V		
	GEV No.	510384	Ref. No. N/A
	pump cover inlet ø 28 mm outlet ø 26 mm ø 100 mm		
	GEV No.	510695	Ref. No. N/A
	mechanical shaft seal height counter ring 5,5 mm		
	GEV No.	521203	Ref. No. N/A
	impellor ø 72 mm H 18 mm thread M7 shaft ø 11 mm		
	GEV No.	521703	Ref. No. N/A
	pump cover gasket EPDM thickness 2,5 mm ID ø 75 mm		



1				
GEV No.	499279	Ref. No.	B246.2520	
description	pump inlet ø 28mm outlet ø 26mm type B246.2520 230/400V 50Hz 3 phase 0,18kW 0,25HP L 265mm rotation direction right FIR			
spare parts for	499279			
	GEV No.	510510	Ref. No.	X2212-HP,0,10_ (1)
	pump cover pump type 2212/2228/2229/2211			
	GEV No.	510532	Ref. No.	X2228-HP,0,20_ (1)
	impeller ø 72 mm H 22 mm pump type B229 thread M7			
	GEV No.	510695	Ref. No.	N/A
	mechanical shaft seal height counter ring 5,5 mm			
	GEV No.	521703	Ref. No.	N/A
	pump cover gasket EPDM thickness 2,5 mm ID ø 75 mm			



1				
GEV No.	499262	Ref. No.	5213.2450	
description	pump inlet ø 30mm outlet ø 26mm type 5213.2450 220-240V 50Hz 1 phase 0,28kW L 195mm rotation direction left capacitor 6,3µF FIR			



1				
GEV No.	499266	Ref. No.	5213.3951	
description	pump inlet ø 30mm outlet ø 26mm type 5213.3951 400V 50Hz 1 phase 0,28kW L 195mm rotation direction left capacitor 6,3µF FIR			



1				
GEV No.	499261	Ref. No.	5213.2160	
description	pump inlet ø 30mm outlet ø 26mm type 5213.2160 208-240V 60Hz 1 phase 0,28kW L 195mm rotation direction left capacitor 6,3µF FIR			



1

GEV No.	500598	Ref. No.	5213EB2450 5213EB2451
description	pump inlet ø 30mm outlet ø 26mm type 5213E2450 230V 50Hz 1 phase 0,22kW 0,1HP L 190mm rotation direction left capacitor 5µF FIR		
spare parts for 500598			
	GEV No.	365017	Ref. No. —
	operating capacitor capacity 5µF 450V		
	GEV No.	502265	Ref. No. 5213EB2450
	pump cover inlet ø 30 mm outlet ø 26 mm ID ø 89 mm		
	GEV No.	510695	Ref. No. N/A
	mechanical shaft seal height counter ring 5,5 mm		
	GEV No.	521203	Ref. No. N/A
	impellor ø 72 mm H 18 mm thread M7 shaft ø 11 mm		



1

GEV No.	499137	Ref. No.	5213E2452 5213EB2450
description	pump inlet ø 30mm outlet ø 26mm type 5213E2452 220/240V 50Hz 1 phase 0,07kW 0,1HP L 195mm rotation direction left capacitor 5µF FIR		
spare parts for 499137			
	GEV No.	365017	Ref. No. —
	operating capacitor capacity 5µF 450V		
	GEV No.	502250	Ref. No. —
	O-ring EPDM thickness 4mm ID ø 74mm Qty 1 pcs		
	GEV No.	502265	Ref. No. 5213EB2450
	pump cover inlet ø 30 mm outlet ø 26 mm ID ø 89 mm		

spare parts for 499137			
	GEV No.	510695	Ref. No. N/A
	mechanical shaft seal height counter ring 5,5 mm		
	GEV No.	521203	Ref. No. N/A
	impellor ø 72 mm H 18 mm thread M7 shaft ø 11 mm		
	GEV No.	532718	Ref. No. N/A
	O-ring EPDM thickness 4 mm ID ø 80 mm Qty 1 pcs		



1

GEV No.	500686	Ref. No.	1252.1401
description	pump inlet ø 30mm outlet ø 30mm type 1252.1401 230V 50Hz 1 phase 0,19kW 0,25HP L 180mm rotation direction right capacitor 10µF FIR		
spare parts for 500686			
	GEV No.	365015	Ref. No. —
	operating capacitor capacity 10µF 400V		
	GEV No.	510605	Ref. No. N/A
	impellor ø 80 mm H 21 mm M7L		
	GEV No.	510702	Ref. No. N/A
	mechanical shaft seal height counter ring 5,5 mm		
	GEV No.	521571	Ref. No. 2240303
	pump cover FIR inlet ø 30 mm outlet ø 30 mm		
	GEV No.	521701	Ref. No. N/A
	pump cover gasket		







1

GEV No.	500267	Ref. No.	1267.1400
description	pump inlet ø 30mm outlet ø 30mm type 1267.1400 230V 50Hz 1 phase 0,18kW 0,25HP L 185mm rotation direction right capacitor 10µF FIR		
spare parts for	500267		
	GEV No.	365015	Ref. No. —
	operating capacitor capacity 10µF 400V		
	GEV No.	510605	Ref. No. N/A
	impellor ø 80 mm H 21 mm M7L		
	GEV No.	510702	Ref. No. N/A
	mechanical shaft seal height counter ring 5,5 mm		
	GEV No.	521501	Ref. No. N/A
	pump cover inlet ø 30 mm outlet ø 30 mm		
	GEV No.	521701	Ref. No. N/A
	pump cover gasket		







1

GEV No.	500261	Ref. No.	1267.1405
description	pump inlet ø 30mm outlet ø 30mm type 1267.1405 230V 50Hz 1 phase 0,18kW 0,25HP L 180mm rotation direction right capacitor 10µF FIR		
spare parts for	500261		
	GEV No.	365015	Ref. No. —
	operating capacitor capacity 10µF 400V		
	GEV No.	510605	Ref. No. N/A
	impellor ø 80 mm H 21 mm M7L		
	GEV No.	510702	Ref. No. N/A
	mechanical shaft seal height counter ring 5,5 mm		

spare parts for 500261			
	GEV No.	521571	Ref. No. 2240303
	pump cover FIR inlet ø 30 mm outlet ø 30 mm		
	GEV No.	521701	Ref. No. N/A
	pump cover gasket		





1

GEV No.	500262	Ref. No.	1268.1401
description	pump inlet ø 30mm outlet ø 30mm type 1268.1401 230V 50Hz 1 phase 0,22kW 0,3HP L 185mm rotation direction right capacitor 10µF FIR		
spare parts for	500262		
	GEV No.	365015	Ref. No. —
	operating capacitor capacity 10µF 400V		
	GEV No.	510609	Ref. No. N/A
	impellor ø 84 mm H 21 mm M7L		
	GEV No.	510702	Ref. No. N/A
	mechanical shaft seal height counter ring 5,5 mm		
	GEV No.	521571	Ref. No. 2240303
	pump cover FIR inlet ø 30 mm outlet ø 30 mm		
	GEV No.	521701	Ref. No. N/A
	pump cover gasket		







1

GEV No.	500270	Ref. No.	1272/A
description	pump inlet ø 30mm outlet ø 30mm type 1272 230V 50Hz 1 phase 0,37kW 0,5HP L 195mm rotation direction right capacitor 12,5µF FIR		
spare parts for	500270		
	GEV No.	365014	Ref. No. —
	operating capacitor capacity 12,5µF 400V		
	GEV No.	510605	Ref. No. N/A
	impellor ø 80 mm H 21 mm M7L		
	GEV No.	510702	Ref. No. N/A
	mechanical shaft seal height counter ring 5,5 mm		
	GEV No.	521571	Ref. No. 2240303
	pump cover FIR inlet ø 30 mm outlet ø 30 mm		
	GEV No.	521701	Ref. No. N/A
	pump cover gasket		



1

GEV No.	500268	Ref. No.	1272/A
description	pump inlet ø 30mm outlet ø 30mm type 1272/A 230V 50Hz 1 phase 0,37kW 0,5HP L 195mm rotation direction right capacitor 12,5µF FIR		
spare parts for	500268		
	GEV No.	365014	Ref. No. —
	operating capacitor capacity 12,5µF 400V		
	GEV No.	510605	Ref. No. N/A
	impellor ø 80 mm H 21 mm M7L		
	GEV No.	510702	Ref. No. N/A
	mechanical shaft seal height counter ring 5,5 mm		
	GEV No.	521501	Ref. No. N/A
	pump cover inlet ø 30 mm outlet ø 30 mm		

spare parts for 500268

	GEV No.	521701	Ref. No.	N/A
	pump cover gasket			



1



GEV No.	500383	Ref. No.	1286.1406
description	pump inlet ø 30mm outlet ø 30mm type 1286.1406 230V 50Hz 1 phase 0,18kW 0,25HP rotation direction right FIR		



1

GEV No.	499171	Ref. No.	2240.1411
description	pump inlet ø 30mm outlet ø 30mm type 2240.1411 230V 50Hz 1 phase 0,24kW 0,33HP L 183mm rotation direction right capacitor 10µF FIR		
spare parts for	499171		
	GEV No.	365015	Ref. No. —
	operating capacitor capacity 10µF 400V		
	GEV No.	510607	Ref. No. N/A
	impellor ø 85 mm H 29 mm shaft intake ø 9x8mm		
	GEV No.	510695	Ref. No. N/A
	mechanical shaft seal height counter ring 5,5 mm		
	GEV No.	521571	Ref. No. 2240303
	pump cover FIR inlet ø 30 mm outlet ø 30 mm		







Table continues overleaf

spare parts for 499171			
	GEV No.	521701	Ref. No. N/A
	pump cover gasket		
	GEV No.	521707	Ref. No. N/A
	pump cover gasket		



GEV No.	499105	Ref. No.	2286D1405
description	pump inlet ø 30mm outlet ø 30mm type 2286D1405 220/240V 50Hz 1 phase 0,18kW 0,25HP L 180mm rotation direction right capacitor 10µF FIR		
spare parts for 499105			
	GEV No.	365015	Ref. No. —
	operating capacitor capacity 10µF 400V		
	GEV No.	510605	Ref. No. N/A
	impellor ø 80 mm H 21 mm M7L		
	GEV No.	510702	Ref. No. N/A
	mechanical shaft seal height counter ring 5,5 mm		
	GEV No.	521571	Ref. No. 2240303
	pump cover FIR inlet ø 30 mm outlet ø 30 mm		
	GEV No.	521701	Ref. No. N/A
	pump cover gasket		



GEV No.	500331	Ref. No.	B286.1650
description	pump inlet ø 30mm outlet ø 30mm type B286.1650 230V 50Hz 1 phase 0,37kW 0,5HP L 195mm rotation direction right capacitor 12,5µF FIR		
spare parts for 500331			
	GEV No.	365014	Ref. No. —
	operating capacitor capacity 12,5µF 400V		
	GEV No.	510607	Ref. No. N/A
	impellor ø 85 mm H 29 mm shaft intake ø 9x8mm		
	GEV No.	510695	Ref. No. N/A
	mechanical shaft seal height counter ring 5,5 mm		
	GEV No.	521571	Ref. No. 2240303
	pump cover FIR inlet ø 30 mm outlet ø 30 mm		
	GEV No.	521701	Ref. No. N/A
	pump cover gasket		
	GEV No.	521707	Ref. No. N/A
	pump cover gasket		





GEV No.	500327	Ref. No.	B287.1650
description	pump inlet ø 30mm outlet ø 30mm type B287.1650 230V 50Hz 1 phase 0,24kW 0,33HP L 180mm rotation direction right capacitor 10µF FIR		
spare parts for 500327			
	GEV No.	365015	Ref. No. —
	operating capacitor capacity 10µF 400V		

Table continues overleaf

spare parts for 500327			
	GEV No.	510607	Ref. No. N/A
impellor ø 85 mm H 29 mm shaft intake ø 9x8mm			
	GEV No.	510695	Ref. No. N/A
mechanical shaft seal height counter ring 5,5 mm			
	GEV No.	521571	Ref. No. 2240303
pump cover FIR inlet ø 30 mm outlet ø 30 mm			
	GEV No.	521701	Ref. No. N/A
pump cover gasket			
	GEV No.	521707	Ref. No. N/A
pump cover gasket			





GEV No.	499327	Ref. No.	5215.4150
description	pump inlet ø 30mm outlet ø 35mm type 5215.4150 200-254/346-440VV 50Hz 3 phase		
spare parts for	499327		
	GEV No.	521079	Ref. No. —
fanwheel cover ø 155mm H 70mm plastic			



GEV No.	499321	Ref. No.	B242C2702
description	pump inlet ø 30mm outlet ø 35mm type B242C2702 230V 50Hz 3 phase 0,55kW L 300mm rotation direction right FIR		



GEV No.	500020	Ref. No.	4134.1402
description	pump inlet ø 32mm outlet ø 32mm type 4134.1402 230V 50Hz 1 phase 0,18kW 0,25HP L 180mm rotation direction right capacitor 10µF FIR		
spare parts for	500020		
	GEV No.	510506	Ref. No. —
pump cover pump type 4333/1265			
accessories for	500020		
	GEV No.	504329	Ref. No. —
blind plug H 17,5mm thread M16x1.5 plastic WS 22			











GEV No.	500558	Ref. No.	B226H1500
description	pump inlet ø 33mm outlet ø 30/28mm type B266H1500 230V 50Hz 1 phase 0,22kW 0,3HP L 195mm rotation direction right capacitor 5µF FIR		
spare parts for	500558		
	GEV No.	365017	Ref. No. —
operating capacitor capacity 5µF 450V			
	GEV No.	510693	Ref. No. N/A
mechanical shaft seal for shaft ø 12 mm			
	GEV No.	521545	Ref. No. N/A
pump cover FIR type B226H inlet ø 33 mm			





Table continues overleaf

spare parts for 500558				
image not available	GEV No.	521565	Ref. No.	N/A
	pump cover gasket pump type B226H			
	GEV No.	521566	Ref. No.	N/A
	impellor ø 80 mm H 15 mm M7L pump type B226H			



GEV No.	500561	Ref. No.	B221A	
description	pump inlet ø 33mm outlet ø 30mm type B221A 230V 50Hz 1 phase 0,15kW 0,2HP L 195mm rotation direction left capacitor 6,3µF FIR			
spare parts for 500561				
	GEV No.	365012	Ref. No.	—
operating capacitor capacity 6,3µF 450V				
	GEV No.	501309	Ref. No.	N/A
impellor ø 80 mm H 19 mm M7R pump type type D1				
	GEV No.	501310	Ref. No.	—
pump cover				
	GEV No.	510693	Ref. No.	N/A
mechanical shaft seal for shaft ø 12 mm				



GEV No.	500274	Ref. No.	B221A1500	
description	pump inlet ø 33mm outlet ø 30mm type B221A1500 230V 50Hz 1 phase 0,15kW 0,2HP L 195mm rotation direction left capacitor 6,3µF FIR			
spare parts for 500274				
	GEV No.	365012	Ref. No.	—
operating capacitor capacity 6,3µF 450V				
	GEV No.	501309	Ref. No.	N/A
impellor ø 80 mm H 19 mm M7R pump type type D1				
	GEV No.	510693	Ref. No.	N/A
mechanical shaft seal for shaft ø 12 mm				
image not available	GEV No.	521500	Ref. No.	N/A
	pump cover			
	GEV No.	521700	Ref. No.	N/A
	pump cover gasket			
	GEV No.	551223	Ref. No.	—
housing 4-pole size 6,3mm straight nylon				







GEV No.	500388	Ref. No.	B265.1500	
description	pump inlet ø 33mm outlet ø 30mm type B265.1500 230V 50Hz 1 phase 0,22kW 0,3HP L 265mm rotation direction left capacitor 6,3µF FIR			
spare parts for 500388				
	GEV No.	365012	Ref. No.	—
operating capacitor capacity 6,3µF 450V				





Table continues overleaf



spare parts for 500388			
	GEV No.	501309	Ref. No. N/A
impellor ø 80 mm H 19 mm M7R pump type type D1			
	GEV No.	510702	Ref. No. N/A
mechanical shaft seal height counter ring 5,5 mm			
image not available	GEV No.	521500	Ref. No. N/A
pump cover			
	GEV No.	521700	Ref. No. N/A
pump cover gasket			



1			
GEV No.	500127	Ref. No.	4247.1900
description	pump inlet ø 37mm outlet ø 41mm type 4247.1900 230V 50Hz 1 phase 0,44kW 0,6HP L 200mm rotation direction right capacitor 10µF FIR		

spare parts for 500127			
	GEV No.	365015	Ref. No. —
operating capacitor capacity 10µF 400V			
	GEV No.	510608	Ref. No. N/A
impellor ø 93 mm H 32 mm shaft intake ø 9/8mm			
	GEV No.	510692	Ref. No. N/A
mechanical shaft seal for shaft ø 11 mm			
	GEV No.	521505	Ref. No. X4247-HP0,6_(1)
pump cover FIR inlet ø 37 mm outlet ø 40 mm			
	GEV No.	521702	Ref. No. N/A
pump cover gasket thickness 3.5x4.5mm Qty 1 pcs			



1			
GEV No.	499170	Ref. No.	4243.1400
description	pump inlet ø 45mm outlet ø 1" IT type 4243.1400 230V 1 phase 0,55kW 0,75HP L 310mm rotation direction right capacitor 12,5µF FIR		



1			
GEV No.	500463	Ref. No.	2253
description	pump inlet ø 45mm outlet ø 30mm type 2253 230V 50Hz 1 phase 0,24kW 0,33HP L 160mm rotation direction right FIR		

spare parts for 500463			
image not available	GEV No.	521148	Ref. No. —
pump cover pump type Fir 2253(500.463)			







1

GEV No.	500125	Ref. No.	2253
description	pump inlet ø 45mm outlet ø 30mm type 2253 230V 50Hz 1 phase 0,24kW 0,33HP L 175mm rotation direction right capacitor 10µF FIR inlet ø 45mm outlet ø 30mm		



1

GEV No.	499165	Ref. No.	1297.1900
description	pump inlet ø 45mm outlet ø 32mm type 1297.1900 230V 50Hz 1 phase 0,29kW 0,4HP L 165mm rotation direction right capacitor 8µF FIR		
spare parts for	499165		
	GEV No.	365013	Ref. No. —
	operating capacitor capacity 8µF 400V		
	GEV No.	510512	Ref. No. —
	pump cover OLYMPIA inlet ø 45 mm outlet ø 31 mm		
	GEV No.	510554	Ref. No. —
	O-ring EPDM thickness 2 mm ID ø 120 mm Qty 1 pcs		
	GEV No.	510615	Ref. No. —
	impellor ø 90 mm H 22 mm rotation direction right		
	GEV No.	510693	Ref. No. N/A
	mechanical shaft seal for shaft ø 12 mm		



1

GEV No.	501464	Ref. No.	3910.1423
description	pump inlet ø 45mm outlet ø 39mm type 3910.1423 230V 50Hz 1 phase 0,4kW L 220mm rotation direction right capacitor 10µF FIR		
spare parts for	501464		
	GEV No.	365015	Ref. No. —
	operating capacitor capacity 10µF 400V		
	GEV No.	510508	Ref. No. N/A
	pump cover FIR inlet ø 45 mm outlet ø 40 mm		
	GEV No.	510607	Ref. No. N/A
	impellor ø 85 mm H 29 mm shaft intake ø 9x8mm		
	GEV No.	510692	Ref. No. N/A
	mechanical shaft seal for shaft ø 11 mm		
	GEV No.	521702	Ref. No. N/A
	pump cover gasket thickness 3.5x4.5mm Qty 1 pcs		







1

GEV No.	500710	Ref. No.	1217/A
description	pump inlet ø 45mm outlet ø 40mm type 1217/A 230V 50Hz 1 phase 0,56kW 0,75HP L 295mm rotation direction right capacitor 12,5µF FIR		







1

GEV No.	500017	Ref. No.	1219.1405
description	pump inlet ø 45mm outlet ø 40mm type 1219.1405 230V 50Hz 1 phase 0,73kW 1HP L 300mm rotation direction right capacitor 12,5µF FIR		
spare parts for	500017		
	GEV No.	365014	Ref. No. —
	operating capacitor capacity 12,5µF 400V		
	GEV No.	510600	Ref. No. N/A
	impellor ø 102 mm H 29 mm shaft intake ø 9/8mm		
	GEV No.	510692	Ref. No. N/A
	mechanical shaft seal for shaft ø 11 mm		
	GEV No.	521539	Ref. No. N/A
	pump cover FIR inlet ø 45 mm outlet ø 40 mm		
	GEV No.	521702	Ref. No. N/A
	pump cover gasket thickness 3.5x4.5mm Qty 1 pcs		







1

GEV No.	499140	Ref. No.	1219.2504
description	pump inlet ø 45mm outlet ø 40mm type 1219.2504 220/380-240/415V 50Hz 3 phase 1,1kW 1,5HP L 290mm rotation direction right FIR		
spare parts for	499140		
	GEV No.	502007	Ref. No. N/A
	pump cover gasket		

spare parts for	499140		
	GEV No.	510529	Ref. No. N/A
	impellor ø 103 mm H 30 mm shaft intake ø 9/8mm		
	GEV No.	510692	Ref. No. N/A
	mechanical shaft seal for shaft ø 11 mm		
	GEV No.	511187	Ref. No. N/A
	pump cover FIR inlet ø 45 mm outlet ø 40 mm		





1



GEV No.	500004	Ref. No.	1219.2521
description	pump inlet ø 45mm outlet ø 40mm type 1219.2521 230/400V 50Hz 3 phase 1,1kW 1,5HP L 300mm rotation direction right capacitorµF FIR		
spare parts for	500004		
	GEV No.	502007	Ref. No. N/A
	pump cover gasket		
	GEV No.	510529	Ref. No. N/A
	impellor ø 103 mm H 30 mm shaft intake ø 9/8mm		
	GEV No.	510692	Ref. No. N/A
	mechanical shaft seal for shaft ø 11 mm		
	GEV No.	511187	Ref. No. N/A
	pump cover FIR inlet ø 45 mm outlet ø 40 mm		







GEV No.	500033	Ref. No.	1221.1400
description	pump inlet ø 45mm outlet ø 40mm type 1221.1400 230V 50Hz 1 phase 0,37kW 0,5HP L 210mm rotation direction right capacitor 12,5µF FIR		
spare parts for	500033		
	GEV No.	365014	Ref. No. —
	operating capacitor capacity 12,5µF 400V		
	GEV No.	502007	Ref. No. N/A
	pump cover gasket		
	GEV No.	510607	Ref. No. N/A
	impellor ø 85 mm H 29 mm shaft intake ø 9x8mm		
	GEV No.	510692	Ref. No. N/A
	mechanical shaft seal for shaft ø 11 mm		
	GEV No.	511187	Ref. No. N/A
	pump cover FIR inlet ø 45 mm outlet ø 40 mm		



GEV No.	500009	Ref. No.	1222.1406
description	pump inlet ø 45mm outlet ø 40mm type 1222.1406 230V 50Hz 1 phase 0,37kW 0,5HP L 275mm rotation direction right capacitor 12,5µF FIR		
spare parts for	500009		
	GEV No.	365014	Ref. No. —
	operating capacitor capacity 12,5µF 400V		
	GEV No.	502007	Ref. No. N/A
	pump cover gasket		

spare parts for 500009			
	GEV No.	510607	Ref. No. N/A
	impellor ø 85 mm H 29 mm shaft intake ø 9x8mm		
	GEV No.	510692	Ref. No. N/A
	mechanical shaft seal for shaft ø 11 mm		
	GEV No.	511187	Ref. No. N/A
	pump cover FIR inlet ø 45 mm outlet ø 40 mm		



GEV No.	499071	Ref. No.	1222.2800
description	pump inlet ø 45mm outlet ø 40mm type 1222.2800 440V 60Hz 0,37kW 0,5HP L 275mm rotation direction right FIR		
spare parts for	499071		
	GEV No.	502007	Ref. No. N/A
	pump cover gasket		
	GEV No.	510528	Ref. No. —
	flange suitable for pump		
	GEV No.	510692	Ref. No. N/A
	mechanical shaft seal for shaft ø 11 mm		
	GEV No.	511187	Ref. No. N/A
	pump cover FIR inlet ø 45 mm outlet ø 40 mm		



1

GEV No.	500086	Ref. No.	1223.1400
description	pump inlet ø 45mm outlet ø 40mm type 1223.1400 230V 50Hz 1 phase 0,55kW 0,75HP L 275mm rotation direction right capacitor 12,5µF FIR		
spare parts for	500086		
	GEV No.	365014	Ref. No. —
	operating capacitor capacity 12,5µF 400V		
	GEV No.	502007	Ref. No. N/A
	pump cover gasket		
	GEV No.	510608	Ref. No. N/A
	impellor ø 93 mm H 32 mm shaft intake ø 9/8mm		
	GEV No.	510692	Ref. No. N/A
	mechanical shaft seal for shaft ø 11 mm		
	GEV No.	511187	Ref. No. N/A
	pump cover FIR inlet ø 45 mm outlet ø 40 mm		
	GEV No.	521022	Ref. No. —
	fanwheel cover ID ø 137mm ED ø 142mm H 70mm		



1

GEV No.	500254	Ref. No.	1266.1400
description	pump inlet ø 45mm outlet ø 40mm type 1266.1400 230V 50Hz 1 phase 0,37kW 0,5HP L 205mm rotation direction right capacitor 12,5µF FIR		
spare parts for	500254		
	GEV No.	365014	Ref. No. —
	operating capacitor capacity 12,5µF 400V		
	GEV No.	510508	Ref. No. N/A
	pump cover FIR inlet ø 45 mm outlet ø 40 mm		
	GEV No.	510692	Ref. No. N/A
	mechanical shaft seal for shaft ø 11 mm		
	GEV No.	521210	Ref. No. N/A
	impellor ø 96 mm H 30 mm shaft intake ø 9/8mm		
	GEV No.	521702	Ref. No. N/A
	pump cover gasket thickness 3.5x4.5mm Qty 1 pcs		





1

GEV No.	500256	Ref. No.	1270/A
description	pump inlet ø 45mm outlet ø 40mm type 1270 230V 50Hz 1 phase 0,55kW 0,75HP L 205mm rotation direction right capacitor 12,5µF FIR		
spare parts for	500256		
	GEV No.	365014	Ref. No. —
	operating capacitor capacity 12,5µF 400V		
	GEV No.	510508	Ref. No. N/A
	pump cover FIR inlet ø 45 mm outlet ø 40 mm		





Table continues overleaf



spare parts for 500256			
	GEV No.	510692	Ref. No. N/A
mechanical shaft seal for shaft ø 11 mm			
	GEV No.	521210	Ref. No. N/A
impellor ø 96 mm H 30 mm shaft intake ø 9/8mm			
	GEV No.	521702	Ref. No. N/A
pump cover gasket thickness 3.5x4.5mm Qty 1 pcs			







1

GEV No.	500252	Ref. No.	1270.1402
description	pump inlet ø 45mm outlet ø 40mm type 1270/A 230V 50Hz 1 phase 0,55kW 0,75HP L 205mm rotation direction right capacitor 12,5µF FIR		
spare parts for 500252			
	GEV No.	365014	Ref. No. —
operating capacitor capacity 12,5µF 400V			
	GEV No.	510508	Ref. No. N/A
pump cover FIR inlet ø 45 mm outlet ø 40 mm			
	GEV No.	510692	Ref. No. N/A
mechanical shaft seal for shaft ø 11 mm			
	GEV No.	521210	Ref. No. N/A
impellor ø 96 mm H 30 mm shaft intake ø 9/8mm			
	GEV No.	521702	Ref. No. N/A
pump cover gasket thickness 3.5x4.5mm Qty 1 pcs			



1

GEV No.	500289	Ref. No.	1276.2530
description	pump inlet ø 45mm outlet ø 40mm type 1276.2530 230/400V 50Hz 3 phase 0,55kW 0,75HP L 270mm rotation direction right FIR		
spare parts for 500289			
	GEV No.	501314	Ref. No. N/A
impellor ø 75 mm			
	GEV No.	502007	Ref. No. N/A
pump cover gasket			
	GEV No.	502014	Ref. No. N/A
pump cover FIR inlet ø 45 mm outlet ø 40 mm			
	GEV No.	510692	Ref. No. N/A
mechanical shaft seal for shaft ø 11 mm			



1











GEV No.	500707	Ref. No.	1278.1401
description	pump inlet ø 45mm outlet ø 40mm type 1278.1401 230V 50Hz 1 phase 0,75kW 1HP L 210mm rotation direction right capacitor 12,5µF FIR		
spare parts for 500707			
	GEV No.	365014	Ref. No. —
operating capacitor capacity 12,5µF 400V			
	GEV No.	510508	Ref. No. N/A
pump cover FIR inlet ø 45 mm outlet ø 40 mm			





Table continues overleaf

spare parts for 500707			
	GEV No.	510610	Ref. No. N/A
impellor ø 95,5 mm H 23 mm shaft intake ø 9/8mm			
	GEV No.	510692	Ref. No. N/A
mechanical shaft seal for shaft ø 11 mm			
	GEV No.	521702	Ref. No. N/A
pump cover gasket thickness 3.5x4.5mm Qty 1 pcs			



1			
GEV No.	500027	Ref. No.	1292.1400
description	pump inlet ø 45mm outlet ø 40mm type 1292.1400 230V 50Hz 1 phase 0,56kW 0,75HP L 200mm rotation direction right capacitor 12,5µF FIR		
spare parts for 500027			
	GEV No.	365014	Ref. No. —
operating capacitor capacity 12,5µF 400V			
	GEV No.	510600	Ref. No. N/A
impellor ø 102 mm H 29 mm shaft intake ø 9/8mm			
	GEV No.	510692	Ref. No. N/A
mechanical shaft seal for shaft ø 11 mm			
	GEV No.	521506	Ref. No. N/A
pump cover FIR inlet ø 45 mm outlet ø 40 mm			
	GEV No.	521702	Ref. No. N/A
pump cover gasket thickness 3.5x4.5mm Qty 1 pcs			



1			
GEV No.	500684	Ref. No.	1299.1402
description	pump inlet ø 45mm outlet ø 40mm type 1299.1402 230V 50Hz 1 phase 0,37kW 0,5HP L 208mm rotation direction right capacitor 12,5µF FIR		
spare parts for 500684			
	GEV No.	365014	Ref. No. —
operating capacitor capacity 12,5µF 400V			
	GEV No.	510508	Ref. No. N/A
pump cover FIR inlet ø 45 mm outlet ø 40 mm			
	GEV No.	510607	Ref. No. N/A
impellor ø 85 mm H 29 mm shaft intake ø 9x8mm			
	GEV No.	510692	Ref. No. N/A
mechanical shaft seal for shaft ø 11 mm			
	GEV No.	521702	Ref. No. N/A
pump cover gasket thickness 3.5x4.5mm Qty 1 pcs			













1			
GEV No.	500549	Ref. No.	2220
description	pump inlet ø 45mm outlet ø 40mm type 2220 230V 50Hz 1 phase 0,73kW 1HP L 235mm rotation direction right capacitor 16µF FIR		
spare parts for 500549			
	GEV No.	365021	Ref. No. —
operating capacitor capacity 16µF 425V			



Table continues overleaf

spare parts for 500549			
	GEV No.	502007	Ref. No. N/A
pump cover gasket			
	GEV No.	502014	Ref. No. N/A
pump cover FIR inlet ø 45 mm outlet ø 40 mm			
	GEV No.	510529	Ref. No. N/A
impellor ø 103 mm H 30 mm shaft intake ø 9/8mm			
	GEV No.	510692	Ref. No. N/A
mechanical shaft seal for shaft ø 11 mm			



GEV No.	500118	Ref. No.	2236.1400
description	pump inlet ø 45mm outlet ø 40mm type 2236.1400 230V 50Hz 1 phase 0,74kW 1HP L 235mm rotation direction right capacitor 16µF FIR		
spare parts for 500118			
	GEV No.	365021	Ref. No. —
operating capacitor capacity 16µF 425V			
	GEV No.	510508	Ref. No. N/A
pump cover FIR inlet ø 45 mm outlet ø 40 mm			
	GEV No.	510600	Ref. No. N/A
impellor ø 102 mm H 29 mm shaft intake ø 9/8mm			
	GEV No.	510692	Ref. No. N/A
mechanical shaft seal for shaft ø 11 mm			
	GEV No.	521702	Ref. No. N/A
pump cover gasket thickness 3.5x4.5mm Qty 1 pcs			



GEV No.	500702	Ref. No.	2246.1400
description	pump inlet ø 45mm outlet ø 40mm type 2246.1400 230V 50Hz 1 phase 0,24kW 0,33HP L 195mm rotation direction right capacitor 10µF FIR		
spare parts for 500702			
	GEV No.	365015	Ref. No. —
operating capacitor capacity 10µF 400V			
	GEV No.	510607	Ref. No. N/A
impellor ø 85 mm H 29 mm shaft intake ø 9x8mm			
	GEV No.	510692	Ref. No. N/A
mechanical shaft seal for shaft ø 11 mm			
	GEV No.	521539	Ref. No. N/A
pump cover FIR inlet ø 45 mm outlet ø 40 mm			
	GEV No.	521702	Ref. No. N/A
pump cover gasket thickness 3.5x4.5mm Qty 1 pcs			













GEV No.	500287	Ref. No.	2256.1420
description	pump inlet ø 45mm outlet ø 40mm type 2256.1420 230V 50Hz 1 phase 0,73kW 1HP L 200mm rotation direction right capacitor 16µF FIR		
spare parts for 500287			
	GEV No.	365021	Ref. No. —
operating capacitor capacity 16µF 425V			

Table continues overleaf

spare parts for 500287			
	GEV No.	501313	Ref. No. N/A
impellor ø 103 mm H 28 mm shaft intake ø 9/8mm			
	GEV No.	502007	Ref. No. N/A
pump cover gasket			
	GEV No.	502014	Ref. No. N/A
pump cover FIR inlet ø 45 mm outlet ø 40 mm			
	GEV No.	510692	Ref. No. N/A
mechanical shaft seal for shaft ø 11 mm			



GEV No.	499216	Ref. No.	2256T2550
description	pump inlet ø 45mm outlet ø 40mm type 2256T2550 180-253V 50Hz 1 phase 0,75kW 1HP L 250mm rotation direction right capacitor 20µF FIR		

spare parts for 499216			
	GEV No.	365019	Ref. No. —
operating capacitor capacity 20µF 400V			
	GEV No.	501313	Ref. No. N/A
impellor ø 103 mm H 28 mm shaft intake ø 9/8mm			
	GEV No.	502007	Ref. No. N/A
pump cover gasket			
	GEV No.	502014	Ref. No. N/A
pump cover FIR inlet ø 45 mm outlet ø 40 mm			
	GEV No.	510692	Ref. No. N/A
mechanical shaft seal for shaft ø 11 mm			



GEV No.	499069	Ref. No.	2256V1425
description	pump inlet ø 45mm outlet ø 40mm type 2256V1425 230V 50Hz 1 phase 0,74kW 1HP L 235mm rotation direction right capacitor 16µF FIR		

spare parts for 499069			
	GEV No.	365021	Ref. No. —
operating capacitor capacity 16µF 425V			
	GEV No.	499188	Ref. No. 2256V1425
pump inlet ø 45mm outlet ø 40mm type 2256V1425			
	GEV No.	510529	Ref. No. N/A
impellor ø 103 mm H 30 mm shaft intake ø 9/8mm			
	GEV No.	510692	Ref. No. N/A
mechanical shaft seal for shaft ø 11 mm			
	GEV No.	521539	Ref. No. N/A
pump cover FIR inlet ø 45 mm outlet ø 40 mm			
	GEV No.	521702	Ref. No. N/A
pump cover gasket thickness 3.5x4.5mm Qty 1 pcs			



GEV No.	499188	Ref. No.	2256V1425
description	pump inlet ø 45mm outlet ø 40mm type 2256V1425 230V 50Hz 1 phase 0,75kW 1HP L 235mm rotation direction right capacitor 16µF FIR		















spare parts for 499188			
	GEV No.	365021	Ref. No. —
operating capacitor capacity 16µF 425V			

Table continues overleaf

spare parts for 499188			
	GEV No.	499188	Ref. No. 2256V1425
pump inlet ø 45mm outlet ø 40mm type 2256V1425			
	GEV No.	510529	Ref. No. N/A
impellor ø 103 mm H 30 mm shaft intake ø 9/8mm			
	GEV No.	510692	Ref. No. N/A
mechanical shaft seal for shaft ø 11 mm			
	GEV No.	521539	Ref. No. N/A
pump cover FIR inlet ø 45 mm outlet ø 40 mm			
	GEV No.	521702	Ref. No. N/A
pump cover gasket thickness 3.5x4.5mm Qty 1 pcs			

			
1			
GEV No.	500269	Ref. No.	2265.1920
description	pump inlet ø 45mm outlet ø 40mm type 2265.1920 230V 50Hz 1 phase 0,55kW 0,75HP L 245mm rotation direction right capacitor 16µF FIR		
spare parts for	500269		
	GEV No.	365021	Ref. No. —
operating capacitor capacity 16µF 425V			
	GEV No.	510508	Ref. No. N/A
pump cover FIR inlet ø 45 mm outlet ø 40 mm			
	GEV No.	510600	Ref. No. N/A
impellor ø 102 mm H 29 mm shaft intake ø 9/8mm			
	GEV No.	510692	Ref. No. N/A
mechanical shaft seal for shaft ø 11 mm			
	GEV No.	521023	Ref. No. —
fanwheel cover ED ø 150mm H 70mm for wash pump			
	GEV No.	521702	Ref. No. N/A
pump cover gasket thickness 3.5x4.5mm Qty 1 pcs			

			
1			
GEV No.	500263	Ref. No.	2265.1921
description	pump inlet ø 45mm outlet ø 40mm type 2265.1921 230V 50Hz 1 phase 0,55kW 0,75HP L 250mm rotation direction right capacitor 16µF FIR		
spare parts for	500263		
	GEV No.	365021	Ref. No. —
operating capacitor capacity 16µF 425V			
	GEV No.	510508	Ref. No. N/A
pump cover FIR inlet ø 45 mm outlet ø 40 mm			
	GEV No.	510600	Ref. No. N/A
impellor ø 102 mm H 29 mm shaft intake ø 9/8mm			
	GEV No.	510692	Ref. No. N/A
mechanical shaft seal for shaft ø 11 mm			
	GEV No.	521023	Ref. No. —
fanwheel cover ED ø 150mm H 70mm for wash pump			
	GEV No.	521702	Ref. No. N/A
pump cover gasket thickness 3.5x4.5mm Qty 1 pcs			



1			
GEV No.	499134	Ref. No.	2282
description	pump inlet ø 45mm outlet ø 40mm type 2282 230V 50Hz 0,37kW 0,5HP L 205mm rotation direction right capacitor 12,5µF auxiliary pressure connection 11mm supporting pressure open FIR		
spare parts for	499134		
	GEV No.	365014	Ref. No. —
	operating capacitor capacity 12,5µF 400V		
	GEV No.	510607	Ref. No. N/A
	impellor ø 85 mm H 29 mm shaft intake ø 9x8mm		
	GEV No.	510692	Ref. No. N/A
	mechanical shaft seal for shaft ø 11 mm		
	GEV No.	521539	Ref. No. N/A
	pump cover FIR inlet ø 45 mm outlet ø 40 mm		
	GEV No.	521702	Ref. No. N/A
	pump cover gasket thickness 3.5x4.5mm Qty 1 pcs		

spare parts for	500010		
	GEV No.	510600	Ref. No. N/A
	impellor ø 102 mm H 29 mm shaft intake ø 9/8mm		
	GEV No.	510692	Ref. No. N/A
	mechanical shaft seal for shaft ø 11 mm		
	GEV No.	521023	Ref. No. —
	fanwheel cover ED ø 150mm H 70mm for wash pump		
	GEV No.	521506	Ref. No. N/A
	pump cover FIR inlet ø 45 mm outlet ø 40 mm		
	GEV No.	521702	Ref. No. N/A
	pump cover gasket thickness 3.5x4.5mm Qty 1 pcs		



1			
GEV No.	499151	Ref. No.	3910.1421
description	pump inlet ø 45mm outlet ø 40mm type 3910.1421 230V 50Hz 1 phase 0,37kW 0,5HP L 190mm rotation direction right capacitor 10µF FIR		
spare parts for	499151		
	GEV No.	365015	Ref. No. —
	operating capacitor capacity 10µF 400V		
	GEV No.	510508	Ref. No. N/A
	pump cover FIR inlet ø 45 mm outlet ø 40 mm		
	GEV No.	510607	Ref. No. N/A
	impellor ø 85 mm H 29 mm shaft intake ø 9x8mm		
	GEV No.	510692	Ref. No. N/A
	mechanical shaft seal for shaft ø 11 mm		
	GEV No.	521702	Ref. No. N/A
	pump cover gasket thickness 3.5x4.5mm Qty 1 pcs		



1			
GEV No.	500010	Ref. No.	2292.1400 2292.1506
description	pump inlet ø 45mm outlet ø 40mm type 2292.1506 230V 50Hz 1 phase 0,55kW 0,75HP L 238mm rotation direction right capacitor 12,5µF FIR		
spare parts for	500010		
	GEV No.	365014	Ref. No. —
	operating capacitor capacity 12,5µF 400V		



1

GEV No.	500389	Ref. No.	3911
description	pump inlet ø 45mm outlet ø 40mm type 3911 230V 50Hz 1 phase 0,55kW 0,75HP rotation direction right FIR		



1

GEV No.	500479	Ref. No.	3911.1423
description	pump inlet ø 45mm outlet ø 40mm type 3911.1423 230V 50Hz 1 phase 0,56kW 0,75HP L 204mm rotation direction right capacitor 10µF FIR		



1

GEV No.	500249	Ref. No.	3911.1421
description	pump inlet ø 45mm outlet ø 40mm type 3911.1421 230V 50Hz 1 phase 0,55kW 0,75HP L 205mm rotation direction right capacitor 12,5µF FIR		

spare parts for 500249

	GEV No.	365014	Ref. No.	—
		operating capacitor capacity 12,5µF 400V		
	GEV No.	502007	Ref. No.	N/A
		pump cover gasket		
	GEV No.	502014	Ref. No.	N/A
		pump cover FIR inlet ø 45 mm outlet ø 40 mm		
	GEV No.	510610	Ref. No.	N/A
		impellor ø 95,5 mm H 23 mm shaft intake ø 9/8mm		
	GEV No.	510692	Ref. No.	N/A
		mechanical shaft seal for shaft ø 11 mm		

spare parts for 500479

	GEV No.	365015	Ref. No.	—
		operating capacitor capacity 10µF 400V		
	GEV No.	510508	Ref. No.	N/A
		pump cover FIR inlet ø 45 mm outlet ø 40 mm		
	GEV No.	510610	Ref. No.	N/A
		impellor ø 95,5 mm H 23 mm shaft intake ø 9/8mm		
	GEV No.	510692	Ref. No.	N/A
		mechanical shaft seal for shaft ø 11 mm		
	GEV No.	521702	Ref. No.	N/A
		pump cover gasket thickness 3.5x4.5mm Qty 1 pcs		







1

GEV No.	500038	Ref. No.	3911.1425
description	pump inlet ø 45mm outlet ø 40mm type 3911.1425 230V 50Hz 1 phase 0,55kW 0,75HP L 205mm rotation direction right capacitor 10µF FIR		

spare parts for 500038





	GEV No.	365015	Ref. No.	—
		operating capacitor capacity 10µF 400V		

Table continues overleaf

spare parts for 500038			
	GEV No.	510508	Ref. No. N/A
pump cover FIR inlet ø 45 mm outlet ø 40 mm			
	GEV No.	510610	Ref. No. N/A
impeller ø 95,5 mm H 23 mm shaft intake ø 9/8mm			
	GEV No.	510692	Ref. No. N/A
mechanical shaft seal for shaft ø 11 mm			
	GEV No.	521702	Ref. No. N/A
pump cover gasket thickness 3.5x4.5mm Qty 1 pcs			



1

GEV No.	499189	Ref. No.	3911.1428
description	pump inlet ø 45mm outlet ø 40mm type 3911.1428 230V 50Hz 1 phase 0,55kW 0,75HP L 211mm rotation direction right capacitor 12,5µF FIR		
spare parts for 499189			
	GEV No.	365014	Ref. No. —
operating capacitor capacity 12,5µF 400V			
	GEV No.	510508	Ref. No. N/A
pump cover FIR inlet ø 45 mm outlet ø 40 mm			
	GEV No.	510610	Ref. No. N/A
impeller ø 95,5 mm H 23 mm shaft intake ø 9/8mm			
	GEV No.	510692	Ref. No. N/A
mechanical shaft seal for shaft ø 11 mm			
	GEV No.	521702	Ref. No. N/A
pump cover gasket thickness 3.5x4.5mm Qty 1 pcs			



1

GEV No.	499335	Ref. No.	3911K1513
description	pump inlet ø 45mm outlet ø 40mm type 3911K1513 230V 50Hz 1 phase 0,55kW 0,75HP L 205mm rotation direction right capacitor 12,5µF FIR		
spare parts for 499335			
	GEV No.	365014	Ref. No. —
operating capacitor capacity 12,5µF 400V			
	GEV No.	510508	Ref. No. N/A
pump cover FIR inlet ø 45 mm outlet ø 40 mm			
	GEV No.	510610	Ref. No. N/A
impeller ø 95,5 mm H 23 mm shaft intake ø 9/8mm			
	GEV No.	510692	Ref. No. N/A
mechanical shaft seal for shaft ø 11 mm			
	GEV No.	521702	Ref. No. N/A
pump cover gasket thickness 3.5x4.5mm Qty 1 pcs			



1







GEV No.	501502	Ref. No.	3911K2530
description	pump inlet ø 45mm outlet ø 40mm type 3911K2530 180-253V 50Hz 1 phase 0,55kW 0,75HP L 205mm rotation direction right capacitor 10µF FIR		
spare parts for 501502			
	GEV No.	365014	Ref. No. —
operating capacitor capacity 12,5µF 400V			
	GEV No.	510508	Ref. No. N/A
pump cover FIR inlet ø 45 mm outlet ø 40 mm			

Table continues overleaf

spare parts for 501502			
	GEV No.	510610	Ref. No. N/A
impellor ø 95,5 mm H 23 mm shaft intake ø 9/8mm			
	GEV No.	510692	Ref. No. N/A
mechanical shaft seal for shaft ø 11 mm			
	GEV No.	521702	Ref. No. N/A
pump cover gasket thickness 3.5x4.5mm Qty 1 pcs			



1			
GEV No.	499207	Ref. No.	3911K2533
description	pump inlet ø 45mm outlet ø 40mm type 3911K2533 180-253V 50Hz 1 phase 0,55kW 0,75HP L 205mm rotation direction right capacitor 12,5µF FIR		
spare parts for 499207			
	GEV No.	365014	Ref. No. —
operating capacitor capacity 12,5µF 400V			
	GEV No.	510508	Ref. No. N/A
pump cover FIR inlet ø 45 mm outlet ø 40 mm			
	GEV No.	510610	Ref. No. N/A
impellor ø 95,5 mm H 23 mm shaft intake ø 9/8mm			
	GEV No.	510692	Ref. No. N/A
mechanical shaft seal for shaft ø 11 mm			
	GEV No.	521702	Ref. No. N/A
pump cover gasket thickness 3.5x4.5mm Qty 1 pcs			







1			
GEV No.	500025	Ref. No.	3981.1400
description	pump inlet ø 45mm outlet ø 40mm type 3981.1400 230V 50Hz 1 phase 0,24kW 0,33HP rotation direction right FIR		



1			
GEV No.	500550	Ref. No.	3983
description	pump inlet ø 45mm outlet ø 40mm type 3983 230V 50Hz 1 phase 0,37kW 0,5HP L 210mm rotation direction right capacitor 12,5µF FIR		
spare parts for 500550			
	GEV No.	502014	Ref. No. N/A
pump cover FIR inlet ø 45 mm outlet ø 40 mm			



1

GEV No.	499043	Ref. No.	3983.1409
description	pump inlet ø 45mm outlet ø 40mm type 3983.1409 230V 50Hz 1 phase 0,37kW 0,51HP L 205mm rotation direction right capacitor 12,5µF FIR incl. capacitor		
spare parts for	499043		
	GEV No.	365014	Ref. No. —
	operating capacitor capacity 12,5µF 400V		
	GEV No.	510607	Ref. No. N/A
	impellor ø 85 mm H 29 mm shaft intake ø 9x8mm		
	GEV No.	510692	Ref. No. N/A
	mechanical shaft seal for shaft ø 11 mm		
	GEV No.	521539	Ref. No. N/A
	pump cover FIR inlet ø 45 mm outlet ø 40 mm		
	GEV No.	521702	Ref. No. N/A
	pump cover gasket thickness 3.5x4.5mm Qty 1 pcs		



1

GEV No.	500375	Ref. No.	3983
description	pump inlet ø 45mm outlet ø 40mm type 3983.1411 230V 50Hz 1 phase 0,37kW 0,5HP L 200mm rotation direction right capacitor 12,5µF FIR		







1

GEV No.	500464	Ref. No.	4217
description	pump inlet ø 45mm outlet ø 40mm type 4217 230V 50Hz 1 phase 0,56kW 0,75HP L 290mm rotation direction right capacitor 12,5µF FIR		
spare parts for	500464		
	GEV No.	365014	Ref. No. —
	operating capacitor capacity 12,5µF 400V		







1

GEV No.	500264	Ref. No.	4217.2100
description	pump inlet ø 45mm outlet ø 40mm type 4217.2100 400V 50Hz 3 phase 0,55kW 0,75HP L 285mm rotation direction right FIR		
spare parts for	500264		
	GEV No.	510610	Ref. No. N/A
	impellor ø 95,5 mm H 23 mm shaft intake ø 9/8mm		
	GEV No.	510692	Ref. No. N/A
	mechanical shaft seal for shaft ø 11 mm		
	GEV No.	521506	Ref. No. N/A
	pump cover FIR inlet ø 45 mm outlet ø 40 mm		
	GEV No.	521702	Ref. No. N/A
	pump cover gasket thickness 3.5x4.5mm Qty 1 pcs		







1

GEV No.	500266	Ref. No.	4217/A1 4217B2720
description	pump inlet \varnothing 45mm outlet \varnothing 40mm type 4217B2720 230/400V 50Hz 3 phase 0,075kW 1HP L 290mm rotation direction right FIR		
spare parts for	500266		
	GEV No.	510508	Ref. No. N/A
	pump cover FIR inlet \varnothing 45 mm outlet \varnothing 40 mm		
	GEV No.	510600	Ref. No. N/A
	impellor \varnothing 102 mm H 29 mm shaft intake \varnothing 9/8mm		
	GEV No.	510692	Ref. No. N/A
	mechanical shaft seal for shaft \varnothing 11 mm		
	GEV No.	521702	Ref. No. N/A
	pump cover gasket thickness 3.5x4.5mm Qty 1 pcs		







1

GEV No.	499128	Ref. No.	4228.1503
description	pump inlet \varnothing 45mm outlet \varnothing 40mm type 4228.1503 230V 50Hz 0,55kW L 207mm rotation direction right capacitor 12,5 μ F FIR		
spare parts for	499128		
	GEV No.	365014	Ref. No. —
	operating capacitor capacity 12,5 μ F 400V		
	GEV No.	510508	Ref. No. N/A
	pump cover FIR inlet \varnothing 45 mm outlet \varnothing 40 mm		

spare parts for 499128			
	GEV No.	510693	Ref. No. N/A
	mechanical shaft seal for shaft \varnothing 12 mm		
	GEV No.	521702	Ref. No. N/A
	pump cover gasket thickness 3.5x4.5mm Qty 1 pcs		
	GEV No.	524358	Ref. No. N/A
	impellor \varnothing 96 mm H 23 mm shaft intake \varnothing M7Lmm		



1

GEV No.	500400	Ref. No.	4255.1600
description	pump inlet \varnothing 45mm outlet \varnothing 40mm type 4255.1600 230V 50Hz 1 phase 0,55kW 0,75HP L 215mm rotation direction right capacitor 12,5 μ F FIR		
spare parts for	500400		
	GEV No.	365014	Ref. No. —
	operating capacitor capacity 12,5 μ F 400V		
	GEV No.	510692	Ref. No. N/A
	mechanical shaft seal for shaft \varnothing 11 mm		
	GEV No.	521210	Ref. No. N/A
	impellor \varnothing 96 mm H 30 mm shaft intake \varnothing 9/8mm		
	GEV No.	521506	Ref. No. N/A
	pump cover FIR inlet \varnothing 45 mm outlet \varnothing 40 mm		
	GEV No.	521702	Ref. No. N/A
	pump cover gasket thickness 3.5x4.5mm Qty 1 pcs		



1

GEV No.	499045	Ref. No.	4268.2350
description	pump inlet ø 45mm outlet ø 40mm type 4268.2350 230V 50Hz 1 phase 0,45kW 0,6HP L 205mm rotation direction right capacitor 12,5µF FIR		



1





GEV No.	500981	Ref. No.	4281.2350
description	pump inlet ø 45mm outlet ø 40mm type 4281.2350 230V 50Hz 1 phase 0,55kW 0,75HP L 230mm rotation direction right capacitor 12,5µF FIR		



1

GEV No.	499123	Ref. No.	4296.2350
description	pump inlet ø 45mm outlet ø 40mm type 4296.2350 230V 50Hz 1 phase 0,75kW L 250mm rotation direction right capacitor 16µF FIR		
spare parts for	499123		
	GEV No.	365021	Ref. No. —
	operating capacitor capacity 16µF 425V		

spare parts for 499123

	GEV No.	510608	Ref. No.	N/A
	impellor ø 93 mm H 32 mm shaft intake ø 9/8mm			
	GEV No.	510692	Ref. No.	N/A
	mechanical shaft seal for shaft ø 11 mm			
	GEV No.	521539	Ref. No.	N/A
	pump cover FIR inlet ø 45 mm outlet ø 40 mm			
	GEV No.	521702	Ref. No.	N/A
	pump cover gasket thickness 3.5x4.5mm Qty 1 pcs			



1

GEV No.	501401	Ref. No.	5283	
description	pump inlet ø 45mm outlet ø 40mm type 5283 230V 50Hz 1 phase 0,37kW L 205mm FIR			
spare parts for	501401			
	GEV No.	365014	Ref. No.	—
	operating capacitor capacity 12,5µF 400V			
	GEV No.	510608	Ref. No.	N/A
	impellor ø 93 mm H 32 mm shaft intake ø 9/8mm			
	GEV No.	510692	Ref. No.	N/A
	mechanical shaft seal for shaft ø 11 mm			
	GEV No.	521506	Ref. No.	N/A
	pump cover FIR inlet ø 45 mm outlet ø 40 mm			
	GEV No.	521702	Ref. No.	N/A
	pump cover gasket thickness 3.5x4.5mm Qty 1 pcs			



1





GEV No.	501400	Ref. No.	B206.1500
description	pump inlet ø 45mm outlet ø 40mm type B206.1500 230V 50Hz 1 phase 0,55kW L 235mm FIR		
spare parts for	501400		
	GEV No.	Ref. No.	—
	operating capacitor capacity 12,5µF 400V		
	GEV No.	Ref. No.	N/A
	pump cover FIR inlet ø 45 mm outlet ø 40 mm		
	GEV No.	Ref. No.	N/A
	impellor ø 102 mm H 29 mm shaft intake ø 9/8mm		
	GEV No.	Ref. No.	N/A
	mechanical shaft seal for shaft ø 11 mm		
	GEV No.	Ref. No.	—
	fanwheel cover ED ø 150mm H 70mm for wash pump		
	GEV No.	Ref. No.	N/A
	pump cover gasket thickness 3.5x4.5mm Qty 1 pcs		



1





GEV No.	500396	Ref. No.	B257.1605 B257.1700
description	pump inlet ø 45mm outlet ø 40mm type B257.1700 230V 50Hz 1 phase 0,75kW 1HP L 220mm rotation direction right capacitor 16µF FIR		
spare parts for	500396		
	GEV No.	Ref. No.	—
	operating capacitor capacity 16µF 425V		

spare parts for 500396

	GEV No.	510508	Ref. No.	N/A
	pump cover FIR inlet ø 45 mm outlet ø 40 mm			
	GEV No.	510692	Ref. No.	N/A
	mechanical shaft seal for shaft ø 11 mm			
	GEV No.	521001	Ref. No.	N/A
	impellor ø 91 mm H 30 mm pump type B267.4050			
	GEV No.	521702	Ref. No.	N/A
	pump cover gasket thickness 3.5x4.5mm Qty 1 pcs			



1

GEV No.	500370	Ref. No.	B267.2350
description	pump inlet ø 45mm outlet ø 40mm type B267.2350 230V 50Hz 1 phase 0,55kW 0,75HP L 230mm rotation direction right capacitor 16µF FIR		
spare parts for	500370		
	GEV No.	Ref. No.	—
	operating capacitor capacity 16µF 425V		
	GEV No.	Ref. No.	N/A
	mechanical shaft seal for shaft ø 12 mm		
	GEV No.	Ref. No.	N/A
	pump cover FIR inlet ø 45 mm outlet ø 40 mm		
	GEV No.	Ref. No.	N/A
	pump cover gasket thickness 3.5x4.5mm Qty 1 pcs		



1

GEV No.	500369	Ref. No.	B267.4050
description	pump inlet ø 45mm outlet ø 40mm type B267.4050 230/400V 50Hz 3 phase 0,75kW 1HP L 230mm rotation direction right FIR		
spare parts for	500369		
	GEV No.	510692	Ref. No. N/A
	mechanical shaft seal for shaft ø 11 mm		
	GEV No.	521001	Ref. No. N/A
	impellor ø 91 mm H 30 mm pump type B267.4050		
	GEV No.	521506	Ref. No. N/A
	pump cover FIR inlet ø 45 mm outlet ø 40 mm		
	GEV No.	521702	Ref. No. N/A
	pump cover gasket thickness 3.5x4.5mm Qty 1 pcs		



1

GEV No.	499304	Ref. No.	3983.1409
description	pump inlet ø 45mm outlet ø 41mm type 3983.1409 230V 50Hz 1 phase 0,37kW 0,5HP L 200mm rotation direction right capacitor 12,5µF FIR kit		
spare parts for	499304		
	GEV No.	365014	Ref. No. —
	operating capacitor capacity 12,5µF 400V		
	GEV No.	510607	Ref. No. N/A
	impellor ø 85 mm H 29 mm shaft intake ø 9x8mm		
	GEV No.	510692	Ref. No. N/A
	mechanical shaft seal for shaft ø 11 mm		
	GEV No.	521539	Ref. No. N/A
	pump cover FIR inlet ø 45 mm outlet ø 40 mm		
	GEV No.	521702	Ref. No. N/A
	pump cover gasket thickness 3.5x4.5mm Qty 1 pcs		



1

GEV No.	499285	Ref. No.	4242.1400
description	pump inlet ø 45mm outlet ø 43mm type 4242.1400 230V 50Hz 1 phase 0,37kW 0,5HP L 270mm rotation direction right FIR		



1

GEV No.	500989	Ref. No.	4242.1500
description	pump inlet ø 45mm outlet ø 43mm type 4242.1500 230V 50Hz 1 phase 0,55kW 0,75HP L 275mm rotation direction right capacitor 12,5µF FIR 2800rpm		
spare parts for	500989		
	GEV No.	365014	Ref. No. —
	operating capacitor capacity 12,5µF 400V		



1

GEV No.	500560	Ref. No.	B250.1500
description	pump inlet ø 50mm outlet ø 37mm type B250.1500 230V 50Hz 1 phase 0,9kW 1,2HP L 265mm rotation direction left capacitor 12,5µF FIR		
spare parts for	500560		
	GEV No.	365014	Ref. No. —
	operating capacitor capacity 12,5µF 400V		
	GEV No.	510693	Ref. No. N/A
	mechanical shaft seal for shaft ø 12 mm		
	GEV No.	521273	Ref. No. N/A
	impellor ø 103 mm H 27 mm rotation direction left		
	GEV No.	521567	Ref. No. N/A
	pump cover FIR inlet ø 50 mm outlet ø 37 mm		
	GEV No.	521702	Ref. No. N/A
	pump cover gasket thickness 3.5x4.5mm Qty 1 pcs		



1

GEV No.	499055	Ref. No.	0237
description	pump inlet ø 50mm outlet ø 49mm type 0237 220-240V 50Hz 1 phase 0,6kW 0,8HP L 230mm rotation direction right capacitor 16µF FIR		
spare parts for	499055		
	GEV No.	365021	Ref. No. —
	operating capacitor capacity 16µF 425V		

spare parts for 499055

	GEV No.	509031	Ref. No. —
	impellor ø 93 mm H 31 mm shaft ø 12 mm		
	GEV No.	510552	Ref. No. N/A
	pump cover gasket		
	GEV No.	510692	Ref. No. N/A
	mechanical shaft seal for shaft ø 11 mm		
	GEV No.	513713	Ref. No. —
	pump cover bottom part		
	GEV No.	521562	Ref. No. —
	pump cover		
	GEV No.	523509	Ref. No. —
	deep-groove ball bearing type 6201-2RS		





1

GEV No.	500927	Ref. No.	0213.1600
description	pump inlet ø 53mm outlet ø 44mm type 0213.1600 230V 50/60Hz 1 phase 1kW 1,36HP L 290mm rotation direction right capacitor 12,5µF FIR		
spare parts for	500927		
	GEV No.	365014	Ref. No. —
	operating capacitor capacity 12,5µF 400V		
	GEV No.	509010	Ref. No. N/A
	impellor ø 105 mm H 20 mm M10L		
	GEV No.	510693	Ref. No. N/A
	mechanical shaft seal for shaft ø 12 mm		
	GEV No.	521543	Ref. No. —
	pump cover ELFRAMO inlet ø 53 mm outlet ø 44 mm		
	GEV No.	521717	Ref. No. —
	O-ring EPDM thickness 1,78 mm ID ø 120,37 mm		







1

GEV No.	500278	Ref. No.	AF90L/2C-12
description	pump inlet ø 57mm outlet ø 49mm type AF90L/2C-12 400V 50Hz 3 phase 2,7kW 3,7HP L 400mm rotation direction right FIR inlet ø 57mm outlet ø 49mm		
spare parts for	500278		
	GEV No.	502002	Ref. No. —
	gasket set		
	GEV No.	502008	Ref. No. —
	impellor ø 137 mm H 45 mm		



1

GEV No.	499091	Ref. No.	2233S1500
description	pump inlet ø 60mm outlet ø 47mm type 2233S1500 230V 50Hz 1 phase 0,89kW 1,22HP L 251mm rotation direction right capacitor 16µF FIR		
spare parts for	499091		
	GEV No.	365021	Ref. No. —
	operating capacitor capacity 16µF 425V		
	GEV No.	510552	Ref. No. N/A
	pump cover gasket		
	GEV No.	510693	Ref. No. N/A
	mechanical shaft seal for shaft ø 12 mm		
	GEV No.	521067	Ref. No. N/A
	service kit for pump type 2233S1500		
	GEV No.	521512	Ref. No. N/A
	pump cover FIR inlet ø 60 mm outlet ø 50 mm		



1

GEV No.	500527	Ref. No.	2233.B140
description	pump inlet ø 60mm outlet ø 50/30mm type 2233.B140 230V 50Hz 1 phase 0,55kW 0,75HP L 210mm rotation direction right capacitor 12,5µF FIR inlet ø 60mm		
spare parts for	500527		
	GEV No.	365014	Ref. No. —
	operating capacitor capacity 12,5µF 400V		
	GEV No.	510552	Ref. No. N/A
	pump cover gasket		
	GEV No.	510608	Ref. No. N/A
	impellor ø 93 mm H 32 mm shaft intake ø 9/8mm		
	GEV No.	510692	Ref. No. N/A
	mechanical shaft seal for shaft ø 11 mm		
	GEV No.	521511	Ref. No. N/A
	pump cover inlet ø 60 mm outlet ø 50/30mm		



1





GEV No.	500683	Ref. No.	2233.U150
description	pump inlet ø 60mm outlet ø 50mm type 2233.U150 230V 50Hz 1 phase 0,89kW 1,2HP L 260mm rotation direction right capacitor 16µF FIR		
spare parts for	500683		
	GEV No.	365021	Ref. No. —
	operating capacitor capacity 16µF 425V		

Table continues overleaf



spare parts for 500683			
	GEV No.	510552	Ref. No. N/A
	pump cover gasket		
	GEV No.	510600	Ref. No. N/A
	impellor \varnothing 102 mm H 29 mm shaft intake \varnothing 9/8mm		
	GEV No.	510692	Ref. No. N/A
	mechanical shaft seal for shaft \varnothing 11 mm		
	GEV No.	521511	Ref. No. N/A
	pump cover inlet \varnothing 60 mm outlet \varnothing 50/30mm		



1			
GEV No.	499231	Ref. No.	2233A2350
description	pump inlet \varnothing 60mm outlet \varnothing 50mm type 2233A2350 230V 50Hz 1 phase 0,75kW L 255mm rotation direction right capacitor 16 μ F FIR inlet \varnothing 60mm outlet \varnothing 50mm		
spare parts for 499231			
	GEV No.	365021	Ref. No. —
	operating capacitor capacity 16 μ F 425V		
	GEV No.	510529	Ref. No. N/A
	impellor \varnothing 103 mm H 30 mm shaft intake \varnothing 9/8mm		
	GEV No.	510552	Ref. No. N/A
	pump cover gasket		
	GEV No.	510692	Ref. No. N/A
	mechanical shaft seal for shaft \varnothing 11 mm		
	GEV No.	521512	Ref. No. N/A
	pump cover FIR inlet \varnothing 60 mm outlet \varnothing 50 mm		



1			
GEV No.	500709	Ref. No.	2278A2251
description	pump inlet \varnothing 60mm outlet \varnothing 50mm type 2278 230V 50Hz 1 phase 0,75kW 1HP L 300mm rotation direction right capacitor 16 μ F FIR		



1			
GEV No.	500544	Ref. No.	4223.1900
description	pump inlet \varnothing 60mm outlet \varnothing 50mm type 4223.1900 230V 50Hz 1 phase 0,73kW 1HP L 225mm rotation direction right capacitor 16 μ F FIR		
spare parts for 500544			
	GEV No.	365021	Ref. No. —
	operating capacitor capacity 16 μ F 425V		
	GEV No.	510552	Ref. No. N/A
	pump cover gasket		
	GEV No.	510693	Ref. No. N/A
	mechanical shaft seal for shaft \varnothing 12 mm		
	GEV No.	518067	Ref. No. N/A
	impellor \varnothing 103 mm H 29 mm M7L		
	GEV No.	521512	Ref. No. N/A
	pump cover FIR inlet \varnothing 60 mm outlet \varnothing 50 mm		



1

GEV No.	500528	Ref. No.	4233.1500
----------------	--------	-----------------	-----------

description pump inlet ø 60mm outlet ø 50mm type 4233.1500 230V 50Hz 1 phase 0,74kW 1HP L 220mm rotation direction right capacitor 16µF FIR

spare parts for 500528

	GEV No.	365021	Ref. No.	—
		operating capacitor capacity 16µF 425V		
	GEV No.	510552	Ref. No.	N/A
		pump cover gasket		
	GEV No.	510693	Ref. No.	N/A
		mechanical shaft seal for shaft ø 12 mm		
	GEV No.	517319	Ref. No.	—
		hose connector T1: M12x1.75 hose ø 11mm brass		
	GEV No.	521177	Ref. No.	N/A
		impellor ø 93 mm H 23 mm thread M10L		
	GEV No.	521511	Ref. No.	N/A
		pump cover inlet ø 60 mm outlet ø 50/30mm		



1





GEV No.	499281	Ref. No.	4298.1404
----------------	--------	-----------------	-----------

description pump inlet ø 60mm outlet ø 50mm type 4298.1404 230V 50Hz 1 phase 1,1kW L 210mm rotation direction right capacitor 12,5µF FIR

spare parts for 499281

	GEV No.	365014	Ref. No.	—
		operating capacitor capacity 12,5µF 400V		

spare parts for 499281

	GEV No.	510600	Ref. No.	N/A
		impellor ø 102 mm H 29 mm shaft intake ø 9/8mm		
	GEV No.	510692	Ref. No.	N/A
		mechanical shaft seal for shaft ø 11 mm		
	GEV No.	521702	Ref. No.	N/A
		pump cover gasket thickness 3.5x4.5mm Qty 1 pcs		
	GEV No.	698762	Ref. No.	N/A
		pump cover FIR inlet ø 60mmmm outlet ø 50mmmm		







1





GEV No.	499336	Ref. No.	2250.2732
----------------	--------	-----------------	-----------

description pump inlet ø 62 outlet ø 62 type 2250.2732 230/400V 50Hz 2,95kW 4HP



spare parts for 499336





	GEV No.	510687	Ref. No.	N/A
		mechanical shaft seal for shaft ø 18 mm		
	GEV No.	521026	Ref. No.	N/A
		pump cover gasket ID ø 182,5 mm thickness 5x4.5mm		
	GEV No.	521028	Ref. No.	N/A
		pump cover FIR inlet ø 62 mm outlet ø 62 mm		
	GEV No.	521277	Ref. No.	N/A
		impellor ø 135 mm H 39 mm		



1			
GEV No.	500098	Ref. No.	B215.2500
description	pump inlet ø 62mm outlet ø 49mm type B215.2500 230/400V 50/60Hz 3 phase 1,5kW 2HP L 332mm rotation direction right FIR		
spare parts for	500098		
	GEV No.	510693	Ref. No. N/A
	mechanical shaft seal for shaft ø 12 mm		
	GEV No.	511148	Ref. No. —
	impellor ø 118 mm H 20 mm M10L		
	GEV No.	521544	Ref. No. N/A
	pump cover inlet ø 63 mm outlet ø 50 mm		
	GEV No.	521718	Ref. No. N/A
	O-ring EPDM thickness 3,53 mm ID ø 164,7 mm		



1			
GEV No.	499051	Ref. No.	B214.1600
description	pump inlet ø 62mm outlet ø 50mm type B214 230V 50/60Hz 1 phase 1kW rotation direction right capacitor 12,5µF FIR		
spare parts for	499051		
	GEV No.	365014	Ref. No. —
	operating capacitor capacity 12,5µF 400V		
	GEV No.	509010	Ref. No. N/A
	impellor ø 105 mm H 20 mm M10L		
	GEV No.	510693	Ref. No. N/A
	mechanical shaft seal for shaft ø 12 mm		

spare parts for 499051			
	GEV No.	517174	Ref. No. —
	nut thread M8 H 6,5mm WS 13 SS		
	GEV No.	521544	Ref. No. N/A
	pump cover inlet ø 63 mm outlet ø 50 mm		
	GEV No.	521718	Ref. No. N/A
	O-ring EPDM thickness 3,53 mm ID ø 164,7 mm		
	GEV No.	560312	Ref. No. —
	plain washer ID ø 10,5mm ED ø 20mm thickness 2mm		



1			
GEV No.	499268	Ref. No.	4290.6600
description	pump inlet ø 62mm outlet ø 61mm type 4290.6600 220-254/380-440V 60Hz 3 phase 1,5kW L 350mm rotation direction right FIR		







1			
GEV No.	499334	Ref. No.	2250.2731 2250/C
description	pump inlet ø 62mm outlet ø 62mm type 2250.2731 230/400V 50Hz 1 phase 3kW FIR		
spare parts for	499334		
	GEV No.	510687	Ref. No. N/A
	mechanical shaft seal for shaft ø 18 mm		
	GEV No.	512455	Ref. No. —
	fan wheel ø 155mm H 18mm shaft intake ø 18mm		

Table continues overleaf







spare parts for 499334			
	GEV No.	521026	Ref. No. N/A
	pump cover gasket ID ø 182,5 mm thickness 5x4.5mm		
	GEV No.	521028	Ref. No. N/A
	pump cover FIR inlet ø 62 mm outlet ø 62 mm		
	GEV No.	521277	Ref. No. N/A
	impellor ø 135 mm H 39 mm		



1			
GEV No.	499139	Ref. No.	2275.2722
description	pump inlet ø 62mm outlet ø 62mm type 2275.2722 230/400V 50Hz 3 phase 2,6kW L 400mm rotation direction right FIR		
spare parts for 499139			
	GEV No.	510687	Ref. No. N/A
	mechanical shaft seal for shaft ø 18 mm		
	GEV No.	521026	Ref. No. N/A
	pump cover gasket ID ø 182,5 mm thickness 5x4.5mm		
	GEV No.	521028	Ref. No. N/A
	pump cover FIR inlet ø 62 mm outlet ø 62 mm		
	GEV No.	521277	Ref. No. N/A
	impellor ø 135 mm H 39 mm		
	GEV No.	524676	Ref. No. —
	fan wheel ø 160mm shaft intake ø 24mm plastic		







1			
GEV No.	500986	Ref. No.	4290.2700
description	pump inlet ø 62mm outlet ø 62mm type 4290.2700 220-240/380-415V 50Hz 3 phase 1,5kW 2HP L 350mm rotation direction right FIR		
spare parts for 500986			
	GEV No.	510687	Ref. No. N/A
	mechanical shaft seal for shaft ø 18 mm		
	GEV No.	521017	Ref. No. N/A
	impellor ø 120 mm H 35 mm rotation direction right		
	GEV No.	521026	Ref. No. N/A
	pump cover gasket ID ø 182,5 mm thickness 5x4.5mm		
	GEV No.	521028	Ref. No. N/A
	pump cover FIR inlet ø 62 mm outlet ø 62 mm		



1			
GEV No.	500985	Ref. No.	4290.2700
description	pump inlet ø 62mm outlet ø 64mm type 4290.2700 220-240/380-415V 50Hz 3 phase 1,5kW 2HP L 350mm rotation direction right FIR installation kit inclusive		





1



GEV No.	501487	Ref. No.	4267.5050
description	pump inlet ø 63mm outlet ø 40mm type 4267.5050 230/400V 50Hz 3 phase 1,5kW L 300mm rotation direction right FIR		
spare parts for	501487		
	GEV No.	502273	Ref. No. N/A
	pump cover FIR inlet ø 63 mm outlet ø 2x40mm		
	GEV No.	510602	Ref. No. 1225315/S
	impellor ø 110 mm H 34 mm rotation direction right		
	GEV No.	510693	Ref. No. N/A
	mechanical shaft seal for shaft ø 12 mm		
	GEV No.	524416	Ref. No. N/A
	pump cover gasket thickness 4x4mm Qty 1 pcs		



1





GEV No.	500112	Ref. No.	1214.1000
description	pump inlet ø 63mm outlet ø 47mm 230/400V 50Hz 3 phase 0,55kW 0,75HP L 305mm rotation direction right FIR		
spare parts for	500112		
	GEV No.	510601	Ref. No. N/A
	impellor ø 103 mm H 25 mm rotation direction right		
	GEV No.	510693	Ref. No. N/A
	mechanical shaft seal for shaft ø 12 mm		

spare parts for 500112

	GEV No.	521513	Ref. No.	N/A
	pump cover FIR inlet ø 63 mm outlet ø 47 mm			
	GEV No.	524416	Ref. No.	N/A
	pump cover gasket thickness 4x4mm Qty 1 pcs			



1

GEV No.	500056	Ref. No.	1211.2706 1211ST.10
description	pump inlet ø 63mm outlet ø 47mm type 1211.2706 230/400V 50Hz 3 phase 0,55kW 0,75HP L 305mm rotation direction right FIR		
spare parts for	500056		
	GEV No.	510601	Ref. No. N/A
	impellor ø 103 mm H 25 mm rotation direction right		
	GEV No.	510693	Ref. No. N/A
	mechanical shaft seal for shaft ø 12 mm		
	GEV No.	521513	Ref. No. N/A
	pump cover FIR inlet ø 63 mm outlet ø 47 mm		
	GEV No.	524416	Ref. No. N/A
	pump cover gasket thickness 4x4mm Qty 1 pcs		



1









GEV No.	500687	Ref. No.	1211ST.10
description	pump inlet ø 63mm outlet ø 47mm type 1211ST.10 230/400V 50Hz 3 phase 0,55kW 0,75HP L 305mm rotation direction right FIR		
spare parts for	500687		
	GEV No.	510601	Ref. No. N/A
	impellor ø 103 mm H 25 mm rotation direction right		

Table continues overleaf

spare parts for 500687			
	GEV No.	510693	Ref. No. N/A
	mechanical shaft seal for shaft \varnothing 12 mm		
	GEV No.	521513	Ref. No. N/A
	pump cover FIR inlet \varnothing 63 mm outlet \varnothing 47 mm		
	GEV No.	524416	Ref. No. N/A
	pump cover gasket thickness 4x4mm Qty 1 pcs		







1

GEV No.	500155	Ref. No.	1225
description	pump inlet \varnothing 63mm outlet \varnothing 47mm type 1225 230V 50Hz 1 phase 1,1kW 1,5HP L 335mm rotation direction right capacitor 31,5 μ F FIR		
spare parts for 500155			
	GEV No.	365016	Ref. No. —
	operating capacitor capacity 31,5 μ F 400V		
	GEV No.	510602	Ref. No. 1225315/S
	impellor \varnothing 110 mm H 34 mm rotation direction right		
	GEV No.	510693	Ref. No. N/A
	mechanical shaft seal for shaft \varnothing 12 mm		
	GEV No.	521513	Ref. No. N/A
	pump cover FIR inlet \varnothing 63 mm outlet \varnothing 47 mm		
	GEV No.	524416	Ref. No. N/A
	pump cover gasket thickness 4x4mm Qty 1 pcs		



1

GEV No.	500708	Ref. No.	1225.1420
description	pump inlet \varnothing 63mm outlet \varnothing 47mm type 1225.1420 230V 50Hz 1 phase 1,1kW 1,5HP L 335mm rotation direction right capacitor 31,5 μ F FIR		
spare parts for 500708			
	GEV No.	365016	Ref. No. —
	operating capacitor capacity 31,5 μ F 400V		
	GEV No.	510602	Ref. No. 1225315/S
	impellor \varnothing 110 mm H 34 mm rotation direction right		
	GEV No.	510693	Ref. No. N/A
	mechanical shaft seal for shaft \varnothing 12 mm		
	GEV No.	524416	Ref. No. N/A
	pump cover gasket thickness 4x4mm Qty 1 pcs		



1





GEV No.	500023	Ref. No.	1225.2725
description	pump inlet \varnothing 63mm outlet \varnothing 47mm type 1225.2725 230/400V 50Hz 3 phase 1,1kW 1,5HP L 335mm rotation direction right FIR		
spare parts for 500023			
	GEV No.	510602	Ref. No. 1225315/S
	impellor \varnothing 110 mm H 34 mm rotation direction right		
	GEV No.	510693	Ref. No. N/A
	mechanical shaft seal for shaft \varnothing 12 mm		

Table continues overleaf



spare parts for 500023			
	GEV No.	521513	Ref. No. N/A
pump cover FIR inlet ø 63 mm outlet ø 47 mm			
	GEV No.	524416	Ref. No. N/A
pump cover gasket thickness 4x4mm Qty 1 pcs			







1	GEV No.	499187	Ref. No.	1226.2530
description pump inlet ø 63mm outlet ø 47mm type 1226.2530 230/400V 50Hz 3 phase 1,5kW 2HP L 335mm rotation direction right FIR				



1	GEV No.	500742	Ref. No.	1226.2602
description pump inlet ø 63mm outlet ø 47mm type 1226.2602 230/400V 50Hz 3 phase 1,5kW 2HP L 333mm rotation direction left FIR				



1	GEV No.	500533	Ref. No.	1226.2820
description pump inlet ø 63mm outlet ø 47mm type 1226.2820 230/400V 50Hz 3 phase 1,5kW 2HP L 335mm rotation direction right FIR				

spare parts for 500533				
	GEV No.	510693	Ref. No.	N/A
mechanical shaft seal for shaft ø 12 mm				
	GEV No.	521215	Ref. No.	N/A
impellor ø 118 mm H 34 mm rotation direction right				
	GEV No.	521513	Ref. No.	N/A
pump cover FIR inlet ø 63 mm outlet ø 47 mm				
	GEV No.	524416	Ref. No.	N/A
pump cover gasket thickness 4x4mm Qty 1 pcs				



1	GEV No.	501513	Ref. No.	1227.2711M10
description pump inlet ø 63mm outlet ø 47mm type 1227.2711M10 230/400V 50Hz 3 phase 1,7kW L 340mm rotation direction right FIR				









spare parts for 501513				
	GEV No.	510693	Ref. No.	N/A
mechanical shaft seal for shaft ø 12 mm				

Table continues overleaf

spare parts for 501513			
	GEV No.	511667	Ref. No. —
fan wheel ø 123mm H 17mm shaft intake ø 15mm			
	GEV No.	521513	Ref. No. N/A
pump cover FIR inlet ø 63 mm outlet ø 47 mm			
	GEV No.	524416	Ref. No. N/A
pump cover gasket thickness 4x4mm Qty 1 pcs			
	GEV No.	698772	Ref. No. N/A
impellor ø 113 mm H 34 mm M10L			



1	GEV No.	500323	Ref. No.	1227.2721
description pump inlet ø 63mm outlet ø 47mm type 1227.2721 230/400V 50Hz 3 phase 2kW 2,7HP L 335mm rotation direction right FIR				
spare parts for 500323				
	GEV No.	510599	Ref. No.	N/A
impellor ø 123 mm H 34 mm M8L				
	GEV No.	510693	Ref. No.	N/A
mechanical shaft seal for shaft ø 12 mm				
	GEV No.	521513	Ref. No.	N/A
pump cover FIR inlet ø 63 mm outlet ø 47 mm				
	GEV No.	524416	Ref. No.	N/A
pump cover gasket thickness 4x4mm Qty 1 pcs				



1	GEV No.	500035	Ref. No.	1293.1402
description pump inlet ø 63mm outlet ø 47mm type 1293.1402 230V 50Hz 1 phase 0,55kW 0,75HP L 295mm rotation direction right capacitor 12,5µF FIR inlet ø 63mm outlet ø 48mm				
spare parts for 500035				
	GEV No.	365014	Ref. No.	—
operating capacitor capacity 12,5µF 400V				
	GEV No.	510601	Ref. No.	N/A
impellor ø 103 mm H 25 mm rotation direction right				
	GEV No.	510693	Ref. No.	N/A
mechanical shaft seal for shaft ø 12 mm				
	GEV No.	521513	Ref. No.	N/A
pump cover FIR inlet ø 63 mm outlet ø 47 mm				
	GEV No.	524416	Ref. No.	N/A
pump cover gasket thickness 4x4mm Qty 1 pcs				







1	GEV No.	500325	Ref. No.	1293.1603
description pump inlet ø 63mm outlet ø 47mm type 1293.1603 230V 50Hz 1 phase 0,55kW 0,75HP L 300mm rotation direction right capacitor 12,5µF FIR				
spare parts for 500325				
	GEV No.	365014	Ref. No.	—
operating capacitor capacity 12,5µF 400V				



Table continues overleaf



spare parts for 500325			
	GEV No.	510601	Ref. No. N/A
impeller ø 103 mm H 25 mm rotation direction right			
	GEV No.	510693	Ref. No. N/A
mechanical shaft seal for shaft ø 12 mm			
	GEV No.	521513	Ref. No. N/A
pump cover FIR inlet ø 63 mm outlet ø 47 mm			
	GEV No.	524416	Ref. No. N/A
pump cover gasket thickness 4x4mm Qty 1 pcs			

			
1			
GEV No.	499228	Ref. No.	1293.2725
description	pump inlet ø 63mm outlet ø 47mm type 1293.2725 220-240/380-415V 50Hz 3 phase 0,55kW L 302mm rotation direction right FIR		

			
1			
GEV No.	500034	Ref. No.	1293.3500
description	pump inlet ø 63mm outlet ø 47mm type 1293.3500 230/400V 50Hz 3 phase 0,55kW 0,75HP L 300mm rotation direction right FIR		
spare parts for 500034			
	GEV No.	510601	Ref. No. N/A
impeller ø 103 mm H 25 mm rotation direction right			
	GEV No.	510693	Ref. No. N/A
mechanical shaft seal for shaft ø 12 mm			

spare parts for 500034			
	GEV No.	521513	Ref. No. N/A
pump cover FIR inlet ø 63 mm outlet ø 47 mm			
	GEV No.	524416	Ref. No. N/A
pump cover gasket thickness 4x4mm Qty 1 pcs			

			
1			
GEV No.	500257	Ref. No.	1295
description	pump inlet ø 63mm outlet ø 47mm type 1295 230/400V 50Hz 3 phase 0,88kW 1,2HP L 300mm rotation direction right FIR		
accessories for 500257			
	GEV No.	521213	Ref. No. N/A
impeller ø 117 mm H 24 mm M8L			











			
1			
GEV No.	500330	Ref. No.	1295.1409
description	pump inlet ø 63mm outlet ø 47mm type 1295.1409 230V 50Hz 1 phase 0,88kW 1,2HP L 305mm rotation direction right capacitor 12,5µF FIR		
spare parts for 500330			
	GEV No.	365014	Ref. No. —
operating capacitor capacity 12,5µF 400V			
	GEV No.	510693	Ref. No. N/A
mechanical shaft seal for shaft ø 12 mm			

Table continues overleaf

spare parts for 500330			
	GEV No.	521213	Ref. No. N/A
impellor ø 117 mm H 24 mm M8L			
	GEV No.	521513	Ref. No. N/A
pump cover FIR inlet ø 63 mm outlet ø 47 mm			
	GEV No.	524416	Ref. No. N/A
pump cover gasket thickness 4x4mm Qty 1 pcs			







1

GEV No.	500029	Ref. No.	1295.2502 1295.2503
description	pump inlet ø 63mm outlet ø 47mm type 1295.2503 230/400V 50Hz 3 phase 0,88kW 1,2HP L 305mm rotation direction right FIR		
spare parts for 500029			
	GEV No.	510693	Ref. No. N/A
mechanical shaft seal for shaft ø 12 mm			
	GEV No.	521213	Ref. No. N/A
impellor ø 117 mm H 24 mm M8L			
	GEV No.	521513	Ref. No. N/A
pump cover FIR inlet ø 63 mm outlet ø 47 mm			
	GEV No.	524416	Ref. No. N/A
pump cover gasket thickness 4x4mm Qty 1 pcs			



1

GEV No.	500706	Ref. No.	2237.2522
description	pump inlet ø 63mm outlet ø 47mm type 2237.2522 230/400V 50Hz 3 phase 2kW 2,7HP L 330mm rotation direction right FIR		
spare parts for 500706			
	GEV No.	510599	Ref. No. N/A
impellor ø 123 mm H 34 mm M8L			
	GEV No.	510693	Ref. No. N/A
mechanical shaft seal for shaft ø 12 mm			
	GEV No.	521513	Ref. No. N/A
pump cover FIR inlet ø 63 mm outlet ø 47 mm			
	GEV No.	524416	Ref. No. N/A
pump cover gasket thickness 4x4mm Qty 1 pcs			



1









GEV No.	500117	Ref. No.	1226 422522725
description	pump inlet ø 63mm outlet ø 47mm type 4225.22725 230/400V 50Hz 3 phase 1,4kW 2HP L 280mm rotation direction right FIR		
spare parts for 500117			
	GEV No.	510602	Ref. No. 1225315/S
impellor ø 110 mm H 34 mm rotation direction right			

Table continues overleaf

spare parts for 500117			
	GEV No.	510693	Ref. No. N/A
mechanical shaft seal for shaft \varnothing 12 mm			
	GEV No.	521513	Ref. No. N/A
pump cover FIR inlet \varnothing 63 mm outlet \varnothing 47 mm			
	GEV No.	524416	Ref. No. N/A
pump cover gasket thickness 4x4mm Qty 1 pcs			



GEV No.	500570	Ref. No.	422512725
description	pump inlet \varnothing 63mm outlet \varnothing 47mm type 422512725 230/400V 50Hz 3 phase 1,1kW 1,5HP L 285mm rotation direction right FIR		





spare parts for 500570			
	GEV No.	510693	Ref. No. N/A
mechanical shaft seal for shaft \varnothing 12 mm			
	GEV No.	521082	Ref. No. N/A
impellor \varnothing 96 mm H 32 mm rotation direction right			
	GEV No.	521513	Ref. No. N/A
pump cover FIR inlet \varnothing 63 mm outlet \varnothing 47 mm			
	GEV No.	524416	Ref. No. N/A
pump cover gasket thickness 4x4mm Qty 1 pcs			



GEV No.	499283	Ref. No.	422512760
description	pump inlet \varnothing 63mm outlet \varnothing 47mm type 422512760 230/400V 60Hz 3 phase 1,1kW L 290mm rotation direction right FIR		



GEV No.	501540	Ref. No.	422522726
description	pump inlet \varnothing 63mm outlet \varnothing 47mm type 422522726 230/400V 50Hz 3 phase 1,4kW 2HP L 280mm rotation direction right FIR		

spare parts for 501540			
	GEV No.	510602	Ref. No. 1225315/S
impellor \varnothing 110 mm H 34 mm rotation direction right			
	GEV No.	510693	Ref. No. N/A
mechanical shaft seal for shaft \varnothing 12 mm			
	GEV No.	521513	Ref. No. N/A
pump cover FIR inlet \varnothing 63 mm outlet \varnothing 47 mm			
	GEV No.	524416	Ref. No. N/A
pump cover gasket thickness 4x4mm Qty 1 pcs			







1

GEV No.	499280	Ref. No.	5295.5050
description	pump inlet ø 63mm outlet ø 47mm type 5295.5050 230/400V 50Hz 3 phase 1,5kW L 300mm rotation direction right FIR		
spare parts for	499280		
	GEV No.	502277	Ref. No. N/A
	impellor ø 111 mm H 31 mm thread M8L		
	GEV No.	510693	Ref. No. N/A
	mechanical shaft seal for shaft ø 12 mm		
	GEV No.	521022	Ref. No. —
	fanwheel cover ID ø 137mm ED ø 142mm H 70mm		
	GEV No.	524416	Ref. No. N/A
	pump cover gasket thickness 4x4mm Qty 1 pcs		
	GEV No.	698773	Ref. No. N/A
	pump cover inlet ø 63 mm outlet ø 47 mm		

spare parts for	501452		
	GEV No.	524416	Ref. No. N/A
	pump cover gasket thickness 4x4mm Qty 1 pcs		





1

GEV No.	501457	Ref. No.	1204
description	pump inlet ø 63mm outlet ø 53mm type 1204 230/400V 50Hz 3 phase 1,5kW 2HP L 328mm rotation direction left FIR		
spare parts for	501457		
	GEV No.	502013	Ref. No. N/A
	pump cover FIR inlet ø 63mm outlet ø 53mm		
	GEV No.	510604	Ref. No. N/A
	impellor ø 118 mm H 34 mm M8R		
	GEV No.	510693	Ref. No. N/A
	mechanical shaft seal for shaft ø 12 mm		
	GEV No.	524416	Ref. No. N/A
	pump cover gasket thickness 4x4mm Qty 1 pcs		







1

GEV No.	501452	Ref. No.	1204
description	pump inlet ø 63mm outlet ø 53mm type 1204 220-240V 50Hz 1 phase 1,5kW 2HP L 34mm capacitor internalµF FIR		
spare parts for	501452		
	GEV No.	510531	Ref. No. N/A
	pump cover FIR inlet ø 63 mm outlet ø 53 mm		
	GEV No.	510604	Ref. No. N/A
	impellor ø 118 mm H 34 mm M8R		
	GEV No.	510693	Ref. No. N/A
	mechanical shaft seal for shaft ø 12 mm		



1



GEV No.	500018	Ref. No.	1204.2528
description	pump inlet ø 63mm outlet ø 53mm type 1204.2528 230/400V 50Hz 3 phase 1,5kW 2HP L 328mm rotation direction left FIR		



spare parts for 500018			
	GEV No.	510523	Ref. No. —
	fan wheel ø 142mm shaft intake ø 15mm blades 12		
	GEV No.	510531	Ref. No. N/A
	pump cover FIR inlet ø 63 mm outlet ø 53 mm		
	GEV No.	510604	Ref. No. N/A
	impellor ø 118 mm H 34 mm M8R		
	GEV No.	510693	Ref. No. N/A
	mechanical shaft seal for shaft ø 12 mm		
	GEV No.	524416	Ref. No. N/A
	pump cover gasket thickness 4x4mm Qty 1 pcs		



1

GEV No.	500258	Ref. No.	1204.2725
description	pump inlet ø 63mm outlet ø 53mm type 1204.2725 230/400V 50Hz 3 phase 1,5kW 2,01HP L 320mm rotation direction left FIR		

spare parts for 500258			
	GEV No.	510531	Ref. No. N/A
	pump cover FIR inlet ø 63 mm outlet ø 53 mm		
	GEV No.	510604	Ref. No. N/A
	impellor ø 118 mm H 34 mm M8R		

spare parts for 500258			
	GEV No.	510693	Ref. No. N/A
	mechanical shaft seal for shaft ø 12 mm		
	GEV No.	511667	Ref. No. —
	fan wheel ø 123mm H 17mm shaft intake ø 15mm		
	GEV No.	524416	Ref. No. N/A
	pump cover gasket thickness 4x4mm Qty 1 pcs		



1

GEV No.	499152	Ref. No.	1205.2502
description	pump inlet ø 63mm outlet ø 53mm type 1205.2502 230/400V 50Hz 3 phase 2kW 2,7HP L 328mm rotation direction left auxiliary pressure connection 10mm FIR		



1

GEV No.	500031	Ref. No.	1205.2528
description	pump inlet ø 63mm outlet ø 53mm type 1205.2528 230/400V 50Hz 3 phase 2kW 2,7HP L 330mm rotation direction left FIR		





spare parts for 500031			
	GEV No.	510357	Ref. No. N/A
	impellor ø 124 mm H 34/16mm thread M8R blades 6		
	GEV No.	510523	Ref. No. —
	fan wheel ø 142mm shaft intake ø 15mm blades 12		
	GEV No.	510531	Ref. No. N/A
	pump cover FIR inlet ø 63 mm outlet ø 53 mm		
	GEV No.	510693	Ref. No. N/A
	mechanical shaft seal for shaft ø 12 mm		

Table continues overleaf

spare parts for 500031			
	GEV No.	524416	Ref. No. N/A
pump cover gasket thickness 4x4mm Qty 1 pcs			







1

GEV No.	499297	Ref. No.	1205.2820
description	pump inlet ø 63mm outlet ø 53mm type 1205.2820 230/400V 50Hz 3 phase 2,7HP L 330mm rotation direction left FIR		
spare parts for 499297			
	GEV No.	510357	Ref. No. N/A
impellor ø 124 mm H 34/16mm thread M8R blades 6			
	GEV No.	510523	Ref. No. —
fan wheel ø 142mm shaft intake ø 15mm blades 12			
	GEV No.	510531	Ref. No. N/A
pump cover FIR inlet ø 63 mm outlet ø 53 mm			
	GEV No.	510693	Ref. No. N/A
mechanical shaft seal for shaft ø 12 mm			
	GEV No.	524416	Ref. No. N/A
pump cover gasket thickness 4x4mm Qty 1 pcs			



1

GEV No.	500111	Ref. No.	1241.2500 1241.2530
description	pump inlet ø 63mm outlet ø 53mm type 1241.2500 230/400V 50Hz 3 phase 1,1kW 1,5HP L 330mm rotation direction left FIR		
spare parts for 500111			
	GEV No.	510531	Ref. No. N/A
pump cover FIR inlet ø 63 mm outlet ø 53 mm			
	GEV No.	510612	Ref. No. N/A
impellor ø 110 mm H 34 mm M8R			
	GEV No.	510693	Ref. No. N/A
mechanical shaft seal for shaft ø 12 mm			
	GEV No.	524416	Ref. No. N/A
pump cover gasket thickness 4x4mm Qty 1 pcs			







1

GEV No.	499237	Ref. No.	1241.2503
description	pump inlet ø 63mm outlet ø 53mm type 1241.2503 230/400V 50Hz 3 phase 1,1kW 1,5HP L 330mm rotation direction left FIR		





1

GEV No.	500271	Ref. No.	1241.2708
description	pump inlet ø 63mm outlet ø 53mm type 1241.2708 230/400V 50Hz 3 phase 1,12kW 1,52HP L 330mm rotation direction left FIR		
spare parts for	500271		
	GEV No.	510531	Ref. No. N/A
	pump cover FIR inlet ø 63 mm outlet ø 53 mm		
	GEV No.	510612	Ref. No. N/A
	impellor ø 110 mm H 34 mm M8R		
	GEV No.	510693	Ref. No. N/A
	mechanical shaft seal for shaft ø 12 mm		
	GEV No.	524416	Ref. No. N/A
	pump cover gasket thickness 4x4mm Qty 1 pcs		



1

GEV No.	500277	Ref. No.	1241.2720
description	pump inlet ø 63mm outlet ø 53mm type 1241.2720 230/400V 50Hz 3 phase 1,1kW 1,5HP L 335mm rotation direction left FIR		
spare parts for	500277		
	GEV No.	502013	Ref. No. N/A
	pump cover FIR inlet ø 63mm outlet ø 53mm		
	GEV No.	510612	Ref. No. N/A
	impellor ø 110 mm H 34 mm M8R		
	GEV No.	510693	Ref. No. N/A
	mechanical shaft seal for shaft ø 12 mm		

spare parts for 500277

	GEV No.	524416	Ref. No.	N/A
	pump cover gasket thickness 4x4mm Qty 1 pcs			





1

GEV No.	501463	Ref. No.	1241.2780
description	pump inlet ø 63mm outlet ø 53mm type 1241.2780 230/400V 50Hz 3 phase 1,1kW 1,5HP L 335mm rotation direction left FIR		
spare parts for	501463		
	GEV No.	502013	Ref. No. N/A
	pump cover FIR inlet ø 63mm outlet ø 53mm		
	GEV No.	510523	Ref. No. —
	fan wheel ø 142mm shaft intake ø 15mm blades 12		
	GEV No.	510612	Ref. No. N/A
	impellor ø 110 mm H 34 mm M8R		
	GEV No.	510693	Ref. No. N/A
	mechanical shaft seal for shaft ø 12 mm		
	GEV No.	524416	Ref. No. N/A
	pump cover gasket thickness 4x4mm Qty 1 pcs		



1

GEV No.	500119	Ref. No.	1241.4701
description	pump inlet ø 63mm outlet ø 53mm type 1241.4701 230V 50Hz 1 phase 1,1kW 1,5HP L 330mm rotation direction left capacitor 31,5µF FIR		
spare parts for	500119		
	GEV No.	365016	Ref. No. —
	operating capacitor capacity 31,5µF 400V		
	GEV No.	510531	Ref. No. N/A
	pump cover FIR inlet ø 63 mm outlet ø 53 mm		
	GEV No.	510612	Ref. No. N/A
	impellor ø 110 mm H 34 mm M8R		
	GEV No.	510693	Ref. No. N/A
	mechanical shaft seal for shaft ø 12 mm		
	GEV No.	524416	Ref. No. N/A
	pump cover gasket thickness 4x4mm Qty 1 pcs		

spare parts for	501459		
	GEV No.	510612	Ref. No. N/A
	impellor ø 110 mm H 34 mm M8R		
	GEV No.	510693	Ref. No. N/A
	mechanical shaft seal for shaft ø 12 mm		
	GEV No.	524416	Ref. No. N/A
	pump cover gasket thickness 4x4mm Qty 1 pcs		





1

GEV No.	500705	Ref. No.	1243.2700
description	pump inlet ø 63mm outlet ø 53mm type 1243 230/400V 50Hz 3 phase 2,39kW 3,2HP L 363mm rotation direction left FIR		
spare parts for	500705		
	GEV No.	510357	Ref. No. N/A
	impellor ø 124 mm H 34/16mm thread M8R blades 6		



1

GEV No.	501459	Ref. No.	1241/1
description	pump inlet ø 63mm outlet ø 53mm type 1241/1 230/240V 50Hz 1 phase 1,1kW 1,5HP L 330mm rotation direction left capacitor 31,5µF FIR		
spare parts for	501459		
	GEV No.	365016	Ref. No. —
	operating capacitor capacity 31,5µF 400V		
	GEV No.	502013	Ref. No. N/A
	pump cover FIR inlet ø 63mm outlet ø 53mm		







1

GEV No.	499197	Ref. No.	1243
description	pump inlet ø 63mm outlet ø 53mm type 1243 255/440V 60Hz 3 phase 3,2HP L 370mm rotation direction left FIR		





1

GEV No.	500324	Ref. No.	1243.2520 1243.2591
description	pump inlet ø 63mm outlet ø 53mm type 1243.2591 230/400V 50Hz 3 phase 2,35kW 3,2HP L 365mm rotation direction left FIR		
spare parts for	500324		
	GEV No.	510357	Ref. No. N/A
	impellor ø 124 mm H 34/16mm thread M8R blades 6		
	GEV No.	510531	Ref. No. N/A
	pump cover FIR inlet ø 63 mm outlet ø 53 mm		
	GEV No.	510693	Ref. No. N/A
	mechanical shaft seal for shaft ø 12 mm		
	GEV No.	524416	Ref. No. N/A
	pump cover gasket thickness 4x4mm Qty 1 pcs		



1

GEV No.	500952	Ref. No.	1244.2527
description	pump inlet ø 63mm outlet ø 53mm type 1244.2527 400V 50Hz 3 phase 2,5kW 3,5HP L 360mm rotation direction left FIR		
spare parts for	500952		
	GEV No.	510357	Ref. No. N/A
	impellor ø 124 mm H 34/16mm thread M8R blades 6		
	GEV No.	510531	Ref. No. N/A
	pump cover FIR inlet ø 63 mm outlet ø 53 mm		
	GEV No.	510693	Ref. No. N/A
	mechanical shaft seal for shaft ø 12 mm		

spare parts for 500952

	GEV No.	524416	Ref. No.	N/A
	pump cover gasket thickness 4x4mm Qty 1 pcs			



1

GEV No.	501462	Ref. No.	2204/D	
description	pump inlet ø 63mm outlet ø 53mm type 2204/D 230V 50Hz 1 phase 0,73kW 1HP L 260mm rotation direction left capacitor 20µF FIR			
spare parts for	501462			
	GEV No.	365019	Ref. No.	—
	operating capacitor capacity 20µF 400V			
	GEV No.	502013	Ref. No.	N/A
	pump cover FIR inlet ø 63mm outlet ø 53mm			
	GEV No.	510693	Ref. No.	N/A
	mechanical shaft seal for shaft ø 12 mm			
	GEV No.	521219	Ref. No.	N/A
	impellor ø 106 mm H 27 mm thread M8R shaft ø 28 mm			
	GEV No.	524416	Ref. No.	N/A
	pump cover gasket thickness 4x4mm Qty 1 pcs			



1

GEV No.	500276	Ref. No.	2204D1520
description	pump inlet ø 63mm outlet ø 53mm type 2204D1520 230V 50Hz 1 phase 0,73kW 1HP L 260mm rotation direction left capacitor 20µFµF FIR		
spare parts for	500276		
	GEV No.	365019	Ref. No. —
	operating capacitor capacity 20µF 400V		
	GEV No.	502013	Ref. No. N/A
	pump cover FIR inlet ø 63mm outlet ø 53mm		
	GEV No.	510693	Ref. No. N/A
	mechanical shaft seal for shaft ø 12 mm		
	GEV No.	521219	Ref. No. N/A
	impellor ø 106 mm H 27 mm thread M8R shaft ø 28 mm		
	GEV No.	524416	Ref. No. N/A
	pump cover gasket thickness 4x4mm Qty 1 pcs		
	GEV No.	524845	Ref. No. —
	fan wheel ø 116mm shaft intake ø 9,7mm plastic		



1

GEV No.	500058	Ref. No.	2241.2500
description	pump inlet ø 63mm outlet ø 53mm type 2241.2500 230/400V 50Hz 3 phase 0,89kW 1,2HP L 305mm rotation direction left FIR		
spare parts for	500058		
	GEV No.	510531	Ref. No. N/A
	pump cover FIR inlet ø 63 mm outlet ø 53 mm		
	GEV No.	510693	Ref. No. N/A
	mechanical shaft seal for shaft ø 12 mm		
	GEV No.	510834	Ref. No. N/A
	impellor ø 110mm H 29mm thread M8R		
	GEV No.	524416	Ref. No. N/A
	pump cover gasket thickness 4x4mm Qty 1 pcs		
accessories for	500058		
	GEV No.	524046	Ref. No. —
	vibration damper L 40mm W 25mm H 25mm for pump		



1

GEV No.	501467	Ref. No.	2241.2501
description	pump inlet ø 63mm outlet ø 53mm type 2241.2501 230/400V 50Hz 3 phase 0,89kW 1,5HP L 305mm rotation direction left FIR		



1

GEV No.	499293	Ref. No.	2241.2703
description	pump inlet ø 63mm outlet ø 53mm type 2241.2703 230/400V 50Hz 3 phase 0,89kW 1,2HP L 300mm rotation direction left FIR		





1



GEV No.	499193	Ref. No.	2241.5800
description	pump inlet ø 63mm outlet ø 53mm type 2241.5800 255/440V 60Hz 3 phase 1,1kW L 305mm rotation direction left FIR		



1

GEV No.	499108	Ref. No.	4205.2701 4205.2702
description	pump inlet ø 63mm outlet ø 53mm type 4205.2702 230/400V 50Hz 3 phase 1,38kW 1,85HP L 330mm rotation direction left FIR		
spare parts for	499108		
	GEV No.	502013	Ref. No. N/A
	pump cover FIR inlet ø 63mm outlet ø 53mm		
	GEV No.	502122	Ref. No. N/A
	impellor ø 119 mm H 33 mm M8R		

spare parts for 499108

	GEV No.	510693	Ref. No.	N/A
	mechanical shaft seal for shaft ø 12 mm			
	GEV No.	524416	Ref. No.	N/A
	pump cover gasket thickness 4x4mm Qty 1 pcs			



1

GEV No.	499251	Ref. No.	5223.2350
description	pump inlet ø 63mm outlet ø 53mm type 5223.2350 230V 50Hz 1 phase 0,74kW L 314mm rotation direction left capacitor 16µF FIR		

spare parts for 499251

	GEV No.	365021	Ref. No.	—
	operating capacitor capacity 16µF 425V			
	GEV No.	502274	Ref. No.	N/A
	pump cover FIR inlet ø 63 mm outlet ø 53 mm			
	GEV No.	502275	Ref. No.	N/A
	impellor ø 100 mm H 29 mm thread M8R blades 6			
	GEV No.	510693	Ref. No.	N/A
	mechanical shaft seal for shaft ø 12 mm			
	GEV No.	521022	Ref. No.	—
	fanwheel cover ID ø 137mm ED ø 142mm H 70mm			
	GEV No.	524416	Ref. No.	N/A
	pump cover gasket thickness 4x4mm Qty 1 pcs			



1

GEV No.	499300	Ref. No.	5223.4050
description	pump inlet ø 63mm outlet ø 53mm type 5223.4050 230/400V 50Hz 3 phase 1,1kW L 316mm rotation direction left FIR		







1

GEV No.	499113	Ref. No.	5234.4050
description	pump inlet ø 63mm outlet ø 53mm type 5234.4050 230/400V 50Hz 3 phase 1,62kW 2,2HP L 340mm rotation direction left FIR		



1

GEV No.	499109	Ref. No.	5233.4051
description	pump inlet ø 63mm outlet ø 53mm type 5233.4051 220-240/380-415V 50Hz 3 phase 1,1kW 1,5HP L 345mm rotation direction left FIR		

spare parts for	499109		
	GEV No.	502274	Ref. No. N/A
	pump cover FIR inlet ø 63 mm outlet ø 53 mm		
	GEV No.	510612	Ref. No. N/A
	impellor ø 110 mm H 34 mm M8R		
	GEV No.	510693	Ref. No. N/A
	mechanical shaft seal for shaft ø 12 mm		
	GEV No.	524416	Ref. No. N/A
	pump cover gasket thickness 4x4mm Qty 1 pcs		



1

GEV No.	499115	Ref. No.	5234.4052
description	pump inlet ø 63mm outlet ø 53mm type 5234.4052 230/400V 50Hz 3 phase 1,62kW L 340mm rotation direction left FIR		



1

GEV No.	500741	Ref. No.	5234.4055
description	pump inlet ø 63mm outlet ø 53mm type 5234.4055 230/400V 50Hz 3 phase 1,5kW 2HP L 340mm rotation direction left FIR		





spare parts for	500741		
	GEV No.	502274	Ref. No. N/A
	pump cover FIR inlet ø 63 mm outlet ø 53 mm		
	GEV No.	510604	Ref. No. N/A
	impellor ø 118 mm H 34 mm M8R		





Table continues overleaf



spare parts for 500741			
	GEV No.	510693	Ref. No. N/A
mechanical shaft seal for shaft \varnothing 12 mm			
	GEV No.	524416	Ref. No. N/A
pump cover gasket thickness 4x4mm Qty 1 pcs			







GEV No.	500244	Ref. No.	1241.2725
description	pump inlet \varnothing 63mm outlet \varnothing 54mm type 1241.2725 230/400V 3 phase 1,1kW 1,5HP rotation direction left FIR		

spare parts for 500244			
	GEV No.	510531	Ref. No. N/A
pump cover FIR inlet \varnothing 63 mm outlet \varnothing 53 mm			
	GEV No.	510612	Ref. No. N/A
impellor \varnothing 110 mm H 34 mm M8R			
	GEV No.	510693	Ref. No. N/A
mechanical shaft seal for shaft \varnothing 12 mm			
	GEV No.	524416	Ref. No. N/A
pump cover gasket thickness 4x4mm Qty 1 pcs			







GEV No.	500397	Ref. No.	2254.1000
description	pump inlet \varnothing 70mm outlet \varnothing 60mm type 2254.1000 230/400V 50Hz 3 phase 1,1kW 1,5HP L 320mm rotation direction right FIR		

spare parts for 500397			
	GEV No.	510693	Ref. No. N/A
mechanical shaft seal for shaft \varnothing 12 mm			

spare parts for 500397			
	GEV No.	521216	Ref. No. N/A
impellor \varnothing 100 mm H 31 mm M8L			
	GEV No.	521515	Ref. No. N/A
pump cover inlet \varnothing 70 mm outlet \varnothing 60 mm			
	GEV No.	524416	Ref. No. N/A
pump cover gasket thickness 4x4mm Qty 1 pcs			







GEV No.	500115	Ref. No.	2254.2560 2254.2561
description	pump inlet \varnothing 70mm outlet \varnothing 60mm type 2254.2561 230/400V 50Hz 3 phase 1,5kW 2HP L 325mm rotation direction right FIR		

spare parts for 500115			
	GEV No.	504313	Ref. No. —
hose connector thread M12x1.75 grommet \varnothing 11,3mm			
	GEV No.	510693	Ref. No. N/A
mechanical shaft seal for shaft \varnothing 12 mm			
	GEV No.	521014	Ref. No. N/A
impellor \varnothing 110 mm H 32 mm rotation direction right			
	GEV No.	521515	Ref. No. N/A
pump cover inlet \varnothing 70 mm outlet \varnothing 60 mm			
	GEV No.	524416	Ref. No. N/A
pump cover gasket thickness 4x4mm Qty 1 pcs			







1

GEV No.	499264	Ref. No.	2254.2562
description	pump inlet ø 70mm outlet ø 60mm type 2254.2562 220-240/380-415V 50Hz 3 phase 1,5kW L 322mm rotation direction right FIR		
spare parts for	499264		
	GEV No.	510694	Ref. No. —
	mechanical shaft seal for shaft ø 13 mm		
	GEV No.	521014	Ref. No. N/A
	impellor ø 110 mm H 32 mm rotation direction right		
	GEV No.	521515	Ref. No. N/A
	pump cover inlet ø 70 mm outlet ø 60 mm		
	GEV No.	524416	Ref. No. N/A
	pump cover gasket thickness 4x4mm Qty 1 pcs		



1

GEV No.	499265	Ref. No.	2254.5881
description	pump inlet ø 70mm outlet ø 60mm type 2254.5881 255/440V 60Hz 3 phase 1,5kW L 322mm rotation direction right FIR		
spare parts for	499265		
	GEV No.	502276	Ref. No. N/A
	impellor ø 90 mm H 30 mm thread M8L		
	GEV No.	504313	Ref. No. —
	hose connector thread M12x1.75 grommet ø 11,3mm		
	GEV No.	510693	Ref. No. N/A
	mechanical shaft seal for shaft ø 12 mm		

spare parts for	499265		
	GEV No.	521515	Ref. No. N/A
	pump cover inlet ø 70 mm outlet ø 60 mm		
	GEV No.	524416	Ref. No. N/A
	pump cover gasket thickness 4x4mm Qty 1 pcs		









1

GEV No.	500248	Ref. No.	4186.1500
description	pump outlet ø 27mm type 4186.1500 230V 50Hz 1 phase 0,25kW 0,33HP L 170mm rotation direction right capacitor 12,5µF FIR		
spare parts for	500248		
	GEV No.	365014	Ref. No. —
	operating capacitor capacity 12,5µF 400V		
	GEV No.	502012	Ref. No. N/A
	pump cover bottom part for wash pump		
	GEV No.	502015	Ref. No. N/A
	impellor ø 86 mm H 22 mm shaft intake ø 9/8mm		
	GEV No.	503147	Ref. No. —
	pump cover gasket thickness 3,53 mm ID ø 148,8 mm		
	GEV No.	510695	Ref. No. N/A
	mechanical shaft seal height counter ring 5,5 mm		
accessories for	500248		
	GEV No.	521730	Ref. No. N/A
	flange gasket EPDM thickness 5 mm ID ø 155 mm		



1

GEV No.	501460	Ref. No.	4186.1500
description	pump outlet ø 27mm type 4186.1500 230V 50Hz 1 phase 0,25kW 0,33HP L 170mm rotation direction right capacitor 12,5µF FIR outlet ø 27mm		
spare parts for	501460		
	GEV No.	502012	Ref. No. N/A
	pump cover bottom part for wash pump		
	GEV No.	502015	Ref. No. N/A
	impellor ø 86 mm H 22 mm shaft intake ø 9/8mm		
	GEV No.	503147	Ref. No. —
	pump cover gasket thickness 3,53 mm ID ø 148,8 mm		
	GEV No.	510695	Ref. No. N/A
	mechanical shaft seal height counter ring 5,5 mm		
accessories for	501460		
	GEV No.	365014	Ref. No. —
	operating capacitor capacity 12,5µF 400V		
	GEV No.	521730	Ref. No. N/A
	flange gasket EPDM thickness 5 mm ID ø 155 mm		







1

GEV No.	500012	Ref. No.	1243
description	pump type 1243 50Hz rotation direction left FIR		



1

GEV No.	500259	Ref. No.	2212.1400
description	pump type 2212.1400 230V 50Hz 1 phase 0,075kW 0,1HP rotation direction right FIR		
spare parts for	500259		
	GEV No.	365017	Ref. No. —
	operating capacitor capacity 5µF 450V		
	GEV No.	510510	Ref. No. X2212-HP,0,10_(1)
	pump cover pump type 2212/2228/2229/2211		
	GEV No.	510695	Ref. No. N/A
	mechanical shaft seal height counter ring 5,5 mm		
	GEV No.	521203	Ref. No. N/A
	impellor ø 72 mm H 18 mm thread M7 shaft ø 11 mm		
	GEV No.	521703	Ref. No. N/A
	pump cover gasket EPDM thickness 2,5 mm ID ø 75 mm		



1

GEV No.	500326	Ref. No.	3911
description	pump type 3911 230V 50Hz 1 phase 0,55kW 0,75HP rotation direction right FIR		





1

GEV No.	500026	Ref. No.	3942
description	pump type 3942 230V 50Hz 1 phase 0,55kW 0,75HP rotation direction right FIR		



1

GEV No.	510693	Ref. No.	N/A
description	mechanical shaft seal for shaft \varnothing 12mm slide ring ext. \varnothing 24mm slide ring H 15,5mm slide ring int. \varnothing 11mm counter ring mounting \varnothing 24mm height counter ring 8mm counter ring int. \varnothing 14mm		



1

GEV No.	510703	Ref. No.	N/A
description	mechanical shaft seal for shaft \varnothing 13mm slide ring H 13mm height counter ring 5,5mm ED \varnothing 26mm		



1

GEV No.	500698	Ref. No.	4273.2350
description	pump type 4273.2350 230V 50Hz 1 phase 0,55kW 0,75HP L 170mm rotation direction left capacitor 12,5 μ F FIR		
spare parts for	500698		
	GEV No.	365014	Ref. No. —
	operating capacitor capacity 12,5 μ F 400V		
	GEV No.	510695	Ref. No. N/A
	mechanical shaft seal height counter ring 5,5 mm		
	GEV No.	512437	Ref. No. —
	impellor \varnothing 85 mm H 27 mm rotation direction right		



1

GEV No.	510687	Ref. No.	N/A
description	mechanical shaft seal for shaft \varnothing 18mm height counter ring 8mm ID \varnothing 17mm ED \varnothing 39mm H 15mm mounting \varnothing 42mm int. \varnothing 1 21mm		



1

GEV No.	510690	Ref. No.	N/A
description	mechanical shaft seal for shaft \varnothing 8mm ED \varnothing 24mm mounting \varnothing 24/26mm		



1

GEV No.	510695	Ref. No.	N/A
description	mechanical shaft seal height counter ring 5,5mm ID \varnothing 11mm		



1

GEV No.	510702	Ref. No.	N/A
description	mechanical shaft seal height counter ring 5,5mm ID \varnothing 12mm		

spare parts and accessories

mechanical shaft seals



1

GEV No.	510692	Ref. No.	N/A
description	mechanical shaft seal for shaft \varnothing 11mm slide ring ext. \varnothing 24mm slide ring H 13mm counter ring mounting \varnothing 26mm height counter ring 8mm counter ring int. \varnothing 14mm		

impellers



1

GEV No.	502275	Ref. No.	N/A
description	impellor ø 100mm H 29mm thread M8R blades 6		



1

GEV No.	521216	Ref. No.	N/A
description	impellor ø 100mm H 31mm M8L		



1

GEV No.	510600	Ref. No.	N/A
description	impellor ø 102mm H 29mm shaft intake ø 9/8mm rotation direction right blades 6		



1

GEV No.	510601	Ref. No.	N/A
description	impellor ø 103mm H 25mm rotation direction right thread M8L seat ø 12,2mm blades 6		



1

GEV No.	521273	Ref. No.	N/A
description	impellor ø 103mm H 27mm rotation direction left thread M7R shaft ø 12mm shaft length 10mm blades 6		



1

GEV No.	501313	Ref. No.	N/A
description	impellor ø 103mm H 28mm shaft intake ø 9/8mm		



1

GEV No.	518067	Ref. No.	N/A
description	impellor ø 103mm H 29mm M7L		



1

GEV No.	510529	Ref. No.	N/A
description	impellor ø 103mm H 30mm shaft intake ø 9/8mm rotation direction right blades 6		



1

GEV No.	509010	Ref. No.	N/A
description	impellor ø 105mm H 20mm M10L rotation direction right blades 4		



1

GEV No.	521219	Ref. No.	N/A
description	impellor ø 106mm H 27mm thread M8R shaft ø 28mm shaft length 10mm seat ø 12mm blades 6		



1

GEV No.	510834	Ref. No.	N/A
description	impellor ø 110mm H 29mm thread M8R suitable for FIR		





			
1			
GEV No.	521014	Ref. No.	N/A
description	impeller ø 110mm H 32mm rotation direction right thread M8L shaft ø 28mm shaft length 3mm seat ø 12,2mm blades 6		

			
1			
GEV No.	510612	Ref. No.	N/A
description	impeller ø 110mm H 34mm M8R		

			
1			
GEV No.	510602	Ref. No.	1225315/S
description	impeller ø 110mm H 34mm rotation direction right thread M8L shaft ø 28mm seat ø 12,2mm blades 6		

			
1			
GEV No.	502277	Ref. No.	N/A
description	impeller ø 111mm H 31mm thread M8L		

			
1			
GEV No.	698772	Ref. No.	N/A
description	impeller ø 113mm H 34mm M10L pump type 1227.2711M10 rotation direction right suitable for FIR blades 6		

			
1			
GEV No.	521213	Ref. No.	N/A
description	impeller ø 117mm H 24mm M8L		

			
1			
GEV No.	510604	Ref. No.	N/A
description	impeller ø 118mm H 34mm M8R rotation direction left		

			
1			
GEV No.	521215	Ref. No.	N/A
description	impeller ø 118mm H 34mm rotation direction right thread M8L seat ø 12mm blades 6		

			
1			
GEV No.	502122	Ref. No.	N/A
description	impeller ø 119mm H 33mm M8R		

			
1			
GEV No.	521017	Ref. No.	N/A
description	impeller ø 120mm H 35mm rotation direction right thread M14L seat ø 18mm blades 6		

			
1			
GEV No.	510599	Ref. No.	N/A
description	impeller ø 123mm H 34mm M8L		

			
1			
GEV No.	510357	Ref. No.	N/A
description	impeller ø 124mm H 34/16mm thread M8R blades 6		



1

GEV No.	521277	Ref. No.	N/A
description	impellor ø 135mm H 39mm pump type Fir 2275; 3.6HP thread M14L		



1

GEV No.	521200	Ref. No.	N/A
description	impellor ø 63mm H 13mm shaft ø 11mm shaft length 32mm		



1

GEV No.	521279	Ref. No.	N/A
description	impellor ø 64mm H 17mm thread M5L blades 3 metal		



1

GEV No.	521266	Ref. No.	N/A
description	impellor ø 67mm H 18mm thread M7 shaft ø 11mm shaft length 32mm blades 3		



1

GEV No.	521202	Ref. No.	N/A
description	impellor ø 72mm H 17mm thread M5L		



1

GEV No.	521201	Ref. No.	N/A
description	impellor ø 72mm H 18mm thread M7 shaft ø 11mm shaft length 32mm blades 3		



1

GEV No.	521203	Ref. No.	N/A
description	impellor ø 72mm H 18mm thread M7 shaft ø 11mm shaft length 32mm blades 3		



1

GEV No.	510532	Ref. No.	X2228-HP0,20_(1)
description	impellor ø 72mm H 22mm pump type B229 thread M7 shaft ø 11mm shaft length 32mm blades 3		



1

GEV No.	501314	Ref. No.	N/A
description	impellor ø 75mm		



1

GEV No.	521566	Ref. No.	N/A
description	impellor ø 80mm H 15mm M7L pump type B226H		

			
1			
GEV No.	521207	Ref. No.	N/A
description	impellor ø 80mm H 18mm shaft intake ø 9x8mm rotation direction right suitable for HOONVED blades 5		

			
1			
GEV No.	502015	Ref. No.	N/A
description	impellor ø 86mm H 22mm shaft intake ø 9/8mm		

			
1			
GEV No.	501309	Ref. No.	N/A
description	impellor ø 80mm H 19mm M7R pump type type D1		

			
1			
GEV No.	502276	Ref. No.	N/A
description	impellor ø 90mm H 30mm thread M8L		

			
1			
GEV No.	510605	Ref. No.	N/A
description	impellor ø 80mm H 21mm M7L		

			
1			
GEV No.	521001	Ref. No.	N/A
description	impellor ø 91mm H 30mm pump type B267.4050 rotation direction right		

			
1			
GEV No.	510609	Ref. No.	N/A
description	impellor ø 84mm H 21mm M7L		

			
1			
GEV No.	521177	Ref. No.	N/A
description	impellor ø 93mm H 23mm thread M10L suitable for FIR		

			
1			
GEV No.	510607	Ref. No.	N/A
description	impellor ø 85mm H 29mm shaft intake ø 9x8mm rotation direction right blades 6		

			
1			
GEV No.	521061	Ref. No.	N/A
description	impellor ø 93mm H 27mm shaft intake ø 9x8mm rotation direction left blades 6		



			
1			
GEV No.	510608	Ref. No.	N/A
description	impellor ø 93mm H 32mm shaft intake ø 9/8mm blades 6 inner height 11mm		

			
1			
GEV No.	510610	Ref. No.	N/A
description	impellor ø 95,5mm H 23mm shaft intake ø 9/8mm rotation direction right seat ø 16mm blades 6		

			
1			
GEV No.	524358	Ref. No.	N/A
description	impellor ø 96mm H 23mm shaft intake ø M7Lmm rotation direction right suitable for MEIKO shaft ø 12mm shaft length 9mm blades 6		

			
1			
GEV No.	521210	Ref. No.	N/A
description	impellor ø 96mm H 30mm shaft intake ø 9/8mm seat ø 16mm blades 6		

			
1			
GEV No.	521082	Ref. No.	N/A
description	impellor ø 96mm H 32mm rotation direction right thread M8L		

			
1			
GEV No.	521067	Ref. No.	N/A
description	service kit for pump type 2233S1500 impellor, pump cover gasket, mechanical shaft seal		
spare parts for	521067		
	GEV No.	510552	Ref. No.
			N/A
description	pump cover gasket		
	GEV No.	510693	Ref. No.
			N/A
description	mechanical shaft seal for shaft ø 12 mm		

pump cover gaskets			
			
1			
GEV No.	521730	Ref. No.	N/A
description	flange gasket EPDM thickness 5mm ID ø 155mm Qty 1 pcs		

			
1			
GEV No.	509002	Ref. No.	N/A
description	O-ring EPDM thickness 2,62mm ID ø 82,22mm Qty 1 pcs		

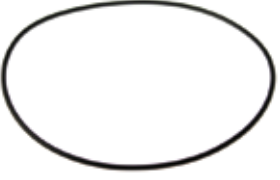
			
1			
GEV No.	521718	Ref. No.	N/A
description	O-ring EPDM thickness 3,53mm ID ø 164,7mm Qty 1 pcs		

			
1			
GEV No.	532718	Ref. No.	N/A
description	O-ring EPDM thickness 4mm ID ø 80mm Qty 1 pcs		

			
1			
GEV No.	502007	Ref. No.	N/A
description	pump cover gasket		

			
1			
GEV No.	521700	Ref. No.	N/A
description	pump cover gasket		



1

GEV No.	521701	Ref. No.	N/A
description	pump cover gasket		



1

GEV No.	521707	Ref. No.	N/A
description	pump cover gasket		



1

GEV No.	521703	Ref. No.	N/A
description	pump cover gasket EPDM thickness 2,5mm ID ø 75mm Qty 1 pcs		



1

GEV No.	510551	Ref. No.	N/A
description	pump cover gasket ID ø 158,3mm pump type 1214/1293/1225/2243/1226/1204/3473/1241 thickness 3,53mm EPDM Qty 1 pcs		

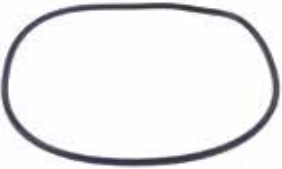

1

GEV No.	521026	Ref. No.	N/A
description	pump cover gasket ID ø 182,5mm thickness 5x4.5mm		



1

GEV No.	510552	Ref. No.	N/A
description	pump cover gasket pump type 1292-2/3942/3981/3911/3983		



image not available

GEV No.	521565	Ref. No.	N/A
description	pump cover gasket pump type B226H		



1

GEV No.	521702	Ref. No.	N/A
description	pump cover gasket thickness 3.5x4.5mm Qty 1 pcs		



1

GEV No.	524416	Ref. No.	N/A
description	pump cover gasket thickness 4x4mm Qty 1 pcs		

pump covers



image not available

GEV No.	521500	Ref. No.	N/A
description	pump cover		



1

GEV No.	521571	Ref. No.	2240303
description	pump cover FIR inlet ø 30mm outlet ø 30mm turn direction right ø 128mm ID ø 100mm inner height 21mm		



1

GEV No.	521505	Ref. No.	X4247-HP.0,6_(1)
description	pump cover FIR inlet ø 37mm outlet ø 40mm turn direction right ø 160mm ID ø 125mm inner height 25mm		



1

GEV No.	502014	Ref. No.	N/A
description	pump cover FIR inlet ø 45mm outlet ø 40mm		



1

GEV No.	521539	Ref. No.	N/A
description	pump cover FIR inlet ø 45mm outlet ø 40mm auxiliary pressure connection 10mm supporting pressure open turn direction right ø 160mm ID ø 125mm inner height 25mm		



1

GEV No.	510508	Ref. No.	N/A
description	pump cover FIR inlet ø 45mm outlet ø 40mm pump type PU 0.5/3911 turn direction right ø 160mm ID ø 125mm inner height 25mm		



1

GEV No.	511187	Ref. No.	N/A
description	pump cover FIR inlet ø 45mm outlet ø 40mm turn direction right ø 160mm ID ø 122mm inner height 21mm		



1

GEV No.	521506	Ref. No.	N/A
description	pump cover FIR inlet ø 45mm outlet ø 40mm turn direction right ø 160mm ID ø 125mm inner height 25mm		



1

GEV No.	521567	Ref. No.	N/A
description	pump cover FIR inlet ø 50mm outlet ø 37mm ø 150mm ID ø 118mm inner height 25mm		



1

GEV No.	521512	Ref. No.	N/A
description	pump cover FIR inlet ø 60mm outlet ø 50mm		



1

GEV No.	698762	Ref. No.	N/A
description	pump cover FIR inlet ø 60mmmm outlet ø 50mmmm pump type 4298.1404 turn direction right ø 156,5mm		



1

GEV No.	521028	Ref. No.	N/A
description	pump cover FIR inlet ø 62mm outlet ø 62mm turn direction right ø 215mm ID ø 175mm inner height 40mm		



1

GEV No.	502273	Ref. No.	N/A
description	pump cover FIR inlet ø 63mm outlet ø 2x40mm pump type 4267.5050 turn direction right		



1

GEV No.	502013	Ref. No.	N/A
description	pump cover FIR inlet ø 63mm outlet ø 53mm supporting pressure 1/2" turn direction left ø 185mm ID ø 150mm inner high 37mm		



1

GEV No.	521513	Ref. No.	N/A
description	pump cover FIR inlet ø 63mm outlet ø 47mm turn direction right ID ø 150mm inner high 32mm		
spare parts for	521513		
	GEV No.	504329	Ref. No. —
blind plug H 17,5mm thread M16x1.5 plastic WS 22			



1

GEV No.	521545	Ref. No.	N/A
description	pump cover FIR type B226H inlet ø 33mm outlet ø 30/28mm		



1

GEV No.	502274	Ref. No.	N/A
description	pump cover FIR inlet ø 63mm outlet ø 53mm		



1

GEV No.	510384	Ref. No.	N/A
description	pump cover inlet ø 28mm outlet ø 26mm ø 100mm ID ø 76mm		



1

GEV No.	510531	Ref. No.	N/A
description	pump cover FIR inlet ø 63mm outlet ø 53mm auxiliary pressure connection M16x1.5mm supporting pressure open turn direction left ø 185mm ID ø 150mm inner high 37mm		
spare parts for	510531		
	GEV No.	504329	Ref. No. —
blind plug H 17,5mm thread M16x1.5 plastic WS 22			



1

GEV No.	502265	Ref. No.	5213EB2450
description	pump cover inlet ø 30mm outlet ø 26mm ID ø 89mm inner high 35mm		



1

GEV No.	521501	Ref. No.	N/A
description	pump cover inlet ø 30mm outlet ø 30mm pump type 4134		

1

GEV No.	521511	Ref. No.	N/A
description	pump cover inlet ø 60mm outlet ø 50/30mm supporting pressure M12x1.75 supporting pressure open pump type 2233 turn direction right ø 160mm ID ø 120mm inner high 23mm		
accessories for	521511		
	GEV No.	517319	Ref. No. —
	hose connector T1: M12x1.75 hose ø 11mm brass		



1

GEV No.	521515	Ref. No.	N/A
description	pump cover inlet ø 70mm outlet ø 60mm		



1

GEV No.	698773	Ref. No.	N/A
description	pump cover inlet ø 63mm outlet ø 47mm turn direction right ø 194mm ID ø 158mm		



1

GEV No.	510510	Ref. No.	X2212-HP0,10_(1)
description	pump cover pump type 2212/2228/2229/2211		



1

GEV No.	521544	Ref. No.	N/A
description	pump cover inlet ø 63mm outlet ø 50mm turn direction right ø 180mm ID ø 165mm inner high 42mm		



1

GEV No.	502012	Ref. No.	N/A
description	pump cover bottom part for wash pump		